

BYTE

THE SMALL SYSTEMS JOURNAL[®]

SEPTEMBER 1986 VOL. 11, NO. 9

\$3.50 IN UNITED STATES
\$4.25 IN CANADA / £1.75 IN U.K.
A MCGRAW-HILL PUBLICATION
0360-5280

The 68000 Family

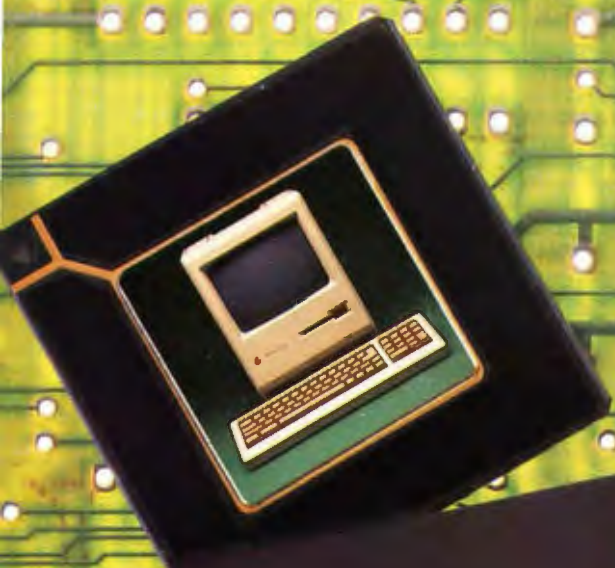

Turbo GameWorks™

Also recently released, Turbo GameWorks is what you think it is: "Games" and "Works." Games you can play right away (like Chess, Bridge and Go-Moku), plus the Works—which is how computer games work. All the secrets and

strategies of game theory are there for you to learn. You can play the games "as is" or modify them any which way you want. Source code is included to let you do that, and whether you want to write your own games or simply play the off-the-shelf games, Turbo GameWorks will give hours of diversion, education, and intrigue. George Koltanowski, Dean of American Chess, and former President, United States Chess Federation, reacted to Turbo GameWorks like this, "With Turbo GameWorks, you're on your way to becoming a master chess player," and Kit Woolsey, writer, author, and twice Champion of the Blue Ribbon Pairs, wrote, "Now play the world's most popular card game—Bridge . . . even program your own bidding or scoring conventions." Suggested retail: \$69.95.



Turbo Graphix Toolbox™

It includes a library of graphics routines for Turbo Pascal programs. Lets even beginning programmers create high-resolution graphics with an IBM, Hercules,™ or compatible graphics adapter. Our Turbo Graphix Toolbox includes all the tools you'll ever need for complex business graphics, easy windowing, and storing screen images to memory. It comes complete with source code, ready to compile. Suggested retail: \$69.95.



Recognition for Borland International has come from business, trade, and media, and includes both product awards and awards for technical excellence and marketing. Borland was named "Company of the Year" by PC Magazine; Sidekick, the #1 best seller for the IBM PC, was named "Product of the Year" by InfoWorld. Turbo Pascal was selected one of PC Week's Top 10 Products for 1984. SuperKey won one of PC Magazine's "Best of 1985" awards. Reflex, The Analyst was recognized in the "Software Products of the Year" awards by InfoWorld; and Reflex and Sidekick were both nominated for British Micro Awards in 1986.



Turbo Database Toolbox™

A perfect complement to Turbo Pascal, because it contains a complete library of Pascal procedures that allows you to search and sort data and build powerful database applications. Having Turbo Database Toolbox means you don't have to reinvent the wheel each time you write a Turbo Pascal program. It comes with source code for a free sample database—right on disk. The database can be searched by keywords or numbers. Update, add, or delete records as needed. Just compile it and it's ready to go to work for you. Suggested retail: \$69.95.



Technical Specifications:

TURBO PASCAL 3.0 Minimum memory: 128K, includes 8087 and BCD features for 16-bit MS-DOS and CP/M-86 systems. CP/M-80 version minimum memory: 48K, 8087 and BCD features not available

TURBO DATABASE TOOLBOX Minimum memory: 128K. CP/M-80 minimum memory: 48K. Requires Turbo Pascal 2.0 or later.

TURBO GRAPHIX TOOLBOX™ Minimum memory: 192K. Requires PC/MS-DOS 2.0 or later, Turbo Pascal 3.0, and IBM CGA, Hercules Monochrome Card or equivalent.

TURBO TUTOR 2.0 Minimum memory: 192K. CP/M-80 version minimum memory 48K. Requires PC/MS-DOS 2.0 or later and Turbo Pascal 3.0.

TURBO EDITOR TOOLBOX™ Minimum memory: 192K. Requires PC/MS-DOS 2.0 or later and Turbo Pascal 3.0.

TURBO GAMEWORKS™ Minimum memory: 192K. Requires PC/MS-DOS 2.0 or later and Turbo Pascal 3.0.

TURBO PROLOG™ Minimum memory: 384K.

REFLEX: THE ANALYST™ Minimum memory: 384K. Requires IBM CGA, Hercules Monochrome Card or equivalent. Works with Intel's AboveBoard-PC and -AT, AST's RAMpage! and RAMpage! AT, Quadram's Liberty-PC and -AT, Tecon's 640 Plus, IBM's EGA and 3270/PC, AT&T's 6300 and many others.

REFLEX WORKSHOP™ Minimum memory: 384K. Requires Reflex: The Analyst. Two disk drives or hard disk recommended.

TURBO LIGHTNING™ Minimum memory: 256K. Two disk drives required. Hard disk recommended.

LIGHTNING WORD WIZARD™ Minimum memory: 256K. Requires Turbo Lightning, Turbo Pascal 3.0 required to edit source code.

SIDEKICK™ Minimum memory: 128K.

TRAVELING SIDEKICK™ Minimum memory: 256K.

SUPERKEY™ Minimum memory: 128K.

*For IBM PC, AT, XT, PCjr and true compatibles only, running PC/MS-DOS 2.0 or later.





COMPLETELY
NEW VERSION!

Turbo Tutor® 2.0



Just released (July '86), the new Turbo Tutor can take you from "What's a computer?" on through to complex data structures, assembly languages, trees, tips on writing long programs in Turbo Pascal, and a

high level of expertise. Source code for everything is included. New split screens allow you to put source text in the bottom half of the screen and run the examples in the top half. There are quizzes that ask you, show you, tell you, teach you. You get a 450-page manual—which is not as daunting as it sounds, because unlike many software manuals, it was not written by orangutans. (With our all "almost-free" upgrade, you can upgrade to Turbo Tutor 2.0 by sending us your master diskettes, proof of purchase, and \$10.00, which covers shipping and handling.) Suggested retail: \$39.95.

NEW SPECIAL!

Turbo Pascal® 3.0



"For the IBM PC, the benchmark Pascal compiler is undoubtedly Borland International's Turbo Pascal," says Gary Ray of PC Week. We and more than 500,000 other people around the world think Mr. Ray got that right.

Since launch, Turbo Pascal has become the *de facto* worldwide standard in high-speed Pascal compilers. Described by Jeff Duntemann of PC Magazine as the "Language deal of the century," Turbo Pascal is now an even better deal than that—because we've included the most popular options (BCD reals and 8087 support). What used to cost \$124.95 is now only \$99.95! You now get a lot more for a lot less: the compiler, a completely integrated programming environment, and BCD reals and 8087 support—all for a suggested retail of only \$99.95.

Turbo Editor Toolbox™



Recently released, we called our new Turbo Editor Toolbox a "construction set to write your own word processor." Peter Feldmann of PC Magazine covered it pretty well with, "A 'write your own word processor'

program for intermediate level programmers, with lots of help in the form of prewritten procedures covering everything from word wrap to pull-down windows."

Source code is included, and we also include MicroStar, a full-blown text editor with pull-down menus and windowing. It interfaces directly with Turbo Lightning to let you spell-check



your MicroStar files. Jerry Pournelle of BYTE magazine said, "The new Turbo Editor Toolbox is the Turbo Pascal source code to just about anything you ever wanted a PC-compatible text editor to do." Suggested retail: \$69.95.

Borland's Business Productivity Programs:

Reflex: The Analyst™ Analytical database manager. Provides complete new look at data normally hidden by programs like 1-2-3™ and dBASE™. Best report generator for 1-2-3.

NEW!

Reflex Workshop™ Important new addition to Reflex: The Analyst. Gives you 22 different templates to run your business right.

SideKick™ Complete RAM-resident desktop management includes notepad, dialer, calculator and more.

Traveling SideKick™ Electronic version of business/personal diaries, daytime organizers, works with your SideKick files; important professional tool.

SuperKey™ Keyboard enhancer. Simple macros turn 1000 keystrokes into 1. Also encrypts your files to keep confidential files confidential.

Borland's Electronic Reference Programs:

Turbo Lightning™ Works with all your programs and checks your spelling while you type! Includes 80,000-word Random House™ Concise Dictionary and 50,000-word Random House Thesaurus. Forerunner of Turbo Lightning Library.

Lightning Word Wizard™ Includes ingenious crossword solver and six other word challenges. If you're into programming, Lightning Word Wizard is also a development toolbox and the technical reference manual for Turbo Lightning.

All Borland products are registered trademarks or trademarks of Borland International, Inc. or Borland/Analytica, Inc. 1-2-3 is a registered trademark of Lotus Development Corp. dBASE is a registered trademark of Ashton-Tate. Random House is a registered trademark of Random House, Inc. Hercules is a trademark of Hercules Computer Tech. IBM, AT, XT, and PCjr are registered trademarks of International Business Machines Corp. Copyright 1986 Borland International. BI-1067A

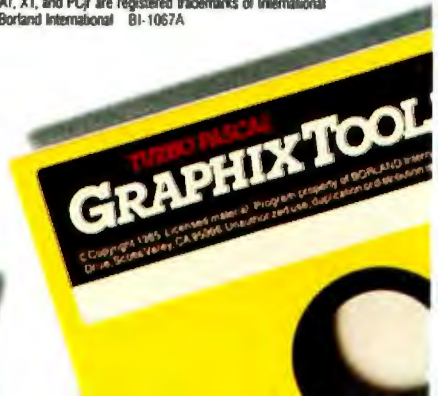



We frequently surprise people with inventive, imaginative software, and people frequently surprise us with the way they use it.

For example, you'll read on this page how Michael J. Watkins of the Petroleum Technology Center in Houston, Texas,

used Turbo Pascal® (and Turbo Graphix Toolbox™ and Turbo Tutor™) to cut down the tedium and time in creating Circular Performance Profile Charts (CPPCs).

We didn't know they existed, but you learn something new every day!

Applications like CPPCs might not fit your exact needs, but at the same time they might stimulate fresh ideas in your mind about how you can put Turbo Pascal and the Turbo Pascal family to work for you.

And thank you for your interest in and support for Borland International.

Philippe Kahn,
President, Borland International

INSIDE STORIES!

- Turbo Pascal 3.0, already described by *PC Magazine* as "Language deal of the century," is now an even better deal than that, because we've included the most popular options (BCD reals and 8087 support). What used to cost \$124.95 is now only \$99.95!
- Completely new Turbo Tutor 2.0 now available. New software. New manual. New split screens. New quizzes. Only \$39.95. Upgrades available under Borland's "Almost-Free" upgrade plan. Details inside.

LATE NEWS!

- June/July Special Artificial Intelligence Issue of *The Micro Technical Journal* says, "Turbo Prolog looks like it's going to be a winner, for both the beginner and professional programmer."

Turbo Pascal deliberately programmed to go around in circles

Circular charts (or CPPCs) are used by Michael J. Watkins of the Petroleum Technology Center in Houston, Texas, to plot a single performance property for a large number of elastomers, which have elastic, rubber-like properties.

Mr. Watkins wrote us saying, "Because CPPCs condense a lot of data in one graphic, they can be very tedious and time-consuming to draw."

What he did to solve those problems was to write a Turbo Pascal program for IBM® personal computers to "generate these charts quickly and easily."

He used Turbo Pascal "because it has a companion set of very powerful graphics programs (Turbo Graphix Toolbox) which greatly simplifies the required programming."

Turbo Pascal is not a difficult language to use and can be easily learned by persons who can program in FORTRAN or BASIC. An excellent tutorial (Turbo Tutor) is available for the novice or experienced programmer. The Turbo Pascal products are also very moderately priced.

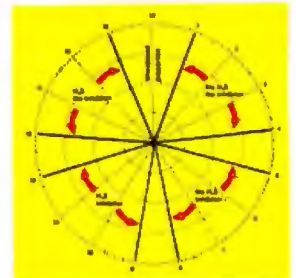

"The computer is no better than its program."
Elting Morison, author of "Men, Machines and Modern Times"



Step-by-step tutorial, demo programs with source code included!

Borland's new Turbo Prolog is the powerful, completely natural introduction to Artificial Intelligence

Prolog is probably one of the most powerful computer programming languages ever conceived, which is why we've made it our second language—and "turbo-charged" it to create Turbo Prolog.

Our new Turbo Prolog, the natural language of Artificial Intelligence, brings supercomputer power to your IBM® PC and introduces you step-by-step to the fascinating new world of Artificial Intelligence. And does all this for an astounding \$99.95.

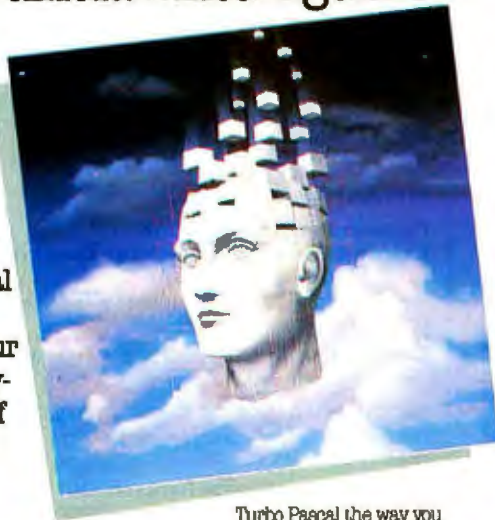

Turbo Prolog is to Prolog what Turbo Pascal® is to Pascal!

Our Turbo Pascal astonished everyone who thought of Pascal as "just another language." We changed all that—and now Turbo Pascal is the de facto worldwide standard, with hundreds of

thousands of enthusiasts and users in universities, research centers, schools, and with professional programmers, students, and hobbyists.

You can expect at least the same impact from Turbo Prolog, because while Turbo Prolog is the most revolutionary and natural programming language, it is also a complete development environment—just like Turbo Pascal. Minimum memory: 384K

"Turbo Prolog offers generally the fastest and most approachable implementation of Prolog.

Darryl Rubin, AI Expert

Even if you've never programmed before, our free tutorial will get you started right away

You'll get started right away because we have included a complete step-by-step tutorial as part of the 200-page Turbo Prolog Reference Manual. Our tutorial will take you by the hand and teach you everything you're likely to need to know about Turbo Prolog and artificial intelligence.

For example: once you've completed the tutorial, you'll be able to design your own expert systems utilizing Turbo Prolog's powerful problem-solving capabilities.

Think of Turbo Prolog as a high-speed electronic detective. First, you feed it information and teach it rules. Then Turbo Prolog "thinks" the problem through and comes up with all the reasonable answers—almost instantly.

If you think that this is amazing, you just need to remember that Turbo Prolog is a 5th-generation language—and the kind of language that 21st-century computers will use routinely. In fact, you can compare Turbo Prolog to

Turbo Pascal the way you could compare Turbo Pascal to machine language.

You get the complete Turbo Prolog programming system for only \$99.95

You get a complete Turbo Prolog development system including:

- The lightning-fast Turbo Prolog incremental compiler and the interactive Turbo Prolog editor.
- The 200-page reference manual which includes the step-by-step Turbo Prolog tutorial.
- The free GeoBase™ natural query language database including commented source code on disk—ready to compile. GeoBase is a complete database designed and developed around U.S. geography. It includes cities, mountains, rivers, and highways, and comes complete with natural query language. Use GeoBase immediately "as is," or modify it to fit your own interests.

So don't delay—don't waste a second—get Turbo Prolog now. \$99.95 is an amazingly small price to pay to become an immediate authority—an instant expert on artificial intelligence! The 21st century is only one phone call away.

YES! I want the best!
For credit card orders or the dealer nearest you
call (800) 255-8008
in CA call (800) 742-1133

Copies	Product	Price	Totals
___	Turbo Prolog	\$99.95	\$ _____
___	Reflex: The Analyst	149.95*	\$ _____
___	Reflex Workshop	69.95*	\$ _____
___	Reflex, Reflex Workshop	199.95*	\$ _____
___	turbo Pascal 3.0 w/BORF & BCD	99.95	\$ _____
___	Turbo Pascal for CP/M-80	69.95	\$ _____
___	Turbo Database Toolbox	69.95	\$ _____
___	Turbo Graphics Toolbox	69.95	\$ _____
___	Turbo Alter 2.0	39.95	\$ _____
___	Turbo Editor Toolbox	69.95	\$ _____
___	turbo GameWorks	69.95	\$ _____
___	Turbo Lighting	99.95	\$ _____
___	Lightning Word Wizard	69.95	\$ _____
___	Turbo Lighting: Lightning Word Wizard	149.95	\$ _____
___	SideKick	84.95	\$ _____
___	Travelling SideKick	69.95*	\$ _____
___	SideKick, Travelling SideKick	125.00*	\$ _____
___	SuperKey	69.95	\$ _____
Outside USA add \$10 per copy			\$ _____
CA and MA res. add sales tax			\$ _____
Amount enclosed			\$ _____

Prices include shipping to all US cities.

Carefully describe your computer system:

Mine is: ___ 8-bit ___ 16-bit

I use: ___ PC-DOS ___ CP/M-80 ___ MS-DOS ___ CP/M-86

My computer's name and model is: _____

The disk size I use is: 3 1/2" 5 1/4" 8"

Payment: VISA MC Money order Check

Credit card expiration date: ___/___/___

Card #

City: _____

State: _____ Zip: _____

Telephone: _____

CODs and purchase orders WILL NOT be accepted by Borland. Outside USA make payment by bank draft, payable in US dollars drawn on a US bank.

*Limited Time Offer until September 1, 1986.

**YES, if within 60 days of purchase you find that this product does not perform in accordance with our claims, call our customer service department and we will gladly arrange a refund.

Prices subject to change without notice.

Turbo Prolog 1.0 Technical Specifications

Compiler: incremental compiler generating native in-line code and linkable object modules. The linking format includes a linker and is compatible with the PC-DOS linker. Large memory model support. Compiles over 2500 lines per minute on a standard IBM PC.

Interactive Editor: The system includes a powerful interactive text editor. If the compiler detects an error, the editor automatically positions the cursor appropriately in the source code. At run-time, Turbo Prolog programs can call the editor, and view the running program's source code.

Type System: A flexible object-oriented type system is supported.

Windowing Support: The system supports both graphic and text windows.

Input/Output: Full I/O facilities, including formatted I/O, streams, and random access files.

Numeric Ranges: integers: -32767 to 32767; Reals: 1E-307 to 1E+308

Debugging: Complete built-in trace debugging capabilities allowing single stepping of programs.

BORLAND
INTERNATIONAL

4585 SCOTT'S VALLEY DRIVE
SCOTT'S VALLEY, CA 95066
(408) 438-8400 TELEX 172373

Vive la différence



C·O·N·T·E·N·T·S



82



160

FEATURES

INTRODUCTION	82
PRODUCT PREVIEW: LABVIEW: LABORATORY VIRTUAL INSTRUMENT ENGINEERING WORKBENCH <i>by G. Michael Vose and Gregg Williams</i>	84
Scientists and engineers can use the Macintosh as a general-purpose laboratory tool by creating virtual instruments.	
CIARCIA'S CIRCUIT CELLAR: BUILD A HARDWARE DATA ENCRYPTOR <i>by Steve Ciarcia</i>	97
This easy-to-build device is extremely difficult to crack.	
PROGRAMMING PROJECT: CALCULATING CRCs BY BITS AND BYTES <i>by Greg Morse</i>	114
Use the XOR function to implement modulo 2 division when calculating cyclic redundancy checks.	
PROGRAMMING INSIGHT: BREAKING OUT <i>by Edward Batutis</i>	127
BREAKPT provides the IBM PC-DOS DEBUG program with a break-out switch.	
KEYED FILE ACCESS IN BASIC <i>by Stephen C. Perry</i>	137
If maintaining data on disk is a problem for you, these BASIC routines may be the solution.	
REAL TIME UNDER REAL PASCAL <i>by James Feldman</i>	145
A look at two ways to interface a machine language routine to Pascal.	

THEME: 68000 MACHINES

INTRODUCTION	160
68000 TRIPS AND TRAPS <i>by Mike Morton</i>	163
Programming in assembly language will help you exploit the 68000 to the fullest.	
UNIX AND THE MC68000 <i>by Andrew L. Rood, Robert C. Cline, and Jon A. Brewster</i>	179
The powerful yet simple programmer's model offered by the 68000's architecture makes UNIX implementation easy.	
A COMPARISON OF MC68000 FAMILY PROCESSORS <i>by Thomas L. Johnson</i>	205
High levels of hardware and software compatibility distinguish the five members of this family.	
ATARI ST SOFTWARE DEVELOPMENT <i>by Michael Rothman</i>	223
A programmer surveys TOS operating system and how the 68000 influences it.	
AMIGA ANIMATION <i>by Elaine A. Ditton and Richard A. Ditton</i>	241
An exploration of the exciting possibilities for animation on the Amiga.	
AMIGA VS. MACINTOSH <i>by Adam Brookes Webber</i>	249
A comparison of the system calls on two 68000-based machines reveals one as the clear winner.	

REVIEWS

INTRODUCTION	258
REVIEWER'S NOTEBOOK <i>by Jon Edwards</i>	261
THE FRANKLIN ACE 2200 <i>by Albert S. Woodhull</i>	263
An inexpensive Apple II clone with integrated disk drives.	
THE LEADING EDGE MODEL D PC <i>by Stan Miastkowski</i>	269
An IBM PC compatible that has lots of standard features.	

BYTE (ISSN 0360-1280) is published monthly with one extra issue per year by McGraw-Hill Inc. Founder James H. McGraw (1860-1948). Executive, editorial circulation and advertising offices: One Phoenix Mill Lane, Peterborough, NH 03458, phone (603) 924-9281. Office hours: Monday through Thursday 8:30 AM - 4:30 PM, Friday 8:30 AM - 1:00 PM Eastern Time. Address subscriptions to BYTE Subscriptions, PO Box 590, Monticello, NJ 08836. Postmaster: send address changes USPS Form 3579, undeliverable copies and fulfillment questions to BYTE Subscriptions, PO Box 596, Monticello, NJ 08836. Second-class postage paid at Peterborough, NH 03458 and additional mailing offices. Postage paid at Winnipeg, Manitoba. Registration number 9321. Subscriptions are \$21 for one year, \$38 for two years, and \$55 for three years in the U.S. and its possessions. In Canada and Mexico \$23 for one year, \$42 for two years, \$61 for three years. \$69 for one year air delivery to Europe, 31,000 yen for one year air delivery to Japan, 15,600 yen for one year surface delivery to Japan, \$37 surface delivery elsewhere. Air delivery to selected areas at additional rates upon request. Single copy price is \$1.50 in the U.S. and its possessions, \$4.25 in Canada and Mexico, \$4.50 in Europe, and \$5 elsewhere. Foreign subscriptions and sales should be remitted in U.S. funds drawn on a U.S. bank. Please allow six to eight weeks for delivery of first issue. Printed in the United States of America.

BYTE September

VOLUME 11, NUMBER 9, 1986

THE XEROX 6060 by Wayne Rash Jr.	275
A speedy machine virtually identical to the AT&T PC 6300.	
THE C. ITOH TRIPRINTER by Robert D. Swearingin	283
A hefty printer that lets you program dozens of functions.	
THE TURNER HALL CARD by Jonathan Angel	287
Simple-to-install memory expansion for IBM PCs and compatibles.	
TURBO PROLOG by Namir Clement Shammas	293
An implementation of Prolog for the IBM PC.	
SOFTWARE CAROUSEL by Mark Haas	299
A virtual memory manager that enables you to shift between programs instantly.	
PARADOX 1.1 by Rusel DeMaria	303
A relational database offering tremendous power.	
WORDPERFECT 4.1 by Ricardo Birmele	311
Improvements beyond earlier versions.	
REVIEW FEEDBACK	315
Readers respond to previous reviews.	

KERNEL

INTRODUCTION	318
COMPUTING AT CHAOS MANOR: A BUSY DAY by Jerry Pournelle	321
But he was able to finish all he had to do.	
ACCORDING TO WEBSTER: TWO FINE PRODUCTS by Bruce Webster	335
Close-ups on Turbo Prolog and LightspeedC.	
BYTE JAPAN: PERSPECTIVES ON HARDWARE AND SOFTWARE by William M. Raike	351
Bill finds a few interesting products at Tokyo's Microcomputer Show.	
BYTE U.K.: TURBOCHARGING MANDELBROT by Dick Pountain	359
Dick returns to the topic of dynamic load balancing.	
APPLICATIONS ONLY: SING YE MACPRAISES by Ezra Shapiro	367
Excellent software is converting this Mac skeptic.	

BEST OF BIX

AMIGA	380	MACINTOSH	404
ATARI ST	390	PASCAL	409
IBM PC AND COMPATIBLES	398		
EDITORIAL: COLLEGE CREDITS THROUGH COMMUNICATIONS	6	CIRCUIT CELLAR FEEDBACK	58
MICROBYTES	9	BOOK REVIEWS	65
LETTERS	14	FIXES	373
WHAT'S NEW	31	CHAOS MANOR MAIL	376
EVENTS AND CLUBS	49	BOMB RESULTS AND NEXT MONTH IN BYTE	461
ASK BYTE	50	READER SERVICE	463



258



318

Address editorial correspondence to Editor BYTE, One Phoenix Mill Lane, Peterborough, NH 03458. Unacceptable manuscripts will be returned if accompanied by sufficient postage. Not responsible for lost manuscripts or photos. Opinions expressed by the authors are not necessarily those of BYTE. Copyright © 1986 by McGraw-Hill Inc. All rights reserved. Trademark registered in the United States Patent and Trademark Office. Where necessary, permission is granted by the copyright owner for libraries and others registered with the Copyright Clearance Center (CCC) to photocopy any article herein for the flat fee of \$1.50 per copy of the article or any part thereof. Correspondence and payment should be sent directly to the CCC, 29 Congress St., Salem, MA 01970. Specify ISSN 0360-5308/87 \$1.50. Copying done for other than personal or internal reference use without the permission of McGraw-Hill Inc. is prohibited. Requests for special permission or bulk orders should be addressed to the publisher. BYTE is available in microform from University Microfilms International, 300 North Zeeb Rd., Dept. PR, Ann Arbor, MI 48106 or 18 Bedford Row, Dept. PR, London WC1R 4EJ, England. Subscription questions or problems should be addressed to: BYTE Subscriber Service, P.O. Box 328, Hancock, NH 03449.



BYTE

SENIOR VICE PRESIDENT/PUBLISHER
HARRY L. BROWN
EDITOR IN CHIEF
PHILIP LEMMONS

BIX

MANAGING EDITOR, BYTE
FREDERIC S. LANGA

ASSISTANT MANAGING EDITOR

GLENN HARTWIG

CONSULTING EDITORS

STEVE CIARCIA

JERRY POURNELLE

EZRA SHAPIRO

BRUCE WEBSTER

SENIOR TECHNICAL EDITORS

JON R. EDWARDS, *Reviews*

G. MICHAEL VOSE, *Themes*

GREGG WILLIAMS, *Features*

TECHNICAL EDITORS

DENNIS ALLEN

RICHARD GREHAN

KEN SHELDON

GEORGE A. STEWART

JANE MORRILL TAZELAAR

TOM THOMPSON

CHARLES D. WESTON

EVA WHITE

STANLEY WZOLA

ASSOCIATE TECHNICAL EDITORS

CURTIS FRANKLIN, JR., *Best of BIX*

MARGARET COOK GURNEY, *Book Reviews*

BRENDA McLAUGHLIN, *Applications Software Reviews*,
San Francisco

COPY EDITORS

BUD SADLER, *Chief*

JEFF EDMONDS

FAITH HANSON

NANCY HAYES

CATHY KINGERY

PAULA NOONAN

WARREN WILLIAMSON

JUDY WINKLER

ASSISTANTS

PEGGY DUNHAM, *Office Manager*

MARTHA HICKS

JUNE N. SHELDON

NEWS AND TECHNOLOGY

GENE SMARTE, *Bureau Chief, Costa Mesa*

RICH MALLOY, *Senior Technical Editor, New York*

CINDY KIDDOD, *Editorial Assistant, San Francisco*

ASSOCIATE NEWS EDITORS

DENNIS BARKER, *Microbytes*

CATHRYN BASKIN, *What's New*

ANNE FISCHER LENT, *What's New*

CONTRIBUTING EDITORS

JONATHAN AMSTERDAM, *programming projects*

MARK DAHME, *video, operating systems*

MARK HAAS, *at large*

RIK JADRNICEK, *CAD, graphics, spreadsheets*

ROBERT T. KUROSAKA, *mathematical recreations*

PHIL LOPICCOLO, *computers in medicine*

ALASTAIR J. W. MAYER, *software*

ALAN R. MILLER, *languages and engineering*

DICK POUNTAIN, *U.K.*

ROGER POWELL, *computers and music*

WILLIAM M. RAIKE, *Japan*

PHILLIP ROBINSON, *semiconductors*

ART

NANCY RICE, *Art Director*

JOSEPH A. GALLAGHER, *Associate Art Director*

JAN MULLER, *Art Assistant*

ALAN EASTON, *Drafting*

PRODUCTION

DAVID R. ANDERSON, *Production Director*

DENISE CHARTRAND

MICHAEL J. LONSKY

VIRGINIA REARDON

TYPOGRAPHY

SHERRY MCCARTHY, *Chief Typographer*

LEN LORETTE

DONNA SWEENEY

EXECUTIVE EDITOR, BIX
GEORGE BOND

SENIOR EDITOR

DAVID BETZ

ASSOCIATE EDITORS

TONY LOCKWOOD

DONNA OSGOOD, *San Francisco*

BUSINESS AND MARKETING

DOUG WEBSTER, *Director, (603) 924-9027*

PATRICIA BAUSUM, *Secretary*

BRIAN WARNOCK, *Customer Service*

DENISE A. GREENE, *Customer Service*

TAMMY BURGESS, *Customer Credit and Billing*

TECHNOLOGY

CLAYTON LISLE, *Director, Business Systems Technology, MHS*

BILL GARRISON, *Business Systems Analyst*

JACK REILLY, *Business Systems Analyst*

LINDA WOLFF, *Senior Business Systems Analyst*

ADVERTISING SALES

DENNIS J. RILEY, *Director of Sales and Marketing*

SANDRA FOSTER, *Administrative Assistant*

ADVERTISING/PRODUCTION (603-924-6448)

LISA WOZNAK, *Supervisor*

ROBERT D. HANNINGS, *Senior Account Coordinator*

MARION CARLSON

KAREN CILLEY

LYDA CLARK

MICHELE JACKSON

WAI CHIU LI, *Quality Control Manager*

JULIE MURPHREE, *Advertising/Production Coordinator*

MARKETING COMMUNICATIONS

HORACE T. HOWLAND, *Director (603-924-3424)*

VICKI REYNOLDS, *Promotion Manager*

LISA JO STEINER, *Marketing Assistant*

STEPHANIE WARNECKY, *Marketing Art Director*

SHARON PRICE, *Associate Art Director*

WILBUR S. WATSON, *Operations Manager, Exhibits*

RESEARCH

PATRICIA AKERLEY, *Research Manager*

JULIE PERRON, *Market Research Analyst*

CYNTHIA DAMATO SANDS, *Reader Service Coordinator*

PLANNING AND DEVELOPMENT/PUBLIC RELATIONS

(603-924-7233)

MICHELE P. VERVILLE, *Manager*

FAITH KLUNTZ, *Copyrights Coordinator*

FINANCIAL SERVICES

PHILIP L. PENNY, *Director of Finance and Services*

KENNETH A. KING, *Business Manager*

CHRISTINE LEE, *Assistant*

VICKI WESTON, *Accounting Manager*

LINDA SHORT, *D/P Manager*

EDSON WARE, *Credit*

MARILYN HAIGH

DIANE HENRY

VERN ROCKWELL

JOANN WALTER

PUBLISHER'S ASSISTANT

BEVERLY JACKSON

CIRCULATION (800-258-5485)

ANDREW JACKSON, *Subscriptions Manager*

LAURIE SEAMANS, *Assistant Manager*

SUSAN BOYD

MARY EMERSON

LOUISE MENEGUS

AGNES E. PERRY

JENNIFER PRICE

JAMES BINGHAM, *Single-Copy Sales Manager*

CATHY A. RUTHERFORD, *Assistant Manager*

CLAUDETTE CARSWELL

KAREN DESROCHES

PERSONNEL

CHERYL HURD, *Office Manager*

PATRICIA BURKE, *Personnel Coordinator*

BUILDING SERVICES/TRAFFIC

ANTHONY BENNETT, *Building Services Manager*

BRIAN HIGGINS

MARK MONKTON

RECEPTIONIST

DONNA HEALY

EDITORIAL AND BUSINESS OFFICE: One Phoenix Mill Lane,
Peterborough, New Hampshire 03458, (603) 924-9281.

West Coast Offices: 425 Battery St., San Francisco, CA 94111,
(415) 954-9718; 3001 Red Hill Ave., Building #1, Suite 272, Costa
Mesa, CA 92626, (714) 537-6292. **New York Editorial Office:**
1221 Avenue of the Americas, New York, NY 10020, (212)
512-2000

Officers of McGraw-Hill Information Systems Company: President: Richard B. Miller, Executive Vice Presidents: Frederick P. Jannott, Construction Information Group; Russell C. White, Computers and Communications Information Group; J. Thomas Ryan, Marketing and International. Senior Vice Presidents: Francis A. Shinal, Controller; Robert C. Violette, Manufacturing and Technology; Senior Vice Presidents and Publishers: Laurence Altman, Electronics Week; Harry L. Brown, BYTE; David J. McGrath, Construction Publications. Group Vice President: Peter B. McCuen, Communications Information. Vice President: Fred Q. Jensen, Planning and Development.

Officers of McGraw-Hill, Inc.: Harold W. McGraw, Jr., Chairman; Joseph L. Donno, President and Chief Executive Officer; Robert N. Landes, Executive Vice President and Secretary; Walter D. Serwatka, Executive Vice President and Chief Financial Officer; Shel F. Asen, Senior Vice President, Manufacturing; Robert J. Bahash, Senior Vice President, Finance and Manufacturing; Ralph R. Schulz, Senior Vice President, Editorial; George R. Elsingler, Vice President, Circulation; Ralph J. Webb, Vice President and Treasurer

BYTE, BIX and The Small Systems Journal are registered trademarks of McGraw-Hill Inc.

Circuit-Board-Artwork Software: \$895. And guaranteed.

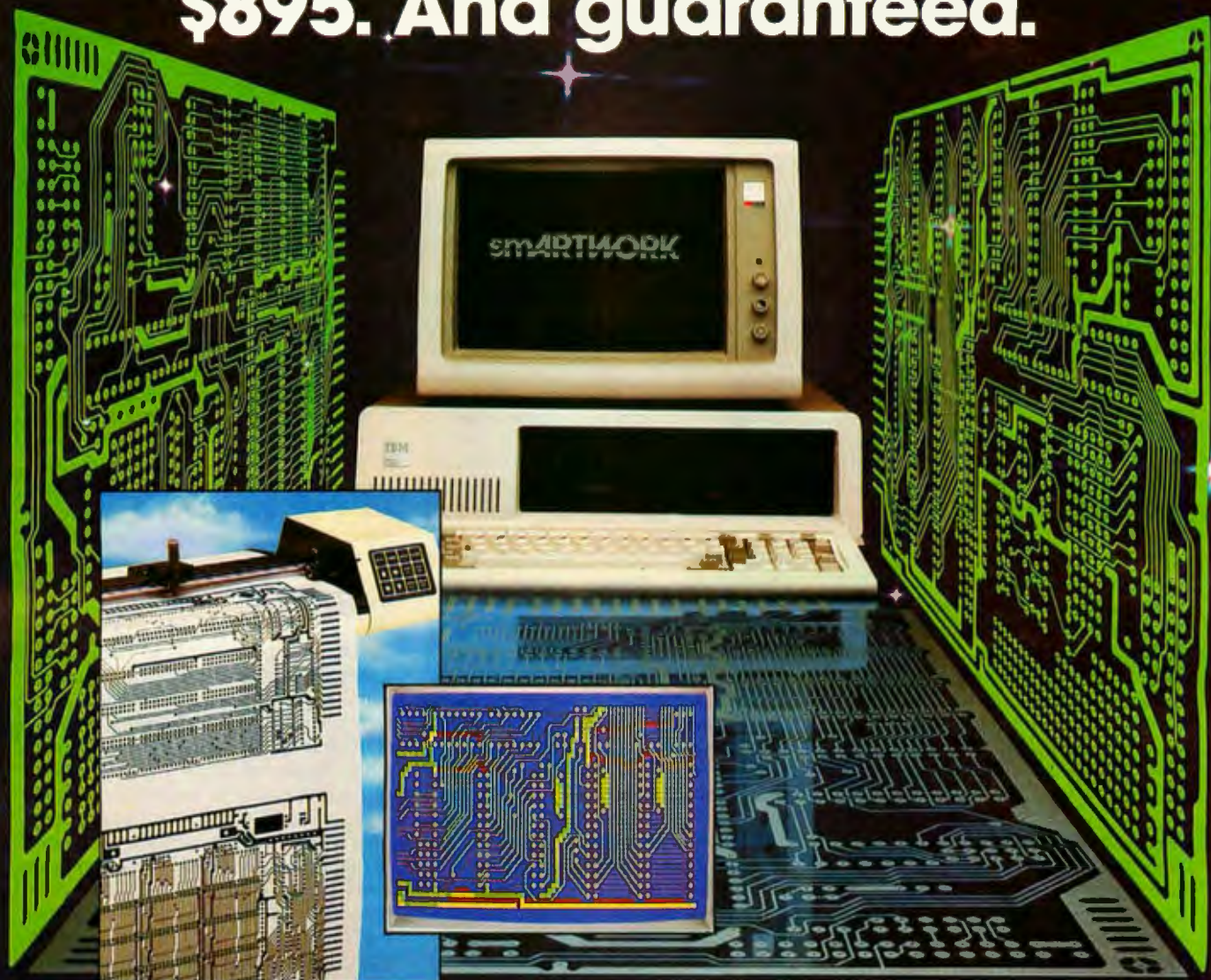

smARTWORK® lets the design engineer create and revise printed-circuit-board artwork on the IBM Personal Computer. You keep complete control over your circuit-board artwork — from start to finish.

And smARTWORK® is reliable. When we couldn't find a package that was convenient, fast, and affordable, we created smARTWORK® to help design our own microcomputer hardware. We've used it for over two years, so we know it does the job.

That's why we offer every design engineer a *thirty-day money-back no-nonsense guarantee*.

smARTWORK® advantages:

- Complete interactive control over placement and routing
- Quick correction and revision
- Production-quality 2X artwork from a pen-and-ink plotter

- Prototype-quality 2X artwork from a dot-matrix printer
- Easy to learn and operate, yet capable of sophisticated layouts
- Single-sided and double-sided printed circuit boards up to 10 x 16 inches
- Multicolor or black-and-white display

System Requirements:

- IBM Personal Computer, XT, or AT with 320K RAM, 2 disk drives, and DOS Version 2.0 or later
- IBM Color/Graphics Adapter with RGB color or black-and-white monitor
- IBM Graphics Printer or Epson FX/MX/RX series dot-matrix printer
- Houston Instrument DMP-41 pen-and-ink plotter
- Microsoft Mouse (optional)

The Smart Buy

At \$895, smARTWORK® is proven, convenient, fast — and *guaranteed*. Call us today. And put smARTWORK® to work for yourself next week. Try it for 30 days at absolutely no risk. That's smart work.

Wintek Corporation
1801 South Street
Lafayette, IN 47904-2993
Telephone: (317) 742-8428
Telex: 70-9079 WINTEK CORP UD

Inquiry 380



In Europe contact: RIVA Terminals Limited,
Woking, Surrey GU21 5JY ENGLAND,
Telephone: 04862-71001, Telex: 859502

smARTWORK®, Wintek, and the Wintek logo are registered trademarks of Wintek Corporation.

COLLEGE CREDITS THROUGH TELECOMMUNICATIONS

We urge colleges and universities to expand the practice of granting credits for courses taught through computer conferencing.

We have become aware of the need for computer-mediated instruction because BYTE's offices are located in a rural area. In order to advance professionally, members of our staff often need to take university courses to increase their knowledge of computer science or engineering. Unfortunately, we have no universities in easy commuting range that offer broad curricula in these fields of study. Some of our staff members have endured long commutes to continue their studies, but work loads are high at BYTE, and few employees can both do their jobs well and undertake regular university studies at distant sites.

THE INSTRUCTIONAL MEDIUM

Direct observation has shown us that computer conferencing works as an instructional medium. We have seen tutorial topics spring up in many conferences on BIX. People learn about programming a new machine, for example, from volunteer teachers in distant areas. Sessions have the quality of free and open classroom discussions. The lack of face-to-face contact has not proved to be a hindrance.

We also know that instruction by computer conferencing has already worked in a university. The New School for Social Research, through an association with Connect Ed, has already taught graduate courses in media studies. Connect Ed uses the EIES conferencing software developed at the New York Institute of Technology by Murray Turoff. Some members of the BYTE staff visited the New School last year and spoke with students and teachers in the New School/Connect Ed program. All agreed that the system works. In their program, computer conferencing is supplemented by some actual classes. The requirement of occasional classes on campus is much less daunting than a long commute several times each week.

From the teacher's perspective, computer conferencing has some advantages as an instructional medium. It is easy to

monitor attendance and to measure participation. Questions can be addressed to the whole class or to an individual. Since students can think as long as they wish before replying, dialogue conducted through computers is in some respects easier than spoken conversation. And, of course, shy and quiet people can always have their say in computer conferencing. The loud and aggressive can't drown them out. Examination tools to simplify the administration of exams on-line would not be difficult to create.

NEW EDUCATIONAL OPPORTUNITIES

The use of telecommunications as a means of instruction can enable potential students in rural areas to gain access to outstanding teachers and scholars at major universities. If computer conferencing software is used, students can enjoy discussion and debate with students from different regions and backgrounds. The community of higher education will become accessible from remote areas as never before. Potential students in rural areas will enjoy unprecedented educational opportunities.

Moreover, computer conferencing can make many educational opportunities now beyond commuting range available to everyone. Even the opportunities available to those in urban areas will increase.

COST ADVANTAGES

Sadly, the cost of higher education has now become prohibitive for many people. Instruction through computer conferencing can alleviate this situation by reducing expenses for both the university and the student. Universities will be able to add more students without building more dormitories and classrooms. The student can continue to live at home, incurring no new room and board expenses. This will effectively reduce the student's expenses to the amount of tuition, which can be exactly the same for on-line students as for on-campus ones. With tuition remaining the same, the university will experience no loss of revenue.

COMBINED STUDY

It seems likely that universities will be able to combine on-line instruction

with on-campus instruction to provide improved courses. Daily on-line instruction could be supplemented by on-campus instruction—perhaps one or two Saturdays per month. Another intriguing possibility would be letting on-line students compete for on-campus scholarships to complete their studies. On-line interaction with prospective students might also permit both students and universities to make better choices in the admissions process.

THE BIG STEP

We urge universities to offer credit courses through computer conferencing in order to test the limits of the medium and to learn how best to combine on-line and on-campus instruction. We believe computer conferencing can help preserve and extend educational opportunity in a time of prohibitive costs for many students and many universities. If universities do this, they will open their curricula to millions of potential students—personal computer users everywhere. Through their computers and modems, personal computer users, even those located in rural areas, will gain access to an enormous range of courses. Let's hope that universities and accrediting associations will seize this opportunity to extend educational programs.

—Phil Lemmons
Editor in Chief

Update on Availability of Listings

This issue contains postage-paid cards for ordering source code listings on disk or in print. You can order individual disks or take out an annual subscription. While the postage-paid cards and our agreement with a disk fulfillment service will make ordering more convenient, they will also add to our costs. As a result, we have had to raise prices. Previously, IBM and other available 5¼-inch disks were priced at \$5 each, or \$60 for the year. The IBM disks will now cost \$8.95 each, or \$69.95 for the year. Pricing for other available disks is stated on the order cards.

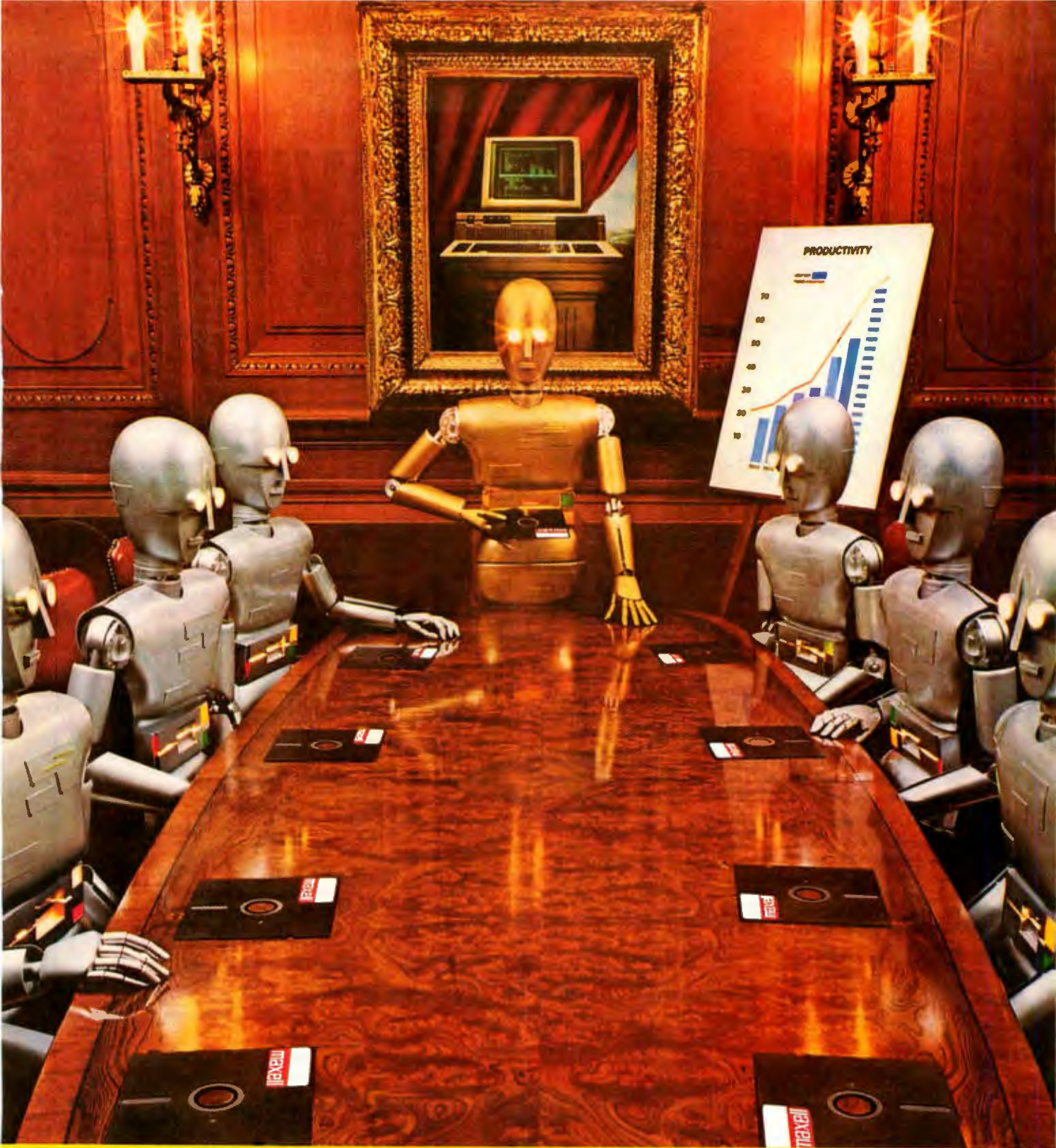

When computers get down to business, they move up to Maxell.

Maxell is ready when you are with the newest technology in magnetic media. A perfect example is this double-sided 3½" microdisk.



maxell.
THE GOLD STANDARD

RAM-Resident Program Users...

IT'S EASY TO WIN WHEN YOU BUY THE REFEREE™

Referee™ stops RAM-resident program conflicts.

If you use desktop organizers, spell checkers, keyboard enhancers or other RAM-resident programs, you may have already discovered the horror of "RAM Cram."

RAM Cram occurs when memory-resident programs compete with each other (and with applications programs) for control of your keyboard or other computer resources. It's a fierce competition that can cause your computer to lock up completely. Then you pay the penalty—in lost time and lost data.

With Referee, you make the rules.

Referee, by Persoft, is a new type of software that puts you in total control of your RAM-resident programs. And that puts Referee in a league all its own. You can create your own RAM Teams™ for specific applications programs. Team Superkey™ and Sidekick™ with Lotus 1-2-3™. Or call in Prokey™ and bench



the others when you switch to dBASE III™.

Load all the programs you need at the beginning of your workday. Referee automatically activates and deactivates the ones you need according to your set of rules. Instantly. Invisibly. You can also use Referee to unload programs from memory—even those with no unload option of their own.

Referee's Sideline™ menu enables you to control RAM-resident programs from within an applications program!

It's ideal for integrated packages like Symphony™. You can use a keyboard enhancer with the spreadsheet module. Or deactivate it, enter the word processing module and activate your favorite spell checker. It's easy. And you never have to back all the way out of the program!

Referee puts an end to RAM-resident program conflicts. It solves a very big problem for a very small price.

It's easier to win with the Referee on your side. For more information, and for the dealer nearest you, contact: Persoft, Inc., 465 Science Drive, Madison, WI 53711, (608) 273-6000—Telex 759491.

Referee™

persoft

© Copyright 1986 Persoft, Inc. All rights reserved.
Referee, Sideline, and RAM Teams are trademarks of Persoft, Inc.
Sidekick and Superkey are registered trademarks of Borland International, Inc.
Lotus 1-2-3 and Symphony are registered trademarks of Lotus Development Corp.
Prokey is a trademark of RoseSoft, Inc.
dBASE III is a registered trademark of Ashton-Tate.

Philips Working on WORMs Compatible with CD-ROMs

Philips Subsystems and Peripherals (New York City) is working on a new type of write-once read-many (WORM) optical disk drive that will be compatible with CD-ROM optical disks. Philips calls the new disks CD-PROMs and says that the disks will store the same amount of data (540 megabytes), formatted in the same way, as CD-ROM disks. CD-PROMs are more than a year away from commercial availability.

Currently, most small write-once optical disks are 5.5 inches in diameter (compared to the 4.7 inches of the CD-ROM disk) and can store only 100 to 200 megabytes per side. What will differentiate CD-PROM disks from standard CD-ROM disks is the manner in which the bits of information are stored. On a normal CD-ROM disk, the bits are stored as pits in the medium. On the CD-PROM disk, the bits are stored as phase changes in the medium.

Philips is working on a drive that not only reads and writes the new CD-PROM disks but can also read regular CD-ROM disks. One problem is the sizable amount of processing required for the error-correction techniques CD-ROM disks need (see May BYTE, page 164).

Another problem is that CD-PROM disks are more delicate than CD-ROM disks, which are relatively impervious to normal wear and tear. Philips is proposing to other manufacturers a disk cartridge designed to protect CD-ROM and CD-PROM disks.

The CD-PROM drives may be useful for archival purposes or for publishing large amounts of information in small quantities—that is, quantities not cost-effective for regular CD-ROM publishing. Another possible application will be for companies that want to test prototype CD-ROM disks before mass-producing them.

The cartridge for the CD-ROM disks will probably be introduced at the Fall COMDEX show. Samples of the CD-PROM drives will probably not be ready until the second half of next year. Production units will most likely not be available until 1988. Philips expects the drives to cost less than \$1000, and the disks somewhere under \$100.

The Terabytes Are Coming, the Terabytes Are Coming

Remember when a gigabyte was an unbelievably large quantity of data? Well, now a Dutch company named DOCdata is planning an optical tape drive that can store 1 terabyte—that's 1000 gigabytes—of data. The device, called the DOCwheel, uses 128 optical data cassettes arranged in a wheel; it has a footprint of approximately 3 square feet. The DOCwheel will supposedly be able to access any file on any cassette in an average time of 10 seconds.

Each cassette is approximately the same size as a standard audio cassette, measuring 4.4 by 2.2 by 0.6 inches. With a data capacity of up to 8 gigabytes, the cassette's ratio of data capacity to volume is said to be 30 times that of an optical disk. For durability, the cassette has a steel casing and is hermetically sealed to keep out dust.

The DOCwheel and the smaller DOCreader, which can read only one cassette, are designed to be used with large systems and will be plug-compatible with existing magnetic tape drives, DOCdata said. Although the system uses write-once optical tape, DOCdata does not think this will be an impediment, since most magnetic tape is used in a similar way (that is, magnetic tape is written on once and might later be recycled, but it is rarely updated).

Both devices are scheduled to be available commercially in 1987. DOCdata N.V. can be reached at P.O. Box 1021, Maaskade 11, 5900 BA Venlo, The Netherlands, (0) 77-544100.

Colorado Crystals Changing Face of Display Technology

A new type of liquid-crystal device has been designed by a physics professor at the University of Colorado in Boulder and a colleague from Sweden's Chalmers Technical University. The device, called an electro-optic light valve, uses a ferroelectric liquid crystal between closely spaced glass plates. It's described as being much faster than liquid-crystal light valves currently in use. In large arrays, the ferroelectric crystals can provide display screens that have inherent memories.

(continued)

The Colorado professor, Noel Clark, says that when voltage is applied, the valves change color in less than a microsecond. According to Clark, who with Sven T. Lagerwall has patented the technology, the crystals provide a high-speed electrically operated light valve with built-in memory.

Clark said that because the technology offers very fast switching times, it could be used in shutters that respond in less than a microsecond, in high-speed switches for fiber optics, and in optical modulators. Another possibility Clark cited is optical printers, which he called "fast and inexpensive enough to make laser printers obsolete."

Along with David Walba, a chemistry professor who helped synthesize the new crystals, Clark set up a Boulder-based firm that's selling the ferroelectric crystal materials.

GaAs Chip Passes Test As Microprocessor

McDonnell Douglas (Huntington Beach, CA) has built a gallium arsenide chip for use as a microprocessor and claims it's the first such chip to be tested successfully. The MD2901 "contains the logic elements to process information, not just to store it," said Bill Geideman, microprocessor program manager at McDonnell Douglas. "It would form the brains of a gallium arsenide computer." Gallium arsenide as an IC material is noted for its speed, resistance to natural radiation, and use of less power than silicon chips.

Geideman said the new chip, a bit-slice processor, is "tested and fully functional." It emulates the AMD2901 and could run the same software. The 4-bit chip measures one-eighth inch square, contains 1860 transistors, and uses 135 milliwatts of power.

Geideman said he hopes to assemble a 16-bit computer using the new architecture and several other chips. The company said it is developing a 32-bit GaAs microprocessor.

And Jessica Had Amnesia, and Dorian Really Wasn't Dead, and . . .

A computer science professor at Columbia University (New York City) is working on a program designed to generate plot outlines for soap operas. The program, called Universe, can currently generate only a few outlines. But professor Michael Lebowitz thinks he can get the program to generate a significant variety of plots by expanding its knowledge base to a size approximately two orders of magnitude larger than its present dimension.

To design the program, Lebowitz monitored one soap opera, "Days of Our Lives," and noticed some patterns. For example, there is usually some force keeping lovers apart. In a two-year period, Lebowitz counted three dead spouses who turned out to be alive, four lovers who died (at least temporarily), and three lovers who contracted some type of disease (one of which, of course, was amnesia).

Universe is being written in LISP and is now running on a DEC 20 mainframe, although Lebowitz says it could easily run on an IBM PC AT. Lebowitz predicts that the program will probably not replace scriptwriters but says it may be useful as a scriptwriter's assistant.

Nanobytes

An industry source who recently dissected IBM's 3½-inch external disk drive (introduced in April and available for the PC, PC XT, and PC AT) says the drive itself is a 2-megabyte drive, from **Alps Electric USA**, that could be formatted for as much as 1.4 megabytes of data, instead of its current capacity of 720K bytes. This leads to speculation that a new version of PC-DOS will enable users to exploit the full 1.4 megabytes, which would provide incentive to switch from 360K 5¼-inch drives to the new microfloppies. . . . **Phoenix Technologies Ltd.** (Norwood, MA) and **Interactive Systems Corp.** (Santa Monica, CA) have agreed to jointly develop software designed to provide a "virtual" PC environment under UNIX System V version 3.0 for computers based on the Intel 80386 microprocessor. The V86/ix (an internal name) software would allow PC-compatible DOS applications to run as a task under UNIX without modification. . . . **The Association of Independent Microdealers** (Peoria, IL) has formed a special interest group called the Computer Musicians Cooperative, aimed at bringing together computer dealers, music dealers, manufacturers, and people who are interested in computer music. . . . **The U.S. Naval Observatory** (Washington, DC) is planning to put out a disk of astronomical information for professional and amateur star-watchers, navigators, meteorologists, engineers, and other people who want to know what's happening in the heavens. The Floppy Almanac will run on MS-DOS machines. . . . **NSI Logic Inc.** (Marlboro, MA) has integrated five graphics standards on one chip. The user-programmable EVC (Enhanced Video Controller) -315 can emulate the Color Graphics Adapter, the Monochrome Display Adapter, the Enhanced Graphics Adapter, the Hercules Graphics Controller, and the Professional Graphics Adapter.

Pre-shrunk. Pre-fitted. Pre-thunk.

When you buy a Ven-Tel modem, you buy 12 years of well thought out, innovative technology that's custom-tailored to your needs.

Like the PC Modem Half Card,[™] the first modem ever shrunk to fit into a short slot, so you'd have another long slot for more memory or other functions.

And our "pre-fitted" 2400 baud modem—the only 2400 that lets you double your transmission speed *without* reconfiguring your PC, buying new software or changing switches.

Another thing: other modems have 300 or so working components, ours have 70. That means they use less energy and generate less heat—the main cause of PC malfunctions.

Even so, we back every Ven-Tel modem with a free *five-year* warranty. No other major manufacturer even comes close.

So when the Ven-Tel modem you buy off the shelf seems like it was custom made for your office, don't be surprised. It was.

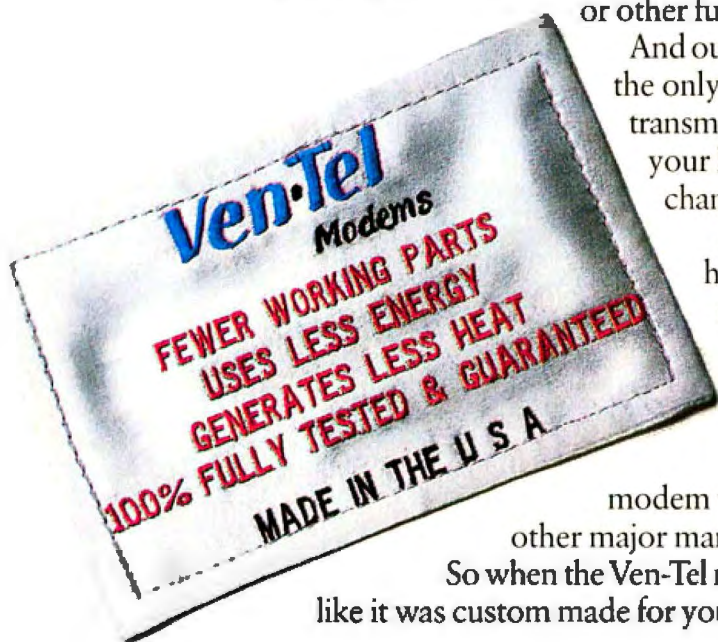

Ven-Tel

Modems

Our free 24-page booklet, "How To Select The Correct Modem," contains specific information about our full line of modems. To request your copy, call 800-538-5121. In California, call 408-727-5721.

New Fro

40 Megabyte Capacity, BACKUP™ Tape System.

Irwin has raised tape backup to a capacity of 40 megabytes. And, just as with Irwin's 10 and 20 megabyte systems, the micro cartridge is so small, it fits easily in a shirt pocket. This new 40 megabyte system provides all of the features and advantages that have made Irwin BACKUP™ Tape Systems the best selling in the microcomputer industry. *Here's why!*

Irwin's Complete and Friendly Software makes backup convenient and easy to use. Menu driven, Irwin software permits unattended backup of your entire disk or only specific files you select.

Interchangeability is Assured by Irwin's patented SERVO™ track following feature. Your Irwin Micro Cartridge can be accurately read on any computer equipped with an Irwin BACKUP™ Tape System.

Irwin's EC/TAPE™ provides automatic error correction. This eliminates the need for verification and assures you of data integrity.

Extremely Affordable,

less than \$1,000*, the Irwin 40 megabyte BACKUP™ System more than pays for itself the first time it is used to restore data.

Designed Specifically to protect information stored in microcomputers equipped with hard disks, each Irwin 10, 20 and now 40 megabyte system includes models for internal mounting drive or external plug-in. Irwin BACKUP™ Systems are designed for IBM PC/AT, IBM PC/XT and most popular compatibles.

Now there's 40 megabyte protection that is easy to use and affordable. Why take unnecessary risks? Call 1-800-BACKUP 1 or visit a leading computer store for a "hands-on" demonstration.

IRWIN™ Irwin Magnetics, Box 7639
MAGNETICS Mt. Prospect, IL 60068
1.800.BACKUP.1

*Suggested retail price.

Inquiry 175

© 1986 Irwin Magnetics Systems, Inc.
IBM PC/AT and IBM PC/XT are registered trademarks
of International Business Machines Corp.

m Irwin!



HILBERT CURVES MADE SIMPLER

Thank you for June's Programming Insight, "Hilbert Curves Made Simple." I was not familiar with these elegant designs. It seemed to me, however, that the Hilbert curve would lend itself to simpler, more self-evident instructions in the Logo language rather than in BASIC.

After reviewing Michael Ackerman's article, I sat down with Apple Logo II and taught the turtle that Hilbert curves, regardless of complexity, were simply right-hand curves and left-hand curves that alternate in a constant, recursive pattern. I carefully explained to the turtle that these curves could be generated with only three procedures and two variables:

```
TO HILBERT :ORDER :SIZE
PENUP
SETPOS [-125 115]
SETHEADING 180
PENDOWN
CURVRIGHT :ORDER
END
```

```
TO CURVRIGHT :ORDER
IF :ORDER = 0 [STOP]
LEFT 90
CURVLEFT :ORDER - 1
FORWARD :SIZE
RIGHT 90
CURVRIGHT :ORDER - 1
FORWARD :SIZE
CURVRIGHT :ORDER - 1
RIGHT 90
FORWARD :SIZE
CURVLEFT :ORDER - 1
LEFT 90
END
```

```
TO CURVLEFT :ORDER
IF :ORDER = 0 [STOP]
RIGHT 90
CURVRIGHT :ORDER - 1
FORWARD :SIZE
LEFT 90
CURVLEFT :ORDER - 1
FORWARD :SIZE
CURVLEFT :ORDER - 1
LEFT 90
FORWARD :SIZE
CURVRIGHT :ORDER - 1
RIGHT 90
END
```

The first procedure, HILBERT, tells the

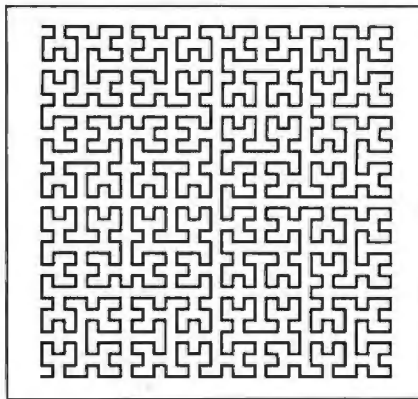

Figure 1: Hilbert curve with Logo.

turtle where to start and that the largest pattern will be that of a right-hand curve. The other two procedures (CURVRIGHT and CURVLEFT) show the turtle how to make right- and left-hand curves and where to make the little side trips.

The symmetry of the curve is suggested in the palindromic nature of the two mirror-image procedures. The swapping of right and left turns is built in. Even to those unfamiliar with programming, this Logo program conveys how complex designs (like figure 1 above) can be generated by a few simple, understandable instructions.

MARK D. WIDOME
Hershey, PA

IN DEFENSE OF AMIGA

Much of the "discussion" about popular personal computers approaches the fervor usually reserved for religion (and computer languages). While it is not my intention to turn BYTE readers into Amiga converts, the misinformation in Ronald Miller's comments in the June Letters column ("Putting the Amiga to Good Use," page 14) cries out for clarification.

Specifically, Mr. Miller:

- Based his opinions on a conversation he had with one dealer. I know a dealer who worships the Osborne 1 and has little use for anything else.
- Concludes that the IBM PC's 8087 chip is faster and more precise for numerical work than the 68881. BYTE readers should keep in mind that the 68881 is to the

68000 what the 8087 is to the 8088. Would it be fair of me to say that the 68881 runs rings around the 8087 for accuracy and speed? Astute readers will also notice that the IBM PC does not come with the 8087. In both machines the math coprocessor is an add-on.

- Worries about RAM glitches corrupting his data. While this is not a meritless concern, it is minuscule compared to the possibility of a "bad bit" (or worse) on your disk, where far more information is stored. Memory errors seldom happen; disk errors happen too often. It is much more critical to have a file system that helps you recover from disk errors. AmigaDOS may well be the most secure file system on any personal computer, just for this reason.

A recent experience comes to mind: I was compiling a program on the Amiga while a friend sat next to me using an IBM XT. As I got up to stretch, I inadvertently kicked the power strip where the two computers were plugged in, flickering power off for a split second. The XT monitor flashed, then the machine rebooted itself. The Amiga monitor flashed. Period. The disk drive kept on spinning, and the compile finished normally. Which machine do I want to keep my database on?

- Is amazed at how bad the 80-column text is and suspects that a font change would fix that. Correct. In fact, the Amiga fonts are not generated by a character generator chip; all fonts are changeable. The Sidecar (Amiga PC-compatible add-on) font looks just like the IBM PC font, for example.

- Rules out the machine as a word processor because it does not have monochrome video output. I don't now how this

(continued)

LETTERS POLICY: To be considered for publication, a letter must be typed double-spaced on one side of the paper and must include your name and address. Comments and ideas should be expressed as clearly and concisely as possible. Listings and tables may be printed along with a letter if they are short and legible.

Because BYTE receives hundreds of letters each month, not all of them can be published. Letters will not be returned to authors. Generally, it takes four months from the time BYTE receives a letter until it is published.

LOOKING FOR THE BEST VALUE IN PC/AT COMPATIBLES?



INTRODUCING THE \$1495 A★STAR™

Looking for a lower priced, higher quality PC/AT compatible than our new A★Star™ is like looking for a needle in a haystack. You're more apt to come up with a case of hayfever.

A★Star gives you features you won't get from *any* other vendor. Not IBM. Not Compaq. Not even those foreign manufacturers. Features like a 220 watt power supply, eight available expansion slots and "network ready" multi-user operation. All for only \$1495. And that price includes a 1.2MB diskette drive, 512KB memory, a fixed disk/diskette drive controller, a tactile feedback keyboard (you'll love it!) and a 6/8MHz switch/software selectable 80286 CPU.

Best of all, A★Star is quality built right here in America by Wells American Corporation - an American Stock Exchange manufacturer. So now you

can buy with confidence from a vendor you can trust, just like you've trusted IBM. And you'll get a genuine, top quality product (not a cheap imitation) for a price even less than those "questionable" mail order clones. And if that's not enough, it's all money-back guaranteed!

The \$1495 Wells American A★Star.™



A PC/AT FOR ONLY \$1495? THAT'S NOTHING TO SNEEZE AT!

[Hurry! This offer is limited.]

- I'm tired of sneezing! Have someone call me immediately to take my order.
- A★Star sounds terrific. Tell me more.

Name: _____

Company: _____

Phone: _____

Address: _____

City: _____

State: _____ Zip: _____



Wells American

803/796-7800 • TWX 510-601-2645
Sunset Boulevard • West Columbia, SC 29169



Super Power Compatibility

The POWER SYSTEM™ from PECAN has set a new standard for comprehensiveness in program development environments that you won't find anywhere else:

PORTABILITY: Whether you're an ardent beginner or a seasoned pro, THE POWER SYSTEM lets you design software that can run on virtually any mini or micro without having to rewrite the program. The program you write on one computer will operate on another—even if the two hardware systems are incompatible. Your software never becomes obsolete—even if your hardware does.

INTEGRABILITY: The versatility and flexibility of THE POWER SYSTEM enables different users to exchange program modules freely with one another, even though the modules may be written in different programming languages.

LANGUAGE INTERCHANGEABILITY: THE POWER SYSTEM lets you customize the modules of your application in the most appropriate of Pecan's powerful languages including UCSD PASCAL, BASIC, FORTRAN-77, ASSEMBLER, or MODULA-2. Once you've created your multi-language program, the modules are linked automatically. The application then runs as if you'd written it all in one language.

THE POWER SYSTEM FEATURES:

- NATIVE CODE • SEPARATE COMPILATION OF UNITS • EXTENDED PRECISION ARITHMETIC
- DYNAMIC MEMORY MANAGEMENT • EVENT-DRIVEN MULTI-TASKING • CONFORMANT ARRAYS
- PROCEDURAL PARAMETERS • 8087 AND BCD SUPPORT (PC'S AND COMPATIBLES) • LARGE FILE EDITOR
- LIBRARY UTILITY • ON-LINE HELP SYSTEM • FILE MANAGER

THE POWER SYSTEM Only \$99.95

For PC-DOS, MS-DOS, AMIGA, ATARI ST, MACINTOSH, RAINBOW, TANDY, STRIDE, as well as most popular 8/16/32 bit systems. Also available in VAX, UNIX, PDP-11 OS's & others.

THE POWER SYSTEM includes the language of your choice: UCSD PASCAL, MODULA-2, BASIC, ASSEMBLER and FORTRAN-77. Choose an additional language for only \$79.95. Buy three and we will send you a fourth one **FREE!**

To custom-tailor software, PECAN offers such programming tools as:

CROSS-ASSEMBLER/NGC PACKAGE.....	\$79.95	SOFTTEACH TUTORIAL.....	\$49.95
KEYED SEQUENTIAL ACCESS METHOD.....	\$59.95	MENUMAKER.....	\$49.95
CODE OPTIMIZER.....	\$59.95	PROGRAM ANALYSIS TOOLKIT.....	\$59.95
SYMBOLIC DEBUGGER.....	\$59.95	SORT UTILITY.....	\$59.95

Write for complete list of development aids.

ATTENTION CORPORATIONS: Call and ask about our training seminars.
SCHOOLS: Special Educational Discounts

NOT COPY PROTECTED

Mail Your Check Or Money Order To:
Pecan Software Systems, Inc.
1410 - 39th Street
Brooklyn, New York 11218
(718) 851-3100
ITT TELEX NUMBER: 494 8910
COMPUSERVE CODE: 76703,520

PECAN™
The UCSD Pascal Company

Credit Card Orders **1-800-63-PECAN**
Call Toll Free (NYS) 1-800-45-PECAN

Please add \$2.50 for shipping within the US. Foreign orders add \$10.00 and make payment by bank draft payable in US dollars on US bank. New York State residents add appropriate sales tax.

UCSD Pascal is a trademark of The Regents of University of California.

Inquiry 269

could help. I am typing this letter on the Amiga, which (at the moment) has a black screen with amber letters (and a white cursor so I can always find it quickly, and blue depth-arranger icons, too, but that's beside the point) and a custom font. I have often sat here for hours and have never developed a headache from the display. A nice long-persistence monitor and my 50-line word processor work very well together, thank you.

• Dismisses the Amiga from being a "real graphics" machine without explanation. If he means it's not a \$30,000 dedicated graphics processor, I see his point. Similarly, Mr. Miller asserts that it cannot be used for image processing work because it does not have 1K by 1K by 256 capability.

First, no personal computer fits these descriptions, save those that have been enhanced with third-party add-on boards. Second, for those who can't afford to do "real graphics" on a \$30,000 system, a quarter of the functionality can be had for 5 percent of the price. Third, the hardware in the Amiga 1000 doesn't have 1K by 1K by 256 capability (yet), but the software has always had the capability.

• Asks the question, "What is an Amiga good for?" My mother asks that about all personal computers. For the amount of time and money we shovel into these glorified hobbies of ours, could we really justify them? Ten years from now we might come across an old issue of BYTE and remember what religions (machines, languages, text editors) were then. And laugh.

BOB PAGE
Andover, MA

SMALLTALK AND SPACE BLANKETS

As a developer of object-oriented languages and a Smalltalk fan, I read with great interest I. Ganapathy's letter in the June issue ("Problems with Smalltalk," page 24). I have to agree that Smalltalk-80's windowing problems are significant and a real drawback to anyone hoping to write an application and release it to inexperienced users.

Part of the problem is that getting Smalltalk's windows to work well on smaller machines would have required a great deal of optimization and recoding in machine language. This obviously makes the language far less portable and gives pause to any potential implementor.

Another part of the problem is the nature of Smalltalk's genesis. Smalltalk was developed in a research branch of Xerox and will never be a significant profit center. Since Smalltalk is hardly relevant to Xerox's corporate survival, there isn't the

(continued)

The source of Wizardry...

Throughout history people have sought the aid of wizards to advise and direct them through the mysteries of the age. These powerful beings were believed to be the purveyors of supernatural substances, the weavers of secret spells, and keepers of a magic lore. Today we know what was once magic is simply a combination of knowledge and ability—the ability to manipulate an environment and solve its most difficult problems.

Today's wizards seldom make such claims to supernatural powers, yet they work their magic still: in global communications, information networking and a range of areas that once existed only in a world of imagination. No longer fantasy, this is the magic on which a real world now depends.

Ours is an age that demands a knowledge of systems software for computer networks, switching systems, expert systems and a variety of powerful operating systems including the UNIX[®] operating system and UTS[®] on machines

ranging from micros to mainframes.

At Lachman Associates, Inc., we understand the unique position of the systems professional who holds the secrets of this specialized knowledge.

We understand because of who we are:

over 125 full-time consultants who advise and direct sophisticated technical projects for some of the largest companies in the world. The spells we weave and the magic we summon can create high-reliability operating systems; telephony products; networking with TCP/IP, OSI, X.25, and ISDN; Network File Sharing (NFS); engineering and scientific applications; multi-processor architecture evaluations; training, product analysis and documentation; or still another environment yet to be imagined.

So be advised. Wizards do exist. In fact you might be one. If not, remember us. Someday you will surely need one.

Equal Opportunity Employer
Resumes accepted in confidence



L A C H M A N

Lachman Associates, Inc.

Corporate Offices

645 Blackhawk Drive • Westmont, IL 60559
312 986 8840

*the UNIX[®] systems
people*

Chicago Columbus
Denver New Jersey

UNIX is a registered trademark of AT&T.
UTS is a trademark of the Amdahl Corporation.

The world's best data acquisition software just got better.

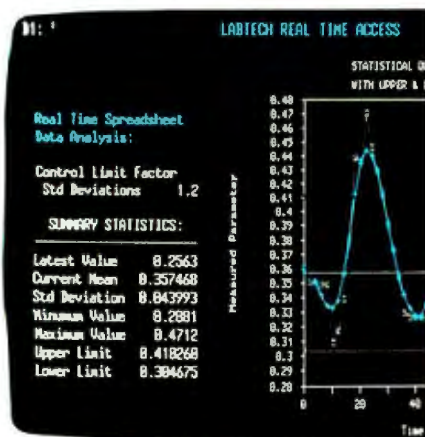

Real time data flowing into a Symphony spreadsheet.

with LABTECH Real Time Access.

With LABTECH Real Time Access you have a link between NOTEBOOK and any other MS/PC-DOS application package. A real time link that serves as a data "pipeline" between the two.

So now you can move data directly between NOTEBOOK and Lotus 1-2-3®, Symphony®, Ashton-Tate's dBASE III®, MathSoft's MathCAD™, or other spreadsheets, data bases, statistical analysis systems, or programs that you develop.

If you already own LABTECH NOTEBOOK you're probably already thinking of new ways to use it with Real Time Access. If you don't have NOTEBOOK now, you have one more reason to invest in it.

Find out more about LABTECH NOTEBOOK, the accepted standard in Data Acquisition software, and LABTECH Real Time Access, the ultimate option. Call or write Laboratory Technologies now for complete information.

LABTECH software is compatible with: IBM PC, XT, AT, compatibles

LABTECH NOTEBOOK works with Instrumentation Interfaces from: Acrosystems, Action Instruments, Advanced Peripherals, Analog Devices, Anasco, Burr-Brown, Coulbourn Instruments, Cyborg, Dataq, Datatek, Data Translation, Datal, HanZon Data, IBM, ICS/Action, Interactive Microware, Interactive Structures, Keithley, Metrabyte, Microhybrid, Micro Star Laboratories, National Instruments, Omega Engineering, Scientific Solutions, Strawberry Tree and Taurus.



Laboratory Technologies Corporation
255 Ballardvale Street, Wilmington, MA 01887
(617) 657-5400.

dBASE III is a registered trademark of Ashton-Tate. Lotus 1-2-3 and Symphony are registered trademarks of Lotus Development Corporation. MathCAD is a trademark of MathSoft, Inc.

LETTERS

same kind of motivation to support the language with new releases. I'm sure Smalltalk is extremely important to the group at PARC, but their *raison d'être* is research, not technical support.

This may also explain why so little emphasis was placed on "cosmetic" issues such as clean, fast windowing. It seems that more attention has been given to the underlying elegance of the language than to the external features. Many of the windowing problems have been addressed in Smalltalk systems used internally at Xerox. As of a couple years ago, however, these fixes had not been applied even to the system used for demonstrations.

Ironically, Smalltalk is the system that popularized windows in the first place. Now that windows are hot, Smalltalk has been outclassed by hungrier, more profit-minded competitors in the commercial marketplace. Nevertheless, we all owe Smalltalk and Xerox PARC a tip of the hat for many innovations that are just now finding their way into the mainstream of personal computing. I suppose it's kind of like NASA and space blankets.

CHARLES B. DUFF
Evanston, IL

novices like me. I would like to suggest replacing the symbols used in the article with more informative icons.

Figure 2 below shows the symbols for the basic operators and the apply node. I designed the icons to make the point that they can make learning easier.

STEVE METSKER
Portland, ME

ITERATIVE VS. NONITERATIVE INVERSION

Several correspondents have pointed out something to me that should have been made clear in my article ("Inversion of Large Matrices," April) and was not; namely, for serial processing—meaning home computers—any iterative method of matrix inversion, such as Pan-Reif, is far inferior in speed and memory economy to established noniterative inversion-in-place methods such as Gauss-Jordan. Computations sent to me by Alfred Allen of Victoria College in Victoria, Texas, for example, show a speed advantage of the latter methods using compiled BASIC, over the program I gave using interpreted BASIC, by factors of 20 to 40 or even more.

To exploit the Pan-Reif "breakthrough," one has to be serious about needing speed in the inversion of very large matrices. This means investing sizable sums of money in parallel processing hardware.

On consulting the references I gave, one finds the following: Let $M(n)$ be the

(continued)

LINKING DATA FLOW WITH DEVEILED HANDS

I found "Linking Data Flow and Functional Languages" (by Chris Hankin, David Till, and Hugh Glaser, May) enlightening, but I had trouble getting used to the notation used in the data flow diagrams. To make reading data flow diagrams easier for

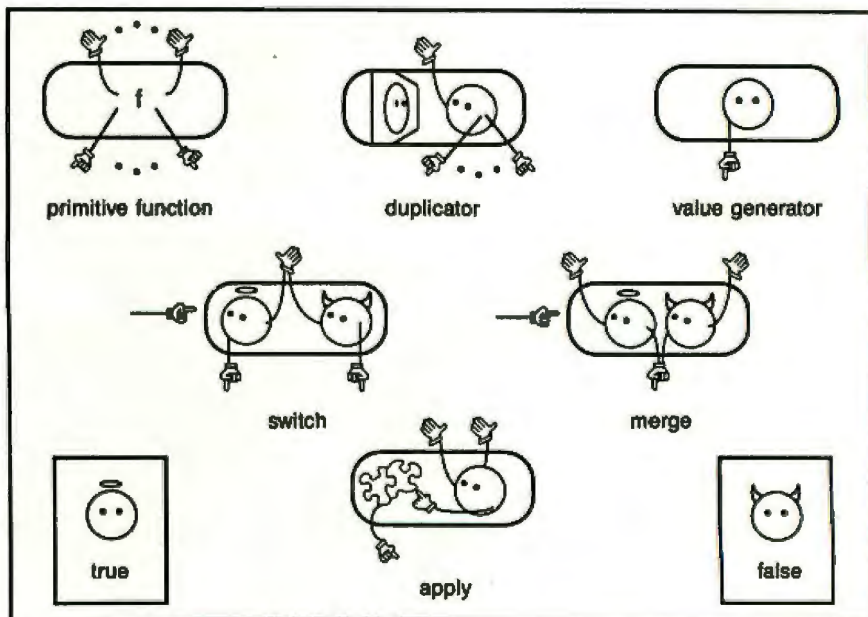

Figure 2: Truth, Falsity, the basic operators, and the apply node.

AST's EGA Solution: Upgradeability Is Just A Chip Away



Introducing AST-3G™ Plus

A lot of EGA boards bundle together IBM® EGA, MDA, CGA and Hercules™ modes, whether you need them or not. And like it or not, you pay for them. AST-3G offers something a little different—customer's choice.

Optional CGA, Hercules, MDA Modes. Buy AST-3G's super EGA graphics solution today, and if you don't need compatibility with Hercules, CGA and MDA, you don't have to buy it. If you change your mind later that's okay too. Upgradeability is just a chip away using the AST Plus Enhancement Kit.

Easy Upgradeability. The Plus Enhancement Kit makes the upgrade to CGA, Hercules and MDA modes a simple matter of just snapping a chip into the AST-3G board. And for you corporate buyers, here's your chance to mix and match several boards according to your needs.

AST-3G Is Feature Perfect. With or without the Plus Option, AST-3G offers high-resolution 640 x 350 graphics, full-spectrum color capabilities, high-quality text and across-the-board compatibility with all your applications, including business/presentation graphics, CAD/CAM, graphic arts and desktop publishing. AST-3G virtually transforms your PC into a presentation medium to create, preview and present clear, clean, crisp text and sizzling graphics.

Graph-In-The-Box™ Software Included. You can produce a variety of sharp, colorful charts from spreadsheets, word processing, database programs and more using this revolutionary RAM-resident software we've included. Graph-In-The-Box captures data from whatever program you are running and generates a chart on the spot, without ever leaving your applications program.



Enhanced Graphics Adapter (EGA) Mode

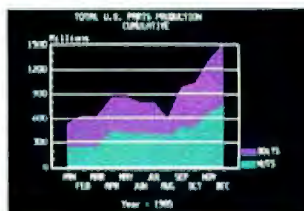

Color/Graphics Adapter (CGA) Mode



Hercules Graphics Mode



Monochrome Display And Printer Adapter (MDA) Mode

Give Yourself An Option With AST-3G. For more information contact your local AST authorized dealer, or call our Product Information Center (714) 863-1480. AST Research, 2121 Alton Ave., Irvine, Ca. 92714. TWX: 753699 ASTR UR.

**AST
RESEARCH INC.**

AST-3G trademark of AST Research, Inc
IBM registered trademark of International Business Machines Hercules trademark of Hercules Graphic Products, Inc Graph-In-The-Box trademark of New England Software. Copyright 1986 AST Research, Inc. All rights reserved



The Plus Is On Us

Mail in this coupon to AST today, and you will receive an AST-3G Plus Enhancement Kit absolutely free (a \$75 value). The kit provides CGA, Hercules and MDA compatibility on your AST-3G.

- Please send me a free AST-3G Plus Enhancement Kit.
 Please send me more information on the AST-3G.

Name _____

Title _____

Company _____

Address _____

City _____ State _____ Zip _____

Phone _____

AST Research, Inc. 2121 Alton Avenue, Irvine, CA 92714-4992

B3G - A1 Offer Expires 9/30/86

number of parallel processors required to multiply two $n \times n$ rational-number matrices in total time of the order of the logarithm of n , written $O(\log n)$. Prior to Pan-Reif, the most efficient known algorithms for inverting a nonsingular $n \times n$ matrix required $O(\log^2 n)$ time and $M(n) \times n^{1/2}$ processors. Moreover, all known algorithms of this "polylog-time" type were unstable—that is, they required calculations of perfect precision to yield any results at all.

The Pan-Reif algorithms, of which I gave a sample, are stable and forgiving of low-precision arithmetic and run in $O(\log^2 n)$ time with $M(n)$ processors, provided the matrix is not too poorly conditioned. The requirement is that the number denoting the "condition" of the matrix be less than n^k for some constant k . The elements of the inverse matrix are obtained with relative precision 2^{-t} , where $t = n^k$ for some constant k . It should be added that fast multiplication methods are involved—I

presume in hardware.

Needless to say, any polylog-time algorithm is much faster than any power-of- n -time algorithm for large enough n . So, we are speaking of exciting progress from the standpoint of, say, the Department of Defense, which may not care what it costs to invert large matrices of data on incoming enemy missiles. BYTE readers are not in this category. Still, for anyone interested in iterations, it is intriguing to watch the algorithm at work—struggling away, gradually overcoming its difficulties . . . so much like the human mind at work on a problem that one is tempted to view the "thinking" process as some sort of iterative algorithm.

My intent in assigning both plus and minus entries to the random-entry A -matrix to be inverted was to show that the Pan-Reif method works for any real-number entries and is not limited to those of one sign. Incidentally, the REM at line 130 of my listing 1 is misleading in its reference to an alleged need to "input normalized data" in case a user-supplied matrix is to be inverted. Any real numbers can be input—they need not be normalized. In reference to numerical checks on the inversion, line 250 of the listing assures that no entry of the difference between the identity matrix and the matrix product $B \times A$ for $B = A^{-1}$ exceeds in magnitude some chosen small number—be it called a criterion or a tolerance. The routine at lines 500 to 610 makes a similar check for the reversed-order product $A \times B$. I am indebted to a former BYTE technical editor, Tom Clune, for the latter refinement.

THOMAS E. PHIPPS JR.
Urbana, IL

FoxBASE wins the dBASE race!

6.43 times faster than dBASE III PLUS

New FoxBASE+ sweeps the field: runs 2.26 times faster than Clipper, 6.69 times faster than dBCOMPILER, and 10.86 times faster than dBMAN! And FoxBASE compiles programs up to 60 times faster than other compilers.

The others aren't even close!

New FoxBASE+ is totally compatible with dBASE III PLUS as is original FoxBASE with dBASE II. No changes in your present programs, databases, screens, or reports!

Though FoxBASE is a super-fast compiler, it offers the familiar, user-friendly interactive features of dBASE and the full power of "dot prompt" mode plus many significant enhancements.

Best of all, FoxBASE is economical. Single-user FoxBASE costs just \$395, multi-user FoxBASE \$995**—no matter how many workstations you have.

So call (419) 874-0162 now, and ask for a copy of our detailed benchmarks. After all . . .

Nothing Runs Like a Fox.

FOXBASE 

Fox Software
27475 Holiday Lane, Perrysburg, OH 43551
(419) 874-0162 Telex: 6503040827

FoxBASE is available in single and multi-user versions for MS-DOS, XENIX, UNIX, many networks, and other environments.

*Continued on page 135
©1986 Fox Software
FoxBASE, FoxBASE+, and
Fox Software are trademarks of Fox Software.
dBASE II and dBASE III PLUS are trademarks of Ashton-Tate.
Clipper is a trademark of Borland International.
dBCOMPILER is a trademark of Microsoft Corporation.
dBMAN is a trademark of AT&T.
IBM and PC are registered trademarks of International Business Machines Corporation.



CRT RADIATION

I am writing in response to the letter from William G. Nabor ("CRTs Are Safe," May, page 24). As Mr. Nabor correctly asserts, CRTs do not emit significant amounts of ionizing radiation. They do, however, affect the concentration and trajectory of ions (charged particles) in the vicinity of the screen. The relative concentration of positive and negative air ions is known to have physiological effects on humans and animals. High concentrations of positive ions can cause irritability, increased susceptibility to respiratory infections, and fatigue. These effects are seen on a large scale during certain weather phenomena that increase the concentration of positive ions in the air, such as the Santa Ana wind in California or the Witch Wind in Israel, for example.

The positively charged screen of the CRT creates a region of high positive ion

(continued)

THE PC PENS



Discover new dimensions in PC graphics with Houston Instrument's "PC Pens"—a family of desktop plotters that allow you to add brilliant color and clarity to your presentations.

Starting at \$699,* these compact plotters produce professional graphics that dot-matrix printers simply can't match. With sharp resolution, HI's PC Pens give you countless graphic choices—a variety of pen types (felt tip, hard nib, and drafting), plotting media (paper, vellum, and transparencies), and special firmware.

Whether you're producing sales graphs, creating CAD drawings,

or charting household finances, these plotters complete the picture on 8½ × 11 or 11 × 17 inch formats.

Choose from Houston Instrument's single-pen DMP-40, the four-pen PC Plotter series, or the impressive eight-pen DMP-29. Each features a standard RS-232-C compatible interface and Houston Instrument's built-in DM/PL™ language, making each one immediately compatible with most microcomputers and hundreds of software packages. And each is remarkably reliable and simple to use.

For more information and the name of the distributor nearest you, call Houston Instrument at 1-800-531-5205

(512-835-0900 if in Texas) or write Houston Instrument, 8500 Cameron Road, Austin, Texas 78753. In Europe, contact Houston Instrument, Belgium NV., Rochesterlaan 6, 8240 Gistel, Belgium. Tel.: 32-(0)59-277445, Tlx.: 846-81339.

*U.S. suggested retail price for PC595 model plotter. Pricing subject to change. DM/PL is a trademark of Houston Instrument.

Inquiry 164

houston instrument

A Division of AMETEK

flux, in which the user's face is generally immersed. This could affect the health of users who are sensitive to ion concentrations. A grounded screen positioned in front of the surface of the CRT will reduce the flux of ions in the vicinity of the user. I have not seen the advertisement to which Mr. Nabor refers, but I suspect that the advertisers have confused the terms "ionizing radiation" and "ions."

WILLIAM L. COBB
Melrose, MA

EASY C: IS THE EASY WAY THE BEST WAY?

I much appreciate your continuing interest in the C language and the high caliber of BYTE's articles on C.

In "Easy C" (which appeared in the May BYTE), Pete Orlin and John Heath describe a set of mnemonic replacements for certain C operators, keywords, and syntactical elements. The intent was "to produce a version of C that is quicker to learn and apply."

This approach is undesirable for several reasons:

A programmer who learns Easy C will not be literate in standard C and will not be able to read fluently in the C literature. Does not communication require adherence to accepted rules of style (in this case the rules of standard C)? Is it not wrong to teach, "As with any question of style, subjectivity is the rule"? Should not changes in an established language be made cautiously, as the ANSI group is doing?

A program written in Easy C is difficult to read PERIOD Uppercase characters draw the eye to keywords COMMA operators COMMA and delimiters COMMA so moving the focus of attention away from the principal content of statements PARENTHESIS variables COMMA functions COMMA values COMMA etc PERIOD PARENTHESIS PERIOD In the examples given in figures 5 and 6 PARENTHESIS pages 146 and 148 PARENTHESIS COMMA it may be easier to follow the flow of the program in Easy C COLON but does not the eye of the reader more readily find the variables and see the operations upon them in something written in standard C QUESTION MARK If you doubt this COMMA try to scan for information a paragraph such as this COMMA in which punctuation EM DASH period COMMA comma COMMA etc PERIOD EM DASH is replaced by uppercase words.

A major attraction of the C language is its clarity. One can generally understand at first reading uncommented C code written by another programmer. Heavily commented FORTRAN and BASIC can be unreadable, even for the coder after a bit of time has gone by. As illustrated in the preceding paragraph, the introduction of uppercase mnemonics reduces the clarity of the C language. I am sensitive to this, perhaps because of having been compelled awhile ago to write a filter that helped maintain sanity by converting, back to standard C, code written in a version of C like Easy C.

An aesthetic point: I believe that much of the visual beauty of C code is lost when uppercase words replace sparse C tokens.

The use of #define statements to allow mnemonic replacements of standard C operators is found occasionally in the C literature, and the excellent Van Nuys Toolkit, placed in the public domain in 1983, was written in an Easy C-like dialect. Such attempts to change the form of C have not met with general acceptance.

(continued)



VTERM/220 Quality makes all other DEC terminal emulators obsolete

Over 35,000 demanding professionals, like Teradyne's Gregg Prescott, have recognized VTERM's superior quality.

Now this same VTERM quality is available in Coefficient's powerful new emulator, VTERM/220.

Features include:

- Plug compatible VT220 emulation with 132-column support and optional Tektronix™ 4010/4014 graphics.
- Extensive file transfer system offering KERMIT, XMODEM and our VTRANS protocol with VMS™, RSX 11 M/M+, RSTS/E™ and UNIX™ software.
- Host data capture on PC with conversion to Lotus® 1-2-3®, Symphony® and dBase®
- "Hot Key" toggle between host session and PC DOS.

Call us today at 212-777-6707 ext. 190.



Coefficient

The Leader in DEC Emulation Software

Coefficient Systems Corporation
611 Broadway, New York, N.Y. 10012

Trademarks: DEC, VMS, RSTS/E, RSX 11 M/M+, Digital Equipment Corp.; Tektronix, Tektronix, Inc.; Lotus, 1-2-3, Symphony, Lotus Development Corp.; dBase, Ashton-Tate, UNIX, AT&T, Bell Laboratories

jc lips

The Word is Out...

It's going to break your heart if you already own a PC.

JC LIPS provides a new experience in personal computing. Our third generation personal computer brings you technological advancement and features which have not been possible in the past. It runs all popular IBM PC software 2 to 4 times faster than other compatibles. It will impress you with unsurpassed performance and cool reliability. Best of all, it is available to you at an affordable price.

JC LIPS features the advanced-technology CMOS NEC V40 processor running at 8 MHz with an equivalent throughput of at least 9.5 MHz. The systemboard has 256K of RAM, expandable to 640K, a built-in floppy disk controller, a socket for a high speed floating point processor, and 8 I/O expansion slots. Also included as standard on systems are 360K floppy disk(s), a serial interface, a parallel printer interface, a battery backed-up clock, a keyboard, and a 135 Watt power supply, capable of handling all of this plus any accessories you may add later.

JC LIPS' display system includes a quality 14" high resolution monochrome monitor, with a dark

background non-glare screen and a tilt and swivel base for easy viewing. The multi-function display card provides an IBM PC compatible interface for a monochrome display with Hercules compatible graphics or a RGB color graphics display.

JC LIPS is also available with high speed 20 MB hard disk with 2K cache buffer memory controller, Enhanced Color Graphics display adapter, high resolution RGB color monitor, local area networking controller, and more. These options can be added at any time, and with the features we supply as standard, it will be a difficult system to outgrow.

NOW the word is out. Another superb product is available from the high-performance, multi-user systems company, JC Information Systems.



JC INFORMATION SYSTEMS

161 Whitney Place
Fremont, CA 94539
(415) 659-8440 TWX 910-381-7041

perhaps because one has to pay too much in clarity to obtain a modest decrease in frequency of coding error. If one believes this judgment is wrong, then should not the ANSI Standardization Committee, rather than individual dissenters, be enjoined to wrestle with the problem?

The moral? If you generate a mutated C, keep the new species to yourself and please let no others learn of your forbidden engineering, unless you are sure

the mutant is so well conceived that it will take over the world.

JOHN A. RUPLEY
Tucson, AZ

MODIFICATIONS TO CP/M

I have some unofficial modifications to CP/M v. 2.2 that might benefit BYTE readers.

- The DDT D command displays nonprintable characters with a period. This ar-

angement causes some confusion, because a period is not an infrequently used character. A better choice, I believe, would be the ASCII tilde (~) character.

Method: Change memory address 0E41 from 2E to 7E.

```
A>DDT DDT.COM press return
-SE41          press return
0E41 2E       enter 7E and press
              return
0E42 C3       enter a period and
              press return
-             press control key
              and C key
```

```
A>SAVE 19 DDT.COM
```

The following modifications assume the reader is proficient in the use of DDT.COM and can write assembly language utility routines to find the starting address of a byte sequence. A more intimate knowledge of CP/M is also necessary.

- When using Control-S to stop/start console output, pressing any other key, after initially issuing a Control-S, causes subsequent Control-S commands to be ignored.

Method: In the .COM file that is used for system generation, find the starting address of the byte sequence (in hex) B7 C2 G2. Change the next call instruction from call ??23H to call ??2AH; the ?? hex numbers are unchanged. Save the memory image and sysgen it. [Editor's note: Be sure to keep a backup copy of your original system disk.]

- Change the Control-S for stopping/starting console output to the space bar, which is more convenient.

Method: In a manner similar to that used in the second method above, find the starting address of the byte sequence (in hex) FE 13 C2 42. Change the 13H to 20H, save the memory image and sysgen it.

DAVID A. DANIELLO
Blacksburg, VA

A BUG IN PRODOS DIRECTORIES

I enjoyed the article "Sorting ProDOS Directories" (June) by Antonio Silvestri. Unfortunately, the sample program has a bug that Mr. Silvestri's test program will not detect.

The bug (pointed out by Glen Bredon, who noticed this same type of problem in early versions of several commercial ProDOS utilities) can be evidenced by expanding the size of a subdirectory file that has had its order in the parent directory altered by the sort. An easy way is to add more than 13 new files to the "relocated" subdirectory (which adds at least one block to the directory file's size); try the following steps:

(continued)

SideTalk™

It minds the phone while you do your work

No more interruptions! Because now SideTalk can transfer your files or receive your mail while you're using your computer for other important matters. And SideTalk is programmable with its own BASIC-like language. What's more, you're never more than a keystroke away from all of the power of SideTalk.

When we say SideTalk is the best telecommunications program on the market, we're not just talking out of the side of our mouth.



Lattice

To place your order:
Lattice, Incorporated
Post Office Box 3072
Glen Ellyn, Illinois 60138
312-858-7950
TWX 910-291-2190



Only
\$119.95



12MHz SPEED plus A MEGABYTE FOR DOS!



THEY ALL NEED NUMBER SMASHER/ECM™

Turn your PC or XT into the machine it should have been! The 12 MHz Number Smasher/ECM is the fastest accelerator on the market. It is also the most powerful, providing a **true megabyte** for DOS!

To break the 640K DOS barrier MicroWay designed a Memory Management Unit (MMU) that is tailored to DOS plus a 2000 byte resident driver - MegaDOS™. MicroWay calls this breakthrough Extended Conventional Memory. When you type CHKDSK with the board installed, your system will report 1,036,288 bytes total memory and 1,010,016 bytes free! Any conventional DOS program can utilize a full megabyte for data or code without changing a byte.

Downloading a mainframe application? ECM memory runs with any program that uses DOS for screen services including RM and MS FORTRAN and MS and LATTICE C! This means you have an additional 384K available for oversized applications. Programs which write directly to the screen require a simple patch to adhere to the new standard. MicroWay has already developed patches for the Lotus, WORDSTAR and AUTOCAD screen drivers. Release 1A of 1-2-3 jumps from 535,516 to 916,444 bytes available and runs faster than Release 2 for most worksheets.

Number Smasher/ECM is 100% compatible with all hardware and software including EMS and EGA boards. The compatibility is a result of control: its speed is switch, keyboard or software selectable from 4.77 MHz to 12.0 MHz. Applications which have not been upgraded to ECM can still be run by setting DOS to 640K or 704K and using the memory above DOS for I/O enhancers.

Number Smasher/ECM runs floating point bound programs faster than an AT or any other 80286 based machine. In fact, Number Smasher's 12 MHz 8087 runs a factor of three faster than the standard 80287 on the AT, delivering up to 125 kflops. Software is included for RAM Disk, print spooler, and disk caching, which speeds up floppy and hard disks by a factor of 2 to 10!

Number Smasher/ECM is the most cost effective productivity tool you can buy. The base board which runs at 9.54 MHz comes with 512K and costs only \$599! The complete system which includes a motherboard accelerator, one megabyte of memory and a 12 MHz 8087 is just \$1199. Call today to discuss your particular configuration. Remember: *"The advantage of buying from MicroWay is outstanding personal service."* (PC Magazine, 6/10/86 - p. 162)

Micro Way

The World Leader in 8087 Support

P.O. Box 79, Kingston, Mass. 02364 USA (617) 746-7341
Tempo House, London, U.K. call 01-223-7662

Number Smasher, ECM and MegaDOS are trademarks of MicroWay, Inc. MicroWay is a registered trademark of MicroWay, Inc.

1. Make (format) a ProDOS data disk (call it /TEST/ for the sake of argument).
2. Create two files (in this order):

```
CREATE /TEST/SUB.B
CREATE /TEST/SUB.A
```

3. Alphabetize the test disk.
4. Create 13 or more files within one of the subdirectories. A simple BASIC program to do this is

```
10 FOR = 1 TO 15
20 PRINT CHR$(4);"SAVE /TEST/SUB.A"
```

5. Try to read the contents of the subdirectory, as per the command
- ```
CAT /TEST/SUB.A
```

You should get a "beep" and a RANGE ERROR message after the 13th filename. The creation of 15 files in SUB.A expanded the size of the subdirectory, but this was not reflected in its entry within the parent directory. Incidentally, you can LOAD any

file within the subdirectory, even though you can't get CAT or CATALOG to display it.

The problem has to do with the rearrangement of subordinate directory entries while sorting a directory file. Each subdirectory file contains a link to its location within its parent directory. The link consists of a pointer to the block (of the parent directory) where the subdirectory's filename entry is located, and its numerical position among the 13 (possible) filename positions within the block. Mr. Silvestri's routine will usually move the filenames' positions within the parent directory (unless they happen to wind up in exactly the same positions after the sort) but does not correct the link in the subdirectory file itself.

In the example, we start with a newly formatted ProDOS volume named ?TEST (the volume directory will start block \$2). ?TEST will occupy the position of the first filename. We then CREATE the directory file SUB.B as its second entry and the directory file SUB.A as its third entry. Each of these entries will point to the actual file assigned to each of these names. Information within the file SUB.B itself will point to its filename's location within /TEST's directory as the third file in block \$2. SUB.A will similarly point to itself as being the second file.

Now we alphabetize the /TEST directory, SUB.A, SUB.B, and their associated data exchange places, so now SUB.A is the second entry and SUB.B is the third entry. But neither subdirectory file's links (pointing back to its original position in the parent directory) has been updated to reflect this! So now the link within the file SUB.A points to the entry (and data) associated with SUB.B.

The problem does not evidence itself immediately. What occurs is that any alteration in the status of one of the subdirectories that requires altering its entry within the volume directory will result in the improper entry being "updated." If SUB.A expands to eight blocks, the entry SUB.B will be assigned the new data instead, while the entry SUB.A is unchanged.

The way around this is to have the sort program correct the link to the parent within the subdirectory file. I don't have a quick and easy fix (I'm too lazy), but Glen Bredon has developed a set of ProDOS utilities that includes a program that may fix any directories after the fact. I hope Mr. Silvestri doesn't find this too discouraging, as a lot of programmers (and commercial programs) seemed to initially run into this bug. Volumes that do not use subdirectories (or in which the subdirec-

(continued on page 370)

## WHAT'S THE SECRET DEBUGGING WEAPON USED BY EVERYBODY FROM BORLAND TO ORACLE? FREE 44-PAGE ANSWER FROM ATRON.

"WE COULDN'T HAVE DONE IT WITHOUT ATRON'S HARDWARE-ASSISTED SOFTWARE BUGBUSTERS."

Philippe Kahn Larry Ellison  
Gordon Froese Oracle Pres.

This is the city saved by the Atron bugbusters. Your city. Full of wizards, with hundreds of millions of dollars invested in wringing every ounce of intelligence and performance out of your PC. It used to be plagued with the toughest software bugs known to mankind.

### PLAGUES OF BIBLICAL PROPORTIONS

The first and most difficult plague was impossible to trap with software debuggers. These were carnivorous bugs which randomly overwrote programs, data, even the debugger. Nastiest were the ones that slipped in once every few hours, or changed their behavior after each new compile. Forty days and forty nights of recompiling, trying something else, caused many a would-be resident of the city to run screaming into the wilderness, never to be heard from again.

Second came the plague of not knowing where the program was, or where it had recently been. This compounded the first plague: How could anyone know what caused the random memory overwrites? Add to this random interrupts and timing dependencies, and you begin to understand *The Fear* that gripped the city.

Then came the last plague, which brought the wizards to their knees before they even started debugging. Their towering programs consumed so much memory, there wasn't enough room for their symbol table, let alone debugging software. Even if they could get past the first two plagues, this one killed their firstborn software.

### ENTER THE HARDWARE-ASSISTED SOFTWARE BUGBUSTERS

The Atron solution came as a revelation: Monitor every memory reference and every instruction executed, by adding a hardware board to the AT or PC with an umbilical probe to the processor.

The result? Wham! The PC PROBE™ and the AT PROBE™ saved civilization as we know it. The first plague was cured with PROBE'S hardware-assisted breakpoint traps on reading, writing, executing, inputting and outputting. These could be done on single or ranges of addresses, and could include particular data values. All in real time. For a mere software debugger to attempt this, a 1-minute program would take 5 hours to execute.

The second plague, not knowing from whence you came, was cured with PROBE'S real-time trace memory. The history of program execution is saved on-board. In real time. Once a hardware trap has occurred,



### FREE 44-PAGE BUGBUSTING BIBLE COULD MAKE YOU A PROPHET, AND YOUR COMPANY A PROFIT.

We've written a complete tutorial on state-of-the-art bugbusting. And it's yours, free for the asking. Full of examples and illustrations, it will show you how the wizards work their magic.

If you're tired of suffering the wrath of program bugs, call Atron today. You could be busting bugs, and sales records, tomorrow.



20665 Fourth Street • Saratoga, CA 95070 • 408/741-5900

# LANGUAGES THAT ARE CAUSING THE BIGGEST PROGRAMMING BACKLOG IN HISTORY ARE ALSO EATING NICE BIG HOLES IN OUR POCKETS.

Whether it's BASIC, COBOL, Pascal, "C", or a data base manager, you're being held back.

Held back because the language has frustrating limitations, and the programming environment isn't intuitive enough to keep track of what you're working on.

In the real world, there's pressure to do more impressive work, in less time, and for more clients.

We've been given some incredibly powerful hardware in recent times, but the languages aren't a whole lot better than they were 20 years ago.

So, whatever language you have chosen, by now you feel it's out to get you — because it is.

Sure, no language is perfect, but you have to wonder, "Am I getting all I deserve?"

And, like money, you'll never have enough.

Pretty dismal, huh?

We thought so, too.

So we did something about it.

We call it CLARION™

You'll call it "incredible."

Distributed on 7 diskettes, CLARION consists of over 200,000 lines of code, taking 3+ years to hone to "world-class" performance.

With CLARION you can write, compile, run and debug complex applications in a New York afternoon.

Even if you're in Savannah.

It gives you the power and speed to create screens, windows and reports of such richness and clarity you would never attempt them with any other language.

Because you would have to write the code.

With CLARION you simply design the screens using our SCREENER utility and then CLARION writes the source code AND compiles it for you in seconds.

Likewise, you can use REPORTER to create reports.

Remember, only CLARION can recompile and display a screen or report layout for modification.

And with no time wasted.

All the power and facilities you need to write great programs, faster than you ever dreamed of.

Programs that are easy to use. Programs that are a pleasure to write.

And to you that means true satisfaction.

You've coveted those nifty pop-up help windows some major applications feature. But you can't afford the time and energy it takes to write them into your programs.

That's the way it used to be.

So we fixed that, too.

CLARION's HELPER is an interactive utility that let's you design the most effective pop-up help screens that you can imagine. And they're "context sensitive," meaning you can have help for every field in your application.

Unlike the other micro languages, CLARION provides declarations, procedures, and functions to process

dates, strings, screens, reports, indexed files, DOS files and memory tables.

Imagine making source program changes with the CLARION EDITOR. A single keystroke terminates the EDITOR, loads the COMPILER, compiles the program, loads the PROCESSOR and executes the program. It's that easy!

Our data management capabilities are phenomenal. CLARION files permit any number of composite keys which are updated dynamically.

A file may have as many keys as it needs. Each key may be composed of any fields in any order. And key files are updated whenever the value of the key changes.

Like SCREENER and REPORTER, CLARION's FILER utility also has a piece of the CLARION COMPILER. To create a new file, you name the Source Module. Then you name the Statement Label of a file structure within it.

FILER will also automatically rebuild existing files to match a changed file structure. It creates a new record for every existing record, copying the existing fields and initializing new ones.

Sounds pretty complicated, huh?

Not with CLARION's documentation and on-line help screens. If you are currently competent in BASIC, Pascal or "C" you can be writing CLARION applications in a day. In two days you won't believe the eloquence of your CLARION programs.

Okay, now for the best part of all. You can say it in CLARION for \$295.00—plus shipping and handling. All you need is an IBM® PC, XT, AT or true compatible, with 320 KB of memory, a hard disk drive, and a parallel port. And we'll allow a full 30 day evaluation period. If you're not satisfied with CLARION, simply return it in its original condition for a full refund.

If you're not quite ready to take advantage of this no-risk opportunity, ask for our detailed 16 page color brochure. It vividly illustrates the elegance of CLARION. Consider it a preview of programming in the fast lane.

Either way, the 800 call's a freebie.



SAY IT IN

## CLARION™

DEPT. A2BY/4

# 1-800-354-5444



**BARRINGTON SYSTEMS, INC. 150 EAST SAMPLE ROAD POMPANO BEACH, FLORIDA 33064 305/785-4555**

IBM is a registered trademark of International Business Machines Corporation. CLARION™ is a trademark of Barrington Systems, Inc. ©1986 Barrington Systems

# OFFICE AUTOMATION

Tech PC, we're out to capture your micro-computer business. No one matches our diverse line of high performance products, or our comprehensive system of support, warranty, and third party maintenance service options. Tech PC is a large Southern California computer design and manufacturing firm with computer research and design specialists, production engineers, technical assistance staff, qualified sales personnel, and a strong management and investment team to provide you with state of the art products, state of the art reliability, and state of the art economy.

## PORTABLES

Tech PC Portable Computers come in four different base models to match your computing needs. Our entry level Tech PC/XT portable computer is designed to provide a non-obstructive profile, and has a capacity to hold two thirty megabyte hard disks, a high resolution monochrome monitor with a Hercules compatible graphics card to drive it with 800 by 400 lines resolution, and never before heard of 6 expansion slots in a portable computer. If 4.77 MHz of Intel 8088 power isn't fast enough, try our Turbo 4.77 to 8 MHz 8088-2 or optional NEC V-2 microprocessor based portable machine. Designed to increase speed up to 170 percent of a standard PC/XT, the Tech PC/AT and Tech Turbo PC/AT portable units are state of the art in portable performance. The 80286 microprocessor based units can be fitted with up to 240 megabytes of high speed voice coil hard disk technology, and with the Turbo AT's 10 MHz math co-processor socket and 10 MHz

80286 microprocessor the unit can manipulate large spreadsheets with unparalleled performance.

## DESKTOPS

Tech PC Desktop Computers are designed for survival. The XT's leave your desktop looking comfortably empty with their slim non-obtrusive profile; The AT's give you a powerful presence with a clean lined sturdy chassis. Combined with a 14 inch, 800 by 400 line amber monochrome monitor or a 14 inch, 1280 by 800 black and white monochrome monitor you've got State of the Art staring straight back at you. If 8 MHz 80286 power isn't fast enough for you... try the Tech Turbo PC/AT with its 10MHz 80286 and 10 MHz 80287 math co-processor socket. The Tech Turbo PC/AT gives you the strongest, most powerful 80286 performance available from anyone, anywhere... available with up to 16 megabytes of memory and hard disks up to 1 gigabyte with our new optical storage disk, the Tech Personal





Computer Desktops represent the cutting edge of desktop microcomputer technology.

**Tech Personal Computers, Inc.** is a full service manufacturer of Micro Computer Products and offers a complete line of Desktop, Portables and Multi-User Computer Systems as well as an accessory line of over one hundred enhancement products. **Tech Personal Computers, Inc.** are all backed by a full one year warranty with additional maintenance coverage and extended maintenance contracts available through Momentum Service Corp. For more information concerning hundreds of MSC Service Centers throughout the United States, contact **Tech Personal Computers, Inc.** at (714) 754-1170.



# OFFICE ON LOCATION

## DESKTOPS

- TECH PC/XT DESKTOP** .....\$ 529  
*Options:*
- Tech PC/XT with 20MB Hard Disk .....\$ 979
- Tech PC/XT with 20MB Hard Disk, Monochrome Monitor, Hercules® Compatible Mono/Graphics Card .....\$1179
- TECH TURBO PC/XT DESKTOP** .....\$ 629  
*Options:*
- Tech Turbo PC/XT Desktop with 20MB Hard Disk .....\$1079
- Tech Turbo PC/XT 20MB Hard Disk, Monochrome Monitor, Hercules® Compatible Mono/Graphics Card .....\$1279
- TECH PC/AT DESKTOP** .....\$1399  
*Options:*
- Tech PC/AT with 20MB Hard Disk .....\$1799
- Tech PC/AT with 20MB Hard Disk, Monochrome Monitor, Hercules® Compatible Mono/Graphics Card .....\$1999
- TECH TURBO PC/AT DESKTOP** .....\$1599  
*Options:*
- Tech Turbo PC/AT Desktop with 20MB Hard Disk .....\$1999
- Tech Turbo PC/AT with 20MB Hard Disk, Monochrome Monitor, Hercules® Compatible Mono/Graphics Card ..\$2199

## PORTABLES

- TECH PC/XT PORTABLE** .....\$ 899  
*Options:*
- Tech Turbo PC/XT Portable with 20 MB Hard Disk ....\$1349
- Tech Turbo PC/XT Portable with 1200 Baud Internal Hayes Compatible Modem and 20 MB Hard Disk .....\$1549

- TECH TURBO PC/XT PORTABLE** .....\$ 999  
*Options:*
- Tech Turbo PC/XT Portable with 20 MB Hard Disk ...\$1449
- Tech Turbo PC/XT Portable with 1200 Baud Internal Hayes Compatible Modem and 20 MB Hard Disk .....\$1649
- TECH PC/AT PORTABLE** .....\$1799  
*Options:*
- Tech PC/XT Portable with 20 MB Hard Disk .....\$2199
- Tech PC/XT Portable with 1200 Baud Internal Hayes Compatible Modem and 20 MB Hard Disk .....\$2399
- TECH TURBO PC/AT PORTABLE** .....\$1999  
*Options:*
- Tech PC/XT Portable with 20 MB Hard Disk .....\$2399
- Tech PC/XT Portable with 1200 Baud Internal Hayes Compatible Modem and 20 MB Hard Disk .....\$2599

All TECH PC PORTABLES available with tape backups, hard disks up to 1 gigabyte, networking systems, and hundreds of other hardware and software accessories.

# TECH PC

**714/754-1170**

**2131 South Hathaway, Santa Ana, California 92705**  
**Telex 272006 Answer Back - TECH FAX: 71415568325**

# MORE USERS FOR YOUR PC

*Advanced Digital's PC-Slave is the solution to your multi-user or local area network problems.*



Just plug Advanced Digital's PC-Slave board into your PC expansion slot, a connecting cable, a low-cost dumb terminal or a PC look-alike terminal and you're in business. As many as 31 low-cost workstations may be added to your IBM-PC, AT, XT, and the compatibles. Share a common data base without loss of speed or efficiency since each PC-Slave has its own 8088 CPU, 256-768K RAM dedicated to each user. Advanced Digital provides additional software which supports File & Record locking and print spooling. Advanced Digital's slave concept provides the best multi-user PC system available today! For the location of the dealer nearest you contact:

**Advanced Digital Corporation**  
5432 Production Drive  
Huntington Beach, CA 92649  
(714) 891-4004 / (800) 251-1801  
Telex 183210 ADVANCED HTBH

**ADVANCED  
DIGITAL  
CORPORATION**

**Advanced Digital U.K. Ltd.**  
27 Princes Street, Hanover Square  
London W1R8NQ-United Kingdom  
(01) 409-0077 (01) 409-3351  
TLX 265840 FINEST

Regional Distributors: In California, Thomas Data Systems, Inc. (213) 214-4661, MP Systems (714) 770-6411; In Texas, MP Systems (214) 385-8885 or (800) 854-8885; In Ontario, Canada, Computer Lab (416) 298-7680; In Australia, Archives Computers (03) 699-8377; In Florida, International Micro Systems (305) 665-1515

Inquiry 5 for End-Users. Inquiry 6 for DEALERS ONLY.

## Turbo Chassis for Amiga

Computer Systems Associates has released the Turbo Chassis, an expansion unit that adds a 32-bit 68020 microprocessor and 68881 floating-point coprocessor to the Commodore Amiga. Installed with the 68881 on a coprocessor board in the chassis, the 68020 runs at 14.28 MHz, twice the frequency of the Amiga's standard 68000 processor. The coprocessor board also provides 32-bit data and address buses, as well as 32-bit DMA operation. According to the company, the 68020 and 68881 are fully supported by AmigaDOS.

The Turbo Chassis attaches to the Amiga via a 100-pin expansion bus. In addition to the coprocessor board, the unit is equipped with a 512K-byte, 32-bit static RAM board, a 20-megabyte hard disk drive with an SCSI controller, and a power supply; a 40-megabyte hard disk is optional. The unit's two remaining expansion slots can accommodate additional boards from CSA or from other manufacturers.

With the coprocessor board, memory board, and 20-megabyte hard disk drive, the Turbo Chassis sells for \$5475. You can also purchase the components separately or with an Amiga and color monitor. For more information, contact Computer System Associates, 7564 Trade St., San Diego, CA 92121, (619) 566-3911. Inquiry 550.



The Amiga Turbo Chassis, with 68020 and 68881 processors.

## Smalltalk-based Expert System Shell

Humble, a set of tools from Xerox for building expert systems, functions in the Smalltalk-80 environment. It's primarily a goal-directed expert system shell to which you can add rules and data definitions, from a browser window, to create systems for specific problems. You can also alter the certainty model. The rule language contains an "escape" to standard Smalltalk-80 code.

The program, which can deal with several hypotheses simultaneously, is capable of both backward and forward chaining. The former is automatic during execution; the latter can be specified at any time during rule execution. Because Humble supports multiple execution contexts, the same rules can be applied to several similar objects within a knowledge base. Any Smalltalk-80 application can interface to Humble knowledge bases.

Humble runs in Smalltalk-80 systems based on

any licensed virtual image. It needs at least 200K bytes of memory after the Smalltalk image is loaded. A site license is \$1500; per-machine price is \$500. The package comes with source code for the shell and supporting windows. Contact Xerox Special Information Systems, 250 North Halstead St., P.O. Box 7018, Pasadena, CA 91109, (818) 351-2351. Inquiry 551.

## Spreadsheet-style Signal-Analysis Software

DSP Systems has developed technical-worksheet software that provides a spreadsheet-like environment for displaying and analyzing digital waveforms. DADiSP Worksheet has 150 data manipulation and analysis functions, including signal editing, signal arithmetic and calculus, waveform generation, FFTs, statistical analysis, and peak finding. You can also build other functions

with macros.

You set up signal-processing steps by typing formulas into a window. The menu-driven program evaluates and displays the results of each step. Worksheets can be saved and used to build analysis templates.

DADiSP Worksheet supports real and complex arithmetic and carries engineering units through compound calculations. It can detect an 8087, supports various file formats, and has command files for automating data analysis. The program runs on the IBM PC series and compatibles with an EGA, IBM CGA, or Hercules graphics adapter. The package price of \$795 includes six months of updates and support. A demo disk is \$20. Contact DSP Systems, One Kendall Square, Cambridge, MA 02139, (617) 577-1133. Inquiry 552.

## Amiga Organizer

Order, a desktop organizer for Commodore's Amiga, uses the machine's multitasking, voice, graphics, sound, menu, and window capabilities. The package bundles a telephone directory that doubles as a mailing list and label printer; a talking alarm clock; a perpetual calendar; an appointment book; a screen dumper; and Doodler, a scratch pad for graphing and sketching. The software also contains a 37-function scientific calculator, which can print a tape of computations.

Retail price is \$44.95. Con-

(continued)

tact the Northeast Software Group at ICS, 165 Dyerville Ave., Johnston, RI 02919, (401) 273-1001. Inquiry 553.

## Scientific Sourcebook

**A**dvanced Scientific Analysis & Graphics is a sourcebook of techniques written in IBM PC BASICA. The 48 source code applications, which can be run alone or as modules in custom programs, are designed primarily for people involved in math, physics, and engineering. The programs on the disk are also listed in a handbook.

The sourcebook is broken down into four categories: graphics techniques, including programs for 3D surface plotting, contouring, and charting; imaging and transforms, including programs for FFTs, fractal structures, convolution, image enhancement, and optical ray tracing; probability and statistics, with programs for probability distributions, confidence bounds, Monte Carlo radiative transfer, and regression; and matrix operations, covering 3D perspective projections, symbolic multiplication, determinants, inversion, simultaneous equations, and eigenvalues and eigenvectors.

The package sells for \$60. For more information, contact Simplification UnLtd., P.O. Box 654, Menlo Park, CA 94026, (415) 859-4244. Inquiry 554.

## Hard Disk Cards with up to 60 Megabytes

**E**xpress Systems introduced a series of Hard DiskCards for IBM PCs, ATs, and compatibles that range in capacity from 20 to 60 megabytes. The 40- and 60-megabyte cards, called

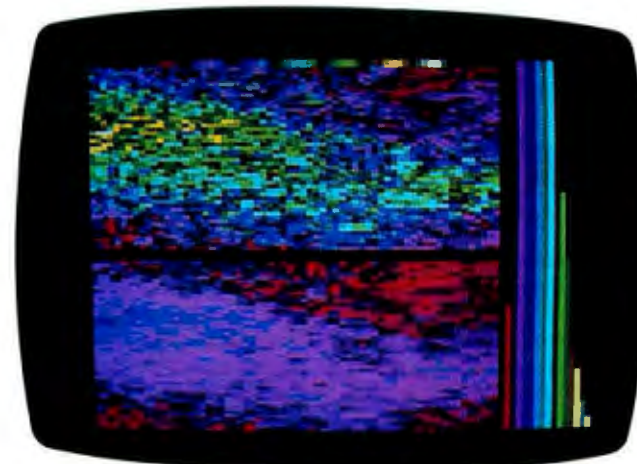
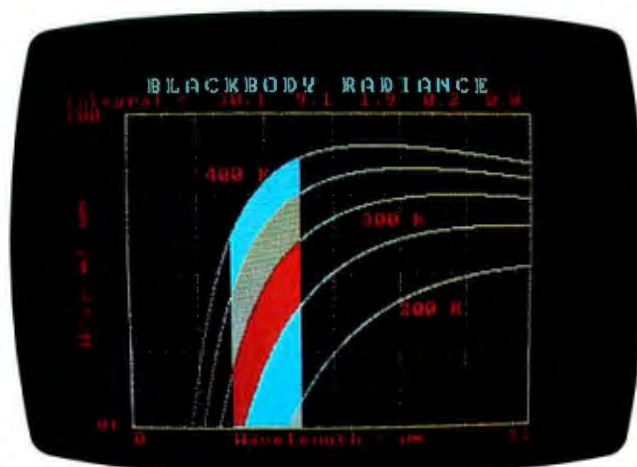

A plot (top) and a pseudocolor image generated with code from Simplification's sourcebook.

the Express Double DiskCards, require two expansion slots; all others require one and a half slots.

The 20-megabyte AT Backup DiskCard for the IBM PC AT (\$449) comes with backup utilities and software that compresses binary, text, and database files by 30 to 90 percent of the original size. The drive performs file-by-file backup at the rate of 3 megabytes per minute. The Express Double DiskCards come with two hard disks. One disk can back up the other with the firm's automatic backup software, or the drives can be made to work as one with the

company's Coalesce software.

In addition, the Coalesce software (\$95) permits you to combine any Express Hard DiskCard with an existing hard disk and have both disks act as one. The software can also divide a single drive into multiple units and lets you bypass the DOS file limitation of 32 megabytes.

The 20-megabyte Hard DiskCard sells for \$595 or \$495, with access speeds of 60 or 80 milliseconds, respectively. The 30-megabyte cards with 80- and 60-ms access speeds sell for \$695 and \$795. The 40-megabyte card (80 ms only) costs \$995; the 60-megabyte card (60 ms only) costs

\$1095. For more information, contact Express Systems Inc., 1254 Remington Rd., Schaumburg, IL 60195, (800) 341-7549, ext. 3600; in Illinois, (312) 882-7733, ext. 3600. Inquiry 555.

## TI Graphics Design Kit

**T**exas Instruments is offering the TMS340 Graphics Design Kit for designing bit-mapped graphics systems. The \$99 kit contains samples of components likely to be used in a graphics system, including the TMS4161 64K by 4 video RAM, the TMS34061 video system controller, and the TMS34070 color palette chip.

Other components include a 4-bit bidirectional universal shift register and a 68-pin plastic leaded chip carrier socket for the video system controller. Also packaged with the kit are user's guides, data sheets, and applications information. For more information, contact Texas Instruments Inc., Semiconductor Group (SC-618), P.O. Box 809066, Dallas, TX 75380-9066, (800) 232-3200, ext. 700. Inquiry 556.

## 80386 Development Tool

**A**merican Computer & Peripheral has announced a software development tool to help programmers adapt to the 80386 microprocessor environment. The 386 Translator plugs into an 80286 PGA (pin grid array) socket in an IBM PC AT or compatible computer and transforms the system into an 80386 environment.

The 386 Translator costs \$395 without an 80386 chip

(continued)

# "ATTENTION!"

Now  
there's  
a true  
value-added  
IBM®  
compatible!

General Technologies, an affiliate of one of America's leading electronic parts manufacturers and distributors, has designed three outstanding personal computers with full IBM® compatibility:

■ **GENERAL AT:**

A fast, powerful, dual-speed (8/6 MHz) computer with an 80286 CPU. Perfect as a file server.

■ **GENERAL TURBO:** A high-speed PC. Zero wait state. 70% faster than a standard PC/XT®. Rated by Norton Utility.

■ **GENERAL PC:** The perfect inexpensive personal computer for your home and office.

RUNS ALL MAJOR SOFTWARE WRITTEN FOR IBM® PC, PC/XT® AND AT®.

ALL PACKAGED WITH FREE INTEGRATED BUSINESS SOFTWARE!

180-DAY FULL WARRANTY, INCLUDING PARTS AND LABOR.

FREE 60-DAY ON-SITE SERVICE IN OVER 100 CITIES NATIONWIDE.

Get more computer for a lot less money by calling toll-free 1-800-426-1242 for our professional dealer nearest you. Snap to it and snap up a real value with GENERAL!

IBM, AT and PC/XT are registered trademarks of International Business Machines Corporation.



**GENERAL**  
Technologies, Inc.

Bloomfield, New Jersey 07003

Twx: 710-994-4780 • Fax: 201-429-8683

FOR WARRANTY SERVICE DIRECTORY CALL 1-800-262-6772  
FOR SOFTWARE/HARDWARE SUPPORT CALL 1-201-429-0053

Inquiry 140

**DEALER INQUIRIES INVITED**

or \$895 with an 80386. Intel offers PLM compilers, assemblers, and other MS-DOS software for 80386 program development. For more information, contact American Computer & Peripheral Inc., 2720 South Croddy Way, Santa Ana, CA 92704, (714) 545-2004. Inquiry 557.

### PC-compatible Laptop from STM Electronics

**S**TM Electronics announced the STM Laptop, an IBM PC-compatible portable computer that can be equipped with an expansion unit called the LapMate. The LapMate, which connects to the computer through an interface on the back of the system unit, provides additional disk drives and other expansion options.

The computer runs on a 4.77-MHz 80C88 processor and can accommodate an 8087 math coprocessor. Priced at \$2999, the standard model comes with 256K bytes of RAM (expandable to 640K) and an internal 720K-byte 3½-inch floppy disk drive.

Two display options are available. The electroluminescent display provides a resolution of 80 columns by 25 lines in text mode and 640 by 200 pixels in graphics mode. The backlit LCD screen offers the same text and graphics resolution. The Laptop also supports a PC-compatible color graphics adapter and includes as standard a parallel and serial port and a mouse port.

A ROM cartridge interface on the computer's back-panel accepts ROM cartridges available from STM or other manufacturers. A ROM cartridge without the ROM is priced at \$39, and a cartridge with 128K bytes of EPROM sells for \$115. The company also offers two op-



The STM Laptop connects to the LapMate expansion unit.

tional ROM sockets for installing up to 256K bytes of applications software.

Among the other options are 384K bytes of internal bubble memory (\$649), an internal 300/1200-bps modem (\$299), two nickel-cadmium battery packs that power the unit for two hours (\$149) or four hours (\$249), a battery pack recharger/adaptor (\$19.50), and an AC adapter/charger (\$149).

With a base price of \$549, the LapMate unit contains a 5¼-inch and a 3½-inch floppy disk drive; a hard disk drive is optional. The unit also contains a half-length expansion slot that will accept an RGB adapter (\$209) and has interfaces for an external PC-compatible keyboard, an external monitor, and a connector for additional expansion boxes. According to the company, the computer should be available this month. For more information, contact STM Electronics Corp., 444 Castro St., Mountain View, CA 94041, (415) 968-1790. Inquiry 558.

### Atari ST Development System

**T**he Nexus EPROM Development System for the Atari ST consists of

software and a 16-bit external EPROM programmer/simulator that plugs into the ST's cartridge port. The device enables you to program EPROMs of 8K and above and supports data transfer to and from the serial port and disk files in binary, hex-space and Motorola and Intel hex formats.

The unit has two sockets for programming and reading EPROMs, 64K bytes of CMOS simulator RAM, an external simulation socket, and a socket for further expansion. Internal (cartridge) simulation enables the unit's 64K of RAM to be treated as if it were 64K of EPROM. During external simulation, the ST is free for processing other tasks.

The system's software uses the GEM interface and provides windows for displaying RAM or EPROM contents. Its data manipulation features include edit, locate a value, block move, fill/clear RAM, calculate checksums, check for blank and programmable EPROMs, and verify EPROM against RAM.

The development system sells for £175. For more information, contact Nexus Technical Services Ltd., 38 Melrose Ave., Reading, Berkshire RG6 2BN, U.K., tel: (0734) 664559. Inquiry 559.

### 3D Modeling Package for Mac

**P**hoenix 3D is a set of Macintosh tools for creating and viewing three-dimensional models. You can design models from all sides, using the mouse to rotate, twist, stretch, bend, explode, and shrink or enlarge the image. You can then view the drawing from any angle. Drawing tools let you remove hidden lines, shade with 64 levels of gray, smooth facets, and filter the resulting image. Drawings can be saved as MacPaint documents. With a conversion utility supplied on the disk, you can import models from other programs.

Models can have as many as 1200 polygons (with as many as 22 sides), spheres, cones, prisms, and surfaces of revolution. The package provides 55 methods of rendering algorithms for building wireframe, hidden-line, flat-shaded, or smooth-shaded models.

The program runs on the 512K Mac, Mac Plus, and Mac XL; supports HFS, Switcher, and Servant; and works with the Imagewriter and LaserWriter. Phoenix 3D costs \$39.95. Contact Dreams of the Phoenix Inc., P.O. Box 10273, Jacksonville, FL 32247, (904) 396-6952. Inquiry 560.

### Apple-based System for Handicapped

**P**oint to Pictures is a software/hardware system for persons with IQ levels of 20 to 80 or developmental ages of 6 months to 5 years. R. J. Cooper & Associates says it designed its package, based on research at a school for low-functioning 3- to 22-year-olds, to fulfill three goals: increase educational productivity, stimulate spontaneous

(continued)

# GET SERIOUS



## ...ABOUT ANALYZING YOUR DATA.

You might be spreading your spreadsheet a little too thin. Or maybe you're starting from scratch. But if you're serious about data analysis, you're ready for SPSS/PC+™ — a full software family that brings you six high-powered ways to complete any data analysis task.

*Enter it.* SPSS/PC+ Data Entry™ takes the effort out of entering and correcting data.

*Analyze it.* The SPSS/PC+ Base Package provides a powerful array of statistical and reporting procedures.

*Examine it.* SPSS/PC+ Advanced Statistics™ lets you get more serious with your data.

*Table it.* SPSS/PC+ Tables™ produces presentation-ready tables instantly.

*Chart it.* SPSS/PC+ Graphics™ featuring Microsoft® Chart creates show-stopping graphs and charts.

*Map it.* SPSS/PC+ Mapping™ featuring MAP-MASTER™ — our latest option — creates maps where vast amounts of data can be summarized and presented in one, simple picture.

SPSS/PC+ products are being put to productive use by serious fact finders in business, government and education. For countless purposes such as market research. Wage and salary studies. Survey analysis. And quality control. Plus each product is superbly documented and supported by SPSS Inc., a leader in statistical software for nearly 20 years.

So if you're serious about data analysis, step up to SPSS/PC+. For details, contact our Marketing Department.

**CALL 1/312/329-3630**

**SPSS inc.**

SPSS Inc. • 444 North Michigan Avenue, Suite 3000 • Chicago, Illinois 60611

In Europe: SPSS Europe B.V. • P.O. Box 115 • 4200 AC Gorinchem, The Netherlands • Telephone: +31183036711 • TWX: 21019

SPSS/PC+ runs on IBM PC/XT/AT's with hard disk. Contact SPSS Inc. for compatible microcomputers. SPSS/PC+, SPSS/PC+ Data Entry, SPSS/PC+ Advanced Statistics, SPSS/PC+ Tables, SPSS/PC+ Graphics and SPSS/PC+ Mapping are trademarks of SPSS Inc. for its proprietary computer software. Chart and Microsoft are trademarks of Microsoft Corporation. MAP-MASTER is a trademark of Decision Resources. © 1986, SPSS Inc.

speech, and help with early acquisition of augmentative communication skills.

PTP uses a large graphics tablet (the Power Pad) with large pictures on its surface to allow low-functioning individuals to interact with the Apple IIe. The system employs graphic and verbal prompts (using the Echo+ speech synthesizer). An interface that hooks to the game port controls two switch-modified toys, which can correlate to pictures on the Power Pad.

Several configurations are available. Software prices range from \$49.95 to \$199.95. The Power Pad and the Echo+ sell for \$150 each. For more information, contact R. J. Cooper & Associates, 2144 South 1100 E, Suite 150, Salt Lake City, UT 84106, (801) 263-1388. **Inquiry 561.**

### MacBus Holds PC Add-on Boards

**D**esigned for laboratory, instrumentation, and test and measurement applications, National Instruments' MacBus expansion unit provides a Macintosh Plus with a means of using IBM-compatible expansion cards.

The MacBus unit has five 16-bit PC AT expansion slots, two of which are occupied by a microcomputer card and an SCSI card that provides the communications link to the Mac. The three remaining slots can accommodate A/D converters, digital I/O, serial communication links, video frame grabbers, and other boards compatible with the IBM PC or PC AT.

Data acquisition and instrument control are performed by National Instruments' GPIB-V50 microcomputer card, which contains an 8-MHz, 16-bit microprocessor, circuits that control



The Kurzweil Voiceterminal acts as a terminal or stand-alone PC.

the AT-compatible bus, and an IEEE-488 interface. The card can also hold an optional 8-MHz math coprocessor. The operating system, contained in EPROM on the card, is a version of the company's IBCL (Instrument Bus Control Language), which provides commands for controlling GPIB instruments and a program development language.

The system's software includes an IEEE-488 bus control and configuration utilities and a driver for the MacBus hardware. Language interface libraries provide access to the IEEE-488 driver and the MacBus hardware from user-developed programs written in C and BASIC.

List price for the hardware is \$1495; for the software, \$200. Contact National Instruments Corp., 12109 Technology Blvd., Austin, TX 78727-6204, (800) 531-4742; in Texas, (800) 433-3488. **Inquiry 562.**

### Kurzweil's Voiceterminal

**K**urzweil Applied Intelligence introduced the Kurzweil Voiceterminal (KVT), a 1000-word intelligent terminal that enables you to use spoken words and phrases to control, enter data into, and retrieve data from mainframes and minicomputers. The terminal emulates ASCII or IBM 3270 terminals and also functions as a stand-alone computer that can run most IBM PC-compatible software.

Each Kurzweil Voiceterminal consists of an IBM PC XT-compatible computer with embedded voice recognition, a 10-megabyte hard disk drive, and a 360K-byte floppy disk drive. The system is also equipped with a monochrome display, two serial ports, and one parallel port.

The KVT connects to host systems via a hard-wired serial communications line or a modem. The system automatically translates voice commands and data

into keyboard inputs; no modification to host applications is required. Multiple users can train the terminal to recognize their voices and tailor the vocabulary for particular applications. The company also offers predefined command sets for mainframe applications.

In a stand-alone configuration, the Voiceterminal costs \$9500; with ASCII emulation, \$9900; and with IBM 3270 emulation, \$10,900. Contact Kurzweil Applied Intelligence, 411 Waverley Oaks Rd., Waltham, MA 02154, (617) 893-5151. **Inquiry 563.**

### Tallgrass File Servers

**T**allgrass Technologies introduced two file server products that support a variety of local area network configurations and communications options. Both products use the VINES virtual networking software developed by Banyan Systems.

The TG-8000 is a 32-bit desktop network file server that provides wide-area networking, host access, server-to-server communications, and resource sharing for small networks. The TG-8000AT is a software-only version that enables an IBM PC AT or compatible to function as a network server.

Prices for the TG-8000 begin at \$8495 for a configuration that includes 1 megabyte of RAM, a 50-megabyte hard disk, and 60-megabyte tape backup. The VINES software costs \$1895. The TG-8000AT software, which is scheduled to ship in October, will also sell for \$1895. Contact Tallgrass Technologies Corp., 11100 West 82nd St., Overland Park, KS 66214, (913) 492-6002. **Inquiry 564.**

(continued)





Clipper is the fastest dBase III and dBase III Plus™ compiler available. Nothing else comes close. When performance counts, experts rely on Clipper for more speed, more power, and more creative freedom. You can, too. Call for details.

- *Clipper compiled programs run 2 to 20 times faster.*
- *No royalties...no runtime fees.*
- *Source code security.*
- *User defined functions.*
- *Arrays.*
- *Simple menu commands.*
- *Context sensitive help can be included with programs.*
- *More fields; more memory variables.*
- *Call C and Assembly programs.*
- *Complete debugging facilities.*
- *Multiple file relationships.*
- *IBM PC, XT, AT, 3270 compatible™.*
- *Multi-user capability.*

*Clipper*™

CLIPPER. THE dBASE COMPILER.  
A WINNING PERFORMANCE EVERY TIME.



**nantucket**™

Nantucket Corporation  
5995 South Sepulveda Boulevard  
Culver City, California 90230  
(213) 390-7923  
Outside California call toll-free:  
1-800-251-8438

dBase, dBase III, and dBase III Plus are trademarks of Ashton-Tate, Inc.  
IBM PC, XT, AT, and 3270 are trademarks of International Business Machines Corporation.  
Clipper and Nantucket are trademarks of Nantucket Corporation.

## SYSTEMS

**AT Compatible  
from Wyse**

**W**yse Technology announced the WYSEpc 286, an IBM PC AT-compatible computer that operates at 10 and 6 MHz. The computer offers up to 81.2 megabytes of disk storage, several display options, and a standard PC AT keyboard or an IBM Enhanced Personal Computer keyboard.

Standard features include 640K bytes of RAM, eight full-size PC AT expansion slots, a real-time clock with battery backup, an RS-232C serial port, and a parallel port. Also included as standard are MS-DOS 3.1 and GW-BASIC 3.1. The computer can be configured with a 1.2-megabyte half-height floppy disk drive, a 20-megabyte half-height hard disk drive, and a 40-megabyte full-height hard disk drive.

The company is also offering three monitors and two graphics adapter boards, all of which are PC-compatible, for use with the WYSEpc 286. The 14-inch monitors include the WY-530 monochrome monitor (\$235), WY-630 color graphics monitor (\$599) with 640 by 200 resolution, and WY-640 EGA-compatible monitor (\$749) with 640 by 350 or 640 by 200 resolution. The WY-430 graphics board (\$299) is compatible with the Hercules graphics adapter, IBM Color Graphics Adapter, and Plantronics display adapter. The WY-440 graphics board (\$499) provides compatibility with IBM's Enhanced Graphics Adapter.

The computer can also be connected to Wyse terminals for use as a multiuser system. With a 1.2-megabyte floppy drive, the system sells for \$2499; with a 20-megabyte hard drive, \$2999; and



*Zenith's Z-181, an IBM PC compatible with 640K bytes of RAM.*

with a 40-megabyte hard drive, \$4199. Contact Wyse Technology, 3571 North St., San Jose, CA 95134, (408) 433-1000. Inquiry 565.

**Two VMEbus  
Single-Board Systems**

**F**orce Computers' CPU-6 series of VMEbus boards is based on 68000 or 68010 processors and supports floating-point operations. The CPU-6 series offers 512K bytes of dedicated on-board DRAM permitting zero-wait-state operation at 8 MHz and one-wait-state operation at 12.5 MHz. A 68881 coprocessor at 8 or 12.5 MHz is optional.

Four 28-pin JEDEC sockets accommodate 27512 EPROMs for up to 256K bytes of user and system program area or 8-bit-wide SRAM devices. Three RS-232C serial ports and one parallel port are also incorporated. Other standard features include a real-time clock with battery

backup and a 16K-byte monitor including a one-line assembler/disassembler.

The base board sells for \$1845. Contact Force Computers Inc., 727 University Ave., Los Gatos, CA 95030, (408) 354-3410. Inquiry 566.

**M**otorola introduced a 32-bit VMEbus-compatible board (Model MVME133) that incorporates a 12.5-MHz 68020, a 68881 floating-point coprocessor, and 1 megabyte of DRAM. A 16.67-MHz version (Model MVME133-1) is also available.

Among the other features of the single-board computer are a serial debug port and two RS-232C multi-protocol serial ports, three 8-bit timers, a real-time clock, and an A24/D32 VMEbus master interface with system controller capabilities.

With a 12.5-MHz processor, the board costs \$1995. Contact Motorola Semiconductor Products Inc., P.O. Box 20912, Phoenix, AZ 85036, (602) 438-3501. Inquiry 567.

**Zenith's Z-181  
Laptop Computer**

**Z**enith introduced the Z-181, an IBM PC-compatible laptop computer priced at \$2399. Like the IBM PC Convertible, the Zenith machine uses a 4.77-MHz CMOS 8088 processor and features two 3½-inch floppy disk drives capable of storing 720K bytes of data each. Unlike the Convertible, the Z-181 is completely compatible with the ROM BIOS in the IBM PC, according to Zenith.

The Z-181's fold-up LCD screen uses what the company calls supertwisted birefringent crystals with electroluminescent backlighting to attain a claimed contrast ratio of 12 to 1. (Zenith claims that a standard monochrome CRT has a contrast ratio of 3 to 1.) In addition, the screen can display true shades of gray and has both brightness and contrast controls.

The 11.8-pound computer comes standard with 640K bytes of memory, connectors for RGB and composite monochrome monitors, and serial and parallel interfaces. The portable also comes with MS-DOS 3.2 (a BASIC interpreter is optional), a real-time clock, a nickel-cadmium battery that powers the unit for up to five hours, an AC charger, a socket for an 8087 math coprocessor, and a set of "desktop" software packages. Options include a 5¼-inch battery-powered disk drive, a 300/1200-bps internal modem, and an interface for a bar code reader.

For more information, contact Zenith Data Systems, 1000 Milwaukee Ave., Glenview, IL 60025, (800) 842-9000; in Illinois, (312) 391-8949. Inquiry 568.

*(continued)*

# Princeton is the best choice in PC monitors.

When you're looking for a personal computer monitor, look at Princeton Graphic Systems. Our growing family of high quality personal computer monitors delivers compatibility, brilliant colors, high resolution, and dependability. Whether you're designing sophisti-

cated business graphics or number-crunching a financial spreadsheet. That's why Princeton is number one in the minds of more

and more personal computer owners every year.

For the very best in PC monitors, the choice is clear: Pick the company that's at the top. Princeton Graphic Systems.



**HX-12E.** Our EGA-compatible monitor gives you 64 vivid colors. Extra sharp text and graphic displays. The finest dot pitch (.28mm) of any IBM-compatible enhanced monitor. Nonglare screen. Fully compatible with IBM's™ Enhanced Graphics Adapter (or equivalents).



**SR-12P.** Top-of-the-line analog color monitor features ultra high resolution (640 x 480), 4,096 colors for superb graphics. The finest dot pitch (.26mm) of any PGC-compatible monitor. Laminated nonglare panel.



**HX-12.** High resolution RGB color monitor with .31mm dot pitch gives you better graphics, better text than IBM's Color Monitor (5153). Nonglare screen. Voted "Best in the World" two years running in *PC World's* "World Class PC Contest".

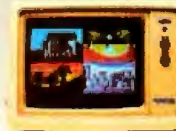

**SR-12.** Super high resolution RGB monitor with a .31mm dot pitch. Compatible with Sigma Designs Color 400 board and others. Gives you 400 lines of resolution. Nonglare screen.



**MAX-12.** High resolution amber monitor. When used with an IBM-compatible monochrome adapter delivers 720 x 350 resolution. With an IBM-compatible color adapter, 640 x 200 resolution with 15 shades of amber. The monitor automatically adjusts to either card.



**HX-9/HX-9E.** Compact nine-inch high resolution RGB monitor. Perfect for workstations where space is at a premium. Both feature a .28 dot pitch and an etched dark glass screen. Ergonomic features like a built-in tilt/swivel base, nonglare screen, and a built-in green/amber switch. HX-9E is compatible with IBM's EGA (or equivalents).

All monitors come with free data and power cables.

Visit your local computer store today and ask about our full line of high resolution color and monochrome monitors. Monitors that live up to the Princeton Graphic Systems tradition of quality, performance, and value.

Princeton Graphic Systems, 601 Ewing Street, Bldg. A, Princeton, NJ 08540; (609) 683-1660; TLX 821402PGSPRIN; (800) 221-1490, ext. 1104.

IBM is a trademark of International Business Machines, Inc. Color 400 is a trademark of Sigma Designs, Inc. QuadEGA+ is a trademark of Quadram Corp. Compaq is a trademark of Compaq Computer Corp.

## PRINCETON®

GRAPHIC SYSTEMS  
AN INTELLIGENT SYSTEMS COMPANY

## PERIPHERALS

**Line Printer for PCs**

The Personal Line Printer from Printronix is designed for use with IBM PCs, XT's, AT's, and compatibles. The printer, which produces an entire line of dots at one time, operates in draft mode at 134 lines per minute and in near-letter-quality mode (with a character matrix of 18 by 35 dots) at 47 lines per minute. The printer is also capable of producing IBM block graphics characters and bit-map graphics at a resolution of 60, 120, or 240 dots per inch. Plug-in cartridges enable the printer to emulate the IBM Proprinter, Epson LQ-1500, and Diablo 630. A choice of downloadable fonts is also available.

The printer comes with a Centronics parallel interface and 2K-byte buffer. List price is \$795, which includes a tractor and friction feed and two font/personality modules. Additional font cartridges cost \$40 each. Contact Printronix, 17500 Cartwright Rd., P.O. Box 19559, Irvine, CA 92713, (800) 826-3874; in California, (800) 826-7559 or (714) 863-1900. Inquiry 569.

**300- to 9600-bps Modem**

Fastcomm Data introduced a modem that transmits data at 300, 1200, 2400, and 9600 bps. The Fastcomm modem enables you to connect with another computer at lower speed, then switch to 9600 bps for downloading files.

Available in internal (\$979), external (\$999), and rack-mount (\$979) models, the modem offers auto-dial/auto-answer capabilities and nonvolatile memory for storing communication parameters. The modem supports

a superset of the Hayes AT command set, as well as the Bell 212A and CCITT V.22bis and V.29 standards. Contact EVI/Fastcomm Data Corp., 12347-E Sunrise Valley Dr., Reston, VA 22091, (703) 620-3900. Inquiry 570.

**Mitsubishi's Low-Cost Digitizer**

The Grafnet Model-01 from Mitsubishi is a standard page-size digitizer with an active area 8.3 inches by 11.8 inches. Priced at \$395, the tablet comes with a pen or an optional four-button puck.

The digitizer operates at up to 60 points per second; its resolution is 0.1 mm or 250 lines per inch. It features a DIP-switch-selectable range of output data formats that, the company says, makes it compatible with any computer input protocol. The tablet works with AutoCAD, P-CAD, PC-Paint, and other standard software packages.

A power supply is bundled with the tablet; a 6-foot RS-232C connecting cable is optional. Contact Mitsubishi International Corp., 520 Madison Ave., New York, NY 10022, (212) 605-2607. Inquiry 571.

**High-Resolution Display for Macintosh**

MicroGraphic Images is offering MegaScreen, a graphics display interface for the Macintosh that provides a resolution of 1024 by 1024 pixels. The \$1495 board includes 128K bytes of memory and fits inside the computer.

According to the company, the board can be modified to work with any monitor,

including a video projector, an IBM monochrome monitor, a television, or a VCR at low resolution. For an additional \$1500, MicroGraphic offers a 20-inch monitor with a resolution of 1024 by 980 that is said to be the same as the one offered with Sun computers.

The company claims that almost all Macintosh software that uses a "grow bar" can be grown to cover the entire high-resolution screen. By the end of the year, the company expects to have an option available for the interface that will let users connect a video camera and do fast digitization. Contact MicroGraphic Images Corp., 20954 Osborne St., Canoga Park, CA 91304, (818) 407-0571. Inquiry 572.

**Teleswitch Gives You Access to Remote PC**

Teleswitch, a power-control device that can be activated through a remote phone or modem, enables a password-authorized caller to turn on a personal computer and peripherals at any time and from anywhere. The device keeps the system's power on for as long as the caller stays on-line. A time-delay circuit turns the power off five minutes after the caller disconnects the line.

To power a computer up, you dial the number, hang up the phone when the system answers, and then redial after about a minute or a sufficient interval to allow the computer to boot up. Redial and password validation must be completed within five minutes; otherwise, the device automatically turns the computer's power off.

The unit also features voltage spike and surge suppression for all devices

plugged into its four power outlets. The device complements pcAnywhere, a remote-access communications program developed by Dynamic Microprocessor Associates that runs on IBM PCs. Suggested retail price for Teleswitch is \$229. Contact EKD Computer Sales and Supply Corp., 764 Middle Country Rd., Selden, NY 11784, (516) 736-0500. Inquiry 573.

**Memory Upgrade for Amigas**

Alegra, a memory expansion unit from Access Associates, adds 512K to 2 megabytes of RAM to the Commodore Amiga. The unit supports the auto-configuration architecture of the Amiga; with 512K bytes of RAM, it costs \$379.

According to the company, the Alegra's power requirement is less than 5 watts for all versions; power is supplied by the Amiga at the expansion connector. Contact Access Associates, 491 Aldo Ave., Santa Clara, CA 95054, (408) 727-0256. Inquiry 574.

**Streaming Tape Backup for Macs**

Mirror Technologies' Magnum Tape 20 tape drive offers image, file-by-file, and incremental tape backup for the Macintosh computer. The drive uses tape cartridges (\$29) with a capacity of 25 megabytes.

Priced at \$1195, the drive connects to the SCSI port of a Mac Plus or to a Fat Mac equipped with the company's Fast Port option (\$199). Contact Mirror Technologies, 2209 Phelps Rd., Box 304, Hugo, MN 55038, (612) 426-3276. Inquiry 575.

(continued)

# Unforgettable.



Disc drives should never forget one thing: your important information.

At Seagate, we build our drives to protect your data against all mishaps. And we put each drive through a series of grueling tests to make sure it doesn't forget.

That's why quality-conscious customers have bought more than 3 million of our 5 1/4" hard disc drives.

So the next time you're looking for a new computer, disc memory upgrade or add-on, ask for Seagate by name.

It's all you need to remember.

Seagate Technology, 920 Disc Drive,  
Scotts Valley, CA 95066. 800-468-DISC.  
In California, 800-468-DISK.

 **Seagate**

## A D D - I N S

**Internal Hard Drive for Tandy 1000**

**A**n internal 10-megabyte hard disk drive for the Tandy 1000 is available from J&M Systems. The \$495 drive comes with a controller, cables, mounting hardware, and installation manual. The drive requires IBM PC-DOS 2.1 or later; its low power consumption, the company says, enables it to be powered by the Tandy 1000's power supply. For more information, contact J&M Systems Ltd., 15100-A Central SE, Albuquerque, NM 87123, (505) 292-4182. Inquiry 576.

**PC Network for \$250 per Computer**

**T**he Invisible Network, a local area network for IBM PCs and compatibles, can connect up to 45 computers at a maximum distance of 1300 feet. Each computer in the network is equipped with a plug-in board and linked with double twisted-pair wire and telephone jacks. The network requires one computer with a minimum of 320K bytes of RAM and a hard disk to be used as server; the company recommends an IBM PC AT.

The network transfers data at a rate of 700K bits per second. It requires the IBM PC Network program as the network operating system and can run PC- or MS-DOS 3.1 or later and multiuser NETBIOS programs such as dBASE III Plus, R:base 5000, and others.

Each plug-in board costs \$249.95; a 30-foot cable sells for \$10. A starter kit with two plug-in cards and a

cable costs \$499.90. For more information, contact Invisible Software Inc., 481 47th Ave., San Francisco, CA 94121, (415) 221-0916. Inquiry 577.

**Plug-in ROM Simulator**

**T**he ROMSim from Grossman + Associates is a ROM simulator board designed to increase the efficiency of microprocessor development. According to the company, the board can be used in place of in-circuit emulators in most development applications.

The board occupies one slot in the IBM PC AT and compatibles and emulates 2716, 2732, 2764, 27128, and 27256 ROMs. ROM-based programs can execute from the board's RAM, and programs assembled on the computer can be loaded directly into the board. You can use the standard DEBUG utility to enter patches or changes to a program while debugging. The board also features address trapping and a processor address capture.

The ROMSim costs \$650. For more information, contact Grossman + Associates, 749 Grayling Bay, Costa Mesa, CA 92626, (714) 662-7911. Inquiry 578.

**4- and 8-Megabyte RAM Upgrades for RT PCs**

**C**learpoint released two memory expansion boards for the IBM RT PC. The RTRAM/4 offers up to 4 megabytes of RAM using 256K ZIP DRAMs, and the RTRAM/8 offers an 8-megabyte capacity using megabit DRAMs. Both boards sup-

port the RT's error detection and correction logic and have an access time of 150 nanoseconds.

The RTRAM/4 draws 1.9 amps, and the RTRAM/8 draws 1.4 amps because of the fewer number of DRAMs. List price for the 4-megabyte board is \$1895; for the 8-megabyte board, \$4395. For more information, contact Clearpoint Inc., 99 South St., Hopkinton, MA 01748, (617) 435-5395. Inquiry 579.

**Definicon's 32-bit Coprocessors for PCs**

**D**efinicon Systems has developed two 32-bit coprocessor boards for IBM PC XTs, ATs, and compatible computers. The boards have an NS32032 processor operating at a minimum of 10 MHz, an NS32081 floating-point processor, and an NS32082 memory management unit for MS-DOS virtual memory functions. Both boards support multiuser tasks under AT&T's UNIX System V.

The basic board (DSE-32) can be equipped with up to 2 megabytes of dual-ported RAM. The DSI-32E comes with 2 or 4 megabytes of 120-ns RAM and features an expansion socket that accepts one or two half-size piggyback boards for up to 12 megabytes of RAM. The DSI-32E is also available with a clock speed option that boosts the clock rate to 15 MHz. Both boards include a 2681 DUART operating at 38,400 bps and two RS-232C serial ports via DB-25 and DB-9 connectors.

The boards' proprietary loader runs under MS-DOS

2.0 and later. For software development, the company offers C, Pascal, and FORTRAN compilers, as well as assemblers, linkers, loaders, library managers, symbolic debuggers, public domain FORTH and LISP, a graphics library for virtual screens, and utilities.

Prices for the DSI-32 begin at \$1495; for the DSI-32E, \$2295. A 4-megabyte add-on board costs \$1795. For more information, contact Definicon Systems Inc., 31324 Via Colinas, Suite 108, Westlake Village, CA 91362, (818) 889-1646. Inquiry 580.

 **GPIB Interface for PCs from Philips**

**P**hilips introduced a GPIB interface that allows an IBM PC, AT, or compatible computer to connect to and control up to 15 instruments.

The PM 2201 board plugs into one of the computer's expansion slots and comes with supporting software and an installation and programming manual. The software enables you to call GPIB procedures through a high-level language addition to the computer's BASICA or GW-BASIC interpreter. Functions include bus initialization, sending commands, sending and receiving messages, remote and local instrument setting, serial polling, time-out setting, error reporting, and others.

The PM 2201 sells for \$850. For more information, contact Philips Test and Measurement Instruments Inc., 85 McKee Dr., Mahwah, NJ 07430, (201) 529-3800. Inquiry 581.

(continued)

**NEW RELEASE**  
EVEN MORE FEATURES

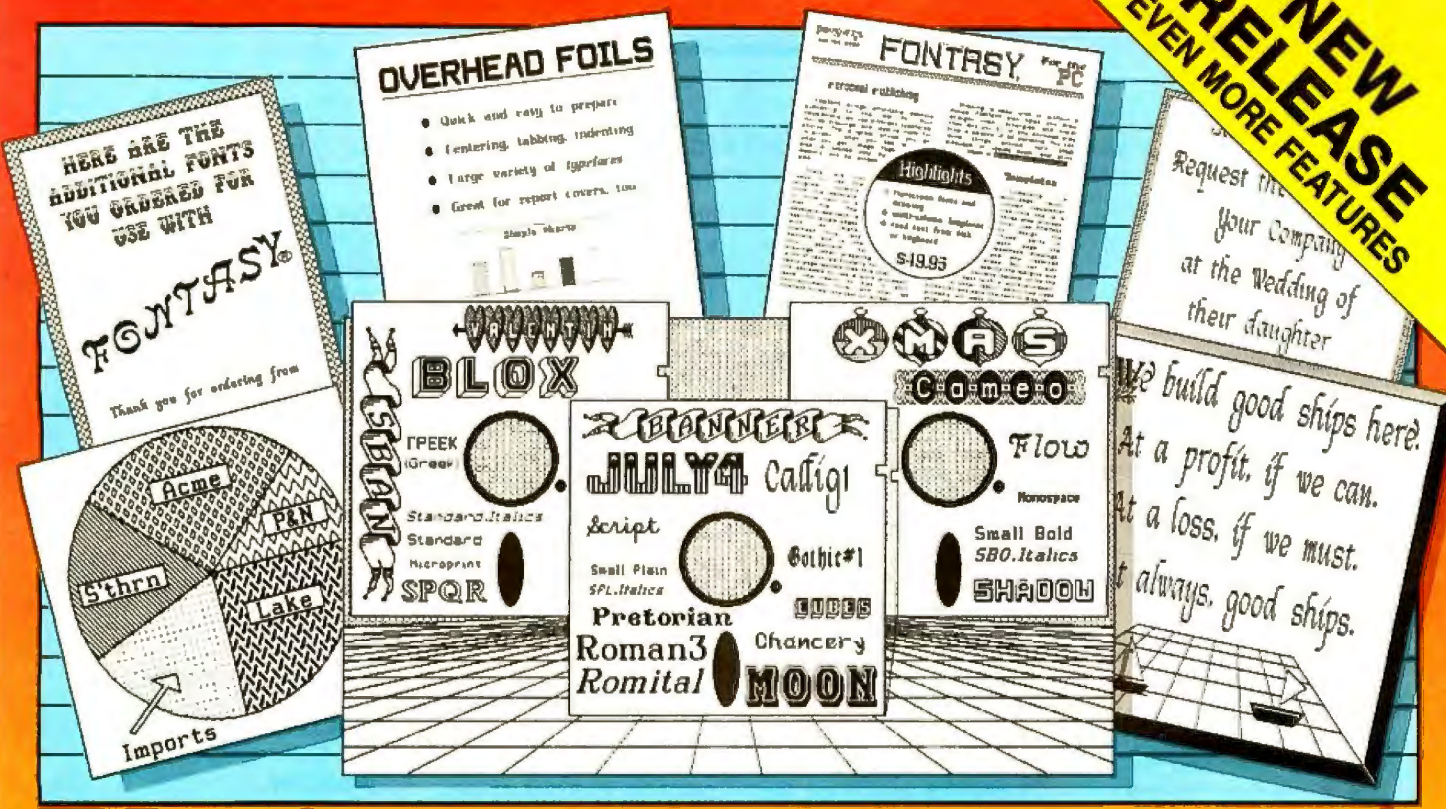

Fontasy printed all of these.

# See What You Can Do With

**P**resentations! Newsletters! Flyers! Signs! Overhead foils! Invitations! Menus! Logos! Announcements! Banners! Layouts! When you need a good-looking visual quickly you need FONTASY — superb typefaces and simple drawing in one easy to use package.

FONTASY gives you a "what-you-see-is-what-you-get" picture, as you type and draw on the graphics screen of your IBM PC. You can create a page at a time, see a mini-picture of that page, print it, and save it on disk. Page size is limited only by memory, not by screen size.

### Features

Proportional space, justify, kern, bold face, rearrange, magnify, black/white reversal, rotate, mirror image, lines, rectangles, ovals, draw, fill in, undo (and un-undo), on line help, 200 page book, and easy control from keyboard or mouse. Corporate licenses available.

Fonts, fonts, and more fonts! We have over 275 typefaces in our growing library, and will be happy to send you free print samples on request.

When you deal directly with the manufacturer (that's us), you pay rock-bottom distributor prices. If you order FONTASY now, we will give you 28 fonts (a \$50 value) at no extra charge. With so many features at such a low price, FONTASY belongs in your software library even if you already have a "font" program.

Inquiry 281



**\$69<sup>95</sup>**

Includes 28 Fonts and free ClipArt.

### Equipment Needed

IBM-PC, XT, AT, or true compatible (Compaq, etc.) with IBM or Hercules graphics adapter and graphics monitor. 256K memory needed for partial pages, 448-640K recommended for full pages. Dot-matrix printer. Mouse optional. MS-DOS 2.00 or above.

FONTASY supports: IBM graphics printer, Proprinter, Epson FX, JX, LX, MX, RX, and LQ-1500; C. Itoh 8510, 1550, 1570, Prowriter-Jr, H-P LaserJet, ThinkJet; Microline 92, 93; Gemini 10X, 15X; Radio Shack DMP 105-430, 2100; Toshiba 351, 1340-1351; Star; and most Epson-compatibles.

### Money-Back Guarantee

Fontasy is not copy protected and has a 30 day money back guarantee. So, take advantage of our breakthrough price and order now TOLL FREE:

**1-800-824-7888, operator 669 (ORDERS ONLY)**

For further information and same day shipping, call: (818) 765-4444

**PROSOFT®**  
7248 Bellaire Ave., Box 560  
No. Hollywood, CA 91603-0560

Name \_\_\_\_\_ Company \_\_\_\_\_  
Address \_\_\_\_\_ Telephone \_\_\_\_\_  
City, State, ZIP \_\_\_\_\_  
Visa/MC \_\_\_\_\_ Exp. Date \_\_\_\_\_  
Computer \_\_\_\_\_ Memory \_\_\_\_\_ Printer \_\_\_\_\_

Terms: M.C. Visa, checks. Please add \$3.00 shipping and handling in U.S. or Canada, \$20.00 overseas, \$2.00 for C.O.D., and sales tax in Calif.

**FONTASY \$69.95**  
Tax \_\_\_\_\_  
Shipping \_\_\_\_\_  
Total \_\_\_\_\_

## 68020 C Cross-Compiler System

**S**oftware Development Systems announced the UniWare 68020 C Cross-Compiler System, which runs under UNIX, XENIX, and DOS. It supports Kernighan and Ritchie with standard extensions and new language features such as the const type specifier, function prototyping, and lint-like type checking.

You can write programs in any combination of C and assembly language, and you have control over placement of program parts and the sizes of ints, pointers, and other types.

The package includes a 68020 assembler with macros. The DOS version sells for \$595; XENIX for \$1390; and UNIX for \$2790. Contact Software Development Systems Inc., 3110 Woodcreek Dr., Downers Grove, IL 60515, (312) 971-8170. Inquiry **582**.

## Serial Async Communications

**A** serial asynchronous communications package. Dual Serial Port Manager from Akron Software provides an interface between an application program and the serial ports of an IBM PC, XT, AT, or compatible. It enables applications developers to write programs that communicate with external modems, computers, or other peripherals via the COM1 and COM2 ports.

The interface program is interrupt-driven, buffers all received and transmitted data, and enables developers to specify the size of each buffer. With DSPM, an application program can use

both ports simultaneously.

DSPM works with programs written in Pascal, C, compiled or interpreted BASIC, FORTRAN, and assembly language. It requires less than 2K bytes of RAM plus buffer space, according to the company, and costs \$99. For more information, contact Akron Software, 53 Hillside Ave., Toronto, Ontario, Canada, M8V 1S7, (416) 251-1866. Inquiry **583**.

## Multiuser Operating Environment

**R**ealFile from Realia enables you to use the file-sharing capabilities of PC-DOS on the IBM PC Network. A central journal communicates task record locks, current positions, and block alterations.

The RealFile operating environment runs on IBM PCs, XTs, ATs, and compatibles running PC-DOS or MS-DOS 3.1 or higher. The program uses 8K bytes of RAM and costs \$150. For more information, contact Realia, 10 South Riverside Plaza, Chicago, IL 60606, (312) 346-0642. Inquiry **584**.

## PDOS for 68020 Systems

**E**yring Research Institute announced a version of PDOS for 68020-based systems. PDOS includes a real-time, multitasking kernel, file manager, editor, floating-point module, assembler, and linker. These require less than 32K bytes of RAM, according to Eyring.

The Institute reports that the macro assembler runs

up to 40,000 lines per minute.

BASIC, C, Pascal, and FORTRAN are available for use with the 68020 PDOS. The operating system alone costs \$1250. For more information, contact Eyring Research Institute Inc., 1455 West 820 N, Provo, UT 84601, (801) 375-2434. Inquiry **585**.

## A Ratfor for MS-DOS FORTRAN-77

**L**ogical Developments says it has rewritten the Ratfor concept, used primarily in minicomputer applications, using C, enabling it to work with FORTRAN-77 compilers and personal computers.

RF77 is a translator program, with programs written in RF77 syntax and then converted into equivalent FORTRAN code. RF77 also accommodates FORTRAN's formatting requirements, enabling the programs to be compiled with any normal FORTRAN compiler.

RF77 adds WHILE, FOR, and REPEAT...UNTIL loop-control structures, which are not in FORTRAN.

The RF77 program requires an IBM PC or compatible running MS-DOS or PC-DOS 2.0 or higher. RF77 costs \$65. For more information, contact Logical Developments, P.O. Box 55798, Houston, TX 77255, (800) 835-2246, ext. 41. Inquiry **586**.

## Simulator/Debuggers for MS-DOS Machines

**M**ecklenburg Engineering's simulator/debuggers enable you to test and debug software by loading

files in hexadecimal format. Status displays show the contents of the machine registers and also memory references, where necessary. Instructions are displayed disassembled and show the data about to be read or overwritten. You can change target machine registers and memory from the keyboard.

The programs run on IBM PCs, XTs, ATs, and compatibles. Versions are available for the 6300, 6500, 6800, 8085, 8048, and Z80. Each is \$75. Contact Mecklenburg Engineering Inc., P.O. Box 744, Chagrin Falls, OH 44022, (216) 338-8379. Inquiry **587**.

## Visual COBOL

**V**isual COBOL from mbp Software and Systems Technology is an enhanced version of its native code COBOL compiler. New features include full support of DOS path names, faster compilation speed, and a shrink utility that, according to the company, reduces the size of executable code.

This screen management system has an enhanced mask editor that creates a working-storage screen definition in the form of a COPY file. The enhanced mask editor also offers real-time numeric field validation and update capabilities with an ACCEPT statement.

Visual COBOL runs on IBM PCs, XTs, ATs, and compatibles with 192K-byte RAMs. The company recommends a hard disk. The package costs \$1150. Contact mbp Software and Systems Technology Inc., 1131 Harbor Bay Parkway, Suite 260, Alameda, CA 94501, (415) 769-5333. Inquiry **588**.

(continued)



Program Review:

**TRANSEC  
dANALYST™**  
CONVERTS ANY dBASE III®  
TO dBASE III PLUS  
**\$74.95**

**Makes dBASE Easier to Program,  
Reduces Logic Errors, Bugs**

TranSec dANALYST™ automatically converts any dBASE III program to dBASE III PLUS with true record and file locking for multi-user operation. Features include syntax/blocking analysis, tabbed file output, variable cross reference. Framework-type interface command windows, pop-up menus, graphic analysis REPORTS menu. Saves programmer's time to analyze and debug dBASE II, III, or PLUS. Supports multi-user Clipper and network version of WordTech. Not copy protected. Rated a "best buy."

TranSec dANALYST™ \$74.95 plus \$5 s/h  
TO ORDER: 1-800-423-0772 VISA/MC  
IN FL: 1-305-474-7548

Program Review:

**TRANSEC  
PCEASY™**  
FILES LIKE YOU THINK  
**\$74.95**

**Simplify Naming, Finding Your  
Files with 32-Character File Names**

TranSec PCEasy™ is a new easy-to-use "office environment" file management system that allows anyone to easily organize large amounts of data on a hard disk. Expands DOS file name limit to 32 characters to name files naturally, the way you think. Use easily remembered plain words or numbers. The interface structure mimics the paper world, only it's faster, better and easier to use... by programmers, managers, secretaries, clerks. PCEasy immediately finds file cabinets, file drawers, file folders, spread sheets, reports in their own logical location. Automatic menu access to application programs. Works with all popular applications and utilities. Not copy protected. Rated "\*\*\*\*" for ease of use."

TranSec PCEasy™ \$74.95 plus \$5 s/h  
TO ORDER: 1-800-423-0772 VISA/MC  
IN FL: 1-305-474-7548

# UNLOCK™ Removes Copy Protection

Produces Unprotected Backup Copies

## RUNS YOUR SOFTWARE ON ANY HARD DISK

UNlock "copying" disk allows you to make "unprotected" DOS copies of popular original program disks. Unprotected backup copies perform perfectly, as do copies of these copies. UNlock copies run on any hard disk, including Bernoulli Boxes. No original

required in drive "A." Run on a RAM disk simply and conveniently. Also, copy DOS 5¼" programs to 3½" diskettes. For IBM® PC, XT, AT, compatibles, 256K or more, DOS 2.1 or higher. Choice of the critics!

Guaranteed to work only with programs below:

**UNLOCK™ ALBUM "A" PLUS** **\$49.95**  
(Plus \$4 ship/handling Foreign orders \$10)

- dBASE III & dBASE III PLUS™
- FRAMEWORK I & II™
- CHARTMASTER™ (6.1)
- SIGNMASTER™ (5.1)
- FASTBACK™ (5.3)
- HARVARD TOTAL PROJECT MGR.™ (1.10)
- THINKTANK™ (2.0, 2.1)
- LOTUS 1-2-3™ (1.A-2.0)
- IBM WRITING ASSISTANT™ (1.01)
- IBM FILING ASSISTANT™ (1.0)
- IBM REPORTING ASSISTANT™ (1.0)
- GRAPHWRITER™ (4.3, 4.31)
- REALIA COBOL™ (1.2, 2.0)
- MULTILINK ADVANCED™ (3.02, 3.03)

• DOLLARS & SENSE™ (2.0)

**UNLOCK™ ALBUM "B" PLUS** **\$49.95**  
(Plus \$4 ship/handling Foreign orders \$10)

- SYMPHONY™ (1.1)
- CLIPPER™
- LOTUS 1-2-3 REPORT WRITER™ (1.0)
- DOUBLEDOS™
- smARTWORK™ (1.0 Rev. 8 thru 10 & 1.1)
- DISK OPTIMIZER™
- MANAGING YOUR MONEY™ (1.5, 1.51, 2.0)
- MICROSOFT WORD™ (1.15, 2.0, 2.01)
- PFS: ACCESS™ (1984 Ed.)
- PFS: PLAN™ (B)
- PFS: GRAPH™ (B)
- PFS: WRITE™ (1.01, C)
- PFS: REPORT™ (B, C)
- PFS: FILE™ (B, C)

• DATABASE MANAGER II—THE INTEGRATOR™ (2.0, 2.02)

**SPECIAL OFFER** "Best of UNLOCK"  
**ALBUM "D" PLUS** **\$74.95**  
(Plus \$4 ship/handling Foreign orders \$10)

- dBASE III & dBASE III PLUS™
- FRAMEWORK I & II™
- CLIPPER™
- FASTBACK™ (5.3)
- CHARTMASTER™ (6.1)
- SIGNMASTER™ (5.1)
- DOLLARS & SENSE™ (2.0)
- MICROSOFT WORD™ (1.15, 2.0, 2.01)
- LOTUS 1-2-3™ (1.A-2.0)
- SYMPHONY™ (1.1)
- LOTUS 1-2-3 REPORT WRITER™ (1.0)
- DOUBLEDOS™
- HARVARD TOTAL PROJECT MGR.™ (1.10)
- MANAGING YOUR MONEY™ (1.5, 1.51, 2.0)
- THINKTANK™ (2.0, 2.1)

**UNLOCK™ FLIGHT/JET #201** **\$14.95**  
(Plus \$4 ship/handling Foreign orders \$10)

- FLIGHT SIMULATOR™ - JET™

CHOICE OF THE CRITICS!

**PERSONAL COMPUTING** "UNlock has two particularly endearing characteristics: it works, and works simply. I was able to quickly produce unprotected copies of Lotus 1-2-3 release 2, Symphony 1.1, Microsoft Word 2.0, dBase III 1.1, and Framework II. These copies performed flawlessly, as did copies of these copies." Christopher O'Malley, PERSONAL COMPUTING, April '86

**PC** "Because copy protection can interfere with the ability to back up a hard disk, business-oriented users may prefer programs like TranSec's UNlock series." Winn L. Rosch, PC MAGAZINE, May 27, 1986

**BYTE** "UNlock 4.7 defeats the latest Prolok and SuperLock type of copy protection scheme. It's menu-driven and works fine on the programs it's supposed to work on: Lotus 1-2-3, dBase III, Framework, Symphony, Paradox, and several others." Jerry Pournelle, BYTE, Feb. '86

Recommended by the editors of:  
**PERSONAL COMPUTING**  
"The Best Software Utilities For Under \$100"

**TRANSEC  
UNLOCK™**

ORDER TODAY TOLL FREE:  
**1-800-423-0772**  
IN FLORIDA: 1-305-474-7548



TranSec Systems, Inc., 1802 North University Drive, Plantation, FL 33322  
Trademarks are the sole property of their respective owners. UNLOCK is for use only to improve the usability of legally acquired and operated software.

## SOFTWARE • SCIENTIFIC AND ENGINEERING

**Program for Robot Design**

**K**ern International's MATMAN, a program for computer-aided design of robot arms written at Texas A&M, is based on the Stanford manipulator. The software can predict the degree-of-freedom motion of the manipulator when the control parameters of each link are specified, or it can tell what the control parameters should be for a particular movement. MATMAN symbolically handles the complex matrix manipulation.

The disk contains source code in BASIC for the IBM PC. The manual covers the theory of robot manipulator kinematics and the derivation of equations. MATMAN sells for \$85. Contact Kern International Inc., 575 Washington St., Pembroke, MA 02359, (617) 826-0095. **Inquiry 589.**

**Computer-aided Circuit Design**

**E**soft's electronic design tool, CompDes, is a menu-driven program with selections that range from basic electricity to circuit design.

The program calculates values of circuits for active and passive filters, attenuators, amplifiers, and power supplies. You can

determine circuit values of resistance, reactance, resonance, and decibel ratios with the program's built-in calculators.

To use CompDes, you must have an IBM PC, XT, AT, or compatible with MS-DOS or PC-DOS 2.0 or higher and at least 128K bytes of RAM. The price is \$49.95. Contact Esoft Software, P.O. Box 072134, Columbus, OH 43207, (614) 491-0832. **Inquiry 590.**

**Least Squares Approximation**

**A**lpha Applied Research announced R2, a least squares approximation software package with curve fitting and data correlation capabilities.

You can build mathematical models of scientific and engineering data using a variety of functions, including polynomials, exponentials, power functions, logarithmics, trigonometrics, inverse trigonometrics, hyperbolic, and inverse hyperbolic. You can test many functional forms, according to the company, with the addition of user-defined variables. You can also build linear and nonlinear equations in two to ten variables from experimental data.

To run R2 you must have

an IBM PC XT or compatible running MS-DOS or PC-DOS 2.0 or higher, at least 256K bytes of RAM, and a single floppy disk drive. R2 costs \$199 for the single-variable configuration; \$298 for the multiple version. Contact Alpha Applied Research, 2355 McLean Blvd., Eugene, OR 97405, (503) 485-6841. **Inquiry 591.**

**Signal Processing on the IBM PC**

**T**ektronix announced Signal Processing and Display Programs, a waveform-processing, display, and data structure manipulation package.

SPD offers signal processing algorithms, enhanced graphics, flexible data structures, and software libraries. According to the company, SPD has more than 190 processing functions.

All of the waveform-processing graphic-display functions and data structure manipulation utilities are written in C. Some of these functions can be accessed through a BASIC interface as well.

Hardware requirements include an IBM PC, XT, AT, or compatible with 256K bytes of RAM, a hard disk, and color graphics adapter. The company recommends using an XT or AT with 640K

RAM. For BASIC programming, you'll need an IBM BASIC version 1.0 compiler. For C programming, SPD is compatible with Lattice C version 2.15. The cost of the package is \$950. Contact Tektronix Inc., P.O. Box 500, Beaverton, OR 97077, (800) 426-2200; in Oregon, (503) 627-9000. **Inquiry 592.**

**Guide to Signal Processing**

**M**oonshadow Software describes its SPIA as an interactive software guide for people who want to study signal processing. Using the program, you "build" functions by selecting from a library of predefined functions and mathematical operations. These operations include Fourier transforms, convolutions, and correlations. Each command is displayed graphically in up to three windows. SPIA also operates on user-acquired data.

The package runs on the IBM PC family and compatibles and supports several graphics adapters, including Hercules and IBM devices. It costs \$99; "qualified students" can buy it for \$25. Contact Moonshadow Software, 5016 Castlewood Dr., San Jose, CA 95129, (408) 446-2459. **Inquiry 593.**

## SOFTWARE • BUSINESS AND OTHER

**Linking XENIX Machines**

**M**IBM's TEAMate is a tool that enables groups of people to work together using their existing terminals, XENIX-based personal computers, and software.

TEAMate structures users' files into an outline form,

from which members of the team can develop, reorganize, edit, or read documents. These can include text, spreadsheets, or graphs.

The software can also be used as an electronic messaging system and a computer conferencing system

for both internal and external communication.

The user interface is cursor-controlled. Other features include an on-line help facility, database access control, XMODEM support, and mappable keys for non-standard terminal support. You can customize the commands, database, and screen and print formats for vertical

applications.

TEAMate runs under SCO XENIX System V on the IBM PC AT and compatibles. Prices for TEAMate start at \$1995. An upgrade kit, which includes SCO XENIX System V, a database system, a word-processing system, 2 megabytes of

(continued)



**IN 3,000 YEARS, MAN'S NEED  
TO PRESENT HIS IDEAS HASN'T CHANGED.  
BUT HIS TOOLS HAVE.**

Counting the corn and measuring the market used to demand artistic, as well as accounting, virtuosity. And before you could show your results to the powers that be, you had to wait for the ink to dry on the papyrus.

Today the whole procedure is cut and dried. Computers separate the wheat from the chaff. And printers present the results faster than an asp can strike.

Now, the new OKIDATA MICROLINE® 290 series goes beyond speed to give you graphic capabilities the ancient scribes would envy. The 292 model produces executive-quality correspondence at "need-it-yesterday" speed. The 293 prints just as fast on paper as wide as 16".

And for lightning-fast, high-quality data processing, the 294 wide carriage simply can't be beat.

Add color as brilliant as anything along the Nile—just by pushing a button. And special effects like boldface, underlines and italics are as easy to use, too.

The MICROLINE 290 series works with your IBM®, IBM compatibles and other major PCs. And works perfectly, thanks to OKIDATA's high quality and rugged reliability.

Count on OKIDATA to produce the clearest presentations for your business. And count yourself lucky you don't have to know how to draw. For the dealer nearest you, call 1-800-OKIDATA.

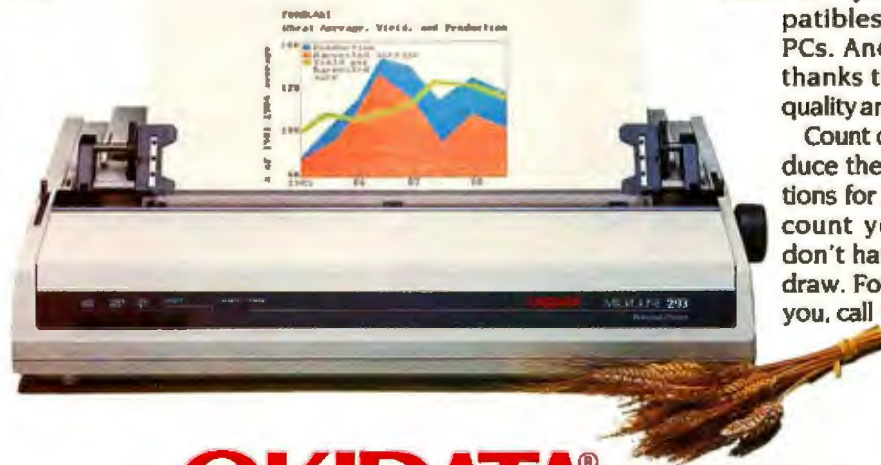

**OKIDATA®**  
an OKI AMERICA company

We put business on paper.

Inquiry 256

## SOFTWARE • BUSINESS AND OTHER

memory, and four serial ports, costs \$4500. For more information, contact MMB Development Corp., 753 Deep Valley Dr., Rolling Hills Estates, CA 90274, (213) 541-4504. Inquiry 594.

## Relational Database

**M**icrorim announced R:base System V, a database management product for the IBM PC and compatibles. This relational database enables multiple users to perform data management and create programs to automate data management tasks in stand-alone or multiuser LAN environments.

R:base System V requires an IBM PC, XT, AT, or compatible, with PC-DOS or MS-DOS 2.0 or higher for single users, 3.1 or higher for multiusers. Single users need 512K bytes of RAM; multiusers need 640K. A hard disk is required. The price is \$700. For more information, contact Microrim Inc., 3925 159th Ave. NE, P.O. Box 97022, Redmond, WA 98073-9722, (206) 885-2000. Inquiry 595.

## Database for IBM PCs

**T**AS-Plus, a programmable relational database, was announced by Business Tools. It combines the aspects of a file manager, a relational database, and an application development system.

TAS-Plus enables you to create, add, change, and delete database records without writing a program. Front-end facilities include pull-down menus and on-line help screens. You can display multiple records and manipulate data with the browse utility. The report



A screen from Microrim's R:base System V.

writer organizes the data that you select into report formats that you define. Also, you can convert dBASE III files to TAS-Plus files with another utility. Up to 16 files can be open at the same time, and they can be updated as well. And you can chain to other programs or execute DOS commands without leaving TAS-Plus.

System requirements include an IBM PC, XT, AT, or compatible running MS-DOS or PC-DOS 2.0 or higher. You must also have a monochrome or color monitor, 384K bytes of RAM, and at least one floppy disk or hard disk drive. TAS-Plus costs \$69. For more information, contact Business Tools Inc., 4038-B 128th Ave. SE, Suite 266, Bellevue, WA 98006, (206) 644-2015. Inquiry 596.

### WHERE DO NEW PRODUCT ITEMS COME FROM?

*The new products listed in this section of BYTE are chosen from the thousands of press releases, letters, and telephone calls we receive each month from manufacturers, distributors, designers, and readers. The basic criteria for selection for publication are: (a) does a product match our readers' interests? and (b) is it new or is it simply a reintroduction of an old item? Because of the volume of submissions we must sort through every month, the items we publish are based on vendors' statements and are not individually verified. If you want your product to be considered for publication (at no charge), send full information about it, including its price and an address and telephone number where a reader can get further information, to New Products Editor, BYTE, One Phoenix Mill Lane, Peterborough, NH 03458.*

send it through a network or e-mail system, using most communications packages. Solutions says.

Glue runs on any Mac and is HFS-compatible. Suggested retail price is \$49. Contact Solutions Inc., P.O. Box 989, Montpelier, VT 05602, (802) 229-0368. Inquiry 597.

## Function Library Enhances Clipper

**C**ommunication Horizons announced five versions of its function libraries, which provide record- and file-locking capabilities for the Clipper dBASE III compiler from Nantucket.

NovelLib provides multiuser capabilities for Clipper running on the Novell Network and requires Novell's Netware 4.61 or higher. PCnetLib is for use with IBM's PC Network or Token Ring. MlinkLib works with The Software Link's Multi-Link Advanced or LANLink. 3ComLib is for use with 3Com's EtherShare series. OrchidLib works with Alloy Computer Products' ATNX, RTNX, or NTNX and AST's PCnet.

All libraries share the same syntax and can be transported to another network with few program changes, according to the company. The multiuser libraries include a basic core of functions that parallel the record- and file-locking function of dBASE III Plus.

To use the libraries, you must have the appropriate network or multiuser system and an IBM PC or compatible with approximately 20K of free memory above the single-user program size. The libraries cost \$99 each. Contact Communication Horizons, 701 Seventh Ave., Suite 900, New York, NY 10036, (212) 724-0150. Inquiry 598.

## Graphics Glue

**G**lue is a Macintosh software package that enhances desktop-publishing programs, such as Page-Maker and ReadySetGo, by letting you incorporate in a document graphics from most Mac applications. Solutions Inc. says its product also makes electronic distribution of documents (newsletters, for example) practical.

The program adds a print-to-disk capability to most Mac applications. After you've saved a graph or a spreadsheet, you can copy images into a document being produced with MacWrite, MacPaint, Word, or other software. Images copied by Glue are not limited by screen size.

Once you've printed a document to disk, you can

## Small Wonder.

Proof positive that good things come in small packages is the new 3.5-inch diskette.

And that's big news for anyone who uses an appropriately configured IBM PC, PC/XT, Personal Computer AT and the new IBM PC Convertible.

Durable 3.5" diskettes, allow you to carry over 350 standard typed pages (720KB) in your shirt pocket. That's twice as much information as on a 5.25" (360KB) diskette, in a much more rugged, portable form.



*The new 3.5" diskette stores up to twice as much (720 KB) as a 5.25" (360KB) diskette.*

Now IBM PC users have the option of using programs and data in either size, and the flexibility to work with other members of the IBM PC family using 3.5" diskettes.

## Translation Services.

The new IBM Personal Computer 3.5" External Diskette Drive provides a vital bridge between your IBM PC and 3.5" technology. This compact unit makes it easy for you to share information between computers using 3.5" diskettes and 5.25" diskettes.

*The IBM PC 3.5" External Diskette Drive provides a cost-effective bridge between 3.5" and 5.25" technology.*



*The new IBM PC Convertible is a f*

The IBM Personal Computer 3.5" External Diskette Drive comes in two models, one for the IBM Personal Computer AT and one for the IBM PC, PC/XT or IBM PC Convertible.

Information and applications can be shared\* between 3.5" diskette drive machines and an IBM PC running DOS 3.2 with the IBM Personal Computer 3.5" External Diskette Drive attached.

Transferring files and programs between 3.5" and 5.25" diskettes is as easy as making a backup copy of a diskette. So, you can very quickly have a "database to go" for your IBM PC Convertible. Or, a week's worth of sales call information in a ready-to-use form for your secretary when you return.

## Print Evolution.

The new IBM Proprinter XL is especially designed to make life easier for those who work with accounting applications. Its wide carriage design and switchable printing speeds of up to 200cps are perfectly suited for spreadsheet applications.

The IBM Proprinter XL also features an easy-to-use front operator panel that lets you choose from the XL's extensive menu of features, even if you have little or no programming skills.

Plus, the new Proprinter XL offers a long list of standard, labor-saving features to make many printing jobs easier: easy printing of single sheets and envelopes without removing your continuous forms paper, power-assisted paper

loading, all-points-addressable graphics capabilities, near-letter-quality printing (40cps), and emphasized text printing (100cps). Plus, you can set the printer in double high, double wide or emphasized print through the operator panel or through software.

## Power To Go.

The new IBM PC Convertible can play two powerful roles in any businessperson's life.

In the office, with an optional IBM PC monochrome or color display and adapter, the PC Convertible fills the bill as a space-saving desktop PC.

But when you're ready to hit the road or runway, just attach the high quality, 80-column x 25-line detachable LCD display, and the PC Convertible is ready to travel, too.

Weighing in at a scant 12 pounds, the IBM PC Convertible delivers full-size PC performance in a portable computer with heavyweight features including:

A full-function keyboard with full-size keys and the same center-to-center key spacing as a standard IBM PC keyboard.

A fast, very efficient 80C88 microprocessor with up to 10 hours of non-stop computing power between battery recharges (with average use).

Up to 512KB of user storage (through 128KB expansion cards from a standard 256KB).

Dual 3.5" diskette drives supporting 720KB capacity 3.5" diskettes.

Additional IBM PC Convertible features help ensure that work done on the road doesn't get lost in transit.

# READ ONLY

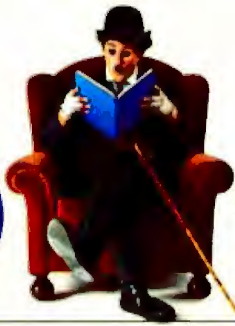

*A review of the IBM Personal Computer Family. Vol. 3, No. 1*

## Welcome To Read Only.

Here's great news for IBM PC users. IBM has expanded its already expansive PC product line to bring even more power and flexibility to your desktop.

In this issue alone you'll be reading about new enhancements to the IBM PC/XT, the IBM Personal Computer AT, the IBM PC Keyboard, the IBM Proprinter, the Mainframe Communications Assistant, and more.

And, as if that weren't enough, IBM has also found time to expand your computing horizons even more by introducing exciting new PC products. This issue of *Read Only* will tell you about the new IBM PC

Convertible, new 3.5" diskettes, the new IBM PC 3.5" External Diskette Drive, and two new accounting software packages.



## HARDWARE NEWS

### The Right Touch.

To make it easier than ever to work at an IBM PC/XT or Personal Computer AT, IBM has introduced the new IBM Enhanced Personal Computer Keyboard (shown below).

IBM redesigned its classic keyboard to better meet the needs of PC users, office system users, as well as users who communicate with larger computers.

To accomplish this, IBM included separate cursor and screen control keys, making it easier for users to dedicate the numeric keypad to numeric input when working with number-intense applications. Plus, the keypad can still be used for cursor and screen control when not in the num/lock mode.

IBM also increased the number of function keys from ten to twelve, arranged across the top of the keyboard. This gives users two additional keys for increased automatic operation.

All to enhance the productivity of those who work with words, numbers or a host of other applications.

Two *Ctrl* and *Alt* keys for ambidextrous access.

Isolated *Escape* key to help reduce keying errors.

Enlarged *Tab* and *Caps Lock* keys.

Twelve *Function* keys in new position—two additional *Function* keys provide added flexibility in host access or communications applications.

Enlarged *Backspace* and *Shift* keys.

Dedicated *Function Control* keys for frequently used functions.

Dedicated *Numeric Pad* including *Enter* key and four *Arithmetic Function* keys for easy numeric input.

Separate *Screen Control* and *Cursor* keys for faster, easier access.

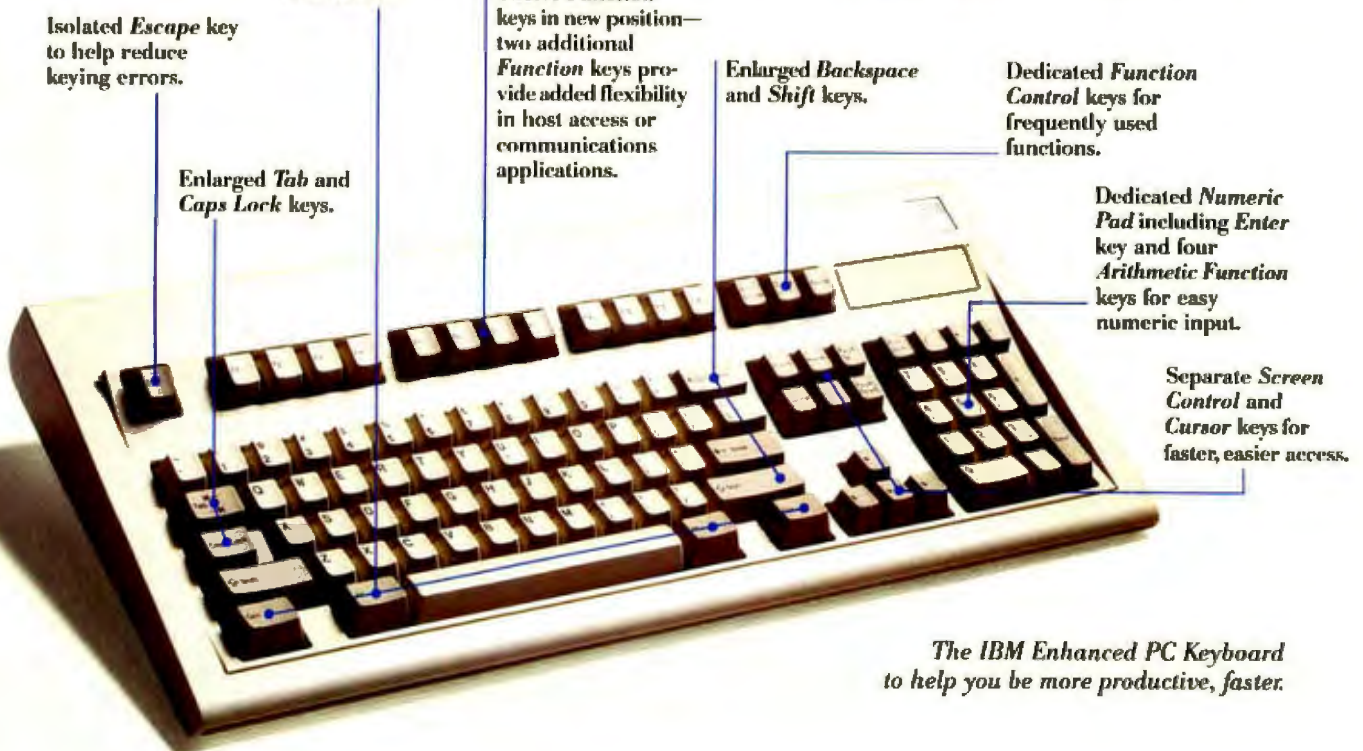

*The IBM Enhanced PC Keyboard to help you be more productive, faster.*



wer PC that works wherever you do.

These optional features include:  
An internal modem feature to let you communicate with other computers simply by plugging the PC Convertible into any standard modular phone outlet.  
The IBM PC Convertible Printer for system battery powered, near-letter-quality printing anywhere.  
Plus, the IBM PC Convertible can come with a helpful set of programs to get you up and running on the road to enhanced productivity. Fast.

### Planned For Growth.

It's a classic case of a very good thing that just keeps getting better. IBM has now introduced the enhanced PC/XT product family: increased flexibility in storage, memory and option configuration for maximum productivity today, and



The new IBM PC/XT—enhanced power and flexibility for today. And tomorrow.

plenty of room to expand as your business does.  
The XT is now available with a 20-megabyte hard file that can store up to 10,000 pages of information. There's also an easy, low cost way to increase memory to a full 640KB on the system board without tying up valuable expansion slots. And the XT now has 3.5" diskette capability, utilizing the new IBM Personal Computer 3.5" External Diskette Drive.

Plus, full IBM PC compatibility means that no matter which XT model you choose, you can benefit from the extensive IBM Personal Computer software library.

The new IBM PC/XTs, because one size should not have to fit all.

### Power Play.

If you thought you'd seen all the IBM Personal Computer AT has to offer, think again. Twice.

IBM has increased processor speed in two new models of the IBM Personal Computer AT by an impressive 33% (from 6mhz to 8mhz). So, they're sure to become your fast friends if you work with large spreadsheets and volumes of data.

The new models offer a standard 30MB hard file and the option to add an additional 20MB or 30MB hard file. That's a grand total of 60MB, or approximately 30,000 pages of words and numbers.

These two newcomers are born communicators: Sharing files with other PCs from a variety of popular software programs. Working as a server for data storage and file processing in an IBM PC LAN running

the IBM PC Local Area Network program. Utilizing IBM TopView™ and one of the IBM PC 3270 Emulation Programs to access mainframe information and to execute PC DOS and mainframe applications concurrently.

And the best news of all is that you can get all this increased power without an increased price.



Now the IBM Personal Computer AT offers a choice of hard files to meet your storage needs.



## WHAT'S THE PROGRAM

### Meet Your New Assistant.

Keeping the books for a small business is a very big job. So, IBM thought you could use a friendly, versatile, highly skilled assistant. The new IBM Accounting Assistant Series.

This complete series of automated bookkeeping application programs for small to medium size businesses can help cut any job down to size. And, its modular design means that you can start out with just the programs you need today, then expand your series as your business grows.

The IBM Accounting Assistant Series includes six individual editions: General Accounting, Accounts Payable, Accounts Receivable and Billing, Payroll, Inventory



The IBM Accounting Assistant Series. Big help for small to medium size businesses.

Control and Purchasing, and Job Cost bidding software.

Plus, thanks to the IBM Accounting Assistant Series' user-friendly attributes and easy-to-follow instructions, you can start profiting from your system from day one.

### High-Powered Advice.

Perhaps your business has progressed past the need for basic accounting software. Then you should consider getting powerful, sophisticated help: the IBM Business Advisor.

IBM Business Advisor PC accounting software takes integrated software to a new level of sophistication and ease-of-use.

Business Advisor's seamless architecture allows functions from each of its modules to play together. Passage back and forth among the General Accounting, Accounts Payable, Accounts Receivable, Payroll, Inventory Control, Order Entry and other applications is intuitive. Menu guide you easily from one task to another.

And when you make a change anywhere, consider it made everywhere it applies. Automatically, through Business Advisor's real-time posting feature.

This Business Advisor speaks your language, too. It uses business language instead of accounting language, and has over 80 easily customized financial report formats built in. And you don't have to keep this all to yourself, because in an IBM LAN

different people at different PCs can work on the same file at the same time.

And you always go further when everyone is working together.



### "NEWS" BRIEFS

**The 3270 Emulation Programs,** Entry Level, Version 2 and Version 3, give you an easy and inexpensive way to attach your IBM PC to your host computer.

Working at your IBM PC, stand-alone or in an IBM LAN, you can now utilize the local power and user-friendly attributes of your PC for DOS applications, plus have access to the vast memory, number-crunching capacities and other productivity-enhancing capabilities of your host computer.

The Entry Level product offers up to 40% faster file transfer between your



IBM PC 3270 Emulation Products can put your IBM PC or IBM LAN in touch with the big time.

PC and host computer. A "Hot Key" for easy switching between host and PC applications. Keyboard remapping so you can always work in a familiar keyboard format. And much more.

Versions 2 and 3 can provide an economical gateway which lets you

share the wealth of host knowledge with the members of your IBM PC Network or Token-Ring Network.

Versions 2 and 3 support the new PC DOS 3.2, 3.5" media, the IBM Local Area Network program 1.10, a host of printers and the TopView 1.1 interface, for multitasking and windowing capabilities.

All of which adds up to added productivity for you and everyone on your IBM Local Area Network or token ring.

To find out more about the entire family of 3270 PC Emulation Programs, as well as a wide range of other IBM connectivity hardware and software, watch for the next *Read Only*.

**Mainframe Communications Assistant** enhancements include 3.5" media support and increased IBM PC family communications capabilities.

**The IBM PC Voice Communications Option** speaks for itself. This multifunction adapter card can allow your IBM PC to recognize and respond to voice commands, speak text that appears on the screen, initiate and receive/record/playback phone calls, provide remote, tone push button phone access to your PC (and host), and transmit voice and data simultaneously.



For more information on any of the Personal Computer products discussed in this issue of *Read Only*, see your Authorized IBM Personal Computer Dealer. Or, call 800-447-4700. In Alaska call 800-447-0890.

IBM and Personal Computer AT are registered trademarks of International Business Machines Corporation. PC/XT and TopView are trademarks of International Business Machines Corporation.

\*Before copying any software product, be sure to read, understand and comply with the specific software license agreement and installation instructions for that product.

© 1986 International Business Machines Corporation. Little Tramp character licensed by Bubbles Inc., S.A.



# E·V·E·N·T·S A·N·D C·L·U·B·S

September 1986

## EVENTS

**MIDCON/86.** Dallas, TX. Electronic Conventions Management Inc., 8110 Airport Blvd., Los Angeles, CA 90045. (800) 421-6816; in California, (800) 262-4208 or (213) 772-2965. *September 9-11*

**ESC 86: SECOND EUROPEAN SIMULATION CONGRESS.** Antwerp, Belgium. The Society for Computer Simulation, P.O. Box 17900, San Diego, CA 92117-7900, or Ghislain C. Vansteenkiste, Professor of Engineering, University of Ghent, Coupure Links 653, B-9000 Ghent, Belgium, tel: 91-236961, ext. 400; telex: 12754 RUGENT. *September 9-12*

**SOFTWARE ENGINEERING '86.** Southampton University, United Kingdom. BISL Conference Dept. (SE '86). The British Computer Society, 13 Mansfield St., London W1M 0BP, United Kingdom, tel: 01 637 0471. *September 10-12*

**THE 39TH ANNUAL CONFERENCE ON ENGINEERING IN MEDICINE AND BIOLOGY.** Baltimore, MD. The Alliance for Engineering in Medicine and Biology, 1101 Connecticut Ave. NW, Suite 700, Washington, DC 20036, (202) 857-1199. *September 13-16*

**EUROMICRO 86: TWELFTH SYMPOSIUM ON MICROPROCESSING AND MICROPROGRAMMING.** Venice, Italy. Mrs. Chiquita Snippe-Marlisa, p/a TH Twente, Dept. INF, Room A227, P.O. Box 217, 7500 AE Enschede, The Netherlands, tel: (31) (53) 338799; telex: 44200 THES. *September 15-18*

**FALL NATIONAL DESIGN ENGINEERING SHOW & CONFERENCE.** Jacob K. Javits Convention Center, New York, NY. Fall National Design Engineering Show, Cahners Exposition Group, 999 Summer St., Stamford, CT 06905, (203) 964-0000. *September 16-18*

**THIRD ANNUAL INTERNATIONAL FORUM ON MICRO-BASED CADD.** Colorado State University, Fort Collins, CO. Office of Research, Development, and Training, Department of Industrial Sciences, Colorado State University, Fort Collins, CO 80523, (303) 491-5278. *September 17-19*

**CANADIAN HIGH TECHNOLOGY WEEK.** Ottawa, Ontario. Canadian High Technology Week, 2487 Kaladar Ave., Suite 214, Ottawa, Ontario, Canada K1V 8B9. (613) 731-9850. *September 21-27*

**1986 NEBRASKA VIDEODISC SYMPOSIUM.** Lincoln, NE. Videodisc Design/Production Group, KUON-TV/University of Nebraska, P.O. Box 83111, Lincoln, NE 68501-3111, (402) 472-3611. *September 22-25*

**PDOS INTEREST GROUP CONFERENCE.** Garden Grove, CA. Eyring Research Institute Inc., 1455 West 820 N, Provo, UT 84601, (801) 375-2434. *September 22-25*

**ULTRATECH '86.** Long Beach, CA. Gregg Balko, Society of Manufacturing Engineers, One SME Dr., P.O. Box 930, Dearborn, MI 48121, (313) 271-1500. *September 22-25*

**ARTIFICIAL INTELLIGENCE AND ADVANCED COMPUTER TECHNOLOGY CONFERENCE/EXHIBITION.** Rhein-Main Halle, Wiesbaden, West Germany. Tower Conference Management Co., 331 West Wesley St., Wheaton, IL 60187, (312) 668-8100. In Europe, TCM Expositions Ltd., Exchange House, 33 Station Rd., Liphook, Hampshire GU30 7DN, United Kingdom, tel: (44) 0428-724660; telex: 859438 TOWER. *September 23-25*

**THE INTERNATIONAL VIDEOTEX INDUSTRY EXPOSITION AND CONFERENCE.** New York, NY. Susan M. LeDonne, Cahners Exposition Group, 999 Summer St., Stamford, CT 06905, (203) 964-0000. *September 23-25*

**ACC '86: 1986 AUSTRALIAN COMPUTER CONFERENCE AND EXHIBITIONS.** Melbourne, Australia. Peter Peterick, Riddell Exhibition Promotions Pty. Ltd., Riddell House, 137-141 Burnley St., Richmond, Victoria 3121, Australia. *September 23-26*

**INTEREX/HEWLETT-PACKARD COMPUTER USERS CONFERENCE.** Detroit, MI. Interex, 680 Almanone Ave., Sunnyvale, CA 94086, (408) 738-4848. *September 29-October 3*

**NORTHCON/86 ELECTRONIC SHOW AND CONVENTION.** Seattle, WA. Electronic Conventions Management Inc., 8110 Airport Blvd., Los Angeles, CA 90045, (800) 421-6816; in California, (800) 262-4208 or (213) 772-2965. *September 30-October 2*

*If you send notice of your organization's public activities at least four months in advance, we will publish them as space permits. Please send them to BYTE (Events and Clubs), One Phoenix Mill Lane, Peterborough, NH 03458.*

## CLUBS

**THE AMIGAN APPRENTICE AND JOURNEYMAN.** P.O. Box 411, Hatteras, NC 27943. For Amiga programmers.

**NORTH AMERICAN AMIGA USERS GROUP (NAAUG).** Box 376, Lemont, PA 16851.

**MACINTERESTED.** Nashville Macintosh Users Group, c/o Clark Thomas, 2305 Ellison Place #C5, Nashville, TN 37203, (615) 327-1757.

**INDY ST COMPUTER CLUB.** Box 2525, Indianapolis, IN 46206, (317) 898-9856.

**AMIGA ATLANTA.** Box 7724, Atlanta, GA 30357, (404) 676-0384 or 676-0411.

**SPACE COAST AMIGA USERS GROUP.** P.O. Box 2098, Merritt Island, FL 32952.

**TORONTO ATARI FEDERATION.** 5647 Yonge St. #1527, Willowdale, Ontario, Canada M2M 4E9.

**THE SPACE COAST MACINTOSH MEETING AND DRINKING SOCIETY (MACMAD).** c/o Jamie Cox, 2604 Lewis St., Melbourne, FL 32901, (305) 723-7935.

**TECHNOLOGY UPDATE.** Sensory Aids Foundation, 399 Sherman Ave. Suite 12, Palo Alto, CA 94306, (415) 329-0430. Technology for blind and partially sighted people.

**APPLE PUGET SOUND PROGRAM LIBRARY EXCHANGE.** A.P.P.L.E. Co-op, 290 Southwest 43rd St., Renton, WA 98055.

**SNAP-N-SKETCH IMAGE PROCESSING USERS GROUP.** P.O. Box 9506, Berkeley, CA 94709, (415) 841-7627.

**KCS COMPUCLUB.** KCS Micro Computer Services, 8 Reynolds Cr., Belleville, Ontario, Canada K8P 2W7, (613) 966-8250.

**GAVILAN USER GROUP.** Robert Brown, 780 Manx Ave., Campbell, CA 95008, (408) 379-2774.

**MILWAUKEE AREA IBM PC USERS GROUP.** P.O. Box 2121, Milwaukee, WI 53201-2121.

**BAHAMAS BULLETIN BOARD SYSTEM.** Erik Russell, P.O. Box N1684, Nassau, Bahamas, (809) 326-5630. For Commodore 64 and 128 users. ■

## Conducted by Steve Ciarcia

### A SHARP APPLE

Dear Steve,

I am the owner of an Apple IIe and a Sharp PC-1350. I have learned that a modem and/or RS-232C interface is now available for the PC-1350 (perhaps for other Sharp PC machines as well).

However, I have been unable to locate information on how to hook my two computers together so they can communicate. Do you have any suggestions? Also, do you know of any users groups for Sharp PC-series computers or of any publications devoted specifically to these computers?

LARRY JONES  
Manhattan Beach, CA

*It would seem that the easiest approach to communication between your Sharp and Apple machines would be ASCII transfer through modems. Terminal programs in both machines would ease uploads and downloads and could allow format changes in files, allowing, for instance, BASIC program transfer. As these machines are widely dissimilar hardware-wise, this would seem to be the best way to go.*

*I am uncertain of the availability of a Sharp-specific publication or a users group in your area. A Sharp dealer would probably know of any such magazines. As to users groups, you might contact*

*The Silicon Valley Computer Society  
P.O. Box 60506  
Sunnyvale, CA 94088*

*They might be able to advise you of clubs in your area that are interested in Sharp computers. You might also pick up a copy of Computer Shopper (available at many electronics and computer shops); they have listings of users groups that are updated monthly.—Steve*

### 8 OR 16?

Dear Steve,

As a relative newcomer to computer hardware systems, I am somewhat perplexed to find a large number of 16-bit computers that have only eight DRAM chips on the main processor card. Included in this list are many of the newer computers, like the Amiga and the Atari

520ST, as well as the Cypher, which sports a 68000 and a Z80—surely there must be some way of accessing a 16-bit-wide RAM bank with two reads or writes of the Z80 rather than slowing the 68000 down by forcing it to increment the address after each half-word.

For the benefit of any other tyro who may be perplexed by the anomaly of a "four-lane highway with a two-lane tollgate at the end," could you please explain the pros and cons of 8- versus 16-bit-wide RAM in a 16-bit processor system?

I cannot imagine that price has anything to do with it, since the Amiga and the 520ST are recently released machines, and 256K-bit DRAMs are available for less than \$5 apiece.

Is it true that the NS32016 CPU has a CP/M subset of its coding? Does this mean that CP/M can be run directly on an NS32016?

CHRIS WENDT  
Malvern, Victoria, Australia

*There's a simple trade-off that governs whether or not a manufacturer will use a full 16-bit interface for a computer: Will the added performance add enough sales to outweigh the cost of the added hardware? As it turns out, fetching two bytes in sequence isn't a severe penalty with micros that are designed to use an 8-bit bus, so for most tasks the smaller bus wins out. The trick is that the 808x- and 680xx-class processors fetch instruction bytes before they're needed, whenever the bus isn't being used for anything else. In most cases, the prefetching hardware can keep up with the instruction execution hardware with little performance degradation.*

*Using both 16-bit and 8-bit processors on the same bus has some interesting consequences: If the memory is 16 bits wide, you must read and write two bytes at a time. How do you handle an 8-bit processor writing only one byte? In effect, the memory hardware must read two bytes, change one of them, then write them both back. Remember that a 16-bit memory can't be accessed byte by byte!*

*There are two reasons why you don't see 16-bit-wide RAMs, ROMs, and*

*EPROMs. The first is pin count: 16 for data I/O, 1 each for power and ground, 2 for chip select and output enable, then 7 or 8 for a multiplexed address add up to 28 pins and a rather large (expensive) package. The second is economics: IC prices are determined in large part by sales volume. A 16-bit-wide IC could be used only in a 16-bit-wide system; an 8-bit-wide IC can be used in either a 16-bit or an 8-bit system. If you're a manufacturer, you'll always choose to produce a part that can be used in the most systems.*

*As far as I know, the National Semiconductor 32000 family isn't compatible with the Intel 8080 instruction set used by CP/M computers. You may be thinking of the new V20 processors from NEC that are pin-compatible with Intel 8088 ICs but can also emulate an 8080 when a special mode is used.—Steve*

### SOLENOIDS

Dear Steve,

I am a graduate student in water resources engineering at Texas A&M University. We are currently modeling water distribution networks (water supply system: pipes, elevated tanks, pumps, etc.) with a program written in BASIC. We need to be able to trigger electric solenoids to turn pumps, valves, etc., on and off from within the program. I haven't seen any solenoid-driver software or hardware advertised that could be operated with the

(continued)

IN ASK BYTE, Steve Ciarcia answers questions on any area of microcomputing. The most representative questions received each month will be answered and published. Do you have a nagging problem? Send your inquiry to

Ask BYTE  
c/o Steve Ciarcia  
P.O. Box 582  
Glastonbury, CT 06033

Due to the high volume of inquiries, personal replies cannot be given. All letters and photographs become the property of Steve Ciarcia and cannot be returned. Be sure to include "Ask BYTE" in the address.

The Ask BYTE staff includes manager Harv Weiner and researchers Eric Albert, Bill Curlew, Ken Davidson, Jeannette Dojan, Jon Elson, Roger James, Frank Kuechmann, Dave Lundberg, Edward Nisley, Dick Sawyer, Andy Siska, and Robert Stek.

## News about the Microsoft Language Family

### Adding New Commands to Microsoft® QuickBASIC Version 2.00

The standard way to add separately compiled modules to a BASIC program has been through the use of a linker, but Microsoft QuickBASIC provides a second method as well. The Microsoft QuickBASIC BuildLib routine can be used to add separately compiled modules to the BASIC runtime file. You can create a new runtime file that includes software interrupt support by typing:

```
BUILDLIB USERLIB.OBJ, QB__BIOS.EXE;
```

This will create a new runtime file by the name QB\_\_BIOS.EXE that can be used by Microsoft QuickBASIC. When you load Microsoft QuickBASIC, you must specify the new runtime file with the /L switch as follows:

```
QB/L QB__BIOS.EXE
```

This allows Microsoft QuickBASIC to support separately compiled modules without requiring the LINK step.

### Using the mouse in Microsoft QuickBASIC Version 2.00 Programs

The software interrupt routines that you just added to Microsoft QuickBASIC can be used to access the ROM BIOS and DOS system service routines. These routines provide a range of mouse, keyboard, video, and DOS services that were previously unavailable to BASIC programs. The following example lets you draw in high resolution graphics mode with the mouse. The mouse driver (MOUSE.COM) must be installed before running this program.

```
DEFINT a-z 'everything is integer
SCREEN 2 'high resolution graphics
m0 = 0: m1 = 0: m2 = 0: m3 = 0: oldx = 0: oldy = 0
CALL mouse(m0, m1, m2, m3) 'initialize mouse
m0 = 1
CALL mouse(m0, m1, m2, m3) 'turn on mouse cursor
m0 = 3
WHILE inkey$ = "" 'exit when a key is pressed
 CALL mouse(m0, m1, m2, m3) 'read mouse position
 IF m1 <> 0 THEN 'if mouse button pressed
 LINE(oldx,oldy)-(m2, m3) 'draw a line to mouse position
 oldx = m2: oldy = m3 'save old position
 END IF
WEND
END
' Call the mouse interrupt driver
SUB mouse(m0, m1, m2, m3) STATIC
DIM regs(7)
 regs(0) = m0: regs(1) = m1: regs(2) = m2: regs(3) = m3
 CALL INT86(51, VARPTR(regs(0)), VARPTR(regs(0)))
 m0 = regs(0): m1 = regs(1): m2 = regs(2): m3 = regs(3)
END SUB
```

In addition to INT86, the userlib.obj module also contains the INT86X and PTR86 routines. The INT86X routine should be used instead of INT86 when the system call requires segment registers. The PTR86 routine is used to convert the address of a large numeric array variable to a segment-offset value for use with INT86X. Access to the software interrupts adds tremendous flexibility to BASIC programs. However, care should be taken since BASIC does no error checking on interrupt calls.

For more information on the products and features discussed in the newsletter,  
**write to:** Microsoft Languages Newsletter  
 16011 NE 36th Way, Box 97017, Redmond, WA 98073-9717  
**Or phone:**  
 (800) 426-9400. In Washington State and Alaska,  
 call (206) 882-8088. In Canada, call (416) 673-7638.

Microsoft is a registered trademark of Microsoft Corporation.

#### Latest DOS Versions:

|                           |      |
|---------------------------|------|
| Microsoft C Compiler      | 4.00 |
| Microsoft COBOL           | 2.10 |
| Microsoft FORTRAN         | 3.31 |
| Microsoft Macro Assembler | 4.00 |
| Microsoft Pascal          | 3.31 |
| Microsoft QuickBASIC      | 2.00 |

Look for the Microsoft Languages Newsletter every month in this publication.

IBM PC or a compatible. It would be best if we could operate the solenoids from within BASIC. Can you offer any suggestions?

FRANK BELL  
College Station, TX

Some boards available for the IBM PC for control and instrumentation applications may satisfy your needs. These generally won't drive solenoids directly but can be buffered with transistors or solid-state relays as appropriate. A couple of sources are

Analog Devices  
P.O. Box 280  
Norwood, MA 02062  
(617) 329-4700

Burr-Brown  
P.O. Box 11400  
Tucson, AZ 85734  
(602) 746-1111

Metrabyte Corporation  
440 Myles Standish Blvd.  
Taunton, MA 02780  
(617) 880-3000

It is also fairly simple to use a printer

port to control your solenoids, if you can get by with eight channels. The output lines should be connected to latches or flip-flops to hold the solenoids on, since the printer ports are set up to output short pulses. You could use one line to signal the latches when to turn on or off or use the flip-flop to alternately turn the solenoid on or off each time it receives a signal.

The method for doing this in BASIC is to do LPRINT CHR\$(n), where n is the series sum ( $X_i \cdot 2^i$ ) for  $i=0$  to 7 and  $X_i$  is 0 or 1, depending on whether solenoid number i is to be turned on. For example, if solenoids 0 and 2 are to be switched, you would send CHR\$( $1 \cdot 2^0 + 0 \cdot 2^1 + 1 \cdot 2^2 + 0$ ) or CHR\$(5) (binary 0000101).—Steve

**BOOTING PROBLEMS**

Dear Steve,

I recently purchased Orchid Technology's PCTurbo 186 board and an AST multifunction card for my IBM PC XT-compatible machine. When I boot the machine with both cards in it, I get a "bad checksum" error from the PCTurbo 186 board. The boards work fine on their own.

I have tried everything I can think of, including removing the game ports and changing the direct memory access channel. Have you any idea what might be the problem?

Also, why won't the 80186 work with the 8087 on the PC motherboard?

PERUEZ BHATHENA  
Dammam, Saudi Arabia

I talked to Howard Pitchon at Orchid Technology about your problem. He says that the most likely cause is a conflict between the printer interrupt on the multifunction card and the interrupt used by the PCTurbo 186.

The PCTurbo 186 board uses IRQ 7, which is normally assigned to the printer. There is little software on the market that uses the printer interrupts, so you probably won't have any trouble if you disable it. (And you'll surely have none if you don't have a printer connected to the port!)

There may be a jumper on the multifunction card that disables IRQ 7. If not, you will have to cut the trace that connects the circuitry to pin B21 on the

(continued)

**AC/FORTRAN™**

The most powerful FORTRAN 77 compiler available for a personal computer.

AC/FORTRAN is a full feature, mainframe quality, ANSI FORTRAN 77 compiler. It generates position independent, directly executable native object code and includes: a full screen **Debugger, Linker, Library manager, Runtime Library, IEEE math**, interface to **C, VAX** extensions and the ability to generate assembler source. There is no limitation on code or data size; support for **Complex numbers, Virtual arrays, and Overlays** is provided. AC/FORTRAN requires only 46K of RAM, works with hard drives and is not copy protected. All of the following versions of AC/FORTRAN are source compatible.

- MacFortran V2.2** — HFS compatible. Includes full support for mouse, windows and toolbox. Distributed by Microsoft as MS FORTRAN for Macintosh. \$295
- MacFortran/RL** — Replacement Hardware Runtime library for MacFortran (MS FORTRAN) V2.1 and later. Version available for NS32081 or the HyperDrive 2000 with MC68881. \$149
- MacFortran/020** — Professional Series: includes all the features of MacFortran (MS FORTRAN) PLUS full support for 68020/68881 upgrades such as Levco's Prodigy 4. \$495
- Amiga** — Includes full support and special documentation for ROM interface. \$295
- Amiga/020** — Professional Series: includes all the features of AC/FORTRAN plus full support for CSA's 68020/68881 Turbo Amiga. \$495
- Atari ST** — Includes full support and special documentation for GEM. Runs on all 520/1040 series machines. \$199.95

Telephone orders welcome

**abs:ft**

4268 N. Woodward, Royal Oak, MI 48072 USA  
(313) 549-7111 Telex 235608



MS and Microsoft are trademarks of Microsoft Corp.; VAX is a trademark of Digital Equipment; Macintosh is a trademark licensed to Apple; Amiga is a trademark of Commodore; Atari and ST are trademarks of Atari Corp.; MacFortran, MacFortran/RL, MacFortran/020, and AC/FORTRAN are trademarks of Absoft Corp.

We have 1000's of Software and hardware items in stock. Shipments on almost all items within 24 hours!



Call for programs not listed

Technical & Other Info. (602) 246-2222

**TOLL-FREE ORDER LINE 1-800-421-3135**

**FREE! UP TO \$100 SOFTWARE FREE!**

With every purchase over \$100.00 you can select one of the following MS/DOS diskettes at no charge. Please indicate choice(s).

1. Blueberry I - 54 basic utility programs includes printer select, graphic generation, etc. **Retail value \$10.**
2. Blueberry II - includes a banner generator, a label maker and a checker game (requires graphics card). **Retail value \$10.**
3. Print Select program - Assembly language program to select different type fonts, etc., or make your printer function as a correctable typewriter - perfect for envelopes, notes, etc. Adaptation modules for popular printers included and capability to adapt any printer. **Retail value \$40.**
4. Deposit Program Compiled DBase to list and total cash, check, bank card for bank deposit and keeps history - Developed for our corporate use - Super Program! (source code available). **Retail value \$40.**

Select an additional diskette for every additional purchase of \$150 or purchase over \$500 and receive all four at no charge.

**---DATA BASE MANAGERS---**

|                            |                |
|----------------------------|----------------|
| Clipper                    | \$334          |
| Clout 2                    | 117            |
| Condor III                 | 310            |
| Fox and Geller Quickcode   | 138            |
| Fox and Geller Quickreport | 138            |
| Knowledgeman II            | 285            |
| Nutshell Filer             | 59             |
| Powerbase 2.2              | 212            |
| PFS: File                  | 78             |
| Q&A                        | Call for price |
| RBase 5000                 | 247            |
| Think Tank                 | 92             |
| Wordtech DBase 3 compiler  | 419            |

**---WORD-PROCESSING---**

|                            |      |
|----------------------------|------|
| Easy (Micro Pro)           | 88   |
| Leading Edge w/Merge/Spell | 75   |
| Microsoft Word 3.0         | Call |
| Multimate 3.31             | Call |
| Multimate Advantage        | Call |
| Peachtree 5000             | 145  |
| PFS: Write                 | 78   |
| Volkswriter 3              | 139  |
| Webster Spell Checker      | 37   |
| Word Perfect 4.1           | 195  |
| Wordstar                   | 162  |
| Wordstar Propac            | 233  |
| Wordstar 2000              | 233  |
| Wordstar 2000+             | 278  |

**---SPREADSHEETS---**

|                     |      |
|---------------------|------|
| Microsoft Multiplan | 108  |
| PFS: Plan           | 78   |
| Supercalc 4         | Call |
| VP Planner          | 49   |

**---ACCOUNTING---**

|                            |      |
|----------------------------|------|
| BPI Accounts Payable       | 299  |
| BPI Account Receivable     | 299  |
| BPI General Accounting     | 299  |
| BPI Payroll                | 299  |
| Cyma                       | Call |
| Dollars and Sense          | 94   |
| Tobias Managing Your Money | 94   |

**TCS. Big Four equivalent of Peachtree Series 4** - Specially augmented and customized for your IBM PC Terminal and Printer - GL, AR, PA, AP, CP/M-80, CP/M-86 for PC XT, DOS 1.1, 2.0.  
Each Module \$65 For All Four \$249

**---INTEGRATED---**

|                |      |
|----------------|------|
| Enable         | Call |
| Smart Software | Call |

**---TRANSFER PROGRAMS---**

|                   |      |
|-------------------|------|
| Crosstalk XVI     | \$89 |
| Hayes Smartcom II | 88   |
| Microsoft Access  | Call |
| Move-It           | 79   |
| Remote            | 89   |

**---GRAPHICS---**

|                            |     |
|----------------------------|-----|
| Chartmaster                | 205 |
| Energraphics 2.0           | 289 |
| Fancy Font                 | 129 |
| Fontrix                    | 99  |
| Freelance                  | 197 |
| Graphwriter/Combo          | 294 |
| Microsoft Bus Mouse        | 107 |
| Microsoft Flight Simulator | 28  |
| PC Mouse W/DR Halo II      | 106 |
| Printshop                  | 33  |
| Signmaster                 | 134 |

**INCREDIBLE VALUE!**

Nationally advertised boards for IBM PC and most compatibles at giveaway prices. **1 year warranty**

|                                                                                                                                                                                                                        |      |
|------------------------------------------------------------------------------------------------------------------------------------------------------------------------------------------------------------------------|------|
| Keyboards (similar to 5151)                                                                                                                                                                                            | \$89 |
| Monochrome Board w/Printer Port                                                                                                                                                                                        | \$79 |
| Graphic Board with parallel port (similar to Hercules Graphics)                                                                                                                                                        | \$85 |
| Expansion Board 0 to 576K                                                                                                                                                                                              | \$42 |
| Multifunction Board w/game port (similar to AST Six Pack)                                                                                                                                                              | \$99 |
| Four Drive Floppy Controller                                                                                                                                                                                           | \$45 |
| Color Card without printer port                                                                                                                                                                                        | \$79 |
| Color Card with printer port                                                                                                                                                                                           | \$89 |
| <b>MULTITECH Turbo</b> IBM Compatible Computer 256K, dual drives, 8MHz, Ports-parallel, -serial-clock, 5151 type keyboard, graphics board (similar to Hercules), mono monitor, DOS 3.1 6 month national (TRW) warranty | Call |

**---LANGUAGES---**

|                           |      |
|---------------------------|------|
| Lattice C Compiler 3.0    | Call |
| Run C Professional        | 135  |
| Microsoft C Compiler      | 219  |
| Microsoft Fortran         | 195  |
| Microsoft Macro Assembler | 84   |
| Microsoft Pascal Compiler | 166  |
| Microsoft Quick Basic     | 55   |

**---UTILITIES---**

|                      |     |
|----------------------|-----|
| Carbon Copy          | 115 |
| Copy II PC           | 19  |
| Copy II PC Board     | 79  |
| Copywright           | 42  |
| Desqview             | 59  |
| Direct Access        | 59  |
| Fastback             | 85  |
| Microsoft Windows    | 56  |
| Norton Utilities 3.1 | 49  |
| PC Tools             | 19  |
| Prokey 4.0           | 72  |
| Superkey             | 39  |

**---PROJECT MANAGEMENT---**

|                    |      |
|--------------------|------|
| Microsoft Project  | 219  |
| Super Project Plus | Call |

**HARDWARE**

**---HARD DRIVES---**

|                                      |      |
|--------------------------------------|------|
| Bernoulli 20 MB 1/2 ht. w/Controller | 2077 |
| Filecard 20 MB                       | 555  |
| Seagate 20 MB Internal w/Controller  | 399  |
| Seagate 30 MB w/Controller           | 479  |

**---MODEMS---**

|                        |      |
|------------------------|------|
| Hayes 1200             | Call |
| Hayes 1200B w/Software | Call |
| Hayes 2400             | 599  |

**HARDWARE**

|                             |       |
|-----------------------------|-------|
| U.S. Robotics Courier 2400  | \$359 |
| U.S. Robotics Password 1200 | Call  |

**---RAM---**

|                                  |         |
|----------------------------------|---------|
| 64K 150NS Chips (Japan-Set of 9) | \$10.50 |
| 256K Ram Chips (Set of 9)        | 27      |

**---BOARDS---**

|                                          |      |
|------------------------------------------|------|
| AST Advantage                            | 329  |
| AST Sixpack (384K)                       | Call |
| Hercules Color Card                      | 145  |
| Hercules Graphics Card                   | 299  |
| J RAM III (Tall Tree)                    | Call |
| J RAM III AT (Tall Tree)                 | Call |
| J Lazer (Tall Tree)                      | Call |
| Paradise Five Pak                        | 99   |
| Paradise Modular Graphics Card           | 249  |
| Quadram Board with Par/Ser and Game Port | 199  |
| Quadcolor I                              | 185  |
| Sigma Maximizer Multifunction            | 149  |
| STB Chauffeur Board                      | 249  |
| STB EGA Plus                             | Call |
| STB Mono Board                           | 155  |
| AB Parallel Print Switch w/cables        | 75   |
| Mini Micro Parallel Print Buffer         | 69   |
| IBM 135 Watt Power Supply                | 59   |

**---COMPUTERS---**

|                                                                |      |
|----------------------------------------------------------------|------|
| Corona PC                                                      | Call |
| Sperry PC Mono 256K Dual Drive Serial Port, Clock, MS/DOS 2.11 | Call |

**ABBOTT TURBO PC**

IBM Compatible Computer, 4.77 MHZ or 7.47 MHZ, AT style keyboard, 640K, dual drive, 135 watt power supply ..... 620  
or with 20 MB Seagate Harddrive .. 975  
6 month limited warranty

Sharp Portable ..... Call

**---PRINTERS---**

|                                         |      |
|-----------------------------------------|------|
| <b>CITIZEN</b>                          |      |
| MSP-10                                  | 285  |
| MSP-15                                  | 385  |
| MSP-20                                  | 325  |
| Citizen 120D                            | 185  |
| Premiere 35 Daisywheel                  | 469  |
| <b>CANNON Laser</b>                     | 1939 |
| <b>EPSON</b> - Call on all models       |      |
| <b>NEC</b>                              |      |
| 8850                                    | 1098 |
| P5 Parallel                             | 870  |
| P5 XL                                   | 1098 |
| Elf 360                                 | 398  |
| <b>OKIDATA</b> - Call on all models     |      |
| <b>PANASONIC</b>                        |      |
| 1091                                    | 235  |
| 1092                                    | 299  |
| 1592                                    | 435  |
| KXP3151                                 | 399  |
| <b>STAR MICRONICS</b> - Call for prices |      |
| <b>TOSHIBA</b>                          |      |
| P351                                    | 969  |
| P341                                    | 768  |

**---MONITORS---**

|                  |                |
|------------------|----------------|
| <b>AMDEK</b>     | Call for price |
| Multitech RGB    | 259            |
| NEC Multi Sync   | 544            |
| Samsung TTL      | 72             |
| Taxan 121 Green  | Call           |
| Taxan 122 Amber  | Call           |
| Princeton Max 12 | 159            |

**TERMS:** Add 3% for C.O.D. orders. Shipping on most software is \$5.00. AZ orders +6.7% sales tax. Personal check - allow fourteen (14) days to clear. Prices are subject to change. We accept purchase orders from authorized companies. All returns are subject to a restock fee. We do not guarantee compatibility.

No Charge for MasterCard or Visa



**TOLL-FREE ORDER LINE 1-800-421-3135**  
**WAREHOUSE DATA PRODUCTS**  
2701 West Glendale Ave. • Phoenix, AZ 85051

Hours 7 A.M. to 5:30 P.M. M.S.T. - Mon. thru Fri.  
Saturday 10:00 A.M. to 3:00 P.M.

card's edge connector. First try the jumper, then resort to surgery if it still fails.

To locate B21, lay the multifunction card down with the ICs underneath (the solder traces on top) and the edge connector pointing toward you. Count edge-connector contacts starting from B1 on the left near the mounting bracket: pin B21 is the twenty-first contact. Use a sharp knife or an awl to scrape a gap in to the printed circuit trace coming from

the pin; be careful not to damage any other traces, but be sure to cut through completely.

I doubt that the DMA channel is a problem, but you should try both allowed settings to see what happens. Start with the default of direct memory access channel 3 after you modify the multifunction card. Remember that you have to tell the software which DMA channel is being used. The details for that are in the instructions, and I suspect that you're

already familiar with them.

Howard also mentions that game adapters have given some trouble in the past, so you may want to remove that option if you can. When you get things working without it, you can try installing it again to see if it contributed to the troubles.

The Pcturbo 186 board does not use any of the PC's RAM space, so removing RAM chips won't solve any of the problems. Do make sure that you've got the multifunction card's switches set to indicate the starting address at 256K bytes and six installed banks with a length of 384K bytes when you reinstall the RAM chips.

The reason that the 80186 on the Pcturbo 186 board can't use the 8087 on the PC's system board is, sad to say, because the PC wasn't designed to have a complete computer system on an I/O card! The original IBM PC was intended to have the "computer" part (the 8088 and 8087) on the system board and the "I/O" part (printer ports and the like) on the cards. IBM didn't include the circuitry that would allow the Pcturbo 186 board to connect to the 8087, so you won't get any benefit from an 8087 when you're running the Pcturbo 186 board.

If your programs include 8087 support, you might want to find out which version is faster: 8087 running on the PC or non-8087 running on the Pcturbo 186 board. The results may be surprising!  
—Steve

**COMPUTER GENERATIONS**

Dear Steve,

What were the first five generations of computers, and what would you imagine might be the next five?

What role do you see virtual devices playing throughout these generations?

RICHARD WILLIS  
Palma de Mallorca, Spain

*It all depends on how you count, but the first five computer hardware generations seem to be*

1. Electromechanical calculators
2. Vacuum tube computers (mid 1940s to late 1950s)
3. Transistor computers (early 1960s to mid 1960s)
4. Integrated circuit computers (late 1960s to mid 1980s)
5. VLSI computers (mid 1980s onward)

The popular use of the term "Fifth Generation Computers" comes from the Japanese effort to produce machines that are much easier to use and capable of

(continued)

# We Beat The Systems.

Display Telecommunications Corporation was named Best Small Business Exporter in Texas for 1986 because we offer the best IBM® PC clone available. We offer state-of-the-art components and our service reps are always accessible to answer your questions. Beat the systems with DTC.

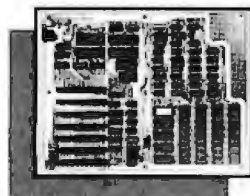

**MEGA-BOARD-XT™**  
The Industry Standard

**MEGA-BOARD-AT™**  
80286 CPU

**MEGA-NET™**  
Token-Passing Ring LAN • IBM NETBIOS Compatible

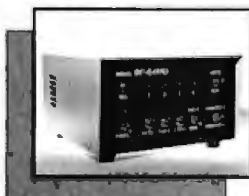

**MULTIPLE INPUT/ DUAL OUTPUT SWITCHING BUFFER**  
4 Computers In—2 Printers Out • Automatically routes Computer to Printer • Internal Buffering 64K or 256K

**OEM QUANTITY PRICING AVAILABLE ON REQUEST**

|                   |        |
|-------------------|--------|
| XT Bare Board     | 59.95  |
| XT Assembled 256K | 299.95 |
| Mega-Case         | 69.95  |
| Mega-Kit          | 775.00 |
| DTC-2 BIOS        | 99.95  |
| Power Supply      | 89.95  |
| Switching Buffer  | 399.00 |

**BIOS licensing.**

IBM is a registered trademark of International Business Machines Corporation.



**MEGA-KIT™**  
Motherboard 256K • Case • 130W Power Supply • (2) 1/4 Height Floppy Disk Drives with Controller • Keyboard

**BARE-BONES MEGA-KIT™**  
Same as Mega-Kit but without floppy Disk or Controller

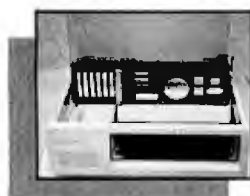

**MEGA-CASE™**  
Flip Top (requires a power supply with a switch in the rear)

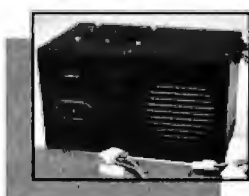

**POWER SUPPLY**  
130 Watt • Rear Power Switch

**Display Telecommunications Corporation**

8445 Freepoint Parkway • Suite 445 • Irving, TX 75063  
1-800-227-8383 • For Technical Calls Only: 1-214-929-1382  
TELEX 5106000176 DTC UD

# "Information Is The Next Frontier"

Michael B. Shane  
Chairman, Leading Edge World Trade, Inc.  
and Leading Edge Products, Inc.

## ACCESS INFORMATION\*



The Leading Edge Model "D" comes complete with more standard features than most others list as options. It's IBM®-compatible, it comes with a 15-month warranty and when configured with a single drive is priced at \$1345.00. A dual disk-drive version and a 30MB Fixed-drive version of the Model "D" are also available.



The Leading Edge Model "L" Series 1200B Modem fits in full or half-size slots of the Leading Edge Model "D"™, "M"™, and "MH"™; the IBM PC, AT, and IBM compatibles. It's Hayes®-compatible, yet at \$149.95 is priced at about a third the price of Hayes' equivalent.



Electronic data bases like the Source™, CompuServe™, and 2,500 others, give you instant access to information on just about every topic under the sun. (Access charges vary.)

If you were to buy a Leading Edge® Model "D"™ Personal Computer and plug into it a Leading Edge® Model "L" Series™ Modem, you'd have created one of the most powerful information gathering and processing tools ever to sit on a desktop — for \$1495.

### How Powerful?

Think about instant access to current and historical financial quotes, up-to-the-minute news on all topics, detailed statistics on companies, industries, or even the entire economy.

Think about instant access to information on topics like medicine, law, finance, real estate, politics, farming, and automotive repair — to name only a few.

Think about having immediate access to documented information on every subject from astrology to zoology.

Just think about what you could do with all that information; think of how profoundly it could improve your life.

Now, stop thinking about it and call **1-800-USA-LEAD** for more information and a Leading Edge Dealer near you. For our Fortune Fleet Division, call **1-800-457-7286**.

\*To obtain a copy of the Leading Edge Corporate Philosophy on Information, please write to this address.

**Leading Edge Hardware Products, Inc.**  
225 Turnpike Street  
Canton, MA 02021  
In MA, (617) 828-8150. Fortune Fleet Division (617) 769-8050

Inquiry 197



Leading Edge and Logo are registered trademarks of Leading Edge Products, Inc. Model "D", "M", M-H, Model "L" Series, and Information System are trademarks of Leading Edge Products, Inc. IBM is a registered trademark of International Business Machines Corporation. Hayes is a registered trademark of Hayes Microcomputer Products, Inc. The Source is a service mark of Source Telemarketing Corporation, a subsidiary of the Readers Digest, Inc. CompuServe is a service mark of CompuServe Information Services, Inc.

# MEET DISTINGUIS

*3 paper feeding controls,  
plus paper-saving  
push/pull tractor feed.*

*Diagnostic self-test  
signals errors with  
flashes and beeps.*

*Go off-line to change  
type styles and modes  
without lengthy  
software commands.*

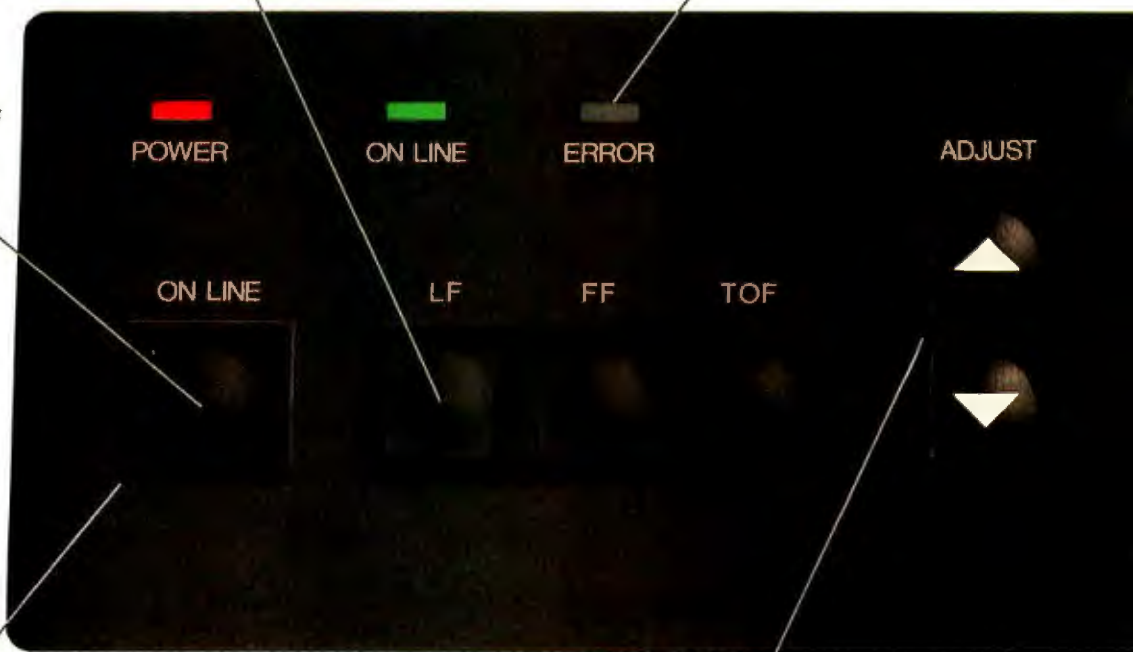

*12 pushbuttons  
to control printing  
functions.*

*Lets you feed paper  
line-by-line, by 1/216-inch  
increments, or continuously.*

This could be the most intelligent group of buttons ever assembled.

You'll find them on the front of every Alps Dot Matrix Printer. And you'll use them to do something most printers can't.

Everything.  
Just push a

button on our front panel. You can change type styles and print modes,

load paper automatically, reprint data stored in the print buffer, even override your software to do things it can't.

All while using your PC for other work at hand.

But of course, Alps printers are more than a bunch of buttons.

They're fast. The new P2100™ prints drafts at an amazing 400 cps, the

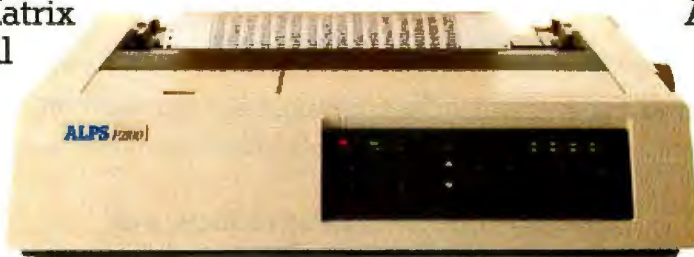



# OUR FIELD PANEL.

*Clears print buffer  
of data without  
printing it.*

*17 LEDs indicate  
functions in operation.*



*Choose three  
almost amazing  
P2000 speeds:  
250 cps draft,  
125 cps memo,  
or 50 cps letter  
quality. Price: \$995.*

*Automatically reprints data  
stored in print buffer  
(4K expandable to 256K).*

*Select font cartridges,  
printing modes, print  
itches and spacing  
quickly and easily.*

*Choose three amazing  
P2100 speeds: 400 cps  
draft, 200 cps memo,  
or 80 cps letter quality.  
Price: \$1595.*

P2000™ at an almost amazing 250 cps.

They're versatile. They print everything from letters and graphs to six-part forms and 16-inch-wide spreadsheets. And they run with all the most popular PCs and software.

Best of all, they're reliable.

Because Alps printers are among the most solidly built at any price. In fact, with normal care, they'll run five years or more without a breakdown. And their precision-engineered print-

head will deliver over 200 million characters of superb output.

So don't just get a printer that does a lot of work. Get one that doesn't interfere with yours.

An Alps.

For our brochure and name of our nearest dealer, call (800) 828-ALPS. In CA, (800) 257-7872.

We'll show you how to push all the right buttons.

**ALPS**  
AMERICA



## Let Lab Boss™ turn your IBM PC into a powerful instrument controller.

You can spend thousands of dollars for a dedicated instrument controller.

Or a few hundred for a controller that's dedicated to you and your IBM PC.

Lab Boss™ from National Instruments puts you and your IBM PC (or compatible) firmly in charge of GPIB instruments. From sophisticated laboratory equipment, like digitizing oscilloscopes and spectrometers, to standard printers, plotters, tape drives and more. At data transfer speeds

that are the highest in the industry.

And Lab Boss products offer a direct data link from your measuring equipment to a full range of analysis software, including RS/1, Lotus 1-2-3, and Symphony. So you can easily report your findings on the same system you used for

instrument control, data acquisition and analysis. Try that on a dedicated controller! So — you want to be the boss? Call National Instruments. 800/531-4742.



**NATIONAL INSTRUMENTS**  
12109 Technology Blvd.  
Austin, TX 78727 512/250-9119

handling much more difficult problems than the current generation. It's not clear how software generations should be counted, but this list seems reasonable:

1. Machine language binary programs (not even assembly language!)
2. Assembly language programs
3. FORTRAN, ALGOL, and similar high-level languages
4. Application-specific languages and simple AI
5. Programs capable of reasoning in the real world

Particularly with respect to the hardware generations, it seems that each one took us quite by surprise. So beyond speculating on the likelihood of bioelectronics and three-dimensional circuitry, I'm willing to be surprised like everyone else. One thing is certain, though: The software is the hardest part of the job!

I don't think that virtual devices are related to particular computer generations. A virtual device is simply a sub-program that translates a standardized I/O device command set into the specific commands required by a particular I/O device. For example, a virtual device interface to two different graphics displays would allow a single program to run unchanged on either one: Only the virtual device code would be changed.—Steve

### CIRCUIT CELLAR FEEDBACK

#### PROGRAM CONVERSION

Dear Steve,

I built the scrolling alphanumeric display you described in the April 1984 Circuit Cellar, and it worked great using the Z8 board. However, I no longer have use of the Z8 board. I do, however, have an Apple II computer at my disposal. I was wondering if it is at all possible to convert the Z8-BASIC system controller assembly language instructions for use by the 6502 microprocessor on the Apple II.

If you could provide me with some help in converting these programs, I would be more than grateful.

JAVIER PELAYO  
Los Angeles, CA

The Z8671 microprocessor used in the Z8 controller and the 6502 used in the Apple II have completely different architectures and instruction sets. Because of this, a one-to-one translation of the assembly language source listing is im-

(continued)

# MARK WILLIAMS' C

Those who insist on C compiler performance  
are very big on Mark Williams.

And the compiler is just part of our total C Programming System.

NEW 3.0  
ENHANCEMENTS

These and other powerful utilities now included in the C Programming System:

- make: compiles only what's necessary from multiple modules, a powerful programming discipline
- diff: identifies differences between two files
- m4: macroprocessor expression editing and substitution
- egrep: extended pattern search
- MicroEMACS: full screen editor with source

#### COMPILER FEATURES

- Runs under MS-DOS
- Full Kernighan & Ritchie C with recent extensions including void and enum
- Register variables for fast, compact code
- Full UNIX™ compatibility and complete libraries
- 8087 Support
- One-step compiling
- English error messages
- ROMable code
- Large and small memory models
- MS-DOS linker compatibility
- Linker, assembler, archiver
- Extensive third party library support

#### csd C SOURCE DEBUGGER

- Debugs at C source level without assembly language
- Separate evaluation, source, program and history windows
- Can execute any C expression
- Capabilities of a C interpreter, but runs in real time
- Set trace points on any statement or variable

New!  
C for the  
Atari ST.  
\$179<sup>95</sup>  
Call for  
features.

Mark Williams' C compiler has earned a place in some very big companies for some very good reasons: it proves the benchmarks right with the speed, code density, consistent performance and expert support required in professional development environments.

But a total development tool shouldn't stop with compiling. Or go on and on with extras that add up and up.

Only Mark Williams' C Programming Systems *includes* the csd C Source Debugger with true source level debugging to speed your programming job.

And only Mark Williams' new 3.0 version *includes* utilities like "make" to make quick work of even the largest projects.

From source code to final product, only one takes you all the way: Mark Williams' C Programming System. All for only \$495. Ask about our 60-day money back guarantee when you call

**1-800-692-1700 to order today.\***

You'll be big on the total C Programming system from Mark Williams, too.

 Mark  
Williams  
Company

1430 West Wrightwood  
Chicago, Illinois 60614

© 1985 Mark Williams Company  
UNIX is a registered trademark of Bell Labs.

\*In Illinois call 312-472-6659.

# Accidental File Erasure Can Be Fatal.

It's no secret. Thousands of business and home users have turned to existing file recovery programs to "save their posteriors" when a file has been erased by accident—and met disaster! After-the-fact procedures just can't assure success every time. Finally, there is a revolutionary new file recovery system which can do the job, *SafetyNet™* from

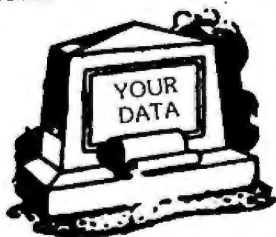

Westlake Data. When you erase a file, it disappears from your directory but not from your grasp. Your data is safe and secure, ready to be recovered whenever you desire. The recovery of your file is assured regardless of the time span between erasure and recovery! This unique approach sets a new industry standard for file recovery programs.

## SafetyNet™

FOR FLOPPY AND HARD DISK SYSTEMS  
catches your file erasure mistakes  
even before you do!

You don't lose data every day. But when you do, you want it back—and you want it back NOW. With *SafetyNet™* three easy steps lead to INSTANT FILE RECOVERY:

- 1) Type "SN" at the > prompt,
- 2) Select the files you wish recovered by highlighting the file and pressing the "space bar", and 3) Press the "Enter" key. That's all you need to do!! Your data will be back at your finger tips in seconds!

## SafetyNet™

From The Creators of *PathMinder™*

Revolutionary New File Recovery System  
For the IBM PC and Compatibles

**49<sup>95</sup>** plus \$5 shipping and handling NOT COPY PROTECTED

Contact your dealer or call  
(800) 628-2828 ext. 555



**WESTLAKE DATA CORPORATION**

P.O. Box 1711

(512) 474-4666

Austin, Texas 78767



DON'T BOOT UP WITHOUT US!

Dick Hodgkins  
President

### CIARCIA FEEDBACK

possible. With some 6502 assembly language experience, it should be possible for you to create a program for the Apple that will permit it to control the scrolling display. You need three output bits: data, clock, and clear. It would be easy to use the "annunciator" outputs on the Apple's game controller socket for this purpose.

The following are some books that give full explanations of the workings of the annunciators:

*Sather, James.* Understanding the Apple II (Quality Software, 1983)

*Gayler, Winston D.* The Apple II Circuit Description (Howard W. Sams, 1983)

Several good Apple II and 6502 assembly language programming books are available. These can provide the information you need to create your program. Two of these books are

*De Jong, Marvin L.* Apple II Assembly Language (Howard W. Sams, 1982)

*Leventhal, Lance.* Assembly Language Programming: 6502 (Osborne/McGraw-Hill, 1979)

—Steve

### PEOPLE DETECTION

Dear Steve,

I want to improve a home-lighting control system I installed in 1980. One of my requirements is to control the level of lighting in one of our rooms.

I currently use six reflector spots at regular intervals around the walls to give plenty of light where it's required. At about half power, the lamps give adequate illumination for background purposes, but for reading you need to bring the lamp closest to where you are sitting to full power.

My problem is correctly detecting the location of a person. Movement detection would have to be very sensitive if you are sitting still reading. Similarly, body heat detection would also need careful calibration to avoid permanently illuminating a radiator. Also, any scanning system would have to be quiet in operation, since the whir of a rotating scanner would be most annoying.

I have even considered installing floor-pressure switches under the carpet. If you have any suggestions, I would be pleased to hear them.

RODERICK SPARKSFIELD  
Sandy, Bedfordshire, United Kingdom

One of the best methods for detecting people in a room is to use infrared motion detectors. These are commonly used

(continued)

# Mark Williams

Now the biggest name  
in C compilers comes in a size  
everybody can afford.

Let's C.<sup>™</sup>  
\$75

Introducing Mark Williams' \$75 C compiler. Want to explore C programming for the first time? Or just on your own time? Now you can do it in a big way without spending that way. With Let's C.

This is no little beginner's model. Let's C is a powerful programming tool, packed with all the essentials of the famous Mark Williams C Programming System. The one chosen by Intel, DEC, Wang and thousands of professional programmers. The one that wins the benchmarks and the reviewers' praise:

**Mark Williams Let's C**

- For the IBM-PC and MS-DOS
- Fast compact code plus register variables
- Full Kernighan & Ritchie C and extensions
- Full UNIX<sup>™</sup> compatibility and complete libraries
- Small memory model
- Many powerful utilities including linker, assembler, archiver, or one-step compiling, egrep, pr, tail, wc
- MicroEMACS full screen editor with source
- Supported by dozens of third party libraries
- Upgradeable to C Programming System for large scale applications development

**Let's C Benchmark Done on an IBM-PC/XT, no 8087.**  
Program: Floating Point from BYTE, August, 1983.

Exec Time in Seconds

|         |        |
|---------|--------|
| Let's C | 134.20 |
| MS 3.0  | 347.45 |

*"Let's C is a thoroughly professional C environment loaded with tools and programming utilities. It is also another fine Mark Williams Co. product."*

—Christopher Skelly, *Computer Language Magazine*, Feb. 1986

And now for more big news. Get our revolutionary csd C Source

Debugger for just \$75, too. You can breeze through debugging at the C source level ignoring clunky assembler code.

Use this coupon or charge by calling toll-free:  
1-800-MWC-1700. In Ill. call 312-472-6659.

**ORDER NOW! 60-DAY MONEY BACK GUARANTEE!**

**Mark Williams Let's C**

Please send me:

\_\_\_\_\_ copies of Let's C and \_\_\_\_\_ copies of csd (C Source Debugger) at \$75 each. (Ill. residents add 7% sales tax.)

Check    Money Order    Visa, MasterCard or American Express

Name \_\_\_\_\_

Address \_\_\_\_\_

City \_\_\_\_\_ State \_\_\_\_\_ Zip \_\_\_\_\_

Card # \_\_\_\_\_ Exp. Date \_\_\_\_\_

Signature \_\_\_\_\_ BY096



**Mark  
Williams  
Company**

1430 West Wrightwood  
Chicago, Illinois 60614

# ZBasic™

The **FASTEST, EASIEST, MOST POWERFUL BASIC EVER!**

**Amazing New Advance—ments for an Old Friend.**

ZBasic is an incredibly advanced and powerful BASIC—but—it's still the old BASIC you're used to. Instead of spending 6 months of your life learning another complicated language, let ZBasic put your programs into light-speed, now! (If you know BASIC, you know ZBasic.)

**How Fast is ZBasic?**

Lightening fast. Four years of intense development have produced the ultimate BASIC. ZBasic is "Compiled BASIC," and generates stand-alone applications that make any other BASIC completely obsolete. Just look at these speed comparisons.

| Macintosh™       | Apple IIe, IIc            |
|------------------|---------------------------|
| ZBasic™ 7.4 sec  | ZBasic™ 486 sec           |
| MSBASIC™ 684 sec | AppleBASIC™ 5,401 sec     |
| IBM® PC™         | Z-BASIC™ (IBM) 110.20 sec |
| ZBasic™ 13.7 sec | ZBasic™ 30 sec            |
| BASIC™ 2,180 sec | MSBASIC™ 2,550 sec        |

10 iterations of the Steve test by Steve, January, 1983

**Compiler Speed/Interpreter Ease.**

Like a BASIC interpreter, ZBasic allows you to write and execute your programs immediately! No messy "Linkers," "Loaders," or clumsy "Subroutine Packages" like most other compilers. To compile and edit, simply type "RUN." Debugging works the same as the interpreter, too. Just type "BREAK" or "CTRL C" to get back to the editor.

**Lightning-Fast Compilation.**

Computer Language Magazine says, "Compilation is amazingly fast..." After typing "RUN," ZBasic compiles your program at blinding speed—40 lines per second.

**Works the Same on All Computers.**

If you're tired of throwing away your old programs everytime you switch to a new computer, ZBasic is for you. Source code is portable from one computer to another, and since ZBasic uses Device Independent Graphics and Disk File commands, your programs automatically "Adapt" to any other computer. And the ZBASIC editor is the same on all versions—regardless of the computer.

**Einstein Math.**

ZBasic offers programmers a math package that surpasses anything else in the industry! (Yes, ZBasic is even better than FORTRAN, PASCAL, MODULA-2 or any other language available!) You will have up to 54 digits of user-selectable accuracy at your power.

**"Superb Documentation!"**

"The 387 page ZBasic manual is a model of clarity and organization. The documentation is superb, solidifying our impression that someone worked incredibly hard to make ZBasic a benchmark for all other BASIC Compilers."

PC WEEK, Nov. 12, 1985

**Easy Structure—If You Want It.**

ZBasic helps you "Structure" your programs in a way that's easy and simple... you may use GOSUB or GOTO with names or line numbers. Supports multi-line LONG IFs and LONG FNs. LIST programs with—or without—line numbers! ZBasic automatically indents loops and structures in LISTings, too.



**ZBasic Users Say:**

"As awesome! It's about what Great Unbelievable!" **J.R. CPA, Seymour, MO**

"...fast, generates stand alone programs, requires only modest amounts of memory, has outstanding compilation speeds and...was bug free and felt solid. And the price is very attractive." **Bruce W. Turkin, COMPUTER LANGUAGE**

"ZBasic is a powerful offering for BASIC programmers. It provides the flexibility of Turbo Pascal and the speed of compiled BASIC, all at a price that can't be matched. Kudos to Zedcor and to all users who make wise decisions to use ZBasic to the fullest." **Garry Ray, PC WEEK**

"The best I have ever seen, I love it! You should be proud of this product." **R. R. Manager, Mesa, AZ**

"Mind-blower! Easily the best BASIC I've ever seen!" **J. G., Baltimore, MD**

**Versions shipping now!**

- Macintosh, Apple IIe - IIc (128K & DOS 3.3) • IBM PC and MSDOS 2.1 & Compatibles • Kaypro Graphics version (CPM-80) • CP/M-80, 2.0 or greater (280 only) • TRS-80 Model 1/3, Model 4/4 •

**Customized for YOUR Computer:**

**MSBASIC™ and Compatibles:** Including PC, XT, AT, y... Turbo™ 120-1300-2000-3000 and all Compaq™ C-series last stand-alone COM files. Supports a mouse, highlights keywords and lots more.

**Macintosh™:** Complete Toolbox ROM calls support, creates 68000 Hexide Code, Macintosh and AppleLink support, program size to 4 megabyte, math accuracy from 8 to 240 digits. Incredible program speeds!

**Apple™ IIe, IIc:** Mouse support for both the IIe and IIc. Super Hi-Res graphics support (500x150 and 280x150 and Hi-RES support too). Advanced Graphics commands like CIRCLE, BOX, FILL, etc. and you can Mix Graphics and Text on the screen like a PC. DOS 3.3 support (PRODOS coming this summer). Requires Apple IIe or IIc with 128K but programs created with ZBasic™ will run on a 64K Apple II •

**Z80™ Microtower CP/M™ 2.0 • TRS-80™ model 1, 3 or 4 and a special graphic version for Kaypro CPM**

**ONLY ZBASIC GIVES YOU THESE FEATURES:**

- Highlights errors...makes debugging easy!
- Not Copy Protected
- Never any Royalties or Runtime fees for programs you sell.
- Direct commands (Speeds logic testing like an interpreter)
- Super Single-Step debugging
- CHAIN with variable passing. (Share all or some worksheets)
- Create intransparent subroutines and functions
- Multi-line LONG IF, multi-line LONG FNs (argument passing)
- Defmac, HEX, DEC or BINARY support.
- Device-independent Graphics and File I/O.
- Never does String "Garbage Collection"
- Comes with "Quick" and "Slow" sort routines
- Built in "HELP" screen lets you get answers fast.
- Long variable name (18 characters)
- Long: WHILE-WEND, DO-UNTIL, FOR-NEXT-STEP
- Serial Port and Modem support
- Easily load your old BASIC programs saved in ASCII

in security and alarm systems and are quite sensitive. They work by dividing the area in their view into a series of discrete slices and then monitoring the infrared level in each slice. When a moving warm body disturbs the normal pattern that the detector sees, it trips a relay. It does not take a great deal of motion to trigger the detector, depending on where it is located.

In your situation, you could try using several detectors, each one aimed at the area that you want it to control. I don't know what type of system you are using to control your lights, but I'm sure that you could find a way to interface the detectors to your system.

I am currently using a number of these detectors around my home to control lighting. They are connected to my Home Run Control System (April to June 1985 BYTE). When one of the detectors sees motion, HCS senses it and turns the light or lights on. As long as someone remains in view of the detector, HCS keeps resetting the time-out. When the person leaves the room, HCS will turn the lights off.—Steve

**PROPERTY PROTECTION**

Dear Steve,

Some time ago, I believe you mentioned a company that provides property-protection devices. I am looking at the Home Run Control System, and I would like to use this company's passive infrared motion detectors. Can you give me the name of this company?

**WILLIAM P. DRESCHER  
Lansing, MI**

The company is

Mountain West  
P.O. Box 10780  
Phoenix, AZ 85064-0780  
(800) 528-6169

Its catalog contains a variety of security devices and reference books. Several application notes for the various devices are also included.—Steve ■

Over the years I have presented many different projects in BYTE. I know many of you have built them and are making use of them in many ways.

I am interested in hearing from any of you telling me what you've done with these projects or how you may have been influenced by the basic ideas. Write me at Circuit Cellar Feedback, P.O. Box 582, Glastonbury, CT 06033, and fill me in on your applications. All letters and photographs become the property of Steve Ciarcia and cannot be returned.

# POWER COMPILER

**\$89<sup>95</sup>** ORDER TOLL FREE:  
**1-800-482-4567**

Technical Support: (602) 795-3996  
or Use Our Coupon on Facing Page  
(Please specify brand or model)  
or write to us at Zedcor, Inc.  
4500 E. Speedway, #93  
Tucson, AZ 85712

# ZBasic™ The Ultimate BASIC development system for your Macintosh™



## Let ZBasic™ Unleash the Power of Your Macintosh™

Accelerate your BASIC program! Compare ZBasic™ to C, Pascal, FORTRAN and other BASICs:

| SIEVE BENCHMARK* (100000)    | Run Time | Compile** Time |
|------------------------------|----------|----------------|
| ZBasic™ Interactive Compiler | 7.0      | 10.            |
| Softworks™ BASIC Compiler    | 520.0    | 20.            |
| True BASIC™ Compiler         | 132.0    | 10***          |
| MS-BASIC™ 2.1 Interpreter    | 654.0    | 0.             |
| Softworks™ C Compiler        | 8.8      | 445.           |
| Aztec™ C Compiler            | 6.5      | 240.           |
| MS™ FORTRAN Compiler         | 6.6      | 180.           |
| TML™ Pascal Compiler         | 6.6      | 120.           |

\*10 iterations of Sieve benchmark from Byte, Jan. 1985. TML speed from MacUser, June 1986. C speeds from Byte, Nov. 1985 (non-regular). MS-FORTRAN speed from MACHORLD, June 1986. Softworks BASIC time from MacUser, June 1988.  
 \*\*Compile time when in stand-alone application. IBM data not used.  
 \*\*\*True BASIC™ program was not a stand-alone double-click application. This requires an optional (5000) runtime module. Compile time was faster than interactive mode.

## Lightning-Fast Compilation

"Compilation is so fast that execution is indistinguishable from a BASIC interpreter."  
 As reviewed in BYTE, May 1988

## Create Double-Click Programs

ZBasic creates fast, stand-alone (double-click 68000 native code) applications easily with no royalties or runtime fees for your programs.

## "Superb Documentation"

"The 387 page manual is a model of clarity and organization. The documentation is superb, solidifying our impression that someone worked incredibly hard to make ZBasic a benchmark for all other BASIC compilers."  
 As reviewed in PC Week, Nov. 1985  
 (The new 620 page manual is even better)

## Standard Features

- Highlights Errors
- No royalty/runtime fee
- Auto indents structures
- Single Step debug
- Fast string processing
- Use both serial ports
- No garbage collection
- Device Ind. graphics
- Not Copy Protected
- Multi-line FN and IF
- Line numbers or labels
- Chain programs
- SORT source included
- Load old programs saved as text files
- Device Ind. File IO

## Ultimate Math Accuracy

The MAC version of ZBasic gives you 8 to 240 digits of configurable BCD precision (no binary rounding errors). In addition, a High-Speed SANE Floating Point option will be available late summer for \$59.95 (fixed binary single and double precision).

## A Portable Language

Designed as a "portable language," ZBasic is available on many popular computers including: IBM® (MS-DOS®) and compatibles, CPM®-80, Apple® IIe, IIc and TRS-80™. This allows you to easily create programs to work on many other machines.

## Designed for Mac Programmers

In addition to the hundreds of commands provided with "Standard ZBasic"—this version provides lots of extras.

- AppleLink™ Network commands
- MacLink™ (with English or Phonemes)
- Modern and Printer serial port commands
- Enhanced Integer range of 1,2,147,483,647
- From 8-240 digits of configurable BCD Accuracy
- Over 400 QuickDraw & TOOLBOX commands
- Memory management (SEGMENT) commands
- MOS EDITOR included (licensed from Apple®)
- RMaker™ included (licensed from Apple®)
- Interactive Commands and Edit Windows
- Works with HFS, MFD and all hard disks

## SOME OF THE SPECIAL MAC COMMANDS

|               |              |            |
|---------------|--------------|------------|
| DIALOG ON     | DIALOG OFF   | DIALOG (N) |
| ON DIALOG     | EDIT FIELD   | EDIT%      |
| BUTTON        | MENU ON/OFF  | BUTTON (N) |
| MENU          | APPLE MENU   | EDIT MENU  |
| DEMOUSE       | TIMER        | TIMER OFF  |
| TIMER ON      | ON TIMER (N) | MOUSE ON   |
| MOUSE OFF     | MOUSE (N)    | ON MOUSE   |
| FILES         | SOUND        | BEEP       |
| EJECT         | OPEN TALK    | TALK       |
| SCROLL BUTTON | FINDERINFO   | EXPERT     |
| WATCH OFF     | WINDOW CLOSE | WINDOW     |
| ALERT WINDOWS | HELP WINDOWS | SEGMENT    |

## GRAPHICS ENHANCEMENT

|                      |                                   |
|----------------------|-----------------------------------|
| COORDINATE           | COORDINATE WINDOW                 |
| GET and PUT          | CLIPBOX (←→)←→, test, zoom, etc.) |
| PICTURE              | PICTURE CHOP                      |
| PEN (x,y)←→, pattern | TEXT font, size, face, mode       |
| SCROLL               | LCOPY and PAGE LPRINT             |
| CLIPBOARD LOAD       | CLIPBOARD SAVE                    |

## PRINT TEXT OR GRAPHICS TO YOUR LASERWRITER™ OR IMAGewriter™

|               |                       |
|---------------|-----------------------|
| CLEAR LPRINT  | DEF PAGE              |
| DEF LPRINT    | ROUTE (SCREEN)        |
| COORDINATE    | COMPLETE TEXT CONTROL |
| FRHANDLE      | PRGCANCEL             |
| LPRINT% (x,y) | LPRINT% (x,y)         |

Available NOW for the  
**512K Macintosh™ and Macintosh Plus™**

Send me the Ultimate BASIC Development system for the Macintosh

Price: \$89.95 + shipping.

Shipping: in U.S. \$5 (C.O.D. add \$5)  
 Canada \$12-Foreign \$25-\$U.S. only (no C.O.D.)

Visa-Mastercard-American Express

Signature  Exp.

Mail to: **Zedcor Inc.**  
 4500 E. Speedway, Suite 93  
 Tucson, Arizona 85712  
 Tech Support: (602) 795-3996

MS, True BASIC, Softworks, Aztec, TML, IBM, etc., are trademarks of their respective companies. Macintosh is a trademark licensed to Apple Computer Inc. ZBasic is a trademark of Zedcor Inc.

## Review Quotes

"Fast, generates stand-alone programs, requires modest amounts of memory, and has outstanding compilation speeds."  
 Bruce W. Tonkin  
 As reviewed in COMPUTER LANGUAGE

"ZBasic is extremely fast and accurate... In most cases, compilation is so fast that execution is indistinguishable from a normal BASIC interpreter start-up."  
 TJ Byers  
 As reviewed in BYTE

"ZBasic is a powerful offering for BASIC programmers. It provides the flexibility of Turbo Pascal and the speed of compiled BASIC, all at a price that can't be matched. Kudos to Zedcor..."  
 Garry Ray  
 As reviewed in PC WEEK

"Without question, ZBasic is one of the best BASIC compilers... ZBasic's compiler is fast... conclusion, if you like to program in BASIC, buy ZBasic. If you don't like to program in BASIC, buy ZBasic."  
 Jim Baldrige  
 As reviewed in HARVEST  
 (Newsletter for the Northern Texas Computer Society)

"ZBasic is unquestionably an excellent implementation of the language... [and] comes with one of the best user manuals in the industry."  
 James McKelvey  
 As reviewed in INCIDER

30 day Money-Back Guarantee  
 Not Copy Protected

ZBasic™ is available from Better Computer and Software Stores everywhere...

Or Call Toll Free to Order  
**800-482-4587**

# In\*a\*Vision "a marvelous little CAD system"

Listen To What The Critics Are Saying About In\*a\*Vision

## PC Week

September 1985

"Stands out from the crowd." "It has the makings of a winner."

## InfoWorld

February 1986

"In\*a\*Vision is very easy-to-learn and easy-to-use."

## PC Magazine

March 1986

"Fast, accurate and fun to use." "Excellent template system."

## Computer Buyers Guide

March 1986

"A remarkable value." "Fast and easy to learn."

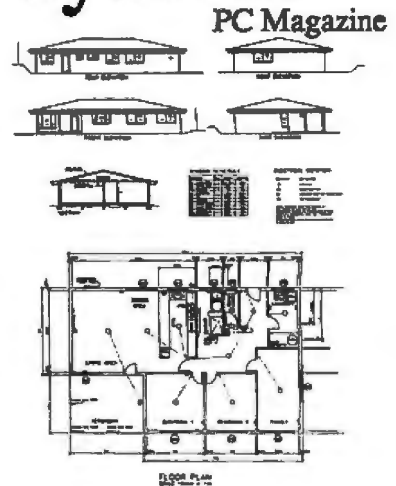

**P**ower. Versatility. Ease. All of these add up to performance. And performance is what In\*a\*Vision is all about.

### Power!

"What surprised us was how fast In\*a\*Vision works."

PC Magazine

"Even complex command sequences are generated with lightning speed."

"This is arguably the first piece of software that fully utilizes the power of the AT."

Computer Buyers Guide

"The spooling mechanism is a real timesaver."

PC Magazine

"The system is ideal for the kind of fine detail work that engineers, draftsmen and designers demand."

Computer Buyers Guide

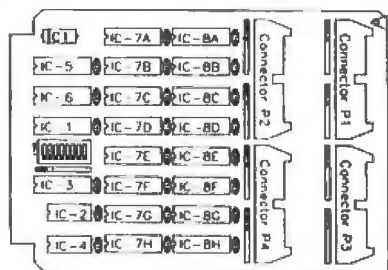

### Ease!

"An hour with In\*a\*Vision and even the most devoted MAC fan will be a convert."

PC Magazine

"The program is quickly mastered; intuitive quickness is what this system is all about."

"The program's ease-of-use and speedy execution allow you to concentrate on design..."

Computer Buyers Guide

"In\*a\*Vision is so easy to learn that its menu bar will tempt you to begin using it without even reading the documentation."

"The program's use is intuitive."

InfoWorld

**Order Now!**  
**1-800-272-3729**

Yes, I want to improve my CAD performance with In\*a\*Vision.  
Please send me \_\_\_ copies at \$495 each.

I enclose:  Check  Money Order

Credit Card:  Visa  MasterCard

American Express

Name \_\_\_\_\_

Company Name \_\_\_\_\_

Address \_\_\_\_\_

City \_\_\_\_\_

State \_\_\_\_\_

Zip \_\_\_\_\_

Country \_\_\_\_\_

Credit Card No. \_\_\_\_\_

Exp. Date \_\_\_\_\_

Send to: MICROGRAFX, Inc.  
1820 N. Greenville Ave.  
Richardson, TX 75081  
In Texas: 214-234-1769

Runs with or without Microsoft Windows on two-floppy or hard disk IBM PC or compatible with 320K; hard disk and 512K recommended.

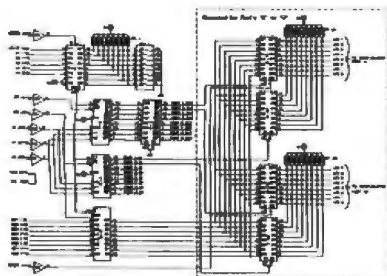

### Versatility!

"In\*a\*Vision's text provisions are flexible and impressive."

This advertisement was created with In\*a\*Vision and output at 300 DPI.

**MICROGRAFX**  
The Picture of Success



# B·O·O·K R·E·V·I·E·W·S

## AMIGA PROGRAMMER'S HANDBOOK

Eugene F. Mortimore  
Sybex  
Berkeley, CA: 1986  
529 pages, \$24.95

TECHNICAL TOPICS  
FOR MOTOROLA  
MC68000-BASED  
MICROCOMPUTERS:  
An Annotated  
Bibliography of  
Recent Books

## AMIGA PROGRAMMER'S HANDBOOK

Reviewed by  
Gregg Williams

Many people find the Commodore Amiga interesting because of its tremendous processing power. Unfortunately, very little of that power is accessible without the proper computer program. Because of this, many users of a new machine like the Amiga are hungry for the detailed technical documentation that unlocks the computer's capabilities. Although the official Commodore seven-book technical reference set was available much sooner than is usual for a new computer, at \$100 it is expensive for the interested (but not professional) user. The quality and price of Eugene F. Mortimore's *Amiga Programmer's Handbook* make it a good buy for such people, but it isn't a substitute for the full reference set.

### ORGANIZATION

The *Amiga Programmer's Handbook* is essentially an overview of the Amiga as seen from the programming point of view. After a brief explanation of needed background information about program development (register usage, include

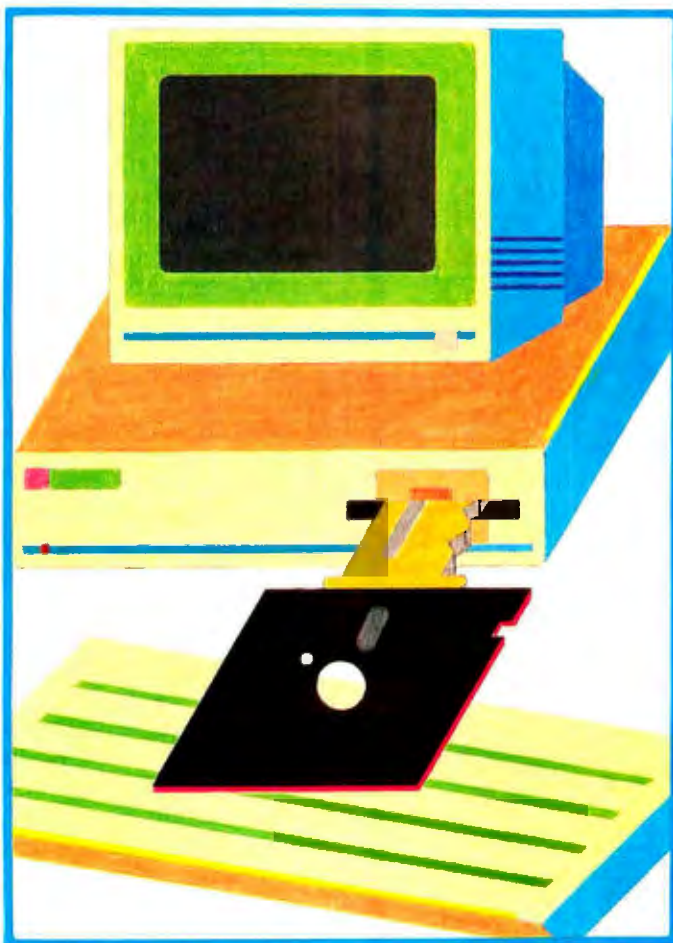

files, and structures), Mortimore presents seven chapters, each of which covers a class of functions: the Exec functions (resource management), graphics display and drawing, animation, text, Layer functions (which manipulate Amiga "screens"), Intuition (the user interface), and Workbench (the Amiga's operating environment).

Each chapter is structured like the book itself—an overview describing important concepts followed by detailed information. Within the chapters, the detailed information is a collection of alphabetized entries covering all the software routines designed for programmers' use. (These names—like AreaDraw, SetSoftStyle, and SetDMRequest—are important because they are called by name in whatever language you are using to develop a program.)

Each entry follows the same format: the syntax of the function, a description of its purpose, descriptions of all its inputs, and a discussion section that describes the context of the function's use. This last section contains useful information that is not in the Amiga reference books. It begins by listing all the other related functions in the chapter; for example, the discussion of AreaDraw lists the other five functions that manipulate areas. It then describes the context in which the function is used, sometimes listing other functions that must be called, suggesting alternative methods, and warning of possible pitfalls. The entries are usually between one and two pages long.

The book ends with two appendixes, a glossary of terms, and some notes on advanced video topics (the dual-play-

*(continued)*

# MAKE YOUR PC CLONE A GOOD INVESTMENT!

Your PC represents a substantial investment, so it does not make sense to risk costly downtime or system failure due to the use of a so-called "BARGAIN" power supply.

At Fortron we insist on quality and reliability. That's what has earned us a UL rating. For your complete satisfaction we offer a one-year warranty and full technical support.

**200 WATTS  
PC AT  
\$189.00**



**MEETS  
FCC CLASS B**

**150 WATTS  
PC XT  
\$129.00**



- U.L. Recognized
- Meets FCC Class B requirements
- 115/230 VAC, selectable
- OVP, OCP short circuit protection
- Power failure signal
- All U.S. made connectors provide better connection to drives and CPU board
- Meets European safety specs
- 100% burn-in & pre-shipment test, one full year warranty
- Direct replacement for original IBM® power supplies
- FARADAY® type pin-out available upon request

## PC EXPANSION CHASSIS

Provides easy expansion to your PC, PC XT, Tandy 1000™, Compaq Portable™, Compaq Desk Pro™, and other PC clones by having extra expansion slots for video controllers, disk drives or I/O boards.

**FC 640 ... \$388.00**

- 5 slot mother board
- 100 w power supply
- Capacity for 3 drives
- 15 1/2" x 12" x 6 1/4"



**FC 650 ... \$398.00**

- 8 slot mother board
- 150 w U.L. reg. power supply
- Capacity for 4 drives
- 19 1/4" x 15" x 5"



**FC 660 ... \$438.00**

- 12 slot mother board
- 100 w power supply
- Capacity for 2 drives
- 15 3/4" x 15 1/4" x 15 1/4"



\*Prices above include system interface adaptors

## SPECIAL OFFER

- **20 MB hard disk drive** with controller and cables **\$385.00**
  - **20 MB internal tape back-up** with controller, cable and software **\$545.00**
- (Special prices valid with expansion chassis purchase only.)

### FORTRON CORPORATION

3225 Seldon Court Fremont, CA 94538  
 Telex: 559291 FORTRON

Orders Only: (800) 821-9771  
 In Calif: (415) 490-8171  
 Technical Service: (415) 490-8403

Compaq Portable: Desk Pro™/ Compaq Corp.  
 IBM™/I.B.M., Tandy 1000™/Tandy Corp.

field, double-buffering, hold-and-modify, and extra-half-bright modes).

### STRENGTHS AND WEAKNESSES

As an intermediate C programmer with some knowledge of the Amiga's internal details, I am beginning to appreciate the way Mortimore organized functions and cross-references. Although I still have to go to the reference manuals to get detailed information, I am often at a loss as to what information I need and where to find it. This book's dictionary-like organization and thesaurus-like cross-referencing of related functions gave me a much-needed overview. The Discussion section includes the sort of hard-earned practical observations and advice that reference books lack.

The *Amiga Programmer's Handbook* was the first technical book published by a source outside Commodore-Amiga (others have appeared since then), and the rush to publish first has affected this book, although not as adversely as it does most such technical books. On the positive side, this book seems to be far more accurate (technically and grammatically) than most early books and many other books; I've found only one or two typographical errors and no technical ones so far. One serious drawback, however, is that the book contains no figures and only a few examples, both of which are sorely needed (they are present in the most recent version of the technical reference set).

Because it is not a seven-volume set, the *Amiga Programmer's Handbook* necessarily summarizes some important concepts and leaves others out entirely. That's not a fault, but you need to be aware of it. The book points out that much of the missing information is documented in the include files that come with your assembler or C compiler. This is true—every serious Amiga programmer should print and read the Intuition include file (include.h for C, include.i for assembly language).

Another, more serious weakness is an omission: Mortimore makes no mention of devices (the word used to describe the mechanism by which the Amiga interacts with various hardware components). This means that the book offers no insight into (among others) the audio subsystem, the keyboard, the "console" (video text output) device, the game ports (mouse and joystick interface hardware), the serial and parallel ports, the "narrator" device (which handles Amiga's human-speech output), and the printer-driver software.

A final criticism, reported by a Commodore Amiga technical person, is that the book mixes information from both versions 1.0 and 1.1 of the Amiga Workbench. (Yet another version, 1.2, may be out by the time you read this.) Although I have not seen any examples of this during my use of the book, I'm sure they're there—so be warned, and double-check with the official Amiga documentation.

I said earlier that you couldn't develop Amiga software with this book alone. Actually, by studying the include files and several of the numerous C source code files in the public domain, you could get by with just this book, but

(continued)



# PANASONIC® PRINTERS. THEY'RE GENERATING A LOT OF GOOD PRINT.

The good reviews keep rolling in. And, as you can see, the critics agree: Panasonic printers are real winners!

But that shouldn't come as too big of a surprise. After all, Panasonic printers offer the advanced features and ease-of-use you've come to expect from Panasonic.

So, whether your business is big, small or in-between, you'll find a printer with features to love every bit as much as the critics. Like—as one

...y had. ...their ...  
Panasonic machines are well made, sturdy  
various applications for which they were de-  
signed. ...  
letter-quality text. About the  
be so...

PC WEEK—JUNE 17, 1986

with this little printer.  
As far as I'm concerned, the KX-P1091  
produces not near letter quality but rather  
true letter quality in this mode. You'd real-  
ly have to strain to distinguish it from type-  
writer quality. Knowing that the person  
... the company produced fast, courteous,  
and knowledgeable answers.

PC—SEPT. 17, 1985

reviewer observed—extraordinary near-letter-quality on our dot matrix models. They also come standard with impressive high-resolution graphics capability. So you can add graphs, charts, illustrations—even your company's logo.

Not to be outdone, all our daisy wheel printers give you sophisticated advances like boldface, shadow and underline.

Of course, we've put just as much care into the

human side of our printers, too. You'll find switches and buttons that let you change print sizes and styles right on the printer rather than through the computer. And, with our continuous, self re-inking ribbons, you'll find yourself changing ribbons less often. When you do, our snap-in cartridge makes it a snap.

...the  
KX-P3151. It is a well-built product  
that promises to deliver many hours of  
trouble-free operation. The print qual-  
ity is clear and well-defined. The align-  
ment of characters on adjacent lines is  
also excellent, a sign of a well-designed  
paper and printwheel transport system.

Finally, just when you thought all this would be hard to top, there's more: all our printers are backed with an unprecedented two-year limited warranty.

Now that you've reviewed all of this for your- self, call toll-free 1 (800) PIC-8086 for the name

ed. / ...  
... 30.1 pounds. Like all the Pan-  
asonics we tested at, the 1592 comes  
with the company's exceptional two-  
year warranty. And like all of them, it  
definitely rates a look.

of the  
dealer  
nearest  
you.  
You'll  
see how  
easily

PRINTERS BUYERS GUIDE & HANDBOOK #3

Panasonic printers generate good print for you. And, you'll agree: **THE EASIER, THE BETTER.**

**Panasonic**  
Office Automation

# STATISTICAL PACKAGES

Complete, high-performance  
data-analysis software from:



**StatSoft™**

**Unbeatable power and flexibility for  
unbeatable prices!**

1. **STATS-2™** (release 2.1): A complete, superfast statistical package. Can also be used as a statistical supplement for Lotus 1-2-3™ and other spreadsheet programs. Runs on IBM™ and compatibles, 256k, 2dd, 8087 support ..... **\$149**
2. **STATFAST-2™** (release 2.1): The most powerful statistical package developed for the Macintosh™ 128k/512k/Plus, 1dd..... **\$119**
3. **APP-STAT™**: A complete statistical package for the Apple II™ family of computers, 1dd ..... **\$99**
4. **PSYCHOSTAT-3™**: A complete statistical package, available for Kaypro™ and all CP/M™ computers, 1dd ..... **\$99**

All of these statistical packages are user friendly and super-easy to use. They include the full range of basic statistical analyses (descriptive statistics, t-tests, correlations, cross-tabulations, nonparametric statistics, and much more) and advanced multivariate statistics (comprehensive multiple regression with forecasting, general multifactor ANOVA/ANCOVA up to 5 factors including a covariate, repeated measures, contrasts, unbalanced designs, and more). All packages can handle **data files of unlimited size**, include flexible Data Editors with complex transformations and complete data-base management functions, and can access data files from spreadsheets, data-bases, and mainframes.

Ask for our statistical packages for other computers.

**TO ORDER:** Send check, credit card number, or money order (plus \$5 shipping and handling) to:



**StatSoft™**

2832 EAST 10TH STREET, SUITE 4, TULSA, OK 74104  
(918) 583-4149



To order by phone (Visa, MasterCard, C.O.D. orders accepted) or talk to our technical staff for more information, call (918) 583-4149.

STATSOFT STATSOFT logo STATS 2 STATFAST APP-STAT PSYCHOSTAT 3 LOTUS 1 2 3 IBM  
Macintosh Apple II Kaypro and CP/M are trademarks of respective companies

it would be like trying to use a one-disk computer—you can do it, but it's a lot of extra work.

## CONCLUSION

The *Amiga Programmer's Handbook* is an accurate, well-organized reference book for the Amiga's internal software, though it omits needed material about the software interface to several input and output devices. It doesn't offer the technical depth you'll sometimes need, but it provides several kinds of contextual information that the manuals don't. It is nevertheless a useful addition to an Amiga technical library.

*Gregg Williams is a senior technical editor at BYTE who worked on the Amiga cover story (August 1985). He can be reached at BYTE, One Phoenix Mill Lane, Peterborough, NH 03458.*

## TECHNICAL TOPICS FOR MOTOROLA

### MC68000-BASED MICROCOMPUTERS:

#### An Annotated Bibliography of Recent Books

Compiled by Donald Evan Crabb

Observing the progress of the Motorola MC68000 processor chip, I felt that a survey of some of the current books on the subject was needed. By eliminating monographs and manuals, I focused on four areas: 68000 technical references, Macintosh 68000 programming references, Macintosh 68000 programming textbooks, and Atari 520ST technical books. The books mentioned below offer current technical information about the MC68000 and its implementation in several computers. This collection reflects my bias and cannot be considered inclusive. All books are softcover unless otherwise specified.

## 68000 TECHNICAL REFERENCES

Cramer, William, and Jerry Kane. *68000 Microprocessor Handbook: Includes 68008, 68010, & 68020*. 2nd ed. Berkeley, CA: Osborne/McGraw-Hill, 1986. \$34.95. 142 pages.

The *68000 Microprocessor Handbook* covers technical criteria of the M68000 processor family with a distinct hardware orientation. It is a functional overview of the microprocessors of the M68000 family, including the MC68020. As such, it leaves out a thorough discussion of the instruction set of the 68000 family, opting instead for a 10-page overview of the more than 300 instructions that make these microprocessors work. William Cramer and Jerry Kane have condensed the instruction set discussion into a general synopsis about the basic format of instructions and their use. Topics familiar to readers of other 68000 books include addressing modes, timing and bus operations, exception processing, and I/O interfacing. The consistent hardware orientation is based on the configuration of the M68000 family and how its architecture and operations can support systems and applications software. As a hardware handbook, the *68000 Microprocessor Handbook*

(continued)

# Powerful MS-DOS™ Software.

For the IBM®-PC, XT, AT & others with generic MS-DOS/PC-DOS 2.0 or higher.

Not copy  
protected!

Only **\$39.95** Each!

## UTAH COBOL™

Whether student, teacher or professional programmer, this is the one you've heard so much about.

- It's easy to use. Compiles 5000 statements on a 128K machine.
- 170 clear error messages, i.e. DATA-NAME IS MISSING OR MISSPELLED.
- Distribute your object code programs royalty free.
- Small object code programs conserve disk space.
- Fast compile times to increase programmer productivity. Over 25 times faster than one compiler costing \$995!
- You get a diskette and 213-page manual with lots of examples and 16 complete COBOL source code programs. **\$39.95.**

Also available: COBOL Application Packages, Book 1 **\$9.95.**

## UTAH PASCAL™

- 14-digit precision, BCD math, no round-off errors with decimal arithmetic for business and floating point + 63 - 64 for scientific.
- A very nice TRACE style debugging.
- Arrays up to 8 dimensions and 64K strings.
- External procedures and functions with dynamic auto-loading.
- One-step compile, no assembly or link required.
- You get a 132-page manual and diskette. **\$39.95**

## UTAH PILOT™

- Perfect for industrial training, office training, drill and testing, virtually all programmed instruction, word puzzle games, and data entry facilitated by prompts.
- John Starkweather, Ph.D., the inventor of the PILOT language, has added a built-in full-screen text editor, and much more.
- Meets all PILOT-73 standards for full compatibility with older versions.
- You get a diskette, 125-page manual and ten useful sample programs. **\$39.95.**

Also still available for 8-bit machines with CP/M® is our world famous Nevada Software Series used by 50,000 customers in 40 countries. These include Nevada COBOL, Nevada FORTRAN, Nevada PASCAL, Nevada PILOT, Nevada BASIC and Nevada EDIT. **\$39.95** each.

Satisfaction guaranteed. If for any reason you're not completely satisfied, just return the package within 15 days in good condition, and we'll refund your money.

IBM is a registered trademark of International Business Machines Corp. CP/M is a registered trademark of Digital Research. MS is a trademark of Microsoft Corp. © 1985 Ellis Computing, Inc.

## UTAH FORTRAN™

- FORTRAN IV based upon ANSI-66 standards.
- Very fast compile times and easy to use.
- IF . . THEN . . ELSE constructs.
- Chaining with blank and named common.
- Copy statement.
- ENCODE and DECODE.
- Free-format input and output.
- A very nice TRACE style debugging.
- 150 English language error messages.
- You get a diskette, and 223-page manual. **\$39.95**

## UTAH EDIT™

- A character-oriented full-screen video display text editor designed specifically to create COBOL, FORTRAN and PASCAL programs.
- Only requires 15K disk space so it can fit on the same disk as your compilers.
- Completely customizable tab stops, default file type, keyboard control key layout and CRT by menu selection.
- Diskette comes with easy to read 58-page manual. **\$39.95.**

## UTAH BASIC™

- This interpreter has a built-in full-screen editor.
- Single- and Multi-line user definable functions.
- BCD Math- no round-off errors.
- Full Matrix operations.
- You get 220-page manual and diskette. **\$39.95.**

Handling/Shipping: No shipping charge within US. Overseas add \$10 for first package, \$5 each additional. Checks must be in US Dollars, drawn on a US bank.

Utah Software requires 128K RAM and PC-DOS or MS-DOS 2.0 or higher.

HOW TO ORDER. Send check or money order to Ellis Computing, Inc. with VISA or MASTERCARD order by phone. Sorry no COD's.



Ellis Computing, Inc.  
5655 Riggins Court, Suite 10  
Reno, Nevada 89502  
Phone (702) 827-3030

SINCE 1977  

**ELLIS COMPUTING™**

- ✓ COMPATIBILITY
- ✓ AFFORDABILITY
- ✓ RELIABILITY
- ✓ EXPANDABILITY

IBM XT/AT COMPATIBLE COMPUTERS BY

✓ **AFTON COMPUTER INC.**

## QUANTUM 286 TURBO

**Made  
In The  
USA**



- IBM AT COMPATIBLE
- PHOENIX BIOS
- 8-10 MHZ SWITCHABLE CLOCK SPEED
- 512K UP TO 1 MB RAM ON BOARD
- 2 SERIAL PORTS 1 PARALLEL PORT ON BOARD
- 20 MB HARD DISK
- 1.2 MB FLOPPY
- 8 EXPANSION SLOTS
- AT KEYBOARD
- 200 WATT POWER SUPPLY
- ONE YEAR WARRANTY

**All For Only \$1995<sup>00</sup>**

## QUANTUM XT TURBO (Made in the USA)

- PHOENIX BIOS
- 4.77-8MHZ SWITCHABLE CLOCK SPEED
- 640K ON BOARD
- SERIAL, PARALLEL AND CLOCK
- AT STYLE KEYBOARD
- 360K FLOPPY
- 135 WATT POWER SUPPLY
- ONE YEAR WARRANTY

**All For Only \$745<sup>00</sup>**

*Quantum XT 4.77 MHz... Call For Pricing*

## AFTON COMPUTER INC. (714) 863-6951

24825 Calle El Toro Grande  
El Toro, California 92630

Customer Service (714) 553-1701  
Telex 756731

Prices and Configurations Subject To Change.

is most useful to experienced microprogrammers and system designers who seek a handy reference manual.

Fortgang, Karen Skrable, ed. *M68000 8-/16-/32-Bit Microprocessors Programmer's Reference Manual*. 5th ed. Englewood Cliffs, NJ: Prentice-Hall, 1986. \$18.95. 240 pages.

This is *the* reference manual for the M68000 processor family (MC68000, MC68008, MC68010, MC68012). It is written by Motorola engineers for anyone interested in serious assembly language programming of the 68000 family. The latest version adds a discussion of the MC68012 extended virtual memory processor to the material presented in the 4th edition. This book will not, however, teach you 68000 assembly language programming. It is strictly a reference for the 68000 family.

The information is straightforward and delivered in the no-nonsense style that is so familiar to readers of electrical engineering texts. The book's audience is narrowly defined—M68000 programmers, system implementers, and computer designers—but readers should find the coverage of the M68000 family's architecture, data organization and addressing, instruction set, microprocessor operations, and exception processing definitive.

Most of the book concentrates on the MC68000, but it also explains the architectural and instruction set differences of the MC68008 processor (8-bit data bus, 20 address bits), the MC68010 processor (virtual memory version of the MC68000), and the MC68012 (extended virtual memory version of the MC68010). The full 32-bit MC68020 processor is mentioned only briefly.

Kelly-Bootle, Stan, and Bob Fowler. *68000, 68010, 68020 Primer*. Indianapolis, IN: Howard W. Sams & Co., 1986. \$21.95. 368 pages.

This Waite Group book bridges the gap between an M68000 processor reference manual and an M68000 assembly language textbook. Coauthored by a recognized computer pioneer (Stan Kelly-Bootle) and a principal in the Alpha Micro User's Society (Bob Fowler), the *68000, 68010, 68020 Primer* is useful to experienced microcomputer programmers who want a quick introduction to the M68000 family. Novice programmers who don't know much about micros (and least of all the 8-bit microprocessors that preceded the M68000 family) will also find the book informative. The authors provide numerous examples of the M68000 instruction set, discussing the purpose of each instruction and its intended use.

Kelly-Bootle and Fowler have chosen a structure that emphasizes familiarity with the basic concepts of the M68000 early on. From there, they accelerate their discussion through the various levels of microprogramming and finally discuss individual differences between processors of the family. They also include several appendixes that cover the M68000 instruction sets and the various addressing modes. The book is filled with useful illustrations and tables and includes a handy tear-out reference card.

(continued)

# THE PROFESSIONAL'S CHOICE

|                                |                         |                                   |                                 |                                        |                                     |
|--------------------------------|-------------------------|-----------------------------------|---------------------------------|----------------------------------------|-------------------------------------|
| Lotus<br>1-2-3<br><b>\$319</b> | Paradox<br><b>\$469</b> | dBase III<br>Plus<br><b>\$389</b> | FrameWork<br>II<br><b>\$389</b> | MultiMate<br>Advantage<br><b>\$269</b> | Word<br>Perfect 4.1<br><b>\$209</b> |
|--------------------------------|-------------------------|-----------------------------------|---------------------------------|----------------------------------------|-------------------------------------|

## Software

### Word Processing Editors

|                        |       |
|------------------------|-------|
| FANCY FONT             | \$139 |
| FANCY WORD             | \$109 |
| FINAL WORD II          | \$219 |
| MICROSOFT WORD 3.0     | \$279 |
| MULTIMATE              | \$219 |
| MULTIMATE ADVANTAGE    | \$269 |
| OFFICE WRITER/ SPELLER | \$239 |
| PFS: WRITE             | \$ 89 |
| SAMNA WORD III         | \$259 |
| THINK TANK             | \$109 |
| TURBO LIGHTNING        | \$ 65 |
| VOLKSWRITER 3          | \$159 |
| VOLKSWRITER SCIENTIFIC | \$259 |
| WORD PERFECT 4.1       | \$209 |
| WORDSTAR 2000          | \$289 |
| WORDSTAR 2000+         | \$259 |
| WORDSTAR PRO           | \$239 |
| KYWRITE III            | \$239 |

### Database Systems

|                          |       |
|--------------------------|-------|
| CLIPPER                  | \$359 |
| CONDOR III               | \$339 |
| DBASE III PLUS           | \$389 |
| KMAN 2                   | \$339 |
| PARADOX                  | \$469 |
| PFS: FILE/REPORT PLEASE! | \$169 |
| O & A                    | \$99  |
| QUICKCODE III            | \$219 |
| QUICKREPORT              | \$159 |
| R BASE 5000              | \$359 |
| REFLEX                   | \$89  |
| REVELATION               | \$499 |

### Graphics

|                    |       |
|--------------------|-------|
| CHARTMASTER        | \$219 |
| DIAGRAM            | \$309 |
| DIAGRAM MASTER     | \$199 |
| ENERGRAPHICS 2.0   | \$339 |
| FREELANCE          | \$209 |
| GEM DRAW           | \$149 |
| GRAPHWRITER COMBO  | \$299 |
| IN-A-VISION        | \$259 |
| MAPMASTER          | \$239 |
| MS CHART           | \$189 |
| PC DRAW            | \$209 |
| PC PAINTBRUSH      | \$ 99 |
| PFS: GRAPH         | \$ 89 |
| PICTURE PERFECT    | \$245 |
| GRAPHICS PRINTSHOP | \$ 49 |
| SIGNMASTER         | \$149 |
| WINDOWS/DRAW       | \$119 |

### Spreadsheets/Integrated Packages

|                          |       |
|--------------------------|-------|
| ENABLE                   | \$349 |
| FRAMEWORK II             | \$389 |
| JAVELIN                  | \$419 |
| LOTUS 1-2-3              | \$319 |
| MULTIPLAN                | \$135 |
| OPEN ACCESS              | \$259 |
| SMART SYSTEM SPREADSHEET | \$439 |
| AUDITOR                  | \$ 99 |
| SUPERCALC 3              | \$209 |
| SYMPHONY                 | \$449 |
| TWIN                     | \$ 79 |

### Network Applications

|                          |        |
|--------------------------|--------|
| DBASE III LAN PAK        | \$639  |
| KMAN 2                   | \$899  |
| MICROSOFT WORD MULTIMATE | \$Call |
| MULTIMATE ADVANTAGE      | \$749  |
| OPEN SYSTEMS R BASE 5000 | \$459  |
| REVELATION               | \$799  |
| SAMNA WORD III           | \$799  |
| WORD PERFECT             | \$450  |

### Desktop Environments

|             |       |
|-------------|-------|
| DESQVIEW    | \$ 69 |
| MS WINDOWS  | \$ 69 |
| GEM DESKTOP | \$ 39 |
| SIDEKICK    | \$ 39 |

### Project Management

|                               |       |
|-------------------------------|-------|
| HARVARD TOTAL PROJECT MANAGER | \$279 |
| MICROSOFT PROJECT             | \$249 |
| PROJECT SCHEDULER NETWORK     | \$339 |
| QUICKNET 500                  | \$539 |
| SUPERPROJECT + TIMELINE 2.0   | \$269 |
|                               | \$239 |

### Communications/Productivity Tools

|             |        |
|-------------|--------|
| CARBON COPY | \$129  |
| CROSSTALK   | \$ 99  |
| PROKEY      | \$ 85  |
| JRAY GOLD   | \$149  |
| REMOTE      | \$109  |
| SMARTERM    | \$Call |
| SMARTCOM II | \$ 99  |
| SUPERKEY    | \$ 49  |

### Statistics

|                       |       |
|-----------------------|-------|
| SPSS/PC+              | \$575 |
| STATGRAPHICS          | \$449 |
| STATPAC GOLD-WALONICK | \$399 |
| SYSTAT-NEW            | \$499 |

### Languages/Utilities

|                                      |        |
|--------------------------------------|--------|
| CONCURRENT DOS COPYWRITE             | \$179  |
| COPYWRITE                            | \$ 45  |
| C86 C COMPILER                       | \$319  |
| FASTBACK                             | \$ 99  |
| LATTICE C                            | \$269  |
| MARK WILLIAMS C MICROSOFT C COMPILER | \$319  |
| COMPILER                             | \$249  |
| MS BASIC COMPILER                    | \$249  |
| MS FORTRAN                           | \$229  |
| NORTON UTILITIES                     | \$ 59  |
| QUICK BASIC                          | \$ 65  |
| SUPERKEY                             | \$ 55  |
| TURBO PASCAL                         | \$ 49  |
| TURBO PROLOG                         | \$ 69  |
| XENIX                                | \$Call |
| ZERBO DISK                           | \$ 70  |

### Accounting

|                            |       |
|----------------------------|-------|
| BPI                        | \$309 |
| GREAT PLAINS               | \$479 |
| IUS EASYBUSINESS           | \$309 |
| ONE WRITE PLUS             | \$159 |
| OPEN SYSTEMS PEACHTREE     | \$409 |
| REAL WORLD                 | \$259 |
| STAR ACCOUNTING PARTNER II | \$399 |
|                            | \$529 |

## Hardware \*

### Multifunction Boards

|                           |       |
|---------------------------|-------|
| AST ADVANTAGE (128K)      | \$349 |
| AST I/O MINI              | \$139 |
| AST MP MINI               | \$199 |
| AST 8 PAK PLUS (64K)      | \$169 |
| AST 8 PAK                 | \$169 |
| PREMIUM (512K)            | \$359 |
| AST RAMPAGE PC            | \$249 |
| AST RAMPAGE AT            | \$459 |
| AST SHORTRAM (0K)         | \$159 |
| GOLD QUADBOARD (0K)       | \$419 |
| INTEL ABOVEBOARD PC       | \$279 |
| INTEL ABOVEBOARD AT       | \$439 |
| INTEL ABOVEBOARD PS (64K) | \$329 |
| JRAM AT-1 (0K)            | \$239 |
| JRAM 3 (0K)               | \$179 |
| ORCHID CONQUEST (0K)      | \$279 |
| ORCHID ECCEL (0K)         | \$399 |
| PC TURBO 286 (1MB)        | \$799 |
| PC TINY TURBO 286         | \$459 |
| QUADBOARD (64K)           | \$139 |
| SILVER QUADBOARD (0K)     | \$219 |

### Display Boards

|                           |       |
|---------------------------|-------|
| GENOA SPECTRUM            | \$239 |
| HERCULES GRAPHICS CARD    | \$199 |
| HERCULES COLOR CARD       | \$159 |
| PARADISE MODULAR GRAPHICS | \$259 |
| QUADRAM EGA+              | \$369 |
| SIGMA EGA 350             | \$379 |
| SIGMA COLOR 400           | \$449 |
| STB EGA PLUS              | \$339 |
| TECMAR GRAPHICS MASTER    | \$399 |
| TSENG ULTRA PAK           | \$429 |
| TSENG ULTRA PAK-S         | \$369 |

### Emulation Boards

|                 |       |
|-----------------|-------|
| AST 5251-11 *   | \$549 |
| AST 5251-12     | \$499 |
| AST BSC         | \$489 |
| AST SNA         | \$599 |
| IRMA            | \$799 |
| SMART ALEC 5251 | \$699 |

### Modems

|                       |       |
|-----------------------|-------|
| AST REACH 1200        | \$359 |
| HAYES 1200            | \$389 |
| HAYES 1200B           | \$349 |
| HAYES 2400            | \$579 |
| HAYES 2400B           | \$549 |
| TRANSET 1000          | \$279 |
| VENTEL 1200 HALF CARD | \$369 |
| VENTEL 1200 PLUS      | \$300 |
| WATSON                | \$339 |

### Mass Storage/Backup

|                                |        |
|--------------------------------|--------|
| IOMEGA 10+10 W/INTFC           | \$1999 |
| IOMEGA 20+20W/INTFC            | \$2599 |
| IRWIN 120D 20MB TBU            | \$599  |
| IRWIN 145AT 40MB TBU           | \$699  |
| MOUNTAIN DRIVECARD 20MB        | \$719  |
| PLUS HARDCARD 10MB             | \$559  |
| PLUS HARDCARD 20MB             | \$719  |
| PRIAM 42MB AT                  | \$949  |
| SYSGEN SMART IMAGE 20 MB (INT) | \$625  |
| TALLGRASS                      | \$Call |
| TECMAR OIC-60AT TBU (INT)      | \$1199 |
| TECMAR OIC-60H (EXT)           | \$1599 |

### Networks

|               |        |
|---------------|--------|
| AST PC NET    | \$Call |
| NOVELL        | \$Call |
| ORCHID PC NET | \$Call |
| 3 COM         | \$Call |

### Monitors

|                   |             |
|-------------------|-------------|
| AMDEK 310A        | \$159       |
| AMDEK 600/722     | \$429/\$339 |
| NEC MULTISYNC     | \$529       |
| PRINCETON HX-12   | \$449       |
| PRINCETON MAX-12E | \$179       |
| PRINCETON SR-12   | \$469       |
| PRINCETON HX-12E  | \$539       |
| PRINCETON HX-9    | \$529       |
| SAMSUNG           | \$Call      |
| TAXAN 122 AMBER   | \$159       |
| TAXAN 630/640     | \$469/\$339 |

### Printers/Plotters

|                    |        |
|--------------------|--------|
| BROTHER TWINWRITER | \$939  |
| DATAPRODUCTS       | \$Call |
| DIABLO 635         | \$1149 |
| EPSON FX-85        | \$399  |
| EPSON FX-286       | \$549  |
| EPSON HI-80        | \$349  |
| EPSON CR-420 I     | \$1569 |
| EPSON LQ-800       | \$589  |
| EPSON LQ-1000      | \$729  |
| HP 7475A           | \$Call |
| NEC 3550           | \$799  |
| OKIDATA 182        | \$249  |
| OKIDATA 192        | \$379  |
| OKIDATA 193        | \$519  |
| OKIDATA 292        | \$539  |
| OKIDATA 293        | \$589  |
| TOSHIBA P321       | \$565  |
| TOSHIBA P341       | \$829  |
| TOSHIBA P351       | \$1069 |

### Input Devices

|                 |       |
|-----------------|-------|
| KEYTRONIC 5151  | \$179 |
| KEYTRONIC 5153  | \$299 |
| MICROSOFT MOUSE | \$129 |
| PC MOUSE/PAINT+ | \$139 |

### Accessories

|                             |        |
|-----------------------------|--------|
| CABLES                      | \$Call |
| CURTIS SURGE PROTECTORS     | \$Call |
| DATASHIELD BACKUP POWER     | \$Call |
| DATASHIELD SURGE PROTECTORS | \$Call |
| GILTRONIX SWITCHES          | \$Call |
| MASTERPIECE PLUS            | \$135  |
| MICROFAZER INLINE BUFFERS   | \$Call |
| 256K RAM SET                | \$ 39  |
| 8087 MATH CHIP              | \$135  |
| 80287 MATH CHIP             | \$199  |

\*CALL FOR SHIPPING COSTS

|                                  |                                          |                                |                                         |                            |                               |
|----------------------------------|------------------------------------------|--------------------------------|-----------------------------------------|----------------------------|-------------------------------|
| NEC<br>Multisync<br><b>\$529</b> | Mountain<br>Drivecard 20<br><b>\$719</b> | Quadram<br>EGA<br><b>\$369</b> | Hayes 1200B<br>1/2 Card<br><b>\$349</b> | J RAM AT-3<br><b>\$239</b> | IRMA<br>Board<br><b>\$799</b> |
|----------------------------------|------------------------------------------|--------------------------------|-----------------------------------------|----------------------------|-------------------------------|

\*CALL FOR SHIPPING COSTS



## LOWEST PRICE GUARANTEE!!

We will match current nationally advertised prices on most products. Call and compare.

free!

Diskette Library Case with your order



# 1-800-221-1260

In New York State call (718) 438-6057

### TERMS

Checks—allow 14 days to clear. Credit processing—add 3%. COD orders—cash, M.O. or certified check—add \$5.00. Shipping and handling UPS surface—add \$3.00 per item (UPS Blue \$8.00 per item). NY State Residents—add applicable sales tax. All prices subject to change.



MON.-THURS. 9:00 AM-8:00 PM  
SUN. & FRI. 9:00 AM-4:00 PM

# Softline

Softline Corporation  
P.O. Box 729, Brooklyn, N.Y. 11230  
TELEX: 421047 ATLN UI  
FAX: 718-972-8346

BYT-1

# HERE'S 118 REASONS AND IS AMERICA'S

**1 LOW PRICES.** Micro Mart specializes in giving you the best value on all your PC product needs.

**2 QUALITY PRODUCTS.** We've got a huge selection of national brand name products. Computer systems, printers, peripherals, supplies and accessories!

**3 FULL SERVICE SALES.** Our friendly, knowledgeable sales staff will help you

choose the right product at the right price.

**4 COMPLETE TECHNICAL SUPPORT.** For pre-sale or post-sale advice, give us a call. We're here to help.

**5 CUSTOMER SATISFACTION.** It's made us famous. Drop in at one of our many store locations or give us a call today.

*Shop us today and save on these specials...*

## **6 ProLine XT**—A complete system for only \$995!

Here's a system value that can't be beat. Features full PC compatibility. 640K RAM memory. One 360K half height floppy drive. Six expansion slots. Monochrome graphics card and monitor. Printer and communications ports. Clock/calendar. Game port. MS DOS with GW BASIC. Enhanced IBM-style keyboard. UL and FCC approved. Full 1 year parts exclusive warranty.



All systems built and tested! Call for custom configurations!

**FREE!**

**With the purchase of our ProLine XT**

This complete accessory pack: 10 pk. DS/DD Maxell Diskettes. SRW Media Storage Case. Six-outlet Curtis power strip with surge protection. Texwipe PC careware kit with antistatic solution and CRT cleaning fluid and wipes. Perfect Data 5¼" drive head cleaning kit. ProLine XT dust cover. Total Retail Value—\$89.95!

## **7 ProLine AT**—Powerful AT performance for only \$2,289!

All the speed and power you need. Features full PC compatibility. 512K RAM memory. 8Mhz processor. One 360K floppy drive. Eight expansion slots. Monochrome graphics card and monitor. Printer port. Clock/calendar. MS DOS.



UL and FCC approved. 90 day exclusive warranty.

All systems built and tested! Call for custom configurations!

**FREE!**

**With the purchase of our ProLine AT**

This complete accessory pack: 10 pk. tpi quad density Maxell Diskettes. SRW Media Storage Case. Six-outlet Curtis power strip with surge protection. Texwipe PC careware kit with antistatic solution and CRT cleaning fluid and wipes. Perfect Data 5¼" drive head cleaning kit. American XT dust cover. Total Retail Value—\$99.95!



# MORE WHY MICRO MART PC SPECIALIST!

## MULTIFUNCTION BOARDS

We have a complete line of Multifunction Boards compatible with the PC, XT & AT and all compatibles.

- 8. SIX PAK 64-384K, multifunction, fully loaded w/384K ..... \$239
- 9. AST I/O MINI I/O shortboard for Portable & AT ..... **New Low Price!**
- 10. ADVANTAGE 128K-3Mb, expansion for AT
- 11. RAMPAGE 64K-2Mb with Deskview ..... **NEW!**
- 12. QUADRAM QUADBOARD loaded, 384K ..... **CALL!**
- 13. QUADRAM GOLDBOARD, 384K ..... \$459
- 14. TECMAR MEGAFUNCTION, 1 Meg of nonvolatile memory ..... \$369
- 15. TALLTREE J-RAM III ..... **CALL!**
- 16. INTEL ABOVE BOARD, PC & AT ..... From \$280
- 17. THEYSYS FASTCARD up to 1 MB ..... From \$235

## GRAPHICS CARDS

- 18. HERCULES Mono & Color Graphics cards ..... **New Low Price!**
- 19. TECMAR Graphics Master, HiRes Color & Mono supports Lotus ..... \$449
- 20. QUADRAM Quadcolor I & II color cards
- 21. QUADRAM EGA, Includes 256K memory ..... \$389
- 22. STB EGA + Mono & Graphics cards also available ..... **CALL!**
- 23. Generic monographic cards ..... From \$99
- 24. SIGMA Color 400 for PG5 SR-12 ..... **New Low Price!**

## FLOPPY DISK DRIVES

- 25. 1/2 HEIGHT Disk Drives from Panasonic, & Teac; 360K &
- 26. 1.2 MEG Floppy drives for the PC, XT, AT and Compatibles ..... From \$99

## HARD DISCS

- 27. IRWIN Tape Back-up systems ..... **Call!**
- 28. SYSGEN Complete line ..... **Call for our special Sysgen pricing!**
- 29. BERNOULLI TECHNOLOGY Hard disc Subsystems (20 & 40 MB) ..... From \$2875
- 30. SEAGATE Fast 20, 30 Meg, for PC & AT ..... **Call!**
- 31. PRIMA Superfast 40 & 60 Meg, for AT ..... **CALL!**
- 32. TALLGRASS 25, Through 80 Meg. Hard drive systems, including 60 Meg. tape back-up
- 33. WESTERN DIGITAL 10 & 20 MB File cards ..... **CALL!**
- 34. Best availability of voice coil and stepper motor hard drives with highest quality controllers ..... From \$495

## SOFTWARE

### ACCOUNTING

- 35. SORCIM/IUS Complete line including windows ..... From \$295/each

### SPREADSHEETS & INTEGRATED PACKAGES

- 36. SORCIM SuperCALC 3, Vers. 2.0 ..... **New Low Price!**

### ENHANCEMENTS & UTILITIES

- 37. NORTON Utilities 3.0 ..... \$69
- 38. ROSESOF ProKey 3.0 ..... \$89
- 39. CENTRAL POINT SOFTWARE Copy II PC ..... \$35
- 40. SOFTSTYLE Set FX+ and Printworks, printer control
- 41. SIDEWAYS Inverts printout ..... \$51
- 42. BORLAND SideKick and SuperKey ..... From \$40
- 43. BORLAND Lightning and Reflex ..... **NEW! CALL!**

### COMPILERS & LANGUAGE TOOLS

- 44. LATTICE C-Compilers ..... \$279
- 45. MICROSOFT Complete line
- 46. MICROSOFT Quick-Basic ..... **New Low Price!**
- 47. BORLAND Turbo Pascale, Turbo Toolbox, & more ..... From \$35/each

### GRAPHICS

- 48. Z-SOFT PC Paintbrush, mouse graphics ..... \$95
- 49. DECISION RESOURCES Diagram Master ..... From \$199
- 50. MICROSOFT Chart ..... **CALL!**
- 51. MICROSOFT Windows ..... **CALL!**

## COMMUNICATIONS

- 52. MICROSTUF Crosstalk XVI, Latest version ..... \$105
- 53. HAYES Smartcom II ..... \$85
- 54. MICROSOFT Access ..... **CALL!**

## WORD PROCESSING

- 55. MULTIMATE Advantage ..... \$294
- 56. MICROSOFT Word, new version ..... **New Low Price!**
- 57. LIFETREE Volkswriter Deluxe, ver 3.0 ..... \$169
- 58. SSI WordPerfect, version 4.1 ..... **New Low Price, CALL!**
- 59. MICROPRO Wordstar Professional series ..... **New Low Price!**
- 60. LEADING EDGE Nutshell ..... \$59
- 61. LEADING EDGE Word Processor ..... \$59

## OFFICE & PLANNING

- 62. HARVARD Total Project Manager ..... \$339
- 63. SORCIM/IUS Super Project ..... \$209
- 64. MICROSOFT Project, vers. 2.0 ..... \$269

## DATA BASE MANAGERS

- 65. Call For Unadvertised Data Base Managers
- 66. MICROIM 5000, Report Writer & Clout ..... **New Low Price!**
- 67. MICROSTUF Infoscope ..... \$99
- 68. D BASE III plus ..... **CALL!**

## NETWORKING PROTOCOL CONVERSION

- 69. SNA & BISYNC 3780, 5251, Mod 11 & 12, 3274, 3278
- 70. PC TURBO 186/187 board, 128K, 8087 Serial Board attached ..... \$875
- 71. IRMA Complete line ..... From \$849

## PRINTERS

### DOT MATRIX

- 72. EPSON FX85/286 ..... **NEW!**
- 73. EPSON LQ800/LQ1000 ..... **NEW PRICES!**
- 74. OKIDATA 192, 193, 292, 293, Pacemark 2410
- 75. TOSHIBA P-341, P-351, & NEW 321 ..... **New Low Prices!**
- 76. NEC New P-5, P-6, & P-7 ..... **Low Price!**

### LETTER QUALITY

- 77. NEC Spinwriters 2050, 3550, 8850 ..... **New Low Prices!**
- 78. EPSON DX20 & DX35 ..... **NEW LETTER QUALITY PRINTERS**

We carry a full range of form handling options.

## CHIPS

- All our chips are tested and priced for quick sale. Call us!
- 79. INTEL 8087, 80287, math coprocessors ..... **Call for Market Price.**
  - 80. 64K-256K RAMCHIPS ..... **Call for Market Price.**
  - 81. 128K Piggy-back chips for your AT ..... **Call for Market Price.**

## MODEMS

- 82. HAYES Smartmodem 300, 1200, 1200B & 2400. We have the best stock in the U.S.A. .... **CALL!**
- 83. VEN-TEL 1200 Baud Half Card w/Crosstalk ..... \$399
- 84. PEACHTREE TECHNOLOGIES P-1200 (Hayes compatible external) ..... \$249

## MONITORS & CRTS

- 85. PGS Max 12(E), HX12, HX12(E), & SR-12 ..... **New Low Prices! CALL!**
- 86. AMDEK Color 600 ..... **CALL!**
- 87. AMDEK 722, New alternative to IBM enhanced monitor ..... \$569
- 88. AMDEK 310 A ..... **CALL!**
- 89. MAGNAVOX Monochrome monitors ..... \$129
- 90. SONY, monitors in stock ..... **CALL!**

## MISCELLANEOUS

- 91. MOUSE SYSTEMS PC Mouse, optical w/software ..... \$139
- 92. MICROSOFT Mouse, bus or serial mechanical ..... **New model in stock! CALL!**
- 93. KEYTRONICS 5151 Keyboards ..... **CALL!**
- 94. KEYTRONICS 5153 Keyboard w/mouse ..... **NEW!**
- 95. GRAVIS Joysticks ..... \$45
- 96. QUADRAM Microfazer print buffer 8-128K ..... From \$129

## DISKETTES

Following items available only in sets of 100 each brand.

- 97. Precision Diskettes by Xidex, SS/DD ..... \$ .65/ea.
- 98. Precision Diskettes by Xidex, DS/DD ..... \$ .69/ea.
- 99. Maxell SS/DD MD1 ..... \$ .99/ea.
- 100. Maxell DS/DD MD2 ..... \$1.25/ea.
- 101. Maxell High Density MD2 ..... \$2.60/ea.
- 102. Maxell 3 1/2 inch SS/DD MF1 ..... \$1.60/ea.
- 103. Maxell 3 1/2 inch DS/DD MF2 ..... \$2.35/ea.
- 104. Fujii SS/DD MD1 ..... \$ .89/ea.
- 105. Fujii DS/DD MD2 ..... \$1.15/ea.

## MEDIA STORAGE

- 106. Flip N File Original, stores fifty 5 1/4" diskettes with free twin pack of Fujii DS/DD diskettes (\$25 retail value) Now 1/2 price ..... \$12.50
- 107. Flip N File, stores 25 5 1/4" diskettes with lock ..... \$12.99
- 108. Flip N File, stores 50 5 1/4" diskettes with lock ..... \$19.99
- 109. Innovative Concepts Data Case ..... \$ 9.99
- 110. Microdex by S.R.W., stores 25 3 1/2" diskettes ..... \$ 9.99
- 111. Microdex by S.R.W., stores 60 5 1/4" diskettes ..... \$11.99

## SURGE PROTECTORS

- 112. Curtis 6 outlet power strip with surge protection ..... \$19.99
- 113. Curtis Diamond ..... \$31.99
- 114. Curtis Emerald ..... \$37.99
- 115. Curtis Sapphire ..... \$49.99
- 116. Curtis Ruby ..... \$56.99
- 117. Network Wire Tree, 4 outlet surge and spike protector ..... \$44.99
- 118. Network Wire Tree Plus, 6 outlet surge, spike, and modem protector ..... \$64.99

(404) 449-8089 *Orders Only* 1-800-241-8149



## America's PC Specialist

© Copyright 1986, Micro Mart, Inc. Technology Corporate Campus 3159 Campus Drive, Norcross, GA 30071  
Prices are subject to change without notice and are similar, but may vary at Micro Mart Retail Stores.

# Chalcedony PROLOG

Not Copy Protected

A REAL **\$99.95**  
Clocksin & Mellish Prolog for BOTH major microcomputing operating systems — with full cross-compatibility.



Complete with the predicates necessary for POWER AI programming:  
op () name () functor () clause () =.. ("Univ")  
...And no constraining data typing.

- Floating point
- Step-by-step tutorial
- Math functions
- Integrated editor

## PROLOG

Extensible overlay library, 8087 support, large memory model (up to 640K)

## PROLOG

Complete Macintosh environment with extensive pull-down menus and dialogue boxes.

*No Risk Offer: Examine the PROLOG/i or PROLOG/m documentation at our risk for 30 days. If not completely satisfied, return with disk still sealed for refund*

## APPLICATIONS— Complete with SOURCE CODE

### NFL X-pert **\$49.95**

A true interactive expert system written by a professional knowledge engineer. A valuable learning tool for any Prolog programmer interested in using Prolog to develop expert systems.

### TOOLBOX **\$29.95**

More than 50 subroutines that speed and compress list handling, searches, sorts, and reversal algorithms. An inside look at the tricks of the professional Prolog programmer.

### TOYBOX **\$29.95**

Written by an academician to help his students understand Prolog, this collection of puzzles and mind-teasers will illustrate how the Prolog programmer creates programs that find the best solution to the problem. Turn your computer into a super reasoning machine!

#### System Requirements:

Minimum 256K RAM  
(320K recommended)  
PC DOS/MS-DOS  
ANSI Standard Support

Minimum 512K  
Macintosh  
Macintosh-plus and  
HFS Compatible



**CHALCEDONY  
SOFTWARE, INC.**

5580 LA JOLLA BLVD  
SUITE 126 B  
LA JOLLA, CA  
92037  
(619) 483-8513

SAVE 10% when you buy either PROLOG/i or PROLOG/m and all 3 applications.

PHONE ORDERS: 1-800-621-0852 EXT 468

PAYMENT ENCLOSED \$ \_\_\_\_\_  
CA residents add 6% sales tax

CHARGE MY:     MasterCard     Visa

Card No \_\_\_\_\_ Exp Date \_\_\_\_\_

Signature \_\_\_\_\_

Mr / Mrs / Ms \_\_\_\_\_  
(please print full name)

Address \_\_\_\_\_

City/State/Zip \_\_\_\_\_

PROLOG/i **\$99.95**  
PROLOG/m **99.95**

Check:  
MS-DOS  **49.95**  
NFL X-pert  **49.95**  
TOOLBOX **29.95**  
TOYBOX **29.95**  
Complete Pack **188.82**

SHIPPING:  
\$ 5.00 U.S.  
7.50 Canada  
10.00 Caribbean,  
Hawaii Air  
20.00 Overseas Air

Triebel, Walter A., and Avtar Singh. *The 68000 Microprocessor: Architecture, Software, and Interfacing Techniques*. Englewood Cliffs, NJ: Prentice-Hall, 1986. Hardcover. \$34.95. 366 pages.

This book is challenging, both to read and to understand. But if you make the effort and read it carefully, you can come away with a balanced view of both the M68000 microprocessor family and how microcomputers are designed to use these chips. This hardbound textbook would be at home in both electrical engineering/computer science microprogramming and design courses. Walter A. Triebel and Avtar Singh cover the material extensively, with particular emphasis on the memory and I/O interfaces of the MC68000 microprocessor.

The *68000 Microprocessor* also covers the internal architecture of the processor, including a complete discussion of the control and execution of instructions. Triebel and Singh jump into circuit design issues as well, covering such topics as address maps, I/O interface circuits, and interrupt circuits. The software side of the 68000 is not left out, either: Two full chapters break down technical topics like addressing modes, the 68000 instruction set, and the analysis and writing of assembly language programs.

### MACINTOSH 68000 PROGRAMMING REFERENCES

Chernicoff, Stephen. *Macintosh Revealed, Volume One: Unlocking the Toolbox*. Berkeley, CA: Hayden Book Co., 1985. \$25.95. 516 pages. (A full review of this book can be found in November 1985 BYTE, page 57).

Chernicoff, Stephen. *Macintosh Revealed, Volume Two: Programming with the Toolbox*. Berkeley, CA: Hayden Book Co., 1985. \$29.95. 626 pages. A disk of the programming examples in volumes one and two is available from Hayden for \$19.95. (For a full review, see April BYTE, page 67.)

*Inside Macintosh: Promotional Edition*. San Jose, CA: Apple Computer Inc., 1985 (published as documentation). \$25. 1000-plus pages. Also published as a three-volume series by Addison-Wesley, Reading, MA, 1985, at \$24.95 each.

*Inside Macintosh* is the ultimate reference for Macintosh program developers. Published in a phone-book format on newsprint-type stock, it appears as authoritative as it is indispensable. Written by a team of Apple programmers and writers, *Inside Macintosh* offers definitive information about how the Macintosh works: its ROM, RAM, disk drive, microprocessor, ports, keyboard, mouse, and all the rest. The information is densely packed and not particularly easy to get at, but most of what you need is there.

### MACINTOSH 68000 PROGRAMMING TEXTBOOKS

Commander, Jake. *Macintosh Assembly Language Programming*. Blue Ridge Summit, PA: Tab Books, 1985. \$16.95. 198 pages.

(continued)

**ORDER LINE 800-354-7330**

# LOWEST PRICES NO SURCHARGE ON BANK CARDS SILICON SPECIALTIES

**ZENITH COMPUTERS**  
Always the lowest prices.  
Call us for a quote.

| Brother All Models <b>Save</b> |               |
|--------------------------------|---------------|
| Cannon Laser Printer           | <b>1949</b>   |
| Citizen MSP 10                 | <b>\$279</b>  |
| MSP 15                         | <b>\$379</b>  |
| MSP 20                         | <b>\$315</b>  |
| MSP 25                         | <b>\$479</b>  |
| Premier 35                     | <b>\$489</b>  |
| Diablo D-25                    | <b>\$489</b>  |
| 635                            | <b>\$1035</b> |
| EPSON                          |               |
| All Printer Models <b>Save</b> |               |
| Fujitsu                        | <b>Save</b>   |
| IBM Proprietary                | <b>\$399</b>  |
| Juki                           |               |
| 6100                           | <b>\$349</b>  |
| 6300                           | <b>\$669</b>  |
| NEC                            |               |
| 3510, 3550, 3515, 3530         | <b>\$729</b>  |
| 8810, 8830, 8850               | <b>\$1039</b> |
| P5                             | <b>\$959</b>  |
| P6                             | <b>\$429</b>  |
| P7                             | <b>\$609</b>  |
| OKIDATA                        |               |
| All Printer Models <b>Save</b> |               |
| Panasonic 1080                 | <b>\$199</b>  |
| 1091                           | <b>\$239</b>  |
| 1092                           | <b>\$309</b>  |
| 1592                           | <b>\$425</b>  |
| KXP3151                        | <b>\$399</b>  |
| STAR MICRONICS                 |               |
| All Printer Models <b>Save</b> |               |

| PRINTERS                |               |
|-------------------------|---------------|
| Toshiba 341             | <b>\$769</b>  |
| 321 Parallel & Serial   | <b>\$449</b>  |
| P351 Parallel & Serial  | <b>\$969</b>  |
| Laser Printer           | <b>\$969</b>  |
| DISKETTES               |               |
| Maxell MD 2 (Qty 100)   | <b>\$100</b>  |
| Sony MD/2 (Qty 100)     | <b>\$119</b>  |
| MONITORS                |               |
| Amdax All Monitors      | <b>Save</b>   |
| NEC All Monitors        | <b>Save</b>   |
| Princeton Graphics      | <b>Save</b>   |
| Zenith All Models       | <b>Save</b>   |
| VIDEO TERMINALS         |               |
| Qume QVT Green 101      | <b>\$299</b>  |
| OVI Amber 101           | <b>\$314</b>  |
| Wyse 30                 | <b>\$299</b>  |
| 50                      | <b>\$419</b>  |
| 73                      | <b>\$559</b>  |
| Wyse 85                 | <b>\$439</b>  |
| Wyse 350                | <b>\$859</b>  |
| Zenith 2:22             | <b>\$455</b>  |
| Z 29A                   | <b>\$559</b>  |
| Z-49                    | <b>Save</b>   |
| DISK DRIVES             |               |
| Iomega Bernoulli 10 meg | <b>\$1249</b> |
| Bernoulli 20 meg        | <b>\$1649</b> |
| Bernoulli 40 meg        | <b>\$2329</b> |
| SEAGATE                 |               |
| 20 meg w/Western I/O    | <b>\$395</b>  |
| PLOTTERS                |               |
| Epson 16-90             | <b>Save</b>   |

## HARDWARE

| MODEMS                        |              |
|-------------------------------|--------------|
| Ancher Automation             | <b>\$235</b> |
| Signamon Express              |              |
| Practical Peripherals         |              |
| Practical 1200 Baud           | <b>\$124</b> |
| HAYES                         |              |
| All Modems <b>Save</b>        |              |
| Prometheus All Models         | <b>Save</b>  |
| US Robotics Courier 2400      | <b>\$379</b> |
| Postward 1200                 | <b>\$180</b> |
| Microlink 2400                | <b>\$379</b> |
| BOARDS                        |              |
| AST Advantage                 | <b>\$329</b> |
| Rampage AT                    | <b>\$445</b> |
| Rampage PC                    | <b>\$239</b> |
| Six Pack Plus                 | <b>\$159</b> |
| Hercules Color Card           | <b>\$149</b> |
| Graphic Card                  | <b>\$179</b> |
| Intel                         |              |
| Above Board PC (1110)         | <b>\$239</b> |
| Above Board AT (2010)         | <b>\$329</b> |
| Above Board PS/AT (2110)      | <b>\$369</b> |
| Maynard Hardcard              | <b>\$549</b> |
| Paradise Modular Graphic 06 I | <b>\$239</b> |
| Five Pak                      | <b>\$115</b> |
| Plus Development              |              |
| Plus Hard Card 20 Megabyte    | <b>\$669</b> |
| Quadram                       |              |
| Gold & Silver Boards          | <b>Save</b>  |
| Cardbus                       | <b>\$329</b> |
| Quad EGA+                     | <b>\$359</b> |
| Tec Mar Graphics Master       | <b>\$445</b> |
| (8086) No Memory              | <b>\$169</b> |

| IBM COMPUTERS              |               |
|----------------------------|---------------|
| PC 1 Drive 256K            | <b>\$1199</b> |
| XT 1 Drive 256K            | <b>\$1729</b> |
| XT 1 Drive 20 Meg 640K     | <b>\$2169</b> |
| AT/68                      | <b>\$2849</b> |
| AT/339                     | <b>\$4449</b> |
| COMPAQ                     |               |
| Portable II 2 Drive        | <b>\$1649</b> |
| PANASONIC                  |               |
| Sr Partner Dual Drive      | <b>\$1309</b> |
| Exec. Partner Dual Drive   | <b>\$1899</b> |
| TOSHIBA                    |               |
| T 1100                     | <b>\$1299</b> |
| T 1100 Plus                | <b>Save</b>   |
| T 3100                     | <b>Save</b>   |
| SPERRY                     |               |
| Sperry IT                  | <b>\$1999</b> |
| Other Models               | <b>Save</b>   |
| WYSE                       |               |
| Wyse pc 1100-1             | <b>\$979</b>  |
| Wyse pc 1100-2D            | <b>\$1539</b> |
| Zenith Computer Products   |               |
| <b>SAVE up to 50%</b>      |               |
| All Models <b>Save</b>     |               |
| KEYBOARDS                  |               |
| Keytronics 5151            | <b>\$159</b>  |
| SPREADSHEETS               |               |
| Lotus 1 2 3                | <b>Save</b>   |
| Multiplex                  | <b>\$108</b>  |
| Spreadsheet Auditor 2.0    | <b>\$82</b>   |
| VP Planner                 | <b>\$48</b>   |
| <b>Supercalc 4</b>         | <b>Save</b>   |
| MONEY MANAGEMENT           |               |
| Dollars & Sense w/Forecast | <b>\$94</b>   |
| Tobias Managing Your Money | <b>Save</b>   |
| DATA BASE MANAGEMENT       |               |
| Clipper                    | <b>\$335</b>  |
| Cornerstone                | <b>\$67</b>   |
| dBase II                   | <b>Save</b>   |
| dBase III Plus             | <b>Save</b>   |
| Extended Report Writer     | <b>\$74</b>   |
| Knowledgebase II           | <b>\$279</b>  |
| Nutshell 2.0               | <b>\$59</b>   |
| PPS: File                  | <b>\$76</b>   |
| PPS: Report                | <b>\$67</b>   |
| Quickcode                  | <b>\$138</b>  |
| QuickReport                | <b>\$138</b>  |
| Reflex                     | <b>Save</b>   |
| Think Tank                 | <b>\$91</b>   |
| <b>R:Base 5000</b>         | <b>\$245</b>  |

| TRAINING                     |              |
|------------------------------|--------------|
| Flight Simulator             | <b>\$28</b>  |
| PC Logo                      | <b>\$75</b>  |
| Typing Instructor            | <b>\$28</b>  |
| Typing Tutor III             | <b>\$28</b>  |
| INTEGRATIVE SOFTWARE         |              |
| Enable 1 I                   | <b>\$319</b> |
| Framework II                 | <b>Save</b>  |
| Smart Software System        | <b>\$379</b> |
| Symphony                     | <b>Save</b>  |
| GRAPHICS                     |              |
| Chartmaster                  | <b>\$199</b> |
| Diagram Maker                | <b>\$185</b> |
| Energraphyc 2.0              | <b>\$269</b> |
| In A Vision                  | <b>\$249</b> |
| Microsoft Business           |              |
| w/PC Paintbrush 3.0          | <b>\$106</b> |
| Microsoft Chart              | <b>\$168</b> |
| Microsoft Serial Mouse       | <b>\$119</b> |
| Newsroom                     | <b>\$31</b>  |
| PC Draw                      | <b>\$199</b> |
| Click Art Personal Publisher | <b>\$99</b>  |
| PC Mouse w/Dr. Halo II       | <b>\$99</b>  |
| PC Power w/Mouse             | <b>\$115</b> |
| PPS Graph                    | <b>\$76</b>  |
| Printmaster                  | <b>\$29</b>  |
| Signmaster                   | <b>\$132</b> |
| Turbo Graphics Tool Box      | <b>\$30</b>  |

## SOFTWARE

| IBM PC AND 100% Compatibles        |                   |
|------------------------------------|-------------------|
| COMMUNICATIONS                     |                   |
| CompuServe Starter Kit             | <b>Best Price</b> |
| CrossTalk XVI                      | <b>\$92</b>       |
| MS Access 1.0 I                    | <b>Save</b>       |
| PFS Access                         | <b>\$76</b>       |
| Remote                             | <b>\$92</b>       |
| Smartcom II                        | <b>\$83</b>       |
| UTILITIES                          |                   |
| Copy II PC                         | <b>\$19</b>       |
| I DIR                              | <b>\$46</b>       |
| Fastback                           | <b>\$86</b>       |
| Morton Utilities 3 I               | <b>\$48</b>       |
| Penworks                           | <b>\$36</b>       |
| Sidokick                           | <b>\$30</b>       |
| Sidokick (Unprotected)             | <b>\$47</b>       |
| Sidokick Superkey (Bundle)         | <b>\$85</b>       |
| Travelling Sidokick                | <b>\$39</b>       |
| Turbo Prolog                       | <b>\$54</b>       |
| Sideways 3 I                       | <b>\$34</b>       |
| Superkey                           | <b>\$39</b>       |
| PROJECT MANAGEMENT                 |                   |
| Harvard Total Project Manager      | <b>\$262</b>      |
| Microsoft Project                  | <b>\$219</b>      |
| Super Project Plus                 | <b>Save</b>       |
| Timeline 2.0                       | <b>\$209</b>      |
| WORD PROCESSORS                    |                   |
| Learning Edge Word Processor       | <b>\$48</b>       |
| Leading Edge W/P w/Spell & Mail    | <b>\$72</b>       |
| Lightning                          | <b>\$55</b>       |
| Microsoft Word 3.0                 | <b>Save</b>       |
| Multimate Advantage                | <b>Save</b>       |
| PFS: Write w/Spell Checker         | <b>\$76</b>       |
| Wordstar w/Tutor                   | <b>\$162</b>      |
| Wordstar Pro Pack                  | <b>\$233</b>      |
| <b>Word Perfect (Ver.4.1)\$196</b> |                   |
| <b>Wordstar 2000 + 2.0 \$278</b>   |                   |
| LANGUAGES                          |                   |
| C Compiler (Microsoft)             | <b>\$249</b>      |
| Fortran Compiler (Microsoft)       | <b>\$195</b>      |
| Lattice C Compiler                 | <b>\$242</b>      |
| Macro Assembler (Microsoft)        | <b>\$84</b>       |
| Pascal Compiler (Microsoft)        | <b>\$166</b>      |
| Quick Basic 2                      | <b>\$55</b>       |
| Rim C Interpreter                  | <b>\$65</b>       |
| Turbo Pascal w/8087 & BCD          | <b>Save</b>       |
| Turbo Database Tool Box            | <b>\$30</b>       |



**MIT SYSTEMS**  
**Turbo PC/XT \$449**

734 Memory, One 360K Batted Name Floppy Drive  
135 Watt Power Supply, Slide Case, All Style Keyboard  
8 MHz Clock Speed, (Keyboard Selectable), 8 Expansion Slots

**SPECIAL**  
Over \$200 worth of  
Paperback Software Programs  
**\$49** with each system

|                                                          |              |
|----------------------------------------------------------|--------------|
| Turbo PC/XT w/756K & 1 Drive                             | <b>\$449</b> |
| Turbo PC/XT w/640K & 1 Drive                             | <b>\$499</b> |
| Turbo PC/XT w/640K & 2 Drives                            | <b>\$599</b> |
| Turbo PC/XT w/640K, 1 Drive & 20MG                       | <b>\$989</b> |
| ManGraphics Card with Software and Parallel Printer Port | <b>\$ 79</b> |
| Color Card with Parallel Print Port                      | <b>\$ 69</b> |
| Multifunction Card w/Software                            | <b>\$ 79</b> |
| Amber Monitor (TTL)                                      | <b>\$ 95</b> |
| Color Monitor (RGB)                                      | <b>\$289</b> |
| Sega Enhanced Graphics Card                              | <b>\$259</b> |
| I/O Card (Serial/Parallel)                               | <b>\$ 39</b> |
| I/O Card (Serial/Clock Calendar)                         | <b>\$ 39</b> |
| I/O Card (Parallel)                                      | <b>\$ 39</b> |
| 5121 Clone Keyboard                                      | <b>\$ 79</b> |

**SILICON SPECIALTIES**  
2034 WEST SOUTHERN  
MESA, ARIZONA 85202  
602-969-0909

Product shipped in factory cartons with manufacturer's warranty. Please add \$10.00 per order for UPS shipping. Prices & availability subject to change without notice. Send cashier's check or money order - all other checks will delay shipping two weeks.  
Inquiry 309 for MS DOS Products Inquiry 310 for all others

Many other titles available.

NEW 10 MHz

## TIME IS MONEY... 10 MHz IS FAST!!!

FULL IBM PC-AT\* COMPATIBILITY

IF YOU ARE TIRED OF WAITING FOR A 'SOMEDAY' PRODUCT  
OR YOU DON'T WANT TO BUY YESTERDAY'S TECHNOLOGY,  
THEN TREAT YOURSELF TO THE PERFORMANCE & FEATURES  
OF THE "WESTECH 286 TURBO™" 10 MHz

PHOENIX BIOS - THE MISSING LINK IN  
SOFTWARE COMPATIBILITY - ON BOARD

LOWEST COST 10 MHz AVAILABLE

COMPLETELY DESIGNED, MANUFACTURED, ASSEMBLED  
AND TESTED IN U.S.A.

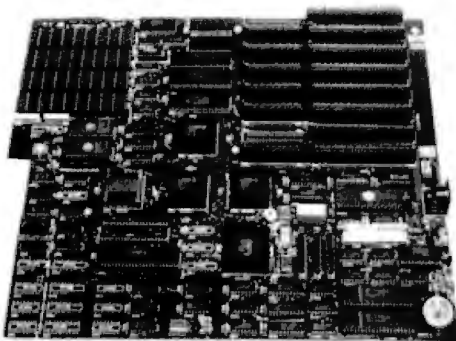

- 8 I/O Slots
- Parallel Port
- Up to 2 RS-232 Ports
- 1 RS-232 Included
- Phoenix BIOS
- Up to 1 MB Onboard
- 512K Included 120ns
- 4 Layer Mother Board
- Onboard Battery
- CMOS Clock Calendar
- Standard Power Connector
- Low Power Circuitry
- 10 MHz 80286
- Socket for 80287
- One-Year Warranty

### HIGH SPEED INDUSTRIAL GRADE COMPUTER FOR:

- Industrial
- Medical
- Scientific
- Engineering
- University/Education
- Artificial Intelligence

QUANTITY DISCOUNTS AVAILABLE FOR QUALIFIED DEALER,  
OEM, UNIVERSITY AND CORPORATE ACCOUNTS.

**\$599.00 OEM Quantity Price**

Call for other pricing

**Westech, Inc.**

**(714) 474-6022**

**17781 Mitchell, Irvine, CA 92714**

**FAX (714) 553-0236 • TELEX 756731**

Answer Back: Western Comp

Prices and availability subject to change  
\* IBM AT is a trademark of International Business Machines Corporation  
Westech 286 Turbo is a trademark of Westech, Inc.

## BOOK REVIEWS

*Macintosh Assembly Language Programming* is a surprisingly good book. Ignore its shortcomings—design, execution, and illustrations—and you will be rewarded with a lucid, effective, and easy-to-understand discussion of Macintosh assembly programming. The author, a microcomputer software writer, has concentrated on the most important aspects of Macintosh assembly language programming (program specification and design, using the 68000 assembly language development system, the Macintosh operating system, etc.), so that novice assembly language programmers have enough hooks to latch onto.

Rosenzweig, Edwin, and Harland Harrison. *Programming the 68000: Macintosh Assembly Language*. Hasbrouck Heights, NJ: Hayden Book Co., 1986. \$24.95. 399 pages.

This book attempts to cover assembly language programming of the MC68000 chip on the Macintosh. I found detailed chapters on difficult material written by both authors to be praiseworthy in their clarity.

*Programming the 68000* covers the territory of a self-taught Macintosh assembly language programming textbook quite well. It provides most of the information you need to know to become a Mac assembly and Toolbox programmer. The authors begin with a discussion of the addressing modes of the 68000 and move through the 68000 instruction set on to the Mac Toolbox and ROM calls.

Takatsuka, Jim, David Burnard, and Fred Huxham. *Using the Macintosh Toolbox with C*. Berkeley, CA: Sybex, 1986. \$22.95. 559 pages.

This book is handy if you're planning to program in C on the Macintosh. Regardless of which C compiler you use, it provides the interfacing information you'll need to make your programs work with the Toolbox. The tutorial approach is reasonably successful. *Using the Macintosh Toolbox with C* details how to use dialog and alert boxes, windows, text editing, menus, screen graphics and icons, and much more from your C programs.

Ward, Terry A. *Programming C on the Macintosh*. Glenview, IL: Scott, Foresman and Co., 1986. \$21.95. 411 pages.

Terry A. Ward's book is important to programmers who want to become part of that software development effort but lack the knowledge about C on the Mac.

Ward begins by moving from a discussion of the ubiquitous Macintosh user interface through a short description of the syntax and properties of C. *Programming C on the Macintosh* goes on to cover five different Mac C compilers, QuickDraw routines, menus, the event manager of the Mac, and the Mac's TextEdit routines. The book is filled with example programs, illustrations, and charts, and is pleasant to read. The index is thin, but the appendixes and a table of contents are helpful.

Williams, Steve. *Programming the Macintosh in Assembly Lan-*

(continued)

# Major Database features for a minor price!



## Before you buy DBase III, QuickCode and Clipper, look at TAS-Plus

TAS-Plus just made it faster, easier and cheaper to build database applications.

TAS-Plus combines the power of a Relational Database with the ease of a Program Generator. Then TAS-Plus adds a Runtime Compiler to produce lightning-fast finished code.

Look at what TAS-Plus gives you:

- Relational Database**
- 4th Generation Language**
- Screen Painter**
- Program Generator**
- Report Writer**
- Source Code Editor**
- Runtime Compiler**

TAS-Plus gives you power where it counts. You can store up to 65,000 records, open up to 16 files at a time and enter up to 10,000 characters per record. TAS-Plus even reads your old DBase files.

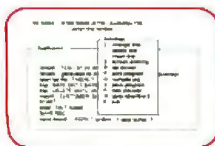

**TAS-Plus writes the program for you**

With TAS-Plus, you can start building professional database applications on day one. Just "paint" the screen the way you want and TAS-Plus writes the

program for you. You can even paint using different colors or graphic characters. And custom reports are just as easy.

TAS-Plus has over 86 commands and 200 options available in its Source Code Editor, so you won't run out of room to grow.

### Easy to use features

Add new databases quickly and easily. Add, change or delete records without any programming at all.

Browse through your database and see multiple records on the screen at the same time.

Restructure capability allows you to change existing databases without loss of any data.

### All this for just '69

TAS-Plus would be respectable at any price, at \$69 it's awesome.

### 30 day Money Back Deal

TAS-Plus comes with a 30 day money back guarantee (less \$15 handling fee). TAS-Plus is available for the IBM PC/XT/AT and fully compatible computers. TAS-Plus Accounting applications available.

**Order Today**  
**1-800-648-6258**

Call our Toll-Free Hotline. Use your VISA, MasterCard or American Express to order today. For information or Washington residents call 1-206-644-2015.

THE ULTIMATE BUSINESS TOOL

TAS+

*Relational Database*

TAS+™

NOT COPY-PROTECTED

**YES!** Rush me the following items

| Qty.                               | Item | Price                              | Subtotal |
|------------------------------------|------|------------------------------------|----------|
| _____                              | TAS+ | \$69                               | _____    |
| Shipping add \$8 USA.              |      | Shipping                           | _____    |
| \$25 outside USA                   |      | Tax                                | _____    |
| WA res add \$5.59 Tax              |      | Amount Enclosed<br>(US funds only) | _____    |
| Name _____                         |      |                                    |          |
| Shipping Address _____             |      |                                    |          |
| City: _____                        |      |                                    |          |
| State _____                        |      | Zip _____                          |          |
| Telephone _____                    |      |                                    |          |
| Payment                            | VISA | MC                                 | AMX      |
| Credit Card Expiration Date: _____ |      |                                    |          |
| Card Number: _____                 |      |                                    |          |
| Name on Card: _____                |      |                                    |          |

**BUSINESS TOOLS INC.**



4038-B 128th Ave. S.E., Suite 266  
Bellevue, Washington 98006  
(206) 644-2015



MasterCard



The following are registered trademarks of these companies: TAS-Plus, The Accounting Solution, Business Tools, Inc.; DBase III, Ashton-Tate; CP/M, Digital Research; IBM PC/XT/AT, International Business Machines Corp; QuickCode, Fox & Giller; Clipper, Nantucket Inc.

Copyright 1986 Business Tools, Inc.

# TOTAL CONTROL with LMI FORTH™



## For Programming Professionals: an expanding family of compatible, high-performance, Forth-83 Standard compilers for microcomputers

### For Development: Interactive Forth-83 Interpreter/Compilers

- 16-bit and 32-bit implementations
- Full screen editor and assembler
- Uses standard operating system files
- 400 page manual written in plain English
- Options include software floating point, arithmetic coprocessor support, symbolic debugger, native code compilers, and graphics support

### For Applications: Forth-83 Metacompiler

- Unique table-driven multi-pass Forth compiler
- Compiles compact ROMable or disk-based applications
- Excellent error handling
- Produces headerless code, compiles from intermediate states, and performs conditional compilation
- Cross-compiles to 8080, Z-80, 8086, 68000, 6502, 8051, 8096, 1802, and 6303
- No license fee or royalty for compiled applications

### For Speed: CForth Application Compiler

- Translates "high-level" Forth into in-line, optimized machine code
- Can generate ROMable code

### Support Services for registered users:

- Technical Assistance Hotline
- Periodic newsletters and low-cost updates
- Bulletin Board System

**Call or write for detailed product information  
and prices. Consulting and Educational Services  
available by special arrangement.**

**LMI** Laboratory Microsystems Incorporated  
Post Office Box 10430, Marina del Rey, CA 90295  
Phone credit card orders to: (213) 306-7412

#### Overseas Distributors.

Germany: Forth-Systeme Angelika Fleisch, Titisee-Neustadt, 7951-1665  
UK: System Science Ltd., London, 01-248 0962  
France: Micro-Sigma S.A.R.L., Paris, (1) 42.85.95.16  
Japan: Southern Pacific Ltd., Yokohama, 045-314-9514  
Australia: Wave-onic Associates, Willson, W.A., (09) 451-2946

## BOOK REVIEWS

*guage*. Berkeley, CA: Sybex, 1986. \$24.95. 779 pages.

*Programming the Macintosh in Assembly Language* is a massive book for experienced programmers. Novices would be overwhelmed by the detailed presentation of 68000 chip architecture, instruction sets, and the Macintosh Toolbox.

The presentation of the Macintosh programming environment is the strongest aspect of the book. The discussion of interfacing issues will help you get your own programs working with the Toolbox quickly, using the appropriate screen and mouse features. The book also has copious listings of the source code discussed throughout.

### ATARI 520ST TECHNICAL REFERENCES

Editors of *Compute!*. *Compute!'s ST Programmer's Guide*. Greensboro, NC: Compute! Publications, 1986. \$16.95. 356 pages.

One-third of this reference book is a discussion of the Atari 520ST implementation of BASIC. The other two-thirds cover Logo programming, GEM and TOS, and writing GEM applications. As one of the first books on the ST, it attempts to cover as many different audiences as it covers programming topics, for the most part successfully.

Later chapters will be of more interest to advanced programmers due to the discussions of TOS, the GEM desktop, the GEM Virtual Device Interface (VDI), and Application Environment Services (AES). The detail is such that an advanced programmer can learn to write GEM applications in C. But just when you expect the book to discuss application implementation under GEM with C, the book ends. *Compute!'s ST Programmer's Guide* also fails to discuss any aspects of assembly language programming for the ST, another serious drawback to the book's ultimate usefulness.

Szczepanowski, Norbert, and Bernd Gunther. *Atari ST GEM Programmer's Reference*. Grand Rapids, MI: Abacus Software, 1986. \$19.95. 414 pages.

Despite its title, the *Atari ST GEM Programmer's Reference* is really a complete programming handbook for the ST. The book covers much of the same ground as *Compute!'s ST Programmer's Guide*, but it does so in much more detail, with more emphasis on implementing user applications with C.

The bulk of this handbook is taken up with the discussion of GEM's Virtual Device Interface (VDI) and how to use it in your programs to create graphics. A fair number of programming examples are provided to help you implement your own code. Like *Compute!'s ST Programmer's Guide*, this book is dry reading, chock full of assembly language routines and C language definitions, without some more invigorating text to break the monotony.

Donald Evan Crabb is director of instruction and laboratories at the University of Chicago (Department of Computer Science, Ryerson Hall 260, 1100 East 58th St., Chicago, IL 60637). He is on the review board of *InfoWorld*. ■

There's a good chance  
that a computer in  
your future will  
come with  
Microware software.

**People who can't wait for the future have Microware software now.**

Right now, many of the biggest names in the business have their next-generation personal computers on the drawing boards. These advanced systems will have capabilities that will go far beyond what's available today. Many of these exciting new products will feature high-performance system software by Microware.

Operating systems and programming languages are the foundations upon which all other applications are built. Microware's OS-9 operating system is the ideal base for innovative fourth-generation application packages. It provides many advanced capabilities including true multitasking, a universal file and I/O system, modular construction, powerful graphics, unlimited communications gateways, and real-time response. And it's so versatile it can be used on almost any size system — from inexpensive personal computers all the way up to large multiuser systems.

Microware also has outstanding versions of the most popular programming languages. For example, Microware's extended, structured Basic is friendlier than an interpreter, yet it runs as fast as a compiler. And it's so smart that it actually reports bugs as programs are typed in. Or consider Microware's full-feature C Compiler. It can recompile almost any Unix application program to be much smaller and faster than the Unix equivalent. You can also choose Fortran and Pascal compilers of equal calibre.

Software like this doesn't happen by accident. Microware software is specifically designed to unleash the full potential of the extraordinary

68000 and 6809 microprocessor families. Microware works in close cooperation with the people who actually design the systems and silicon in order to achieve maximum integration and performance. That's why Microware software has already made a big impact within the scientific, engineering, and industrial communities.

Affordable, powerful personal computers with Microware software are available *now* at most Tandy/Radio Shack retail locations, and through Fujitsu and Hitachi in Japan. Plus over a hundred innovative manufacturers worldwide offer a veritable banquet of professional systems and software for VME, Multibus, STD, and most other popular standard bus architectures. If you're technically oriented, you can even get a reasonably priced Microware PortPak™ and install OS-9 on your own custom 68000 system.

Some things change, others can't. Will Unix ever become affordable and understandable enough for you? How long can MS-DOS keep up with new technology? You can wait and find out, or you can step into the future today. Contact us today and we'll send you complete information.



**MICROWARE.**

MICROWARE SYSTEMS CORPORATION  
1866 N.W. 114th Street • Des Moines, Iowa 50322  
Phone 515-224-1929 • Telex 910-520-2535

MICROWARE JAPAN, LTD.  
41-19 Honcho 4-Chome, Funabashi City • Chiba 273,  
Japan • Phone 0474-22-1747 • Telex 298-3472

OS-9 is a trademark of Microware and Motorola. Unix is a trademark of Bell Laboratories. VAX is a trademark of Digital Equipment Corporation. Multibus is a trademark of Intel Corporation.

Inquiry 240

Simply put: **THE™** highest quality and best value in computer products anywhere.

**THE™** commitment to our customers is compatibility, quality, value, service and support

**THE™** backs every product with a **45 DAY MONEY BACK GUARANTEE** and a **FULL 1 YEAR PARTS AND LABOR WARRANTY**

**THE™ MULTI 384**

This multi-function card features 0-384K memory, a parallel printer port, a serial port for communications, a clock/calendar with battery backup, and a software bonus that includes RAMdisk and other utilities. Retail \$90.00

**\$72.00\***  
Special Wholesale Price



**BEST BUY**  
Functional Clone of AST SixPackPlus

**THE™ COLOR CARD**

100% compatible with the IBM™ colorcard with display modes of 80x25 alphanumeric and 320x200 graphic. Retail Price \$75.00

Special Wholesale Price **\$60.00\***

**THE™ 576K MEMORY +**

Supports 0-576K of available memory and is compatible with all IBM™ PC's. Retail \$46.25

Special Wholesale Price **\$37.00\***

**THE™ PRINTERFACE**

Supports all text and graphics features and is fully compatible with third party software. Retail Price \$23.13

Special Wholesale Price **\$18.50\***

**THE™ MODEMS**

100% Hayes compatible

**THE™ 1200 COM EXTERNAL**

This self-testing 1200 BPS modem comes with auto answer, auto dial, auto redial and a built-in speaker. Retail Price \$161.25\*

Special Wholesale Price **\$129.00\***



**THE™ 1200 COM INTERNAL**

Features auto answer, dial and redial, with a built-in speaker, RS 232-C serial port and PC Talk III. Retail Price \$148.75

Special Wholesale Price **\$119.00\***

**THE™ 2400 COM EXTERNAL**

Eight times the speed of a 300 BPS unit makes this 2400 Baud modem truly affordable, and we've made it truly compatible. With auto answer, auto dial, auto redial, and a built-in speaker with volume control. Retail Price \$346.25

Special Wholesale Price **\$277.00\***

**THE™ H720 MONO**

This monochrome graphics card with printer port features 100% IBM™ and Hercules™ compatibility, at a fraction of their prices. Retail Price \$91.25

**\$73.00\***  
Special Wholesale Price



**BEST BUY**  
Functional Clone of Hercules Graphics Card

**A \$120.00 VALUE!**  
**ADAM OSBORN'S PAPERBACK SOFTWARE**



- Paperback Writer
  - Paperback Speller
  - Numberworks Spreadsheet
- All three for only...

**\$32.00\***

With the purchase of a PC +

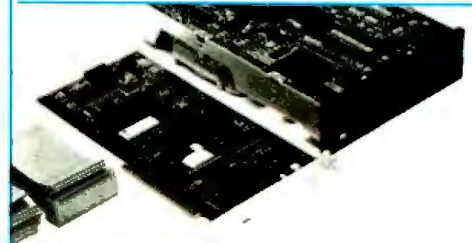

**THE™ 20MB HARD DISK**

Featuring a half-height IBM™ PC compatible internal 20MB disk drive, controller card, connecting cables and installation manual. Retail \$458.75

Special Wholesale Price **\$367.00\***

**THE™ MULTI I/O**

Feature for feature, **THE™** matches the AST™ I/O + and comes up a winner, with serial/parallel and game ports standard. (a second serial port optional), a clock/calendar, RAMdisk and print spooler. Retail Price \$75.00

**\$60.00\***  
Special Wholesale Price

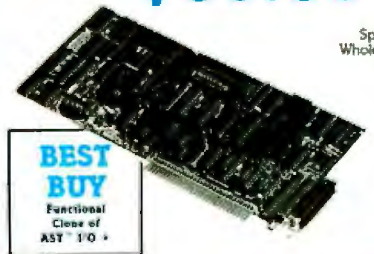

**BEST BUY**  
Functional Clone of AST™ I/O +

**THE™ EGA PLUS**

With 256K standard this 100% IBM™ EGA and Hercules Graphics compatible card is ideal for high resolution graphics display of Microsoft™ Windows, Lotus™ and AutoCAD™. Retail Price \$283.75\*

Special Wholesale Price **\$227.00\***

\*All Items Subject to Availability - Prices Subject to Change  
™ - Registered Trademarks of IBM Ast Research  
Microsoft Hercules Hayes

**Thompson, Harriman and Edwards Computer**



# THE™

Thompson, Harriman and Edwards  
Computer Products Company Ltd.

## THE™ PC+ COMPUTER

THE™ PC+ is compatible with all business, professional and personal software written for the IBM™ PC. It will also enhance your productivity with its ability to switch to an 8 megahertz clock rate, enabling you to run your software twice as fast as the IBM™ PC. THE™ PC+ also comes standard with an "AT" style keyboard, correcting the inefficiencies found by IBM™ on their regular PC keyboard. 256K standard (640K optional) on the mother board will allow you to run memory intensive programs such as Lotus 1-2-3, DBase III and Framework without adding extra memory cards. Plenty of power, with a 135 Watt source and lots of room for expansion with 8 card slots is also standard. Base unit includes: 256K RAM, Computer with One 360K 5¼" Floppy Drive, Dual Turbo Clock Speed, 8 Expansion Slots, 135 Watt Power Supply, "AT" Style Keyboard, Full 1 Year Warranty and 45 Day Money Back Guarantee!  
Retail Price \$586.25\*

Special Wholesale Price  
**\$444.00\***  
(Monitor Not Included)

All THE products in this special sale are offered thru



**THE MOST INCREDIBLE  
LIMITED TIME OFFER IN  
COMPUTER HISTORY, FROM  
THE™ and PC NETWORK...**

# THE™ PC+

**256K RAM,  
IBM™ PC  
compatible,  
360K 5.25"  
Disk Drive,  
Turbo Speed,  
"AT" Style  
Keyboard**

Special Wholesale Price

# \$444.00\*

**\$469.00\* for 640K System**

## PC Network

\*All prices in this ad are wholesale - PC Network Members pay wholesale + 8% and shipping.

CALL TOLL FREE B3N9

**(800) 621-SAVE**

In Illinois (312) 280-0002

**Products Company Ltd.**

Dealer Inquiries Call THE™ at (312) 642-9626  
319 West Ontario Street, Chicago, Illinois 60610



# COMPLETE SYSTEMS

(Optional local warranty service available in most major metro areas)

## IBM PC BASE SYSTEM

IBM PC w/256K  
Floppy Drive Controller  
2 Double Sided Double  
Density Disk Drives  
Mix and Match with  
your Favorite Monitor  
and Printer!

**\$1,025.00\***

CUSTOM  
CONFIGURATIONS  
WELCOME



## IBM PC HARD DISK SYSTEM

IBM PC w/256K  
Floppy Drive Controller  
1 Double Sided Double  
Density Disk Drive  
Half Height Hard Disk

w/20MB

**\$1,467.00\***

CALL FOR  
LATEST IBM  
ANNOUNCEMENTS

## PORTABLE HARD DISK SYSTEM

256K/1 Floppy/20MB Hard Disk



**\$1,910.00\***

## DESKPRO SYSTEM

256K CPU/1 Floppy/Hard Disk



**\$1,999.00\***  
**\$1,910.00\***

w/30MB

w/20MB

APPLE IIc



APPLE IIe



MACINTOSH SYSTEMS



## 64K IBM PC MEMORY EXPANSION KITS

Quantity Discounts Available.  
Guaranteed for Life!



Set of 9 Chips **\$7.75\***

## DISKETTES

Guaranteed for Life!

Blank Name diskettes  
available in boxes of 10  
or in bulk packs of 50

5 1/4" DS/DD

**\$7.95\***

Bx 10 Bx 50  
ea. **.54\***

5 1/4" SS/DD

**\$6.95\***

Bx 10 Bx 50  
ea. **.47\***

3 1/2" SS/DD

Bx. 10  
**\$12.95\***

Free Flip  
& File Case

## 1/2 HEIGHT DS/DD DISK DRIVES



The Network buys direct and makes fantastic deals with manufacturers like MPF/Tandon/CDC/Shugart/Quem/TEAC and others to bring you fantastic prices on Name Brand drives for your PC/AT/XT/rtjr Compatible.

**\$78.00\***

Quantity Discounts Available

## INTERNAL PC HARD DISK

Low Power/Automatic Boot. Works on standard PC's and Compatibles. Includes drive/controller/cables/mounting hardware and instructions.



Full one year warranty!

10MB  
**\$299.00\***

20MB  
**\$367.00\***

Quantity Discount Available



**\$275.00**

WordPerfect

**\$180.00\*** ea.

MultiMate™

\*Members pay 8% above this wholesale price plus shipping.

CALL TOLL FREE 1-800-621-S-A-V-E (orders and memberships)

In Illinois call (312) 280-0002 Validation code: B396

Customer Service and Order Status (312) 280-1567

TM & R—Registered trademarks of IBM/COMPAQ/APPLE/AST Research/LOTUS/MultiMate Int./IOMEGA.

Inquiry 266

# PC NETWORK

SEE WHY OVER 150,000 HAVE JOINED  
MAKING US THE NATION'S #1 SOURCE  
FOR EVERYTHING IN COMPUTING

- **Our 600 Page Wholesale Catalog**  
Over 30,000 products priced at Wholesale + 8%. Anything you will ever need at a Consistent low price...
- **Quarterly Catalog Updates**  
Your Catalog is never obsolete! Keep on top of the newest products and latest price changes.
- **The Printout**  
Our newsletter gives you fantastic specials along with unbiased analysis of new products and industry trends.
- **10 Day Returns on any Hardware!!**  
If you don't like any hardware product—for any reason—return it for a refund.
- **1000 + Title Rental Library**  
14 to 30 day rentals on over 1000 different titles. Try before you buy!!
- **Size, Strength and Stability**  
The Network has over 150 employees, 45,00 square feet of office and warehouse space, inventory valued in excess of \$15,000,000 and is ranked the largest computer product supplier in the nation! Our commitment is to serve our customers and our 90% repeat business rate is proof!!
- **OnLine™ Bulletin Board**  
Download "Freeware" from the nation's largest single concentration of Public Domain software available! Get tied into the nation's largest technical information network! Place orders, get tech support or contact customer service from the Network's OnLine, "not just a bulletin board but a complete customer information network."

CALL TOLL FREE  
1-800-621-S-A-V-E

(Orders—Membership and Advice!)

In Illinois call (312) 280-0002

Your Membership Validation Number **B396**

You can validate your membership number and, if you wish, place your first money-saving order over the phone by using your VISA, MASTERCARD or AMERICAN EXPRESS. Our knowledgeable sales consultants are on duty Mon-Fri. 8:00 AM to 7:00 PM, SAT. 9:00 AM to 5:00 PM CST.

**PERSONAL COMPUTER NETWORK**  
320 West Ohio  
Chicago, Illinois 60610

Call now...Join the PC NETWORK and start saving today!  
Customer Service and Order Status (312) 280-1567  
8:30 AM to 4:30 PM, Mon-Fri. CST



## PC NETWORK • MEMBERSHIP APPLICATION

**YES!** Please enroll me as a member in the PC Network™ and send my catalog featuring thousands of computer products, all at just 8% above DEALER WHOLESALE PRICES. I will also periodically receive "THE PRINTOUT," a special up-to-date on merchandise at prices BELOW even those in my wholesale catalog, and all the other exclusive money-saving services available to Members. **396**

I am under no obligation to buy anything. My complete satisfaction is guaranteed. Please check (✓) all boxes that apply.

- |                                                                                                                                                                                                                                                                                                                                                                                                                                                                                                                                                                                       |                                                                                                                                                                                                                                                                                                                                                                                                                                                |
|---------------------------------------------------------------------------------------------------------------------------------------------------------------------------------------------------------------------------------------------------------------------------------------------------------------------------------------------------------------------------------------------------------------------------------------------------------------------------------------------------------------------------------------------------------------------------------------|------------------------------------------------------------------------------------------------------------------------------------------------------------------------------------------------------------------------------------------------------------------------------------------------------------------------------------------------------------------------------------------------------------------------------------------------|
| <p><b>Basic Membership</b><br/>with optional 14 Day Evaluation.</p> <p><input type="checkbox"/> One-year membership for \$8</p> <p><input type="checkbox"/> Two-year membership for \$15 (Save \$1)</p> <p><input type="checkbox"/> Business Software Evaluation Library for \$25 add'l. per year—with 14-day returns</p> <p><input type="checkbox"/> Games Software Evaluation Library for \$10 add'l. per year</p> <p><input type="checkbox"/> Bill my credit card: <input type="checkbox"/> VISA <input type="checkbox"/> MasterCard <input type="checkbox"/> American Express</p> | <p><b>Special V.I.P. Membership</b><br/>with optional 30 Day Evaluation.</p> <p><input type="checkbox"/> One-year membership for \$15</p> <p><input type="checkbox"/> Two-year membership for \$25 (Save \$5)</p> <p><input type="checkbox"/> BOTH Business and Game Software Evaluation Libraries for \$30 add'l. per year—with 30 day returns</p> <p>*V.I.P. members may receive advance notice on limited quantity merchandise specials</p> |
|---------------------------------------------------------------------------------------------------------------------------------------------------------------------------------------------------------------------------------------------------------------------------------------------------------------------------------------------------------------------------------------------------------------------------------------------------------------------------------------------------------------------------------------------------------------------------------------|------------------------------------------------------------------------------------------------------------------------------------------------------------------------------------------------------------------------------------------------------------------------------------------------------------------------------------------------------------------------------------------------------------------------------------------------|

Account Number:

Exp. Date:  mo.  year

Check or money order enclosed for \$\_\_\_\_\_

Name:

Address:

City:  State:  Zip:

Telephone (  )

My computer(s) is:  IBM PC  IBM-XT  IBM-AT  Apple II  
 Macintosh  Other \_\_\_\_\_

Signature:

(Signature required to validate membership)



A. D. R. E. V. E. R. S. E.

# Features

---

**PRODUCT PREVIEW:**  
**LABVIEW: LABORATORY VIRTUAL INSTRUMENT ENGINEERING WORKBENCH**  
*by G. Michael Vose and Gregg Williams . . .* 84

**CIARCIA'S CIRCUIT CELLAR:**  
**BUILD A HARDWARE DATA ENCRYPTOR**  
*by Steve Ciarcia . . . . .* 97

**PROGRAMMING PROJECT:**  
**CALCULATING CRCs BY BITS AND BYTES**  
*by Greg Morse . . . . .* 114

**PROGRAMMING INSIGHT:**  
**BREAKING OUT**  
*by Edward Batutis . . . . .* 127

**KEYED FILE ACCESS IN BASIC**  
*by Stephen C. Perry . . . . .* 137

**REAL TIME UNDER REAL PASCAL**  
*by James Feldman . . . . .* 145

---

IF THE VIOLATION of private electronic communication is a subject that arouses your ire, Steve Ciarcia's article on data encryption will interest you. Fortunately, there are ways to prevent electronic Peeping Toms. The Circuit Cellar data encryptor is easy to understand, easy to build, and easy to use, but it is very difficult to break. When Steve began this project, he knew little about the subject. Because many of you probably share this lack of knowledge, Steve presents more background material than he ordinarily might.

In this month's Product Preview, BYTE senior technical editors G. Michael Vose and Gregg Williams provide an advance look at LabVIEW, the last four letters of which stand for Virtual Instrument Engineering Workbench. The National Instruments product enables scientists and engineers to create virtual instruments that turn the Macintosh into a general-purpose laboratory tool.

"Calculating CRCs by Bits and Bytes," our Programming Project for September, explains how to use the XOR function to implement modulo 2 division when calculating cyclic redundancy checks. Author Greg Morse provides a lucid description of his method for those who have difficulty understanding the math behind CRC calculations.

When Edward Batutis discovered that the DEBUG program provided with IBM PC-DOS had no break-out switch, he devised a program to provide the capability. "Breaking Out," this month's Programming Insight, explains the routine.

Maintaining data on disk can be a challenging aspect of programming for beginners and experts alike. In "Keyed File Access in BASIC," Stephen C. Perry presents several BASIC routines that provide fast and efficient keyed access to data files.

Our last feature, "Real Time Under Real Pascal" by James Feldman, explains two ways to interface a machine language routine to Pascal. Such a technique is useful for those rare times in a high-level program when you must descend into the depths to achieve timing, communications, or any other operation for which machine language is the sine qua non.

# LABVIEW: LABORATORY VIRTUAL INSTRUMENT ENGINEERING WORKBENCH

---

## *An executable block-diagram environment exploiting Macintosh graphics*

---

*Editor's note: The following is a BYTE product preview. It is not a review. We provide an advance look at this product because we feel that it is significant. A complete review will follow in a subsequent issue.*

**S**cientists and engineers do not deny that computers are important tools in the laboratory. However, they often wish they didn't have to become computer wizards to exploit the potential of the computer. Extending the graphics power of the Macintosh, National Instruments' Laboratory Virtual Instrument Engineering Workbench (LabVIEW) offers a computer programming environment that closely resembles the way scientists and engineers work. Using graphic front panels controlled by executable block diagrams, LabVIEW gives laboratory users a way to create virtual instruments that turn the Macintosh into a

general-purpose laboratory tool.

LabVIEW requires a 512K-byte Macintosh and costs \$1995. It works with stand-alone instruments connected to the Macintosh's serial port, and it supports National Instruments' \$595 GPIB-MAC interface box and the \$1495 MacBus box (see the text box "Using LabVIEW in the Real World" on page 92).

The intended user base for LabVIEW includes engineers and scientists with no programming experience or limited experience with a simple language like BASIC. The components of LabVIEW are the front panel and block-diagram panes for the creation of virtual instruments; a graphic programming language for building front panels and block diagrams; mechanisms for connecting virtual instruments to one another and for linking them to existing C, assembly language, or FORTRAN code modules; built-in I/O functions for reading and writing data to disks or communication ports; and built-in functions for statistical and matrix operations.

### **VIRTUAL INSTRUMENTS**

A virtual instrument (abbreviated as "instrument" for the rest of the article) in the LabVIEW system consists of two items: a front panel and a

block diagram. The front panel contains the input and output controls (e.g., dials, switches, and output screens) that represent the data coming into and going out of the instrument (a control's appearance changes when the user manipulates it). The block diagram contains the program that the instrument executes. Each control is represented by an icon in the block-diagram window, and the program appears as a collection of "black box" icons connected in logic-diagram fashion (see the right half of figure 1). If an instrument is to be used inside another instrument, it must also have an instrument icon, which allows the smaller instrument to be used as a black box in the block diagram of the larger instrument.

### **A SIMPLE EXAMPLE**

We will demonstrate the LabVIEW system with a simple example. Let's say

we want to generate, graph, and store sets of random data points in the range of  $(0, s)$ . (We can store multiple runs of data with the instrument and recall them later, perhaps for use as test data for another instrument.)

Before we start planning the example itself, remember that the random-number function supplied with LabVIEW generates numbers in the range  $(-1, 1)$ . We need a separate virtual instrument that scales a number from the range  $(-1, 1)$  to  $(0, s)$ , where  $s$  is an arbitrary positive scaling factor. Our first task, then, is to create a scaling virtual instrument.

To create a virtual instrument that scales a number from the range  $(-1, 1)$  to  $(0, s)$ , we first have to understand how we are going to calculate this transformation. If we think of the number as a signal to be processed, we might come up with a block diagram for our virtual instrument like the one in figure 2.

First we must add the appropriate controls to the front-panel window (see the left half of figure 1). In standard Macintosh fashion, we call these items up from menu selections in the Controls menu and the dialog boxes that subsequently appear. By clicking on the open-hand icon in the tool palette at the top of the display, the cursor changes to the hand shape, called the Grabber, while it is in the front-panel window. We can then move (and in some cases resize) these controls by using the Grabber. In this example, we use a slider switch to represent the input number to be scaled, an input-only digital readout for the scaling factor  $s$ , and an output-only digital readout for the scaled result.

When we add controls to the front-panel window, the block-diagram window (which appears when you ex-

ecute Open Diagram from the File menu) gains corresponding icons. We create the instrument's design in the block-diagram window in figure 1, using icons called by the Functions menu. Again, we use the Grabber to move icons, and the wiring tool (the spool-of-wire icon in the top row) to draw the connections between icons.

The scaling instrument is now complete. We can test it by using the operate tool (pointing finger) to move the slider switch (thus changing its value) and edit the scale value. When we click on the Go icon on the menu bar, LabVIEW executes the program defined by the block-diagram window and puts the result in the front-panel window. Note that the input value 0,

which is in the middle of the interval  $(-1, 1)$ , translates to 5 on a scale of  $(0, 10)$ .

The two remaining tools in the tool palette are the labeling tool, which is an I-beam cursor acquired by clicking on the large A icon, and the magnifying-glass-shaped help tool, which displays tutorial information on whatever feature of LabVIEW it is used to click on.

This instrument can be saved, recalled, and run as is. However, we must do one more thing to use it in-

(continued)

G. Michael Vose and Gregg Williams are senior technical editors for BYTE. They can be contacted at BYTE, One Phoenix Mill Lane, Peterborough, NH 03458.

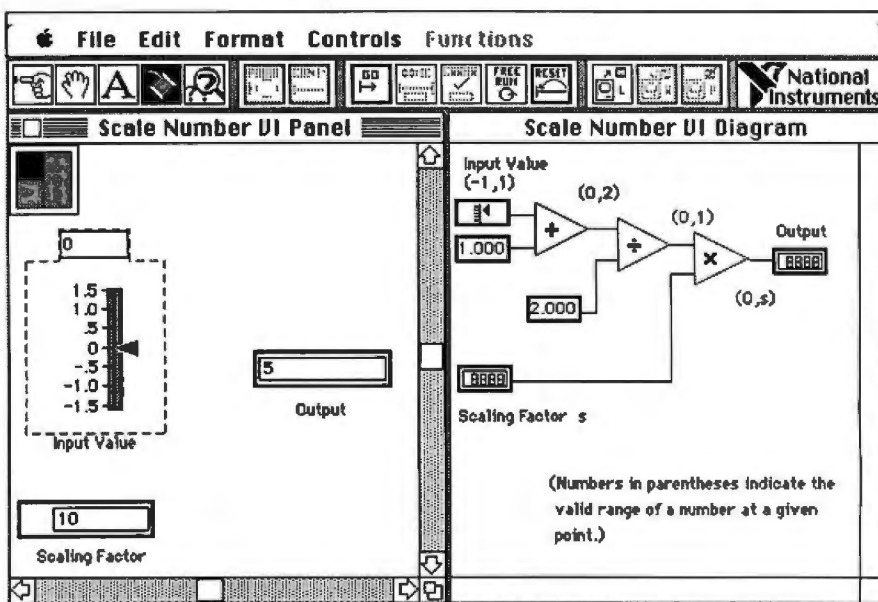

Figure 1: The Scale Number virtual instrument. The left half of this figure contains the front panel for this instrument; it contains two input variables, or controls, and one output control. The block diagram in figure 2 translates directly to the block diagram shown in the right half of this figure. The Input Value slider switch (dashed line) is associated with the upper left corner (blackened) of the instrument's icon.

side other instruments: create a distinctive icon for it. Through selections in the Format menu, you can draw an arbitrary icon, divide its area into rectangular regions, and associate each region with an input or output control. Then within a larger instrument, wires that connect to these regions will be taken as sending or receiving values consistent with the corresponding controls.

The screen dump of figure 1 was taken while the connection points on the scaling instrument's icon were being defined. The icon is represented here by the dark square in the upper left corner of the front-panel window. At this particular moment, the upper left corner of the icon (blackened) is associated with the slider switch (outlined with dashes). The finished icon for the scaling instrument, visible in figure 3, has two inputs, labeled IN and SCA (scale), and an output labeled OUT.

### BUILDING THE GRAPHING INSTRUMENT

The construction of the final instrument, which generates the random numbers and scales and graphs them, proceeds similarly to that of the scaling instrument. (The data can be saved in a step unrelated to the instrument definition.) We begin by creating an input control for the number of points to be generated (e.g., a different kind of slider switch), an input-only numeric window for the scaling factor, and a graphic-output window

(see the left half of figure 3).

The block-diagram window contains several new items. The icon marked IN/OUT/SCA represents the scaling instrument we just designed. The icon with the graphed points is another predefined instrument that takes a list of numbers, pairs the entries with the numbers 0, 1, 2, . . . , and outputs them as a composite structure of data (note the thick striped line) suitable for use by the graphic control. The triangle with the two dice in it is the random-number-generating function.

The most important item in the block-diagram window is the large box that looks like a stack of stationery; in the LabVIEW system, this represents a FOR loop. The contents of the box will be executed a set number of times. The box labeled N determines the number of iterations (here it receives its input from the Number of Points slider switch on the front panel).

As before, to run this instrument, we set the number of data points and the scaling factor using the operator tool, then hit Go. When LabVIEW is finished, it displays the new data in the graphic control, automatically scaling both axes to fit the data.

### CONTROLS

Now that we've seen an example, let's look at the LabVIEW controls in detail.

Controls are the components of the front-panel window that define the inputs to and the outputs from the instrument. Controls are input-only or

output-only, meaning that they will receive values from the front panel or display them.

We have seen numeric controls as both input and output controls. At any time, the user can change the control's appearance, the range of valid values, and other characteristics. (LabVIEW also offers a strip-chart numeric control that displays a running history of the variable's values as they scroll off to the left.) String controls differ from numeric controls in that they hold character strings as values; they usually appear as boxes within which text can appear. Binary controls contain a simple 1-bit value; they can appear as a variety of toggle switches, buttons, and indicator lamps whose appearances change when their states change.

Numeric, string, and binary controls all share the ability to be multidimensional; that is, a single control can represent more than one value. For example, an indicator lamp can be declared as a 2 by 4 by 3 array of binary values. Such a control appears on the front panel as an indicator lamp with three boxes beside it that contain the indexes of the value currently being displayed. By changing the values inside the boxes, you can look at the values of individual elements in the array. LabVIEW supports controls that have up to eight dimensions.

Graphic controls are simpler; as output, they display an ordered set of  $x,y$  pairs as a line graph. National Instruments plans for the graphic controls

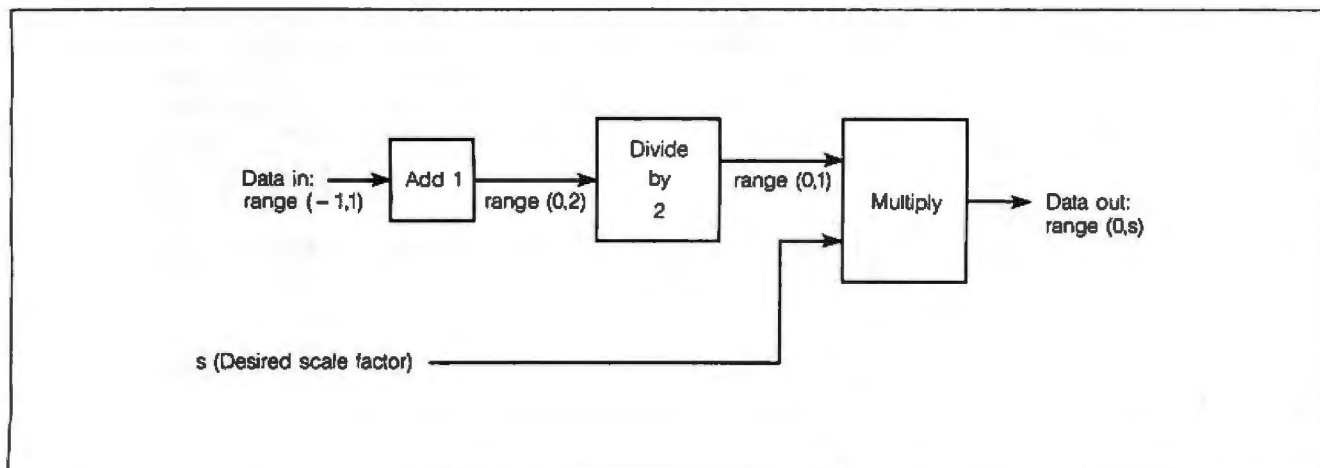

Figure 2: Designing the block diagram. This diagram shows one way to scale a number from the range (-1, 1) to the range (0, s).



to have additional options in the finished product.

The last type of control is a cluster control, which allows you to group an arbitrary collection of data items together so that they can be represented as a single line in the block-diagram window instead of as multiple lines. For example, the  $X(i)$ -versus- $i$  instrument in figure 3 contains a single cluster that transforms the list of  $X(i)$  data and an internally generated list of  $i$  values into the data structure that the graphic-output control requires.

**COMPILED INSTRUMENTS**

The designers of LabVIEW realize that you may need functions that cannot be accomplished with high-level user-defined instruments. They also realize that you may already have data acquisition routines written in a high-level compiled language that you do not want to give up. To meet this situation, LabVIEW has the ability to link the parameters of a compiled subroutine (called, in Macintosh terminology, a code resource file) to front-panel controls. In this way you can tie your routine to an instrument icon and use it anywhere in the LabVIEW system. National Instruments plans to offer Macintosh users the ability to link to routines written in C, assembly language, and FORTRAN, with links to other compiled languages possible in the future.

**G—THE GRAPHICS PROGRAMMING LANGUAGE**

LabVIEW's programming language, called G, uses icons in place of key-words but tosses in a few textural compromises to overcome the intrinsic limitations of a pictographic lexicon. The LabVIEW programmer uses the icons to build the block diagrams that define the function of a virtual instrument.

The language offers a special set of flow-of-control structures and a wiring mechanism to connect them. These wired structures define the flow of data among the parts of a block diagram. In addition, the language provides standard and special arithmetic functions plus a broad array of special functions for input/output,

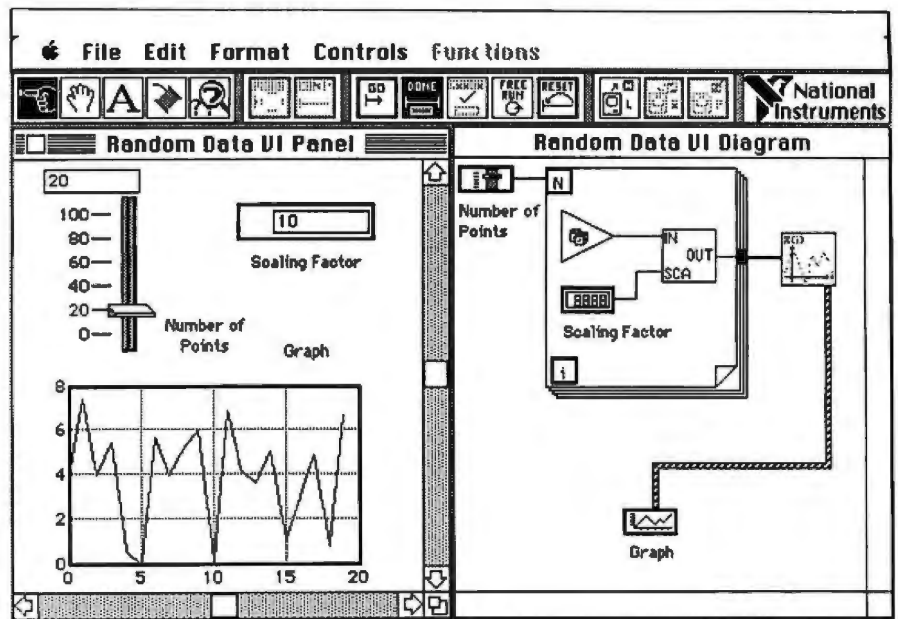

Figure 3: The Random Data virtual instrument. The Scale Number instrument of figure 1 is visible here as the square icon marked IN/OUT/SCA. The Number of Points input drives a FOR loop that scales a random number (the triangular icon) to the range given by the Scaling Factor input control. The instrument then collects the data, scales it, and graphs it.

Table 1: Built-in functions in LabVIEW.

- Arithmetic: +, -, \*, /, \*\* (exponentiation), min, max, neg, abs, inv, AND, OR, XOR
- Comparative: =, not =, >, >=, <, <=, =0, not =0, >0, >=0, <0, <=0
- Transcendental: sin, cos, tan, asin, acos, atan, sinh, cosh, tanh, log, exp, sqrt, ln
- String: string concatenation, substring, parse string, string to numeric, numeric to string, string compare, string length, null-string detection, ASCII-string detection
- Statistical: mean, variance, standard deviation, histogram, mode, median, moments, residues
- Matrix: transposition of dimension, lesser-dimension subsets, subarrays, individual element manipulation, dot product, cross product, matrix multiply, inversion
- Curve fitting: linear, polynomial, exponential
- Signal processing: FFT, inverse FFT, convolution, correlation, power spectrum, integration, differentiation

string manipulation, and scientific and engineering tasks (see table 1 for a list of specific functions available). The compromises to the iconic scheme of the language include a calculator that permits the use of formulas within virtual instruments and a provision for

linking traditional program code to existing instruments.

**BUILDING BLOCKS**

Computer science theorists have shown that any algorithm can be built

(continued)

successfully with three structures: an iterative loop, an IF...THEN...ELSE structure, and a DO...WHILE loop. Any system with these structures can be called a programming language. Using these criteria, LabVIEW's iconic underpinnings can be called a language.

G provides five flow-of-control structures: a sequence structure; an iterative, or FOR, loop; a case selection structure; an indefinite, or WHILE, loop; and a set of shift registers that permit the recursive use of the iterative and indefinite loops. These graphic structures permit structured programming in a data-flow environment.

The sequence structure of G allows the LabVIEW programmer to specify the order of execution of any set of operations. Icons that look like frames of film (see figure 4) represent the separate ordered steps in a series of sequential operations. A number in the upper middle area of each frame displays the sequence number of the frame currently selected.

An instrument's sequence frames execute in strict order; that is, frame one must finish execution before frame two can begin. Interestingly, structures within a frame, such as a FOR structure, can execute in parallel with other such structures. Sequences, however, like nodes in a traditional data-flow model, cannot execute until a prior condition is satisfied, namely, the arrival of dependent data. Sequences help, in fact, to defeat LabVIEW's inherent parallelism. For example, in a three-sequence instrument, you cannot specify that execution begins with the second frame in

the sequence; execution always begins with the first frame. The execution signal for the start of the second frame in the sequence is the availability of all outgoing data at the border of the first frame.

Variables within a sequence frame are local to that frame, but local variable data can pass from a lower-numbered frame to a higher one.

The G control structure for iterative operations is a FOR loop (see figure 4). A pair of special variables local to the loop hold the total number of iterations and the value of the current iteration, or index. It is possible to pass arrays of data into an iterative loop or to perform operations on individual elements using the value of the index to extract values. All the operations placed inside the icon representing the loop execute for every iteration of the loop.

The case selection structure in G permits you to execute several operations within the structure by using a selector value to determine the operation to be performed. The selector value must be an integer between 0 and  $n$ . You must use the case structure to perform the equivalent of IF...THEN...ELSE comparisons in G.

The indefinite, or WHILE, loop is similar to the FOR loop with one major difference. Loop execution depends on a test of a specified condition, usually a Boolean conditional. As with FOR loops, you can pass data arrays into the loop. You can also pass individual array elements into an indefinite loop. Even though the LabVIEW manuals call this a WHILE loop, it is actually an UNTIL loop that

always executes at least once, even when the conditional is set at zero.

The shift registers of G allow an iterative or indefinite loop to execute recursively. A shift-register set includes a leaf node and two or more root nodes. You can use multiple sets of shift registers. Since many programming situations demand the use of past, or existing, data, G's shift registers offer a method for accumulating this data. The data shifts from register to register, with the initial value of the leaf node passing to the first root node and that node's value passing to the second root node.

### CONNECTING THE PARTS

Since the underlying programming model for G is data flow, the connections between control structures, constants, variables, and input/output controls are extremely important. The iconic representation of the paths on which data flows among the G components is wire. The wiring tool is used to connect block-diagram parts. The appearance of a wire reveals details of the type of the data that travels that path. For example, a thin wire represents a flow of single numbers, while a medium-size wire with a hatched border represents a multidimensional array of strings (see figure 5). A dashed wire denotes a bad connection, which is a data path that is not possible.

When G programmers connect two G program structures together with the wiring tool, they do not have to know what kind of wire to use. G chooses the appropriate data type for

(continued)

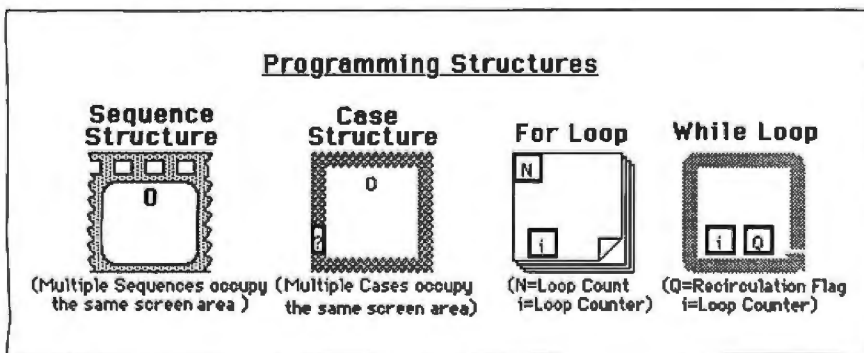

Figure 4: The flow-of-control structures of G, LabVIEW's underlying iconic programming language.

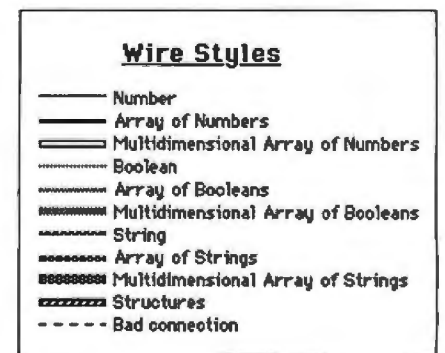

Figure 5: The wire types of G and their associated data types.

# The BIGGEST reason to buy the FASTCOMM™ 2496 is that it adds Top Speed for Bottom Dollar.

*past...* Here are 8 more.

The FASTCOMM 2496 is designed for PC to PC, mini and mainframe users who need all popular baud rates—9600—as well as 2400, 1200 and 300. You can do more than ever before with your modem and you can do it now!

## #1 ... more modem for your money.

The FASTCOMM 2496 includes 300-2400 baud for interactive work and play. When it comes to high-speed downloading—switch to 9600 baud with a simple AT command. You can transfer full diskettes of data in less than 10 minutes! Say goodbye to excessive long distance charges!

## #2 ... with error-free reliability.

What's more, at high data rates, the modem's built-in error detection-correction protocol ensures error-free transmission when phone lines get too "noisy." Constantly monitoring the line, FASTCOMM 2496 quickly bounces you back to top speed when the lines clear. Your data remains intact and error-free! You get optimum performance without the worry!

## #3 ... you can choose the flexibility of an internal modem.

The FASTCOMM 2496B may be the version for you! Ideal for PC applications, this half card inserts into any full or short expansion slot in your IBM PC, XT, AT or compatible, leaving you more room for other expansion uses.

## #4 ... or choose the portability of an external modem.

Our external version—the compact FASTCOMM 2496—is a superb choice for PC terminal to mainframe applications. Its LED status indicators and speaker control make for easy monitoring during operation.



The FASTCOMM 2496B Half Card.

## #5 ... or choose only the speed you need, now.

Start with either our FASTCOMM 9600 or 2400, at even lower prices. Later, snap in additional speeds by purchasing our FASTSNAP boards, available for both the external or half card modem.

## #6 ... customize your modem to suit your needs.

With FASTCOMM's non-volatile memory, make changes that stay. Set defaults today, even on your remote modem using the ATY Command, and you'll have them tomorrow! And whenever you autodial, FASTCOMM automatically sets the speed of the receiving modem to match your baud rate!

## #7 ... supported by popular communications software.

The FASTCOMM 2496 runs with virtually any asynchronous communications software that can support 9600 baud, including *Crosstalk XVI*, *Carbon Copy*, *Respond*, *Relay Gold*, *Q Modem*, *Blast* and *SimPC 3278*.

## #8 ... and you get top to bottom service.

Call our toll-free number and your modem will be on its way within 24 hours! If you're not totally convinced the FASTCOMM 2496 sets a new high in speed, flexibility, and savings, return it within 30 days for a full refund.

And there's more—dial up our FASTCOMM Bulletin Board for user tips, or our customer service representatives for support. And, if you should ever need it, the FASTCOMM comes with a two-year warranty.

**Call 800-521-2496, ext. 18 (in Virginia (703) 620-3900) today!**

### COMPARE THE ADVANTAGES FOR YOURSELF

| Manufacturer    | 300, 1200, 2400 | 9600         | 2496         |
|-----------------|-----------------|--------------|--------------|
| <b>FASTCOMM</b> | <b>\$619</b>    | <b>\$899</b> | <b>\$999</b> |
| HAYES           | \$795           | NA           | NA           |
| NOVATION        | \$795           | NA           | NA           |
| RACAL VADIC     | \$695           | NA           | NA           |
| VENTEL          | \$695           | NA           | NA           |

Fastcomm Data Corp. is an Electronic Vaults, Inc. company.

All product names are trademarks of their manufacturers.



the data path based on the kind of structures that are being connected. G knows, for example, that plotting values on a graph means that the data flowing to the graph will be at least a two-dimensional array of numbers.

The appearance of the wires often changes at the border of a control structure due to data transformations taking place at the border. The values that a FOR loop's operations generate, for example, accumulate into an array at the loop border, and this array of values travels along a data path to another component. In this way the change in the appearance of the wire from a thin line to a thicker line signals that a data transformation has occurred.

LabVIEW programmers have four basic data types at their disposal: real numbers and arrays of reals, Booleans and arrays of Booleans, strings and arrays of strings, and structures that are analogous to structures in C.

#### CONSTANTS, VARIABLES, AND ARITHMETIC FUNCTIONS

You load G program variable values into controls on an instrument's front panel. The controls represent variables on the underlying block diagram, and these values are then used when the program, the virtual instrument, runs. Constants function similarly except that you load their

values at the block-diagram level.

Arithmetic functions in G are as rich as in any other imperative language. Addition, subtraction, multiplication, and division are supplemented by complex functions such as exponentiation, binary and logical functions, transcendentals, and special functions like square root and random-number generation. Table 1 lists the full set of available functions.

A calculator solves the problem of screen clutter for implementing complicated formulas or equations in G. One of the calculator's inputs takes a string containing one or more formulas and uses this formula string to process up to five numeric inputs to produce up to four numeric outputs. The calculator is itself a virtual instrument, and its underlying block diagram can be displayed to aid in the debugging of entered formulas.

#### INPUT/OUTPUT, STRING, AND OTHER FUNCTIONS

The LabVIEW system's design targets scientists and engineers as primary users. The system's designers have incorporated within the G language a number of specialized functions aimed specifically at these users.

In addition to standard file input/output functions, LabVIEW provides built-in functions to manage GPIB communications between a Macin-

tosh and stand-alone instruments or board-level devices. These functions go beyond merely passing ASCII strings containing GPIB commands, providing functions to reset the bus, triggering instrument events, and giving GPIB status information.

A variety of signal-processing functions, like fast Fourier transform, convolution, correlation, power spectrum, integration, and differentiation are planned in the release version of LabVIEW, although they were not in the software we worked with. National Instruments also promises statistical functions, matrix manipulation functions, and curve-fitting routines in the initial release of LabVIEW.

#### CAVEATS

When we wrote this article, there were a number of claimed features for LabVIEW that were not yet complete so we cannot describe exactly how they will work. We worked with at least three pre-beta versions of LabVIEW over a period of three months in compiling this preview, the last of which was version 0.35. We found that the mechanism for programmable data retrieval of past instrument runs was unreliable. The Options function for choosing certain features of input/output controls wasn't working, and several of the planned built-in func-

(continued)

## You already own a computer that can talk. Now let it. Meet the Votrax Family of Voice Products.

- ★ **P.C. DialLog**  
Televoice management system  
Digitizes your voice  
Saves and sends voice messages  
Auto answer/Auto dial  
Call store and forward  
Message distribution  
P.C. to P.C. communication  
For IBM-PC, XT, AT and compatibles
- ★ **Votalker IB & AP**  
Board level speech synthesizers  
Unlimited vocabulary  
Text-to-speech software  
Voice mode selection switch  
Speech filter selection switch  
For IBM-PC, XT, AT and compatibles  
For Apple II, IIE, II Plus and compatibles
- ★ **SC-01 - SC-02**  
Phonetic speech synthesizer chips  
Unlimited vocabulary

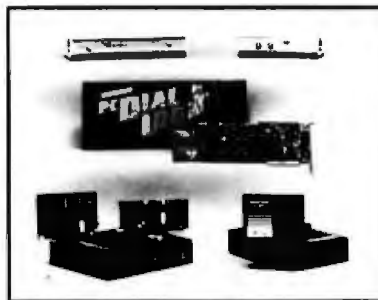

Now you can upgrade almost any personal computer and make it more powerful than ever, by giving it the power of speech.

- ★ **P.S.S. & T.N.T.**  
Stand-alone speech synthesizers  
Unlimited vocabulary  
Text-to-speech  
Parallel/RS-232 compatible  
Exception word table  
On-board music chip  
Adaptable to most computers
- ★ **Votalker C-64**  
Plug in speech synthesizer  
Unlimited vocabulary  
Text-to-speech  
Rate, volume and pitch control  
Three speaking modes  
Free trivia game  
For Commodore C-64/128
- ★ **Software Developers Welcome**
- ★ **Dealers and Distributors Welcome**



1394 Rankin, Troy, Michigan 48063  
1-800-821-1393  
In Michigan 313-688-0341  
For a voice demonstration call  
313-688-2926

# Introducing the 10/6 MHz Multitech 900 Innovation without compromise



The high-performance Multitech 900 is your innovative alternative in an AT system.

## Poised to run faster.

The Multitech 900 operates at 6 or 10 megahertz. With this speed advantage switching from 6 to 10 megahertz cuts processing time almost in half — you spend less time waiting for the information you need to analyze.

## Bundled Soft-white display.

A high-resolution, non-glare, soft-white display and monochrome-graphics adapter are included with your Multitech 900 — not priced separately.

## Price/performance breakthrough.

At \$2,395 the Multitech 900 delivers the high-performance you demand in

an AT system but at an affordable price to fit within all budgets.

## Uncompromising.

While the Multitech 900 introduces innovation it doesn't compromise any industry standards.

For example: *Software compatibility* with programs designed for the IBM PC/AT and PC/XT; *hardware compatibility* to tie into your networking options; full *one-year warranty* and guaranteed *support* from Multitech, a company with a proven track-record in quality microcomputer manufacture; and, *Nationwide service\** that is convenient and dependable. Call us today for more information about the Multitech 900 or our full line of personal computer products.

|                       | CPU Speed                                                | Mother-board Memory     | Max. # of Half-Height Internal Drives | Display                | Operating System | Warranty Period | Suggested List Price |
|-----------------------|----------------------------------------------------------|-------------------------|---------------------------------------|------------------------|------------------|-----------------|----------------------|
| Multitech 900         | 10 or 6 MHz<br>Keyboard, Software or Hardware Switchable | 512K RAM<br>Up to 1MB   | 5                                     | Hi-Res.,<br>Soft-white | MS-DOS 3.1       | 12-Months       | \$2395               |
| IBM PC/AT             | 8 MHz Only                                               | 512K RAM<br>Up to 640K  | 3                                     | Option                 | Option           | 12-Months       | \$5295*              |
| Sperry PC/AT          | 6, 7, 16 or 8 MHz<br>Hardware Switchable                 | 512K RAM<br>Up to 1 MB  | 4                                     | Option                 | MS-DOS 3.1       | 12-Months       | \$3395               |
| Compaq Deskpro 286    | 6 or 8 MHz<br>Keyboard & Software Switchable             | 256K RAM<br>Up to 2.2MB | 4                                     | Option                 | Option           | 3-Months        | \$3395               |
| Tandy 3000            | 8 MHz Only                                               | 512K RAM<br>Up to 640K  | 3                                     | Option                 | Option           | 3-Months        | \$2599               |
| Televideo Telecat-286 | 6 or 8 MHz<br>Keyboard & Software Switchable             | 512K RAM<br>Up to 1MB   | 3                                     | Hi-Res.,<br>Green      | Option           | 3-Months        | \$2995**             |

\*Includes 30MB Hard Disk Drive  
\*\*Includes 20MB Hard Disk Drive

All prices reflect manufacturers' suggested list for base models as of June 4, 1986

Multitech 900 is a trademark of Multitech Electronics Inc.  
All other product names are trademarks of their respective manufacturers



Committed to Excellence, Quality & Service

1012 Stewart Drive  
Sunnyvale, CA 94086  
Tel: (408) 773-8400  
(800) 538-1542

A Division of MSC International  
\*Serviced Nationwide by TRW

tions were not yet available. Some of the alternate graph styles were not yet added. These alternate graphs will include polar plots and scattergrams as well as the ability to plot multiple sets of data on one graph.

### CONCLUSIONS

Many of LabVIEW's features show great promise. Its pop-up menus are context-sensitive; the menu you get depends on the icon you are touching when you call for it. These contextual menus make creating front panels and block diagrams easier and less prone to error. Pop-up menus are consistent with the Macintosh user interface and

are usually better than the dialog boxes that they replace.

The amount of housekeeping that LabVIEW performs—letting the programmer forget about data types, for example—makes the system easy to use by not requiring you to be a programmer. LabVIEW does type-checking automatically, and there is essentially no such thing as a syntax error (dashed lines representing improper wiring connections excepted) when using icons for programming. LabVIEW initializes and maintains loops automatically, and its block diagrams make programs self-documenting.

The metaphor of the front panel

and its underlying block diagram is intuitive and creates a comfortable user interface. The different versions of LabVIEW that we've seen show a good design sense with the addition of new features when necessary.

Logical debugging of block diagrams can be tedious, however. The program's multiple cursors (tools) can be confusing, such as deciding whether to use the Grabber tool or the Pointer. The system is also constrained by its application being limited to engineering uses and by its existence on a Macintosh in a world dominated by IBM PCs.

There are some intrinsic contradictions in LabVIEW. What LabVIEW calls a WHILE loop is actually an UNTIL statement. The case icon must be used for an IF...THEN...ELSE construct.

The screen space within a block diagram may be a limiting factor in LabVIEW's practical application. A single virtual instrument can't be very complex since there's room for only a finite number of operations within a single screen. You can nest virtual instruments without limit, but this doesn't guarantee that you can build complex structures with 10 or 20 branches versus the 2 to 3 branches that can easily fit on a screen.

LabVIEW uses the Macintosh's SANE math library, providing full IEEE-754 floating-point compatibility. SANE yields 80-bit precision for floating-point operations and gives a dynamic range of  $-1.7E-4932$  to  $1.1E+4932$ . Loop counters are always cast to integers and are currently limited to the range 0 to  $2^{32}$ .

National Instruments claims that LabVIEW's performance is equal to BASIC's, but many laboratory applications may require better performance than that. However, the capability to link code resources to virtual instruments may negate this performance limitation.

Overall, using LabVIEW is an exciting experience that may give us a peek into the future. Will the data-flow programming model and object-oriented programming techniques merge into an iconic language of the future? Maybe LabVIEW is a step in that direction. ■

## USING LABVIEW IN THE REAL WORLD

National Instruments specializes in computer and GPIB hardware interfaces and software. They developed LabVIEW as the next generation of software to help users of data acquisition equipment to control this equipment with computers. They now have one product, the GPIB-MAC interface box, which will work on a 512K Macintosh or Macintosh Plus, and another product under development that will connect to a Macintosh Plus through its SCSI port.

National Instruments has been shipping the \$595 GPIB-MAC interface since November. It plugs into the modem port on the Macintosh and makes a GPIB plug available for one or more instruments. (GPIB plugs can stack on top of each other, allowing instruments to be connected in a star pattern.) Currently, custom programs can send GPIB commands and receive results as if through a modem. From LabVIEW, however, the virtual instrument designer can use six different GPIB-related icons in the block-diagram window, including one that passes an arbitrary string to the GPIB bus.

MacBus is a \$1495 hardware and software combination that provides a GPIB interface, five IBM PC AT-compatible interface card slots, and various necessary software packages. Its card cage connects to a Macintosh Plus through its SCSI port. Two slots are taken up by the GPIB interface card

and a microcomputer card containing the NEC V50 chip, which coordinates the Macintosh Plus and the GPIB interface. Backplane circuitry is reported to generate a subset of the IBM PC AT bus. The V50 chip controls the GPIB circuitry through a FORTH-like extensible proprietary language called IBCL, and National Instruments supplies interface routines that allow the user to control and program MacBus from Megamax C or Microsoft BASIC. Although details are not final, users will be able to access existing IBM PC and PC AT cards by some sort of memory mapping; this method will require a custom device driver to interact with the LabVIEW system.

However, even when users have the hardware and software connections to GPIB, their job may not be finished. GPIB commands are terse and cryptic (e.g., rd #16 5 reads up to 16 bytes from the device at address 5), and many users have difficulty writing the correct commands for a given task. Because of this, National Instruments thinks that virtual instruments could be useful as front ends that take a command from the front panel and build and execute the proper GPIB string. National Instruments may supply front-end virtual instruments for selected popular GPIB instruments. Customers could then use these virtual instruments as is or modify them to fit a similar piece of equipment.

# DATA ACQUISITION WORKSTATION

## System 570

- **ANALOG INPUTS:** 32 single-ended or 16 differential. 12 bit, 31 kHz.
- **ANALOG OUTPUTS:** Two, 12 bit.
- **DIGITAL INPUTS:** 16.
- **DIGITAL OUTPUTS:** 16 + 16 power control.
- **SOFTWARE:** IBM PC and Compaq compatible. Comes with Soft500: Interrupt driven BASIC environment. Also works with DADiSP, ASYST, LABTECH NOTEBOOK.
- **EXPANSION SLOT:** Choose one of 16 optional modules.
- **\$1295**, complete with Soft500 software.



For complete information CALL  
**1-800-552-1115**

**KEITHLEY**

# “If you can



EVEREX Streaming Tape Family

If you can find a company with better tape achievements, buy from them:

- Over 30,000 streaming tape sub-systems, ½ height, 5¼” form factor industry standard QIC 24 recording format, QIC-36 hardware interface and largest installed customer base worldwide.
- Over 100,000 industry standard streaming tape controllers in the field.
- The first company to release QIC-02 IBM-compatible software drivers to the OEM community.
- The first company to release an internal 5¼” half-height IBM compatible tape subsystem.
- The first company to release file-by-file retrieval from a mirror-image backup.

If you can find better streaming tape software, buy it:

## User Interface

- Menu driven.
- Multiple windows (nestable and movable).
- Context sensitive on-line help.
- File selection from directory listing or command line.
- Constant tape status display.
- Menu driven hardware configuration guide.

## Tape Functions

- Multiple tapes allowing unlimited backup capacity.
- Multiple datasets for multiple backups on the same tape.
- Tape sequence management recorded on the tape.
- Programmable messages.
- File-by-file and image backup on the same tape.
- Installation program.

## Functionality

- Physical image backup/restore of local disks.
- Logical image backup/restore of local or remote disks.
- File backup from any local or remote disk of any file size.
- File restore from image backup or file backup.
- Allows wildcards for selection of files.
- Automatic scheduler for unattended backups.
- Backup across networks (using logical image or file-by-file).
- Real time clock display.
- Backup any disk whether formatted for DOS or not
- Escape to DOS while in backup/restore operation.

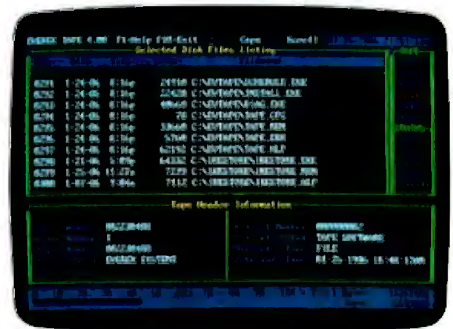

Automatic Scheduler

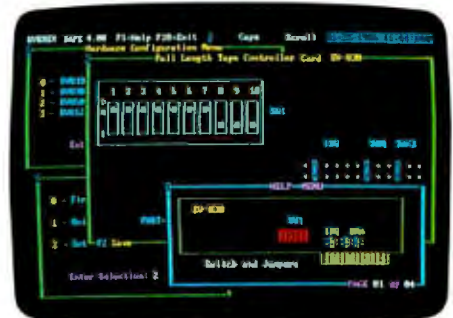

Nestable, Movable Windows



# find...



Backup with Multiple Datasets



Multiple Tape Restores

**If you can find a streaming tape with better performance and system characteristics, buy it:**

### Performance

- File-by-file operations near streaming speed.
- Dynamic adjustment to disk and system speeds.

### System Characteristics

- Hardware identification provides software integrity.
- External systems can be shared with many users.
- Same software for all types of tape drive, controller, and computer system configurations
- External systems uses a shielded round cable with a D-connector for tangle-free, easy connect and disconnect.
- Hardware read-after-write data verification.
- Track 0 seek to insure tape interchangeability.
- Original controller manufacturer.
- Industry standard QIC-24 tape format.
- Industry standard QIC-36 interface.
- Industry standard QIC-02 commands.
- Tape does not require pre-formatting.
- Available in 20MB, 60MB, and 100MB drive capacities.

# ...buy it!"

### EVEREX Excel Streaming Tape.

For the name of your nearest EVEREX dealer or more information, call us. Remember... We are **EVER** for EXcellence.



Excel Stream 20 Internal



Excel Stream 60 Internal



Excel Stream 60 External 1/2 Height

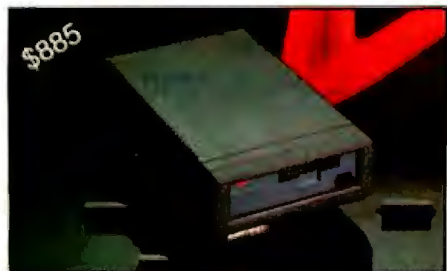

Excel Stream 20 External



Excel Stream 60 External



Excel Stream 60-8 External

**EVEREX**  
EVER for EXcellence™

1-800-821-0806 1-800-821-0807 (in CA)

48431 Millmont Dr., Fremont, CA 94538

Inquiry 123 for End-Users. Inquiry 124 for DEALERS ONLY.



## COMPLETE EVERY FILE TRANSFER PASS.

**The problem:** Error-free file transfer between any IBM PC/XT/AT/Portable\* (or a 100% compatible) and another personal computer—or any mainframe that supports one of these protocols: 3780, 3741, 3740, 2780, or 2740.

**The solution:** PC3780 from TDT Group—chosen by the United States Air Force, Occidental Petroleum, Blue Cross Blue Shield (Nebraska). This synchronous emulator takes

the guessing out of file transfers, lowers the dollar and energy cost of accuracy. With our software and key, one disk drive, a modem and an IBM BSC card\*, you can enter the world of IBM mainframe data communications. Call now!

**Minimum required configuration:** 128 Kbyte RAM, a 320 Kbyte disk drive or fixed disk and an IBM BSC-ASM\* card installed in an IBM micro or 100% compatible.

\*IBM is the Registered Trademark of International Business Machines Corp.

**30-Day Money-Back Guarantee! TO ORDER TOLL-FREE 1-800-826-7839  
SHIPPED VIA U.P.S. \$249**

Price includes archival diskette, software key, user's manual.

# TDT

Rivergate Plaza, 444 Brickell Avenue, Suite 902, Miami, Florida 33131. (305) 372-9332/TELEX: 4947306

# BUILD A HARDWARE DATA ENCRYPTOR

BY STEVE CIARCIA

*This easy-to-build device  
is extremely difficult to crack*



It's 4:00 a.m. Do you know who has logged on to your electronic messaging system? Theophilus Cracker has spent all night trying to get into the files on your latest research project, and he has finally made it. All your efforts and careful planning are about to go down the drain, as the contents of the stolen library are listed on his screen.

But wait, what is this? Why the blank expression on his face? Has he been thwarted by a little black box? Will he go sleepless and hungry trying to figure out why it all looks like trash?

Whether gaining access to sensitive data presents an interesting challenge to the cracker or whether there's a malicious ulterior motive in mind, the violation of your private electronic communication is the same. Fortunately, it can be prevented.

The Circuit Cellar data encryptor is intended to provide an additional level of privacy. With the feverish rush to install the latest and best electronic data and messaging systems, individuals and companies frequently overlook who has access to sensitive materials until something turns up in the wrong place. Rather than requiring password access to all materials of a certain security level within a computer system, data encryption allows individually desig-

nated data access. The delivery of a message "For Mr. Jones's eyes only" becomes an easily achieved reality merely by controlling the dissemination of the encryption keys.

Electronic data should be managed and protected with the same attention given to your bank account. The electronic messaging system that you just installed to coordinate all your branch offices with your on-the-road field service personnel might actually be a comprehensive accounting of your business's current vulnerabilities in the hands of a competitor. Or someone may accidentally log on to a very sensitive memo to the branch managers about recent pay scales.

I'm not attempting to be a harbinger of doom. I'm just trying to point out some things that you may have overlooked. I could hardly have kept your attention if I described anything less than a worst-case scenario.

In reality, vulnerability is a function of access and content. More simply stated, this translates to "who can get their hands on

*(continued)*

Steve Ciarcia (pronounced "see-ARE-see-ah") is an electronics engineer and computer consultant with experience in process control, digital design, nuclear instrumentation, and product development. The author of several books on electronics, you can write to him at P.O. Box 582, Glastonbury, CT 06033.

what." Even the simple one-line telephone bulletin board has a system operator. If installed in a moderate-size business, a few other people would probably have complete access to the electronic database.

At the point where the number of "whos" who should have access to all the "whats" is greater than 0, you

have to think about alternatives.

Because there are more programmers than hardware designers, the predominant approach to system security has been in application software. The techniques most frequently employed to improve computer security are reducing the "whos," individually categorizing the "whos"

(passwords), limiting the posting of the sensitive "whats," or individually categorizing (more passwords) or encrypting the "whats."

These methods have had relative success in minicomputers and mainframes, where there is enough horsepower to maintain a menu-driven, stratified security level, password-

## CRYPTOGRAPHY BACKGROUND

After World War I broke out, American Telephone & Telegraph realized that a system was needed to guard messages sent between its new printing telegraphs. These early teletypes used Baudot code to transmit the 26 letters of the alphabet, the 10 digits, an assortment of punctuation marks, carriage return, line feed, shift-to-figures, and shift-to-letters. There were 32 different combinations of marks (1s) and spaces (0s) making up the 5-bit code.

Gilbert S. Vernam solved the problem in December 1917 with a system that now bears his name and that is the heart of most stream-encryption systems in use today. Vernam sought a system where a key is combined with a plaintext character to produce a cipher character in a reversible way such that if the same key were combined with the cipher character, the original plaintext character would be recovered. The system he employed to combine the plaintext character with the key is an exclusive-OR of each pair of bits to form the ciphertext character. A truth table of the exclusive-OR function will show that the system is reversible, as shown in figure A.

A key bit of 1 causes a plaintext bit

to reverse to form a ciphertext bit. Applying the same key bit again would reverse the ciphertext bit to recreate the original plaintext bit. A key bit of 0 causes the plaintext bit and ciphertext bits to remain unchanged.

The Vernam system drew a lot of interest, particularly from the Navy, because it was the first encryption system that did not need a cipher clerk and the first to encrypt on-line without any delays. But it had a flaw, which the engineers who worked around Vernam discovered.

During early development, key tapes were short loops of tape bearing characters picked from a hat. It didn't take the engineers long to discover that the Vernam system was polyalphabetic, permitting a Kasinsky solution. One of the engineers, Lyman F. Morehouse, solved this problem by combining two short key tapes of slightly different lengths (in effect encrypting the message twice). If one key tape was 1001 characters long and the second was 999 characters long, the resulting key would be 999,999 characters long. The cipher is still polyalphabetic, but it has 999,999 alphabets.

Vernam's system was patented in July

1919, but it did not gain wide acceptance until the Army started using it when World War II broke out.

### HOW SECURE IS MY ENCRYPTOR?

Generating every possible key is not a practical way to break the Circuit Cellar data encryptor because the key is a pseudorandom bit stream that repeats every 18,014,396,353,609,729 bits. Once it is initialized with a user key, the key sequencer is stepped eight times each time a character is encrypted. Not knowing what the initial bit pattern in the sequencer was would require that every possible pattern be tried to decode a message. With each trial, part of the message would be decrypted by using the trial key and examining the results for meaningful words or numbers. Generating the trial key is easy. Testing to see if the decrypted text is meaningful would require some clever programming.

Another technique, the most-probable-word method, is more or less a reverse of the previous one. Instead of guessing at the key and looking for strings of characters that look like words or numbers, a string of characters is assumed to be at a certain location in the text. For instance, it might be assumed that the sender has sent a letter and put "Dear Sir," at the beginning. Knowing this, and assuming its exact location in the message, the key that encrypted that word can be determined.

In reality, this is just part of the solution. The real work is trying to determine the rest of the key from this small segment of the key. This cracking scheme is further complicated by the technique called diffusion, which makes it almost impossible to regenerate the pseudorandom bit streams from even a large sequence of known key bits.

|     |           |            |     |            |           |
|-----|-----------|------------|-----|------------|-----------|
|     | plaintext |            |     | ciphertext |           |
|     |           | 1 0        |     |            |           |
| key | 1         | 0 1        | key | 1          | 0 1       |
|     | 0         | 1 0        |     | 0          | 1 0       |
|     |           | ciphertext |     |            | plaintext |

**Figure A:** A key bit of 1 causes a plaintext bit to reverse to form a ciphertext bit. Applying the same key bit again would reverse the ciphertext bit to recreate the original plaintext bit. A key bit of 0 causes the plaintext bit and ciphertext bits to remain unchanged.

directed communication maze. Unfortunately, most of the recently introduced low-cost microcomputer-based electronic messaging systems and bulletin boards cannot offer this much security, and the user must resort to other means if portions of the database are to be truly protected. The most secure and cost-effective solution is hardware data encryption.

### A DESIGNER'S DILEMMA

This article presents an encryption device that is easy to understand, easy to build, easy to use, but which is very difficult to break.

In building this project, I faced a dilemma regarding the hardware. As with any complex task, there are a multitude of solutions that are usually a trade-off of time and materials. Unlike most designers, who do a one-of-a-kind project and document its use, most of my projects end up being manufactured. While this absolutely demonstrates that the published design indeed works, sometimes the design that is best to manufacture is not the best to use as the basis of an article.

Engineers with lots of manufacturing experience (and the responsibility for making a product successful) instinctively know the algorithm that compares R&D, production costs, and volume. Hardware solutions, while low on initial R&D expense, can be infinitely more expensive to manufacture than a well-thought-out hybrid microcomputer-based hardware/software approach.

The solve-it-quick-it's-only-an-article hardware encryptor is a real kludge. It requires at least 25 TTL chips just to perform the encryption, takes a lot of printed-circuit-board real estate, and is fairly inflexible to functional modification. On the positive side, the building-block SSI/MSI-level interconnections provide convenient functional separations allowing easier explanation.

If I merely wrote articles and never wanted people to use the designs, the answer would be easy (I'll never live down not having PC boards for my serial EPROM programmer. Next month I'll do it right). Rather than redo the encryptor to make it manufac-

turable, I looked very carefully at its component count and performance objectives. The conclusion I came to was to describe and produce the one design that was actually worth building.

### ENCRYPTION TECHNIQUES

Many techniques for encrypting data are available: the RSA public-key encryption system, Lucifer, DES (the data-encryption standard), and variations on the Vernam cipher.

DES, considered among the most effective, is the system chosen by the government and the military. Lucifer and DES are very similar and complex enough to make them difficult to implement on a small computer without dedicated VLSI encryption logic. RSA, developed at MIT in 1977 by Ron Rivest, Adi Shamir, and Len Adleman, is copyrighted; its users must pay a royalty to the copyright owners. This system is not suitable for implementation on a small computer because it involves a lot of large-integer arithmetic.

RSA, Lucifer, and DES are block ciphers, meaning that a block of characters (64 bits or 8 characters for DES, 100 characters for RSA) are encrypted together so that each output block is a functional combination of the complete key and input block.

The Vernam cipher is a stream cipher, meaning that each bit of the encrypted data is a function of only 1 bit of the original data and 1 bit of the key. If the signal gets distorted and causes a bit to be misinterpreted, only that bit will be incorrect in the deciphered text. If a bit is misinterpreted when using a block cipher, the avalanche effect will cause the entire block to be affected. In any encryption system, however, if a whole character is lost or added, the rest of the message will be garbled unless some special text-blocking system is employed to resynchronize the decryptor. Then, only one block will be garbled.

### THE VERNAM CIPHER

I chose the Vernam cipher over DES for this project because it is easy to implement in hardware or in software and it offers adequate security for

*If a cracker  
tested 10 million  
keys per second,  
it would take  
28 years to find  
the correct one.*

anything but the most sensitive communication. While it might seem more intriguing to build a DES-based encryptor, such an endeavor involves either expensive DES encryption chips or bureaucratic involvement in licensing arrangements. I like Circuit Cellar projects to be buildable, and warning labels with abbreviations like NSA and CIA only complicate the task.

While my encryptor could conceivably be used for DES encryption in addition to or instead of the Vernam cipher, I have decided to presently stay with the latter as a published presentation (if the entanglements are resolved, the additional features can be implemented by simply changing an EPROM). Even though the Vernam cipher is simple, it is an effective cipher. The most obvious technique for breaking a cipher is by trying every possible key. The key in this implementation is a pseudorandom bit stream almost  $1.8 \times 10^{16}$  bits long. If an attacker were able to generate and test 10 million keys per second, it would take 28 years, on the average, to discover the key. (See "Cryptography Background" on page 98.)

### CONNECTING AN ENCRYPTOR

Two of the primary design objectives of my data encryptor were that its operation should be transparent to the terminal or computer that it was connected to and that it would be usable with any system. The data encryptor connects to your computer through a serial port (see figure 1). A second encryptor, functioning in decryption mode, is needed wherever

*(continued)*

the scrambled data is received and used (except in loopback mode to encrypt data files on a single system).

The transmitter converts the data output from your computer or terminal to encrypted binary or encrypted ASCII data for transmission to another system. The receiver section takes encrypted text and decipheres it into plaintext that is then presented to your computer or terminal. Both transmitter and receiver sections have serial ports that share a common baud rate and configuration settings; otherwise, they are independent channels. You can encrypt data in one key and decrypt in another as well as send encrypted text while receiving plaintext or vice versa.

If messages are being encrypted for storage on either your own disk drive (figure 1a) or on the storage facilities of an information service (figure 1b), only you need to know the key. If, however, messages are being encrypted and transmitted to a second party (figure 1c), both persons must have the key before the message can be decrypted. The key must thus be delivered to the receiving party by secure electronic communication or manual delivery. It is advisable to change keys occasionally, in case someone discovers it and uses it.

**THE BRUTE-FORCE APPROACH**

My first encryptor design used the brute-force hardware approach

because it easily explained Vernam cipher encrypting. However, this approach was dismissed early. It was not prototyped nor was the schematic fully completed. I caution you that, while parts of it are shown as schematics, these should be treated more as functional block diagrams with connecting wires. They are included merely to explain the internal logic of an encryptor and the cost benefit of performing the same functions in software where applicable.

Figure 2 shows a functional block diagram of a typical hardware-implemented Vernam cipher encryption device (when the terms "encryptor" or "encryption" are used to specify a complete device, they also usually in-

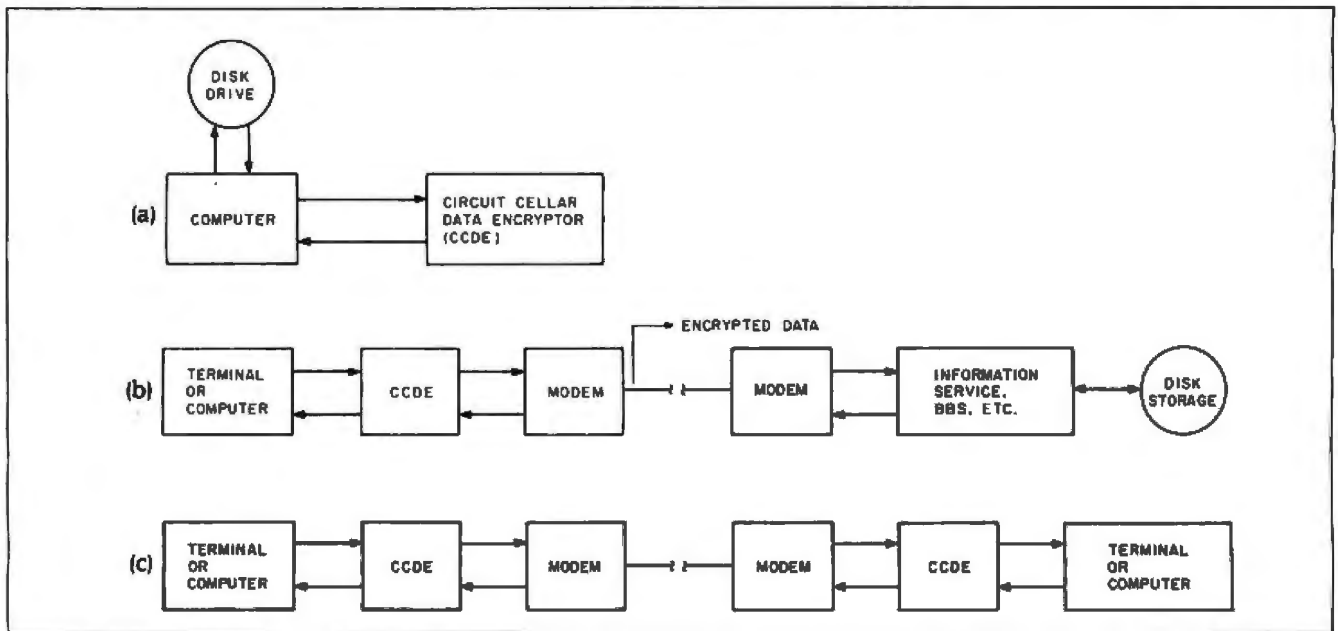

Figure 1: (a) The data encryptor connected in loopback mode. Data is encrypted before being stored on disk. (b) A single-ended data-encryption system. Data is encrypted before being stored on the information system disk. (c) Two data encryptors connected as a two-party secure data-transmission system. Both parties must have the key to encrypt and decrypt data.

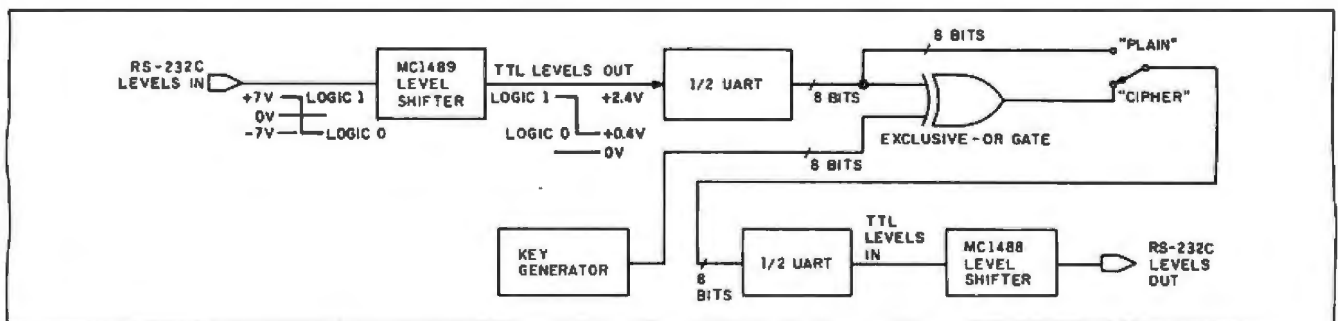

Figure 2: A functional block diagram of the basic Vernam cipher encryptor, as used in the Circuit Cellar data encryptor.

clude the decryption function).

The signal to be encrypted enters from the left. The RS-232C signal has its voltage levels (nominally +7, -7 volts DC) shifted to TTL voltage levels (nominally +2.4, +0.4 V), passes to a UART, and exits the UART as 8 data bits in parallel. If plaintext is selected, the data passes back into a UART and is serialized and level-shifted from TTL to RS-232C. In the plaintext position, the key generator remains inactive.

If ciphertext is selected, the key generator originates 8 bits of the key every time a character is received. Using an exclusive-OR function, the key is combined with the data coming from the receiving UART and is then fed to the sending UART.

Key generation is accomplished directly in hardware (see figure 3). The technique used here is to combine the output of two pseudorandom sequencers to produce one pseudorandom bit stream. The pseudorandom bit stream must produce 8 new bits every time a character is received by the UART. Many imaginative techniques for generating pseudorandom bit streams have been devised, but the security of a system must depend not on how complex this technique is, but on how many bits are produced before the cycle repeats.

**RELATIVE PRIMES**

One possible method is to use an exceptionally long sequencer, but even

this makes the most-probable-word method of cryptanalysis (code cracking) only minimally less successful. A significantly more secure method combines bits from two pseudorandom sequencers. The resulting diffusion makes the most-probable-word cracking very difficult. When combining two bit streams, however, it is important that the lengths of the two component streams be relative primes (they must not have any factors in common). The numbers 14 (2 x 7) and 15 (3 x 5) are relative primes. Put another way, their greatest common denominator (GCD) must turn out to be 1.

The length of the bit stream gen-  
*(continued)*

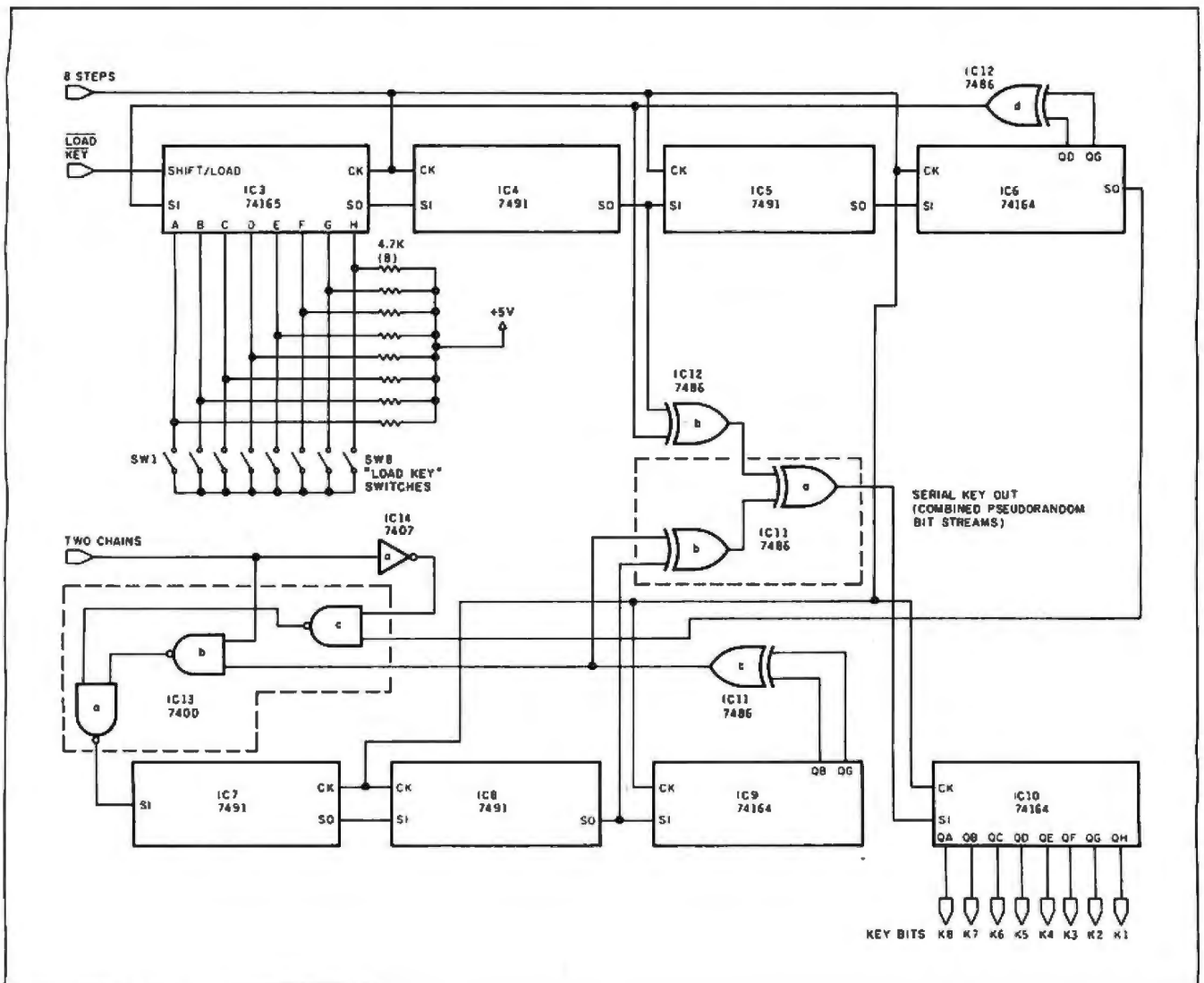

Figure 3: Key-generator logic.

erated by the top four shift registers in figure 3 is  $2^{31} - 1$  or 2,147,483,647. The length of the bit stream of the lower three shift registers is  $2^{23} - 1$  or 8,388,607. The last bit in both bit chains is not used, even though using these bits would almost quadruple the length of the combined bit stream produced, because  $2^{24} - 1$  and  $2^{23} - 1$  are not relative primes. Their GCD

is 255, producing a key length of  $(2^{32} - 1) \times (2^{24} - 1) / 255$ .

**MERSENNE NUMBERS**

The integer  $2^n - 1$  is called a Mersenne number after Marin Mersenne, who determined that two integers,  $2^m - 1$  and  $2^n - 1$ , are not relative primes if  $m$  and  $n$  are not relative primes.

The numbers above ( $2^{32} - 1$  and  $2^{24} - 1$ ) are not relative primes because 32 and 24 are not relative primes. A shift register of length  $n$  can be turned into a pseudorandom sequencer of length  $2^n - 1$  by providing feedback using a combination of exclusive-ORs. ICs 3, 4, 5, and 6 (in figure 3) form a sequencer with a length of  $2^{31} - 1$  by tapping the twenty-eighth and thirty-

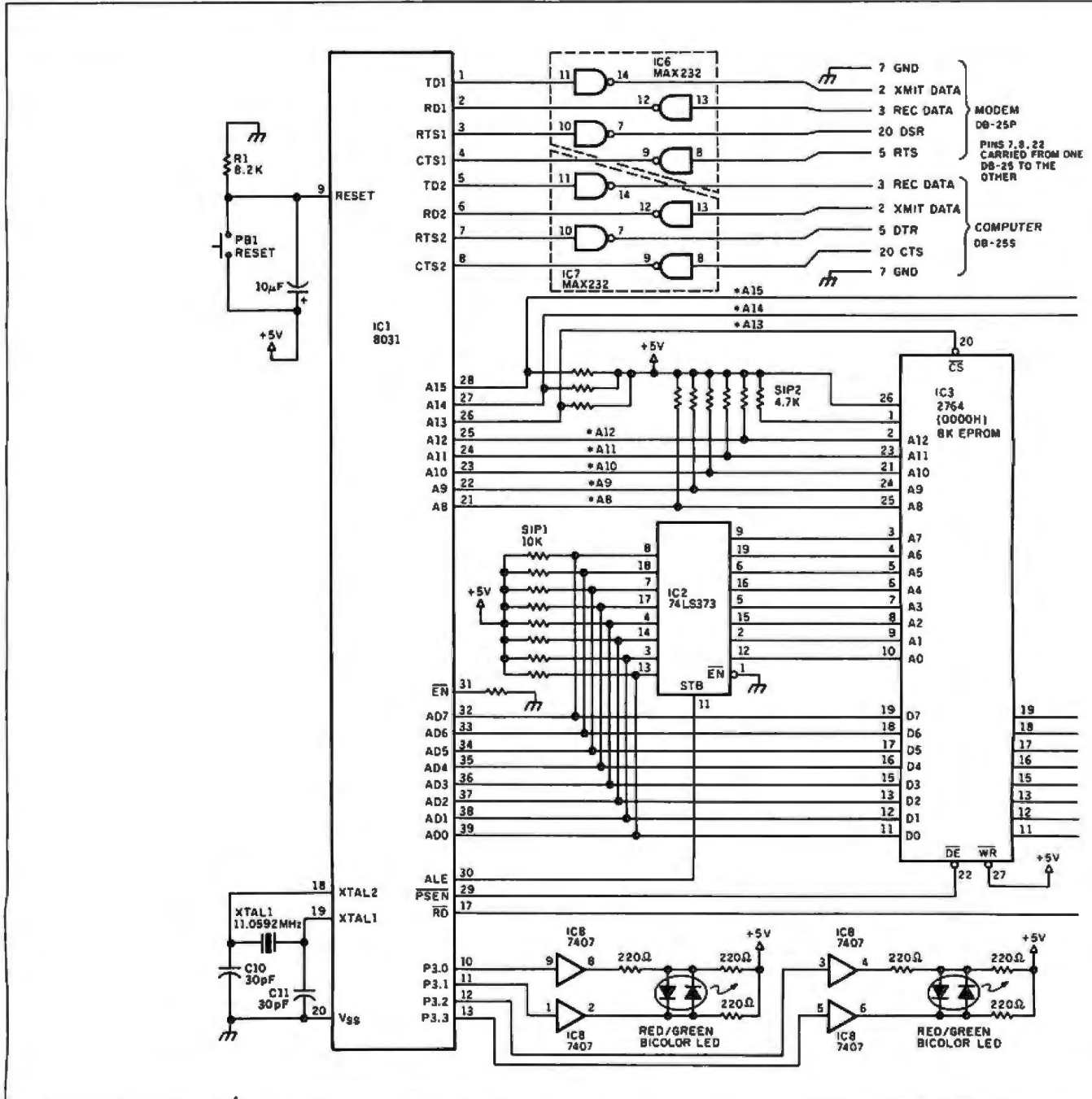

Figure 4: A schematic diagram of the microcomputer-based Circuit Cellar data encryptor.



first bits of the shift register with IC12a.

ICs 7, 8, and 9 form a sequencer with a length of  $2^{24} - 1$  by tapping the eighteenth and twenty-third bits of the shift register with IC11c. Each sequencer is tapped at two places (IC12b and IC11b), and the bit streams from each tap are combined together, using an exclusive-OR, by IC11a and

fed to another shift register where the result becomes the key. This is the diffusion that makes the most-probable-word method difficult. Even if a bit of the key were known, the three exclusive-ORs, acting together like a parity generator, tell whether there was an odd or even number of 1s at the four taps—and no more. Out of 16 possible combinations of 1s and 0s

that could be at the taps, the key bit narrows the choice down to no less than 8.

### A HARDWARE SUBSTITUTE

Most of these functions, including the encryption itself, can be synthesized using a microprocessor and software. The task of producing a cost-effective encryptor then ultimately becomes an exercise in configuring an efficient, low-cost microcomputer. A side benefit of such an approach is that it allows future performance enhancements by merely upgrading the software (to include DES encryption, for example).

The design I finally settled on uses an Intel 8031 microcomputer and only seven additional chips. The eight-chip circuit (shown schematically in figure 4 and in photos 1, 2, and 3) includes two full-duplex serial ports and two parallel ports with configuration DIP switches and bicolor LED channel-status indicators. The encryption and operating system software is contained in an 8K-byte 2764-type EPROM, IC3. Total power consumption is approximately 300 milliamperes if populated with NMOS devices (at somewhat greater cost, consumption can be lowered to about 110 mA if CMOS devices are used throughout).

The 8031, IC1, is a single-chip micro-computer with internal RAM and parallel I/O. The 8031 is capable of addressing 64K bytes of data memory and 64K bytes of code memory via a multiplexed 16-bit address bus. However, only 8K bytes of program memory (IC3) starting at 0000 hexadecimal are required for this application. The rest of the address range provides convenient memory-mapped address space for two 8-bit input ports used to read the configuration switches.

Input buffer IC5 is connected to DIP switch SW1 (addressed at 4000 hexadecimal). Input buffer IC4 is connected to DIP switch SW2 (addressed at 8000 hexadecimal). SW1 sets the serial-port protocol and baud rates; SW2 deals with the encryption/decryption functions. Table 1 gives a complete functional description of

(continued)

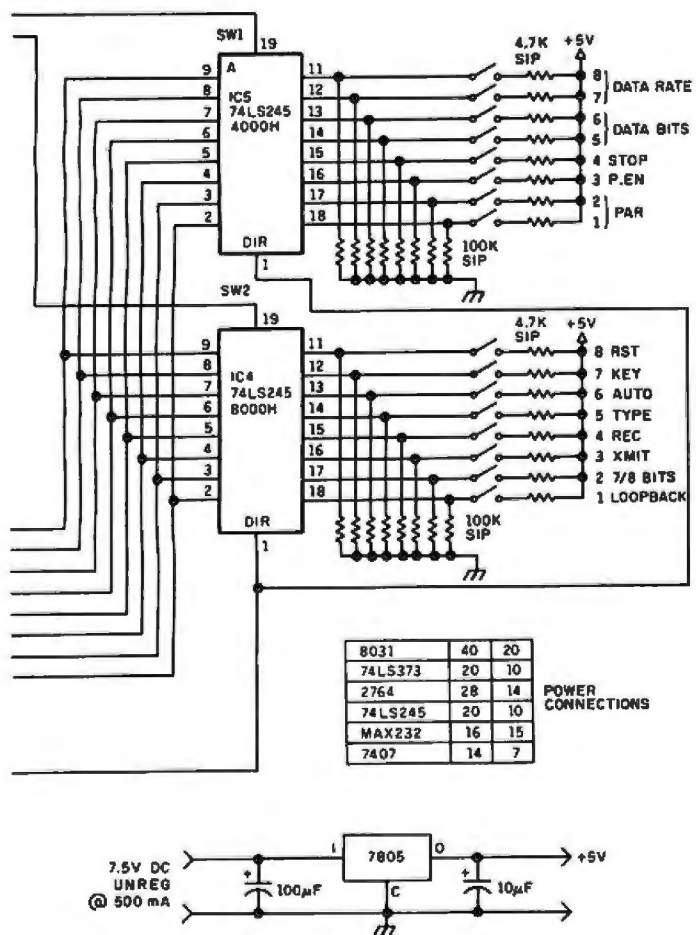

SW1. Table 2 gives a functional description of SW2.

### BIT BANGING

Probably the most unique feature of this microcomputer is that while it incorporates two serial ports, it has no serial-port hardware! Since the effort was to synthesize as many hardware functions as possible, the baud-rate generator and UART were discarded

along with the encryption logic. Instead, my data encryptor utilizes a technique often referred to as bit banging to simulate the missing hardware.

The 8031 includes predecoded parallel output ports among its pin-out connections. Utilizing its crystal-controlled clock to precisely time the execution of certain routines, it is possible to take a single parallel out-

put pin and directly change its logic level to be that that would have occurred through the parallel-to-serial conversion in a hardware UART. This software serial-port technique is frequently used where there is no need for high-speed interrupt processing (anything with a higher priority than the serial port, that is) or high data rates. Considering that the encryptor has to handle two full-duplex ports as well as handshaking, 1200 baud is about the top data rate without increasing the crystal frequency. (The routines for these tasks are not trivial. When it was finished, this bit-banger code turned out to be larger than the encryption software!)

### LEVEL-SHIFTER DESIGN

One other novel design addition in this circuit is found in the RS-232C level shifters themselves. Typically, designers use 1488/1489 level shifters for RS-232C connections. The 1488s are dual-supply devices that are relatively power-hungry. To have used them, the power-supply requirements for the encryptor would have been +12 V, -12 V, and +5 V. As an alternative, an ICL7660 voltage inverter could have been used to create a negative supply from the +12 V, but the power consumption would not have been improved.

Instead, I decided to use a new device called a MAX232 from Maxim. Shown in figure 5 and photo 4, the MAX232 is a dual CMOS RS-232C level shifter that operates on a single +5-V supply. It creates its own +/-10-V sources for use in the RS-232C transmission. While more expensive than the alternatives it replaces, it consumes less board real estate and power. As a result, the encryptor runs on a single 7.5-9-V 0.5-A power source. When populated with CMOS and high-speed CMOS logic, power consumption falls to about 200 mA. (See photo 5.)

One final circuit detail is the inclusion of a pair of bicolor LEDs to provide a visual status indicator to the user. The bicolor LEDs are equivalent to a regular pair of red-and-green LEDs encapsulated in the same two-wire package (three-wire bicolor LEDs are not the same). The bicolor LED

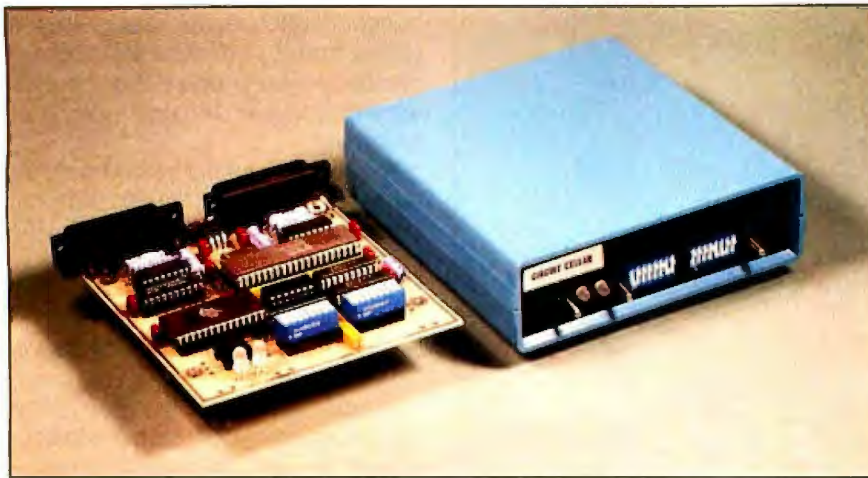

Photo 1: The prototype Circuit Cellar data-encryptor board shown beside the fully enclosed unit.

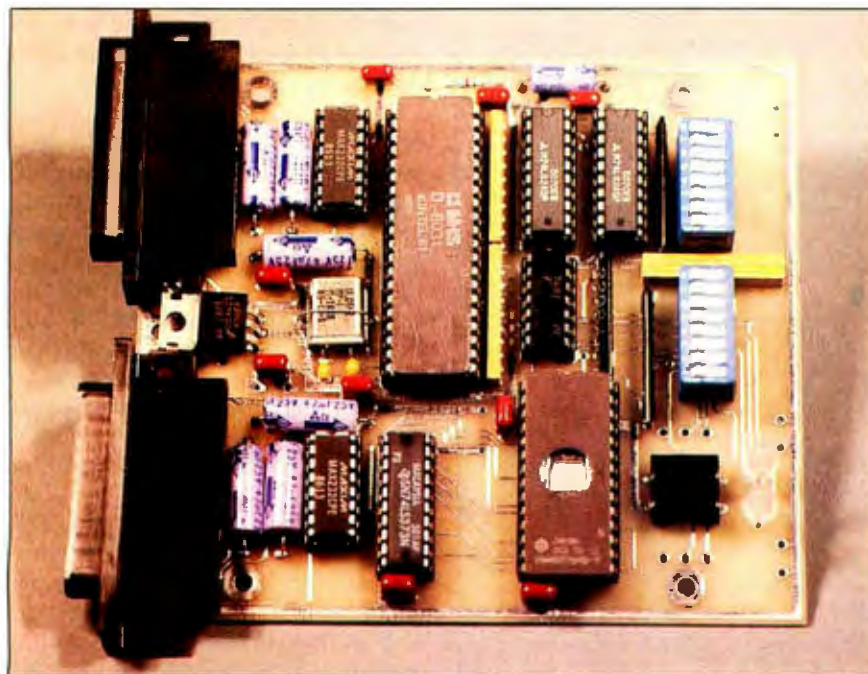

Photo 2: A close-up of the Circuit Cellar data-encryptor board showing the rear-mounted RS-232C connectors (left side) and the manual start/stop and option switches on the front panel (right side).

glows either red or green, depending upon the polarity applied to it. Attaching a bicolor LED between the outputs of a pair of inverters produces a bicolor, bistable status indicator (actually, you get red, green, and off). The inverters are connected to additional parallel output pins on the 8031 and are controlled by the application program. When the LED shows red, the specific encryptor channel is passing plaintext. When it shows green, it is passing encrypted data.

**DATA ENCRYPTOR SOFTWARE**

The data encryptor is a perfect example of what not to build in hardware. Many of its functions can be simulated completely in software, as well as enhancements that would otherwise not be incorporated (like all the ATN= commands). Using just eight chips, a hardware and software system is configured that duplicates the hardware exactly in the method of encryption as well as the user interface. A complete description of the software will not be given here because it is beyond the scope of this article.

*[Editor's note: Should you care to build the encryptor from scratch, the 8K-byte executable-code contents of the encryptor's EPROM is available as a downloadable file from the Circuit Cellar BBS at (203) 871-1988 or pre-programmed from the source (CCI, Tolland, CT) listed at the end of the article.]*

At reset, the 8031 automatically jumps to location 0000 hexadecimal (where the Reset/Power-up Vector resides) and starts initializing the data encryptor. During initialization, the program makes use of three utility subroutines that function as a software UART. (See listing 1.)

GETCHAR waits for a character to appear in the terminal UART, transfers it to the processor's accumulator, and returns to the calling program. PUTCHAR transfers the character in the accumulator to the terminal UART for transmission to the terminal screen.

If hardware UARTs were being used, they would normally be memory-mapped, and their status and data registers would each occupy two locations in memory. In the software implementation, the status register and data register are both at one address.

PARAM2. The distinction as to whether PARAM2 contains status or data is made by which subroutine is called to reference it.

In GETCHAR, JU2STATR is called to put the receive status into PARAM2. GETCHAR will loop until bit 6 of the status byte, DAV, is high, indicating a character has been received by the UART, then JU2RECV is called, which puts the character into PARAM2.

PUTCHAR works similarly, but it must loop until bit 7 of the status byte, TBMT, goes high, indicating that the transmit buffer is empty, then the character to be transmitted is put into PARAM2, and JU2TRANS is called to have the UART transmit the character. PUTSTRG is called to print a string of characters from program memory to the screen. The data pointer, DPTR, is

*(continued)*

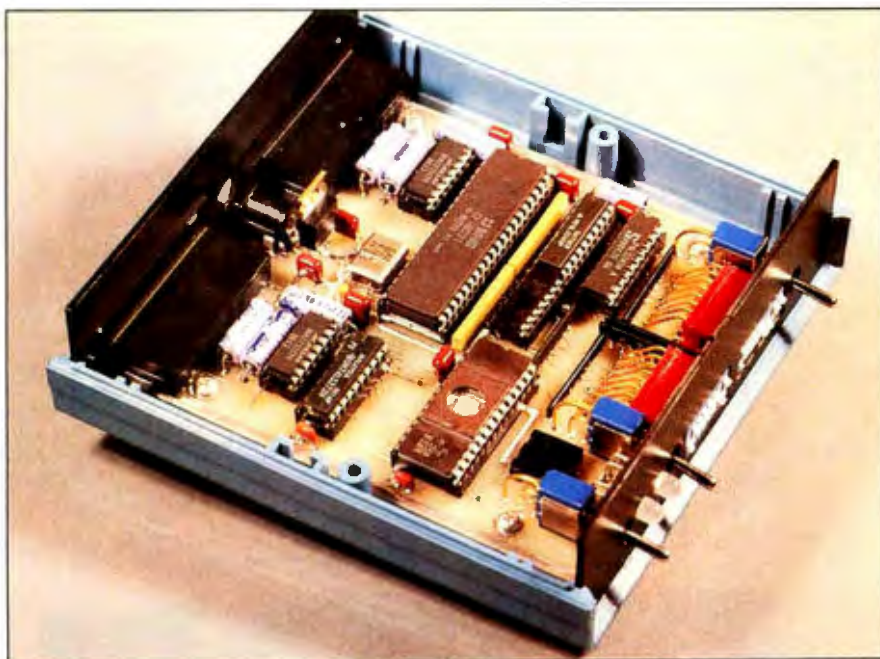

Photo 3: If right-angle DIP sockets and toggle switches are used, the data encryptor can be attractively packaged in a 5- by 5 1/4-inch enclosure.

Table 1: Switch functions for UART DIP switch SW1.

| UART Control DIP Switch SW1 |               |         |                 |
|-----------------------------|---------------|---------|-----------------|
| Switch                      | Function      | Value   | Result          |
| 8 & 7                       | data rate     | OFF OFF | 150 baud        |
|                             |               | OFF ON  | 300 baud        |
|                             |               | ON OFF  | 600 baud        |
|                             |               | ON ON   | 1200 baud       |
| 6 & 5                       | data bits     | OFF OFF | not used        |
|                             |               | OFF ON  | not used        |
|                             |               | ON OFF  | 7 bits          |
|                             |               | ON ON   | 8 bits          |
| 4                           | stop bits     | ON      | 1 stop bit      |
|                             |               | OFF     | 2 stop bits     |
| 3                           | parity enable | ON      | parity disabled |
|                             |               | OFF     | parity enabled  |
| 2 & 1                       | parity        | OFF OFF | space           |
|                             |               | OFF ON  | mark            |
|                             |               | ON OFF  | odd             |
|                             |               | ON ON   | even            |

a 16-bit address pointer, set to the start of the string by the calling routine. The last byte is 00 hexadecimal, signaling the end-of-string to PUTCHAR. (The code for these routines is also available from the Circuit Cellar BBS.)

#### PSEUDORANDOM SEQUENCER

CHAIN1X and CHAIN2X are called by KEYGENE to create the feedback necessary for the pseudorandom se-

quencer. The exclusive-OR function is accomplished by putting one of the bits (bit 28 or bit 18) into the carry and then inverting the carry if the other bit (bit 31 or bit 23) is a 1. SHFCHAIN is called with a value either 2 or 3 hexadecimal in R2 to indicate how many bytes are being shifted. SHFCHAIN shifts the whole chain 1 bit to the left and returns to KEYGENE, which loops eight times to generate 8 bits of the key. The rest of the code is fairly or-

dinary, and you know how I feel about software.

#### HOW TO USE THE DATA ENCRYPTOR

Figure 6 is a block diagram showing the overall program flow of the data encryptor. After reset, initialization of the software UARTs is performed by reading the eight segments of SW1. The encryptor configuration and function are determined by reading the segments of SW2. (See table 1 and table 2 for a complete description of these switch functions.)

After initialization, a copyright notice and a listing of the preset selections defined by SW2 are displayed. If the key is selected to come from manual entry rather than the preset key provided in EPROM, the user is prompted to enter the transmit key and the receive key (the keys stored in EPROM are randomly selected during the manufacturing process and are unique to each encryptor). To aid the user in getting the keys entered correctly, a checksum is calculated and printed. The checksum should be delivered with the key so that users at both ends can check each key after it is entered.

After each key is entered, the user is asked to accept it. If it is rejected, the user is prompted to enter it again. After the transmit key is accepted, the user is prompted in the same manner for the receive key. After the receive key is accepted, the data encryptor goes into an infinite loop, encrypting and transmitting any characters entered from the local terminal/computer connected to it. Conversely, it decrypts and displays (via the local terminal/computer) any encrypted characters it receives from the remotely located modem, computer, or terminal. During the infinite loop, if the data encryptor is in the manual start/stop mode, SW2 is scanned to determine when encryption and decryption should start and stop.

In the manual start/stop mode, the user would start communication in plaintext mode, and the LEDs would glow red (unsafe communication) to indicate this. The users at each end would flip the transmit and/or receive

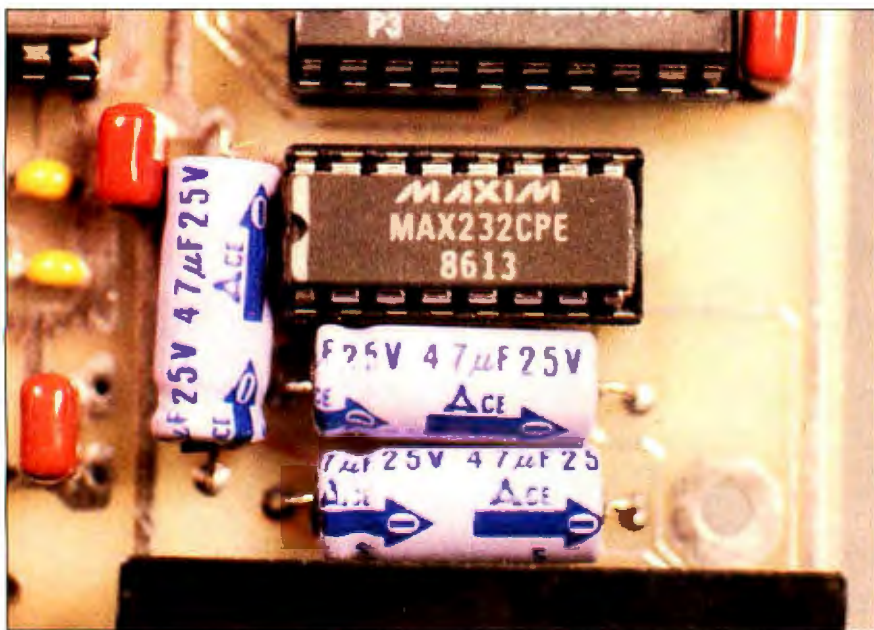

Photo 4: The Maxim MAX232 RS-232 transceiver installed in the data encryptor. The MAX232 runs on +5 V and produces its own +10 and -10 V for RS-232 level output.



Photo 5: Power is supplied to the data encryptor by the wall-module power supply shown. The power supply plugs into the data encryptor between the two RS-232C connectors on the rear panel.

Table 2: Functions of encrypt/decrypt mode control DIP switch SW2.

| Encrypt/Decrypt Mode Control DIP Switch SW2 |                          |       |                |
|---------------------------------------------|--------------------------|-------|----------------|
| Switch                                      | Function                 | Value | Result         |
| 8                                           | DSR reset                | ON    | disabled       |
|                                             |                          | OFF   | enabled        |
| 7                                           | encryption key           | ON    | user-supplied  |
|                                             |                          | OFF   | EPROM-supplied |
| 6                                           | auto start/stop          | ON    | disabled       |
|                                             |                          | OFF   | enabled        |
| 5                                           | data type                | ON    | 8-bit binary   |
|                                             |                          | OFF   | 7-bit ASCII    |
| 4                                           | receive decrypt          | ON    | disabled       |
|                                             |                          | OFF   | enabled        |
| 3                                           | transmit encrypt         | ON    | disabled       |
|                                             |                          | OFF   | enabled        |
| 2                                           | # of encrypted data bits | ON    | 7 bits         |
|                                             |                          | OFF   | 8 bits         |
| 1                                           | loopback                 | ON    | disabled       |
|                                             |                          | OFF   | enabled        |

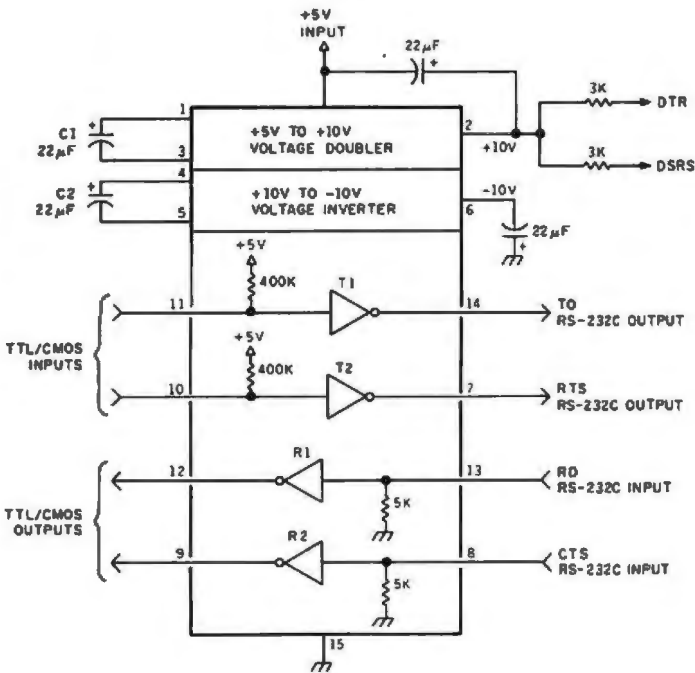

Figure 5: A functional block diagram of the Maxim MAX232 level-converter chip.

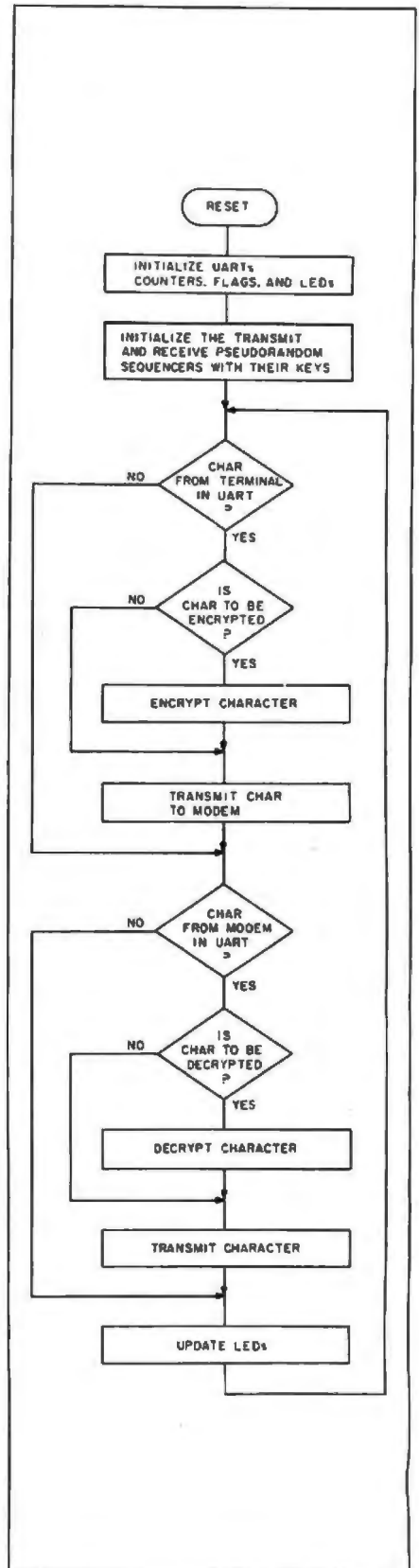

Figure 6: The software flowchart of the Circuit Cellar data encryptor.

## Settings for Encryption Mode Switch SW2

| Switch Segment | Function    | Setting  |
|----------------|-------------|----------|
| 8              | DSR Reset:  | disabled |
| 7              | Key Source: | user     |
| 6              | Start/Stop: | manual   |
| 5              | Data Type:  | ASCII 7  |
| 4              | Receive:    | plain    |
| 3              | Transmit:   | plain    |
| 2              | Encrypt:    | 7 bits   |
| 1              | Loopback:   | off      |

Enter TRANSMIT key:

>

At this point, if the user wants to change the switch settings, they can be changed and the encryptor reset. The settings shown on the screen after reset will reflect the new settings. Note that if switch segment 7 is OFF, nothing will be displayed because the encryptor is assuming it is at a remote site and there is no one to respond to it. Assuming that the settings are what is desired:

```
>How is the time for all good men
Checksum = A6. Accept key? (Y/N) n
Enter TRANSMIT key:
>Now is the time for all good men
Checksum = A0. Accept key? (Y/N) y
Enter RECEIVE key:
>to come to the aid of their party.
Checksum = 1D. Accept key? (Y/N) y
```

User A can now call user B, just as during any regular communication.

Hello, user B.

*Hello, user A.*

Do you remember the keys we agreed on?  
Remember, my transmit key is your receive key.  
*Yes, I remember.*

I will now switch over to ciphertext  
so we can exchange sensitive data.  
I will not transmit anything more  
until I hear from you.

\* User A and user B now switch both switches to ciphertext. Any transmissions from now on will be encrypted.

*Hello, user A. What did you want to tell me?*

My transmit key for our next session will be:  
"J. S. Bach was born in 1685." The checksum is 22.  
My transmit key for our next session will be:

*"1.6180339887." The checksum is 71.*

I will now switch over to plaintext so we can talk  
plainly.

\* User A and user B both change the DIP-switch settings to plaintext. Any transmissions from now on will not be encrypted.

*C U later, user A.*

*See you next time. Bye.*

Figure 7: A sample communication session between user A and user B, using both plaintext and encrypted transmission.

encrypt switches during a pause in transmissions. For example, user A might transmit in plaintext, "I will flip both my switches after the next sentence is transmitted. I will not transmit any more until I receive the go-ahead from you." Then user A flips both switches. User B at the other end reads both sentences, flips both switches, and transmits back "go-ahead." They are now both transmitting encrypted messages. Both LEDs will indicate that transmission is being encrypted by glowing green (safe communication). Figure 7 is a sample communication session between user A and user B. User B's responses are in italic.

### INTELLIGENT COMMAND SET

The Circuit Cellar data encryptor also incorporates an intelligent command structure (somewhat like smart modems) and can change functions without physically manipulating the DIP-switch settings. If the auto start/stop mode is selected instead of manual mode, encryption on the transmit side is started when the command ATN=BEG is sent. This command will start encryption with the character following the command.

The receiving data encryptor will start decrypting with the character following the command. The command ATN=END causes the transmitting data encryptor to stop decrypting after the last character of the command. With the auto start/stop mode, the data stream does not have to be interrupted to start or stop encryption as in the manual mode (as shown in figure 8). Assume the keys have been entered at both ends and communication in plaintext has already begun.

Encryption can be started and stopped as often as desired. Each time it is started, key generation picks up where it left off when encryption was last stopped. Key generation does not start over unless the data encryptor is reset.

### LOOPBACK MODE

Another mode, illustrated in figure 1a, is transmitting to yourself by having the encryptor loop back. Loopback is one of the options selected on SW2. In loopback mode, you can encrypt

a file, store it on disk to protect sensitive data, or transmit it to another computer with standard communication software like XMODEM (the encryptor can encrypt a file without changing control characters or creating them in the encrypted results). A sample loopback encrypting program written in BASIC for an IBM PC is available via the Circuit Cellar BBS.

>Now is the time for all good men  
Checksum = AO. Accept key? (Y/N) y

Consider the example shown above. Since loopback requires the same transmit and receive keys, it asks for only one. As soon as the user concludes that entry by answering yes, any communication will be echoed

back to the terminal.

This sentence is not encrypted.

```
ATN=BEG
vD)tbbv7%6}=dXf6YpOnjfh8
This sentence is also not encrypted.
```

If this were stored somewhere and at another time retransmitted to yourself, it will be decrypted, providing the

same key is used that you used to encrypt it. The three lines above will then look like this:

```
This sentence is not encrypted.
ATN=BEG
This sentence is. ATN=END
This sentence is also not encrypted.
```

*(continued)*

```
Hello, user B.
My transmit key for our next session
will be: ATN=BEG
"J. S. Bach was born in 1685." ATN=END
Talk to you next time. Bye.
```

Figure 8: An example of the use of auto start/stop mode during transmission.

Listing 1: Input/output section of the data encryptor's assembly code.

```

; UTILITIES FOR INPUT/OUTPUT
;
;
; GET A CHARACTER FROM THE KEYBOARD
;
03AF 9176 GETCHAR: ACALL JU2STATR
03B1 E559 MOV A, PARM2 ; GET RECEIVE STATUS
03B3 5440 ANL A, #DAV ; AND LOOP UNTIL
03B5 B440F7 CJNE A, #DAV, GETCHAR ; DATA AVAILABLE.
03B8 917F ACALL JU2RECV ; GET CHARACTER AND
03BA E559 MOV A, PARM2 ; PUT INTO ACCUMULATOR.
03BC 22 RET

;
; WRITE A CHARACTER ON THE SCREEN
;
03BD C082 PUTCHAR: PUSH DPL ; SAVE
03BF C083 PUSH DPH ; DATA POINTER.
03C1 C0E0 PUSH ACC ; SAVE CHAR FOR LATER.
03C3 9176 XMSTAT: ACALL JU2STATR
03C5 E559 MOV A, PARM2 ; GET TRANSMIT STATUS
03C7 5480 ANL A, #TBMT ; AND LOOP UNTIL
03C9 B480F7 CJNE A, #TBMT, XMTSTAT ; TRANSMIT BUFFER EMPTY.
03CC D0E0 POP ACC ; RETREIVE CHARACTER
03CE F559 MOV PARM2, A ; AND TRANSMIT IT.
03D0 C0E0 PUSH ACC ; SAVE FOR AFTER JU2TRANS
03D2 917C ACALL JU2TRANS
03D4 D0E0 POP ACC ; RETREIVE CHARACTER AND
03D6 D0B3 POP DPH ; DATA POINTER FOR CALLING
03D8 D0B2 POP DPL ; ROUTINE.
03DA 22 RET

;
; WRITE A STRING TO THE SCREEN
;
03DB C0E0 PUTSTRG: PUSH ACC ; SAVE ACCUMULATOR.
03DD 7400 PNTCHAR: MOV A, #00H
03DF 93 MOVC A, @A+DPTR ; POINT TO CHAR IN STRING
03E0 6005 JZ DONSTRG ; DONE IF IT IS 0.
03E2 71BD ACALL PUTCHAR ; OTHERWISE WRITE IT
03E4 A3 INC DPTR ; AND POINT TO NEXT CHAR.
03E5 80F6 SJMP PNTCHAR
03E7 D0E0 DONSTRG: POP ACC ; RESTORE ACCUMULATOR.
03E9 22 RET

```

*Because it is  
a bad practice  
to use the same key  
over and over,  
five additional  
plaintext characters  
are sent to scramble  
the fixed key.*

Two other commands are included to enable one encryptor to be located at a remote site. You may want to be able to communicate with your computer at home or at your office, but no one is at the remote computer to initialize the encryptor. With these commands, you can call the computer and initialize the encryptor by phone before sensitive information is transmitted either way (leaving the encryptor attached protects you from the malicious crackers who auto-dial search for unattended auto-answer computers). This procedure is also applicable for use on LANs or multiterminal systems.

The two commands are `ATN=PROM+xxxxx` and `ATN=USER+xxxxx`, where `xxxxx` are any five characters used to offset the key already loaded in the remote data encryptor. (The reason for the offset will be explained later.) Both commands reset the key to a known point in case the key generators in the transmitting and receiving encryptors have gotten out of sync. `ATN=USER+xxxxx` will reset to the manual key that was previously entered through the normal prompting after a power-on reset.

Unfortunately, if a power failure had occurred (without some sort of uninterruptible power source), the key would be lost, and the remote encryptor would have no way of reinitializing without a manually entered key. `ATN=PROM+xxxxx` takes care of this situation by using a key stored in the

encryptor's EPROM to reinitialize with.

Because it is a bad practice to use the same key over and over, however, the five extra characters are sent to scramble the fixed key. This defeats any attempts of an attacker using the most-probable-word method to discover the key. Even though these five characters are sent in plaintext, their effect on the unknown key cannot be predicted. The most-probable-word method can be used only if the attacker knows what part of the key was used to encrypt a given part of a message, and that part of the key must be used often. Both of these commands initialize the transmit and receive side of both encryptors, and encryption or decryption is started immediately after the fifth scrambling character is processed.

#### IN CONCLUSION

I'll have to admit that I didn't know much about data encryption before attempting this project. Since most of you probably share this lack of knowledge, I included more background materials than I might ordinarily present with a project. I trust that I neither bored you nor made you into a paranoid computer user. It's just that forewarned is forearmed.

One additional observation about using the encryptor. While it was designed to facilitate direct use through a modem, the telephone lines are sometimes not up to the task. Dropping or adding a character destroys the synchronization necessary between the encryptor and decryptor, and most modems do not include error checking. Rather than restarting after sending fixed character blocks using the intelligent (`ATN=`) command set, it is much easier to preencrypt the entire file using the loopback mode.

Then, using XMODEM or any good error-checking communication program, send the whole file to the receiving system. This situation does not occur in directly connected computers, LANs, or any communication system with block transmission and error checking.

Finally, after describing the encryptor to a longtime engineering friend, I was informed of an unconsidered

application. His job was to design animated graphics simulations of various research projects so that management has some clue as to what their big-bucks scientists are up to. Unfortunately, to most people these simulations looked and ran like the greatest video games, and he was always trying to track down who had swiped his software for a demo.

The solution was to create a hardware key to his software. He did this by connecting a data-encryptor set in the loopback mode to the serial port on his computer and partially encrypting the graphics software to the cipher key stored in EPROM. As his program initialized, it had to send the encrypted block out to be deciphered correctly before there were any graphics routines to execute. This didn't inhibit the demonstrations but required that they be only at his computer, where he could keep track of his software, or wherever he carried his little black encryptor. Too bad. I used to have such a good time running around demonstrating his stuff!

#### CIRCUIT CELLAR FEEDBACK

This month's feedback begins on page 58.

#### NEXT MONTH

Steve presents his new and improved serial EPROM programmer.

#### BIBLIOGRAPHY

- Data Encryption Standard*. FIPS Publication 46. U.S. Department of Commerce/National Bureau of Standards. 1977.
- Feistel, Horst. "Cryptography and Computer Privacy." *Scientific American*, May 1973, page 15.
- Kahn, David. *The Codebreakers*. New York: Macmillan, 1967.
- Konheim, Alan G. *Cryptography: A Primer*. New York: Wiley, 1981.
- Lancaster, Donald E. *TTL Cookbook*. Indianapolis: Sams, 1974.
- Meushaw, Robert V. "The Standard Data Encryption Algorithm." *BYTE*, March 1979, page 66; April 1979, page 110.
- Roberts, Ralph. "A BASIC Program for Home Cryptography." *BYTE*, April 1982, page 432.
- Smith, John. "Public Key Cryptography." *BYTE*, January 1983, page 198.

*Special thanks to Roger James and Bill Curlew for their software expertise.*



## GLOSSARY

**CAESAR CIPHER:** The simplest encryption scheme, where the encrypted character is displaced from the plaintext character by a fixed amount:

Plaintext:  
 ABCDEFGHIJKLMNOPQRSTUVWXYZ  
 Ciphertext:  
 DEFGHIJKLMNOPQRSTUVWXYZABC

Plaintext: THE QUICK BROWN FOX  
 Ciphertext: WKH TXLFN EURZK IRA

This cipher is easily broken using frequency analysis.

**DES:** This stands for data-encryption standard, a system in which a 64-bit block of data (eight characters) is transformed into an encrypted block of 64 bits using a standard algorithm controlled by a 56-bit key. Because the value of each bit in the output block is dependent on every bit in the input block, it is called a block cipher.

**FREQUENCY ANALYSIS:** Tabulating the occurrences of each letter in the ciphertext. It is assumed that the most frequently occurring letter is a plaintext "e," the next most frequently occurring letter is a "t," etc. Cryptograms in the Sunday paper are easily broken using frequency analysis.

**KASINSKY SOLUTION:** A method of determining the number of alphabets used in a polyalphabetic cipher.

**MONOALPHABETIC CIPHER:** A simple substitution in which each letter of plaintext has a unique letter in the ciphertext.

Plaintext:  
 ABCDEFGHIJKLMNOPQRSTUVWXYZ  
 Ciphertext:  
 EXUGROFBPIAKCZHNODLMSVWYT

Plaintext: THE QUICK BROWN FOX  
 Ciphertext: LBR NMPUA XOHVZ QHW

This cipher is easily broken using frequency analysis.

**POLYALPHABETIC CIPHER:** A system in which several monoalphabetic ciphers are used together in a cycle. This example has a short cycle of 3:

Plaintext:  
 ABCDEFGHIJKLMNOPQRSTUVWXYZ  
 Ciphertext 1:  
 EXUGROFBPIAKCZHNODLMSVWYT  
 Ciphertext 2:  
 LWKCVJAXMBNFEUDSTGOPRYIOZH  
 Ciphertext 3:  
 JPIOAKHQBGLNMRCFEWSYVUTZXD

Plaintext: THE QUICK BROWN FOX  
 Ciphertext: LXA NRBUN PODTZ JCW

Frequency analysis can be used to decipher this, but a separate tabulation must be kept for each alphabet. In this example, three tables would have to be kept. With even a few lines of text, it could be broken. Before tabulation can begin, the attacker must know how many alphabets are being used. If a message is encrypted with as many alphabets as there are characters in the message, and the arrangements of the letters in each is truly random, the message will prove to be impossible to break.

**PSEUDORANDOM SEQUENCE GENERATOR:** Any hardware or software that generates a very long sequence of bits. The sequence will eventually start over and repeat. This is why it is a pseudorandom sequencer and not a random sequencer. In addition, while the sequence appears to be random, it will always be the same if it is started with the same seed.

**VERNAM CIPHER:** A method where a continuous stream of key bits is combined, using an exclusive-OR function, with the message bits for encryption. Each bit in the output stream is dependent on only 1 bit in the input stream and 1 bit in the key.

The following items are available from

CCI  
 P.O. Box 428  
 Tolland, CT 06084

1. Data encryptor/decryptor blank PC board and programmed 2764 EPROM containing encryption algorithm and serial I/O software. . . . . \$79, two for \$150
2. Data encryptor/decryptor PC board kit. Includes all board-mounted components, programmed EPROM, and microprocessor, less power-supply module and case. . . \$99, two for \$195
3. 115-V AC/60-Hz power-supply module for above . . . . . \$9
4. 5-by 5¼-by 1½-inch enclosure with blank end plates . . . . . \$9.75

The data encryptor is available in low quantities only in kit form. It is available assembled and tested with right-angle toggle and DIP switches only in volume OEM quantities (telex: 643331). Price and delivery informa-

tion available on request.

All payments should be made in U.S. dollars by check, money order, MasterCard, or Visa. Surface delivery (U.S. and Canada only): add \$5 for U.S., \$10 for Canada. For delivery to Europe via U.S. air mail, add \$20. Three-day air freight delivery: add \$8 for U.S. (UPS Blue), \$25 for Canada (Purolator overnight), \$45 for Europe (Federal Express), or \$60 (Federal Express) for Asia and elsewhere in the world. Shipping costs are the same for one or two units. Connecticut residents add 7.5 percent sales tax.

Most of the individual encryptor components, including the 8031, are available from JDR Microdevices, 1224 South Bascom Ave., San Jose, CA 95128, (800) 538-5000.

There is an on-line Circuit Cellar bulletin board system that supports past and present projects. You are invited to call and exchange ideas and comments with other Circuit Cellar supporters. The 300/1200/2400-bps

BBS is on-line 24 hours a day at (203) 871-1988.

**Editor's Note:** Steve often refers to previous Circuit Cellar articles. Most of these past articles are available in book form from BYTE Books, McGraw-Hill Book Company, P.O. Box 400, Hightstown, NJ 08520.

*Circuit's Circuit Cellar, Volume I* covers articles in BYTE from September 1977 through November 1978. *Volume II* covers December 1978 through June 1980. *Volume III* covers July 1980 through December 1981. *Volume IV* covers January 1982 through June 1983. *Volume V* covers July 1983 through December 1984. ■

To be included on the Circuit Cellar mailing list and receive periodic project updates and support materials, please circle 100 on the Reader Service inquiry card at the back of the magazine.



CIT

# PRINTERS THAT RUN

In front of you are six time machines.  
The result of half a century of precision chronology.  
Machines that are not only built to save time, but to defy it,  
by taking you years into the future.

They are Citizen™ printers. Designed to run like clockwork with most leading computer systems. They're quiet, lightweight and will produce quality printouts time after time without a bit of trouble.

They have simple user controls and easy paper loading systems that let you start any job in seconds. And only Citizen adds built-in extras like variable-width tractors without making you endure the cost.

E N



# LIKE CLOCKWORK.

Our dot-matrix line, the Citizen 120D and the MSP-10, 15, 20 and 25, fly through documents at 120 to 200 characters per second, with correspondence quality at the flip of a switch.

And our Premiere™ 35 is the only 35 cps daisywheel with a price that's hundreds of dollars less than any printer in its class. Because at Citizen, we want to take you into the future, not set you back.

For more precise information, call 1-800-556-1234 Ext. 34.  
In California, 1-800-441-2345 Ext. 34.

Citizen Printers. Proof that all good things take time.

©1986 Citizen America Corporation. Citizen, the Citizen logo and Premiere 35 are trademarks of Citizen Watch Company, Ltd.



**CITIZEN™**

Inquiry 65



ILLUSTRATED BY CARY HENRIE

# CALCULATING CRCs BY BITS AND BYTES

BY GREG MORSE

*Use the XOR function to implement modulo 2 division  
when calculating cyclic redundancy checks*

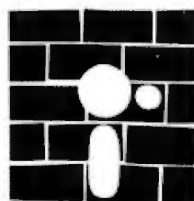

Recently I needed to implement the XMODEM cyclic redundancy check (CRC) option on my XCom9 modem program. Despite the many programs available for calculating CRCs, I had some difficulty understanding the math behind the calculations. The details became clear after much research and experimentation.

The starting point for all CRCs is fancy linear algebra. The CRC is defined in terms of message polynomials, generator polynomials, and so on. As Perez, Wismer, and Becker state in "Byte-wise CRC Calculations" (*IEEE Micro*, June 1983),

In a system employing CRC the message being transmitted is considered to be a binary polynomial  $M(X)$ . It is first multiplied by  $X^k$  and then divided (modulo 2) by an arbitrary generator polynomial  $G(X)$  of degree  $k$  which results in a quotient  $Q(X)$  and a remainder. . .

It sounds confusing, but if you can understand how to apply the math, you can design more efficient programs and spot many erroneous ones.

## THE "MATH-NESS" TO THE METHOD

The design of the polynomial  $G(X)$  is extremely complex. You need to pick one that

produces CRCs that are good at detecting errors. Fortunately, many  $G(X)$ s exist already. Table 1 contains the two most common  $G(X)$ s in an 8-bit-byte environment.

Let's calculate the CRC for the letter *T*, 0101 0100 in binary.  $M(X)$  is the message as it is transmitted. You transmit a character's least significant bit (LSB) first, so  $M(X)$  becomes 00101010. Then you divide modulo 2 as shown in figure 1. (Modulo 2 means you use the XOR instruction instead of the normal add and subtract.) Work it through according to the process shown in figure 2. Note that the CRC result is given in reverse order, that is, most significant bit (MSB) on the right, LSB on the left.

## BIT-ORIENTED ALGORITHMS

Using the long-division approach, if you had only a single zero bit to send, you would get the result shown in figure 3. If you had two bits to send, a zero and then a one, long division would produce the result shown in figure 4. The first remainder in figure 4 is the same as the first remainder in figure 3 except that its LSB has been XORed with

*(continued)*

Greg Morse (10871 Roseland Gate, Richmond, BC., Canada V7A 2R1) is an engineer with the British Columbia Telephone Company. He has 20 years' experience with computers and 10 with data communications. Greg has B.A.Sc. and M.A.Sc. degrees in electrical engineering.

**Table 1:** The two most common  $G(X)$ s (generator polynomials) in an 8-bit-byte environment. You can code the  $G(X)$  as a 17-bit binary, or hexadecimal, number. The ones and zeros represent the coefficients of the different powers of  $X$  in the polynomial.

CRC-16 (Bisynchronous)  
 $X^{16} + X^{15} + X^3 + 1 = 1\ 1000\ 0000\ 0000\ 0101$

CRC-CCITT (SDLC, X.25, XMODEM)  
 $X^{16} + X^{12} + X^5 + 1 = 1\ 0001\ 0000\ 0010\ 0001$

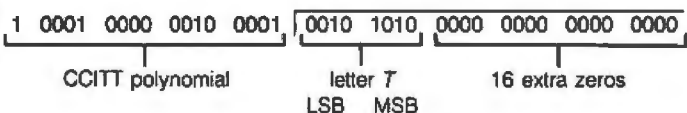

**Figure 1:** The initial modulo 2 division used to calculate the CRC for the letter T. Note that the letter is given LSB first; in other words, it is reversed.

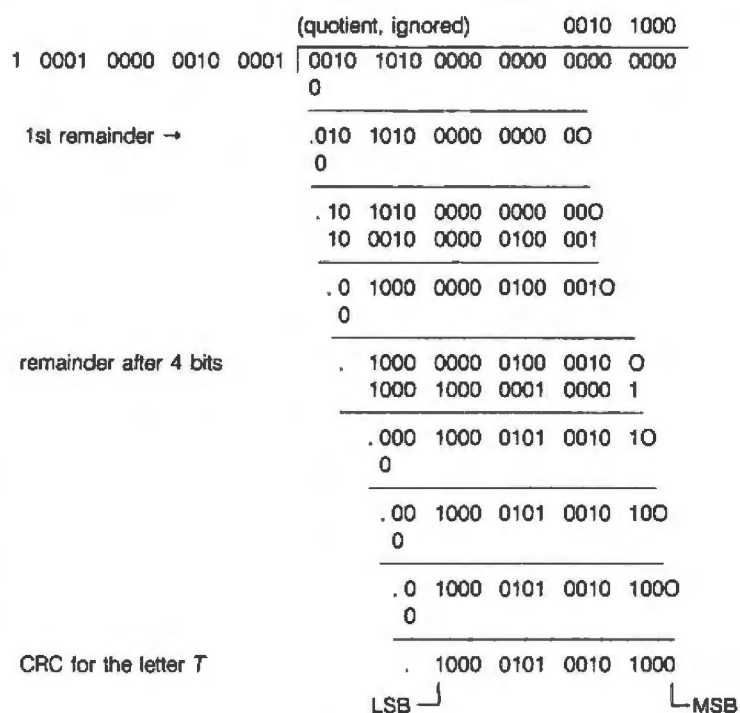

**Figure 2:** The entire long-division calculation process used to derive the CRC for the letter T. The apparent subtractions in this process are XORs; therefore, there are no "borrows." A "." represents a zero that has no further part in the calculation, and "O" represents a zero that was "brought down" from the dividend line. Therefore, the line .00 1000 0101 0010 100 represents a remainder of 00 1000 0101 0010 10. Note that the CRC is given with the LSB on the left. Thus, the CRC for the letter T = 0 54 is (MSB first) 0001 0100 1010 0001, or 14A1 hexadecimal.

the second data bit. This similarity will always be true because of the way the  $M(X)$  polynomial is built.

This observation leads to the following bit-by-bit algorithm for calculating the CRC:

1. Write down the first data bit (zero or one) to be transmitted.
2. Write down 16 zeros to its right.
3. Divide the 17-bit number by the 17-bit CRC polynomial using XOR instead of subtraction. Make a note of the remainder, which is the CRC.
4. Get the next data bit.
5. XOR this bit with the LSB (left-most bit) of the CRC in step 3.
6. Append a zero to the right-hand end of the result in step 5.
7. Divide the 17-bit number from step 6 by the 17-bit CRC polynomial. Use XOR instead of subtraction. The remainder is the CRC.
8. Repeat steps 4 through 7 until there are no more data bits. (You can replace steps 1 through 3 with a single step to initialize the CRC to zeros.)

Thus, you can calculate the CRC a bit at a time, for any number of bits, with almost no extra calculation overhead. In summary, the steps involved in the long-division method are

1. The message bits are written down in the order in which they are transmitted, from left to right, that is, LSB on the left.
2. Sixteen zeros are appended to the right-hand end of the binary number formed in step 1.
3. The generating polynomial is written down MSB first, that is, on the left.
4. The division is done modulo 2, that is, using XOR instead of normal subtraction.
5. The CRC is the remainder after all data bits have been processed. The LSB is on the left.

Figure 5 translates these steps into a flowchart.

### HARDWARE IMPLEMENTATIONS

One disadvantage of the flowchart in figure 5 is that it requires a 17-bit reg-

*(continued)*

## CALCULATING CRCs

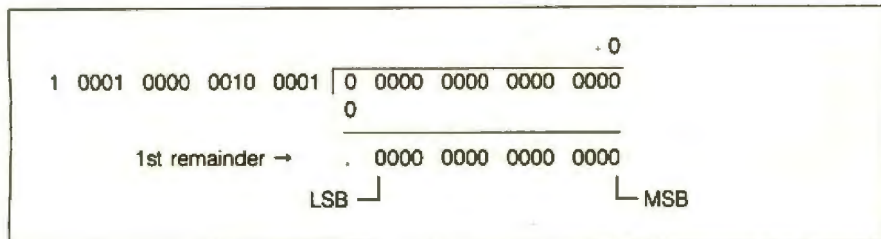

Figure 3: The long-division CRC calculation for a single zero bit.

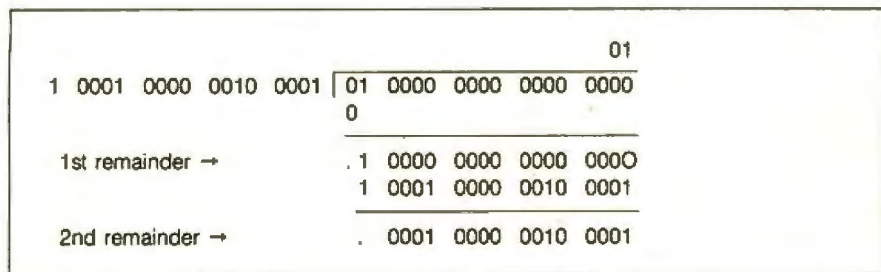

Figure 4: The long-division CRC calculation for the two bits 01.

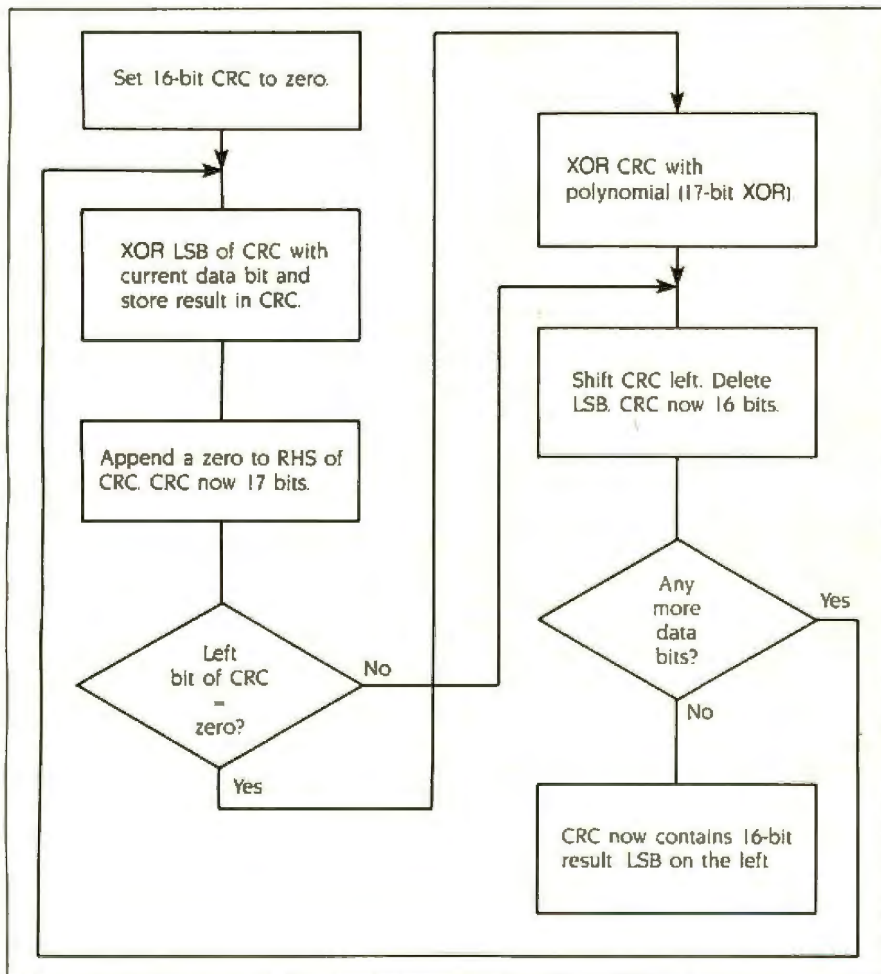

Figure 5: A flowchart representing the steps involved in the long-division method of calculating a CRC.

# MathCAD

The Engineer's Scratch Pad

### FOURIER RECONSTRUCTION

**FOURIER RECONSTRUCTION: SQUARE WAVE**

$N := 40 \quad j := 0 .. N \dots 40 \text{ points}$

$S_j := 1 - 2 \cdot \delta(j - 20) \dots \text{step function}$

Reconstruct function, using first two terms of Fourier series  $i := 1, 3 \dots 3$

$$R_j := \frac{4}{\pi} \sum_i \frac{1}{i} \sin \left[ i \cdot 2 \cdot \pi \cdot \frac{j}{N} \right]$$

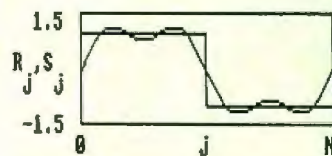

**A powerful computation and documentation tool for your IBM-PC.**

With MathCAD you simply and interactively create, edit and display formulas on the screen the way you are used to writing them. Equations are instantly computed and the results displayed on the screen as a single number or a plot. Text may be added to the screen and everything may be printed out as an integrated document. MathCAD has built-in hyperbolic and circular functions, performs all calculations with real and complex numbers, performs iterative calculations, handles all units, performs error checking and dimensional analysis and much more...

The price of MathCAD—\$189.  
In Massachusetts add 5% sales tax.

**To order send check, p.o., call us with your MasterCard number or call us for the nearest dealer.**

**1.800.MathCAD or 617.577.1017**

# Math Soft

Σ + √ - = × ∫ = ∞

One Kendall Square  
Cambridge, Massachusetts 02139

## CALCULATING CRCs

|         |       |    |    |    |     |    |    |    |    |     |     |     |     |     |     |     |
|---------|-------|----|----|----|-----|----|----|----|----|-----|-----|-----|-----|-----|-----|-----|
| $Q=1$   | R1    | R2 | R3 | R4 | R5  | R6 | R7 | R8 | R9 | R10 | R11 | R12 | R13 | R14 | R15 | 0   |
| XOR     | X16=1 | 0  | 0  | 0  | X12 | 0  | 0  | 0  | 0  | 0   | 0   | X5  | 0   | 0   | 0   | 1   |
| New CRC | R0    | R1 | R2 | R3 | R4  | R5 | R6 | R7 | R8 | R9  | R10 | R11 | R12 | R13 | R14 | R15 |

Figure 6: The division process if  $Q = 1$ .

|         |    |    |    |    |    |    |    |    |    |     |     |     |     |     |     |     |
|---------|----|----|----|----|----|----|----|----|----|-----|-----|-----|-----|-----|-----|-----|
| $Q=0$   | R1 | R2 | R3 | R4 | R5 | R6 | R7 | R8 | R9 | R10 | R11 | R12 | R13 | R14 | R15 | 0   |
| XOR     | 0  | 0  | 0  | 0  | 0  | 0  | 0  | 0  | 0  | 0   | 0   | 0   | 0   | 0   | 0   | 0   |
| New CRC | R0 | R1 | R2 | R3 | R4 | R5 | R6 | R7 | R8 | R9  | R10 | R11 | R12 | R13 | R14 | R15 |

Figure 7: The division process if  $Q = 0$ .

|                         |     |    |    |    |    |    |    |    |    |     |     |     |     |     |     |     |
|-------------------------|-----|----|----|----|----|----|----|----|----|-----|-----|-----|-----|-----|-----|-----|
| $Q=(D \text{ XOR } R0)$ | R1  | R2 | R3 | R4 | R5 | R6 | R7 | R8 | R9 | R10 | R11 | R12 | R13 | R14 | R15 | 0   |
| XOR                     | X16 | 0  | 0  | 0  | Q  | 0  | 0  | 0  | 0  | 0   | Q   | 0   | 0   | 0   | 0   | Q   |
| New CRC                 | R0  | R1 | R2 | R3 | R4 | R5 | R6 | R7 | R8 | R9  | R10 | R11 | R12 | R13 | R14 | R15 |

Figure 8: The division process regardless of the value of  $Q$ .

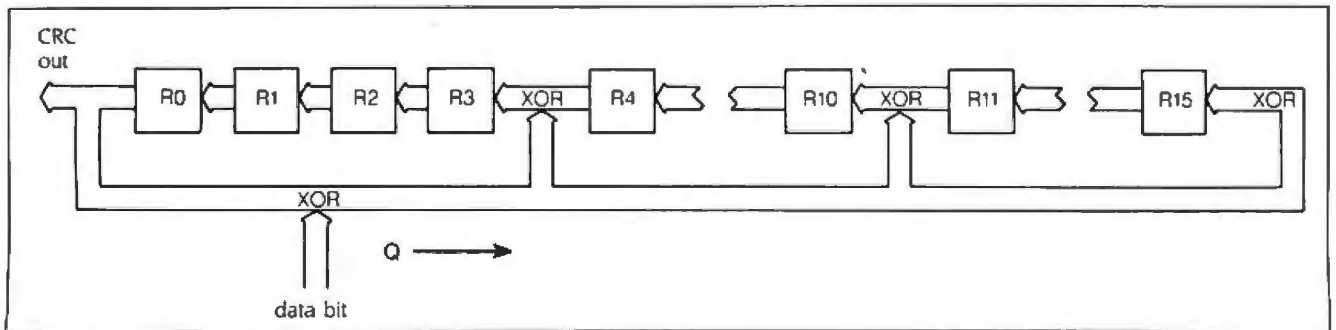

Figure 9: The process shown in figure 8 translated into a hardware circuit using shift registers and XOR gates. (The boxes are stages to a shift register; the shift register is only 16 stages long.) Note that the XOR gate going into R15 is superfluous, since  $Q \text{ XOR } 0$  is always  $Q$ . Note also that in the long-division method, the calculations are done before "bringing down" the next zero bit. Similarly here, the XORs are performed before the shift.

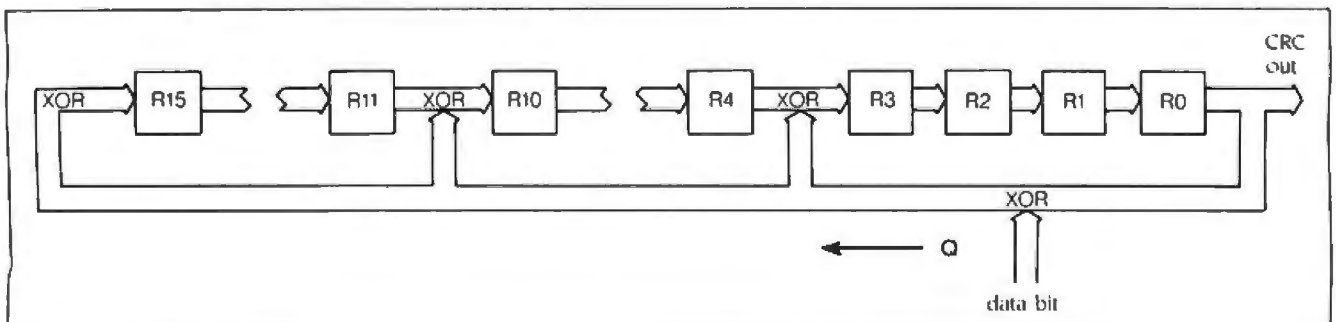

Figure 10: The reverse drawing of figure 9; the LSB is on the right instead of on the left.



ister. However, after the division is complete, the left bit will always be a zero. Either it was a zero to begin with, or if it was a one, it was XORed with the  $X^{16}$  bit of the polynomial, which is also a one, producing a zero. Thus, you can XOR with only the 16 LSBs of the polynomial. In the case of the CRC-CCITT polynomial,  $X^{16} + X^{12} + X^5 + 1$  (1 0001 0000 0010 0001 in binary or 1 021 in hexadecimal), you can XOR with 0 1021.

Let the bits of the CRC register be R0, R1, up to R15; let the data bits be D0 up to D7; let the polynomial bits be X0 up to X15; and define  $Q = D \text{ XOR } R0$ , that is, set Q equal to the current data bit, D, XORed with R0. In every case, the LSB is bit 0.

Then, if  $Q = 1$ , the division process looks like that in figure 6. If  $Q = 0$  XOR R0 is zero, then the division reduces to that in figure 7. But when  $Q = 1$ , the new R15 is always 1, and you XOR R4 and R11 with X12 and X5, which are 1. If  $Q = 0$ , then the new R15 is zero and you XOR R4 and R11 (and all other Rns) with zero.

You can combine the two cases as shown in figure 8. Turning that process into a circuit using shift registers and XOR gates (see figure 9) is straightforward. You can also draw the circuit so that the LSB (R0) is on the right (see figure 10). Both diagrams are convenient depending on the kind of software algorithm to be derived. Note that in hardware the XOR is done before the shift because of the way flip-flops work. The important point is that the new R10 = (old R11) XOR (old R0) XOR (new data bit).

**BIT-BY-BIT SOFTWARE ALGORITHMS**

When you do the calculations in software, you don't have to do the XOR before the shift. The important thing in software is to avoid having to deal with 17-bit values that don't fit into a variable. A software routine also doesn't need to use the  $Q = D \text{ XOR } R0$  result to drive a gate. You can program the polynomial directly into the code as a constant.

You can now derive a software routine based on figure 10 (or figure 9, in which the order of storing the bits of the CRC is reversed). If you assume

that the CRC result is kept in a 16-bit integer with R15 (the MSB of the CRC) in the high (leftmost) bit position, then if  $Q = 1$ , you first shift the previous CRC to the right as in figure 11. In terms of a high-level language, you shift the CRC right by one, discarding the LSB, and XOR with 0 8408. By

testing Q first and then doing the shift before the XOR, you avoid the need for a 17-bit register. Because of the way in which the CRC is stored in the variable, the XOR is done with 0 8408 rather than 0 1021, as you might expect. This follows directly from the

*(continued)*

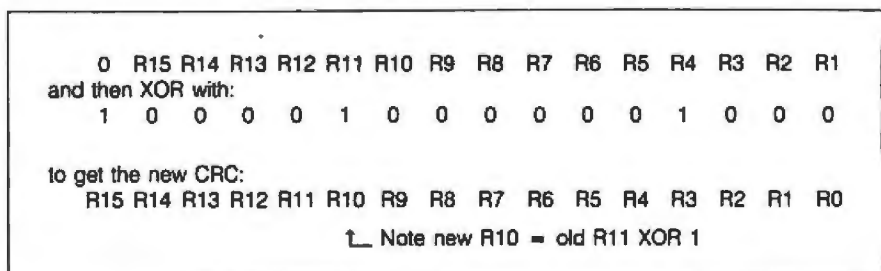

Figure 11: The diagram for a software routine based on the hardware circuit in figure 10. When  $Q = 1$  the new CRC becomes the previous CRC shifted right by one bit position and XORed with G(X).

Listing 1: CCITTC, the CCITT routine for calculating CRCs in C source code.

```

/* Straightforward, non-optimized CRC-CCITT routine */
/* Assumes 16-bit integer variables */
/* MSB of integer is MSB of CRC result */
#define POLY 0x8408
/* POLY = 1021 in bit rev order*/
BLKCRC(bufptr, crcres, count)
 unsigned char *bufptr;
 unsigned int *crcres, count;
 {
 int i;
 crcres = 0; / for SDLC use 0xFFFF */
 for (i=1; i<=count; ++i, bufptr++) /* do for whole BLK*/
 bytecrc(bufptr, crcres) /* do CRC for 1 char */
 return (*crcres);
 } /* end BLKCRC */

bytecrc(bufptr, crcres)
 unsigned char *bufptr;
 unsigned int *crcres;
 {
 unsigned int j,ch,Q;
 ch = (unsigned int) *bufptr; /* get char, to int fmt*/
 for (j=1; j<=8; j++) { /* do each bit LSB 1st */
 Q=(*crcres&0x0001)^(ch&0x0001) /* Q=R0 XOR D */
 if (Q == 0x0001) { /* Q is one */
 *crcres= *crcres>>1; /* shift right one */
 *crcres= *crcres^POLY; /* XOR with number */
 }
 else /* Q is zero */
 *crcres= *crcres>>1; /* just shift no XOR */
 ch = ch >>1; /* move next data bit */
 /* into position */
 } /* end FOR - data bits all done */
 return (*crcres);
 } /* end bytecrc */

```

diagram shown in figure 10. Generally speaking, if you process data LSB first, you can store the CRC with its MSB in the MSB position of the integer variable.

Listing 1 contains the implementation of a CRC calculation based on the CCITT polynomial. CCITT provides lots of intermediate results, for clarity rather than performance. This program implements the CCITT/IBM FCS calculation in a standard way with one exception: initializing the CRC. [Editor's note: CCITT, XMODEM.C, SDLC.ASM, and XMODEM.ASM for OS9 are available in several formats; see the insert card after page 368.]

The purpose, however, is to implement the de facto XMODEM standard. I found no published XMODEM CRC specification as such. What has been published is a C program,

XMODEM.C, that does the calculations (see listing 2). Apart from using the CCITT polynomial, this program is not CCITT standard in that data is processed MSB first, rather than LSB first, and the CRC is initialized to zeros rather than to ones.

### CHOICES IN CRC CALCULATION AND TRANSMISSION

A CRC calculated by these methods has some very desirable error-detection properties, but it is not perfect. For example, you can add or delete any number of zero bits to or from the beginning of the block without affecting the CRC. (The remainder stays zero no matter how many zero bits start the block.) Furthermore, since the CRC is a cyclic code, any error, such as a clock slippage, that deletes

a bit at the beginning of the block and inserts the same bit at the end of the block (the last bit of the CRC) will not affect the CRC. For these reasons the CRCs used by IBM in the SDLC protocol and CCITT in the X.25 and HDLC protocols specify the following:

1. All bits of a block are protected by the CRC.
2. The data is sent LSB first. The CRC is calculated on bits as they are sent.
3. The CRC is initialized to all ones. This allows detection of any missed or inserted zero bits at the beginning of a block. (Missed or inserted ones are still detected.)
4. The one's complement of the

(continued)

Listing 2: XMODEM.C, the XMODEM routine for calculating CRCs in C source code.

```

/* Sample bit-oriented CRC routine */
/* Adapted from YMODEM protocol reference */

/* Calculate CRC on a block of data. */
/* Ptr points to block of characters, count gives size of buffer. */
/* This program returns the CRC with the LSB of the CRC in the */
/* high bit of the result integer. */
/* XMODEM deviates from the CCITT standard in that it does not use */
/* the LSB of the data 1st, nor does it initialize the CRC to all */
/* ones as specified by the standard. */

int calcrc(ptr, count)
char *ptr;
int count;
{
 unsigned int crc;
 int i;
 crc = 0; /* note not 0xFFFF */
 while (--count >= 0) {
 i = (int) *ptr++; /* convert data char to int */
 i = i << 8; /* shift char to high byte */
 crc = crc ^ i; /* add current data to current */
 /* remainder modifies only least */
 /* sig 8 bits (high byte) of CRC */
 for (i=0; i<8; ++i) /* loop for each bit */
 if (crc & 0x8000) { /* test D XOR R0 */
 crc = (crc << 1); /* discard LSB of CRC and */
 /* append zero */
 crc = crc ^ 0x1021; /* XOR with low 16 bits */
 /* of CCITT polynomial */
 /* because CRC is stored LSB 1st */
 /* polynomial written MSB 1st */
 } /* endif */
 else /* discard LSB & append 0 */
 crc = crc << 1;
 } /* end while */
 return (crc & 0xFFFF); /* 16-bit result for whole block */
} /* end calcrc */

```

# The single best way to turn your PC-AT into a multi-user system.



## Introducing the Wyse WY-60.

Now there's a perfectly compatible, reliable, economical, Wyse way to get multi-user mileage from your PC-AT. Wyse WY-60 terminals give you complete compatibility for your IBM Personal Computer AT systems, right down to the exact keyboard layout, character set and display features.

The only thing different is how much cleaner and more readable your information is with the WY-60's high resolution and flat, non-glare, 14" tilt/swivel screen.

Multiple display formats go up to 132 columns and 44 lines on one screen, to get the most out of applications such as Multiplan and WordStar.

And a 512-character downloadable soft font is also there when you need mathematical symbols or customized character sets.

The adjustable arm is optional, and you can choose a green, white or amber screen.

No wonder we ship more terminals than anybody but IBM.\*

Call toll-free or write, today, for more information. Wyse Technology, Attn: Marcom Department 60-AT, 3571 N. First St., San Jose, California 95134.

Call 1-800-GET-WYSE

# WYSE

YOU NEVER REGRET A WYSE DECISION.

Wyse is a registered trademark of Wyse Technology. WY-60 and the "V" shaped design are trademarks of Wyse Technology. IBM and IBM Personal Computer AT are trademarks of International Business Machines Corporation. WordStar is a registered trademark of MicroPro International. Multiplan is a registered trademark of Microsoft Corporation. © 1986 Wyse Technology. \*Estimated 1985 terminal shipment update.

## CALCULATING CRCs

|     |     |     |     |     |     |     |    |    |    |    |    |    |    |    |    |   |
|-----|-----|-----|-----|-----|-----|-----|----|----|----|----|----|----|----|----|----|---|
| Bit | *15 | 14  | 13  | 12  | 11  | *10 | 9  | 8  | 7  | 6  | 5  | 4  | *3 | 2  | 1  | 0 |
| R15 | R14 | R13 | R12 | R11 | R10 | R9  | R8 | R7 | R6 | R5 | R4 | R3 | R2 | R1 | R0 |   |

Figure 12: The contents of the shift register at the beginning of bitwise SDLC calculations.

|         |          |     |     |     |     |                 |     |    |    |    |    |    |                |    |    |    |
|---------|----------|-----|-----|-----|-----|-----------------|-----|----|----|----|----|----|----------------|----|----|----|
| Bit     | *15      | 14  | 13  | 12  | 11  | *10             | 9   | 8  | 7  | 6  | 5  | 4  | *3             | 2  | 1  | 0  |
| Shift 1 | D0<br>R0 | R15 | R14 | R13 | R12 | R11<br>D0<br>R0 | R10 | R9 | R8 | R7 | R6 | R5 | R4<br>D0<br>R0 | R3 | R2 | R1 |

Figure 13: The contents of the shift register after the first shift. Note that all entries in a column are XORed together.

|         |     |     |     |     |     |           |     |    |    |    |    |    |          |    |    |    |
|---------|-----|-----|-----|-----|-----|-----------|-----|----|----|----|----|----|----------|----|----|----|
| Bit     | *15 | 14  | 13  | 12  | 11  | *10       | 9   | 8  | 7  | 6  | 5  | 4  | *3       | 2  | 1  | 0  |
| Shift 1 | T0  | R15 | R14 | R13 | R12 | R11<br>T0 | R10 | R9 | R8 | R7 | R6 | R5 | R4<br>T0 | R3 | R2 | R1 |

Figure 14: The same as figure 13 but with the abbreviation T0 for D0 XOR R0.

|         |     |    |    |    |     |           |           |           |           |     |    |    |    |    |    |    |
|---------|-----|----|----|----|-----|-----------|-----------|-----------|-----------|-----|----|----|----|----|----|----|
| Bit     | *15 | 14 | 13 | 12 | 11  | *10       | 9         | 8         | 7         | 6   | 5  | 4  | *3 | 2  | 1  | 0  |
| Shift 4 | T3  | T2 | T1 | T0 | R15 | R14<br>T3 | R13<br>T2 | R12<br>T1 | R11<br>T0 | R10 | R9 | R8 | R7 | R6 | R5 | R4 |

Figure 15: The contents of the shift register after three more right shifts. T0 represents D0 XOR R0, T1 represents D1 XOR R1, and so on.

|         |     |    |    |    |    |     |           |           |           |           |     |    |    |    |    |    |
|---------|-----|----|----|----|----|-----|-----------|-----------|-----------|-----------|-----|----|----|----|----|----|
| Bit     | *15 | 14 | 13 | 12 | 11 | *10 | 9         | 8         | 7         | 6         | 5   | 4  | *3 | 2  | 1  | 0  |
| Shift 5 | T4  | T3 | T2 | T1 | T0 | R15 | R14<br>T4 | R13<br>T3 | R12<br>T2 | R11<br>T1 | R10 | R9 | R8 | R7 | R6 | R5 |

Figure 16: The contents of the shift register after the fifth shift.

|         |     |    |    |    |    |     |    |    |     |           |           |           |           |           |          |          |
|---------|-----|----|----|----|----|-----|----|----|-----|-----------|-----------|-----------|-----------|-----------|----------|----------|
| Bit     | *15 | 14 | 13 | 12 | 11 | *10 | 9  | 8  | 7   | 6         | 5         | 4         | *3        | 2         | 1        | 0        |
| Shift 8 | T7  | T6 | T5 | T4 | T3 | T2  | T1 | T0 | R15 | R14<br>T7 | R13<br>T6 | R12<br>T5 | R11<br>T4 | R10<br>T3 | R9<br>T2 | R8<br>T1 |

Figure 17: The contents of the shift register after the eighth shift.

CRC is transmitted rather than the CRC itself. This allows detection of slippage-type errors.

5. The CRC is sent LSB first.
6. The polynomial used is  $X^{16} + X^{12} + X^5 + 1$ .

XMODEM.C implements the CRC as follows:

1. Only data bits are included. The header character and two block-number bytes are not included.
2. The data is sent LSB first. The CRC is calculated on the data MSB first.
3. The CRC is initialized to zeros.
4. The CRC is not complemented before transmission.
5. The order of transmission is high byte of CRC then low byte. Since UARTs transmit LSB first, this is equivalent to LSB of high byte through MSB of high byte, then LSB of low byte through MSB of low byte.
6. The polynomial used is  $X^{16} + X^{12} + X^5 + 1$ .

The CCITT method is easily implemented in a chip using shift registers and XOR gates, while the XMODEM method is not easily realized in hardware. To check an incoming data block, you have two options. You can calculate the CRC on all the protected bits only, omitting the CRC bits, and compare the calculated value to the received value. Or you can calculate the CRC on all the protected bits and the CRC itself and then compare the result to a known constant. If the first method is adopted in the CCITT case, the one's complement of the calculated value must be compared to the received CRC. In the XMODEM case, the comparison is direct. If the second method is adopted, in the XMODEM case the known constant is zero, while in the CCITT case it is 0 F0B8. (The high bit is on the left, i.e., 1.) No one's-complementing is required.

### BYTE-ORIENTED SOFTWARE IMPLEMENTATIONS

The next step is to derive routines to calculate the CRC a whole byte at a time rather than bit by bit. This approach was first proposed by Perez, Wismer, and Becker. The motivation is that an 8-bit microprocessor is not

## CALCULATING CRCs

limited to single-bit XORs but can do them 8 bits at a time. The basic approach is to work from the hardware diagram (figure 9 or 10) and see what the CRC register would look like after 8 bits have been calculated.

**Byte-wise SDLC calculations.** In figure 10 you can see that you have the contents of figure 12 in the shift register at the beginning of calculations. Then you take the LSB of data, D0, and XOR it with R0 (D0 XOR R0). After the right shift, the new R15 is D0 XOR R0, the new R10 is R11 XOR D0 XOR R0, and the new R3 is R4 XOR D0 XOR R0. (See figure 13).

The combinations D0 XOR R0, D1 XOR R1, D2 XOR R2, and so on, occur frequently, so let's abbreviate them as T0 = D0 XOR R0, T1 = D1 XOR R1, and so on. Figure 13 can now be rewritten as in figure 14. If you proceed in this fashion for three more shifts, you get figure 15.

To do the XOR on D4, you must use the content of the LSB of the shift register, which is now R4 XOR D0 XOR R0. The result is D4 XOR R4 XOR D0 XOR R0, or in shorter form, T4 XOR T0. The result after the fifth shift is shown in figure 16; after the eighth shift, in figure 17.

The tedious part is done. Now you want to write a program that will produce the same result when you're working with a byte of data as you would get from the shift register after eight shifts. The emphasis in this routine will be on speed. If you make it too general-purpose, a different choice of polynomial will lead to a completely different program. Also, for speed, it makes sense to code the routine in assembly language.

When working with 8-bit microcomputers, it is convenient to define the 8-bit quantities found in table 2. If you study figure 17, you will see that the combination

T7 T6 T5 T4  
XOR T3 T2 T1 T0

occurs several times. Let's call this term U = U7 U6 U5 U4. If you rewrite figure 17 with these substitutions, you get figure 18.

Further optimizations become apparent as you write the code. It is convenient to implement the SDLC algo-

| Bit    | *15 | 14 | 13 | 12 | 11 | *10 | 9  | 8  | 7   | 6   | 5   | *3  | 2   | 1   | 0  |    |
|--------|-----|----|----|----|----|-----|----|----|-----|-----|-----|-----|-----|-----|----|----|
| Line # |     |    |    |    |    |     |    |    |     |     |     |     |     |     |    |    |
| 1      |     |    |    |    |    |     |    |    | R15 | R14 | R13 | R12 | R11 | R10 | R9 | R8 |
| 2      | U7  | U6 | U5 | U4 | T3 | T2  | T1 | T0 |     |     |     |     |     |     |    |    |
| 3      |     |    |    |    |    | U7  | U6 | U5 | U4  | T3  | T2  | T1  | T0  |     |    |    |
| 4      |     |    |    |    |    |     |    |    |     |     |     |     | U7  | U6  | U5 | U4 |

**Figure 18:** The same as figure 17 but using the abbreviations given in table 2. Line 1 is CRCHi moved into CRCLo; line 2 is the high nybble of U and the low nybble of T; line 3 is the line 2 byte shifted left by 3 bits; and line 4 is U shifted right by 4 bits.

**Table 2:** Some convenient abbreviations for various 8-bit quantities used in CRC calculations in an 8-bit microcomputer environment.

|         |     |     |     |     |     |     |    |    |
|---------|-----|-----|-----|-----|-----|-----|----|----|
| CRCHi = | R15 | R14 | R13 | R12 | R11 | R10 | R9 | R8 |
| CRCLo = | R7  | R6  | R5  | R4  | R3  | R2  | R1 | R0 |
| Data =  | D7  | D6  | D5  | D4  | D3  | D2  | D1 | D0 |
| T =     | T7  | T6  | T5  | T4  | T3  | T2  | T1 | T0 |
| U =     | U7  | U6  | U5  | U4  | 0   | 0   | 0  | 0  |

**Table 3:** Some test cases provided for comparison if you want to write your own routine.

| Text                           | SDLC | CRC  |
|--------------------------------|------|------|
| T                              | 1B26 | 14A1 |
| THE                            | 44BE | 7D8D |
| THE,QUICK,BROWN,FOX,0123456789 | DF91 | 7DC5 |

| 15  | 14  | 13  | 12  | 11  | 10  | 9  | 8  | 7  | 6  | 5  | 4  | 3  | 2  | 1  | 0  |
|-----|-----|-----|-----|-----|-----|----|----|----|----|----|----|----|----|----|----|
| R15 | R14 | R13 | R12 | R11 | R10 | R9 | R8 | R7 | R6 | R5 | R4 | R3 | R2 | R1 | R0 |

**Figure 19:** The contents of the shift register at the beginning of byte-wise XMODEM calculations.

| 15  | 14  | 13  | 12  | 11  | 10  | 9  | 8  | 7  | 6  | 5  | 4  | 3  | 2  | 1  | 0  |
|-----|-----|-----|-----|-----|-----|----|----|----|----|----|----|----|----|----|----|
| R15 | R14 | R13 | R12 | R11 | R10 | R9 | R8 | R7 | R6 | R5 | R4 | R3 | R2 | R1 | R0 |
| D7  | D6  | D5  | D4  | D3  | D2  | D1 | D0 |    |    |    |    |    |    |    |    |

**Figure 20:** The contents of the shift register after the XOR with the data byte.

rithm (as in the program SDLC.ASM) because of the built-in check that calculating a CRC on a "received" block provides; that is, the result should always be 0 F0B8.

The innermost loop of SDLC.ASM

takes only 86 cycles per byte including seven overhead cycles to check for end of buffer. If a 2-MHz 6809 were dedicated to CRC calculations, this would result in a through-

*(continued)*

## CALCULATING CRCs

|    |    |    |    |    |    |    |    |    |    |    |    |    |    |    |    |
|----|----|----|----|----|----|----|----|----|----|----|----|----|----|----|----|
| 15 | 14 | 13 | 12 | 11 | 10 | 9  | 8  | 7  | 6  | 5  | 4  | 3  | 2  | 1  | 0  |
| T7 | T6 | T5 | T4 | T3 | T2 | T1 | T0 | R7 | R6 | R5 | R4 | R3 | R2 | R1 | R0 |

Figure 21: The same as figure 20 but with the abbreviations T7 for R15 XOR D7, T6 for R14 XOR D6, and so on.

|    |    |    |    |    |    |    |    |    |    |    |    |    |    |    |    |
|----|----|----|----|----|----|----|----|----|----|----|----|----|----|----|----|
| 15 | 14 | 13 | 12 | 11 | 10 | 9  | 8  | 7  | 6  | 5  | 4  | 3  | 2  | 1  | 0  |
| T6 | T5 | T4 | T3 | T2 | T1 | T0 | R7 | R6 | R5 | R4 | R3 | R2 | R1 | R0 | T7 |
|    |    |    | T7 |    |    |    |    |    |    | T7 |    |    |    |    |    |

Figure 22: The contents of the shift register after processing the first data bit and performing the left shift.

|    |    |    |    |    |    |    |    |    |    |    |    |    |    |    |    |
|----|----|----|----|----|----|----|----|----|----|----|----|----|----|----|----|
| 15 | 14 | 13 | 12 | 11 | 10 | 9  | 8  | 7  | 6  | 5  | 4  | 3  | 2  | 1  | 0  |
| T3 | T2 | T1 | T0 | R7 | R6 | R5 | R4 | R3 | R2 | R1 | R0 | T7 | T6 | T5 | T4 |
| T7 | T6 | T5 | T4 |    |    |    | T7 | T6 | T5 | T4 |    |    |    |    |    |

Figure 23: The contents of the shift register after four shifts.

|    |    |    |    |    |    |    |    |    |    |    |    |    |    |    |    |
|----|----|----|----|----|----|----|----|----|----|----|----|----|----|----|----|
| 15 | 14 | 13 | 12 | 11 | 10 | 9  | 8  | 7  | 6  | 5  | 4  | 3  | 2  | 1  | 0  |
| T2 | T1 | T0 | R7 | R6 | R5 | R4 | R3 | R2 | R1 | R0 | T7 | T6 | T5 | T4 | T3 |
| T6 | T5 | T4 | T3 |    |    | T7 | T6 | T5 | T4 | T3 |    |    |    |    | T7 |

Figure 24: The contents of the shift register after five shifts.

|    |    |    |    |    |    |    |    |    |    |    |    |    |    |    |    |
|----|----|----|----|----|----|----|----|----|----|----|----|----|----|----|----|
| 15 | 14 | 13 | 12 | 11 | 10 | 9  | 8  | 7  | 6  | 5  | 4  | 3  | 2  | 1  | 0  |
| R7 | R6 | R5 | R4 | R3 | R2 | R1 | R0 | T7 | T6 | T5 | T4 | T3 | T2 | T1 | T0 |
| T3 | T2 | T1 | T0 |    |    |    | T7 | T6 | T5 | T4 |    | T7 | T6 | T5 | T4 |
| T7 | T6 | T5 | T4 |    |    |    |    |    |    |    |    |    |    |    |    |
|    |    |    | T7 | T6 | T5 | T4 | T3 | T2 | T1 | T0 |    |    |    |    |    |

Figure 25: The contents of the shift register after eight shifts.

Table 4: The same test cases as in table 3 but for XMODEM.

| Text                           | XMODEM CRC |
|--------------------------------|------------|
| T                              | 1A71       |
| THE                            | 1E0A       |
| THE,QUICK,BROWN,FOX,0123456789 | 049B       |

put of about 200,000 bps. A bitwise algorithm to do the same job takes on average 353 cycles per byte and could take as many as 385. So the bitwise algorithm is about four times faster.

The test cases in table 3 are provided in case you want to write your own routine. The column labeled SDLC results when you initialize the CRC with ones (this is the result before the one's-complementing), and the column labeled CRC results when you initialize with zeros.

XMODEM byte-oriented algorithms. The XMODEM CRC "spec." such as it is, is shown in listing 2. If you repeat the work done for SDLC calculations (in figures 12 through 18) using listing 2 as a base, you will obtain the contents of the diagrams in figures 19 through 25. The contents of the starting CRC are shown in figure 19. After the XOR with the data byte, you get the result shown in figure 20. When you abbreviate R15 XOR D7 as T7, R14 XOR D6 as T6, and so on, figure 20 becomes figure 21. After processing the first data bit and the left shift, you get the result shown in figure 22; after four shifts, figure 23; after five shifts, figure 24; and after eight shifts (the final result), figure 25. Next, you define the appropriate variables such as CRCHI, CRCLO, T, and U, and you look for factors.

An implementation of the XMODEM CRC calculations for the 6809 is given in the program XMODEM.ASM. The test case results using the XMODEM algorithm are shown in table 4.

### CONCLUSION

Once you arrive at the basic idea of using the XOR function to implement modulo 2 division, it is not difficult to apply the CRC algorithms, only tedious. As with so many other communications standards, the options and the details provide most of the difficulties and confusion. ■

### BIBLIOGRAPHY

- Forsberg, Chuck, ed. "XMODEM/YMODEM Protocol Reference." Godzilla BBS. (503) 621-3746.
- IBM SDLC General Information Manual, Appendix B.
- McNamara, J. E. *Technical Aspects of Data Communications*. Bedford, MA: Digital Equipment Press, 1982.

## How has SYSTAT become one of the largest statistical software companies in only 3 years?

### LESS BULK:

- Will run from floppy disks
- Needs less memory (256K on IBM or compatible machines, 64K on CP/M, 400K on VAX, or 512K on Apple Macintosh)
- Has fewer than 1/5 of the commands of other manufacturers' packages

### MORE STATISTICS:

- Full screen spreadsheet data editor
- Missing data, arrays, character variables
- Unlimited cases
- Process rectangular, hierarchical, triangular files and variable length records
- Relational database management and file concatenation
- Character, numeric, and nested sorts
- Unlimited numeric and character transformations
- Interactive or batch
- Read and write text and external files
- Subgroup processing in statistical modules with SELECT and BY
- Value labels
- RECODE statements for quick multiple codes
- Scatterplots, contours, histograms, stem-and-leaf, boxplots, bar charts, quantile, probability plots
- Basic statistics, frequencies, T-tests
- Multi-way crosstabs with log-linear modeling, association coefficients, PRE statistics, asymptotic standard errors
- Pairwise/listwise missing value correlation, SSCP, covariance, Spearman, Gamma, Kendall Tau, Euclidean distances
- Linear, polynomial, multiple, stepwise, weighted regression
- Extended regression diagnostics
- Multivariate general linear model

- Multi-way ANOVA, ANOCOVA, MANOVA, repeated measures, unbalanced designs, post-hoc tests
- Principal components with rotations and scores
- Multidimensional scaling
- Multiple and canonical discriminant analysis, Bayesian classification
- Canonical correlation
- Cluster analysis (hierarchical, single, average, complete median, centroid linkage, k-means, cases, variables)
- Nonparametric statistics (sign, Runs, Wilcoxon, Kruskal-Wallis, Friedman two-way ANOVA, Mann-Whitney U, Kolmogorov-Smirnov, Lilliefors, Kendall coefficient of concordance)
- Time Series (smoothing, seasonal and nonseasonal ARIMA, ACF, PACF, Cross-correlation function, transformations, forecasting, Fourier analysis)
- Nonlinear estimation (non-linear regression, least absolute values regression, logit, probit, maximum likelihood estimation, iteratively reweighted least squares)
- Supplements include: *Logit* (multinomial logit), *Probit* (probit analysis), *Testat* (classical and Rasch model test analysis), *Report* (formatter for SYSTAT files), *Transfer* (dBase, Lotus, GAUSS, STATA, SPSS direct file transfer)

SYSTAT operates on the following machines: IBM-PC, XT, AT,™ Apple II,™ Apple Macintosh,™ Kaypro,™ HP 150,™ HP 9000,™ DEC Rainbow,™ VAX,™ Alpha Micro,™ MS-DOS,™ CP/M™ and UNIX.™

Single copy price:  
\$595 USA and Canada / \$695 Foreign  
Site licenses and quantity prices available

Call or write for additional information

SYSTAT, Inc.  
2902 Central Street  
Evanston, IL 60201

312 864.5670

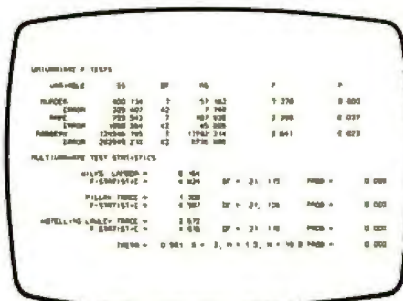

CP/M

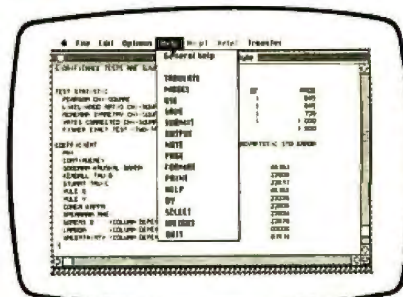

Apple Macintosh

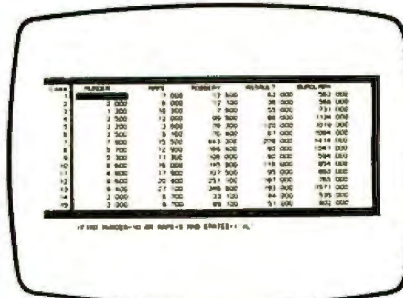

VAX

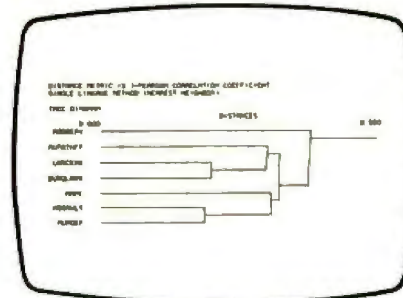

IBM PC

Read more about the extraordinary success of SYSTAT in *So You've Got a Great Idea*, by Steve Fifer (Addison Wesley, 1986).

# MICRO CAP and MICRO LOGIC put your engineers on line... not in line.



## MY OWN WORKSTATION



How many long unproductive hours have you spent "in line" for your simulation? Well, no more. MICROCAP and MICROLOGIC can put you on line by turning your PC into a productive and cost-effective engineering workstation.

Both of these sophisticated engineering tools provide you with quick and efficient solutions to your simulation problems. And here's how.

## MICROCAP: Your Analog Solution

MICROCAP is an interactive analog circuit drawing and simulation system. It allows you to sketch a circuit diagram right on the CRT screen, then run an AC, DC, or Transient analysis. While providing you with libraries for defined models of bipolar and MOS devices, Opamps, transformers, diodes, and much more, MICROCAP also includes features not even found in SPICE.

MICROCAP II lets you be even more productive. As an advanced version, it employs sparse matrix techniques for faster simulation speed and larger net-

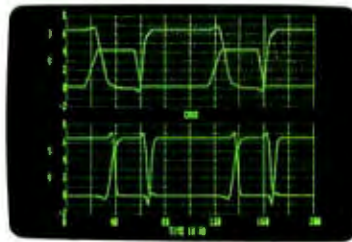

"Typical MICROCAP Transient Analysis"

works. In addition, you get even more advanced device models, worst case capabilities, temperature stepping, Fourier analysis, and macro capability.

## MICROLOGIC: Your Digital Solution

MICROLOGIC provides you with a similar interactive drawing and analysis environment for digital work. Using standard PC hardware, you can create logic diagrams of up to 9 pages with each containing up to 200 gates. The system automatically creates the netlist required for a timing simulation and will handle networks of up to 1800 gates. It provides you with libraries for 36 user-defined basic gate types, 36 data channels of 256 bits each, 10 user-defined clock waveforms, and up to 50 macros in each network. MICROLOGIC produces high-resolution timing diagrams showing selected waveforms and associated delays, glitches, and spikes—just like the real thing.

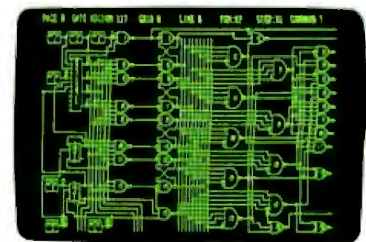

"Typical MICROLOGIC Diagram"

## Reviewers Love These Solutions

Regarding MICROCAP... "A highly recommended analog design program" (PC Tech Journal 3/84). "A valuable tool for circuit designers" (Personal Software Magazine 11/83).

Regarding MICROLOGIC... "An efficient design system that does what it is supposed to do at a reasonable price" (Byte 4/84).

MICROCAP and MICROLOGIC are available for the Apple II (64k), IBM PC (128k), and HP-150 computers and priced at \$475 and \$450 respectively. Demo versions are available for \$75.

MICROCAP II is available for the Macintosh, IBM PC (256k), and HP-150 systems and is priced at \$895. Demo versions are available for \$100.

Demo prices are credited to the purchase price of the actual system.

Now, to get on line, call or write today!

## Spectrum Software

1021 S. Wolfe Road, Dept. B  
Sunnyvale, CA 94087  
(408) 738-4387

Inquiry 325



# BREAKING OUT

BY EDWARD BATUTIS

*This routine enables a breakpoint  
in the PC-DOS DEBUG program*

MOST DEBUGGERS have a "break-out" switch that allows you to jump into the debugger regardless of what your computer is doing. Unfortunately, the DEBUG program provided with IBM PC-DOS does not have this feature. I have designed a program called BREAKPT (short for breakpoint) that gives PC-DOS DEBUG this capability (see listings 1 and 2). [Editor's note: BREAKPT.ASM and BRKPTCOM.BAS are available in a variety of formats; see the insert card following page 368.]

## HOW BREAKPT WORKS

BREAKPT is a memory-resident program that you need to run just once after booting your computer. It searches for a specific set of keystrokes. When it finds them, the program executes the breakpoint interrupt (interrupt 3). If DEBUG is running, BREAKPT prints out the registers, shows the next instruction, and waits for a command.

BREAKPT intercepts the keyboard interrupt (interrupt 9), which is invoked every time you strike a key. The program examines the keyboard flags in the ROM BIOS data area. The first flag, at segment 40H (hexadecimal), byte 17H, shows what Shift and Control keys are currently depressed. If the flags indicate that the Control key

and both Shift keys are depressed simultaneously, BREAKPT sets the microprocessor's trap flag (bit 8) to 1. This initiates the execution of interrupt 3 (the breakpoint interrupt) via interrupt 1 (single step).

For example, you install BREAKPT by entering the command BREAKPT at the DOS prompt. If you want to explore the inner workings of BASICA.COM, you load DEBUG and

BASICA.COM with the command DEBUG BASICA.COM. Then you start BASICA with the go, or g, command. At this point, BASICA is in a loop waiting for a keyboard entry. If you hold down the Control, left Shift, and right Shift keys and then release them,

*(continued)*

Edward Batutis is a systems analyst for LFP Systems Inc. (4600 Marriott Dr., Suite 400, Raleigh, NC 27612).

Listing 1: Assembly language source code for BREAKPT.

```

; BREAKPT
; Copyright 1985, Edward Batutis
;
; Invokes the breakpoint interrupt when Ctrl-Shift-Shift
; combination is pressed.

; Assembled with the IBM Macro Assembler Version 1.00

cseg segment para public 'code'
 assume cs:cseg,ds:cseg
 org 100h

breakpt proc

 jmp install

copyright db 'BREAKPT (c) Copyright 1985,'
 db ' Edward J. Batutis',01ah

old_int9_vector label dword
old_int9_offs dw ?
old_int9_eeg dw ?

```

*(continued)*

## BREAKING OUT

```

new_int9:
 ; call old keyboard routine by simulating an int
 pushf
 call cs:old_int9_vector

 push es ; save registers
 push ax
 push bx

 mov ax,40h ; look at keyboard flag1 in
 mov es,ax ; ROM BIOS data area
 mov bx,17h
 mov al,es:[bx]
 and al,07h ; mask off everything but lowest
 ; three bits
 cmp al,7 ; are Ctrl-Shift-Shift depressed?
 jne quit ; no, quit

 ; turn on the trap flag

 pop bx ; restore registers
 pop ax
 pop es

 push ax ; save register
 pushf ; get flags into ax
 pop ax

 or ax,0100h ; set trap flag on
 push ax ; put new flags back
 popf
 pop ax ; restore ax
 nop ; wait one instruction
 iret ; debug is invoked at this instruction

quit:
 pop bx ; restore registers when
 pop ax ; quitting
 pop es

done:
 iret

END_OF_RESIDENT_CODE LABEL BYTE
banner db 'BREAKPT Installed.',10,13,'$'

install:
 ; get interrupt vector for
 ; keyboard interrupt

 mov ah,35h ; get interrupt vector function
 mov al,9 ; get interrupt 9
 int 21h

 cmp bx,offset new_int9 ; are we already installed?
 je no_install ; yes, just exit

 mov old_int9_offs,bx ; save old keyboard interrupt
 mov old_int9_seg,es ; address

 mov dx,offset banner ; print banner
 mov ah,9 ; print string function
 int 21h

 ; set keyboard interrupt
 ; to point to new_int9

```

# ASYSTANT scientific software. Flexible menu-driven environment gets you up and running—fast.

Fully integrated analysis, graphics, and processing functions operate directly on large datasets.



Lets you interact visually with your data. Just scroll, select curve segments, and watch your results appear.

Unique features give you flexibility not found in most menu-driven packages.

On-line help is always available by typing "?".

Acquired data is immediately available for analysis and graphics. You never have to shuffle programs.



Gives you more power for the price than any other software for the IBM PC.

A single keystroke lets you import data from spreadsheet and other data file formats.

Presentation-quality scientific graphics easily output to plotters.

## The PC software of choice when you don't want to program.

Now get the power of widely acclaimed ASYST™ Scientific Software in a stand-alone menu-driven package: ASYSTANT Ready-to-Run Scientific Software™. Easy to learn and use whatever your computer background, ASYSTANT is a fully integrated analysis and graphics package. It's versatile, too. Unlike other menu-driven products, ASYSTANT gives you an extensive feature set and macro capability to tackle your toughest applications.

Built-in functions include FFT, smoothing, integration, differentiation, curve fitting, statistics, differential equations, and matrix and polynomial operations. And all analysis functions are fully linked to powerful graphics capabilities, including axonometric and contour plotting. ASYSTANT menu-driven scientific software—just \$495.

**Optional data acquisition with ASYSTANT +.** Get all the features of the ASYSTANT package, plus

one-touch data acquisition, with ASYSTANT +. No extensive prompt lists. No tedious set-up. Just choose the "metaphor" of the collection instrument you wish to simulate—such as XY or strip chart recorder, data logger, or signal averager—and you're ready to go. Only \$895.

**Free technical support.** 60 days of free technical support help you design, set up, and fine-tune the perfect system. It's your guarantee of trouble-free operation.

**30-Day No-Risk Offer.  
CALL 1-800-348-0033**

In New York state, (212) 702-3241.

## Macmillan Software Co.

An affiliate of Macmillan Publishing Company  
630 Third Avenue, New York, NY 10017

ASYSTANT Ready-to-Run Scientific Software and ASYST are trademarks of Macmillan Software Co. ASYST and ASYSTANT were developed by Adaptable Laboratory Software, P.O. Box 18448, Rochester, NY 14618

## BREAKING OUT

```

mov ah,25h ; set interrupt function
mov al,9 ; set interrupt 9
mov dx,offset new_int9 ; point to new routine
int 21h

 ; terminate, but stay
 ; partially resident
 ; point to last byte of resident
 ; routines+1

mov dx,offset END_OF_RESIDENT_CODE+1
int 27h

no_install:
int 20h ; don't install, just exit

breakpt endp

cseg ends
end breakpt

```

Listing 2: The BASIC program that creates BREAKPT.COM.

```

100 'RUN THIS PROGRAM (BRKPTCOM.BAS) TO CREATE breakpt.com
110 PRINT "Creating breakpt.com"
120 OUTFILE$="breakpt.com"
140 DATA &hEB, &h74, &h90, &h42, &h52, &h45, &h41, &h4B, &h50, &h54
150 DATA &h20, &h28, &h63, &h29, &h20, &h43, &h6F, &h70, &h79, &h72
160 DATA &h69, &h67, &h68, &h74, &h20, &h31, &h39, &h38, &h35, &h2C
170 DATA &h20, &h45, &h64, &h77, &h61, &h72, &h64, &h20, &h4A, &h2E
180 DATA &h20, &h42, &h61, &h74, &h75, &h74, &h69, &h73, &h1A, &h00
190 DATA &h00, &h00, &h00, &h9C, &h2E, &hFF, &h1E, &h31, &h01, &h06
200 DATA &h50, &h53, &hB8, &h40, &h00, &h8E, &hC0, &hBB, &h17, &h00
210 DATA &h26, &h8A, &h07, &h24, &h07, &h3C, &h07, &h75, &h0E, &h5B
220 DATA &h58, &h07, &h50, &h9C, &h58, &h0D, &h00, &h01, &h50, &h9D
230 DATA &h58, &h90, &hCF, &h5B, &h58, &h07, &hCF, &h42, &h52, &h45
240 DATA &h41, &h4B, &h50, &h54, &h20, &h69, &h6E, &h73, &h74, &h61
250 DATA &h6C, &h6C, &h65, &h64, &h2E, &h0A, &h0D, &h24, &hB4, &h35
260 DATA &hB0, &h09, &hCD, &h21, &hB1, &hFB, &h35, &h01, &h74, &h1D
270 DATA &h89, &h1E, &h31, &h01, &h8C, &h06, &h33, &h01, &hBA, &h61
280 DATA &h01, &hB4, &h09, &hCD, &h21, &hB4, &h25, &hB0, &h09, &hBA
290 DATA &h35, &h01, &hCD, &h21, &hBA, &h62, &h01, &hCD, &h27, &hCD
300 DATA &h20
310 TOTAL= 161
320 OPEN OUTFILE$ AS #1 LEN=1
330 FIELD #1,1 AS A$
340 FOR I=1 TO TOTAL
350 READ A
360 LSET A$=CHR$(A)
370 PUT 1
380 NEXT
390 CLOSE
400 PRINT"Done."
410 END

```

Table 1: An example of the register-content display produced by BREAKPT.

```

AX=3920 BX=3160 CX=0324 DX=0078 SP=FFDA BP=FFEE SI=0000 DI=000F
DS=3160 ES=48CE SS=48CE CS=435E IP=1D31 NV UP EI PL ZR AC PE NC
435E:1D31 CF IRET

```

# STATGRAPHICS®

**Now!**  
Faster, More Procedures,  
Improved Data Management!

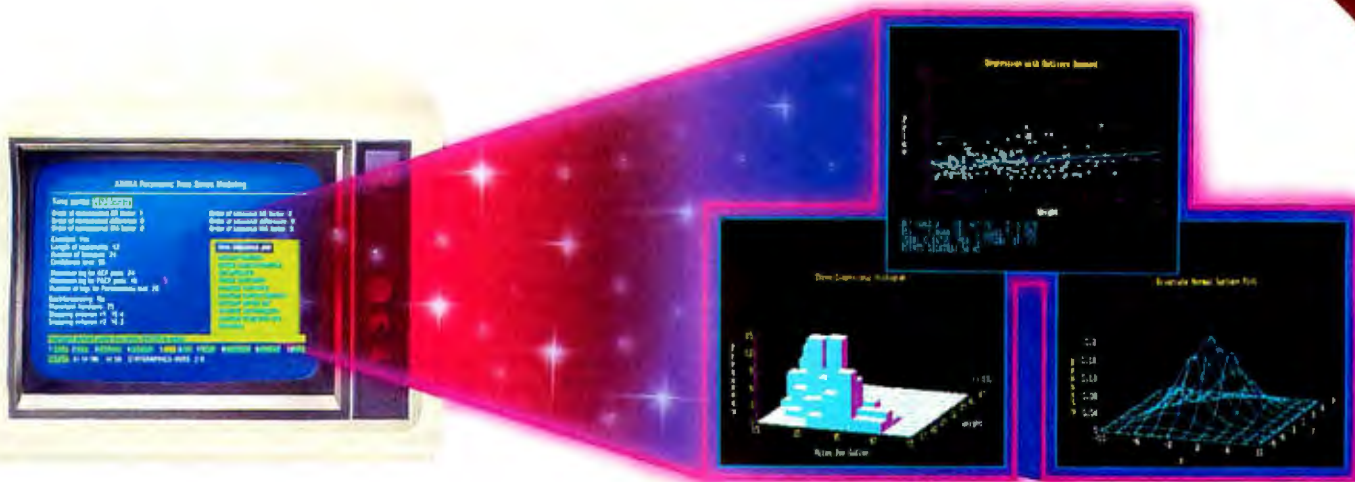

## Powerful Statistics, Sophisticated Graphics In One Complete Software System

STATGRAPHICS from STSC is simply the most complete and powerful statistical software available for your PC. STATGRAPHICS integrates powerful statistics with high-resolution color graphics—in one single software system—to give you an extraordinarily powerful analytical environment.

**"[STATGRAPHICS] is unusually complete as software systems go in terms of statistical capabilities."**  
*(PC Week)*

With more than 250 statistical and mathematical procedures, STATGRAPHICS offers you the power and precision of mainframe software—right on your PC. All the tools you need for comprehensive statistical analysis: ANOVA, complete regression analysis, experimental design, quality control procedures, multivariate techniques, nonparametric methods, and extensive forecasting and time series analysis, including Box-Jenkins.

**"I've found STATGRAPHICS to be one of the most complete and easy-to-use statistics programs that I have come across."**

*(Whole Earth Software Catalog)*

All this statistical power is even more valuable with STATGRAPHICS' unique interactive environment. STATGRAPHICS is completely menu-driven so you can get into your statistical analysis work quickly and be productive right from the start. You can easily go back and forth between your numerical and graphical analysis—change variables as many times as you want—and see the effect immediately.

You can also enter and access data easily. STATGRAPHICS has a full-screen data editor and interfaces with standard ASCII files, Lotus® 1-2-3® and Symphony® worksheets, and dBASE® files.

**"Verdict: [STATGRAPHICS is] a model PC software system which will set standards for PC statistical software."**

*(PC User Magazine)*

STATGRAPHICS offers you a wide variety of graphics capabilities to help you visually analyze your data—more options and more sophistication than any other PC statistical software. Included are histograms, two- and three-dimensional line and surface plots, scatter plots, time sequence plots, quality control charts, as well as bar and pie charts. STATGRAPHICS supports a wide range of graphics boards, printers, and plotters.

For the most complete, advanced statistical graphics software system available, order STATGRAPHICS today. To order, contact your local dealer. If they don't have it, tell them to call STSC toll-free.

**(800) 592-0050**

**In Maryland or Canada call (301) 984-5123.**

### STATGRAPHICS—the best overall choice!

|              | Integrated Statistical Graphics | Direct Lotus & dBASE Interfaces | Menu-Driven | Minimum Hardware Required | Helpline Support | U.S. Suggested Retail Price    |
|--------------|---------------------------------|---------------------------------|-------------|---------------------------|------------------|--------------------------------|
| STATGRAPHICS | ✓                               | ✓                               | ✓           | Dual Floppy Disk          | ✓                | \$795*                         |
| SPSS/PC +*   | NO                              | NO                              | NO          | 10 Meg Hard Disk          | ✓                | \$1385                         |
| SAS/PC       | NO                              | NO                              | ✓           | 20 Meg Hard Disk          | ✓                | \$2700+ Annual Maintenance Fee |

## STSC

Inquiry 330

Available nationally through Softtel and distributors worldwide. Dealer inquiries welcome.

\*International prices slightly higher. STATGRAPHICS, SAS, and dBASE are registered trademarks of Statistical Graphics Corporation, SAS Institute Inc., and Ashton-Tate, respectively. Lotus, 1-2-3, and Symphony are registered trademarks of Lotus Development Corp. PLUS\*WARE and SPSS/PC+ are trademarks of STSC, Inc. and SPSS Inc., respectively.

**A PLUS\*WARE™ PRODUCT**

The ultimate time saving  
input device for IBM PC<sup>T</sup>

# KEYPORT 60

60 Programmable  
Function Keys!

Polytel's programmable multifunction keypad, the KEYPORT 60, is your key to one-finger pushbutton software.

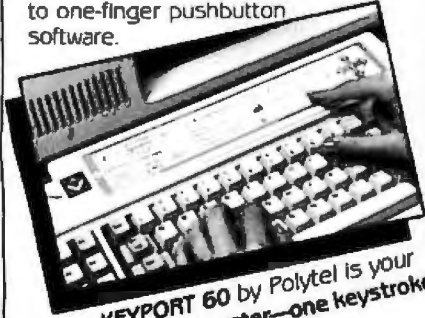

The KEYPORT 60 by Polytel is your Productivity Booster—one keystroke instead of many!

- ★ Every key fully programmable
- ★ Label the keys so you never forget which key does what
- ★ Ideal for entering repetitive commands with a single touch
- ★ No need to memorize hard-to-remember command sequences
- ★ Includes ready-to-go templates for DOS, WordStar, Lotus 1-2-3, and BASIC
- ★ Runs on IBM PC, XT, AT, and compatibles
- ★ Connects to game port—leaves your other ports free
- ★ Does not interfere with normal operation of regular keyboard.
- ★ 60-day money back guarantee—no risk to you.

★ ★ ★ ★ Price—\$139 ★ ★ ★ ★  
(add \$6 shipping for each Keyport)

— SPECIAL OFFER —  
Game port included!  
A \$45 value!

To order, call Polytel at

**1-800-245-6655**

In California, call **1-408-730-1347**

Or send \$145 check or money order to

**Polytel Computer Products Corp.**  
1250 Oakmead Parkway, Suite 310  
Sunnyvale, California 94086

In the UK and Scandinavia, contact

**Electrone Ltd.**

Maywood House, High Street  
Pinner, Middlesex HA5 5QA  
Tel: 01-429-2433



VISA, MasterCard & American Express  
cheerfully accepted!

## BREAKING OUT

Table 2: The meanings of the various bits in the keyboard flags.

| Segment | Offset | Bit | Meaning               |
|---------|--------|-----|-----------------------|
| 40H     | 17H    | 0   | Right Shift depressed |
|         |        | 1   | Left Shift depressed  |
|         |        | 2   | Ctrl depressed        |
|         |        | 3   | Alt depressed         |
|         |        | 4   | Scroll Lock toggled   |
|         |        | 5   | Num Lock toggled      |
|         |        | 6   | Caps Lock toggled     |
| 40H     | 18H    | 7   | Ins active            |
|         |        | 0   | No meaning            |
|         |        | 1   | No meaning            |
|         |        | 2   | No meaning            |
|         |        | 3   | Suspend key toggled   |
|         |        | 4   | Scroll Lock depressed |
|         |        | 5   | Num Lock depressed    |
|         |        | 6   | Caps Lock depressed   |
|         |        | 7   | Ins depressed         |

you will see a display that resembles the one in table 1.

The instruction displayed at the end of the table, IRET, is the last instruction in the BREAKPT routine itself. The contents of the registers will vary depending on exactly where the program is when you press Control-Shift-Shift and depending on where DEBUG is loaded in memory.

If you use the DEBUG trace command, t, you will see the instruction immediately following the one you interrupted. If you use the go command, g, you will return to BASICA.

To explore a particular feature of BASICA, you can write a program that puts the interpreter in a loop and then break out of it with Control-Shift-Shift. For example, breaking out during the program

```
10 a=1.0*1.0:goto 10
```

will probably put you somewhere in (or near) the floating-point multiplication routine.

You can also use BREAKPT if you are debugging a program and it gets away from you. For example, if you set a DEBUG breakpoint in the wrong place, or if the program does something unexpected and does not execute the breakpoint you've set, you can often save yourself by pressing Control-Shift-Shift.

You must be careful not to press Control-Shift-Shift when DEBUG is not

loaded. Also, DEBUG is not very good at debugging programs that make a lot of calls to DOS because DEBUG itself uses DOS. If DEBUG is called during certain DOS interrupts, you normally won't be able to return to the original calling program. It's also important to keep in mind that the breakpoint interrupt won't execute if the interrupts within DEBUG are disabled. DEBUG will be invoked when they become enabled. For this reason, you don't always break out where you think you should.

### MODIFICATIONS

The default condition when DEBUG starts up is for the interrupts to be turned off. If you want to turn them on before starting the program you want to debug, enter the following DEBUG commands: r f then ei. If you want to change the keystrokes that invoke BREAKPT, see table 2, which contains a list of the meanings of each bit in the keyboard flags.

You can alter BREAKPT quickly and easily by using the assemble command in DEBUG or by altering and assembling the source code using the IBM Macro Assembler. You mask the bits that you don't want to check using the and instruction, and then you test to see if the proper bits are turned on with the cmp (compare) instruction. (BREAKPT is compatible with SideKick if loaded after it.) ■



# The C for Microcomputers

PC-DOS, MS-DOS, CP/M-86, Macintosh, Amiga, Apple II, CP/M-80, Radio Shack, Commodore, XENIX, ROM, and Cross Development systems

## MS-DOS, PC-DOS, CP/M-86, XENIX, 8086/80x86 ROM

### Manx Aztec C86

*"A compiler that has many strengths... quite valuable for serious work"*

Computer Language review, February 1985

**Great Code:** Manx Aztec C86 generates fast executing compact code. The benchmark results below are from a study conducted by Manx. The Dhrystone benchmark (CACM 10/84 27:10 p1018) measures performance for a systems software instruction mix. The results are without register variables. With register variables, Manx, Microsoft, and Mark Williams run proportionately faster. Lattice and Computer Innovations show no improvement.

|                            | Execution Time | Code Size | Compile/Link Time |
|----------------------------|----------------|-----------|-------------------|
| <b>Dhrystone Benchmark</b> |                |           |                   |
| Manx Aztec C86 3.3         | 34 secs        | 5,760     | 93 secs           |
| Microsoft C 3.0            | 34 secs        | 7,146     | 119 secs          |
| Optimized C86 2.20J        | 53 secs        | 11,009    | 172 secs          |
| Mark Williams 2.0          | 56 secs        | 12,980    | 113 secs          |
| Lattice 2.14               | 89 secs        | 20,404    | 117 secs          |

**Great Features:** Manx Aztec C86 is bundled with a powerful array of well documented productivity tools, library routines and features.

|                         |                             |
|-------------------------|-----------------------------|
| Optimized C compiler    | Symbolic Debugger           |
| AS86 Macro Assembler    | LN86 Overlay Linker         |
| 80186/80286 Support     | Librarian                   |
| 8087/80287 Sensing Lib  | Profiler                    |
| Extensive UNIX Library  | DOS, Screen, & Graphics Lib |
| Large Memory Model      | Intel Object Option         |
| Z (vi) Source Editor -c | CP/M-86 Library -c          |
| ROM Support Package -c  | INTEL HEX Utility -c        |
| Library Source Code -c  | Mixed memory models -c      |
| MAKE, DIFF, and GREP -c | Source Debugger -c          |
| One year of updates -c  | CP/M-86 Library -c          |

Manx offers two commercial development systems, Aztec C86-c and Aztec C86-d. Items marked -c are special features of the Aztec C86-c system.

|                                       |              |
|---------------------------------------|--------------|
| <b>Aztec C86-c Commercial System</b>  | <b>\$499</b> |
| <b>Aztec C86-d Developer's System</b> | <b>\$299</b> |
| <b>Aztec C86-p Personal System</b>    | <b>\$199</b> |
| <b>Aztec C86-a Apprentice System</b>  | <b>\$49</b>  |

All systems are upgradable by paying the difference in price plus \$10.

**Third Party Software:** There are a number of high quality support packages for Manx Aztec C86 for screen management, graphics, database management, and software development.

|                         |                            |
|-------------------------|----------------------------|
| <b>C-tree \$395</b>     | <b>Greenleaf \$185</b>     |
| <b>PHACT \$250</b>      | <b>PC-lint \$98</b>        |
| <b>HALO \$250</b>       | <b>Amber Windows \$59</b>  |
| <b>PRE-C \$395</b>      | <b>Windows for C \$195</b> |
| <b>WindScreen \$149</b> | <b>FirstTime \$295</b>     |
| <b>SunScreen \$99</b>   | <b>C Util Lib \$185</b>    |
| <b>PANEL \$295</b>      | <b>Plink-86 \$395</b>      |

## MACINTOSH, AMIGA, XENIX, CP/M-68K, 68k ROM

### Manx Aztec C68k

*"Library handling is very flexible... documentation is excellent... the shell a pleasure to work in... blows away the competition for pure compile speed... an excellent effort."*

Computer Language review, April 1985

Aztec C68k is the most widely used commercial C compiler for the Macintosh. Its quality, performance, and completeness place Manx Aztec C68k in a position beyond comparison. It is available in several upgradable versions.

|                                            |                                                                                |
|--------------------------------------------|--------------------------------------------------------------------------------|
| Optimized C Macro Assembler Overlay Linker | Creates Clickable Applications Mouse Enhanced SHELL Easy Access to Mac Toolbox |
| Resource Compiler                          | UNIX Library Functions                                                         |
| Debuggers                                  | Terminal Emulator (Source)                                                     |
| Librarian                                  | Clear Detailed Documentation                                                   |
| Source Editor                              | C-Stuff Library                                                                |
| MacRam Disk -c                             | UniTools (vi,make,diff,grep) -c                                                |
| Library Source -c                          | One Year of Updates -c                                                         |

Items marked -c are available only in the Manx Aztec C86-c system. Other features are in both the Aztec C86-d and Aztec C86-c systems.

|                                        |              |
|----------------------------------------|--------------|
| <b>Aztec C68k-c Commercial System</b>  | <b>\$499</b> |
| <b>Aztec C68d-d Developer's System</b> | <b>\$299</b> |
| <b>Aztec C68k-p Personal System</b>    | <b>\$199</b> |
| <b>C-tree database (source)</b>        | <b>\$399</b> |
| <b>AMIGA, CP/M-68k, 68k UNIX</b>       | <b>call</b>  |

## Apple II, Commodore, 65xx, 65C02 ROM

### Manx Aztec C65

*"The AZTEC C system is one of the finest software packages I have seen"*

NIBBLE review, July 1984

A vast amount of business, consumer, and educational software is implemented in Manx Aztec C65. The quality and comprehensiveness of this system is competitive with 16 bit C systems. The system includes a full optimized C compiler, 6502 assembler, linkage editor, UNIX library, screen and graphics libraries, shell, and much more. The Apple II version runs under DOS 3.3, and ProDOS. Cross versions are available.

The Aztec C65-c/128 Commodore system runs under the C128 CP/M environment and generates programs for the C64, C128, and CP/M environments. Call for prices and availability of Apprentice, Personal and Developer versions for the Commodore 64 and 128 machines.

|                                          |              |
|------------------------------------------|--------------|
| <b>Aztec C65-c ProDOS &amp; DOS 3.3</b>  | <b>\$399</b> |
| <b>Aztec C65-d Apple DOS 3.3</b>         | <b>\$199</b> |
| <b>Aztec C65-p Apple Personal system</b> | <b>\$99</b>  |
| <b>Aztec C65-a for learning C</b>        | <b>\$49</b>  |
| <b>Aztec C65-c/128 C64, C128, CP/M</b>   | <b>\$399</b> |

### Distribution of Manx Aztec C

In the USA, Manx Software Systems is the sole and exclusive distributor of Aztec C. Any telephone or mail order sales other than through Manx are unauthorized.

## Manx Cross Development Systems

Cross developed programs are edited, compiled, assembled, and linked on one machine (the HOST) and transferred to another machine (the TARGET) for execution. This method is useful where the target machine is slower or more limited than the HOST. Manx cross compilers are used heavily to develop software for business, consumer, scientific, industrial, research, and educational applications.

**HOSTS:** VAX UNIX (\$3000), PDP-11 UNIX (\$2000), MS-DOS (\$750), CP/M (\$750), MACINTOSH (\$750), CP/M-68k (\$750), XENIX (\$750).

**TARGETS:** MS-DOS, CP/M-86, Macintosh, CP/M-68k, CP/M-80, TRS-80 3 & 4, Apple II, Commodore C64, 8086/80x86 ROM, 68xxx ROM, 8080/8085/Z80 ROM, 65xx ROM.

The first TARGET is included in the price of the HOST system. Additional TARGETS are \$300 to \$500 (non VAX) or \$1000 (VAX).

Call Manx for information on cross development to the 68000, 65816, Amiga, C128, CP/M-68k, VRTX, and others.

## CP/M, Radio Shack, 8080/8085/Z80 ROM

### Manx Aztec CII

*"I've had a lot of experience with different C compilers. But the Aztec C80 Compiler and Professional Development System is the best I've seen."*

80-Micro, December, 1984, John B. Harrell III

|                                       |              |
|---------------------------------------|--------------|
| <b>Aztec C II-c (CP/M &amp; ROM)</b>  | <b>\$349</b> |
| <b>Aztec C II-d (CP/M)</b>            | <b>\$199</b> |
| <b>C-tree database (source)</b>       | <b>\$399</b> |
| <b>Aztec C80-c (TRS-80 3 &amp; 4)</b> | <b>\$299</b> |
| <b>Aztec C80-d (TRS-80 3 &amp; 4)</b> | <b>\$199</b> |

### How To Become an Aztec C User

To become an Aztec C user call 1-800-221-0440 or call 1-800-832-9273 (800-TEC WARE). In NJ or outside the USA call 201-530-7997. Orders can also be telexed to 4995812.

Payment can be by check, COD, American Express, VISA, Master Card, or Net 30 to qualified customers.

Orders can also be mailed to Manx Software Systems, Box 55, Shrewsbury, NJ 07701.

### How To Get More Information

To get more information on Manx Aztec C and related products, call 1-800-221-0440, or 201-530-7997, or write to Manx Software Systems.

### 30 Day Guarantee

Any Manx Aztec C development system can be returned within 30 days for a refund if it fails to meet your needs. The only restrictions are that the original purchase must be directly from Manx, shipped within the USA, and the package must be in resalable condition. Returned items must be received by Manx within 30 days. A small restocking fee may be required.

### Discounts

There are special discounts available to professors, students, and consultants. A discount is also available on a "trade in" basis for users of competing systems. Call for information.

Inquiry 216

# MANX

To order or for information call:

## 800-221-0440



MOTOROLA

DIGITAL RESEARCH  
GEM/GEM DOS 68K

RM/COBOL

Pascal 2  
Oregon Software

RTUX

RESEARCH  
Concurrent DOS

polyFORTH II

Technical Documentation  
UNIX  
SYSTEM V/68  
MOTOROLA MICROSYSTEMS SYSTEM V/68 Volume IV

VRTX/68000 USER'S GUIDE

PL/M

ELESOFT ADA

FORTRAN 77

Technical Documentation  
VERSAdos  
MOTOROLA MICROSYSTEMS VERSAdos Volume I

FRANZ LISP  
Reference Manual

BASIC

Whitson's, Ltd.  
ESMITH'S LTD.  
C

M PROLOG

MODULA-2

Graphic Kernel System GK-2

M-T-O-S

MACRO ASSEMBLER 68000/68010/68020



# Put your chips on the software.

## The best bet.

If you're betting your future on a 32-bit microprocessor-based system, you'd rather bet a winner. Today, the clear winner is the MC68020 microprocessor. It's faster. It's fully supported in hardware and software. It's backed by what others have called, "The strongest support team in the business." And, we're delivering production quantities. Now.

In fact, last year Motorola shipped over 50,000 units and this year we expect to ship more than a quarter of a million MC68020s.

## Software support. Now.

When you choose the MC68020, you get the largest body of software available for 32-bit microprocessor-based machines. Operating systems. Languages. Tools and utilities. Host independent development systems. And, of course, applications. In fact, 80% of the microprocessor-based system designs running UNIX® OSs are based on M68000 Family chips.

## The fastest just got faster.

At 25 MHz, the latest version of the MC68020 and its earlier 20 MHz version remain

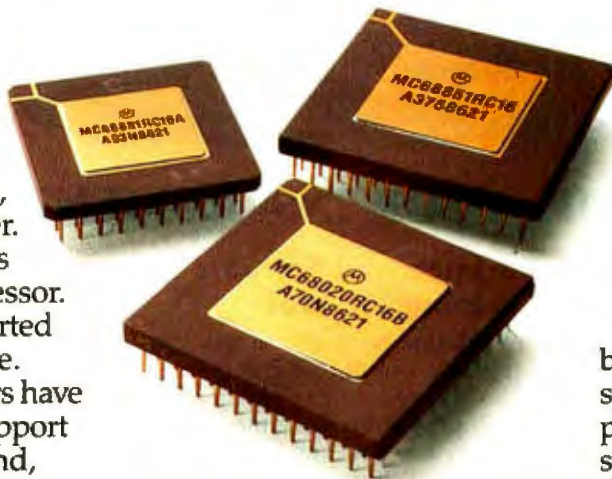

## The MC68020

the fastest general-purpose processors on the market today. And fully compatible. But speed alone isn't the answer. And for the generation beyond the MC68020, we're committed to higher performance devices while maintaining the M68000 Family software base.

## Chips, boards or boxes.

Motorola is with you at every level. As the world's leader in VMEbus products, supplying MC68020-based VMEmodule™ and VMEsystem™ products, we can work with your development team at virtually every level, including technical training.

## Betting the winner.

There's a lot of 32-bit talk in the press. Sampling quantities, blue sky and vaporware are fine, but maybe you'd rather not bet your company on them.

When you're planning to build the kind of leading-edge systems that win in the marketplace, Motorola offers you speed to market, aggressive pricing and the strength of a fully-realized 32-bit environment.

If you're an executive evaluating microprocessors, software and support, call us at 1-800-521-6274. We'll arrange a one-on-one management-level meeting. Fast. And we'll show you why a better microprocessor, coupled with here-and-now volume production, software and support, adds up to a winning combination.

UNIX is a registered trademark of AT&T  
Concurrent DOS and GEMDOS is a trademark of Digital Research Inc.  
VERSAdos is a registered trademark of Motorola Inc.  
VRTX is a registered trademark of Hunter & Ready, Inc.  
RTUX is a trademark of Emerge Systems  
ADA is a trademark of the Department of Defense  
VMEmodule and VMEsystem are trademarks of Motorola Inc.



**MOTOROLA**

# Microprocessor Development Dreams Come True!

On-Line Help menus,  
Command Glossary,  
and Word List.

Windows can be used  
to view source files,  
previous traces,  
and more.

Symbol translation  
or source code  
line display.

Screen displays scroll off  
into history buffer –  
can be viewed later.



Pop-up Mode  
Selection panel  
called by soft key.

Disassembly of code  
in memory can be  
compared with trace in  
adjacent window.

Symbolic debug  
register display.

Context sensitive  
prompt line.

## NEW UniLab II™: FOUR INSTRUMENTS IN ONE!

Here are all the development tools you ever dreamed of integrated into one PC-controlled system:

- An Advanced 48-Channel Bus State Analyzer
- An 8/16-Bit Universal Emulator
- A Built-In EPROM Programmer
- An Input Stimulus Generator

The synergy of these instruments that were designed together to work together saves you time and money. All UniLab II commands and menus are seamlessly integrated into a single, super-efficient working environment.

### An Integrated Software Environment, too!

Imagine being able to split your screen and look at real-time program traces and the source code that produced them at the same time! Then go to the On-Line Help or pop-up Mode Panels instantly.

If you see something on a trace that doesn't look like last time, you can hold it in one window while you scroll back through your previous displays.

If you set a breakpoint and single-step you can then go back to using the analyzer without missing a beat. You can even execute a DOS batch file from UniLab to edit, assemble, and link, then automatically load the new program and symbol table. UniLab uses the full power of the PC.

### Find bugs fast with Hardware-assisted Debugging

The traditional way to look for bugs is to single-step through suspect parts of the code until you catch it in the act. This requires a lot of guessing and wasted time.

With UniLab's built-in analyzer you eliminate the guesswork. Just describe the bug symptom as a trigger, and let the UniLab hardware search

for it as your program runs in real time. UniLab will show you a trace of the program steps leading up to the symptom, almost like magic.

### A friendly user interface

UniLab lets you use commands or menus – or a mixture of both. An on-line manual, soft-key help screens, a glossary of commands and their parameters, with full-screen writeups are also at the ready.

### Reconfigure for any 8 or 16-bit processor in seconds

Thanks to our unique approach to emulation, changes between processor types require only cable and diskette changes. At last count, we specifically support over 120 microprocessors.

Bonus! The built-in EPROM Programmer and Stimulus Generator are simply icing on the cake.

### Affordable capability

How much does all this superior capability cost? A lot less than our less able competitors, and probably a lot less than you expect. Our products are sold with a Money Back Guarantee, and our crack team of Applications Engineers is standing by if you need help. Get the full story on the amazing UniLab II and how it can liberate your development projects, today.

#### ACTION COUPON

Send me info on UniLab II and your No-Risk 10-Day Evaluation!

Name: \_\_\_\_\_ Title: \_\_\_\_\_  
Company: \_\_\_\_\_  
Address: \_\_\_\_\_  
City: \_\_\_\_\_  
State/ZIP: \_\_\_\_\_  
Tel.: \_\_\_\_\_ Ext. \_\_\_\_\_

**UniLab II™**  
Universal Development Laboratory



Orion Instruments, Inc.

# ORION

702 Marshall Street  
Redwood City, California 94063

**CALL TOLL FREE: 1-800-245-8500**

In California (415) 361-8883

# KEYED FILE ACCESS IN BASIC

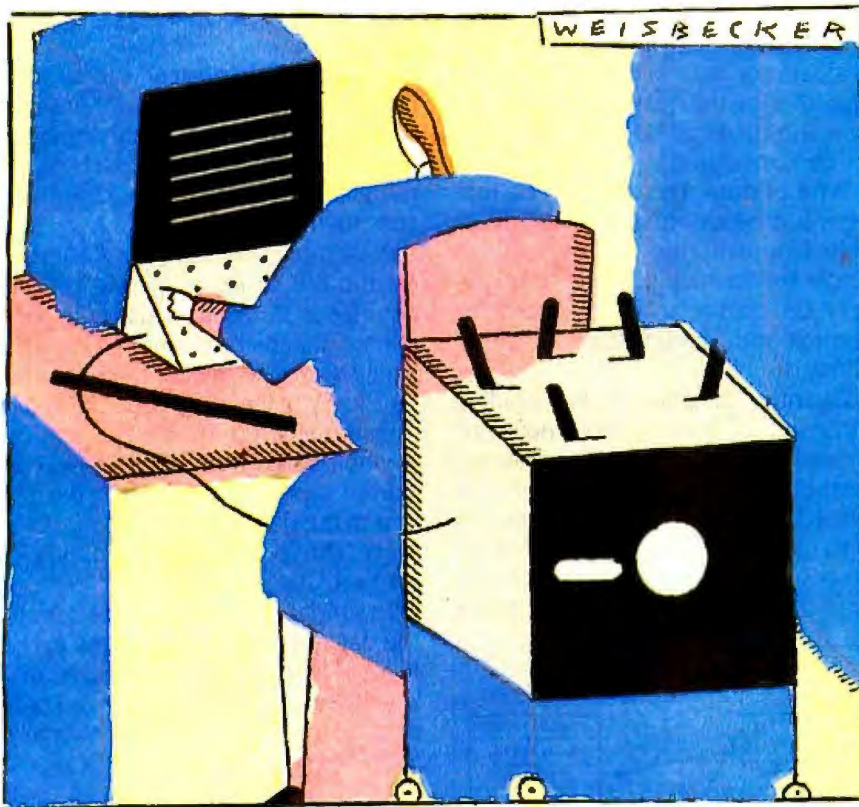

*These routines  
provide efficient access  
to data files*

**F**or both beginning and experienced BASIC programmers, maintaining data on disk files can be a challenging aspect of programming. For beginners, it's often a question of how to do it; for the more experienced, it's a matter of how to do it most efficient-

ly. Either way, programmers are limited by the file operations available in BASIC.

Most versions of BASIC provide two methods for accessing records on a disk file: sequential and random. With sequential access, you locate a record by reading from the beginning of the file until you retrieve the desired record; updating a record requires you to rewrite the entire file. Random access allows you to jump around in the file, directly reading or writing at any location. The record to be located is designated by its relative file position with a GET or PUT statement.

These access methods are adequate for the simple file-handling examples in most BASIC manuals but are of limited use in interactive programs that must respond promptly to user requests. For example, an accounting program that maintains customer records should respond quickly to a query for information about any customer. Typically, this requires searching the file for a record with the name or customer code supplied by the user. Clearly, searching sequentially takes too long for all but the shortest files, and random access often provides no way to locate a record by a field value. Thus the need for another access method—one that will find a record by its field value.

Accessing records by field values, called "keyed access," has long been available in high-level languages.

*(continued)*

Stephen C. Perry (3413 Malibu Dr., Raleigh, NC 27607) is a manager of information systems at Colton Inc. He specializes in applying microcomputers to office and management use. His interests are database management systems and local-area networks.

Using such routines as ISAM (indexed sequential access method), programs can read, write, delete, or update records by one or more key values. The programmer is relieved of coding the underlying search routine and maintaining data and file structures.

This article describes a set of sub-routines you can use in BASIC programs to provide keyed access. The routines enable you to randomly add, delete, update, and retrieve records based on a single, unique key value. The routines also provide sequential access to records based on ascending or descending key value.

Before examining the routines and how to use them, let's review the general concept and requirements of a file management system.

**FILE MANAGEMENT SYSTEMS**

The purpose of any file management system is to give you simple and fast access to records in a file. Ideally, the system should be set up as a "black box" that conceals from you the detailed steps needed to carry out file maintenance operations. Let's examine this box and see how file access is accomplished.

Logically, any file management system can be defined by its file structure, its data structure, and its method of searching. The file structure deter-

mines how records are actually stored on a disk, including the contents and format of data files, and any indexes required for keyed access. The data structure reflects how overhead information for accessing data is maintained in the program, that is, the arrays or list structures containing pointers and key values. The search method is based on the algorithm used to access the data structure. Usually, the method of searching determines the data structure.

Numerous techniques are available for implementing these essential features. To choose from them you must evaluate the data to be handled. The type of data, the quantity of data, and how the data will be accessed must all be considered.

**Type of data:** The data can be represented by records of fixed or variable length having no key fields, a single key, or multiple keys. The keys may be unique to each record, or records with duplicate keys may be allowed.

**Quantity of data:** A file holding thousands of records usually demands a more elaborate structure and access method than one with a few hundred records. The concern with larger files is to minimize the number of disk accesses required to search for a record. This is not as important for smaller

files, since it is possible to keep an index and set of keys in memory for the entire file.

**Processing requirements:** Four basic operations are required on most files—record addition, deletion, modification, and retrieval. What varies is how frequently, and on how much data, each operation must be performed.

Now, having examined the important features of file management in general, let's look at my file management routines.

**SKAM**

My routines are designed to handle files of approximately a thousand fixed-length records with a single unique key. I refer to this collection of routines as SKAM (single-keyed access method).

A data file and an index file make up the file structure of SKAM. The data file is simply a random file containing the records entered by the user. Normally, records are stored physically in the same order in which they are entered; the only exception is when space from deleted records is used. Opening and defining the format of the data file is the responsibility of the programmer and is described later.

The index file contains pointers to the data file that permit access to the records in ascending and descending key order. The programmer need only provide a name for this file. Internally, SKAM assigns the index file as logical file 1. It stores 64 pointers in each physical record.

Besides the pointers for ordering, three other types of information are kept in the index file: the last pointer in the last record contains the number of active records in the data file; the pointer preceding this one contains the number of deleted records in the data file; and a last-in/first-out stack of pointers to the deleted records precedes these last two values.

Corresponding to the data file and index file are two vectors (see figure 1) used by the BASIC routines to hold record keys and addresses. KE\$ contains the key values ordered by actual physical location, and PT% contains a sorted list of pointers that address

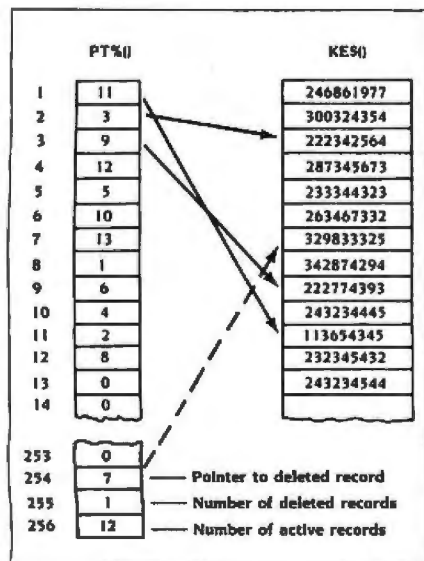

Figure 1: The SKAM vectors before a new record is inserted.

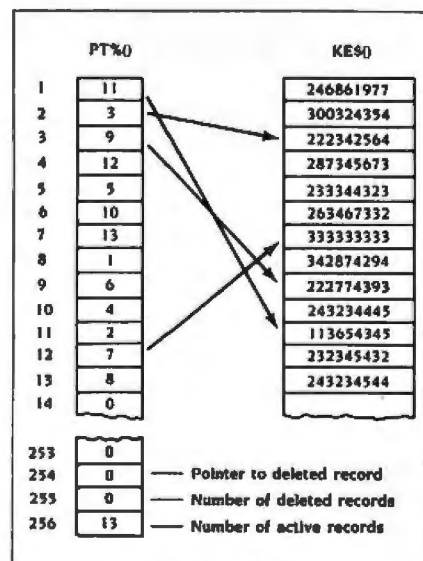

Figure 2: The SKAM vectors after a new record has been added. Note the changes in the PT% vector.

records by ascending key value. Vector PT% contains the exact contents of the index file, with the deleted and active record information stored in its last locations.

To understand the logic of this data structure, let's look at what happens when a record is added to a file. Figure 1 shows the original structure containing 12 records. Figure 2 shows it after a record with the key value 333333333 has been added. Note the changes:

- Location 7 in KE\$, which held a deleted key value, now holds the new key. The physical record has been stored as the seventh record in the data file.
- The total number of deleted records, in PT%(255) has been decremented by 1.
- The total number of active records, in PT%(256) has been incremented by 1.
- A pointer addressing the new record (location 7) has been inserted in location 12 of PT%. This indicates that the new key is logically twelfth in key sequence.

To delete a record, this process is reversed. A pointer is deleted from PT%, and the totals of deleted and active records are appropriately updated. The physical space of the deleted record is made available for reuse by placing a pointer to it in PT%.

It is important to realize that these changes to PT% do not immediately affect the index file; all changes occur only in main memory. As a result, this vector must be written back to the index file after all operations have been completed.

To locate records by key value, a binary search is performed using the vector PT%. First, the pointer at the midpoint of the vector is selected. The key it points to in KE\$ is then compared with a search key. If no match is found, the pointer search area is halved and the midpoint of the new range is selected. This process continues until a match or no match is confirmed.

By searching for keys in main memory, it is not necessary to access the disk for each comparison. Only when

Table 1: The SKAM routines arranged by function. To invoke an operation, set I1% to the required value. Depending upon the operation, other variables will also have to be set. The return code, RC%, indicates the result of the operation.

| I1% | Operation               | F1\$               | A\$                      | NX%                         | RC%                                                  |
|-----|-------------------------|--------------------|--------------------------|-----------------------------|------------------------------------------------------|
| 1   | Set Up Data Structure   | Name of index file |                          |                             | 0 - Successful<br>1 - Index name or MX% not defined  |
| 2   | Add Record              |                    | Key value                |                             | 0 - Successful<br>1 - Key exists<br>2 - File is full |
| 3   | Rewrite Record          |                    | Key of record to rewrite |                             | 0 - Successful<br>1 - Key does not exist             |
| 4   | Delete Record           |                    | Key of record to delete  |                             | 0 - Successful<br>1 - Key does not exist             |
| 5   | Read Record by Key      |                    | Key value                | Relative position of record | 0 - Successful<br>1 - Key does not exist             |
| 6   | Read Relative Record    |                    |                          | Relative location           | 0 - Successful<br>1 - Invalid location               |
| 7   | Store Index             |                    |                          |                             | 0 - Successful                                       |
| 8   | Display File Statistics |                    |                          |                             | 0 - Successful                                       |

a match is found must the actual record be read or written to disk. This works because a matching key found in the *n*th location of KE\$ has its corresponding record at the *n*th record position in the data file.

**USING THE SKAM ROUTINES**

The eight operations shown in table 1 are available for your BASIC programs. To use them, set variable I1% to the value of a desired operation, set any required parameters, and issue a GOSUB command to pass program control to the entry point of the SKAM subroutines. The desired operation, determined by I1%, will be performed and a return code sent back in variable RC%. If this value is 0, the operation was successful; other values identify specific errors.

Let's look at the details of these eight operations.

1. Set Up Data Structure reads the pointers from the index file into the vector PT% and reads the keys from

the data file into KE\$. This routine must be called before the other operations can be used. If F1\$ or MX% is not defined, a code of 1 is returned.

Parameters: I1%=1, F1\$=name of index file, MX%=maximum number of records.

2. Add Record stores a new record in the data file. The index is automatically updated to locate the record in proper key sequence. If a record with the key already exists, the operation will fail.

Parameters: I1%=2, A\$=key of record to be stored.

3. Rewrite Record writes a record back over itself. This allows a program to update a record by reading it, changing a field, and then rewriting the altered record in its old location.

Parameters: I1%=3, A\$=key of record to be rewritten.

4. Delete Record deletes a record having the specified key. Internally, the record is logically—not physically—

(continued)

# DRIVE INN

Enclosures  
& power  
supplies for  
**FLOPPY,  
WINCHESTER,  
TAPE DRIVES,  
SINGLE  
BOARD  
COMPUTERS  
&  
S-100  
SYSTEMS.**

8 inch  
5 inch  
3 inch

**CUSTOMIZING  
AVAILABLE**

Call or write  
for free  
catalogs  
and  
application  
assistance.

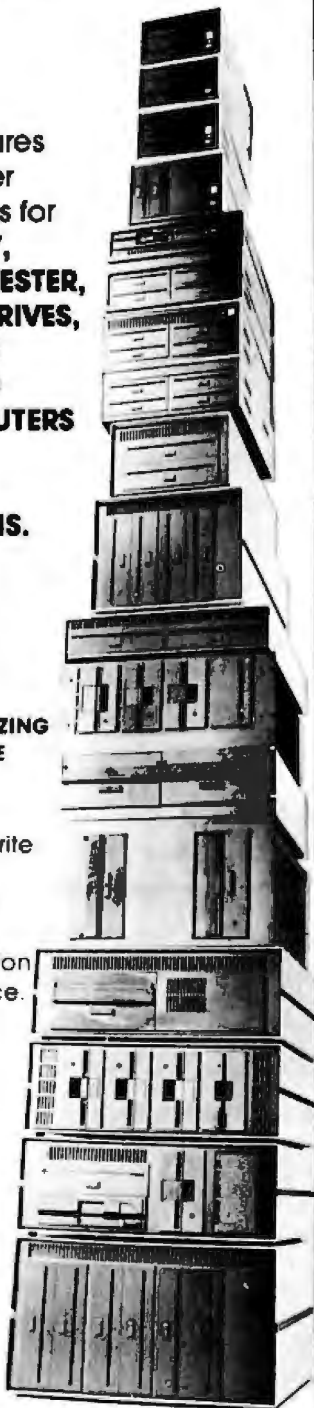

## INTEGRAND

RESEARCH CORPORATION  
8620 Roosevelt Ave. • Visalia, CA 93291  
209/651-1203

TELEX 5106012830 (INTEGRAND UD)  
EZLINK 62926572

We accept BankAmericard/VISA  
and MasterCard

## KEYED FILE ACCESS

Listing 1: A simple BASIC program for maintaining employee records illustrates the use of SKAM routines.

```

1 :-----
2 : SAMPLE PROGRAM USING KEYED ACCESS ROUTINES
3 :-----
4 :
5 UA$="A" ' .. DRIVE CONTAINING DATA
16 OPEN "R",#2,UA$+":DATA.EMP",84 ' .. OPEN DATA FILE
17 FIELD #2, 9 AS KY$, 20 AS NM$, 6 AS BD$, 1 AS SX$, 3 AS JC$, 20 AS A1$, 20 AS
 A2$, 5 AS ZP$
18 :
19 : KY$ - ZIP CODE (KEY) JC$ - JOB CODE
20 : NM$ - NAME A1$ - STREET ADDR.
21 : BD$ - BIRTH DATE A2$ - CITY-STATE
22 : SX$ - SEX ZP$ - ZIP CODE
23 :
25 MX%=150: F1$="PTR.EMP" ' ..INDEX FILE NAME
30 IIX=1: GOSUB 2000 ' ..INITIALIZE DATA STRUCTURE
31 :
32 INPUT "OPERATION (D,A,L,S,LA,U,Q)":Q$
33 IF Q$="D" THEN GOSUB 150: GOTO 32 ' DELETE
34 IF Q$="L" THEN GOSUB 180: GOTO 32 ' LIST INDIVIDUAL DATA
35 IF Q$="A" THEN GOSUB 100: GOTO 32 ' ADD
36 IF Q$="S" THEN IIX=8: GOSUB 2000: GOTO 32 ' DISPLAY STATISTICS
37 IF Q$="LA" THEN GOSUB 200: GOTO 32 ' LIST ALL RECORDS
38 IF Q$="U" THEN GOSUB 250: GOTO 32 ' UPDATE RECORD
40 IF Q$<>"Q" THEN 32
50 CLOSE: END
97 :
98 : ***** ADD RECORD
99 :
100 INPUT "SS#":A$: IF A$="END" THEN 120 ELSE IF LEN(A$)<>9 THEN 100
101 IIX=5:GOSUB 2000: IF RCX<>0 THEN LSET KY$=A$: GOTO 102 ELSE PRINT "*** ERROR
 - KEY ALREADY EXISTS": GOTO 100
102 INPUT "NAME":F$: LSET NM$=F$
105 INPUT "BIRTH DATE":F$: LSET BD$=F$
107 INPUT "SEX":F$: LSET SX$=F$
109 INPUT "JOB CODE":F$: LSET JC$=F$
110 INPUT "STREET":F$: LSET A1$=F$
111 INPUT "CITY-STATE":F$: LSET A2$=F$
112 INPUT "ZIP CODE":F$: LSET ZP$=F$
115 IIX=2: GOSUB 2000 ' .. ADD RECORD
118 IF RCX=0 THEN 100 ELSE PRINT "*** ERROR - RECORD CANNOT BE STORED": GOTO 100
120 IIX=7: GOSUB 2000 ' .. STORE POINTERS
122 RETURN
147 :
148 : ***** DELETE RECORD
149 :
150 STX=0
151 INPUT "CODE TO DELETE":A$: IF A$="END" THEN 156
152 IIX=4: GOSUB 2000
154 IF RCX=0 THEN STX=1 ELSE PRINT "*** ERROR - KEY DOES NOT EXIST"
155 GOTO 151
158 IF STX=1 THEN IIX=7: GOSUB 2000 ' RESTORE POINTERS IF RECORD DELETED
158 RETURN
177 :
178 : ***** LIST INDIVIDUAL RECORD
179 :
180 INPUT "SOCIAL SECURITY NUMBER":A$: IF A$="END" THEN 190
182 IIX=5: GOSUB 2000: IF RCX<>0 THEN PRINT "***ERROR - KEY DOES NOT EXIST": GOTO
 180
183 PRINT " "
184 PRINT " NAME: ";NM$
185 PRINT " JOB CODE: ";JC$
186 PRINT " BIRTH DATE: ";LEFT$(BD$,2);"/";MID$(BD$,3,2);"/";RIGHT$(BD$,2)
187 PRINT " ADDRESS: ";A1$
188 PRINT TAB(13);A2$:PRINT ""
189 GOTO 180
190 RETURN
197 :
198 : ***** LIST RANGE OF RECORDS
199 :
200 NX%=0: IIX=6: KX=0
202 NX%=NX%+1: GOSUB 2000
204 IF RCX<>0 THEN 210
205 PRINT KY$,NM$
206 KX=KX+1: IF KX<10 THEN 202 ELSE INPUT ">":Q$ ' .. PAUSE
207 IF Q$<>"END" THEN KX=0: GOTO 202
210 RETURN
247 :
248 : ***** UPDATE RECORD
249 :
250 INPUT "SS#":A$: IF A$="END" THEN 270
252 IIX=5:GOSUB 2000 ' .. FETCH RECORD TO BE UPDATED
254 IF RCX=1 THEN PRINT "*** ERROR - RECORD DOES NOT EXIST":GOTO 250
255 PRINT "NAME: /";NM$:"/";: INPUT F$: IF LEN(F$)<>0 THEN LSET NM$=F$

```

(continued)

# \$2000? That's Too Darned High!

Why should a CAD package cost more than a Word Processor? It shouldn't! Lots of people ask how we can offer a CAD system as good as ProDesign II at a price as low as \$299. It's easy. A PC Software Package does not cost \$2000 to manufacture. It doesn't even cost \$200. It makes us ask the questions, "Why do comparable CAD packages cost \$2000 and more?" "What makes a CAD package cost more than a Word Processor?"

ProDesign II doesn't. ProDesign II is the complete CAD package you get for \$299. With ProDesign II, you get such advanced features as Auto Dimensioning, Area Fill, Fillets, Mirroring, Isometrics, Curve Fitting, Object Snap, Attributes, Drawing Merge, and many, many more. Features once available only for \$2000 or more. Features you get at no extra charge with ProDesign II.

But there is another, very important reason you should get ProDesign II. ProDesign II is very unique among CAD packages. It is easy to learn and use. When we call ProDesign II "The Easy To Use CAD System", we're not joking. You will be productive with ProDesign II in an hour or two instead of a week or two.

What else does ProDesign II offer? Compatibility. Compatibility with over 100 printers. Compatibility with

over 50 plotters. Compatibility with most graphics adapters, digitizing tablets, and mice. Compatibility with most display adapters. Compatibility with any software that can produce HP plotter commands. Compatibility with mainframe CAD systems (IGES). All at no extra charge! (You can also get an AutoCAD Interchange Utility for \$99 that converts drawings to or from the AutoCAD format.)

What additional hardware do you need? None! An IBM PC compatible and 512K RAM are all you need. ProDesign II produces high resolution drawings on your dot matrix printer - better than .005" resolution on an IBM/Epson compatible printer. And you don't have to get a mouse or digitizing tablet. ProDesign II is designed for easy and efficient keyboard use. You won't even need a math coprocessor, although it is supported. From a small drawing on a dot matrix printer to an E-Size drawing on a large plotter, ProDesign II is the one to use!

## ProDesign II — Affordable, Compatible, and Usable!

Where do you get it? See your local dealer or contact:  
**American Small Business Computers, Inc.**  
 118 South Mill Street  
 Pryor, OK 74361  
 918/825-4844

# PRODESIGN II — ONLY \$299!

## F-18 HORNET DRAWN USING PRODESIGN II

1. BRIDGE
2. BARR ROTARY CAMERA
3. ANNUNCIATOR PANELING
4. WINDSCREEN
5. INSTRUMENT PANEL
6. HEAD-UP DISPLAY
7. CANOPY
8. EJECTION SEAT
9. MEDICAL EQUIPMENT
10. SECOND SEAT SPACE
11. LEADING EDGE ROOT EXTENSION
12. FUELAGE TANKS
13. LEADING EDGE FLAP
14. WING FAIRING
15. SIDEWINDER AIR-AIR MISSILE
16. MISSILE LAUNCH RAIL
17. NAVIGATION LIGHT
18. WING FOLG HINGE JOINT
19. RILLERON
20. FLAP VANE
21. FLAP
22. HYDRAULIC RESERVOIR
23. STORE LIGHT
24. RUDDER HYDRAULIC ACTUATOR
25. NAVIGATION LIGHT
26. BRDM WARNING ANTENNA
27. FUEL JETTISON
28. MOVING TAILPLANE
29. ICR ANTENNA
30. BRDM WARNING ANTENNA
31. FORWARD LIGHTING STRIP
32. AFTERBURNER NOZZLE
33. MOVING TAILPLANE
34. TRAILPLANE HYDRAULIC ACTUATOR
35. TURBOFAN ENGINE
36. RILLERON HYDRAULIC ACTUATOR
37. WING FOLD ACTUATOR
38. SIDEWINDER AIR-AIR MISSILE
39. LEADING FLAP ACTUATOR
40. WING FAIRING
41. LEADING FLAP DRIVE SHAFT
42. EQUIPMENT BAY
43. AUXILIARY POWER TURBINE
44. REAR LANDING GEAR
45. SPARROW AIR-AIR MISSILE
46. LEADING FLAP DRIVE MOTOR
47. MAIN BRANCH ACTUATOR
48. FORWARD BRANCH ACTUATOR
49. LIQUID OXIDIZER CONVERTER
50. BOARDING LADDER
51. FORWARD LANDING GEAR
52. CATALAN LAUNCH STRAP
53. CONTROL COLUMN
54. RUDDER PEDALS
55. ANNUNCIATION FEED CHUTE
56. WING TIP ATTACH SENSOR
57. PITOT HEAD
58. FORWARD LIGHTING STRIP
59. EQUIPMENT BAY
60. FORWARD ICR ANTENNA
61. BRDM FUEL JETTISON
62. BRDM STORE

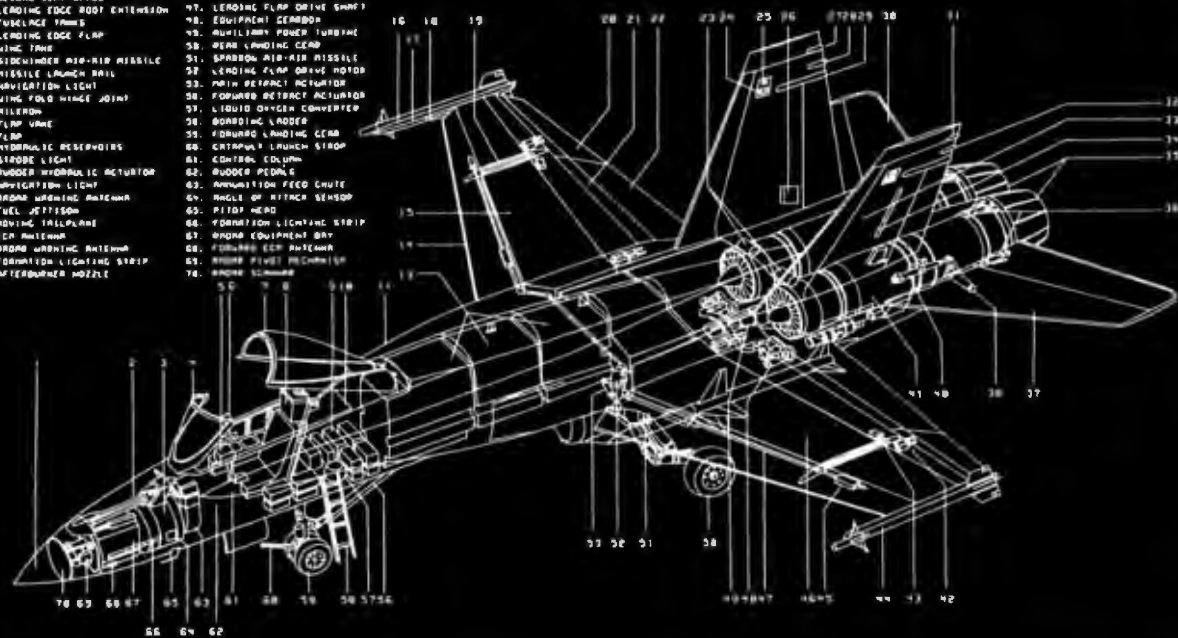

Think it over...

...and the decision becomes clear!

# A Vertical Market Leader for 9 Years

## Construction/Estimating

- Payroll
- General Ledger
- Estimating
- Job Cost

## Medical/Dental

- Appointments
- Patient Billing
- Claim Preparation
- Patient Data Base
- General Ledger
- Payables and Payroll

## Educational Administration

- Scheduling
- Grading
- Attendance
- Computer Literacy
- Vocational Training

24-Hour Technical Support

## Why Think Further?



MS-DOS



MICRO COMPUTER DIVISION

55888 Yucca Trail

P.O. Box 2080

Yucca Valley, CA 92286-2080

(619) 365-9718

```

257 PRINT "BIRTH DATE: /";BD$;"/";: INPUT F$: IF LEN(F$) <> 0 THEN LSET BD$=F$
258 PRINT "SEX: /";SX$;"/";: INPUT F$: IF LEN(F$) <> 0 THEN LSET SX$=F$
260 PRINT "JOB CODE: /";JC$;"/";: INPUT F$: IF LEN(F$) <> 0 THEN LSET JC$=F$
262 PRINT "STREET: /";A1$;"/";: INPUT F$: IF LEN(F$) <> 0 THEN LSET A1$=F$
263 PRINT "CITY-STATE: /";A2$;"/";: INPUT F$: IF LEN(F$) <> 0 THEN LSET A2$=F$
265 PRINT "ZIP CODE: /";ZP$;"/";: INPUT F$: IF LEN(F$) <> 0 THEN LSET ZP$=F$
266 IIX=3: GOSUB 2000 ' .. RESTORE UPDATED RECORD
268 PRINT " ": GOTO 250
270 RETURN
1985 '
1986 '
1987 ' -- FILE MANAGEMENT SUBROUTINES (IIX,NXX,F1$,A$,PTX,PT$, NXX,RCX) --
1988 '
1989 '
2000 RCX=0: IF IIX<1 OR IIX>8 THEN RCX=1: RETURN
2001 IF IIX=1 THEN 2008: ' ELSE STORE VARIABLES USED BY SUBROUTINES
2004 ZX(1)=JX: ZX(2)=JX: ZX(3)=KX:ZX(4)=LOX: ZX(5)=HIX: ZX(6)=ZX
2005 '
2006 ON IIX GOSUB 2035,2000,2090,2100,2150,2200,2250,2280
2007 '
2008 IF IIX=1 THEN 2010: ' ELSE RESTORE VARIABLES USED BY SUBROUTINES
2009 JX=ZX(1): JX=ZX(2): KX=ZX(3): LOX=ZX(4): HIX=ZX(5): ZX=ZX(6)
2010 RETURN
2034 REM --- (1) SUBROUTINE (NXX,F1$) --- INPUT POINTERS AND KEYS
2035 IF NXX<1 THEN RCX=1: RETURN
2037 MRX=(INT((NXX+2)/64)+1)*64
2038 DIM PT$(64),PTX(MRX),KE$(MRX),ZX(8)
2040 OPEN "R",#1,UA$+" "+F1$,128 ' INDEX FILE
2042 FOR JX=1 TO 64: FIELD #1,(JX-1)*2 AS DU$, 2 AS PT$(JX): NEXT JX
2050 KX=0: IF LOF(1)=0 THEN 2062
2051 FOR JX=1 TO INT(MRX/64)
2052 GET 1,JX ' .. INPUT RECORD CONTAINING 64 POINTERS
2054 FOR JX=1 TO 64: KX=KX+1: PTX(KX)=CVI(PT$(JX)): NEXT JX
2055 NEXT JX
2056 '
2057 IF PTX(MRX)=0 THEN 2062
2058 FOR JX=1 TO PTX(MRX)+PTX(MRX-1)
2059 GET 2, JX: KE$(JX)=KY$
2060 NEXT JX
2062 RETURN
2079 REM --- (2) SUBROUTINE (MRX,A$, RCX) --- ADD RECORD TO FILE
2080 GOSUB 2500: IF KX>0 THEN RCX=1: GOTO 2088
2083 GOSUB 2520: IF ZX=MRX-1 THEN RCX=2: GOTO 2088
2085 KX=KX+1: GOSUB 2540 ' .. INSERT POINTER . PTX(KX)=ZX
2086 KE$(ZX)=A$
2087 PUT 2,ZX ' .. STORE NEW RECORD
2088 RETURN
2089 REM --- (3) SUBROUTINE --- REWRITE RECORD
2090 GOSUB 2500: IF KX<0 THEN RCX=1: GOTO 2098
2092 PUT 2,PTX(KX) ' .. STORE RECORD
2098 RETURN
2099 REM --- (4) SUBROUTINE (MRX,A$,RCX) --- DELETE A RECORD
2100 GOSUB 2500: IF KX<0 THEN RCX=1: GOTO 2110
2102 ZX=PTX(KX): IF KX=PTX(MRX) THEN 2107
2104 FOR JX=KX TO PTX(MRX)-1: PTX(JX)=PTX(JX+1): NEXT JX
2107 JX=PTX(MRX)-1
2108 PTX(PTX(MRX))=0: PTX(MRX)=PTX(MRX)-1: PTX(MRX-1)=JX+1:PTX(MRX-2-JX)=ZX
2110 RETURN
2149 REM --- (5) SUBROUTINE (MRX,A$,NXX,RCX) --- READ RECORD BY KEY
2150 GOSUB 2500: IF KX<0 THEN RCX=1: GOTO 2155
2152 GET 2,PTX(KX) ' .. INPUT RECORD
2153 NXX=KX
2155 RETURN
2199 REM --- (6) SUBROUTINE (MRX,NXX,RCX) --- READ RECORD BY SEQUENCE
2200 IF NXX<0 OR NXX>PTX(MRX) THEN RCX=1: GOTO 2205
2203 GET 2, PTX(NXX)
2205 RETURN
2249 REM --- (7) SUBROUTINE (MRX) --- RESTORE POINTERS
2250 KX=0: ZX=INT((PTX(MRX)-1)/64)+1
2252 FOR JX=1 TO ZX
2253 FOR JX=1 TO 64: KX=KX+1:LSET PT$(JX)=MKI$(PTX(KX)): NEXT JX: PUT 1,JX
2254 NEXT JX
2255 KX=INT(MRX/64): IF ZX=KX THEN 2259
2257 KX=(KX-1)*64: FOR JX=1 TO 64: LSET PT$(JX)=MKI$(PTX(JX+KX)):NEXT JX:PUT 1,
INT(MRX/64)
2259 RETURN
2279 REM --- (8) SUBROUTINE --- DISPLAY FILE STATISTICS
2280 PRINT " ":IF PTX(MRX)=0 THEN PRINT "** NO RECORDS IN FILE": GOTO 2290
2282 PRINT " ** FILE STATISTICS **: PRINT " "
2283 PRINT " 1. RECORDS IN FILE: ";PTX(MRX)
2284 PRINT " 2. DELETED RECORDS: ";PTX(MRX-1)
2285 PRINT " 3. LOWEST KEY: ";KE$(PTX(1))
2286 PRINT " 4. HIGHEST KEY: ";KE$(PTX(PTX(MRX)))
2287 PRINT " "
2290 RETURN
2498 '
2499 REM --- SUBROUTINE (MRX,A$, KX) --- BINARY SEARCH
2500 IF PTX(MRX)=0 THEN KX=-1: RETURN
2502 LOX=0: HIX=PTX(MRX)+1
2504 MX=INT((LOX+HIX)/2)
2505 IF A$=KE$(PTX(MX)) THEN KX=MX: GOTO 2510

```

(continued)



KEYED FILE ACCESS

```

2506 IF A$>KE$(PT%(MX)) THEN LOX=MX: ELSE HIX=MX
2508 IF LOX+1 <> HIX THEN 2504 ELSE KX=-HIX
2510 RETURN
2518 '
2519 REM -- SUBROUTINE (MR%,PT%,Z%) -- LOCATE FREE RECORD IN DATA FILE
2520 IF PT%(MR%-1)=0 THEN Z%=PT%(MR%)+1: GOTO 2530
2522 J%=PT%(MR%):JJ%=PT%(MR%-1)
2524 Z%=PT%(MR%-1-JJ%): PT%(MR%-1)=PT%(MR%-1)-1: PT%(MR%-1-JJ%)=0
2530 RETURN
2538 '
2539 REM -- SUBROUTINE (MR%,K%,Z%) -- INSERT POINTER INTO POINTER VECTOR
2540 IF K%=PT%(MR%)+1 THEN 2548
2542 FOR J%=PT%(MR%)+1 TO K%+1 STEP -1
2544 PT%(J%)=PT%(J%-1)
2545 NEXT J%
2548 PT%(K%)=Z%: PT%(MR%)=PT%(MR%)+1
2550 RETURN
2997 '
2998 ' ----- PROGRAM TO INITIALIZE INDEX FILE -----
2999 '
3000 PRINT " ":PRINT TAB(5);"== INITIALIZE INDEX FILE ==" :PRINT " "
3001 INPUT "> DRIVE TO CONTAIN DATA":UA$
3002 INPUT "> FILE NAME":F$
3004 INPUT "> MAXIMUM NUMBER OF RECORDS FILE WILL HOLD":MX%
3006 MR%=(INT((MX%+2)/64)+1)*64
3008 DIM PT$(64)
3009 ' ----- OPEN FILE AND SET POINTERS TO 0
3010 OPEN "R",#1,UA$+" "+F$,128
3012 FOR J%=1 TO 64: FIELD #1,(J%-1)*2 AS DU$,2 AS PT$(J%):NEXT J%
3014 ZR$=MKI$(0): FOR J%=1 TO 64: LSET PT$(J%)=ZR$: NEXT J%
3015 ' ----- STORE BLOCKS OF ZERO POINTERS
3016 FOR J%=1 TO MR%/64
3018 PUT 1,J%
3020 NEXT J%
3022 PRINT " ": PRINT " INITIALIZATION COMPLETE ON DRIVE":UA$
3025 END

```

deleted: A pointer is set up indicating that the space can now be used for storing a new record.

Parameters: I%=4, A\$=key of record to delete.

5. Read Record by Key allows the record with the specified key to be read from the data file. This routine also returns the relative key sequence of the record in the variable NX%. This means, for example, that if the key value is the lowest in the file, NX% is set to 1.

Parameters: I%=5, A\$=key of record to read, NX%=key sequence.  
 6. Read Relative Record reads the nth record—based on key sequence—in the file. For instance, if you want to read the record with the lowest key, set NX% to 1 and call this routine. Conversely, to read the record with the highest key value, set NX% to the number of records in the file before calling.

Parameters: I%=6, NX%=relative position of record to be read.

7. Store Index writes the values of the vector PT% back into the index file and must be called after records have been added or deleted. If these operations occur and the program ends without calling this routine, all your changes will be lost.

Parameters: I%=7.

8. Display File Statistics prints the following file information on the screen:

1. RECORDS IN FILE:
2. DELETED RECORDS:
3. LOWEST KEY:
4. HIGHEST KEY:

Parameters: I%=8.

**A SAMPLE PROGRAM**

To illustrate the use of these SKAM routines, let's consider a simple program for maintaining employee records (see listing 1). It uses a social security number as the key field for each record. [Editor's note: Listing 1, which runs on IBM PC-compatible machines using BASIC, is available in a variety of formats: see the insert card following page 368.]

The listing consists of three sections: (1) lines 1-270 are the sample program; (2) the SKAM routines are in lines 2000-2550; and (3) a short program to build and initialize the index file begins at line 3000. Referring to tables 2 and 3, let's look at the most important features of the code.

Any program using the SKAM routines must take care of some overhead:

(continued)

MetaComCo™  
**Languages**

Atari ST™ • Amiga™ • QL™

**LATTICE® C**

The well known LATTICE® C compiler, full featured portable implementation.

**MCC™ PASCAL**

An ISO/ANSI standard Pascal. A fast single pass compiler, ideal for commercial, educational and personal use.

**MCC™ ASSEMBLER**

A professional standard macro assembler with many powerful features.

**CAMBRIDGE LISP**

LISP interpreter/compiler providing a complete LISP development environment.

**BCPL**

A powerful compiler offering the convenience of a high level language with the flexibility of an assembler.

**APL**

Keyword and symbolic versions of this important language from MicroAPL.

**MCC™ BASIC**

68000 BASIC interpreters and compilers from MetaComCo.

**MENU +™**

An easy to use program environment with pull-down menus. Menu+ comes free with Atari software. Upgrades ready for registered users.

**TOOLKIT**

Provides useful tools and utilities. From the people who wrote AmigaDOS.

| Product   | Atari™<br>ST | Commodore™<br>Amiga | Sinclair™<br>QL |
|-----------|--------------|---------------------|-----------------|
| Lattice C | \$149.95     | \$149.95            | \$129.95        |
| Pascal    | \$99.95      | \$99.95             | \$99.95         |
| Assembler | \$79.95      | *                   | \$49.95         |
| Lisp      | \$199.95     | \$199.95            | \$79.95         |
| BCPL      | TBA          | TBA                 | \$79.95         |
| APL Key.  | \$149.95     | TBA                 | \$129.95        |
| APL Sym.  | \$245.00     | TBA                 | \$129.95        |
| MENU+     | \$29.95      | TBA                 | —               |
| TOOLKIT   | TBA          | \$49.95             | —               |

\* = available from Commodore

† = available from Atari

Cambridge LISP is available for CP/M-68K™

QL Lisp includes interpreter only



**The Quality Source for 68000 Software**  
 5353 #E Scotts Valley Dr., Scotts Valley, CA 95066

Contact your local dealer or call:

Tel: US 800-AKA-META

Cal 800-GET-META, Eur (UK) 44-272-426781

Telex (UK) 444874 METACO G

Add 6.5% tax if CA resident.

Lattice is a registered trademark of Lattice Inc.  
 Amiga and AmigaDOS is a trademark of Commodore-Amiga Inc.  
 Atari ST is a registered trademark of Atari Inc.  
 CP/M-68K is a trademark of Digital Research Inc.

Table 2: Description of the employee record-keeping program by BASIC code numbers.

| Lines   | Description                                                                                                                                                                                                             |
|---------|-------------------------------------------------------------------------------------------------------------------------------------------------------------------------------------------------------------------------|
| 16, 17  | The data file is opened and its format defined. This file must be opened as logical file 2, and the variable used for the key (social security number in this case) must be KY\$.                                       |
| 25      | MX% is set to the maximum number of records to be contained in the data file, and F1\$ is assigned the name of the index file. This information must be the same as that used in the index-file-initialization program. |
| 30      | A call is made to the file management routines to set up the data structure. The subroutines will allocate the vectors PT% and KE\$ and read pointers and keys into them.                                               |
| 100-270 | The subroutines in the sample program that direct the file maintenance operations on the employee file. By calling the appropriate SKAM routines, they provide an example of how to add, delete, and list records.      |

Table 3: Description of the SKAM subroutines and index-file-initialization program by BASIC code numbers.

| Lines     | Description                                                                                                                                                                                                                                                                                                                                            |
|-----------|--------------------------------------------------------------------------------------------------------------------------------------------------------------------------------------------------------------------------------------------------------------------------------------------------------------------------------------------------------|
| 2000-2010 | The control section of the file management routines that stores locally used variables and calls the desired routine.                                                                                                                                                                                                                                  |
| 2035-2062 | Subroutine to input pointers from the index file and store them in vector PT% and to read keys from the data file and store them in KE\$.                                                                                                                                                                                                              |
| 2080-2088 | Subroutine to add a new record to the data file. It calls routines to insert the new pointer and locate a free space in the data file. The new record is stored in this location.                                                                                                                                                                      |
| 2090-2098 | Subroutine to rewrite a record to the data file.                                                                                                                                                                                                                                                                                                       |
| 2100-2110 | Subroutine to delete a record. The pointer to the record to be deleted is located and moved to the section in PT% containing pointers to deleted space.                                                                                                                                                                                                |
| 2150-2155 | Subroutine to retrieve a record with key value in A\$.                                                                                                                                                                                                                                                                                                 |
| 2200-2205 | Subroutine to retrieve a record based on its position in ascending key sequence. NX% contains the relative position.                                                                                                                                                                                                                                   |
| 2250-2259 | Subroutine to write pointers in PT% back to the index file.                                                                                                                                                                                                                                                                                            |
| 2280-2290 | Subroutine to display certain file statistics.                                                                                                                                                                                                                                                                                                         |
| 2500-2510 | Binary search routine. Using the pointers in PT%, the vector KE\$ is searched to find a key matching A\$. If a match is found, K% is set to the location in PT% pointing to the matched key; if no match, K% is set to the negative value of the location in PT% where it would be inserted.                                                           |
| 2520-2530 | Subroutine to locate the next free physical record in the data file. If any records have been deleted, it uses the space from the last one deleted; if there are no deleted records, the next position at the end of the file is used.                                                                                                                 |
| 2540-2550 | Inserts a pointer to a new record in PT%. The pointer is placed at PT%(K%), and all pointers above it are shifted up one position.                                                                                                                                                                                                                     |
| 3000-3025 | The program to create and initialize the index file. The size of the file is determined by the number of records the data file is to contain. For each 64 data records, one block of pointers is allocated in the index file. Additionally, there must be space at the end of this file for keeping count of the number of deleted and active records. |

- The data file must be opened as logical file 2 (line 16).
- Variable KY\$ must be defined as the key (line 17).
- Variables MX% and F1\$ must be set to the maximum number of records in the file and the index filename, respectively.
- The SKAM routines must be called with I1% set to 1 in order to initialize the data structure (line 30).

Four variables, KE\$, PT%, PT\$, and ZZ%, must be reserved for use by the file management routines. To minimize the number of reserved variables, the routines store all other locally used variables in vector ZZ% when the code is entered (line 2004) and restore them upon exit (line 2009).

The file management section stresses a modular, easily understood design. The sample program invokes this section by setting I1% to the number of the desired operation and executing GOSUB 2000. In line 2006 the controlling section passes control to the required subroutine. A return code in variable RC% indicates the status of the operation.

Prior to using the SKAM routines, you must run the short initialization program shown at line 3000. This program asks for the filename and number of records to be contained in the data file. It then creates the index file and initializes the pointers. Note that if you give the name of an existing index file, the program will write over the old index.

## CONCLUSION

For programs requiring single-keyed access to a file, I have found these routines to be an effective, timesaving approach to file I/O. I maintain the code in a software library and append it to programs needing keyed access, such as payroll, general ledger, and membership programs. At less than 100 lines of code, I think the routines offer one of the easier ways to begin accessing records by key values.

[Editor's note: The keyed-access filing routines presented here are in BASIC. For a similar treatment of this method implemented in Pascal, see Bruce Webster's "A Simple File-Indexing Scheme" in the June BYTE.] ■

# NOBODY DELIVERS LIKE LOGICSOFT.



**FREE OVERNIGHT  
DELIVERY**

**LOWEST PRICE  
GUARANTEE**

**TOLL-FREE  
CUSTOMER SERVICE**

## **Buy it today, use it tomorrow!**

Only Logicsoft ships your order the same day via overnight courier.\* Free.

## **Nobody beats Logicsoft prices.**

In fact, if you find a lower price (advertised or a bonafide quote) on any of the hundreds of products we stock, we'll beat it by \$10.† Our Corporate Accounts Program offers attractive volume discounts. Credit cards and PO's accepted.

## **Outstanding customer service and technical support.**

It's only a toll-free phone call away. Another reason why Logicsoft is a major hardware and software supplier to over 50,000 companies, including over 90% of the Fortune 1000.

## **See inside for the lowest prices on over 800 products for IBM-PC's and compatibles.**

\*Applies to order totaling over \$100. If under \$100, shipped UPS—FREE (Within Cont., U.S.). Due to weight restrictions, printers and monitors are also shipped UPS—FREE. †This offer does not apply to items under \$100, American Express or Terms orders. In these instances, we will meet any lower price. We reserve the right to request a current written price quote.

# LOGICSOFT®

To order or receive technical assistance, call our National Hotline:

## **1-800-645-3491**

NY STATE: 1-800-235-6442 (516) 249-8440

Customer Service: 1-800-431-9037 NYS: 516-249-8440

FAX #516-249-5289



No surcharge for MasterCard, VISA, American Express, C.O.D., money order, check or PO's (please call for price verification) • No sales tax on orders shipped outside N.Y. State • Please add 2% for insurance and handling (\$3.00 minimum) (all orders add'l) • We do not bill until we ship. All products covered by mfg's warranty. Defective merchandise may be returned for repair or exchange only. We do not guarantee compatibility. Any goods returned for credit are subject to at 15% restocking charge. All prices and policies subject to change without notice.

## Lease or Purchase Systems From Logicsoft

A Logiclease of any system entitles you to FREE installation and 90-day service contract at your place of business! High tech without high cost.

Outstanding flexibility.

Plus possible tax benefits.

Give Logicsoft a call – we'll process your lease application in 24 hours!

**ONLY LOGICSOFT  
OFFERS ON-SITE  
INSTALLATION & SERVICE  
ON ALL LEASED AND  
PURCHASED SYSTEMS**

A purchase of any system entitles you to installation for only \$99, and FREE service for 90 days at your place of business!

## National Computer Maintenance

Now...trained installers and expert service technicians dispatched from each of our 96 authorized service centers in most metropolitan areas throughout the United States, ready to respond within an average of 4 hours.

# LOGICSOFT

To order or receive technical assistance, call our National Hotline:

**1-800-645-3491**

Customer Service: 1-800-431-9037

NY STATE: 1-800-235-6442 (516) 249-8440

FAX # 516-249-5289

110 Bi-County Blvd., Dept. 543

Farmingdale, NY 11735

CANADA: 416-283-2354

Domestic/Int'l Telex

286905 SoftUR

EUROPE: 020-83 48 64

Telex: 10759 Logic NL

Mail orders to:

LOGICSOFT EUROPE BV

pb 9460, 1006 AL Amsterdam, Holland

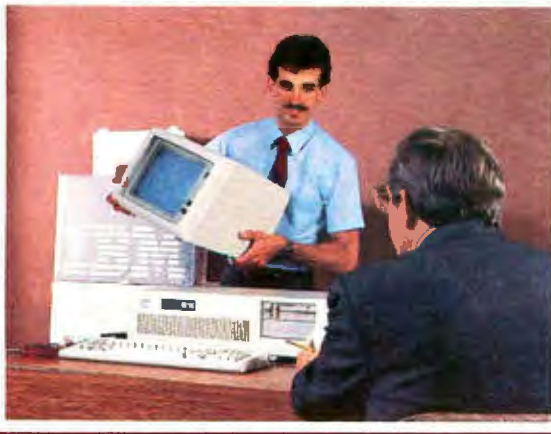

# REAL TIME UNDER REAL PASCAL

## *Two ways to interface a machine language routine to Pascal*

**S**ome critics of Pascal have complained about its inability to communicate with machine language or assembly language routines. If you need to do real-time or real-world programming in a Pascal environment, then access to the real machine is essential. Many Pascals have extensions that do allow such un-Pascal-like goings-on. For example, Apple, Microsoft, and DEC Pascals all provide tools that let you get at the guts of your machine. With such tools, it is not all that difficult to gain access to the real machine if you understand how variables and data are transferred from one procedure to another within a Pascal environment.

Let's say that you want to do some signal processing on data coming in from the outside to an Apple II. For example, you might want to analyze an audio signal to see what its power spectrum is. The data is available through a machine-specific device—an analog-to-digital converter (ADC) board. To find out what the power spectrum is, you have to gather the data and analyze and display the results. One numerical tool for analyzing and displaying these results is a fast Fourier transform, which is an efficient algorithm for finding the

Fourier series that best characterizes a finite sample of a waveform. If you were writing the FFT program, you would most certainly want to do it in a high-level language. For this particular application, you might also have some filtering to do, so you would have to perform still other procedures for signal conditioning. You might want to see the results of such analysis as a graph, so you would use graphing routines. Note that you can perform all these functions using Pascal procedures. In other words, the signal is to come from the outside world, but everything else is to be done in the computationally comfortable higher-level language.

To feed the FFT routine, you want a set of 256 equally spaced samples of a real signal. You probably want to be able to control both the spacing and the source of the signal, and you want that frame of points available for direct processing in Pascal. If it is given that V1 is the name of the array to contain the 256 samples, CHANNEL is an integer that indicates where you would like your signal to come from, DELAY is another integer that specifies how long it is between samples, and FRAME is the name of your assembly language routine, then

there are two ways you might proceed in constructing the interface between Pascal and assembly language. One way is to define the procedure FRAME with parameters CHANNEL and DELAY transferred by value and V1 transferred by address. You would call the assembly language routine as follows:

```
FRAME (CHANNEL, DELAY, V1);
```

(For an explanation of the terms "transfer by value" and "transfer by address," see the text box "The Communication Problem" on page 146.) The other way is to make all variables global so that both Pascal and assembly language can access them directly by name. The call to the assembly language routine would simply be FRAME without any parameters.

Figure 1 shows the relationship between the several segments of the

*(continued)*

*James Feldman teaches computer architecture and semiconductor theory at Northeastern University; he can be reached at the Department of Electrical and Computer Engineering, Northeastern University, Boston, MA 02115. He has a B.S., M.S., and Ph.D. from Carnegie-Mellon University. His interests are computer architecture and semiconductor devices.*

## THE COMMUNICATION PROBLEM

There are two ways for a Pascal procedure to communicate with other routines: through a "transfer by address" or a "transfer by value." The difference between these calls is similar to the difference between giving someone an original document and giving him or her a photocopy. For

example, in the procedure definition  
**PROCEDURE EXAMPLE(X,Y:**  
**INTEGER; VAR U,V:INTEGER)**  
 the values of X and Y are transferred by value to the procedure and, therefore, any change that EXAMPLE makes in them is not returned to the calling

routine. However, having the keyword VAR precede the variables U and V causes the address of the variables to be transferred; it does not cause the variables to be copied. Any change that the procedure EXAMPLE makes in U and V will change corresponding variables in the calling routine.

Listing A: This program demonstrates the difference between transfer by data and transfer by address.

```
PROGRAM TRANSFER;
TYPE Q = ARRAY [0..19] OF INTEGER;

VAR N : INTEGER;
 J,K : Q;

PROCEDURE CHANGE(P:Q; VAR L:Q);

VAR N : INTEGER;

BEGIN
FOR N := 1 TO 10 DO P[N] := 2;
FOR N := 1 TO 10 DO L[N] := 2;
WRITE('P ');
FOR N := 0 TO 19 DO WRITE(P[N]:3);
Writeln;
WRITE('L ');
FOR N := 0 TO 19 DO WRITE(L[N]:3);
Writeln; WRITE('J ');
FOR N := 0 TO 19 DO WRITE(J[N]:3);
Writeln;
```

```
WRITE('K ');
FOR N := 0 TO 19 DO WRITE(K[N]:3);
Writeln;
END;

BEGIN { MAIN }
FOR N := 0 TO 19 DO J[N] := 0;
FOR N := 0 TO 19 DO K[N] := 3;
WRITE('J ');
FOR N := 0 TO 19 DO WRITE(J[N]:3);
Writeln;
WRITE('K ');
FOR N := 0 TO 19 DO WRITE(K[N]:3);
Writeln; Writeln;
CHANGE(J,K);
Writeln; Writeln;
WRITE('J ');
FOR N := 0 TO 19 DO WRITE(J[N]:3);
Writeln;
WRITE('K ');
FOR N := 0 TO 19 DO WRITE(K[N]:3);
END.
```

program. The Pascal user is unaware of the stack, and so is the programmer who shares global variables between the assembly language routine and Pascal. However, in the procedure

that passes variables through the call, a copy of CHANNEL and DELAY and the address of the first byte in the array (V1) are pushed onto the stack just prior to the transfer of control to

FRAME. FRAME begins by pulling these three integers off the stack.

I will first describe in detail the solution to the problem that passes parameters to the assembly language procedure on the stack. Then I will look at a side-by-side comparison of this method and the one that uses global variables.

[Editor's note: The programs of listings 1, 2, and 3 are not meant to be run as such, since they require some specific hardware, but they are good illustrations of the techniques involved in interfacing machine language with Pascal. You can apply these techniques to your own problems.]

### THE UN-PASCAL PROCEDURE

The assembly language program written in Apple II TLA (The Last Assem-

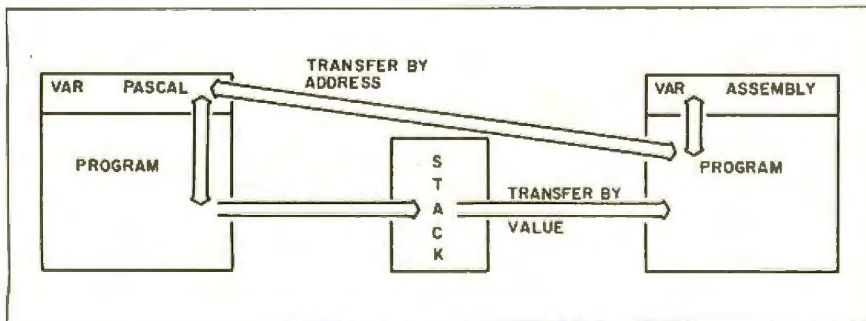

Figure 1: The data-transfer routes. Direct use of global variables is shown, as well as a transfer of data through the procedure call that employs the stack as the transfer agent.

This becomes a critical distinction when you are using structured data such as arrays or records. If data is transferred by value, the whole structure is copied over into a new area of memory. It doesn't take long to run out of memory this way, nor is it a good way to have a fast program. On the other hand, if you transmit the address of the structured data, it takes but one word (2 bytes) to know all about it, even if "it" is a huge, structured variable. All you transmit is the address of the first byte of the array.

Listing A and its accompanying output in figure A give a complete (if silly) demonstration of how the two types of transfer affect the "current" value of a variable. It is done with structured variables to show the details of that operation.

The first pair of rows in figure A are the original values of J and K, respectively. J is all 0s and K is all 3s. Then PROCEDURE CHANGE is called. It gets J as a transfer by value and K as a transfer by address. These become P and L in the procedure. Values 1 to 10 in P and L are changed. These two data vectors are then printed. Both have changed. Next, the global variables J and K are printed from the procedure, showing their

The results of this program appear on the screen as:

|    |   |   |   |   |   |   |   |   |   |   |   |   |   |   |   |   |   |   |   |
|----|---|---|---|---|---|---|---|---|---|---|---|---|---|---|---|---|---|---|---|
| J) | 0 | 0 | 0 | 0 | 0 | 0 | 0 | 0 | 0 | 0 | 0 | 0 | 0 | 0 | 0 | 0 | 0 | 0 | 0 |
| K) | 3 | 3 | 3 | 3 | 3 | 3 | 3 | 3 | 3 | 3 | 3 | 3 | 3 | 3 | 3 | 3 | 3 | 3 | 3 |
| P) | 0 | 2 | 2 | 2 | 2 | 2 | 2 | 2 | 2 | 2 | 0 | 0 | 0 | 0 | 0 | 0 | 0 | 0 | 0 |
| L) | 3 | 2 | 2 | 2 | 2 | 2 | 2 | 2 | 2 | 2 | 3 | 3 | 3 | 3 | 3 | 3 | 3 | 3 | 3 |
| J) | 0 | 0 | 0 | 0 | 0 | 0 | 0 | 0 | 0 | 0 | 0 | 0 | 0 | 0 | 0 | 0 | 0 | 0 | 0 |
| K) | 3 | 2 | 2 | 2 | 2 | 2 | 2 | 2 | 2 | 2 | 3 | 3 | 3 | 3 | 3 | 3 | 3 | 3 | 3 |
| J) | 0 | 0 | 0 | 0 | 0 | 0 | 0 | 0 | 0 | 0 | 0 | 0 | 0 | 0 | 0 | 0 | 0 | 0 | 0 |
| K) | 3 | 2 | 2 | 2 | 2 | 2 | 2 | 2 | 2 | 2 | 3 | 3 | 3 | 3 | 3 | 3 | 3 | 3 | 3 |

Figure A: The output from the program in listing A.

current values. Note that J is still all 0s but K has now changed. In other words, CHANGE was able to act directly on K (and on J's clone, P), but it has no connection with J at all.

The last two lines are simply the final version of J and K written out by the main program. Note that J still retains its original values; K, of course, has been altered.

The observant reader will note that CHANGE did have access to J (and K) through the medium of global variables. After all, it printed them. Global variables also represent a transfer-by-address technique that differs only

slightly in structure from what happened between K and L. With global variables, you have a public blackboard on which any routine can write and from which any routine can read. To use such a public facility, all users—readers and writers alike—must be constrained to using the blackboard in a prescribed manner. That means that every user must call the variables by the same name, that every user must know when another user is changing the data, and that if one user needs to fix the current value, a private copy of the public data must be made before some other user changes it.

bler) is shown in listing 1. It is not meant to be a superb lesson in assembly language programming, but rather an illustration of the transfer of data between Pascal and assembly language. Remember that the call to this program is FRAME (CHANNEL, DELAY, V1).

At the moment of transfer to FRAME, the stack will contain, in order, four 2-byte integers: the return address, the address of the first byte in V1, the value of DELAY, and the value of CHANNEL.

FRAME will first copy the four integers from the stack to local storage. Next it must set up for gathering data by entering the loop once to prime the ADC. Then FRAME will have to put the 256 values of data from the

ADC into the appropriate locations in the Pascal data space and in standard integer format; data comes from the ADC as single bytes (XX) but must go to the P-machine as words (00XX). Finally, FRAME must return control to the calling routine.

The central point in this illustration is the connection to variables in the Pascal data space. Two words of data are transferred directly through the stack as well as two addresses. Each of these words is pulled in turn from the stack and stored at a local address. Then 256 bytes of data are gathered in TMP and transferred as words to the Pascal data space. (The data-collection and transfer functions are separated to make the loop faster.)

If you want to follow the assembly language program in detail, the following comments should be helpful. To span the full 256-word array, the local data pile is divided into two groups of 128 bytes. In the Pascal data space the address for the first 128 words runs from VX to VX+FF (hexadecimal) in steps of 2; for the second group of 128 words, addresses range from VQ=VX+100 (hexadecimal) to VQ+FF (hexadecimal). Note that VQ is generated at the top of the program. Using indexing after acquiring an indirect address (post-indexed indirect), the 6502 processor, with its 1-byte index register, can span a block of 128 words. As illustrated in figure 2, the 256 bytes of data in TMP must

(continued)

Listing 1: The assembly language routine FRAME used to illustrate the passage of parameters through the call statement from Pascal.

```

;-----
.MACRO PULL
;pulls a word off of the stack
;and stores it in location specified
;as in PULL RETURN.

 PLA
 STA %1 ;%1 means first argument of PULL
 PLA
 STA %1+1 ; the high-order byte of the word

.ENDM
;-----

.PROC FRAME,3
;the "3" means three words (6 bytes) of
;parameters (plus return address) will
;be on the stack. LINKER will check
;agreement

;FRAME GRABBER takes 256 8-bit data points and
;stores them in an array of bytes labeled TMP.
;After the data is grabbed, it is transferred
;to V1. The delay between adjacent points is
;given by
; t = 26.64 + 5*DELAY in microseconds.
;DELAY (<256) and CHANNEL (<16) are in the procedure
;call as FRAME(CHANNEL,DELAY,VX).

STOP .EQU 0 ;Each of these sets aside 1 word of
CHANNEL .EQU 2 ;storage on page 0 (54 bytes
DELAY .EQU 4 ;are available).
RETURN .EQU 6
VX .EQU 8
VQ .EQU 0A ;space for (VX+100 hexadecimal)

 PULL RETURN ;MACRO call pulls return address
 ;off the stack and puts it in RETURN.
 PULL VX
 PULL DELAY ;note that the order is the
 ;reverse of the call's parameter list.
 PULL CHANNEL ;at this point the transfer of
 ;parameters through the stack is
 ;complete.

 LDA VX ;set contents of VQ
 STA VQ ;to the address of
 CLC ;VX + 100 hexadecimal
 LDA VX+1
 ADC #1
 STA VQ+1

 LDX #0FF ;start with -1 (or 255) in index to
 ;throw first datum away.
 STX STOP ;put 255 in STOP just for first pass
 ;to allow reading of 257 values.

 LDY CHANNEL
 JMP START

LOOP LDY #0 ;set end point after first passage
 STY STOP ;to get the full 256 point list.
START LDY CHANNEL
 LDA 0C0D0,Y ;assumes slot 5.

```

(continued)

*Global variables provide a public blackboard on which the current status of each variable is always available.*

become 256 words (512 bytes) in the Pascal data space. A byte is taken from TMP and put into the low-order (LO) byte of the appropriate element of the integer array in the Pascal data space. Then 00 (hexadecimal) is put in the corresponding high-order (HO) byte. After that is done for the 256 samples, all that remains is to push the return address back onto the stack and execute a return from sub-routine (RTS).

A macro is used for the repetitive task of pulling 2-byte integers off the stack. Note that locations must be set up to receive that data. I have chosen to put them into page 0 to make the code block as small as possible.

The first step is to cycle the ADC once to get meaningful data into the ADC data register. The data that is received on the first LDA is garbage and should be ignored. It is put into location TMP+FF (hexadecimal), which will be written over when the 256th good point is taken. The second step is to change STOP to let the standard loop slide over 0 as the loop is entered for the first time. This resetting of STOP is done every time around the loop to keep the loop length identical. Note that the first good piece of data (from the second call to the ADC) goes into location TMP+0 and that a total of 256 equally spaced, good data points will be taken, the last going into TMP+FF (hexadecimal).

#### THE GLOBAL ALTERNATIVE

As I mentioned before, you have the option of using global variables. While this method is not generally recom-

(continued)



# This Is One Time IBM's Size Is Not An Advantage.



When it comes to a portable computer, smaller is better. That's one reason the new dual disk drive Toshiba T1100 PLUS has it all over the IBM PC Convertible!

But our portable PC is not only smaller than the IBM, it's lighter. And more powerful. Our 80C86 microprocessor lets you zip through work at up to twice the speed. And our maximum memory capacity is 640K of RAM. Theirs is only 512K.

The T1100 PLUS has other things the IBM doesn't. Like serial, parallel and CRT ports that are built-in standards. Not add-on extras. And a high resolution LCD display screen that tilts to many convenient viewing angles. Not just a few.

Of course, the Toshiba T1100 PLUS does have a few things in common with the IBM portable. Like complete IBM compatibility. And two built-in 720K 3.5" disk drives. It's just that it has these things in a smaller, lighter, faster, more portable, more affordable package.

To find out about the T1100 PLUS, call 1-800-457-7777 for the name of your Toshiba dealer.

And see why being smaller than IBM is going to make us one of the biggest names in PCs.

IBM PC Convertible is a registered trademark of International Business Machines Corporation.



In Touch with Tomorrow

## TOSHIBA

Toshiba America, Inc., Information Systems Division

Inquiry 354

```

 STA TMP,X
 INX
 LDY DELAY
INNER DEY ;delay loop runs 1 or more times.
 ;0 would give 256 cycles.

 BNE INNER
 CPX STOP
 BNE LOOP
 LDY #0 ;Set up to load results into V1.
 LDX #0
 LDA #80 ;80 hexadecimal or 128 decimal
 STA STOP
AGAIN LDA TMP,X ;take a byte from the beginning
 STA (VX),Y ;put it LO at beginning of array
 LDA TMP+80,X ;take a byte from the middle.
 STA (VQ),Y ;put it in LO at middle of array.
 INX ;counting by bytes in TMP
 INY
 LDA #0 ;high order byte is 0
 ;with this 8-bit ADC.

 STA (VX),Y
 STA (VQ),Y
 INY ;counting by Integers (2 bytes).
 CPX STOP
 BNE AGAIN
 LDA RETURN+1 ;Set up for return.
 PHA
 LDA RETURN
 PHA ;return address is back on stack
 ;back to the calling routine.
 RTS

TMP .BLOCK 256,0 ;this is just a block of bytes
 ;for temporary storage of data.

.END

```

employed, the procedure or function is almost independent of its surroundings.

However, there is a hidden dependence that shows up only if the called routine calls yet another routine and then another, and so on. If the subsequent routine has access to the same data, the first routine must know what the second and any subsequent routines do to that variable to know that it hasn't been altered in mid-computation. If you are not the only programmer or if the program is large, it can be exceedingly difficult to know if any other routine is mucking about in the data that you thought was secure.

Global variables do have two redeeming virtues. First, they provide a public blackboard on which the current status of each of the variables is always available without any overhead in computation or memory use. Second, they are easier to deal with at the assembly language level since they can be accessed with direct addressing (by name). If you use the transfer through the stack technique in the calling sequence, these variables must be accessed using indirect addressing. Indirect addressing is not difficult in itself, but it slows the machine down slightly and sometimes puts the burden of complex address computation directly on the programmer.

A side-by-side comparison of the two techniques is given in listing 2. Global data is directly accessible by name from the assembly language program through the .PUBLIC declaration. Note that the right side uses post-indexed indirect addressing (i.e., the full 2-byte address is fetched from page 0 and then indexed), while the left uses indexing of an absolute address provided by the LINKER (i.e., the LINKER installs the appropriate 2-byte address directly into the instruction). The two sets of code look similar and, apart from an extra machine cycle for the indirect instruction, they do the same thing in the same number of instructions. However, note the additional instructions on the right that generate the address of the 128th word of V1 (or, more properly for the column on the right, whatever array was passed in the call).

(continued)

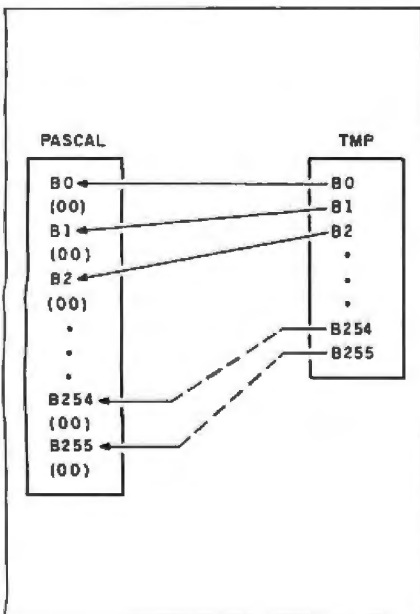

Figure 2: The relationship between bytes in the array TMP and words in Pascal data space.

mended, the global-variable alternative works well enough. The difference between using a global variable and transferring variables through the procedure call is significant, even if the transfer process is by address in both cases. Probably the most important difference is that, with transfers through the call, neither the caller nor the person being called has any idea of what the other uses as the name of the variables. The caller says, "Load your 256 points starting HERE." HERE is an address. It can be a different address each time the person being called is accessed. That makes the two procedures essentially independent of each other. The only thing that must be common is the agreed-upon transfer statement—the interface. For Pascal, the interface is the list of parameters passed in the call and the set of global variables defined for that program segment. If no global variables are



**MAC INKER™**

Re-ink Any Fabric Ribbon  
Automatically for less  
than 5 cents.

Dedicated Units start at **\$54.95**

Universal Cartridge  
MAC INKER **\$68.50**

Universal Spool  
MAC INKER **\$66.95**

shipping \$3.00

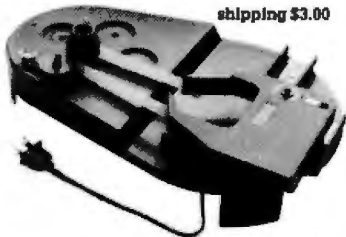

Lubricated, Dot Matrix Ink \$3.00,  
bottle available in black/brown/  
red/green/yellow/purple/  
orange/gold and silver.

Over 50,000 MAC INKER(s) in the field.

Over 7500 printers supported.

**MERCURY MODEM**

Really 100% Hayes\* Compatible.

- 300/1200 baud.
- audio monitor/front panel lights.
- 18 months warranty.

Shipping \$4.00



**\$205.00**

\*Hayes is a trademark of Hayes Microproducts.

**DATA SWITCHES**

All types, all lines switched, all metal,  
heavy duty switch, elegant design, best  
value for money.

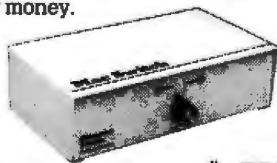

2 Ports Parallel or Serial **\$ 75<sup>00</sup>**

4 Ports Parallel or Serial **\$150<sup>00</sup>**

2 Computers/2 Printers  
Parallel or Serial **\$150<sup>00</sup>**

We have cables too. Please inquire or  
specify at time of order.

Order Toll Free.

Call or write for free brochure.

**1-800-547-3303**

In Oregon 503-297-2321 (24 hours line)

**Computer  
Friends®**

6415 SW Canyon Ct., #10, Portland, OR 97221,  
telex 4949559

Dealer inquiries welcome.

**REAL TIME UNDER PASCAL**

```

PROCEDURE FRAME(Delay,Channel : INTEGER;
 VAR VX : INTRAY); EXTERNAL;

PROCEDURE DUMP; {prints out the data}

VAR K,M,N : INTEGER;

BEGIN
 WRITELN(PRINTFILE);
 FOR K := 0 TO 15 DO BEGIN
 FOR M := 0 TO 15 DO BEGIN
 N := K * 16 + M;
 WRITE(PRINTFILE,VOLTS[N]:5:2,' ');
 END;
 END;
 WRITELN(PRINTFILE);
 WRITELN(PRINTFILE);
 WRITELN(PRINTFILE);
 END;

BEGIN {main}
 REWRITE(PRINTFILE,'PRINTER:'); {open and output file}
 WRITELN(CHR(12)); {clear screen; get DELAY and CHANNEL}

 REPEAT
 GOTOXY(0,5);
 WRITELN('Enter delay as integer (1..256) in steps of');
 WRITE('5 microseconds from minimum of 26 microseconds:');
 DELAY := INTIN;
 IF (DELAY<0) OR (DELAY>255) THEN
 WRITE('DELAY OUT OF RANGE');
 UNTIL (DELAY>-1) AND (DELAY < 256);

 WRITE(CHR(12)); {erases error message}

 REPEAT
 GOTOXY(0,5);
 WRITE('Enter channel number 0..15): ');
 CHANNEL := INTIN;
 IF (CHANNEL<0) OR (CHANNEL>15) THEN
 WRITE('CHANNEL out of range. Reenter. ');
 UNTIL (CHANNEL>-1) AND (CHANNEL < 16);

 A:= 1.25.5;
 WRITELN(CHR(12)); {clears screen}
 GOTOXY(0,5);
 WRITELN('FRAME GRABBER STARTING');
 WRITELN;
 FRAME(CHANNEL,DELAY,V1); {the first call to FRAME.}
 WRITELN(CHR(12)); {clears screen}

 REPEAT
 GOTOXY(0,5);
 WRITELN('Enter delay as integer (1..256) in steps of');
 WRITE('5 microseconds from minimum of 26 microseconds:');
 DELAY := INTIN; {DELAY is 5 microseconds}
 IF (DELAY<0) OR (DELAY>255) THEN
 WRITE('DELAY out of range');
 UNTIL (DELAY>-1) AND (DELAY<256);

 WRITE(CHR(12)); {erases error message}
 GOTOXY(0,5);
 WRITELN('FRAME GRABBER STARTING');
 WRITELN;
 FRAME(CHANNEL,DELAY,V2);
 WRITELN('Converting data to REAL. ');
 FOR N:= 0 TO 255 DO BEGIN

```

(continued)

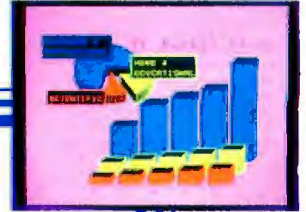
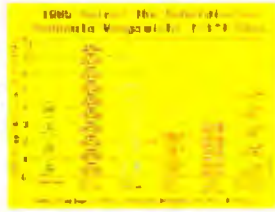
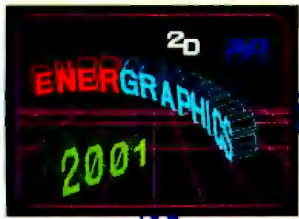

Until today,  
you needed a  
Charting program,  
a Drawing program,  
and a  
Presentation program.

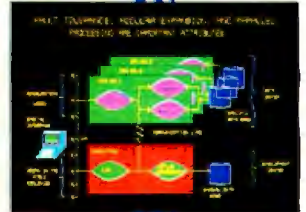

NOW ALL YOU NEED IS



# ENERGRAPHICS 2.0



EnerGraphics 2.0 simply outperforms the competition. Whether you're making charts for a presentation, analyzing data, making maps, flow charts or creating almost any type of graphic, you'll find the capability with EnerGraphics 2.0.

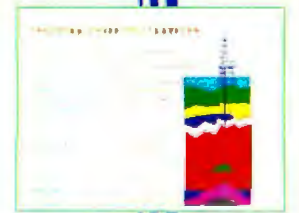

EnerGraphics 2.0 is easy to use too, because a mouse has been added. Now with mere pushes of a button, stunning charts and drawings are easily created. Help screens are also available, plus, new documentation with a quick-tip book that makes EnerGraphics 2.0 a breeze to use. So, if you want this kind of performance and capability which can be used by anyone, the simple choice is EnerGraphics 2.0.



Write for more information and a dealer near you or call 800-325-0174.

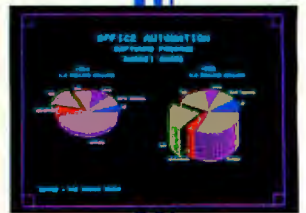
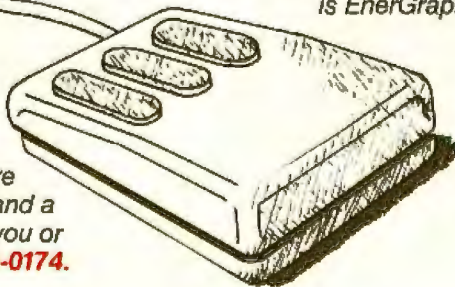

## ENERTRONICS

```

VOLTS[N] := V1[N]; {convert to REAL}
VOLTS[N] := A*VOLTS[N]-5; {change to volts}
END;
DUMP;
FOR N := 0 TO 255 DO BEGIN
 VOLTS[N] := V2[N]; {convert to REAL}
 VOLTS[N] := A*VOLTS[N]-5; {change to volts}
END;
CLOSE(PRINTFILE;
END.

```

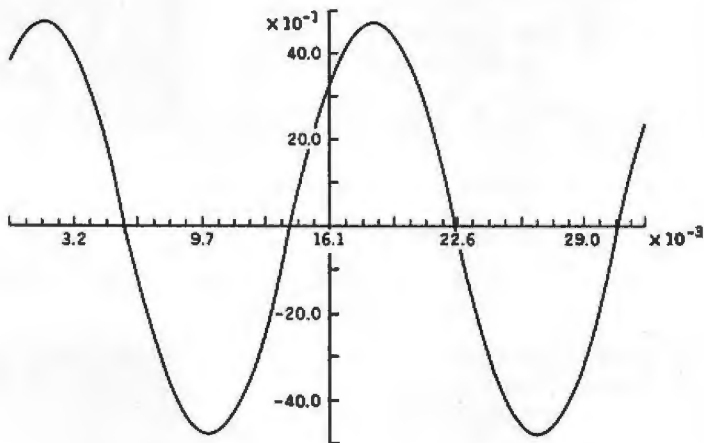

Figure 3: The graph of the data taken from the ADC with DELAY = 6 (hexadecimal).

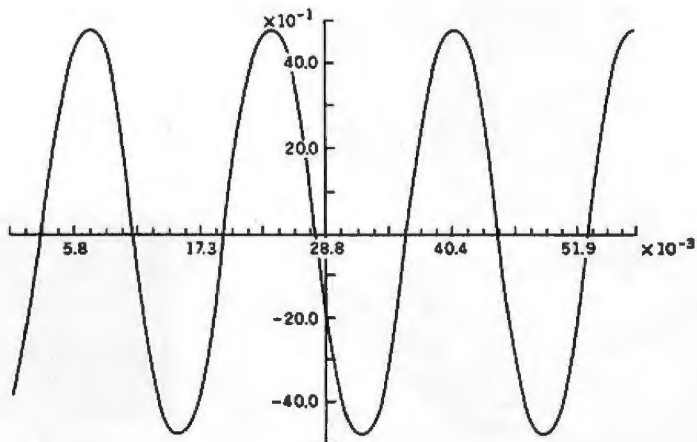

Figure 4: The graph of the data taken from the ADC with DELAY = 20 (hexadecimal).

On the left, you need only write  $V1+100$  (hexadecimal) to have that address of the 128th word of  $V1$ .

Let me stress that in assembly language no reference is made in any of this data manipulation to data structure. Any structure that is there must be handled by the programmer. You have to know exactly how the data will be arranged, and if you do it wrong the opportunities for disaster are boundless.

For example, structured arrays of integers are arranged sequentially in memory. Each integer is distributed over two bytes with the low-order part of the integer in the byte at the lower address. This means the LO byte of integer #2 is the third byte from the start of the list. The `.PUBLIC` statement or the transfer of address through the stack provides you with access to the LO byte in the array being referenced, whether the array is an array of 1 or 100. After that, the counting is all yours.

### THE PASCAL PART

To complete the example, listing 3 is a simple Pascal program that uses the assembly language routine in listing 1. The program simply gathers two blocks of data and prints them out. Its purpose is to show how the call is made, that it actually works, and that the transfer by address through the stack does enable you to apply `FRAME` to any array you might want. Had I used a global variable array, I would have had to use the data I obtained from each call to `FRAME` before calling `FRAME` again. Figure 3 shows the sinusoid plotted from the data taken on a 60-Hz signal using `GRABBER` with `DELAY = 6` (hexadecimal). Figure 4 shows the sine curve with `DELAY = 20` (hexadecimal).

### CONCLUSION

This application shows that for those rare circumstances in a high-level program where you must descend into the depths to achieve timing, communications, or any other operation where machine language is sine qua non, the makers of many Pascals have made it possible for you to do just that. ■

# We've taken the work out of doing Windows.

Microsoft® Windows is becoming the most popular operating environment for PC systems.

It's not surprising. Windows provides the foundation for an exciting new generation of applications that users are demanding. In addition, Windows handles many of the details involved in a software project allowing you to spend more time enhancing your application. That's why a growing number of corporate and independent software developers are building Windows applications.

The Microsoft Windows Software Development Kit is your key to this extraordinary new environment. It's packed with full reference documentation, libraries, utilities and sample programs. Together with our C Compiler or Macro Assembler, it's a comprehensive package that lets you make the most of your application.

## Software with a new view.

Giving your applications the Windows treatment begins with a new look. The rich graphical environment allows you to rethink how you want your program to be presented on screen. It lets you mix text and graphics. You can incorporate multiple fonts in a variety of sizes, faces and styles. And it provides the basic building blocks that make it easy to create drop-down menus, dialog boxes, scroll bars, icons and more.

These features not only simplify your application design, but also provide the familiar interface that makes your software easier to learn and use.

## Easing the data shuffle.

Of course, there's more to Windows than just looks. Now, different applications can work together. In concert.

The Windows Clipboard provides support for users to cut and paste information between your applications and others. Or you can use messages to establish "hot links" to transfer data automatically.

## Upgrading made easy.

Windows' device independent design allows you to build your application today and take advantage of new technology as it becomes available. When new graphics cards, printers and pointing devices appear they can be used with your software, without modifying your code. Simply by installing the new driver.

## Your window of opportunity.

The Microsoft Windows Software Development Kit is your fastest route to better applications. And with it, we also offer DIAL, our on-line technical support service to help you with the tough questions, and development courses that cover everything from using the dialog editor to memory management.

Find out how you can get your Microsoft Windows Software Development Kit. Pick up the phone and call (800) 426-9400. In Washington State and Alaska, call (206) 882-8088. In Canada, call (416) 673-7638. And we'll open the door to Windows.

### The Microsoft Windows Software Development Kit includes:

- Dialog editor.
- Icon editor.
- Font editor.
- Resource compiler.
- Linker.
- MAKE (program maintenance utility).
- Symbolic debugger.
- Heap analysis utility.
- Sample programs.
- Windows libraries.
- Programmer's reference.
- Programmer's utility guide.

### System requirements:

- 512K memory, DOS 2.0 or higher.
  - Two double sided disk drives\*.
  - Graphics adapter card.
- \*hard disk recommended

# Microsoft® Windows Software Development Kit

The High Performance Software.

Microsoft is a registered trademark of Microsoft Corporation.

# The fastest C

Your search for execution speed is over. The new Microsoft® C Compiler Version 4.0 is here. With blazing performance. We've added common sub-expression elimination to our optimizer that produces code that rips through the benchmarks faster than ever before.

"... the Microsoft performance in the benchmarks for program execution is the best of the lot overall!"  
— William Hunt, *PC Tech Journal*, January, 1986\*

But speed isn't the only edge you get with Microsoft C. Other advantages include a variety of memory models like our new HUGE model that breaks the 64K limit on single data items. Plus our NEAR, FAR and HUGE pointers, which provide you greater flexibility. All this allows you to fine tune your program to be as small and fast as possible.

"Excellent execution times, the fastest register sieve, and the best documentation in this review ... Microsoft Corporation has produced a tremendously useful compiler." — Christopher Skelly, *Computer Language*, February, 1986.

## No more debugging hassles. Introducing CodeView. Free.

Now, for a limited time, we'll give you an unprecedented programming tool when you buy Microsoft C, free. New Microsoft CodeView™ offers the most powerful tool yet in



the war on C bugs. Forget the hex dumps. Now you can view and work with programs at any level you want. Use the program source, the disassembled object code, or

### Microsoft C Compiler Version 4.00

#### Microsoft C Compiler

- Produces fast executables and optimized code including elimination of common sub-expressions. **NEW!**
- Implements register variables.
- Small, Medium and Large Memory model libraries.
- Compact and HUGE memory model libraries. **NEW!**
- Can mix models with NEAR, FAR and the new HUGE pointers.
- Transport source and object code between MS-DOS® and XENIX® operating systems.
- Library routines implement most of UNIX™ System V C library.
- Start-up source code to help create ROMable code. **NEW!**
- Full proposed ANSI C library support (except clock). **NEW!**
- Large number of third party support libraries available.
- Choose from three math libraries and generate in-line 8087/80287 instructions or floating point calls:
  - floating point emulator (utilizes 8087/80287 if installed).
  - 8087/80287 coprocessor support.
  - alternate math package — extra speed without an 8087/80287.
- Link your C routines with Microsoft FORTRAN (version 3.3 or higher), Microsoft Pascal (version 3.3 or higher) or Microsoft Macro Assembler.
- Microsoft Windows support and MS-DOS 3.1 networking support.
- Supports MS-DOS pathnames and input/output redirection.

#### Microsoft Program Maintenance Utility. **NEW!**

- Rebuilds your applications after your source files have changed.
- Supports macro definitions and inference rules.

#### Other Utilities

- Library Manager.
- Object Code Linker.
- EXE File Compression Utility.
- EXE File Header Utility.

#### C Benchmarks

|                                  | In seconds      |               |                           |               |              |
|----------------------------------|-----------------|---------------|---------------------------|---------------|--------------|
|                                  | Microsoft C 4.0 | Lattice C 3.0 | Computer Innovation C 2.3 | Aztec C86 3.2 | Wizard C 3.0 |
| Sieve of Eratosthenes (register) | 82.9            | 151.4         | 172.3                     | 88.0          | 91.9         |
| Copy Block                       | 86.9            | 231.7         | 199.0                     | 123.8         | 189.5        |

Run on an IBM PC XT with 512K memory

#### Microsoft CodeView

#### Window-oriented source-level debugger. **NEW!**

- Watch the values of your local and global variables and expressions as you debug.
- Set conditional breakpoints on variables, expressions or memory; trace and single step.
- Watch CPU registers and flags as you execute.
- Effectively uses up to four windows.
- Debug using your original source code, the resulting disassembly or both intermingled.
- Use drop-down menus to execute CodeView commands.
- Access the on-line help to lead you through CodeView's options and settings.
- Easily debug graphics-oriented programs since program output is kept separate from debugger output.
- Keyboard or optional mouse support.
- Enter in familiar SYMDEB or DEBUG commands.



# you've ever seen.

both at the same time. Open a window to view CPU registers and flags. Watch local and global variables as well. All while your program is running.

CodeView gives you complete control. Trace execution a line at a time—using source or assembly code. Or set conditional breakpoints on variables, memory or expressions. CodeView supports the familiar SYMDEB command syntax, as you'd expect. Commands are also available through drop-down menus. Combine the new window-oriented interface with our on-line help and debugging has never been easier. Or quicker.

## Take the \$5 CodeView tour.

You may find it hard to believe our debugger can do all we've claimed. So we're offering test drives. Five bucks will put you behind the wheel of a Microsoft C demo disk with CodeView.\* See for yourself how fast debugging can get.

For more information about the CodeView demo disk, the new Microsoft C Compiler, a list of third party library support or the name of your nearest Microsoft dealer, call (800) 426-9400. In Washington State and Alaska, (206) 882-8088. In Canada call (416) 673-7638.

```
File Search View Run Watch Options Calls Trace! Go! pi.exe
math.c
0) island : 244
1) tiszero() : 1
2) 4034:0000 00 00 00 00 00 00 00 00 43 72

3DB5:00EE B00200 MOV AX,0002
3DB5:00F1 E89402 CALL __chkstk (0380)
3DB5:00F4 56 PUSH SI
3DB5:00F5 8B7604 MOV SI,Word Ptr [BP+04]
13: t[0] = 1;
3DB5:00F8 C606441A01 MOV Byte Ptr [t (1A44)],01
14: div(s); /* t[] = 1/s */
3DB5:00FD 56 PUSH s
3DB5:00FE E82601 CALL _div (0227)
3DB5:0101 83C402 ADD SP,+02
15: add();
3DB5:0104 E84D00 CALL _add (0154) ;BR0
16: island = 1;
3DB5:0107 C746FE0100 MOV Word Ptr [island],0001
17: do {
>da 33 0x29
4034:0021 Microsoft
>
```

## Microsoft® C Compiler

The High Performance Software

Microsoft, MS-DOS and XENIX are registered trademarks and CodeView is a trademark of Microsoft Corporation. UNIX is a trademark of AT&T Bell Laboratories. IBM is a registered trademark of International Business Machines Corporation. \*Offer expires 12/31/86

# Finally, a language worth

For years BASIC has been everyone's first language. And for almost as long, they've been tempted by other languages. Lured by promises of more speed, more power.

We have a solution. A new language that's a substantial improvement over BASICA. Faster. More structured. Finally, a compelling reason to leave BASIC.

Introducing Microsoft's QuickBASIC Compiler, Version 2.0.

At last, you can have the latest programming techniques, combined with the solid foundation of BASIC. Our new compiler is as compatible with BASICA as you can get. At the same time it offers the extra speed and power you've been looking for.

## Run faster with compiled code.

If there's one thing you've asked for, it's speed. And Microsoft® QuickBASIC simply blazes. Old BASICA programs will run up to ten times quicker once they've been compiled. Sometimes even faster.

## Everything you need. Built-in.

Making programs run faster is only part of the story, though. The new Microsoft QuickBASIC Compiler includes a full-screen editor, built-in. So now you can make the jump from writing to RUNning in no time flat. Edit your program, compile it, and run it. Faster than any other BASIC compiler around. All without leaving our on-line help and prompts.

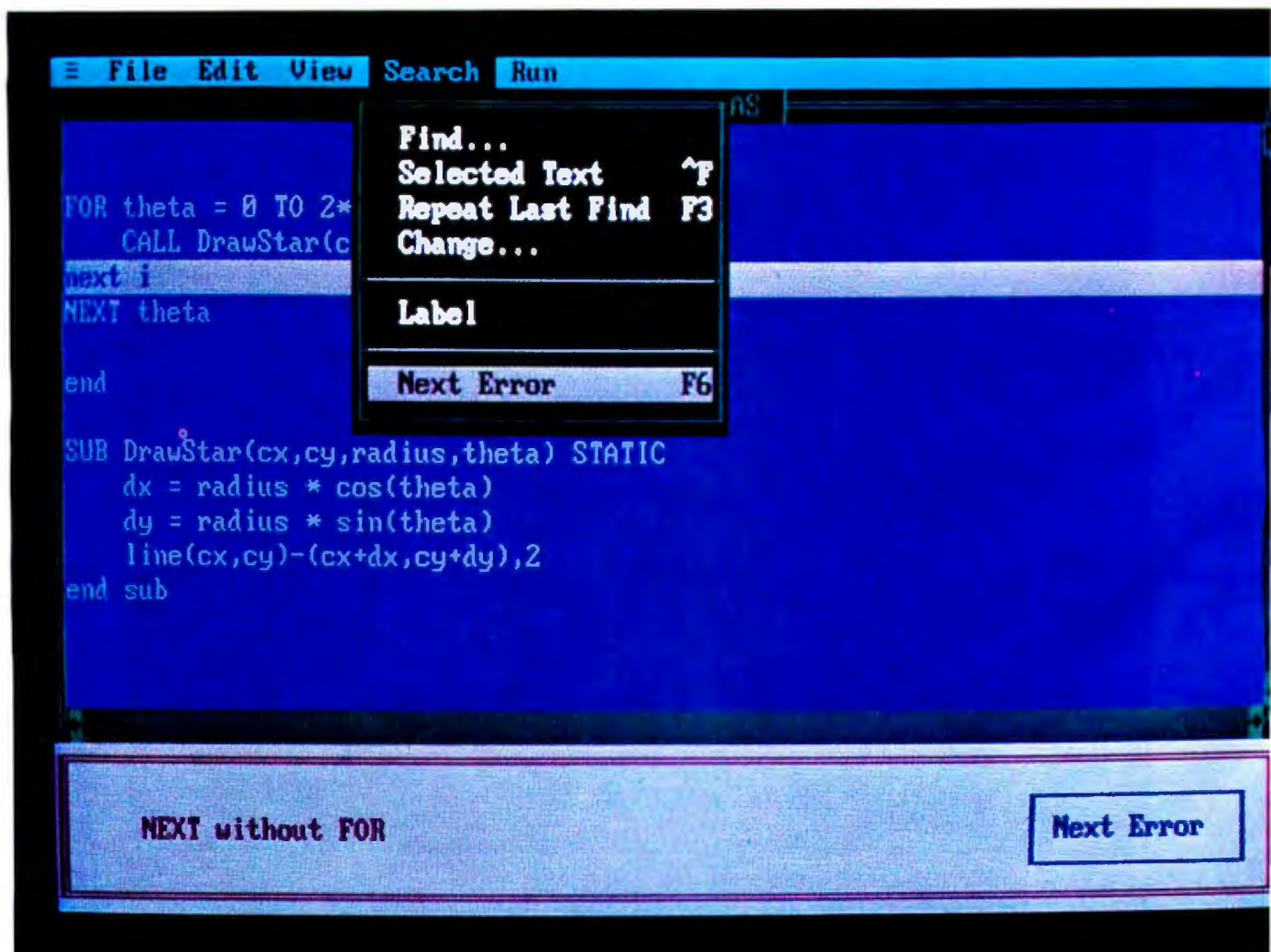

# leaving BASIC for.

On the rare chance your program doesn't run 100% the first time out, we've got another surprise for you. The Microsoft QuickBASIC debugger. Our full-screen tracing lets you debug your programs while watching the source code execute. A line at a time, or with breakpoints. As easy as can be.

Our compiler is also smart enough to save you time. First, by finding any errors in one pass. Second, by putting your editor's cursor on the problem. Automatically. So you don't have to get lost in a maze of error codes and line-numbers.

## The BASIC virtues. And more.

Speaking of line numbers, let's not. Because line numbers are strictly optional. And Microsoft QuickBASIC lets you use alphanumeric labels as well. Now you can GOTO *ErrorCheck* instead of line number 6815.

Or you could stop using GOTOs altogether. There are a variety of options that could make the GOTO an endangered species. Features like multi-line IF-THEN blocks. And named subprograms. Now your BASIC programs can be as structured and organized as you want.

We've only just begun to talk about the virtues of Microsoft QuickBASIC. There are dozens of enhancements to your favorite language. Things like larger arrays. Local and global variables. Reusable modules that let you create libraries of your most often-used routines. All explained in a revised manual that includes a complete language reference.

## Making your quick escape.

If all these features follow your BASIC instincts, then zip on down to your nearest Microsoft dealer. That's where you'll discover the best surprise of all. The price. Only \$99 for the best reason to leave BASIC.

For the name of your nearest Microsoft dealer, call (800) 426-9400. In Washington State and Alaska, (206) 882-8088. In Canada, call (416) 673-7638.

**Microsoft® QuickBASIC**  
The High Performance Software™

### Microsoft QuickBASIC Compiler Version 2.0 for IBM® PC and Compatible Computers.

#### BASICA Compatibility

- Sound statements including SOUND and PLAY.
- Graphics statements including WINDOW, VIEW, DRAW, GET, PUT, LINE, CIRCLE, LOCATE and SCREEN.
- Support of EGA extended graphics modes. NEW!
- BASICA structures are supported including WHILE/WEND, IF/THEN/ELSE, FOR/NEXT, GOSUB/RETURN, and event handling.

| Results of Sieve Benchmark | BASICA 3.1 | Microsoft QuickBASIC 2.0 |
|----------------------------|------------|--------------------------|
| Seconds per iteration      | 78         | 0.52                     |

#### Complete Programming Environment

- Built-in Editor that places the cursor on found errors automatically. NEW!
- Compile entirely in memory at speeds up to 6000 lines per minute. NEW!
- Link routines once when starting a programming session and no need to link again when changing programs. NEW!
- Built-in debugger with single-step, animate, and trace modes. NEW!
- Create stand-alone programs.

#### Alphanumeric Labels

- Can be used to make your programs more readable. Line numbers are not required but are supported for BASICA compatibility.

#### Structured Programming Support

- Block IF/THEN/ELSE/END IF eliminates the need for GOTO statements. NEW!
- Subprograms can be called by name and passed parameters. Both local and global variables are supported.

#### Modular Programming Support

- Separate compilation allows you to create compiled BASIC libraries to use and re-use your programs.
- A library of routines to access DOS and BIOS interrupts is supplied. NEW!

#### Large Program Support

- Code can use up to available memory.
- Numeric arrays, each up to 64K bytes, can use up to available memory. NEW!



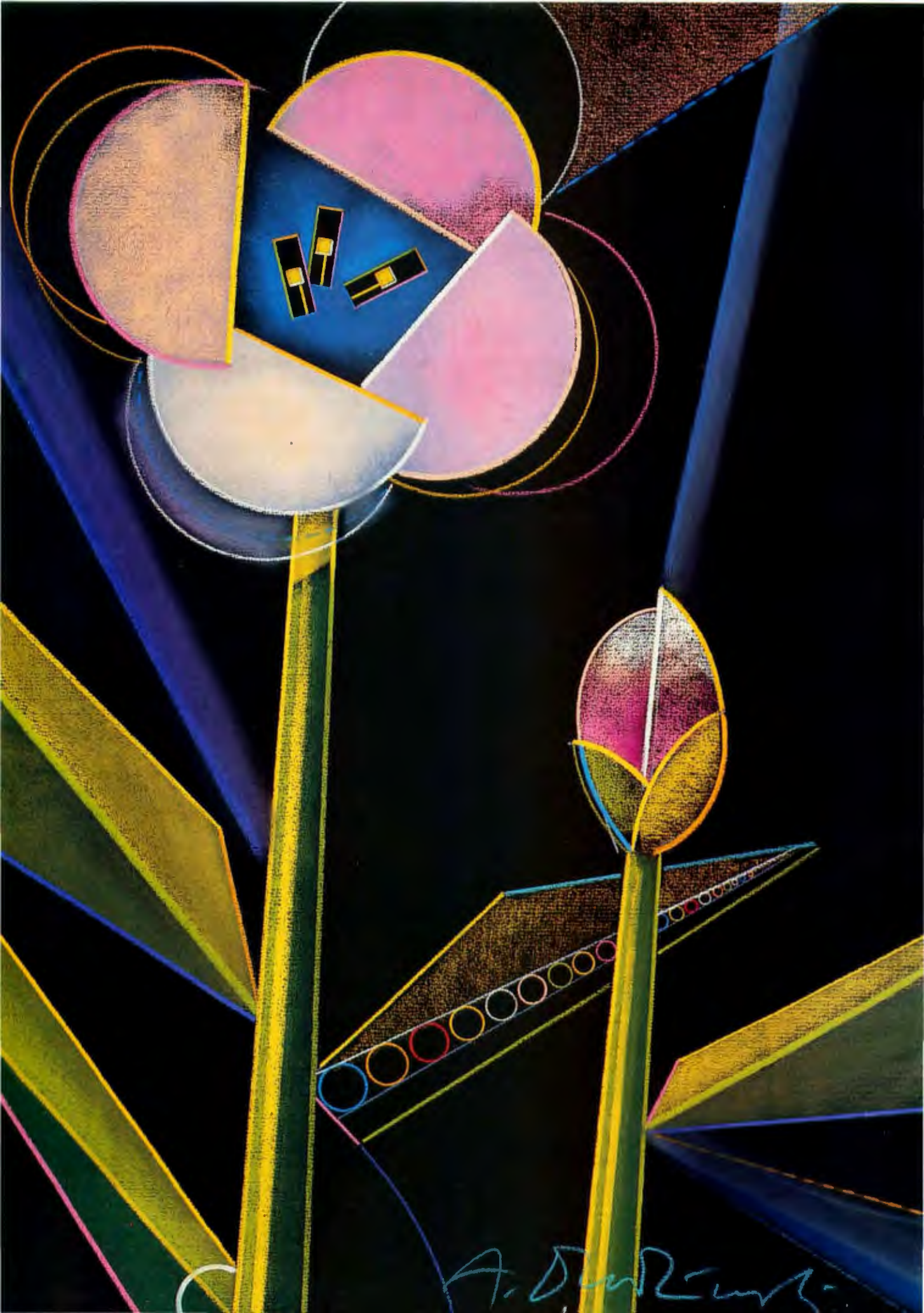

A. D. Runkle

# 68000 Machines

---

|                                                                                                         |            |
|---------------------------------------------------------------------------------------------------------|------------|
| <b>68000 TRICKS AND TRAPS</b><br><i>by Mike Morton</i> .....                                            | <b>163</b> |
| <b>UNIX AND THE MC68000</b><br><i>by Andrew L. Rood, Robert C. Cline,<br/>and Jon A. Brewster</i> ..... | <b>179</b> |
| <b>A COMPARISON OF MC68000 FAMILY<br/>PROCESSORS</b><br><i>by Thomas L. Johnson</i> .....               | <b>205</b> |
| <b>ATARI ST SOFTWARE DEVELOPMENT</b><br><i>by Michael Rothman</i> .....                                 | <b>223</b> |
| <b>AMIGA ANIMATION</b><br><i>by Elaine A. Ditton and Richard A. Ditton</i>                              | <b>241</b> |
| <b>AMIGA VS. MACINTOSH</b><br><i>by Adam Brooks Webber</i> .....                                        | <b>249</b> |

---

THE APPLE MACINTOSH GAVE US all a glimpse, back in February of 1984, of a glittering new future for personal computers. Many people had seen similar technology in the high-end workstations made by companies like Xerox, Apollo, and Sun. But these workstations were priced outside the range of the traditional personal computer; we drooled over them but didn't expect to be able to own one—until the Macintosh came along.

Soon after the Macintosh created a new wave of excitement in the personal computer world, Atari and Commodore began showing prototype machines that offered similar capabilities but with more power and at lower cost. Suddenly, it seemed that a new trend in personal computers was developing.

Inspection of the new machines, and many of the workstations they emulated, revealed a common component—a Motorola MC68000-series microprocessor. Closer investigation showed that the MC68000 had the horsepower and the easy programmability that lent itself to the creation of workstation-like machines. These machines had lots of memory, addressed linearly, and handled bit-mapped graphics with ease.

Many people began to see the MC68000 as an alternative to the Intel iAPX86-series microprocessor that powered the IBM PC-class machines. Today, there are avid MC68000 camps and equally avid Intel iAPX86 programmer cadres.

Sparked by all the interest in the new Commodore Amiga, the Atari ST series, and the Macintosh, BYTE began work on an extensive examination of the MC68000. Originally planning for a separate issue of the magazine, we put together a series of articles exploring the MC68000 and many of the machines it powers. Those articles make up this month's theme section and the continuing coverage of the MC68000 that will appear in our Features section over the next several months.

The coverage in the following pages includes a comparison of the entire MC68000 series by Motorola's Tom Johnson. There are, in fact, five different MC68000s, and Johnson explains what each is designed to do and, most important, how compatible they all are with each other.

In other articles, Mike Morton passes along some of the assembly language techniques he's acquired while helping to write software such as Lotus's Jazz for the Macintosh. Adam Webber shares some similar observations about the Macintosh and Amiga system software gleaned from his work in porting the True BASIC language to those two machines. A group of Hewlett-Packard engineers explains why the MC68000 is particularly well suited to the UNIX operating system. Mike Rothman explains the many faces of GEM and the other system software on the Atari ST. And Elaine Ditton and Richard Ditton look at writing animation software for the Amiga, the MC68000-based machine with the most raw computing power but also the rawest system software of the new wunderkind computers.

Follow-on articles in subsequent issues will include articles on debugging in an MC68000 environment, more assembly language programming techniques, and more advanced tutorials on the Atari ST, Amiga, Macintosh, and other MC68000 machines.

—G. Michael Vose, Senior Technical Editor, *Themes*

## Amiga under \$2,000. Anybody else up to \$20,000.

This "painting" was created on the Amiga™ computer using Electronic Arts' Deluxe Paint™ software. No PC, anywhere, can create this kind of graphic dazzle for the price of an Amiga.

But there's more to the Amiga than whiz bang graphics. It's also a top-of-the-line PC ready to solve problems, business and personal.

The incredible power that brings Tut back to life can also make gigantic spreadsheets sit up and beg, can make eloquent the wordiest of word-processing tasks, and thanks to the Amiga's unique multi-tasking capabilities, it can do

word processing and spreadsheet analysis and graphics and more simultaneously.

No other PC past, present or in the near future has done it, is doing it or is likely to do it.



**See what you think.**

Inquiry 398

# 68000 TRICKS AND TRAPS

BY MIKE MORTON

## *Some assembly language programming guidelines*

THE ERA OF HIGH-LEVEL LANGUAGES has not made assembly language coding a dead art, even on modern microprocessors designed for executing compiled high-level code. Although personal computers are approaching the power of mainframes, the way to get the most out of any processor is to know when to use assembly language. The popular Motorola MC68000 processor is a good example; it has a fairly regular instruction set and instructions to support features of such languages as Pascal and C. Yet the instruction set is not perfectly orthogonal—warts in the design and implementation make the architecture interesting for hand-coded assembly programs.

The continuing usefulness of assembly language, even on this processor, is apparent in recent industry products. The Macintosh ROM, for instance, is written entirely in assembly language, yielding considerable savings in memory and speed.

In this article I'll survey some of the subtleties of the 68000 to help you avoid its pitfalls and exploit its oddities for better speed or memory use. I assume that you have some experience using the 68000; if not, see the bibliography at the end of this article.

### **TRAPS FOR THE BEGINNER**

Most of the 68000's "traps" have a reason behind them; unintuitive aspects of the processor may actually be more useful, easier to implement, or correct in the view of the 68000 designers.

One trap is memory alignment. Although the 68000 supports byte, word, and long-word operations, word and long-word operands must be aligned on word boundaries (even addresses). This is because memory is grouped in

words (2 bytes) and accessed via a 16-bit bus. Instructions must be word-aligned also, but assemblers and linkers normally do this for you.

Another trap is stack direction. The 68000 stack "grows" toward low memory. This means that to allocate stack space you should subtract from the stack pointer: `SUB #size,SP`. To deallocate space (or to discard previously pushed values), add to the stack pointer. Equally confusing, when allocating local storage with the `LINK` instruction, you must specify a negative displacement to be added to the stack pointer.

The stack pointer (SP) must stay word-aligned. If you push or pop a byte through the SP, the processor will move a word to or from the stack, placing the relevant byte in the high-order half of that word. Only the SP behaves this way; other address registers act the way you'd expect. This may seem an anomaly in an orthogonal architecture, but the SP must stay word-aligned so that words and long words are pushed to even addresses.

Shift and rotate instructions can operate on the byte, word, or long-word part of a data register, but shifts of memory operands can be only word size. Data registers can be shifted by up to 32 bits if the shift count is specified in another register or by up to 8 bits if the shift count is a constant given in the instruction. Memory can be shifted by only 1 bit.

The syntax of two-operand instructions may be reversed from other machines you're used to. For instance, the

*(continued)*

Mike Morton received his B.A. in mathematics from Dartmouth College. He is currently a senior software engineer for Lotus Development Corporation (161 First St., Cambridge, MA 02142).

68000 instruction `MOVE.W D0,D1` is equivalent to `LOAD D1,D0` on some other machines; that is, the contents of the D0 register are moved into D1. On the 68000, the destination register—the one affected by the instruction—is always second. The operand order for `CMP` instructions is also reversed from some older machines; therefore you would read `CMP D0,D1` as “compare D1 to D0.” (But beware: Some assemblers reverse the order of the operands from Motorola’s standard; UNIX assemblers often do this.)

The 68000 provides the comparison operations shown in table 1. This includes not only all six possible relationships between two numbers, but also whether numbers are compared as signed or unsigned quantities. (Comparing the word values 0006 and FFFE hexadecimal depends on how the numbers are interpreted. If they’re signed numbers, 6 is greater than -2. But if they’re addresses, they’re unsigned, and 0006 is a lower address than FFFE.)

The confusing thing is that the expected unsigned equivalents of `BLT` and `BGE` are not `BHS` (branch on higher or same) and `BLO` (branch on lower). Instead, Motorola uses `BCS` and `BCC`, respectively. The processor is perfectly orthogonal, providing for all types of comparisons. But the mnemonics are asymmetrical on the unsigned side (unless you use a nonstandard assembler or define your own macros).

(The distinction between signed and unsigned comparisons comes up rarely, since they are the same unless one of the values involved has the high-order bit [the sign bit] set. However, when the distinction is significant, it can lead to trouble. An operating system’s disk allocator may sort disk blocks using a `BGT` instruction. After some years, a site tries to configure a system with more than  $2^{31}$  bytes of disk storage. Everything grinds to a halt because `BGT` compares 80000010 hexadecimal to 7FFFFFF0 hexadecimal and incorrectly finds the latter address to be greater. A `BHI` instruction would have compared and sorted the addresses correctly.)

A note on using the condition codes: After a `TST` instruction, the overflow (V) condition code is cleared. This means that after `TST`, `BLT` is equivalent to `BMI`, and `BGE` is the same as `BPL`. Stylistically, `BMI` and `BPL` make more

sense after a `TST` unless the value being tested is the difference of two other values.

### TRAPS FOR EXPERTS

Some quirks of the 68000 are less intuitive and regularly catch seasoned programmers. Some of these aspects of the implementation suggest design difficulties and trade-offs in the processor; others reflect the designers’ ideas on what constitutes good programming.

Addresses and data are different. Most assemblers quietly assemble `MOVE #0,A0` as a `MOVEA` (move to an address register) instruction without nagging the programmer about the distinction between `MOVE` and `MOVEA`. But the 68000 treats data and address values very differently.

Address operations (`MOVEA`, `ADDA`, etc.) are never byte-size.

Word values are sign-extended to 32 bits before being used in address operations. Thus, `ADDA.W D1,A2` extends the low-order word of D1 before adding it to A2. In the 68000, there is no such thing as a 16-bit address, so a word-size value is converted to 32 bits before being used in address operations.

Address operations never set condition codes; most data operations do. This is useful in subroutines that return information in the condition codes:

```
TST.W D0 ; Set condition codes to
 ; return to caller.
MOVE.L (SP)+,A0 ; Pop return address into A0.
ADD.W #params,SP ; Deallocate <params> bytes
 ; of parameters.
JMP (A0) ; Return with condition codes
 ; still set.
```

(Note that the `MOVE` and `ADD` are translated into `MOVEA` and `ADDA` by the assembler.) The condition codes set by the `TST.W` are unaffected by the remainder of the exit sequence.

Another trap concerns loop operations. A loop ending with a `DBcc` instruction (such as `DBEQ`) loops until the condition cc is true; this instruction can be thought of as “decrement and branch back if condition false.” This is confusing since, if you were to write out several instructions to replace a `DBEQ`, they would contain a `BNE` to jump back to the top of the loop, not a `BEQ`.

If the condition being tested for is not detected (or if you’re using `DBRA`), the loop will stop when the counter reaches -1, not 0. If you want the loop always to be executed once, you should enter it at the top with the count already decremented by 1. For example, to search for the first null (zero) byte in a table of N bytes pointed to by A1:

```
MOVE.W #N-1,D0 ; Start the loop counter
 ; one too low.
LOOP ; Come here to test
 ; another byte.
TST.B (A1)+ ; Is A1’s byte zero?
 ; (Advance after testing)
DBEQ D0,LOOP ; If not zero AND D0 is
 ; still >= 0, loop back.
```

(continued)

Table 1: This table shows which branch instructions will result in a branch taken when testing for a given relationship of D1 to D0 after a `CMP D0,D1` instruction.

| Relationship | Signed | Unsigned                    |
|--------------|--------|-----------------------------|
| D1 < D0      | BLT    | BCS (branch on Carry Set)   |
| D1 <= D0     | BLE    | BLS                         |
| D1 = D0      | BEQ    | BEQ                         |
| D1 ≠ D0      | BNE    | BNE                         |
| D1 > D0      | BGT    | BHI                         |
| D1 >= D0     | BGE    | BCC (branch on Carry Clear) |



“Turbo Pascal...  
is a very good system.  
But don't make  
the mistake of trying to  
use it for large programs.”

*Niklaus Wirth  
as reported in Micro Cornucopia  
August-September 1985*

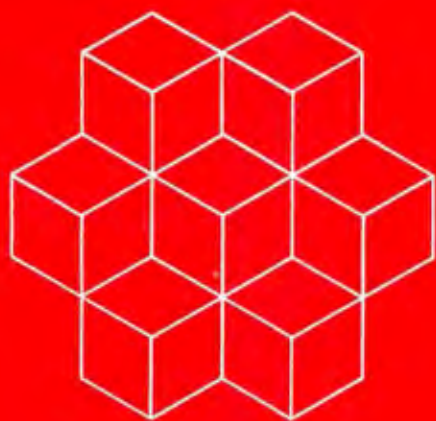

LOGITECH  
**MODULA-2/86**

This loop will execute at most *N* times. It corresponds to Pascal's "repeat...until" construct. For the equivalent of "while...do," which doesn't necessarily enter the loop:

```

MOVE.W #N,D0 ; Start the loop counter normally.
BRA LOOPSTART ; Don't fudge D0; jump to
 ; the loop end first.
LOOP ; This is the loop head.
TST.B (A1)+ ; Is A1's byte zero?
 ; (Advance after testing)
LOOPSTART ; Enter here to check count
 ; before looping.
DBEQ D0,LOOP ; If not zero AND D0 is
 ; still >= 0, loop back.

```

If you're using DBcc, don't forget to initialize the condition codes so the DBcc doesn't fall through when you jump to it. In the code above, the MOVE.W #N, D0 "primes" for the loop.

Also remember that the data register used to control the loop is decremented as a word quantity. If it's possible to have more than 2<sup>16</sup> iterations, you have to nest two DBcc loops. For example, to checksum a list of bytes whose length is specified in the long word D0:

```

MOVEQ #0, D3 ; Initialize checksum.
MOVE.W D0,D1 ; Low word of loop length in D1.
MOVE.L D0,D2 ; Get high word of loop length
SWAP D2 ; in D2 to use for outer loop.
BRA.S START ; Enter at the end of the loop.
LOOP: ADD.B (A1)+,D3 ; Add the next byte into sum.
START: DBRA D1,LOOP ; Inner loop: Loop on low word of
 ; D0.
 DBRA D2,LOOP ; Outer loop: Loop on high word.

```

Small adjustments to the stack pointer can be done with ADDQ (or SUBQ) #n,SP, but these instructions can change it by at most 8 bytes. The fastest way to change it by more than 8 bytes is with LEA n(SP),SP.

The 68000 does not allow you to execute a MOVE instruction with a destination relative to the program counter (PC). In the view of the 68000 designers, code should not patch itself. If you must change a table in the middle of code, you must point to it with an instruction like LEA TABLE(PC),An and then alter it through An. (Self-modifying code is especially bad for 68000 programs that may someday run on the 68020, because the 68020's instruction cache normally assumes that code is pure.)

For no apparent reason, the CLR instruction always reads from an operand before clearing it. But unlike BCLR, CLR doesn't set the condition codes. Never use CLR to write a zero to a memory-mapped device address if the device will be affected by the read. The Scc instruction and MOVES from the status register also read before writing but are less likely to cause problems.

Don't confuse the EXG and SWAP commands. EXG exchanges the 32-bit contents of two registers. SWAP swaps the 16-bit halves of a single data register.

When indexing into an array, remember to multiply the index register by the "stride" (bytes per element) of the array. For instance, if D0 holds an index into an array of long words pointed to by A1, you must multiply the in-

dex by 4 to convert from long words to bytes:

```

MULU #4,D0 ; Turn the array index into
 ; a byte offset.
MOVE.L 0(A1,D0.L),D1 ; Pick up the long-word
 ; array element in D1.

```

The EOR instruction must have a data register for the source, except for the immediate form of the instruction, EORI.

### CODING FOR SPEED: PRINCIPLES

The secret of efficient code on the 68000 can be described using one word: "registers." Suppose, for example, that you have two 32-bit variables. If you keep them in registers, the time to add one to the other with ADD.L D0,D1 is 8 clock periods. If they're in memory pointed to by address registers, the time to add them with MOVE.L (A0),D0 and ADD.L D0,(A1) is 32 clock periods, four times slower! The moral of the story is simple: Work hard to keep frequently used quantities in registers.

You can learn this important rule and others by studying instruction timing information (such as the tables in the *M68000 16/32-bit Microprocessor Programmer's Reference Manual*). Times are given in clock periods, which I'll call cycles; a 10-MHz processor executes 10 cycles per microsecond. In general, the tables give the base time for each instruction. Most base times must have additional times added in for the operands. For instance, the time to execute AND.W D0,(A1)+ is 8 cycles for a word-size AND-to-memory and 4 more cycles for the (A1)+ destination operand. (The source operand is "free" because it's a register.) Thus, the entire instruction takes 12 cycles, or 1.2 μsec on a 10-MHz processor.

When you're trying to save a few cycles in a crucial loop, timing tables can be useful as more than just a reference. They provide a concise summary of the architecture—sort of a shopping list of the instructions available and the cost of each. When you're trying to avoid preconceived notions of which instructions are suited to solving a problem, this summary can remind you of alternatives and encourage lateral drift in your thinking.

### CODING FOR SPEED: BASIC RULES

The MOVEQ, ADDQ, and SUBQ instructions are great. For instance, it's faster to zero all 32 bits of a data register by using MOVEQ #0,Dn than it is to use CLR.L Dn. Remember that these instructions are limited to small numbers: MOVEQ can load values from -128 to 127 into a data register; ADDQ (SUBQ) can add (subtract) only values from 1 to 8 to (from) its destination.

DBcc is especially efficient; use it whenever you can. (But beware the traps described above.)

Not all assemblers automatically produce "short" branches (branches with 8-bit displacements). Check the output of your assembler to see if it emits a short branch whenever possible. If not, you may have to use BRA.S, BSR.S, and Bcc.S in your source code instead of BRA, BSR, and Bcc.

(continued)

# TAKE THE NEXT LOGICAL STEP



## \$89 Price

- Separate Compilation
- Native Code Generation
- Large Memory Model Support
- Multitasking
- Powerful Debugging Tools
- Comprehensive Module Library
- Available for the PC and the VAX

Move up to LOGITECH MODULA-2/86. Whether you're a single programmer or part of a team, with LOGITECH MODULA-2/86 you'll decrease your overall development cycle and produce more reliable, more maintainable code. Build your program using our extensive library modules, your own modules or those from a growing list of available third-party software vendors. If you're a Turbo Pascal user you can even take your existing code along with you with the help of our new Translator!

### NEW & IMPROVED!

#### Turbo Pascal to Modula-2 Translator **\$49**

Now it's even easier for Turbo users to step up to Modula-2/86. Our improved Translator changes your Turbo source code into Modula-2/86 source, solving all the incompatibilities, and translating the function calls of Turbo into Modula-2/86 procedures. Implements the complete Turbo library!

#### LOGITECH MODULA-2/86 **\$89**

Complete with Editor, Run Time System, Linker, 8087 Software Emulation, Binary Coded Decimal (BCD) Module, Logitech's comprehensive library, Utility to generate standard .EXE files. AND more!

#### ■ LOGITECH MODULA-2/86 with 8087 Support **\$129**

■ LOGITECH MODULA 2/86 PLUS **\$189**  
For machines with 512K of RAM. Takes advantage of larger memory to increase compilation speed by 50%.

## NEW, improved Turbo Pascal to Modula-2 Translator!

Call for information about our VAX/VMS version, Site License, University Discounts, Dealer & Distributor pricing.

To place an order call our special toll free number:

800-231-7717

In California:

800-552-8885

# MODULA-2/86

#### RUN TIME DEBUGGER **\$69**

(Source level!)  
The ultimate professional's tool! Display source code, data, procedure call chain and raw memory. Set break points, assign values to variables, pinpoint bugs in your source.

#### UTILITIES PACKAGE **\$49**

Features a post-mortem debugger (PMD). If your program crashes at run time the PMD freezes the situation so you can pinpoint, in the source, the cause of the error and the status of the data. Also includes a disassembler, cross reference utility and version that allows conditional compilation.

#### LIBRARY SOURCES **\$99**

Source code for our major library modules is now available for customization or exemplification.

#### WINDOW PACKAGE **\$49**

Now you can build true windowing into your Modula-2 code. Powerful, though only 15K in size. Features virtual screens, color support, overlapping windows and a variety of borders.

#### MAKE UTILITY **\$29**

Automatically selects modules affected by code changes to minimize recompilation and relinking. Even figures out dependencies for you!

#### CROSS RUN TIME DEBUGGER AND ROM PACKAGE **\$199**

Now available at an introductory price!

## YES I want to move up to LOGITECH MODULA-2/86!

Here's the configuration I'd like:

- |                                                     |              |
|-----------------------------------------------------|--------------|
| <input type="checkbox"/> Logitech Modula-2/86       | <b>\$89</b>  |
| <input type="checkbox"/> with 8087 support          | <b>\$129</b> |
| <input type="checkbox"/> Plus Package               | <b>\$189</b> |
| <input type="checkbox"/> Turbo to Modula Translator | <b>\$49</b>  |
| <input type="checkbox"/> Run Time Debugger          | <b>\$69</b>  |
| <input type="checkbox"/> Utilities Package          | <b>\$49</b>  |
| <input type="checkbox"/> Library Sources            | <b>\$99</b>  |
| <input type="checkbox"/> Window Package             | <b>\$49</b>  |
| <input type="checkbox"/> Make Utility               | <b>\$29</b>  |
| <input type="checkbox"/> ROM Package                | <b>\$199</b> |

Total Enclosed \$ \_\_\_\_\_

Visa  Mastercard  Check Enclosed

Card Number \_\_\_\_\_ Expiration Date \_\_\_\_\_

Signature \_\_\_\_\_

Name \_\_\_\_\_

Address \_\_\_\_\_

City, State \_\_\_\_\_

Zip \_\_\_\_\_ Phone \_\_\_\_\_



## LOGITECH

Logitech, Inc.  
805 Veterans Blvd.  
Redwood City, CA 94063  
Telephone 415-365-9852

For European pricing please contact:

Logitech SA  
Box 32, CH-1143  
Apples, Switzerland  
Telephone 41-21-774545

Turbo Pascal is a registered trademark of Borland International.

Because a taken short branch is slower than an untaken one, try to avoid taking most branches. For instance, if you have a loop searching for a null, the simple way to search is with

```

LOOP ; Here to search for the
 ; next null.
 TST.B (A3)+ ; Check next byte; advance
 ; the search pointer.
 BNE.S LOOP ; Loop back if not found.

```

It takes only a bit more space to "unroll" one or more iterations of the loop:

```

LOOP ; Here to search for the
 ; next null.
 TST.B (A3)+ ; Check next byte; advance
 ; the search pointer.
 BEQ.S FOUND ; If zero, exit the loop.
 TST.B (A3)+ ; Not zero: check another
 ; byte and advance.
 BNE.S LOOP ; If still not found,
 ; loop back.
 FOUND ; Come here when A1 points
 ; one past the null byte.

```

If the character tested generally isn't zero, the BEQ.S usually goes untaken and is faster. You can unroll any number of iterations, adding TST.B/BEQ.S pairs until the extra space consumed is no longer worth the diminishing increase in speed (or the branches become long branches).

Addressing with (An)+ is faster than with -(An). If you have the choice of which direction to go in a search or other loop through memory, move upward. (Note that this is not true for the destination operand of a MOVE instruction.)

Because (An) addressing is faster than x(An), access to the first element of a data structure is faster than to the others. (This is also useful with Pascal records, C structures, etc.)

The MOVEM instruction is a very efficient way to stack or unstack a large number of registers. But if you have to push only two registers, or pop three, MOVEM is no faster than moving them one at a time.

Don't assume that long operations are always slower than word-size ones. For instance, word address operations can be slower than long ones because of the time to sign-extend a word value.

As with other machines, never multiply or divide by a power of 2 when you can shift instead. Although shifts are time-consuming, they're always faster than a multiplication or division. So, you can use the ASL (arithmetic shift left) instruction to multiply by a power of 2 and use ASR (arithmetic shift right) to divide by a power of 2. (Be careful here—the right shift is not the same as a division if the contents of the register are negative. For example, -1 divided by 2 should be zero, but -1 shifted right by 1 bit is -1, rounded incorrectly.) Don't forget that the multiplication instructions produce a long-word result from a word operand; shifting doesn't.

To multiply by 2, add a register to itself instead of shift-

ing: ADD Dn,Dn. In fact, if you are multiplying a word operand by 4, you can do it faster with two ADD instructions than with a single shift by 2 bits.

Similarly, in doing extended-precision arithmetic, you can replace the common operation ROXL #1,Dn with ADDX Dn,Dn and save 2 or 4 cycles, depending on whether the operands are words or longs.

You can compute certain multiplications faster with shifts even if they're not powers of 2. For instance, to multiply D0 by 17, add D0 to 16 times D0:

```

MOVE D0,D1 ; Copy D0 to D1.
LSL #4,D0 ; Compute 16 x D0 in D0.
ADD D1,D0 ; Add original value in to
 ; compute 17 x D0.

```

Computing products this way is still faster than the 40-plus cycles for a multiply instruction.

The cost of maintaining the stack can be lessened if arguments are deleted after the call by the caller, not the subroutine. (Most C compilers use this stack protocol.) If the stack doesn't have to be cleaned up after every call, you can allow debris from several calls in a row to accumulate as long as it's easy to keep track of how much there is. Typically, you can let it pile up until you reach a branch, then unstack it all with an ADDQ (or LEA if there's more than 8 bytes to remove).

Finally, don't ignore the 68000's "higher-level" instructions. Even at the assembler level, instructions such as PEA, LINK, UNLK, and CHK can be very useful.

### CODING FOR SPEED: SOME COOKBOOK EXAMPLES

Here are a variety of things you can do to save time when you're scraping for cycles. Some are useful in many applications; others are very specialized. The more obscure ones are examples of the kinds of tricks that the 68000 can do.

Remember that timings will not be the same on the 68000's relatives (the 68008, 68010, 68020, etc.). If you're working on one of these processors, recompute the timings or, when you're not sure which of two approaches is faster, measure the speed of both. Timings for the 68020 will be especially hard to compute because of its sophisticated prefetch and instruction caching.

You should also know that not all computers run the processor at the advertised speed. For instance, the Macintosh's 68000 runs at 7.8 MHz, but it can't always operate at this speed because the screen is memory-mapped and "steals" some memory cycles. Thus, the effective speed of the Macintosh is about 6 MHz, but only memory cycles are slowed down—CPU cycles are unaffected. So operations done mostly within the CPU (such as multiply, divide, and long register shifts) run at nearly full speed. The lesson in all this is that timings are hard to compute or intuit; you may want to time various pieces of code for yourself to see which is faster.

It is said that one doesn't really know how to use a tool until one knows three ways to abuse it. Here are some of my favorite ways to abuse the 68000.

(continued)

# AMERICA'S NEXT FAVORITE MOUSE.

The best price: \$99

## THE BEST HARDWARE:

- PC/XT/AT compatible through your serial port
- NO pad, NO power supply
- High (200 DPI) resolution
- Tactile feedback switches

## THE BEST SOFTWARE: LOGIMOUSE with Plus Package Software

\$119

- Driver 3.0: makes LOGIMOUSE run with all mouse based software, including Microsoft.
- LOGIMENU: a programmable Pop-Up Menu System that customizes LOGIMOUSE for each of your keyboard based applications.
- CLICK: a new concept in mouse software! It resides in memory, detects what application you're running and automatically sets the mouse to your predefined setting.
- POINT-AND-CLICK SHELL for Lotus 1-2-3: the only mouse interface for 1-2-3 that goes beyond keyboard emulation. With context sensitive pop-up menus and an independent mouse cursor that changes shape and meaning in different areas of the 1-2-3 screen. Makes it faster and easier to select a cell, invoke a command or scroll.
- POINT EDITOR: a mouse based program editor featuring pop-up menus and overlapping, color windows for faster, easier file editing. Use it instead of EDLIN or any other ASCII file editor.

## THE BEST DEALS:

**NEW!** Introductory Price!  
LOGIMOUSE with Plus Pkg. & Reflex ~~\$268~~ \$199

A winning combination! LOGIMOUSE enhances the power of Reflex, Borland's amazing database management system, to probe relationships in your data and display them in graphic form.

**NEW!** Introductory Price!  
LOGICADD-LOGIMOUSE with Plus Pkg. & Generic CADD 2.0 with Dot Plot ~~\$244~~ \$189

Generic CADD has the features and performance of high-priced CAD, DotPlot turns your dot matrix printer into a plotter, and LOGIMOUSE is the ultimate input device.



## NEW Reflex & LOGICADD Packages!

**LOGIPAINT SET—LOGIMOUSE with Plus Pkg. & PC Paintbrush 3.0** ~~\$258~~ \$169  
LOGIMOUSE plus PC Paintbrush 3.0 is the most advanced paint set available for the PC. Use it for designing a logo or painting a picture. You won't believe its power with either freehand drawing or graphics!

To place a credit card order call our special toll-free number:  
**800-231-7717**

Call toll-free in California:  
**800-552-8885**

**YES!** I want America's next favorite mouse!

Please send me:

- |                                                       |       |                                                                                                                                                                  |
|-------------------------------------------------------|-------|------------------------------------------------------------------------------------------------------------------------------------------------------------------|
| <input type="checkbox"/> LOGIMOUSE with Driver 3.0    | \$ 99 | <b>30-Day Money-Back Guarantee/<br/>New 3-Year Warranty</b><br><small>Add \$6.50 for shipping &amp; handling. Calif. residents add applicable sales tax.</small> |
| <input type="checkbox"/> LOGIMOUSE with Plus Software | \$119 |                                                                                                                                                                  |
| <input type="checkbox"/> Plus Package Software        | \$ 29 |                                                                                                                                                                  |
| <input type="checkbox"/> LOGIMOUSE with Reflex        | \$199 |                                                                                                                                                                  |
| <input type="checkbox"/> LOGICADD                     | \$189 |                                                                                                                                                                  |
| <input type="checkbox"/> LOGIPAINT                    | \$169 |                                                                                                                                                                  |

For your computer model: \_\_\_\_\_

VISA     MASTERCARD     CHECK ENCLOSED

Card Number \_\_\_\_\_ Expiration Date \_\_\_\_\_

SIGNATURE \_\_\_\_\_

NAME \_\_\_\_\_

ADDRESS \_\_\_\_\_

CITY, STATE \_\_\_\_\_

ZIP \_\_\_\_\_ PHONE \_\_\_\_\_

DEALER INQUIRIES WELCOME

**LOGITECH**

*United States:*  
LOGITECH, Inc.  
805 Veterans Blvd.  
Redwood City, CA 94063  
Tel: 415-365-9852

*In Europe:*  
LOGITECH SA  
CH-1143 Apples  
Switzerland  
Tel: 41-21-774545

LOGIMOUSE is a registered trademark of LOGITECH. Lotus and 1-2-3 are trademarks of Lotus Development Corp. Reflex is a trademark of Borland-Analytica. Generic CADD is a trademark of Generic Software, Inc.

**Fast subroutine calls.** Although JSR and RTS provide a simple subroutine call-and-return, the cost of pushing the return address on the stack is significant. For a very frequently called subroutine, you can change the call to store the return in an address register as in

```
LEA RETURN,A0 ; Return address goes in A0.
JMP routine ; Jump to the subroutine.
RETURN ; A0 points to this spot.
```

Then to return, just JMP (A0). By avoiding use of memory, this saves 8 cycles. (Note that the LEA instruction references the label RETURN with PC-relative addressing.)

Also, if you end a subroutine with

```
JSR lastsub ; Call one last subroutine
RTS ; and return.
```

and lastsub doesn't alter the stack, you can save a whopping 24 cycles by using "tail recursion" to replace the two instructions with a single

```
JMP lastsub ; "Call" lastsub and
 ; it'll return for us.
```

Finally, if you call a subroutine and then branch somewhere else, you can avoid extra jumping around. For instance,

```
JSR sub ; Make a call
JMP next ; and go somewhere else.
```

can be made slightly faster with

```
PEA next ; Push a fake return address
JMP sub ; and "call."
 ; sub will RTS to next for us.
```

(All of the above work for BSR and BRA as well as JSR and JMP.)

**Quick test for zero.** If you want to test whether a register is zero and don't mind trashing the value, use DBRA

Dn,NOTZERO instead of combining TST.W Dn with BNE NOTZERO.

If you want to do an *N*-way branch depending on a value, you'll usually want to index into a jump table and transfer to the appropriate address. A "case" statement is typically implemented this way. But if you have a very small number of values and want to handle the lower values more quickly, a series of DBRAs can do this conveniently. For example, if you want to branch based on a register that contains 0, 1, or 2,

```
DBRA D0,NOT0 ;Decrement; jump if it wasn't
 ; zero.
<handle zero case>
NOT0 ; Come here if not zero.
 ; D0 has been decremented.
DBRA D0,NOT1 ; Decrement; jump if original
 ; D0 wasn't one.
<handle one case>
NOT1 ; Not one. D0 has been
 ; decremented twice.
DBRA D0,ERROR ; Decrement; if not originally
 ; two, error.
<handle two case>
```

**Checking for membership in a small set.** If you want to see if a number is in a set of several numbers, you can create a bit mask corresponding to the set. For instance, if the set is {0,1,3,5}, the mask has those bits set and the bit map is 00101011 (2B hexadecimal). You can test for membership in this set with

```
BTST D0,#$2B ; Is D0 in {0,1,3,5}?
```

If your set is composed of more than eight elements you have to move the mask into a data register first.

**Quick comparisons.** To check the value of a data register with CMP.L #xxx,Dn takes 14 cycles. If the value be-

(continued)

# GREATER PERFORMANCE...AT HALF THE COST!

## DATA I/O 29B™ COMPATIBILITY-UNDER \$1,500

*Programming A World of Technologies*

UNIVERSAL, GANG & SET PROGRAMMING FOR LAB AND LIGHT PRODUCTION

### BYTEK ALWAYS SETTING HIGHER STANDARDS

- Supports MOS/CMOS EPROM/EEPROMs including Megabit devices. Options: Bipolar PROMs, Logic Array Devices, 40 pin Micro Chips, and GangCel
- Memory capacity to 1Mbyte, 64 bit wide programming, device type and parameters stored in non-volatile memory
- 3-Way device type selection: manually, auto ID or from menu
- 2-Way command execution: Function keys or menu
- Data I/O PROMInk™ and BYTEK PROMsoft™ compatible

26 Key-32 Character LCD display - Memory expandable to 1 Megabyte  
RS232 PC Interface, Parallel Printer Port

Data I/O, PROMInk are trademarks of Data I/O, Inc.  
MADE IN THE U.S.A.

21 Day No Obligation  
Trial Period

**\$1,495**

COMPLETE  
Model:  
\$125-GL



ORDER TODAY  
800-523-1585 / In Fla. - 1-305-994-3520  
Telex: 4998369 BYTEK

Mastercard or Visa Welcome



Instrument Systems Division • 1021 South Rogers Circle • Boca Raton, Florida 33431

# PC-DESK

## TAKES YOU BEYOND SIDEKICK

### PC-DESK. The Ultimate In Desk-Top Management

Now, finally at your command. A completely integrated word processor, calendar/reminder, name/address/phone database and directory. Letter/label/report printer, mailmerge, invoice system and printing calculator.

PC-Desk does just about everything you need. It's a powerful and easy-to-use tool that reduces your work and makes your business life easier. And, it does more than hundreds of higher-priced programs.

### Look At Everything You Get!

#### Easy Instructions

Step by step directions on the screen. You'll always know what codes to use. Even if you're new to computers, you'll be efficient right away.

#### Calendar/Reminder

24 reminders per day. Reminder days are highlighted. Put the cursor on any day. . . all your reminders pop up. See a full month at a time. Flick back and forth between months. Print reminders with a single keystroke. You're organized and you'll stay organized.

#### To Do List

Tracks up to 20 projects. You'll never forget what you need to do.

#### Word Processor

Full-featured. . . why use any other word processor? PC-Desk gives you professional-looking documents. . . with bold, underlining, centering, and justification. Word wrap, block move, search, margin settings. And no waiting for screens to come up with Turboscreen.

#### Personal Address Book

Automatically printed in a pocket-sized format. Cross-indexed by company name. Breast-pocket holder free when you order PC-Desk.

#### Database

Outstanding organization and flexibility. Easy to access and maintain. Name, address, phone number (work and home), salutation, title, date, variables for automatic printing, comments, and more. Sort on zip, or alphabetically by name or company. Search, scroll through, change or delete.

#### The Most Powerful Feature

PC-Desk automatically prepares your letters, invoices and memos.

It's fast and easy to send individually typed, personalized letters, either singly or by the hundreds. Just select the names you want. Tell PC-Desk which letter to send, and it does the rest.

It puts in the special greeting you use for each person. It adds the variable information you want. . . the shipment date, company or product name, or

Select names for group mailings. Make notes on client contact. Print your rolodex, envelopes, (with return address too), letterheads, invoices, labels, entire name and address file.

#### Mail Merge

Fully integrated with database. Letters with up to four variables.

#### Calculator

Print your calculations. Pops up into word processor. Hex, binary, and octal for programmers.

#### Memory Partitioning

Lets you flip back and forth between PC-Desk and other programs. Cut and paste.

#### Logs

Client billing, computer use, telephone, and expense logs. Great for tax records! Print monthly statements with total time and expenses. Edit your logs. With auto-dialer calls are logged automatically.

#### Auto-Dial

Save time. Auto-dial any phone number in your database. Choose work or home number.

#### Encrypt

Protect your files from prying eyes.

#### DOS Functions

Copy, delete, print, view, rename files easily.

#### On-Screen Clock

Full instructions.

#### Manual

Full instructions.

#### Not Copy

Protected

whatever you choose. All at the touch of a button.

PC-Desk is simply spectacular. Users say, "This is the way software ought to be!" Try it for 60 days. If you're not completely satisfied, return it for a full refund.

#### Free Updates, Free Support.

That's right. Free updates. (Remember, if you already own PC-Desk, send for your free update to version 6.5.)

And, if you ever need help, just call us. We'll talk you through it.



### PC-DESK SIMPLY THE BEST.

To order, or for more information:

Call Toll Free 1-800-A-PC-DESK

**YES!** Rush me the best—PC-Desk.  
60-Day Money-Back Guarantee.

★ **SPECIAL OFFER** ★

Only \$79

(plus \$5.00 Shipping & Handling).

You save \$46 on the regular \$125 price.

**Offer Expires in 30 Days**

Check  Money order  
 MasterCard  Visa

Card # \_\_\_\_\_

Expiration date \_\_\_\_\_ / \_\_\_\_\_

Name \_\_\_\_\_

Firm \_\_\_\_\_

Address \_\_\_\_\_

City \_\_\_\_\_

State/Zip \_\_\_\_\_

Requirements: IBM-PC, AT, XT, or compatible. 128K for program, 272K for memory partitioning, MS-DOS 2.0. Modem required for Auto-Dial only.

ing tested for is small enough to fit in a MOVEQ, it's shorter and faster to put the value in a temporary register:

```
MOVEQ #xxx,D0 ; Set up value to look for
CMPL D0,Dn ; and do the comparison.
```

If the value xxx is between -8 and 8, and you don't mind altering the data register, you can just use SUBQ #xxx,Dn (or ADDQ, as appropriate) instead of a CMP. Then you can use a conditional branch just as you would after a CMP. This works for word or long-word comparisons.

**Picking up an unaligned word.** The straightforward approach is to load 1 byte, shift it into position, and load the second byte. The faster way (28 cycles instead of 38) is to exploit the stack pointer's odd behavior when byte quantities are pushed on the stack:

```
MOVE.B (A0)+,-(SP) ; First byte to high half of
 ; new word on stack.
MOVE.W (SP)+,D0 ; Pop that new word to D0.
 ; First byte in place.
MOVE.B (A0),D0 ; Second byte in place.
```

**Clearing address registers.** MOVE.L #0,An takes 12 cycles, while SUB.L An,An takes only 8 and is shorter. (CLR doesn't work with address registers.)

**Avoiding long shifts and rotates.** The time the 68000 takes to shift a register is proportional to the distance being shifted: 2 additional cycles for every bit. Thus, never rotate a long word more than 16 bits in either direction or a word more than 8 bits. (Remember that to shift by more than 8 bits, you have to put the shift count into a data register. In the examples that follow, the bit count is *not* a constant; the value is bracketed to show this.)

```
ROL.L <16+x>,Dn = ROR.L <16-x>,Dn
ROL.W <8+x>,Dn = ROR.W <8-x>,Dn
```

In shifting 16 bits or more, the first 16 bits of the shift can be done with a SWAP to save 26 cycles in each of these cases:

```
LSR.L <16+x>,Dn =
CLR.W Dn ; Clear bits that swap up
SWAP Dn ; and LSR.L #16,Dn.
LSR.W <x>,Dn ; Now finish the shift.

ASR.L <16+x>,Dn =
SWAP Dn ; Slide down 16 bits.
EXT.L Dn ; Sign-extend to a long word.
ASR.W <x>, Dn ; Finish up, sign-extended.
```

```
LSL.L <16+x>,Dn =
LSL.W <x>,Dn ; Shift x bits in low half.
SWAP Dn ; Shift 16 more bits.
CLR.W Dn ; Throw away bottom half.
```

And some long-word operations of less than 16 bits can be optimized with SWAP. Long shifts between 11 and 15 bits can be speeded up with

```
LSL.L <x>,Dn =
SWAP Dn ; Rotate left by 16 bits.
ROR.L <16-x>,Dn ; Undo to x-bit left rotate.
AND.W #mask,Dn ; Remove bottom x bits.
```

```
LSR.L <x>,Dn =
AND.W #mask,Dn ; Remove bottom x bits.
SWAP Dn ; Rotate right by 16 bits.
ROL.L <16-x>,Dn ; Undo to x-bit right rotate.
```

**Fast sign-extend.** While there are instructions to sign-extend bytes into words or words into long words, what if you have a signed 12-bit field (from unpacking a record or reading a DAC)? The standard way to sign-extend this to a full 16-bit word is with

```
LSL.W #16-12,Dn ; Shift so 12-bit field is left-justified.
ASR.W #16-12,Dn ; Shift it back down sign-extended.
```

If you know that the bits outside the 12-bit field are zero, you can do this without shifting. In general, if you want to sign-extend an *N*-bit field to 16 bits, define "mask" to be  $-(2^{(N-1)})$ —a mask with the bottom *N*+1 bits clear. Then the sign extension can be done using a temporary register:

```
MOVE.W #mask,D0 ; Build mask with high N+1 bits set.
ADD.W D0,Dn ; Negative: top bits=0.
 ; Positive: top bits=1.
EOR.W D0,Dn ; Flip so top bits are correct.
```

This is always at least as fast as the shifting method, which gets slower as *N* increases. Sign-extending to a long word is faster this way if *N* is 3 or more.

**Loading large constants.** To move certain values into the upper half of a data register, you might code MOVE.L #00xx0000,Dn. It's faster to replace this single instruction with two:

```
MOVEQ #xx,Dn ; Move value to lower half
 ; and clear upper half.
SWAP Dn ; Swap—put things in position.
```

**Clearing the upper half of a data register.** Instead of doing this with AND.L #\$FFFF,Dn, it's quicker to use

```
SWAP Dn ; Swap high and low halves.
CLR.W Dn ; Clear high half while it's low.
SWAP Dn ; Put things back in place.
```

## CONCLUSIONS

Esoteric coding techniques continue to be important in pushing processors to their limits. A machine such as 68000, which is oriented toward executing compiled high-level languages, can still be appropriate for tight hand-crafted solutions. A programmer who needs the utmost in performance can exploit quirks in an instruction set to great advantage. ■

## BIBLIOGRAPHY

- Harmon, Thomas L., and Barbara Lawson. *The Motorola 68000 Microprocessor Family*. Englewood Cliffs, NJ: Prentice-Hall, 1985.
- Kane, Gerry, Doug Hawkins, and Lance Leventhal. *68000 Assembly Language Programming*. Berkeley, CA: Osborne/McGraw-Hill, 1981.
- Motorola Inc. *M68000 16/32-bit Microprocessor Programmer's Reference Manual*. Englewood Cliffs, NJ: Prentice-Hall, 1984.
- Scanlon, Leo J. *The 68000: Principles and Programming*. Indianapolis, IN: Howard W. Sams, 1981.
- Starnes, Thomas W. "Design Philosophy Behind Motorola's MC68000." *BYTE*, April-June 1983.
- Williams, Steve. *Programming the 68000*. Berkeley, CA: Sybex, 1985.



**The most  
significant  
development in  
monochrome graphics  
since the  
Hercules  
Graphics Card.**

# Announcing the Hercules Graphics Card Plus.

Four years ago, the Hercules™ Graphics Card brought high resolution monochrome graphics to the IBM® PC for the first time. And revolutionized the world of personal computers.

Now, it's happening again.

Because now there's the Hercules Graphics Card Plus. A giant step forward in technology that creates a whole new standard for graphics hardware and a world of potential for software.

**Three modes are  
better than two.**

Until now, graphics cards have had

only two modes to work with: text and graphics.

Text mode is very fast, but it's limited to 256 pre-programmed characters.

Graphics mode, on the other hand, lets your software create as many characters as you want. But for text processing, graphics mode can be slow, painfully slow.

Enter a new, third mode.

Called RamFont™

Two years in development, RamFont gives you the best of both worlds. It blends the blinding speed of text with the flexibility of graphics.

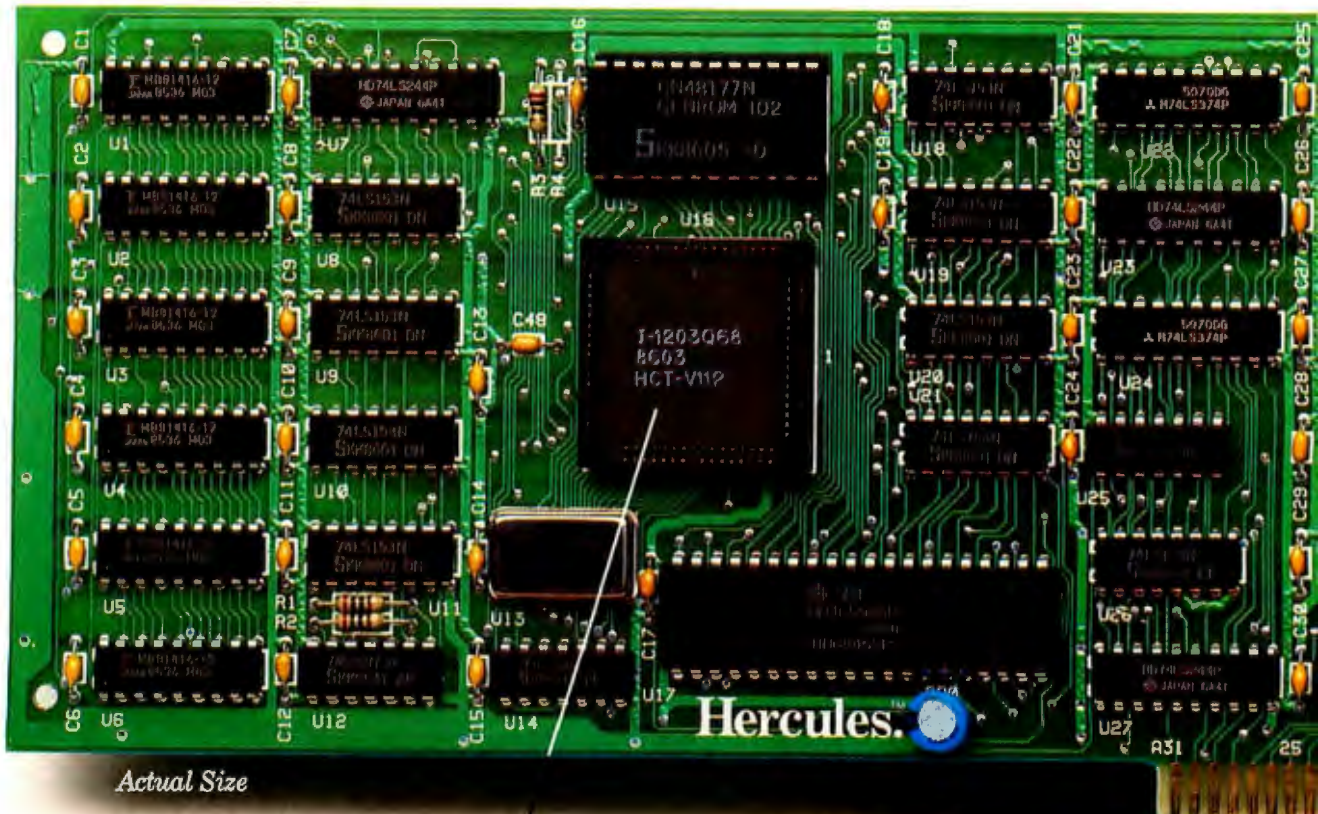

*Actual Size*

*The heart of the Graphics Card Plus: the V112 microchip, Hercules' next generation video processor that makes the RamFont mode possible.*

Enough flexibility to blow the doors off the 256-character limit of text mode.

Because RamFont can handle an astonishing 3072 different characters of various widths and heights.

Instead of 256 canned, unchangeable ones.

### The future according to RamFont.

With all these characters and fonts to work with, software will never be the same again.

RamFont word processors, for example, will put italics, boldface, and scientific characters right on the screen with standard text. So you can see what you're about to print.

RamFont spreadsheets will use smaller characters to display larger amounts of information. So you

can get the big picture.

RamFont integrated packages will mix true text and graphics and turn your PC's screen into a fast-lane version of the Macintosh's.<sup>™</sup>

And if you happen to be one of those geniuses who's fluent in five languages, you'll be able to type a letter in all of them.

Simultaneously.

### A Herculean feat.

How did we manage to combine the radical new RamFont on the same card with

Hercules' legendary sharp text and high resolution 720x348 graphics and still be 100% compatible with the original Hercules Graphics Card?

It wasn't easy.

In fact, it took two years and all of the sophisticated CAD tools at our disposal to create our exclusive V112 microchip.\*

This totally new generation of video processor is at the heart of every Hercules Graphics Card Plus.

It's also at the heart of a revolution in software that's beginning right now.

Turn the page and you'll see what we mean.

*\*Patent applied for.*



*The Hercules Printer Cable— a \$40 value, free with each Graphics Card Plus.*

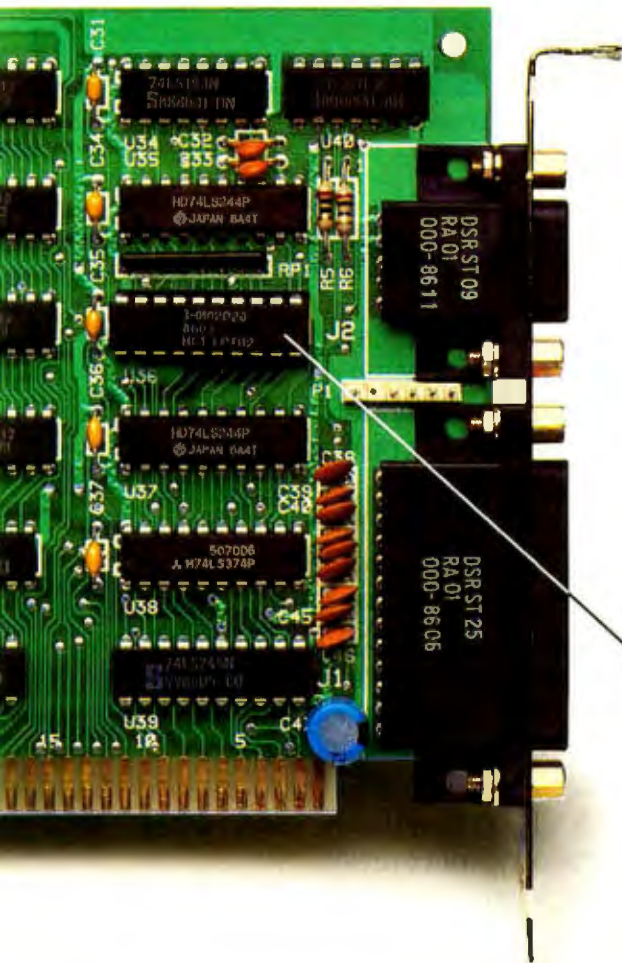

*Another Hercules innovation: the new LPT112. It's a parallel printer port on a chip.*

|    | A                                        | B    | C          | D    | E    | F    | G          |
|----|------------------------------------------|------|------------|------|------|------|------------|
| 1  | Computer Programmer Salary Survey (1982) |      |            |      |      |      |            |
| 2  | From Source EDP                          |      |            |      |      |      |            |
| 3  |                                          |      |            |      |      |      |            |
| 4  | Category                                 | Abbr | Experience | 15%  | Mean | 85%  | Experience |
| 5  | Commercial                               | BUS  | 0-1        | 14.7 | 19.2 | 22.4 | 0-1        |
| 6  | Commercial                               | BUS  | 1-2        | 15.9 | 21.6 | 27.5 | 1-2        |
| 7  | Commercial                               | BUS  | 2-4        | 17.8 | 25.2 | 32.7 | 2-4        |
| 8  | Commercial                               | BUS  | > 4        | 28.2 | 29.8 | 37.1 | > 4        |
| 9  | Engineering/Scientific                   | ENG  | 0-1        | 15.4 | 20.1 | 26.8 | 0-1        |
| 10 | Engineering/Scientific                   | ENG  | 1-2        |      |      |      |            |
| 11 | Engineering/Scientific                   | ENG  | 2-4        |      |      |      |            |
| 12 | Engineering/Scientific                   | ENG  | > 4        |      |      |      |            |
| 13 | Mini/Micro                               | MINI | 0-1        |      |      |      |            |
| 14 | Mini/Micro                               | MINI | 1-2        |      |      |      |            |
| 15 | Mini/Micro                               | MINI | 2-4        |      |      |      |            |
| 16 | Mini/Micro                               | MINI | > 4        |      |      |      |            |
| 17 | Systems                                  | SYS  | 1-2        |      |      |      |            |
| 18 | Systems                                  | SYS  | 2-4        |      |      |      |            |
| 19 | Systems                                  | SYS  | > 4        |      |      |      |            |
| 20 | Data Base                                | DBMS | 1-2        |      |      |      |            |
| 21 | Data Base                                | DBMS | 2-4        |      |      |      |            |
| 22 | Data Base                                | DBMS | > 4        |      |      |      |            |
| 23 | Data Communications                      | COMM | 1-2        |      |      |      |            |
| 24 | Data Communications                      | COMM | 2-4        |      |      |      |            |
| 25 | Data Communications                      | COMM | > 4        |      |      |      |            |
| 26 | Documentation                            | DOC  | 0-1        |      |      |      |            |
| 27 | Documentation                            | DOC  | 1-2        |      |      |      |            |
| 28 | Documentation                            | DOC  | 2-4        |      |      |      |            |
| 29 | Documentation                            | DOC  | > 4        |      |      |      |            |
| 30 |                                          |      |            |      |      |      |            |
| 31 | Commercial                               | BUS  | 0-1        |      |      |      |            |
| 32 | Commercial                               | BUS  | 1-2        |      |      |      |            |
| 33 | Commercial                               | BUS  | 2-4        |      |      |      |            |

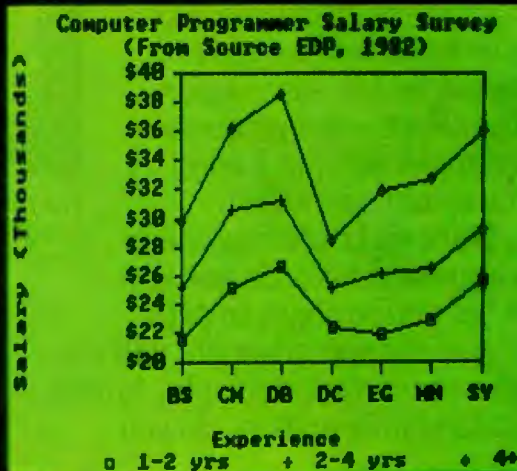

Lotus 1-2-3 Rel. 2 in the RamFont mode of the Graphics Card Plus: fast scrolling, a 90-column by 38-row screen and a pop-up graphics window.

## Software will never be the same again.

The trouble with most new hardware introductions is that there isn't any software available to introduce them to.

Not so with the new Hercules Graphics Card Plus.

It runs everything the original Hercules Graphics Card runs.

Better yet, it comes complete with the software you need to start using the revolutionary new RamFont mode right now with some of the world's favorite programs.

### Lotus blossoms.

Of course, if you want to talk about the world's favorite programs, you have to start with Lotus® 1-2-3®.

You won't recognize Release 2.

Because now you can put nearly twice as much information on your screen, scrolling right and left and up and down at speeds you'll remember nostalgically from the days of Version 1A.

Another thing you won't recognize is that cute little graphics window. You can thank RamFont for that.

Now that RamFont is with us, you can pop up a graphics window any time you're in the mood and still keep your 1-2-3 spreadsheet in the background.

And you can do the same with Symphony™ of course.

Or, if your tastes tend toward Ashton-Tate's Framework™ II, you'll be pleased to hear that you can really

## RAMFONT

Font mode will never be the same again.

The RamFont™ mode of the Hercules Graphics Card model GB112 is a versatile and powerful new mode. The GB112 provides facilities for software to easily accomplish its RamFont mode, what used to require a great deal of effort in graphics mode.

Here are a few examples of fonts created for RamFont mode. We call this font the "follor" font.

Here is an example of an 800 character set, and now the **ITALICS!** In RamFont mode there are 3872 user-definable characters.

## FROM HERCULES

Font mode will never be the same again...

*The Graphics Card Plus in RamFont mode showing multiple fonts created using FontMan,™ a Hercules program that comes free with each Card.*

*Ashton-Tate's Framework II with italics and boldface and speed in the RamFont mode of the new Hercules Graphics Card Plus.*

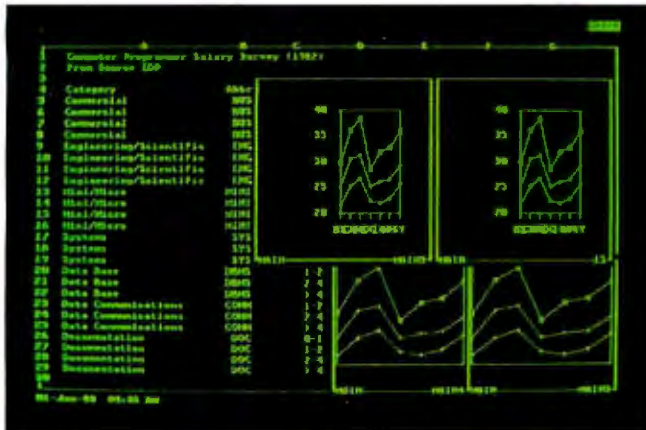

*The programmable RamFont is so flexible, Symphony can mix true text and graphics.*

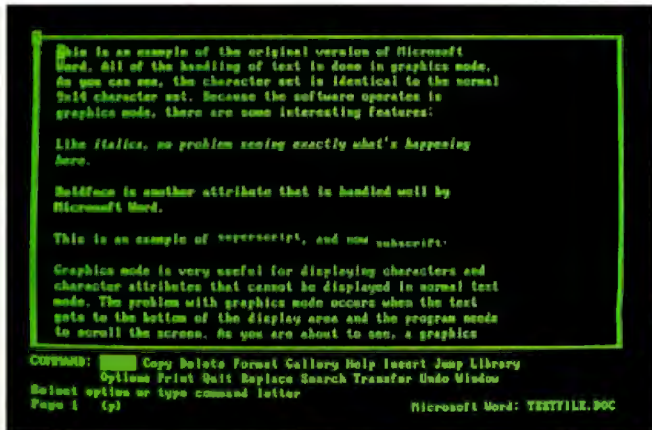

*Microsoft Word in RamFont mode: italics, boldface and small caps—plus speed and lots of it, at last.*

burn rubber with its word processor.

### The revealed Word.

Speaking of word processors, remember a couple of pages ago how we said they would be forever changed? Well, the change has already begun.

For example, the Hercules Graphics Card Plus with RamFont makes Microsoft® Word a whole new program.

Suddenly the italics, boldface, superscripts and subscripts scroll superfast. Which means you don't have to twiddle your thumbs waiting for the screen to catch up with your fingers.

### More to come.

As time goes by, more and more major programs will take advantage

of the extraordinary capabilities of RamFont.

Which gives you two choices.

You can buy a Hercules Graphics Card Plus and look forward to getting your socks knocked off.

Or you can buy another card and watch while technology leaves you and your socks behind.

To help you make up your mind, we've prepared a little surprise for you on the next page.

Just make sure you're sitting down.



# \$299.

Shocked?

We thought you'd be.

Imagine, the new Hercules Graphics Card Plus with the power of RamFont plus everything that made the original Hercules Graphics Card the monochrome standard.

At about half the old price.

Now that's progress.

Call 1-800-532-0600 ext. 202 (in Canada call 1-800-323-0601 ext. 200) for the name of an Authorized Hercules Dealer near you and we'll rush you a free info kit.

# Hercules.<sup>TM</sup> We're strong on graphics.

Address: 2550 Ninth St., Berkeley, CA 94710 Ph: 415 540-6000 Telex: 754063

Trademarks/Owners: IBM/IBM; Macintosh/Apple; Lotus, 1-2-3, Symphony/Lotus; Microsoft/Microsoft; Framework II/Ashton-Tate; Hercules, RamFont, FontMan/Hercules.

# UNIX AND THE MC68000

BY ANDREW L. ROOD, ROBERT C. CLINE, AND JON A. BREWSTER

## *A software perspective on the MC68000 CPU architecture and UNIX compatibility*

THE MOTOROLA MC68000 CPU architecture is well suited to UNIX implementation; its linear, 32-bit addressing simplifies the system programmer's task by allowing direct access to the entire memory address space at all times. The 68000's dual-state architecture also maps conveniently into the UNIX user and kernel modes. The CPU TRAP instruction provides a disciplined way to move from user to supervisor state during a kernel call, and the RTE (return from exception) instruction simplifies the return from supervisor to user state.

The MC68000 architecture provides a powerful yet simple interrupt organization that includes seven levels of interrupt priority. The multiple priority levels are used in UNIX implementations to help organize the kernel device-driver code in an environment comprised of high-speed mass storage devices and low-speed user I/O devices (terminals).

I/O devices are used in a memory-mapped manner rather than having a set of I/O-specific instructions. This allows the UNIX implementer to write device drivers in a high-level language, manipulating I/O devices as though

they were memory-resident data structures.

### **MC68000 ARCHITECTURE OVERVIEW**

In this article, we use the programmer's model rather than the hardware implementation when discussing the MC68000 CPU architecture. The MC68000 is a general-register processor; the CPU incorporates a number of internal registers that can be loaded from main memory, manipulated, and stored in main memory. This is different from a single-accumulator CPU such as the Intel 80286, where most operations happen in one register (the accumulator), or a stack-oriented machine such as the Hewlett-Packard 3000, where all operations occur on the stack. (See figure 1 for a description of the registers.)

Actually, the program counter, stack pointers, and status registers are not considered general registers. The remaining registers are broken into two types, address registers and data registers. Each type has a set of dedicated instructions that enrich its general capability. For example, data registers can handle byte (8-bit), word (16-bit), and long word (32-bit) data.

The address registers can be used as software stack pointers and are intended for address calculations.

There are two distinct CPU stack registers (see figure 1), one for each state, and a small set of privileged instructions whose operation is state-dependent. If a user program attempts to execute a privileged instruction, a trap will occur so that the

*(continued)*

*Andrew L. Rood received a B.S. in mathematics from Stanford University and an M.S. in computer science from Oregon State University. He is a Software Research and Development Project Manager at Hewlett-Packard's Corvallis Workstation Operation.*

*Robert C. Cline earned a B.S. in mathematics from the University of Massachusetts and an M.S. in computer science from Indiana University. He is a Software Research and Development Engineer at Hewlett-Packard's Corvallis Workstation Operation.*

*Jon A. Brewster, who holds a B.S.E.E. degree from Oregon State University, is a software Research and Development Manager at Hewlett-Packard's Corvallis Workstation Operation.*

*The authors can be contacted at Hewlett-Packard, Corvallis Workstation Operation, 1000 Northeast Circle Blvd., Corvallis, OR 97330.*

kernel can arbitrate the violation. The CPU architecture provides vectored interrupts and seven levels of interrupt priority. (Note that access to the interrupt-level mask is a privileged facility.) The MC68000 architecture provides no I/O instructions. I/O is presumed to be performed in a memory-mapped manner using the normal LOAD and STORE instructions.

**A QUICK UNIX SUMMARY**

The UNIX system is a multitasking operating system designed for software development. It has become popular because of its simplicity of design and the ease with which it can be ported to a variety of machine architectures. The simplicity and portability are due mostly to the fact that 90 percent of the system's code is written in the high-level language C.

UNIX is a process-oriented system. The management of processes in the UNIX system is fairly simple. Each runnable process (program) is placed in a list. These processes are ordered by a priority system. Each process shares the CPU via a time-slicing, round-robin, scheduling algorithm where the process with the highest priority gets to use the CPU first. The time slicing is normally governed by a periodic interrupt that occurs each time a system clock ticks.

The UNIX system is oriented around two states of operation: operating system, or kernel, state, and user state.

All driver activity, process management activity, and low-level file management activity occur in the kernel state. Processes normally run in the user state. Each time a kernel intrinsic (operating system request) is called by a process, a state transition changes the user state to the kernel state. When the intrinsic has finished, the state is changed back to the user state. This provides some insulation of user processes from the system internals.

The memory management primitives in the UNIX system make no assumptions about the sophistication of memory management hardware available to them. UNIX systems have been implemented with no memory management and with sophisticated, paged, segmented systems. Even a memory protection scheme can be dispensed with if the system being designed is to be just an applications engine.

Due to the multiprocessing nature of a UNIX operating system, some sort of memory protection is recommended if you intend to do software development on the machine. This is to prevent experimental software from writing over memory occupied by its neighboring processes and destroying them. It is entirely up to the implementer to say how much memory management power is required. Such a decision boils down to the trade-off between price, perfor-

mance, and design schedule.

The I/O system of UNIX is designed around two generic device models: the block device and the character device. Block devices are those, such as disk and tape devices, that treat data in blocks. Character devices are those, such as data terminals, that handle data one character at a time. Strict conventions exist in the system as to how devices of each type are to be accessed. Such a well-defined interface makes driver writing easier. Because driver writing makes up the bulk of the work for most operating system ports, the device model of the UNIX operating system makes porting less trying than with many other less organized systems.

**LINEAR ADDRESS SPACE**

The MC68000 family of processors has a large linear address space in which each memory address is 32 bits long. This allows up to 4 gigabytes of memory to be directly addressed. Since only 24 address lines are brought out of the MC68000 and MC68010 processors, only 16 megabytes are accessible in those members of the family. (The MC68020 presents all 32 bits of address.) This linear addressing scheme sharply contrasts with segmented addressing schemes, which have a small local address range and a way to relocate the local address range within a larger global addressing range.

Linear addressing may be the single most important feature of the MC68000 processor family. It greatly simplifies the task of implementing an operating system and makes large, complex working sets of segment pointers for managing process images unnecessary. (It is also the single biggest difference between the MC68000 and the Intel 80286 CPUs.)

Theoretically, a system with the address reach of a segmented architecture is as powerful as the MC68000 with its large linear reach. However, it is easier for programmers to use the linear addressing scheme (a programmer in this context is an assembly language programmer or a compiler writer).

The reasons to write in assembly  
*(continued)*

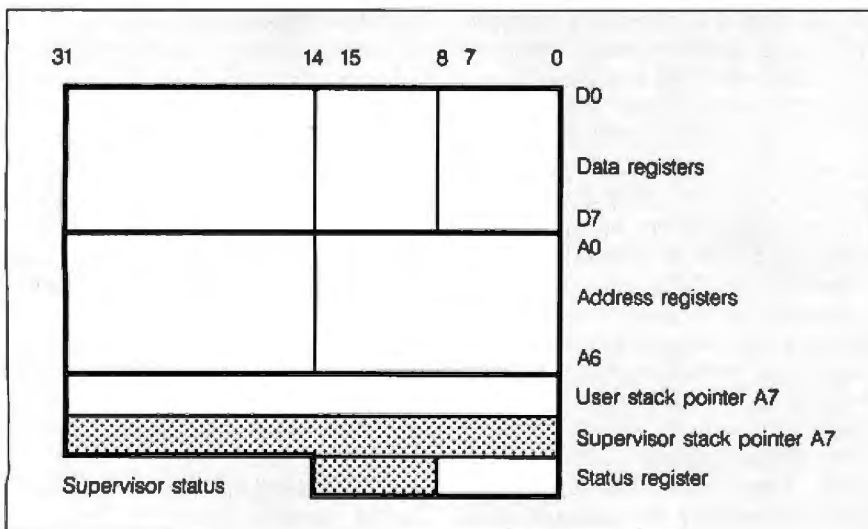

Figure 1: The MC68000 CPU register model.



# Put **RUN/CPM™** in your PC today and run 50,000 programs that you couldn't run yesterday!

## RUN/CPM V-20/30 CP/M Emulator

RUN/CPM is a revolutionary new product which combines software and hardware to allow your PC to run 1,000's of programs written for the CP/M80 operating system. For years, popular 8 bit computers such as "Kaypro", "Osborne", and "Morrow" have relied on this vast library of high quality, inexpensive software, which can now be accessed by your PC. A simple replacement of your PC's 8088 or 8086 microprocessor with a dual 8/16 bit N.E.C. V-20 or V-30 microprocessor creates a system capable of running both CP/M80, and MS-DOS/PC-DOS software. In addition to adding 8 bit CP/M compatibility, your PC's overall performance will improve by up to 30% as a result of the speedup characteristics of the V-20 and V-30 microprocessors. Running CP/M software directly from CP/M disks is easy thanks to RUN/CPM's disk emulation feature, which will allow your PC's floppy drives to directly READ, WRITE, and FORMAT over 175 different CP/M disk formats! You will also be able to run CP/M programs in full color, from a hard disk or RAM disk, and you can even run MS-DOS background programs such as Borland's "Sidekick" on top of CP/M programs! Add pop-up windows, terminal emulation, and help screens and it is easy to see why RUN/CPM is fast becoming the de-facto standard in CP/M emulation software.

## READ/CPM CP/M Disk Emulation

READ/CPM adds CP/M disk compatibility to your PC, XT, or AT. Now your PC can directly READ, WRITE, and FORMAT over 175 different CP/M disks using DOS commands such as "COPY", "TYPE", "DIR", etc. READ/CPM supports a variety of disk drives including 5 1/4", 3 1/2", and with the proper disk controller even supports 8" disk drives. READ/CPM is the solution to your disk compatibility problems.

**RUN/CPM™**  
ONLY \$99.95\*

Includes 20 FREE CP/M Programs

**READ/CPM™**  
ONLY \$49.95

OSBORNE, T...  
HEATH  
CRO  
OSBORNE  
HEATH  
CRO  
OSBORNE  
HEATH

MORROW, CRO  
QUME, KA  
OSBORNE  
MORROW  
CO, QUME

The RUN/CPM Z-80 co-processor gives you all of the incredible features of RUN/CPM, plus the advantage of the full Z-80 instruction set at a price you can afford. Never before has it been easier to add Z-80 compatibility to your PC, XT, or AT. The RUN/CPM Z80 co-processor board comes complete with 64K of memory, a 5Mhz clock, and of course the incredible RUN/CPM emulation software. Plug this card into one of your PC's slots and within minutes you will be running the most powerful CP/M software available, including the most popular assemblers, compilers, debuggers, and wide variety of application programs such as word processors and spreadsheets. Our ISIS-II emulation option will even allow you to run "Intel" development languages on your PC, or AT. If you want to step up to the ultimate in high speed Z80 processing, then check out our RUN/CPM Z80-H full size co-processor available for only \$499.95. Running in excess of 9mhz with 128 K memory on board, this co-processor virtually blows away the competition! Both the RUN/CPM Z80 & Z80-H co-processors come with the RUN/CPM emulator software and are backed by our 30 day money back guarantee.

Here is what the reviewers are saying about "RUN/CPM."

"It's an excellent program backed by a knowledgeable company."

ROBERT ATHEY  
Micro Times

"... the most powerful of all the emulators reviewed."

TED DRUDE  
Computer Shopper

## Run CP/M® Z80 for the incredible price of \$199.95

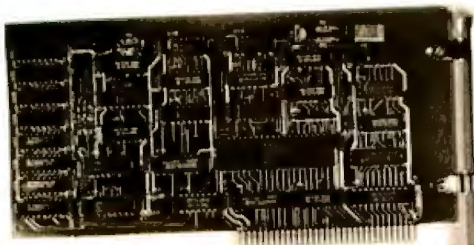

\* Requires V-20 or V-30 microprocessor

RUN/CPM is a registered trademark of Micro Interfaces Corporation. Sidekick is a registered trademark of Borland International. Kaypro is a registered trademark of the Kaypro Corporation; Intel is a registered trademark of the Intel Corporation; CP/M is a registered trademark of Digital Research; Z80 is a registered trademark of the Zilog Corporation; ISIS-II & ISIS-III are registered trademarks of the Intel Corporation.

## I WANT TO ORDER!

To order by phone, or for a dealer nearest you,  
**CALL (800) 637-7226**  
Technical info call (305) 823-8088

| Co-proc | Product                                       | Price    | Total |
|---------|-----------------------------------------------|----------|-------|
| ___     | RUN/CPM requires V-20/30                      | \$ 99.95 | ___   |
| ___     | RUN/CPM Z80 (Board 5mhz)                      | \$189.95 | ___   |
| ___     | RUN/CPM Z80H (Board 9mhz)                     | \$499.95 | ___   |
| ___     | READ/CPM                                      | \$ 49.95 | ___   |
| ___     | V-20 5mhz - Replaces 8088 up to 8 Mhz         | \$ 24.95 | ___   |
| ___     | V-20 5mhz - Replaces 8088 up to 5 Mhz         | \$ 14.95 | ___   |
| ___     | V-30 8mhz - Replaces 8088 up to 8 Mhz         | \$ 29.95 | ___   |
| ___     | V-30 10mhz - Replaces 8088 up to 10 Mhz (NEW) | \$ 49.95 | ___   |
| ___     | MICRUN80 (UDI) requires V-20/30               | \$450.00 | ___   |
| ___     | MICRUN80 5 Mhz Z80 Board                      | \$595.00 | ___   |
| ___     | MICRUN80 9 Mhz Z80 Board                      | \$995.00 | ___   |
| ___     | MICRUN86 (UDI)                                | \$450.00 | ___   |

BB  
Add \$5.00 shipping charge per order except for V-20/30 chips which include shipping. International orders add \$10.00

Payment: VISA MC MONEY ORDER C.O.D. Add \$3.00 airmail

Credit Card Expiration \_\_\_\_\_ / \_\_\_\_\_  
Card # \_\_\_\_\_  
Name \_\_\_\_\_  
Address \_\_\_\_\_  
City \_\_\_\_\_ State \_\_\_\_\_  
Zip \_\_\_\_\_ Tel \_\_\_\_\_ / \_\_\_\_\_

30 DAY MONEY BACK GUARANTEE ON ALL PRODUCTS. SOFTWARE IS NOT COPY PROTECTED.

**Micro Interfaces Corporation**  
6824 N.W. 169th Street, Miami, Florida 33015  
(305) 823-8088 — Telex 5106004680 MICRO INTER CO  
OEM, VAR, Dealers, Inquiries Invited

## RUN INTEL SOFTWARE ON IBM PC'S

Transform an IBM PC, XT, AT, or compatible into a totally integrated Intel Micro Development System, capable of running 8 bit ISIS-II, and 16 bit ISIS-III (UDI) software while remaining 100% MS-DOS compatible. MICRUN 80 and MICRUN 86 are Universal Development Interfaces which will allow you to increase your development capabilities with faster, more reliable and affordable PC based work stations. The MICRUN80 (UDI) utilizes the N.E.C. V-20/30 microprocessor to execute 8 bit Intel software on a PC, or XT. 2 to 3 times faster than an Intel MDS! For ultra fast execution speed, our Z80 co-processor version of MICRUN 80 runs in excess of 9 Mhz and is PC "AT" compatible. The MICRUN86 (UDI) is the perfect solution for running 16 bit ISIS-III software on PC's or XT's, and AT's and does not require any additional hardware. Both MICRUN80, and MICRUN86 come complete with a full featured communication program for transferring Intel software to your PC or choose our B" compatibility option, which will allow you to connect an 8" disk drive to your PC and directly access single density 8" Intel format disks. Micro Interfaces Corporation has brought the power of Intel development to the PC, and in doing so provided you with an affordable alternative to the high cost of Intel development. To order, or obtain more information call the toll free number listed above or refer to the order coupon.

language are varied, but it often comes down to speed, space optimization, and minimal complexity. Keeping the compiler writer's job easy has paid off in two ways: first, high-quality compilers were available early in the MC68000 life cycle; second, the compilers have been of high enough quality to reduce the amount of assembly language programming.

One drawback of linear addressing is that the code density of the actual machine instructions may suffer from the presence of many long addresses (the top byte of which is nearly always 0). This problem is alleviated somewhat by short (16-bit) relative addressing modes. However, UNIX implementations prefer separate instruction and data areas, and, consequently, the relative addressing modes are used infrequently.

Address space management becomes easy with a large, linear address space. The compiler needs to be concerned with only three spaces: code, data, and stack. Also, the operating system can quickly allocate and deallocate any number of easily accessible memory fragments. Very large processes such as those for expert systems can be designed easily because you don't have to be concerned about the overhead involved in passing control between routines

in different code segments.

The same can be said for the use of large data structures. UNIX includes many application programs whose memory image exceeds 1 megabyte and that use individual data structures several hundred kilobytes in size. There is also a class of recursive programs that are heavy stack users. A machine such as the 80286 with a 64K-byte stack limit can be a real disadvantage in this type of application.

Another nice feature of a large address space is that parts of it can be easily reserved for other functions. An example is mapping I/O device interfaces into memory. Many megabytes of address space may be allocated for I/O without impacting other needs. (Segmented-architecture machines typically provide a separate I/O address space to keep the intersegment communication to a minimum.) Figure 2 shows an example of address allocation.

**DUAL PROCESSOR STATES**

The MC68000 is a dual-state processor. The processor has two stack registers, one used while in the supervisor state and the other used while in the user state. When an instruction is executed that changes the CPU state, the stack is automatically

changed as well. The CPU provides status lines coming off-chip to allow support chips (such as an external memory management unit) to determine the current CPU state.

The state of the CPU can be determined by reading the supervisor state bit in the CPU status register. There is a small set of privileged instructions, including STOP, RESET, RTE, MOVE to SR, AND, EOR, OR, and MOVE (word) IMMEDIATE to SR, that operate differently in user state than in supervisor state. In user state they cause a privilege violation and associated CPU fault. In supervisor state they modify the CPU as indicated. Note that any instruction that explicitly sets the supervisor portion of the status register (SR) is a privileged instruction.

Interrupts are dispatched in supervisor state even if the CPU was processing in user state when the interrupt occurred.

**UNIX USE OF DUAL STATES**

In UNIX a process is a user task that has resources allocated to it, including main memory, CPU time, I/O processing, and space in system tables. It is by time-slicing processes that UNIX performs multitasking.

Figure 3 shows a memory-oriented picture of a process. Normal processes have a kernel and user side, each of which contains code, data, and stack. Process 0, the original process, acts as the scheduler in the system. Process 0 is unique in that it has no user side, only a kernel side.

A zombie process is a process that has no user side and no kernel side; in fact, a zombie process has no memory allocated to it at all. It is simply an entry in the process table waiting to be deallocated.

UNIX kernel code normally executes in the supervisor state of the CPU, and the UNIX user code normally executes in the user state of the CPU. In the UNIX framework there is a distinguished user called the superuser. The concept of a superuser should not be confused with the supervisor or kernel portion of a process. A superuser process is a normal process from the CPU perspective.

(continued)

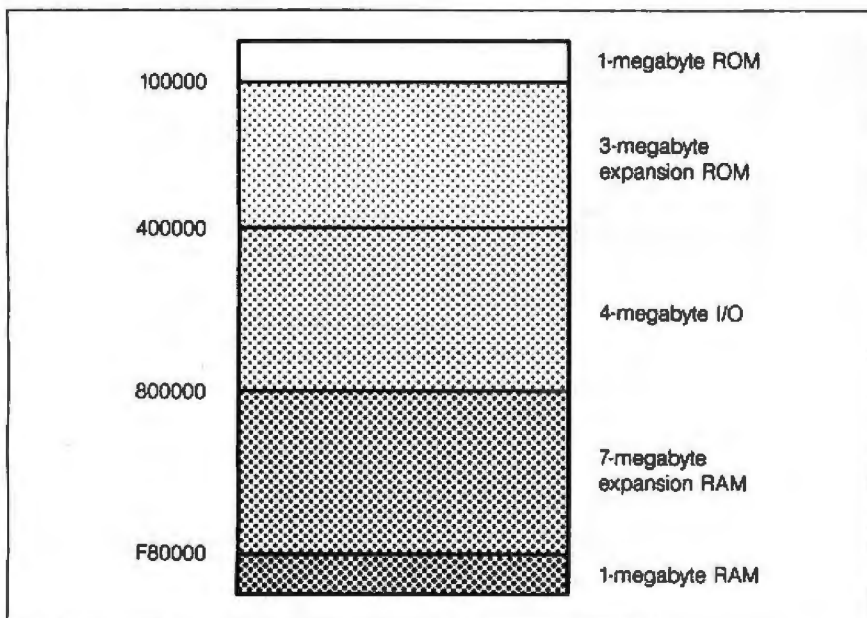

Figure 2: A typical MC68000 address allocation scheme.

If you have not had a trial subscription in the last two years, we invite you now to...

# RECEIVE VALUE LINE FOR ONLY \$55

This Special Introductory Trial offer brings you the COMPLETE Value Line Survey for 10 weeks at a 34% saving. And it's tax-deductible.

## You will receive:

- two strong binders in which are already filed the most recent full-page reports on each of 1700 stocks regularly covered by The Value Line Investment Survey.

- all new full-page stock reports to be issued in the next ten weeks (about 130 new reports each week)—updating and replacing the original reports in your binder.

- the next ten editions of Selection & Opinion, presenting Value Line's current view of the stock market and the economy, plus specific stocks to consider now.

- and as a bonus the Subscriber's Guide by Arnold Bernhard, Value Line's Research Chairman—explains how you can apply thousands of hours of professional research by our 100-strong staff to your own portfolio by focusing on only two unequivocal Value Line ranks—one for timeliness (performance in the next twelve months)—one for safety.

We believe Value Line offers the biggest return for the smallest investment in time. In 10 minutes, the Value Line will give you on one page more useful information about a company's past performance, current status and future prospects than any other published source we know of.

## Money Back Guarantee

If you find that The Value Line Service is not all that you expected it to be, you may return the material we send you within 30 days for a full refund of your fee.

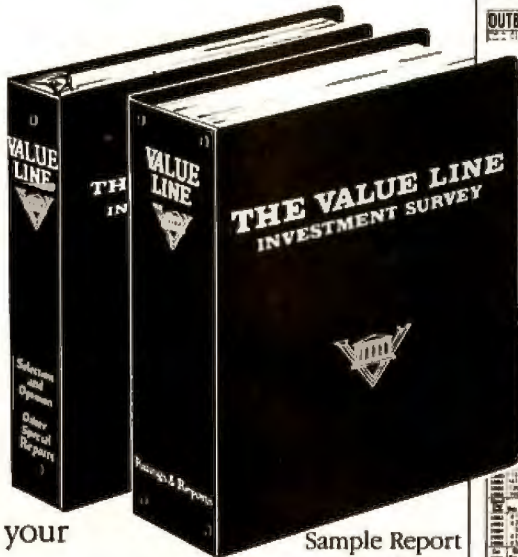

Sample Report reduced from regular 8 1/2" x 11" size.

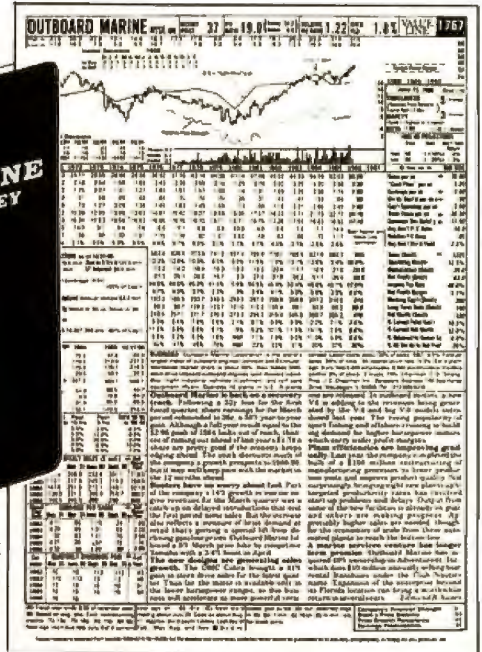

Call toll free (24 hrs. a day 7 days a week) Ext. #281  
1-800-633-2252 Master Card, American Express or Visa

## THE VALUE LINE INVESTMENT SURVEY

711 Third Ave., New York, N.Y. 10017

Dept  
890D01

### INTRODUCTORY OFFER

Begin my 10-week trial subscription for \$55 to The Value Line Survey (limited once to any household every two years) and send me these two bonuses:

- (1) the Subscriber's Guide
- (2) two strong binders with the most recent full page reports on all 1700 stocks.

### ONE YEAR SUBSCRIPTION

Begin my 1-year (52 issues) subscription for \$425 and send me these two bonuses:

- (1) the Subscriber's Guide
- (2) two strong binders with the most recent full page reports on all 1700 stocks.
- (3) a pocket-size CREDIT CARD LCD CALCULATOR

There are no restrictions with this annual subscription.

My payment is enclosed.

Please charge to:  American Exp.  MasterCard  Visa

Account # \_\_\_\_\_ Expiration Date \_\_\_\_\_

This subscription is tax-deductible and non-assignable.

(N.Y. residents add sales tax.) Foreign rates upon request.

Allow 4 weeks for delivery.

Signature \_\_\_\_\_

Name \_\_\_\_\_

Address \_\_\_\_\_ No. \_\_\_\_\_

City \_\_\_\_\_ State \_\_\_\_\_ Zip \_\_\_\_\_

but one that is distinguished by the superuser process identification number (pid). The pid is checked by the operating system during certain critical operations, for example, mounting new file-system devices.

Only superuser processes are allowed to perform these operations. Any process (even those belonging to the superuser) has both a kernel side, which executes in the supervisor state of the CPU, and a user side, which executes in the CPU's user state.

In contrast to the dual privilege levels associated with UNIX, the 80286 processor provides four levels of privilege, each protected from the levels above it. For more sophisticated

operating systems than UNIX this four-state CPU can provide a good implementation vehicle. In the UNIX environment it is not immediately clear that four CPU states are required or even useful.

**TRAP DISCIPLINE**

The TRAP instruction can be used to implement kernel calls and the associated state change from user to supervisor. A matching RTE instruction is used to return to the user state. The register environment can be used to pass information to the kernel, such as the type of kernel call being made. (The registers must be saved explicitly by the kernel as desired.)

The kernel call is a frequently used operation, but typically a costly one. Overhead involved in trapping to the kernel includes TRAP and RTE instructions, register state save and restore, kernel call decode and dispatch, and kernel call implementation. See the text boxes "The User View of a Kernel Call Using TRAP," below, and "The Kernel View of a Kernel Call" on page 186.

The 80286 processor implements a more complex state-transition mechanism using call gates to allow procedures to transfer control to the same or more privileged levels. This scheme is more complex than the MC68000 implementation of CPU state transition, and it is exactly this added complexity that makes UNIX implementation with the 80286 more difficult.

**UNIX CONTEXT SHIFTING**

Context shifting in the UNIX system is the operation of putting the currently executing process to sleep and resuming the execution of some other process. Because of the process orientation of UNIX, and its time-slicing algorithms for scheduling, context shifting is frequently performed.

Context shifting occurs either at the end of a kernel call or in response to some interrupt during user state processing (e.g., the heartbeat interrupt from the system clock). Context-shift overhead includes saving the currently executing process state, selecting a new process to run, and restoring the state of the new process. (See the text boxes "CPU State Save in a Context Shift" on page 188 and "CPU State Resume in a Context Shift" on page 190.)

The 80286 provides a complex task environment that allows high-performance context shifting between tasks. As with the privilege architecture of the 80286, the task separation mechanism is more powerful than is required in a UNIX implementation.

**KERNEL VIEW OF CONTEXT SHIFTING**

The kernel view of context shifting involves two functions: sleep and switch (see figure 4). Sleep is a function that,

*(continued)*

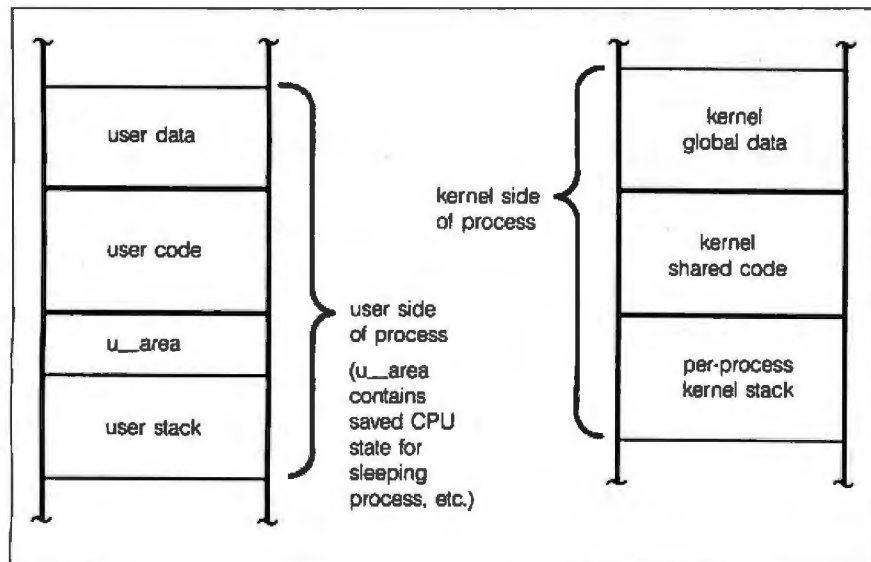

Figure 3: A graphic description of a process, showing user and kernel elements.

**THE USER VIEW OF A KERNEL CALL USING TRAP**

```
syscall(callno,arg1,arg2)
```

Perform the kernel call indicated by callno. Send arg1 and arg2 (typically pointers) to the kernel as part of the call.

```
syscall move.l 4(sp),d0 ; Get the kernel call number.
 move.l 8(sp),d1 ; Get the first argument (arg1).
 move.l 12(sp),d2 ; Get the second argument from
 ; the stack.
```

```
trap #1 ; Trap to supervisor state.
```

```
rts
```

# From micro to mainframe, Casio's got the hardware for your software.



At first glance, it may look like an ordinary calculator, but the Casio solar CM-100 is anything but. It's an extraordinary software tool that's as useful in programming an Apple™ as it is a mainframe IBM™.

The key to the CM-100's incredible flexibility is Casio's adjustable bit-size selector which can be set to suit any size computer up to 32 bits. And its block display which can, by scrolling blocks of 8 digits at a time, display up to a 32 bit word.

But there's much more to this pocket-size powerhouse. It can do base conversions from binary/octal/decimal/hexadecimal modes and can store in its memory numbers in any base. It also has Shift, Rotate, Arithmetic Shift and Boolean functions that include AND, OR, XOR and NOT.

Perhaps what is most extraordinary about the CM-100 though, is not how much it can do, but how little it costs to do it. The CM-100 is the only calculator that'll let you do all your software figuring for less

than you'd figure to pay for an average (\$25.00) textbook.

The more you work with computers—whatever their size—the more you need a CM-100. Whether you're a student or professional, it's the one piece of hardware that will make designing your software easier. For more information, call 1 (800) 553-3338 X34.

Apple and IBM are trademarks of the Apple and IBM Corporations.

**CASIO**  
Where miracles never cease

Casio, Inc. Consumer Products Division: 15 Gardner Road, Fairfield, N.J. 07006

# PC-SIG Library

Keeps on growing...

New disks recently added to our library of user-supported and public domain software for the PC:

- #471 **Present V5.1** Make your own slide shows for business or home using your color monitor.
- #477 **Name Gram/Break Down/Phone Word** Do anagrams, find what words your phone number makes.
- #480 **PC-Outline** Outline and organize information, much like Thinktank.
- #481 **Still River Shell** Makes DOS easy to use.
- #483 **Mail Master** Keeps track of multiple lists, sorts and prints by city, state, zip and name.
- #485 **Icon Maker and FX-Matrix** Makes graphics characters like the MAC for your screen and you can paint them on your EPSON printer.
- #487 **Reflex Point** An action game modeled after the ROBOTECH cartoon series.
- #492 **Nutrient** Tracks your diet and its calorie/nutrient value.
- #494, 495, 496 **The World Digitized** Find over 100,000 different locations in the world and display them on screen.
- #498 **DOS-a-Matic** Load different programs and manipulate them with single keystrokes.
- #499 **PROCOMM** Communications with XMODEM, KERMIT, ASCII protocols, supports IBM-3101, DEC VT52/1000, ADM-3 and ANSI.
- #501 & 502 **Saleseye** Tracks prospects, leads and memos and prints letters with that information.
- #503 **Reliance Mailing List** Keeps track of multiple lists, sorts and prints by specific group—good for custom mailing.
- #506 **Bibliography of Business Ethics and Moral Values** The regularly updated master bibliography for those doing papers and research involving business ethics.
- #507 **PC-Sprint** Software and instruction on how to cheaply speed up your system 2–3 times.
- #508 & 509 **Statistics Tools** Factor experiments, "FORGET-IT" plots, simultaneous confidence intervals, randomization tests, expected mean squares.
- #510 **Visible PASCAL Compiler** Learn to program PASCAL and watch the internal functions of PASCAL as it runs.
- #511 **Turbo Sprites and Animation** Create, maintain and animate your own images in TURBO PASCAL.

## RECENT DISK UPDATES

- # 5 **PC-File** Ver. 4
- # 78 **PC-Write** Ver. 2.6/1
- #124 **Extended Batch** Ver. 2.04a
- #199 **PC-Calc** Ver. 3
- #212, 334 **RBBS-PC** (2 disks) Ver. 3.7
- #388 **100 Letters** Ver. 1.1
- #393 **Checkbook** Ver. 2
- #395 **Home Inventory** Ver. 2
- #397 **Checkbook Program** Ver. 3.31
- #402 **IBM 370 Cross Assembler** Ver. 1.1
- #403 **Computer Tutor** Ver. 4.2
- #417 **ADA Prolog** Ver. 1.90
- #449 **Gaga** Vers. 1.06
- #468 **CPA Ledger** Ver. 1.1
- 350-page directory (disks 1-300) ..... \$8.95
- Printed Supplement (disks 301-454) ..... \$3.95
- 1 yr. PC-SIG Membership (\$35 foreign) ..... \$20  
Includes printed directory, supplement, bimonthly magazine

## SPECIAL

Any 5 Disks plus 1-Year Membership \$39

Disks are \$6 each. Add \$4 postage and handling (\$10 foreign)—CA residents add state sales tax.

Total Enclosed \$\_\_\_\_, by  Check  VISA  MC

Card No. \_\_\_\_\_

Exp. date \_\_\_\_\_ Phone \_\_\_\_\_

Name \_\_\_\_\_

Address \_\_\_\_\_

City \_\_\_\_\_ State \_\_\_\_\_ Zip \_\_\_\_\_



To order, call: **800-245-6717**  
in CA: **800-222-2996**  
For technical questions or  
local orders: **(408) 730-9291**  
1030-D East Duane Avenue  
Sunnyvale, CA 94086 **213**

## UNIX AND THE MC68000

### THE KERNEL VIEW OF A KERNEL CALL

trap

The address of this routine is placed in memory at the address of vector 33 (the TRAP 1 vector); that is, at memory location 132 decimal. When the TRAP #1 instruction is executed, the CPU generates an internal exception and automatically transfers to this routine in supervisor state. The user return address and status register are saved on the supervisor stack.

On entry it is presumed that the registers contain:

- d0 ... the kernel call number
- d1 ... first argument to the kernel call
- d2 ... second argument to the kernel call

Typically the arguments are pointers into the user's data space.

```

trap movem.l #0xFFFE, -(sp) ; Save registers d0-d7 and a0-a6.
 move.l usp,a0
 move.l a0, -(sp) ; Save the user stack pointer.

 move.l d0, -(sp)
 move.l d1, -(sp)
 move.l d2, -(sp) ; Push the incoming parameters so
 ; a high-level language routine
 ; can access them using standard
 ; compiler parameter passing
 ; techniques.

 jsr C-trap ; Call a C handler to perform
 ; the desired kernel call.

```

After the kernel call, this process may be context-shifted out. We have saved the user stack pointer with the register set so that we can do a complete restore later after some other user process has run.

```

 add.l #12,sp ; Strip the parameters off
 ; the stack.

 move.l (sp)+,a0 ; Get the saved user stack
 ; pointer.

 move.l a0,usp ; Restore user stack pointer.

 movem.l +(sp),#0x7FFF ; Restore registers a6-a0 and
 ; d7-d0.

 rte ; Return from exception back
 ; to the user, restoring the
 ; CPU status and returning
 ; to user state of the CPU.

```

(continued)

# Osborne/McGraw-Hill Computer Books

*next generation*

## Your Language Library

### 68000 Assembly Language Programming, Second Edition

by Lance A. Leventhal, Doug Hawkins, Gerry Kane, and William D. Cramer

This classic on assembly language programming for the 68000 microprocessor has been revised to provide complete coverage of the entire 68000 family, including the 68010 and 68020 chips.

\$19.95, Order #0-07-881232-1, 625 pp., 6 3/4" x 9 1/4"



### 68000 Microprocessor Handbook, Second Edition

by William D. Cramer and Gerry Kane

For serious programmers and hardware designers, here's an extensive handbook on the 68000 microprocessor, now revised to cover the 68008, 68010, 68012, and 68020 chips. Includes addressing modes, signal conventions, instruction sets, exception processing logic, timing, and bus operations.

\$14.95, Order #0-07-881205-4, 176 pp., 7 1/2" x 9 1/4"

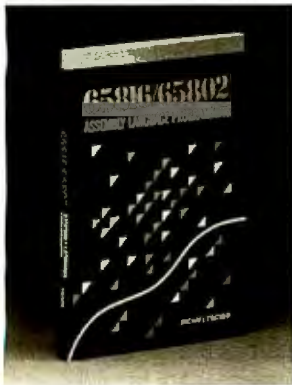

### 65816/65802 Assembly Language Programming

by Michael Fischer

Both a tutorial and lasting reference, this recent addition to Osborne's Assembly Language Programming series examines instruction sets, arithmetic operations, loops, and code conversion, sorting and searching, I/O and interrupts, subroutines, and more. Well-organized, complete and illustrated.

\$19.95, Order #0-07-881235-6, 425 pp., 6 3/4" x 9 1/4"

### 80386/80286 Assembly Language Programming

by William H. Murray, III and Chris H. Pappas

Take full advantage of the unique design of Intel's newly acclaimed 80386 chip and 80286 microprocessor, as well as the 80387/80287 coprocessors with this comprehensive guide. Many practical programming examples and illustrated techniques enhance this authoritative resource.

\$19.95, Order #0-07-881217-8, 400 pp., 6 3/4" x 9 1/4"

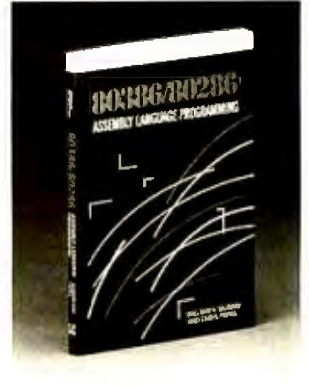

- Osborne/McGraw-Hill books are available at bookstores and computer stores everywhere.
- To order by mail, complete the coupon and send it to:

Osborne/McGraw-Hill  
P.O. Box 400  
Hightstown, NJ, 08520

- All orders must be prepaid and should include local tax.
- Checks, money orders, VISA and MasterCard are acceptable for payment. No postage or handling charges are required.
- Books will be shipped via UPS. Allow 4-6 weeks for delivery. Books will not be delivered to post office boxes.

This order is subject to acceptance by McGraw-Hill. Offer is good only in the U.S.A.

NAME \_\_\_\_\_

ADDRESS \_\_\_\_\_  
(Please, no PO Box)  
CITY \_\_\_\_\_

STATE \_\_\_\_\_ ZIP \_\_\_\_\_

INDICATE METHOD OF PAYMENT  CHECK/MONEY ORDER  
 VISA/EXP. DATE \_\_\_\_\_  MASTERCARD/EXP. DATE \_\_\_\_\_

CARD # \_\_\_\_\_

SIGNATURE \_\_\_\_\_

QTY \_\_\_\_\_ ORDER # \_\_\_\_\_ PRICE \_\_\_\_\_

\_\_\_\_\_

\_\_\_\_\_

Osborne/McGraw-Hill SUBTOTAL \_\_\_\_\_

PO Box 400 TAX \_\_\_\_\_

Hightstown, NJ 08520 TOTAL \_\_\_\_\_



when called, returns after some interval, during which other processes may have executed. Switch is the function that actually performs the selection of a new process and transfers control

to that process.

The kernel also provides a wakeup function. Wakeup is used to make a process (which has been sleeping, waiting for some external event) ready

to run. This is typically after the event has occurred.

Figure 4 shows sleep in a context switch. Sleep calls switch, which in turn performs two operations; it saves the current process's state and then selects the next process to run and runs it. Switch uses two critical functions to perform this: save and resume. Save is a function that, when called once, returns twice. Resume is a function that never returns. Resume actually transfers to some other save, acting as the second return for that save call.

Figure 5 shows an example of control flow from process A to process B and back again to process A. The execution of a sleep call in process A eventually calls switch, which calls save. The save call first returns a 0 value. This call also saves the state of process A for later resumption. Control after the first return from the save call continues into a resume call. This transfers control to process B. Later, process B will itself execute a resume call that transfers control back to process A. This resume (from B) acts as the second return of the save call in process A. This time the save returns the value 1, which causes switch to return to the sleep call, which returns to the user process.

Save's primary responsibility is to save the CPU state so that it can be included as part of the saved process image. The image can later be resumed.

**UNIX FORK PARADIGM**

In UNIX all processes are created by making copies of existing processes, except, of course, the first process, which is handcrafted by the kernel during system boot-up. This process then splits in two using a fork() operation. Each child of this first process in turn can divide as many times as needed to create processes to perform all tasks desired.

To perform a new task, a child process may overlay itself with a new program image using an exec kernel call. Figure 6 shows the fork operation pictorially and demonstrates why the term fork was chosen for this operation.

**CPU STATE SAVE  
IN A CONTEXT SHIFT**

save(save-area)

The function save() saves the CPU register state in preparation for a later resume call. Registers and user stack pointer are saved in save-area[17]. This save call returns 0, indicating it is the first return from save. When resume simulates the second return from save, it will return 1.

The save-area will look like:

```

user stack ptr [16] = usp
 [15] = a7
saved registers [14] = a6
a7,a6,a5,...,a1,a0 ...
d7,d6,d5,...,d1,d0 [1] = d1
 [0] = d0
< ---- save-area

```

```

save move.w #0x2700,sr ; Go to high-priority supervisor
 ; state to prevent interrupts during
 ; this function call. This also clears
 ; the rest of the status bits.

 move.l 4(sp),a0 ; Get address of register save-area.

 movem.l #0xFFFF,(a0)+ ; Save all registers.

 move.l usp,a1 ; Get user stack pointer.

 move.l a1,(a0) ; Save the user stack pointer.

```

At this point other processing may occur, for example, the saving of other types of process description information, especially the stack image that contains the return address for this call.

Note that a1, a0, and d0 are used as working registers here although they are also saved with the rest of the registers.

```

 move.l #0x0,d0 ; The return value for this save
 ; call is 0. For this example the
 ; return value is presumed to be in
 ; d0 upon return from function call.

 move.w #0x2000,sr ; Go to low-priority supervisor
 ; state and enable interrupts.

 rts

```

(continued)



# How to tell the men from the toys.

Fully IBM™ compatible

14" easy-to-read  
tilt-and-swivel monitor

Factory installed 512K  
memory on main board

Finger-friendly 83-key  
keyboard

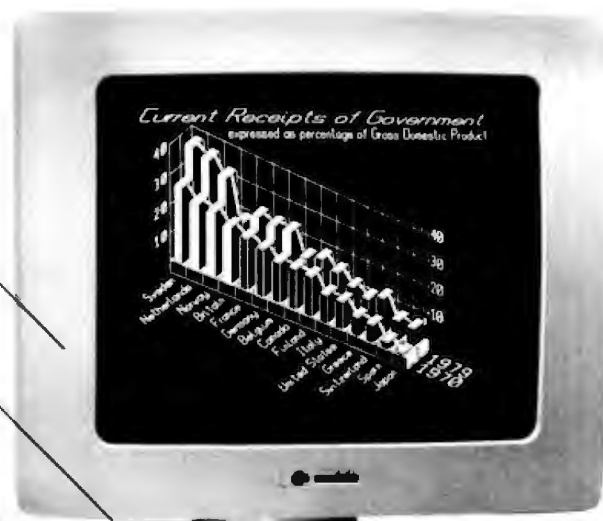

Integrated application  
software-w.p., spread-  
sheet, database and  
communications  
included

MS-DOS™ and start-up  
tutorials

FCC/UL approved

Dual 360K floppy disk  
drives

A lot of today's PC prices seem like bargains. Until you look at what's included. That's why serious business users are buying Cordata PC's. We're the company that's been the value leader in PC's for years. Compare Cordata's features at \$1495 (\$1995 with 20MB hard disk). And you'll see we're not just playing around.

Call (800) 621-6746 (in Calif.: 800-331-5867) for the name of your nearest Cordata dealer.

## Serious PC's. \$1495.

Also available in transportable model. IBM is a trademark of International Business Machines Corp.  
MS-DOS is a trademark of Microsoft, Inc.

 **cordata**

275 E. Hillcrest Drive, Thousand Oaks, CA 91360 TELEX: 650-2696270  
In Europe: Holland 030 40-18111. In Canada: (604) 964-0641

Inquiry 94

# GMX<sup>®</sup> Micro-20 68020

## Single-Board Computer

### Mainframe CPU Performance on a 5.75" x 8.8" Board

(benchmark results available on request)

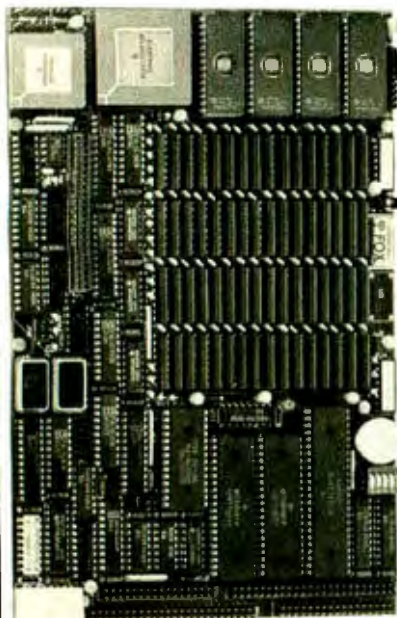

**\$2565<sup>00</sup>** 12.5 MHz Version  
Quantity Discounts Available

## Features

- 32-Bit MC68020 Processor (12.5 or 16.67 Mhz)
- MC68881 Floating-point coprocessor (optional)
- 2 Megabytes of 32-bit wide, high-speed RAM
- 4 RS-232 Serial I/O Ports (expandable to 20)
- 8-bit Parallel I/O Port ("Centronics" compatible)
- Time-of-Day Clock w/battery backup
- 16-bit I/O Expansion Bus
- Up to 256 Kbytes of 32-bit wide EPROM
- Floppy Disk Controller for two 5 1/4" drives
- SASI Intelligent Peripheral Interface (SCSI subset)
- Mounts directly on a 5 1/4" Disk Drive

## Software

### Included:

- GMX Version of Motorola's 020Bug Debugger with up/download, breakpoint, trace, single-step, and assembler/disassembler capabilities
- Comprehensive Hardware Diagnostics

### Optional:

*UNIX<sup>™</sup>-like Multi-user/Multi-tasking  
Disk Operating Systems*

- OS-9/68000<sup>™</sup> (Real-time and PROMable)
- UniFLEX<sup>™</sup>

*Programming Languages and Application  
Software*

- BASIC, C, PASCAL, FORTRAN, COBOL, and ASSEMBLER
- Spreadsheet, Data Base Management, and Word Processing

**GMX** inc.

**1337 West 37th Place  
Chicago, IL 60609**

(312) 927-5510 • TWX 910-221-4055

*State-of-the-Art Computers  
Since 1975*

## UNIX AND THE MC68000

### CPU STATE RESUME IN A CONTEXT SHIFT

```

;
; resume(save-area,)
;
; Resume the process whose saved CPU state is at save-area.
;
resume move.w #0x2700,sr ; Go to high-priority supervisor
; state so you don't get interrupted
; during this state transition.

move.l 4(sp),a0 ; Get the pointer to the CPU saved
; state.

;
; Here you may access other parameters, such as memory management
; information about how to map the new process.
;
;
; Before resuming the new process, its image must be appropriately
; restored (and possibly mapped using an MMU).
;

movem.l (a0)+, #0xFFFF ; Restore all CPU registers.
; This includes a7, the
; supervisor stack pointer that
; still points to the return
; address of the original call.

move.l (a0),a1 ; Get the user stack pointer.

move.l a1,usp ; Restore the user stack pointer.

move.l #0x1,d0 ; Get a 1 as the return value for
; the upcoming simulated return
; to save().

move.w #0x2000,sr ; Go to low-priority supervisor
; state, that is, reenale
; interrupts.

rts ; Return using the return address
; copy from the original call
; to save.

```

The programmer's view of the fork call is that of a function, `fork()`, which, when called once, returns twice. (See the text box "A Programmer's View of `Fork()`" on page 196). It returns once in the calling process with the pid of the new process created. It returns a second time in a new process that is an exact copy of the original except that the new process has a different pid number and the fork call returns the value 0.

During the context shift operation the kernel function `save` is used to

save the process state and prepare a second flow of control to be used in the new process. Rather than terminating in a resume call, the first return from the `save` continues as the control flow in the parent process. (See the text box "A Kernel View of `Fork()`" on page 198.)

### INTERRUPT HANDLING AND UNIX

The MC68000 processor provides a great deal of flexibility for the system

*(continued)*

\$345 (0K)

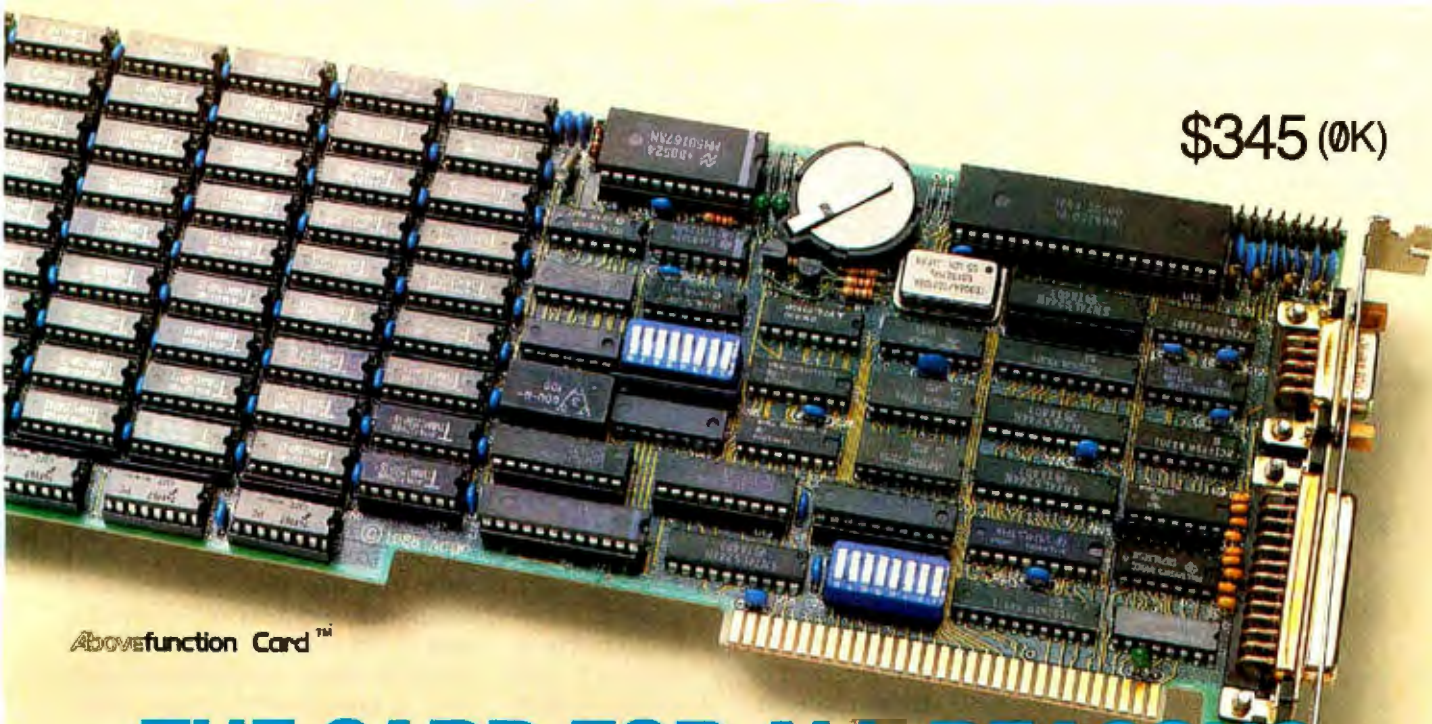

Abovefunction Card™

# THE CARD FOR ALL REASONS

## Reason 1: More Memory

When you need more memory, the Abovefunction Card® from American Computer & Peripheral, Inc. delivers a full 2 Megabytes of RAM to your American, IBM® personal computers and compatibles.

The American Abovefunction Card can fill conventional memory to 640K with the remaining as expanded memory or install up to four Abovefunction Cards to provide the maximum 8 Megabytes of expanded memory for your PC system.

## Reason 2: More Functions

In addition to expanded memory, the American Abovefunction Card includes commonly used features, such as a serial, parallel and game port and real-time clock/calendar, all on one board.

The American Abovefunction Card has Cache Memory, an enhanced disk buffer software that is transparent to the user and gives up to four times faster hard disk access. RAM disk and print buffer capabilities are also contained on the EMM (Expanded Memory Manager)/Utility Diskette.

## Reason 3: Maximized Slot Usage

Plan for the future with the American Abovefunction Card. One card provides your memory and multi-function needs in one I/O expansion slot. This frees valuable slot space for other enhancements.

## Reason 4: Compatibility

The American Abovefunction Card is based on Lotus®/Intel®/Microsoft® specifications and is compatible with Intel's Above® Board.

## Reason 5: Price

And, one of the best reasons of all, the American value: \$725.00 (includes 2 Megabytes RAM) and \$345.00 (0K)

### AUTHORIZED DISTRIBUTOR AND SERVICE CENTERS:

|                                                                           |                                                         |
|---------------------------------------------------------------------------|---------------------------------------------------------|
| California Micro, Inc.<br>Los Angeles, CA (800) 792-6500                  | SK Computers<br>Orlando, FL (800) 624-3250              |
| Imagine Computers<br>Goleta, CA (800) 344-2964                            | The Super Source<br>Norcross, GA (800) 241-8579         |
| PC Land, Inc.<br>Tustin, CA (714) 730-6723                                | Mid America<br>Carmel, IN (317) 846-3101                |
| Computer Professionals<br>Lakewood, CO (303) 232-4009                     | CPU Distribution, Inc.<br>Burnsville, MN (612) 894-9310 |
| Computer Peripheral Warehouse, Inc.<br>Deerfield Beach, FL (305) 481-2170 | Asibem, Inc.<br>Bluespring, MO (816) 229-2442           |

|                                                               |                                                                   |
|---------------------------------------------------------------|-------------------------------------------------------------------|
| Computer Wholesalers<br>Lincoln, NE (402) 466-1962            | American Computer Distributing<br>Chattanooga, TN (615) 870-1073  |
| Micro Configuration East, Inc.<br>Brooklyn, NY (718) 941-2512 | Columbia Data Systems, Inc.<br>Columbia, TN (615) 381-4650        |
| Microsel<br>Oklahoma City, OK (405) 787-4354                  | Omega Data<br>Kirkland, WA (206) 823-9769                         |
| Omega Data<br>Hillsboro, OR (503) 640-3995                    | Inter-Micro Distributor, Inc.<br>Alberta, Canada (403) 438-3997   |
| Power House Sales<br>Sioux Falls, SD (605) 335-7181           | Paris Sud Electronique Composant<br>Paris, France (1) 69.20.66.99 |

### MAJOR DEALERS:

|                                                         |
|---------------------------------------------------------|
| Computerland of Whittier<br>Whittier, CA (213) 945-8321 |
| Elek-tek, Inc.<br>Chicago, IL (312) 677-7660            |
| Inacomp Computer Center<br>Columbus, OH (614) 431-2230  |
| Inacomp Computer Center<br>Saginaw, MI (517) 790-1360   |

## American

COMPUTER & PERIPHERAL, INC.

Corporate Office: 2720 Croddy Way, Santa Ana, CA 92704 USA • Tel: (714) 545-2004 • Fax: (714) 545-2146

Northeastern Office: 826 Busch Court, Columbus, OH 43229 USA • Tel: (614) 846-5433 • Fax: (614) 846-7656

\*Abovefunction, IBM, Lotus, Intel Above and Microsoft are trademarks of American Computer & Peripheral, International Business Machines, Lotus Development, Intel and Microsoft Corporations, respectively.

designer in handling interrupts. As with most processors, all interrupts can be handled in a vectored fashion. This is where each interrupt, internal and external, is associated with a location in memory (the vector address) that holds the address of the handling routine for that particular interrupt.

When an interrupt occurs, the ap-

propriate location in memory or vector is used to fetch the starting address of the appropriate interrupt handler, and control is transferred to it (this is also how things work on the Intel 80286 processor). Figure 7 shows how vectored interrupts access interrupt handlers.

But this is all the 80286 really offers; the MC68000 offers a seven-level processor priority scheme for selectively masking interrupts. Each interrupting device is assigned a priority level. When the processor is set to a particular priority level, all interrupts at that level and below are held off. This allows higher-level, more critical interrupts to supersede the handling of lower-level, less critical interrupts. The Intel 80286 allows only for the turning on and off of all interrupts simultaneously, which is much less flexible.

This selective masking of interrupts is very useful to the UNIX system. Consider a low-priority event, the scheduling event triggered by a periodic interrupt from the system clock. While the scheduling of a process must occur in the multiprocessing UNIX system, it is not crucial that it be done at a precise moment. Any time the scheduling process is taking

place, another interrupt can be handled without harm to the overall operation of the system.

Consider also a high-priority event, the disk interrupt indicating that a sector on the disk has been located. If this interrupt is not serviced immediately, the disk will rotate beyond the desired sector and time will be lost waiting for it to come around again. Such delays could impact system performance greatly. This is especially true with UNIX because it is traditionally a disk-based system. It is easy to see that you would want the disk interrupt to supersede the handling of process-scheduling chores.

On the MC68000 this is easily accomplished by making the disk interrupt a higher priority than the clock interrupt. This allows the disk interrupt to supersede the scheduling process and ensure that it is serviced immediately to prevent any disk performance loss.

On processors where interrupts cannot be selectively masked by priority, the disk interrupt would have to be held off while the scheduling interrupt is handled. Unless external interrupt priority hardware was provided, the disk sector would be missed and system performance would suffer. From the preceding example you can see the advantages of the MC68000 interrupt system for UNIX implementations.

You can also see that it is not necessarily just an advantage for a UNIX system. The situation described in the example could arise in many systems today. The MC68000 interrupt architecture provides the flexibility necessary to build an efficient interrupt control system.

**C LANGUAGE COMPATIBILITY**  
UNIX, the MC68000, and C are all well suited for each other. C itself is a good systems programming language. In fact, 90 percent of the UNIX operating system and most of the user programs for UNIX are written in C. Since the MC68000 allows for a very efficient C compiler, this in turn provides an efficient UNIX implementation.

The compiler writer's task is made easy by the MC68000. The portable

(continued)

```

sleep()
{
 ...
 switch()
 ...
}

switch()
{
 ...
 if (save(proc) == 1)
 return
 ...
 <select new process>
 ...
 resume(new process)
}

```

Figure 4: Sleep in a context switch. Sleep calls switch, which saves the current process state and then selects the next process to run and runs it.

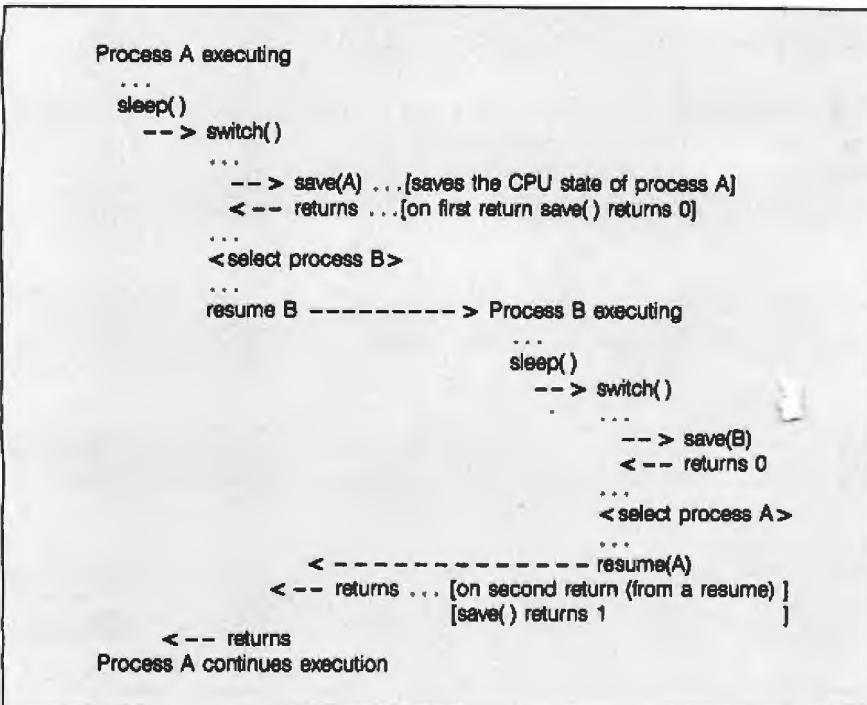

Figure 5: Context shift control flow.

INTRODUCING FUJITSU'S DX FAMILY OF PRINTERS

# TAKING PC PRODUCTIVITY TO NEW HEIGHTS

Choose the 80-column DX2100, or the 136-column DX2200. For sheer print volume, these Fujitsu printers can't be topped. At 110 lines per minute, their throughput is almost double that of most major competitors.

The built-in bi-directional tractor speeds paper handling too. Just flick a switch to go from continuous forms to single-sheet feeding, without removing cumbersome optional tractors or tractor paper.

The well-designed operator panel gives you fast, convenient control of all printer functions, and enables you to identify error conditions quickly.

DX printers won't distract you from your work either—thanks to their quiet operation at less than 55 dBA.

And in addition to fast spread sheets, Fujitsu's DX printers produce near-letter-quality print and excellent graphics. They'll grow with your needs, too. Upgrading to color, or changing your system interface, is as easy as plugging in a new module.

You can put these fine printers to work for a lot less than you might expect. And it costs next to nothing to keep them working. They come with a superb reliability rating of 6000 hours MTBF, and a full one-year warranty.

For more information about the new Fujitsu DX family of printers, call Fujitsu America, Peripheral Products Division, at (800) 626-4686. Get the personal printers that really produce.

**WE'RE DEVELOPING TECHNOLOGY FOR YOU.**



**FUJITSU AMERICA**

Inquiry 138



C compiler was designed for a register machine with two types of general-purpose registers. Setting up the data and address registers as these two types works very well. The MC68000's nearly orthogonal instruction set helps keep code generation straightforward. (An orthogonal instruction set is one in which any registers can

be used with any instructions and with any addressing modes.)

The result of having a CPU that supports an efficient compiler is a code density (number of assembly instructions per C statement) that is good enough for libraries, system work, and even I/O drivers. The C programmer does see the CPU peeking through

now and then even though C is a high-level language. For example, proper use of the register statement requires CPU knowledge.

C on the MC68000 also allows for efficient pointer/integer arithmetic. This is due to the 32-bit linear address space. An integer and a pointer are both 32-bit quantities.

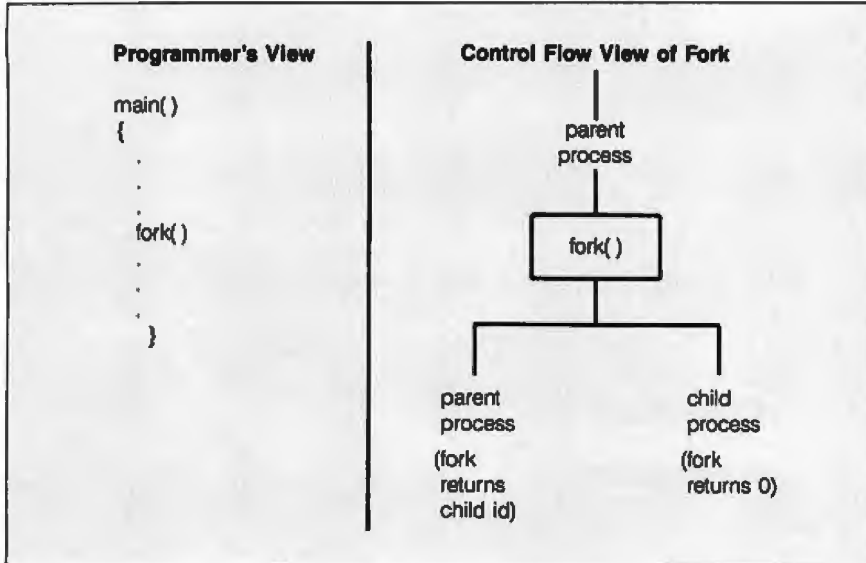

Figure 6: The programmer's view of a fork() call.

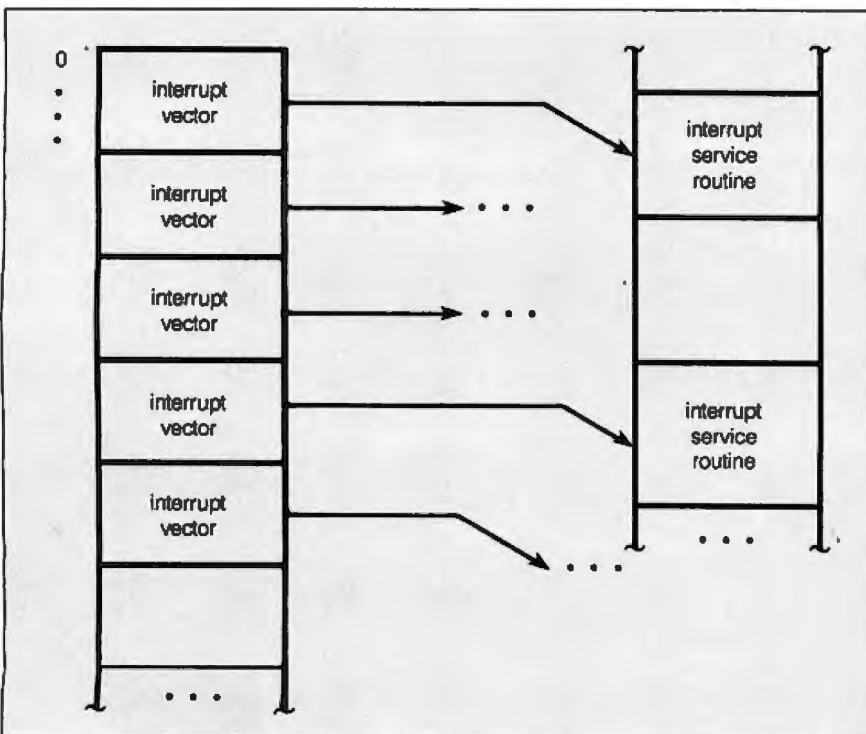

Figure 7: Vectored interrupts.

**MISSING FEATURES**

The MC68000 has some weaknesses with regard to UNIX implementation, primarily the omission of features that are typically implemented separately from the CPU using other VLSI support or discrete implementations. One point in favor of the MC68000 is that its architecture generally does not prohibit or impede external implementation of missing features.

The most glaring omission in the MC68000 family is memory management. The MC68000 philosophy is to do nothing for memory management rather than do a partial job. The MC68000 CPU generates 32-bit logical addresses. If these are to be translated into physical addresses, off-processor hardware to perform the translation must be provided. (Memory management typically consists of address translation and address bounds checking.)

First, consider address translation. Address translation involves a distinction between logical addresses (namespace addresses used in a program) and physical addresses, those that are presented to the main memory. Figure 8 demonstrates this logical/physical distinction using a system block diagram. Address translation allows several processes to use an identical logical address space while using completely separate portions of physical address space. This permits several copies of the same process to coexist in one physical memory.

Because UNIX uses the fork paradigm to duplicate user processes and implement multitasking, some form of memory management is highly desirable, and here there is an advantage to the MC68000 philosophy. Since there is no memory management on board the MC68000, UNIX implementers are forced to choose

(continued)

# AVOCET INTRODUCES MACRO ASSEMBLERS.



*Put your design ideas into more chips.*

**New AVMAC™ Macro cross-assemblers, combined with our simulators, emulators and EPROM programmers, turn your PC or VAX into a complete development system.**

AVMAC is fast. Its transparent buffering scheme provides the speed of memory-based assembly without restricting file size. And, AVMAC has one of the most comprehensive macro facilities available.

AVMAC is loaded with features that make your development job easier. You get source code flexibility; AVMAC supports over 1000 relocatable segments. AVLINK™ linker and AVLIB™ librarian support modular programming with full control over segment combination and placement. AVREF™ generates cross-references by line and procedure. And, AVMAC gives you informative, plain English error messages.

AVMAC offers superior compatibility with manufacturers' assembly languages. And it's designed to work hand-in-hand with AVSIM™, Avocet's software simulator/debugger.

Every company talks about service. But at Avocet we're committed to satisfying customer requests for in-stock items in 2-3 working days. And that's a fact!

For easy access, call our 800 number for ordering, product information and technical assistance. We're also interested in *your* ideas on how we can better serve your needs.

| AVMAC Macro Cross-assemblers |       |
|------------------------------|-------|
| MSDOS™, PCDOS™ .....         | \$349 |
| XMAC68K .....                | \$595 |
| VAX™/UNIX™ .....             | \$995 |

#### Target Microprocessor Families Supported:

|             |              |             |
|-------------|--------------|-------------|
| 6804        | 6502/65C02   | Z8          |
| 6805        | 6800/01,6301 | Z80         |
| 6809        | NEC 7500     | 68H11       |
| 1802/1805   | 8085         | HD64180     |
| 8048/8041   | COP400       | 68020       |
| 8051        | F8/3870      | 68000/68010 |
| <b>NEW!</b> | TMS32010     | TMS32020    |

**In addition to AVMAC, Avocet provides everything you need to develop micro-processor software.**

**AVSIM full-screen Simulator/Debuggers** make software simulation practical. Test your code in a crashproof, interactive environment, without additional hardware. Price \$299.  
**TRICE™ self-powered In-circuit Emulators** recognize 34 different commands;

set break points, single-step, trace and more. Priced from \$498.

**AVPROM™ Programmers** work with any PC. Program over 37 different devices, including EPROMs through 27512, CMOS and E<sup>2</sup>PROMS, and MPU/EPROM combos, using fast, "adaptive" algorithms. From \$429. Gang programmers from \$979.

To find out more about Avocet software development tools, call us toll-free:

## 1-800-448-8500

(In the U.S. except Alaska.)

VISA and Mastercard accepted. Most popular disk formats now available—please specify. Software shipment by second-day air within the continental U.S. included. Special handling and other shipping additional; call for exact quotes. OEM INQUIRIES INVITED. Avocet Systems Inc., P.O. Box 490-B16, Rockport, Maine 04856, (207) 236-9055. Telex: 467210 AVOCET CI.

**AVOCET**   
**SYSTEMS INC.®**

™ signifies manufacturer's trademark

their own style of memory management hardware and can select the trade-off between performance, price, and design schedule that is best for their target market.

MC68000 UNIX implementations on the market range in memory management unit complexity from no extra hardware to an MMU providing

segmentation and paging. Memory management also involves memory protection, often implemented by bounds registers that are compared to user logical addresses. Memory protection allows several processes to coexist in the same physical memory without overwriting each other or reading each other's data.

Memory protection is highly desirable in a multiuser environment to protect users from each other. Although the MC68000 itself does not provide any form of memory protection, it does incorporate VLSI MMUs, the MC68451 and the MC68851. The MC68451 MMU provides memory translation in a segmented fashion and memory protection associated with each segment. The MC68851 provides address translation and bounds checking in a paged environment.

The 80286 provides two modes of addressing: Real Address Mode and Protected Virtual Address Mode. When operating in Real Address Mode, the CPU issues logical addresses, as does the MC68000. When operating in Protected Virtual Address Mode the 80286 performs memory translation and bounds and privilege checking on board the CPU. It is possible to use this virtual address mode to implement process separation in UNIX. This area is one in which the 80286 architecture makes implementation of UNIX easy, in that the implementer is not required to add external memory management hardware.

**INTERRUPTIBILITY**

The 68000 CPU is not restartable for all instructions. If the execution of a given instruction causes a fault (e.g., because of an MMU bounds violation), that instruction cannot necessarily be restarted transparently. Transparently here implies that the restart occurs in such a manner that the interrupted process cannot detect that the interrupt and restart have occurred.

Some MC68000 instructions can be aborted in such a manner that the internal CPU status cannot be recovered and restored. Such instructions cannot be restarted transparently. In a paged memory environment a CPU exception is typically generated by an MMU when a desired page is not in main memory. If the CPU cannot be restarted following the abortion of any instruction, the CPU cannot be used reliably in a paged memory environment.

(continued)

**A PROGRAMMER'S VIEW OF FORK( )**

```

main()
{
 /*
 * Simple fork example program.
 */
 int child-pid;

 /* ... */

 child-pid = fork();

 if (child-pid == 0)
 {
 /*
 * This is executing in the child process.
 */
 printf(" Hi from the child process. \n");
 /*
 * At this point the child process may
 * overlay itself with another command
 * using an exec call; the fork-exec sequence
 * is the "normal" way to start a new program.
 *
 * Here the new program "factorize" is called
 * to overlay the child process image.
 */
 execv("factorize",argv);
 }
 if (child-pid > 0)
 {
 /*
 * This is executing in the parent process.
 */
 printf(" Hello from the parent process. \n");
 printf(" My child's id is %d \n",child-pid);
 }
 if (child-pid == -1)
 {
 /*
 * This is executing in the parent process,
 * but the fork() failed, so there is no
 * child process.
 */
 printf(" FORK FAILED! Awk! \n");
 }
}

```



# How to put Ferrari speed and Mack Truck capacity into a PC

without available slots.



## Install the Dream Board in place of your multifunction card.

Chugging along in an overloaded, underpowered PC without room to expand? Need the increased power and memory of an AT™ without sacrificing your current software library or DP budget?

### **Problem solved:**

### **The Univation Dream Board!**

- A PC accelerator board that triples the speed of your PC,
- Plus an EMS RAM board with up to 2 megabytes of high-speed RAM for your most complex Lotus™ spreadsheets and CAD operations,

- Plus a full-featured multifunction card with serial and parallel ports, clock/calendar, RAM Disk, Print Spooler, Disk Cache, and a speed selection switch that maintains 100% PC software compatibility.

### **All in ONE SLOT**

That's the dream come true. If your PC, XT, Compaq™ Portable, or 100% compatible is full, simply replace your single application multifunction card with the Dream Board. You'll retain all your multifunction features while adding incredible speed and power. **With slots to spare!**

Planning to buy a new PC? The Dream Board is the ideal multifunction board. It provides the speed and power of an AT at a fraction of the cost.

**Act While the Dream Board is fresh in your mind!**

You need the power and the slots. The Dream Board is the answer! Call Univation today. Representatives are waiting to answer your questions and fill your order. Stop traveling in the slow lane. **Move into the passing lane today!**

**Outside California Call:**

**(800) 221-5842**

 **UNIVATION**  
System Solutions for Business

1231 California Circle  
Milpitas, CA 95035  
(408) 263-1200

Inquiry 360

## A KERNEL VIEW OF FORK( )

```

/*
 * Newproc is the internal, kernel form of the fork()
 * system call. Newproc creates a duplicate of the
 * calling process and introduces it to the system.
 */
newproc(
{
/* ... */

/*
 * The new process memory image is duplicated. A new
 * entry in the procedure table is allocated and it is
 * filled with information about this new process.
 */
/* ... */

if (save(save-area) == 1)
{
/*
 * When save returns with the value 1 (after a
 * corresponding call to resume) this copy of the
 * process continues execution. The two processes
 * are duplicates of each other, but traditionally
 * this process is the parent process. This
 * process is the one that originally called
 * fork() and is the one to which the kernel
 * will return the process number of the child.
 */
/* ... */
return(1);
}
/*
 * This flow of control will become the child process.
 * At this point any additional processing that is
 * necessary to make the child ready to run is performed.
 * The kernel will return a 0 value to the fork()
 * call for this flow of control.
 */
/* ... */
return(0);
}

```

Bounds checking can also be used to detect user stack underflow and allow stack growth and process restart. The user memory bounds are set to the end of the user's stack. When an underflow occurs, the MMU generates a bounds violation. The exception handler for the bounds violation can allocate more memory for stack, remap the process, and restart the process. If the CPU cannot be restarted, the process cannot be guaranteed to recover properly after the stack region is expanded by the kernel.

The MC68010 and MC68020 do allow restart of any instruction. On MC68000 UNIX implementations it is possible to implement automatic stack growth using software conventions. A simple test is performed in the preamble to every procedure call to see if sufficient stack is available. This can be accomplished by touching the deepest possible region of use on the stack, using a dummy TST.B instruction. If the test fails, causing a CPU exception and kernel allocation of more stack, the process can be restarted at the instruction after the dummy TST.B instruction. Since this is a software convention, all programs wishing automatic stack expansion must conform to the convention to operate properly.

The text box "Recovery and Restart After a Bus Exception" on page 200 shows a typical bus error exception handler that calls a high-level language routine to implement user stack expansion and process re-mapping.

### COPROCESSORS

The MC68000 family allows for multiple CPU environments. In the UNIX environment there is the possibility for much parallel processing if multiple processors are available. The MC68000 bus operates asynchronously. This aids in configuring buses with a multimaster capability that support multiple CPUs using the same memory and peripherals. Many types of coprocessors are common to UNIX implementations, including floating-point coprocessors, graphics coprocessors, and DMA (direct memory ac-

(continued)

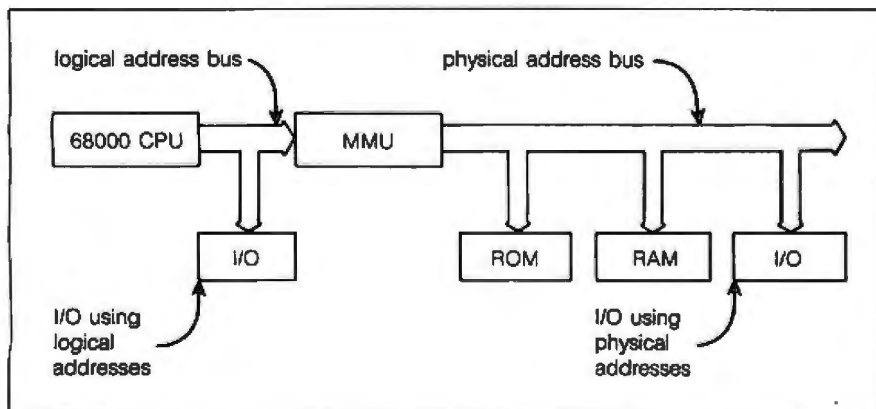

Figure 8: Address translation.



## With the IBM System/36 PC, you can run your business from here.



This surprisingly small IBM System/36 PC has the power to keep any size business moving. At a surprisingly small price.

Connect the System/36 PC to your IBM Personal Computer, and you have the power to build your fortune without spending one.

And you also have a system that's part of the System/36 — IBM's most popular multi-user computer family. Which gives any business access to the broad range of System/36 software as well as PC software.

The basic System/36 PC, a processor and a personal computer, easily operates as a standalone system in a small business. Or ties a department in a larger organization together by connecting a combination of IBM PCs, System/36 terminals or compatible printers. So you can share information and resources.

And yet, with all that power, the System/36 PC processor is so small, it fits under your desk, on top, or next to it. Wherever you put it, you can run a successful business from the best position.

For a free brochure on the IBM System/36 PC, or for information on product availability from participating Authorized IBM PC Dealers, Value Added Dealers or IBM Product Centers, call 1 800 IBM-2468, ext. 104/LD. Or call your marketing representative. And be sure to ask about IBM Credit Corporation financing.

**IBM**<sup>®</sup>

## RECOVERY AND RESTART AFTER A BUS EXCEPTION

: The address of this routine is placed in ROM at the bus address  
: vector location: vector number 2, memory address 8. Control  
: transfers to this location at bus error time.

: Typically an MMU will cause a bus error when a bounds violation  
: occurs (e.g., during stack underflow or page fault).

: At entry the stack will look like this:

```

: sp + 14
:
: sp + 12 Program
: Counter ... Restore during process restart
:
: sp + 10 Status Register ... Restore during process restart
:
: Instruction
: Register ... Examine; verify stack underflow
:
: Access Address ... Examine; verify stack underflow
: and determine how much memory
: to allocate
:
: sp + 2
: ... Function Code; I/N bit; R/W bit
:
: sp ->
:
bus-fault movem.l #0xFFFE, -(sp) ; Save d0-d7 and a0-a6.
: ; These will also be
: ; available to C-bus-handler.

```

jsr C-bus-handler

: A high-level language routine can examine the access address  
: and instruction register to determine the reason for the  
: fault. If the instruction being executed was a TST.B  
: instruction and the access address is "slightly" below  
: the stack, this may represent a stack underflow that  
: requires stack expansion and process remapping.  
: If this was not an implicit stack expansion request,  
: the user process should be sent a signal indicating that  
: the bus error occurred.

: Here the PC should be decremented and the aborted instruction  
: restarted. Since the proper status cannot be assured on a  
: 68000 CPU, the restart is not attempted. On the presumption  
: that the bad instruction was a dummy TST.B, bus-fault simply  
: restores what status it can and returns to the user.

```

movem.l (sp) +, #0x7FFF ; Restore the registers.
addq.l #8, sp ; Strip fcode, access address,
; and instruction register
; off the stack.

rte

```

cess) processors. Because UNIX is a multitasking system with multiple processes executing at any time, the operating system easily manages multiprocessor environments.

For example, the operating system may initiate a disk transfer on behalf of a process, start the operation on a DMA coprocessor, put that process to sleep, and continue executing another process. Similarly, processes may be put to sleep while graphics coprocessors operate on a user's terminal. The MC68000 family includes the MC68881 floating-point coprocessor, which can be used effectively in a UNIX environment.

### SUMMARY

The MC68000 architecture provides a powerful yet simple programmer's model that makes UNIX implementation easy. The difficult programmer's model is a primary weakness of the typical segmented architectures in use in today's UNIX microcomputers, and in overcoming that, the MC68000 became a good choice for UNIX implementation. There are also other good choices, such as those UNIX products on the market that use segmented architectures and others that use stack architectures. Still, a majority of implementations use the MC68000 family.

The MC68000 has many architectural features that help UNIX implementation, including a large linear address space, dual-state processor, and a seven-level interrupt priority scheme. The processor architecture is conducive to using the C programming language, which is the primary development language for UNIX. Further, the MC68000 is a general-register processor that makes UNIX implementation easy because UNIX was originally developed on machines with similar architectures.

The weak side of the MC68000 architecture involves the omission of helpful features, in particular on-board memory management. This desirable feature represents the main advantage of the 80286, but when all factors are taken into account, it is apparent that the architecture of the Motorola MC68000 CPU processor is very well suited to UNIX implementation. ■

# Your first color monitor should be good enough to be your last.

**NEC** introduces the only color monitor you need. Superb resolution plus MultiSync for across-board compatibility with all three PC graphics boards made by IBM,® for business graphics, CAD/CAM, computer art, and text.

Now there's one high resolution color monitor that does things your way. The MultiSync™ monitor from NEC. It gives you the best color resolution available at the price.



- Compatibility with the IBM Professional Graphics Adapter, the IBM Enhanced Graphics Adapter, and the IBM Color Graphics Adapter.

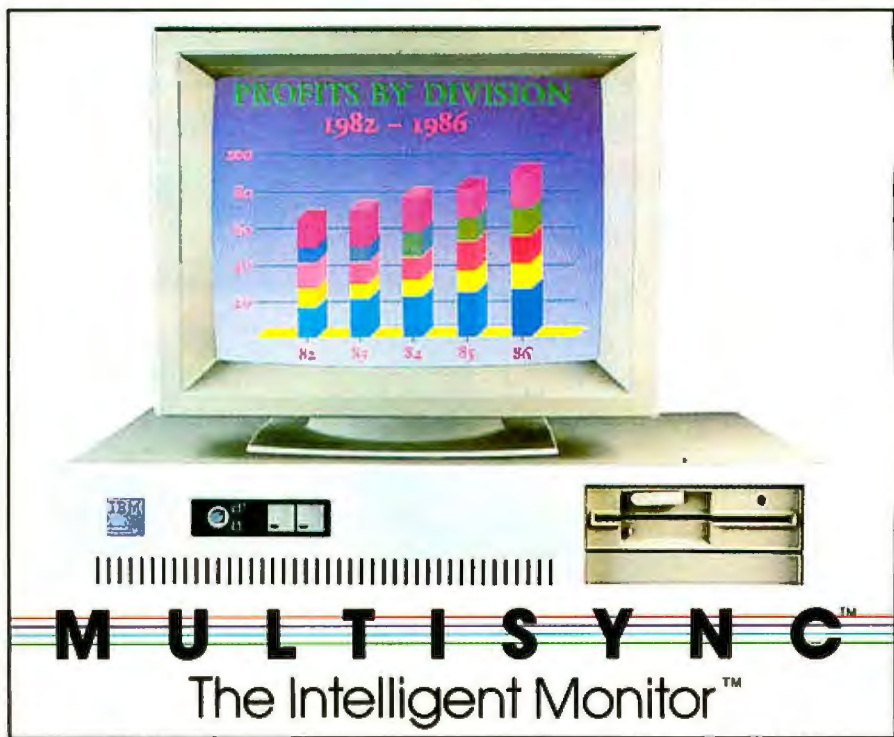

*Compatibility with the IBM® Enhanced Graphics Adapter Board*



- MultiSync, the NEC feature that automatically adjusts to color adapter board scanning frequencies from 15.75 KHz to 35 KHz—suggesting the possibility that the MultiSync monitor might be compatible with all color graphics boards that are fully compatible with the IBM PC, PC/XT, and PC/AT, now and in the future.

- Full implementation of high resolution graphics software for business and other applications, now and in the future.

- And color capability limited only by the board being used.

### See Things Our Way

Until now, you had to choose different color monitors for

compatibility with all three PC color graphics boards made by IBM. With so many board and monitor configurations, folks didn't know which way to look.

The new MultiSync color monitor gives you unique compatibility. As well as TTL and analog color. With 7 switchable text colors. And resolution up to maximum 800 horizontal dots and maximum 560 vertical lines, on a large, 13" diagonal viewing area.

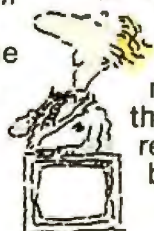

All that, priced at just \$799. All from NEC, a name respected around the world for advanced, reliable products backed by nationwide service.

*Compatibility with the IBM® Professional Graphics Adapter Board*



It's the one color monitor that does everything your way.

*Compatibility with the IBM® Color Graphics Adapter Board*

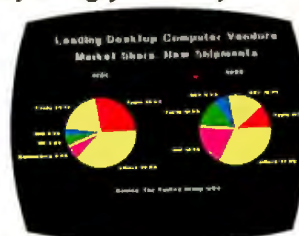

But why talk more about it? Visit your nearest dealer and see a graphic demonstration of the new NEC MultiSync monitor's capabilities. Then draw your own conclusions.

For information dial  
**1-800-447-4700**

NEC HOME ELECTRONICS (U.S.A.) Inc.  
Personal Computer Division  
1401 Estes Avenue  
Elk Grove Village, IL 60007



## THE COMPUTER THAT CONQUERED TIME ALSO CONQUERS SPACE.

Finally: the computers you've been waiting for. Speed. Power. Flexibility. And IBM PC/XT/AT compatibility.

The PC's Limited 286<sup>10</sup> and 286<sup>12</sup> are the most technologically-advanced personal computers ever designed. They run at 10 and 12 megahertz, respectively, providing the fastest processing times of any PC-compatible.

Who needs 12 megahertz speed? *You do*, if you use *dBase* and you're tired of waiting during long sorts and indexes. *You do*, if you're tired of going out to lunch while your compiler finishes its work. *You do*, if you want to see *Microsoft Windows* fly. Or *AutoCAD* or *P-CAD* take off.

The PC's Limited 286s also have the exclusive *SmartVu* panel — an alphanumeric window into the computer that reports on processing speed and provides diagnostic messages in English. It can even help predict hard-disk failures *before* you lose a month's work.

The 286s are also smaller than the other AT-compatibles — more than 25% smaller than the IBM PC-AT, for example. Which means you can find your desk again.

And they're not stripped, Asian wonder-boxes. Designed and built in the U.S., the 286<sup>10</sup> and 286<sup>12</sup> come with 1,024K of fast RAM on the motherboard, 1.2 Mb floppy drive, 200-watt power supply, and an AT-style keyboard.

And every 286 goes through extensive bench-testing and extended burn-in before it leaves our plant.

What more can we say? Except that you can buy the 286<sup>12</sup> for just \$2,695, the 286<sup>10</sup> for \$2,295. Including shipping. Both backed, of course, by PC's Limited's One-Year Limited Warranty and 30-Day Money-Back Guarantee.



Call for latest prices.  
\* Limited Warranty

FREE SHIPPING in the continental United States via UPS Ground.

# PC'S LIMITED 286<sup>8</sup>™ \$1495

High Performance, Competitive Price  
 PC Magazine "Editor's Choice" Feb. 25, 1986  
 Includes: 80286-based system unit, 1024K on mother board,  
 1.2 Meg Floppy Drive, Combined Floppy and Hard Disk Controller Card, AT Style Keyboard, 192W  
 Power Supply, 2 Serials and 1 Parallel Port, and Clock/Calendar with Battery Backup.  
 Runs all Major Software written for the IBM PC™, PC XT™, and PC AT™. (Processor): Intel 80286 running  
 at 8MHz. (Expansion Slots): 8. Same Bus Configuration as IBM PC AT™.  
 One Year Warranty\*



30 Day  
 Money Back  
 Guarantee



# PC'S LIMITED TURBO PC™ \$795

High Performance, Competitive Price  
 Includes: System Unit, 640K on Mother Board, 360K Floppy Drive, AT Keyboard, 130W Power  
 Supply.

Runs all major software written for the IBM PC™, PC/XT™, 40% faster, without  
 modifications Processor: 16-bit 8088—2, 4.77 or 6.66 MHz Clock Speed. Expansion Slots: 8; 7 are  
 available in above configuration.  
 One Year Warranty.\*

## PC'S LIMITED 20 MEG HARD DISK ON A CARD

\$409

- 3 1/2" Tandon Hard Disk
- Software included
- Easy to install
- One Year Warranty



## TANDON HARD DISK WESTERN DIGITAL CONTROLLER

Internal \$409

20 MB Hard Disk System for PC™  
 Includes Tandon Hard Disk, Western Digital Controller, Cables, Manual, Software, and Mounting  
 Hardware. Boots from Hard disk Our Hard Disk Systems are compatible with the latest revisions of  
 the following computers: IBM PC, IBM XT, AT&T 6300, Compaq Deskpro, Tandy 1000, Tandy  
 1200, PC's Limited Turbo PC, Leading Edge PC (Both Models), Sperry PC, Wyse PC, ITT PC, and  
 most other Compatibles  
 PLEASE SPECIFY YOUR COMPUTER TYPE WHEN ORDERING  
 One Year Warranty\*



## FLOPPY DISK DRIVE

\$95

Mitsubishi Electronics Half-Height, DS/DD  
 Also available for AT™ in gray.



## 300/1200 BAUD HAYES COMPATIBLE MODEM

Internal \$159 Fits in Short Slot

External \$179



## WANGTEK 60 MEG TAPE BACKUP SYSTEM

\$795

- Backs up 5 Megs per minute
- Runs under MS DOS or PC DOS
- Pulse Software Included



## PC'S LIMITED SIX FUNCTION CARD

w/OK \$99 w/384K \$149

- Upgradable to 384K
- Clock/Calendar
- Includes Software
- Parallel Port
- Serial Port
- Game Port
- Two Year Warranty\*



## PC'S LIMITED MINI I/O

\$99

- Serial port
- Parallel port
- Clock
- Software
- Fits in short slot



## MONO-II

\$129

- 12" flat and compact screen
- TTL signal input
- Built-in swivel and tilt base
- Instant action system
- Low distortion



## SEAGATE, 20, 30 and 40 MEG HIGH SPEED 40 MS ACCESS TIME HARD DRIVES FOR AT™

20 MEG \$579 30 MEG \$699

40 MEG \$819

Uses Linear Voice Coil Actuator. Heads park automatically  
 at power down. Includes Seagate Full Height Hard Disk,  
 Cable, and Mounting Rails. Boxes from Hard Disk  
 One Year Warranty\*



## PC'S LIMITED PC-576 RAM BOARD W/OK

\$69

- Expandable to 576K
- Supports 64K or 256K RAMS
- Fits in Short Slot

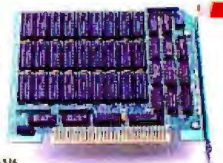

## PC'S LIMITED RGB-1 MONITOR

\$459

- 1MM dot pitch
- RGB input
- 12-inch screen
- 690x240 resolution
- 16 colors



## PC'S LIMITED AT MULTIFUNCTION CARD

\$199 w/OK

- Piggy Back Board \$59 w/OK
- Expandable to 3 MEG (1 S on Board/1 S on Piggy Back Board) • Supports 64 or 256K RAMS • Parallel Port • Serial Port (2nd serial option)



## UNIVERSAL GRAPHICS CARD II

\$199

- Fully compatible with IBM CGA, Plantronics COLORPLUS, IBM Monochrome, and Hercules compatible graphics modes.
- Includes Parallel Port and fits in a "short" slot.



## XT™ POWER 130W

\$99

Solve Your Power Problem  
 Directly replaces Power Supply in PC™  
 Fully XT™ compatible  
 One Year Warranty\*



## TOTAL SATISFACTION GUARANTEE WARRANTY

For warranty service, one year limited warranty on PC's Limited products. Contact Technical Support for a Return Authorization Number (RMA). Returns must be accompanied by your RMA, the invoice, and a brief explanation. During the warranty period, PC's Limited will repair or replace items at our option.

### 30-DAY TOTAL SATISFACTION GUARANTEE

Any item bought from PC's Limited may be returned within 30 days from the date it was shipped for a full refund of your purchase price. Returned items must be as-new, not modified or damaged, with all warranty cards, manuals, and packaging intact. Returned items must be shipped prepaid and insured, and must bear a PC's Limited Credit Return Authorization (CRA) on the shipping label. Call PC's Limited Customer Support Department for CRA. No credit issued after 30 days from date of shipment.

### CONSUMER TIP

When shopping for PC products, ask our competitors about their refund policies. Mitsubishi, Intel, IBM, Hercules, Plantronics, AT&T, Compaq, Tandy, Leading Edge, Sperry, Wyse, and ITT are registered trademarks of their respective companies. IBM PC, IBM XT, IBM AT, are trademarks of IBM Corporation. Leading Edge PC, Sperry PC, Wyse PC, Compaq Deskpro, AT&T 6300, Tandy 1000 and Tandy 1200 are trademarks of their respective companies.

Some quantities may be limited. PC's Limited sells equipment certified to be compliant with FCC Class B standards. All prices are subject to change without notice.

Inquiry 268

SEPTEMBER 1986 • BYTE 203

## PC'S LIMITED

SALES CALLS OUTSIDE TEXAS 1-800-424-1100

SALES CALLS INSIDE TEXAS 1-800-311-8106

1811 Highway 6100, Building 1, Austin, Texas 78734

Sales Calls from elsewhere in the country (512) 339-6961

Technical Support Calls (512) 339-6961 or PC's Limited BBS (512) 339-4117

Customer Service Calls (512) 339-6964 and MEX MEXE, PC's Limited

Buy Now: 973-889-0800 PC LTD. FAX (512) 339-4111

# A POWERFUL PAIR

Having trouble sleeping nights, can't understand why those sheep keep appearing night after night after night! Well stop worrying! We've got the solution!

Introducing the BIG MACK TWIN PACK™, the POWERFUL PAIR that ends those sleepless nights worrying about Head Crashes and Data Security. THE BIG MACK TWIN PACK™ contains a 20MB HARD DISK for your MACINTOSH PLUS as well as a powerful 20MB CASSETTE TAPE BACK-UP for all those files that somehow vanish from your disk. By utilizing the STATE OF THE ART SCSI INTERFACE, the BIG MACK TWIN PACK™ allows for High Performance Transfer Rates to your MACINTOSH PLUS.

The Tape Back-up, in addition to Streaming Back-up, can be used as a Random Access Device that allows file by file back-up and restore operations.

So stop counting sheep and start counting on the reliability of a POWERFUL PAIR of STATE OF THE ART Data Storage Devices...THE BIG MACK TWIN PACK™.



## THE RIGHT PRODUCT AT THE RIGHT TIME



For Information on the Dealer Nearest You, Please Contact:

**Western Computer**

17781 MITCHELL, IRVINE, CALIFORNIA 92714  
(714) 553-1611 • FAX (714) 553-0236  
TELEX 756731 ANSWER BACK: WESTERN COMP.

Prices and Availability Subject to Change Without Notice

Macintosh Plus is a Registered Trademark of Apple Computer Corp  
Big Mack Twin Pack is a Trademark of Western Computer Corp.



**BIG MACK**

**TWINPACK**

Inquiry 371 for End-Users. Inquiry 372 for DEALERS ONLY.



# A COMPARISON OF MC68000 FAMILY PROCESSORS

BY THOMAS L. JOHNSON

*A look at the architecture  
and hardware and software compatibility*

SINCE ITS 1979 introduction, the Motorola MC68000 microprocessor family has grown to five members: the original 16-bit MC68000; the MC68008, an 8-bit data bus version of the MC68000; the MC68010, a virtual memory/virtual machine version; the MC68012, an extended address version of the MC68010; and the MC68020, a full 32-bit virtual memory/virtual machine microprocessor (see figure 1).

Each family member includes architectural enhancements that offer certain advantages, in terms of software, hardware, and system design. However, the extent of software and hardware compatibility between the family members varies.

## **FAMILY OVERVIEW**

The major external differences are in the number of address, data, and various control lines (see table 1).

The MC68000 family uses a three-wire function code that transmits to the system the processing state of the processor on a bus-cycle-by-bus-cycle basis. This allows the designer to maintain in the system hardware the

memory privilege distinctions maintained within the processor. For the MC68000 and MC68008 these function codes can indicate either supervisor mode or user mode, program accesses or data accesses, and interrupt acknowledge bus cycles. The MC68010 and MC68012 use the same encodings on the function code pins but change the name of the interrupt acknowledge space to "CPU space." A CPU space access indicates either interrupt acknowledge or breakpoint acknowledge. The MC68020 expands CPU space accesses to include coprocessor communications and access-permission-level checking, which can be used in sophisticated memory management schemes to implement ring protection architectures. All encodings are done in an upwardly compatible manner, such that systems that recognize an interrupt acknowledge on an MC68000 will work properly even when an MC68020 is inserted in the system. (See figure 2.)

## **USER PROGRAMMING MODEL**

To the user programmer, there is absolutely no difference in the on-chip

resources available for any of the processors in the family. Thus, once a model has been assimilated, no retraining is needed when changing from one family member to any other. The base architecture for the user incorporates eight totally undedicated 32-bit data registers, which can be accessed as bytes, words, or long words (32-bit values) and used for either the source or destination of any operation that will allow the use of a data register (i.e., all arithmetic, logical, and data movement operations). Users also have at their command eight 32-bit address registers that can be accessed as either 16-bit or 32-bit entities. Only one of these registers may be considered dedicated—A7 is the implicit user stack pointer for subroutine calls and so forth.

Rounding out the user model is an 8-bit condition code register and a full 32-bit program counter. The condition code register contains not only the "normal" condition bits for arithmetic

*(continued)*

Thomas L. Johnson is a staff engineer at Motorola Inc. (6501 William Cannon West, Austin, TX 78735-8598).

and logical operations (zero, carry, overflow, negative), but also a bit for extended-precision operations (extended).

The inclusion of 32-bit structures foreshadowed the design of the full 32-bit MC68020—setting the stage for upward compatibility of user-level code in the future processors.

**SUPERVISORY PROGRAMMING MODEL**

A look at the supervisory-level programming model (figure 3) finally reveals the differences in functionality of the family members. Whereas the user-level program has access only to user-level resources, the supervisory-level program has access not only to the complete user-level model, but also to the full supervisory-level programming model for that processor. Note that the supervisor stack pointers are also referred to as A7. An automatic context switch concerning these stack pointers occurs as flow changes from supervisory to user level and back again without

the necessity of loading and reloading stack pointer registers. Table 2 encapsulates all of the resources available to the supervisory-level program on the various processors.

Progressing from the MC68000 to the MC68020, more instructions are available to manipulate the additional supervisory resources, and each model is a proper subset of the next higher processor. Thus, code that manipulates the condition code register on the MC68008 (the 8-bit version of the MC68000) will execute intact on any other of the processors.

This form of "supersetting" the resources on newer family members ensures upward compatibility and is maintained within the family for the supervisor and user programming models, the instructions (to the bit level), the address modes, and all data types.

**ADDITIONAL SUPERVISORY-LEVEL RESOURCES**

The vector base register (VBR), introduced on the MC68010, allows a

supervisory-level program to relocate the 1K-byte exception vector table to anywhere in the physical address map of the processor. This exception vector table is used in the MC68000 family to route specific exceptions to the appropriate handler within the supervisory code space. The vector table consists of 256 four-byte entries, each of which may be used to point to the entry address of its specific handler. Of these 256 vector entries, 37 to 39 vectors (depending on the processor) are dedicated to handling predefined exceptions such as bus errors, TRAP instructions, and so forth. An additional 26 vectors have been reserved for future expansion of functionality, and 192 vector entries can be defined by the user.

The alternate function code registers (SFC and DFC) allow the supervisor to retrieve and modify data in any address map (user or supervisor, program or data). On all family members, the function code outputs are driven automatically based on the

*(continued)*

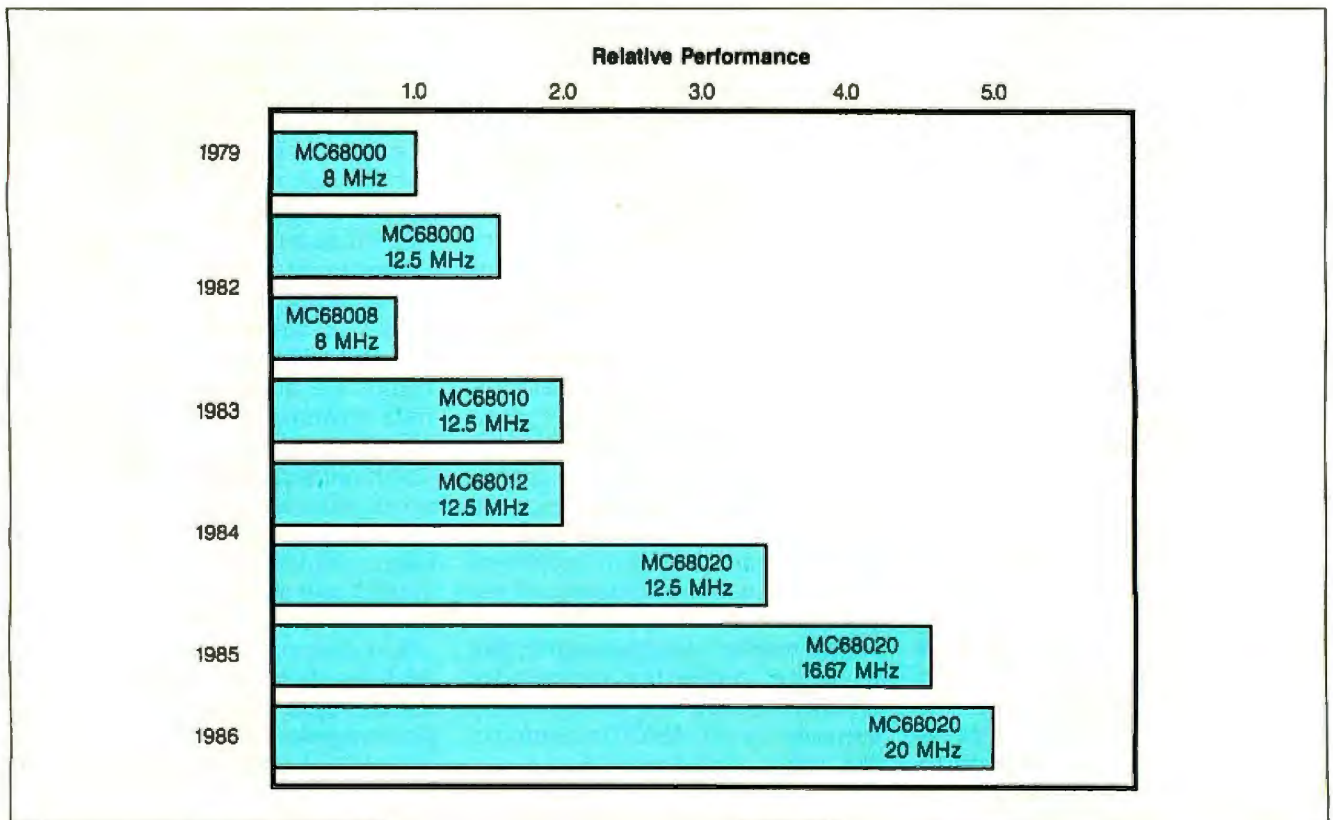
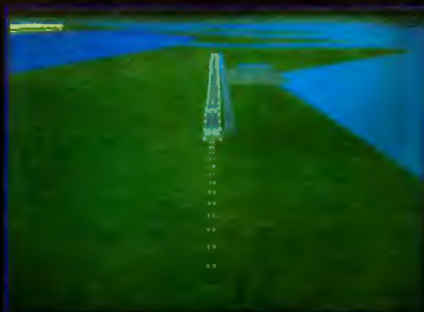
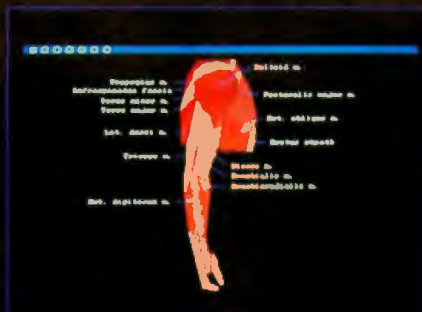

Figure 1: The MC68000 family genealogy.

# High-Speed Animation on Your IBM PC!

# NBC



## X-1 Graphics Board

In our commitment to low-cost animation, we've developed an ultra-high-speed color graphics board to provide the performance of expensive dedicated graphics systems on an inexpensive, user-friendly IBM PC. This board's 400-million bits-per-second color-fill rate offers animation speeds never before available on a PC plug-in board (the X-1 is 10 times as fast as any other PC graphics card we've seen). The low-cost, high-performance X-1 Graphics Board opens up entirely new applications for microcomputer-based graphics.

## 3D Graphics Software for use with the Standard IBM Color/Graphics Adapter or X-1 Graphics Board

Our 3D Graphics software, the graphic drivers behind Jet and Microsoft Flight

Simulator, opens up new worlds of 3D and 2D animation. The program works with both the IBM Color/Graphics Adapter and the X-1 Graphics Board, so you can update your hardware at any time and maintain software compatibility.

**Specs:** The X-1 Graphics Board is available for \$2990, and requires an IBM PC or PC-compatible computer with minimum 128K RAM, PC-DOS or MS-DOS Version 2.0 or newer, and an X-1 compatible RGB display monitor.

The 3D Graphics software is available for \$995, and requires an IBM PC or PC-compatible computer with minimum 256K RAM, PC-DOS or MS-DOS Version 2.0 or newer, and either an IBM Color/Graphics Adapter or the X-1 Graphics Board.

See your dealer for details and a special hardware/software demonstration, or call SubLOGIC directly for more information.

IBM is a registered trademark of International Business Machines Corp.

**subLOGIC**  
Corporation  
713 Edgebrook Drive  
Champaign IL 61820  
(717) 359-5482 Telex 206916

Order Line: (800) 637-4966  
(Interact in 7000s, 4000s, and 1000s.)

Inquiry 333

type and location of the memory bus cycle, and these outputs may be used to enforce hardware protection in the memory subsystem. Because the MC68000 and MC68008 are not virtual machine processors, they have no need to override this hardware-enforced protection, but the MC68010, MC68012, and MC68020 processors require this ability. The alternate function code registers allow these newer processors to perform that function to control the virtual environment.

The two cache control registers introduced in the MC68020 (the cache control register—CACR, and the cache

address register—CAAR) allow the supervisor to control the on-chip instruction cache memory (64 four-byte entries) for that device. The cache powers up as disabled, and the supervisor, at its discretion, may choose to enable it at some later time. Additionally, the supervisor can selectively invalidate cache entries.

The MC68020 status register contains an additional bit for control of the hardware tracing mechanism built into all the family members. The MC68000, MC68008, MC68010, and MC68012 can trace any given instruction or sequence of instructions when

the supervisor enables the tracing mechanism. The MC68020 can also trace only on a program change of flow instruction, such as branch or jump.

The only other added supervisory resource is the master stack pointer (MSP), also new on the MC68020, which allows the separation of task-related and non-task-related exception stacking. In use, the MC68020 powers up and loads the interrupt stack pointer as the active supervisory stack pointer. This is the equivalent to the power-up sequence of any other family member in which the single supervisory stack pointer is loaded. At some later time, the operating system may choose to enable the master stack pointer by enabling the MSP bit in the status register (the stack pointer select bit). From that point on (until disabled), all common program exceptions, including TRAPs and divide-by-zero, that occur will cause state information to be saved on the master stack until an interrupt occurs.

Since interrupts are asynchronous events that will normally have no bearing on the task currently executing in a multitasking environment, it is desirable to separate the interrupt-related information from the task-related information. This is accomplished by first stacking the task-related information from the current task on the master stack and then performing an automatic switch to the interrupt stack pointer for use during interrupt handling away from the interrupted task. Here, a "dummy" stack frame is stored on the interrupt stack so that at the completion of interrupt processing, a single RTE (return from exception) instruction will automatically cause a switch back to the master stack pointer, for reloading the previously saved task state and resumption of that task. The benefit is that the supervisor need not provide stack space for interrupts that may occur during normal task execution and may be unrelated to the currently executing task.

**INSTRUCTION SETS**

On the MC68020, the RTE instruction can perform a large number of dis-

(continued)

Table 1: A pin-out comparison.

|                                 | MC68000   | MC68008   | MC68010   | MC68012   | MC68020   |
|---------------------------------|-----------|-----------|-----------|-----------|-----------|
| Address lines                   | 24        | 20/22     | 24        | 31        | 32        |
| Virtual address range           | 16Mb      | 1Mb/4Mb   | 16Mb      | 2Gb       | 4Gb       |
| Data lines                      | 16        | 8         | 16        | 16        | 32        |
| Bus protocol                    | async     | async     | async     | async     | async     |
| Clock cycles/bus cycle          | 4         | 4         | 4         | 4         | 3         |
| Number of data strobes          | 2         | 1         | 2         | 2         | 1         |
| Number of transfer acknowledges | 1 (DTACK) | 1 (DTACK) | 1 (DTACK) | 1 (DTACK) | 2 (DTACK) |
| Function code lines             | 3         | 3         | 3         | 3         | 3         |
| Bus arbitration lines           | 3         | 2/3       | 3         | 3         | 3         |

**Interrupt acknowledge: MC68000/008**

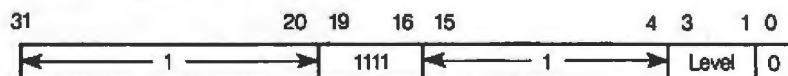

**Breakpoint acknowledge: MC68010/012**

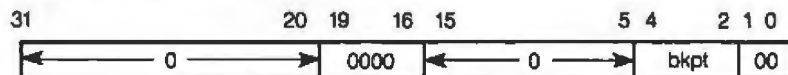

**Access control: MC68020**

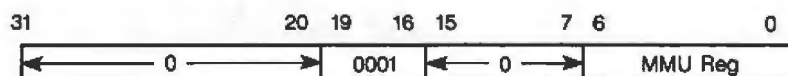

**Coprocessor communications: MC68020**

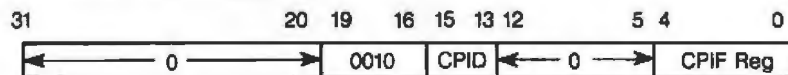

Figure 2: CPU space address bus encodings (FC0-2 = 111).

# The computer below gives you \$6000 performance.



# The computer above gives you a \$2995 price.

## Introducing the TeleCAT-286™

No matter how you look at it, now you can have all the power and speed of the IBM AT—for the price of a comparably-equipped IBM XT. With the new TeleCAT-286, from TeleVideo.

It starts you off with everything you need. Including IBM AT compatibility. 512K RAM. A 20MB hard disk. A 1.2MB floppy. Plus an Intel 80286 CPU

that runs at either 6 or 8MHz clock speed. All standard.

But we didn't just stop at performance. We've also designed a complete set of ergonomic features into the TeleCAT-286. Like a high resolution 640 x 400 monitor. Sculptured keycaps on a high quality keyboard. Even LEDs right on top of the three critical locking keys, where they won't get covered up by overlays. Best of all, you get all this in a

size 28% smaller than the IBM AT.

The new TeleCAT-286. Want to learn more about it? Call us at 1-800-TELECAT, Dept. 114, and we'll tell you the nearest place you can find one.

Then check out the computer with performance above your expectations—at a price below them.

 **TeleVideo®**  
Settle for more.

TeleVideo Systems, Inc. 1170 Morse Avenue, Sunnyvale, CA 94088-3568 (408) 745-7760

IBM is a registered trademark of International Business Machines, Inc.

Inquiry 345

© 1986 TeleVideo Systems, Inc.

create functions (check for dummy frame, change stack pointers, reload state); however, this is the same instruction used on the MC68000, MC68008, MC68010, and MC68012. The function performed by the RTE will relate to the resources and functionality available on the respective processors. Thus, for the MC68000 and MC68008 to return from interrupt processing or normal exception han-

dling, this instruction simply restores the status register and program counter of the suspended task from the supervisory stack pointer, whereas on the MC68010 and MC68012 it also checks the stack format and can reload the more substantial amount of information for the saved internal state. On all processors, the RTE instruction performs whatever is necessary to return from an exception.

The instruction set of the base architecture, that of the MC68000, consists of a set of user-available instructions and a set of *privileged* instructions for control of sensitive system resources. The later family MPUs enhanced this instruction set (see table 3).

**ADDRESS MODES**

As with the instruction sets, the address modes are also upwardly compatible from one family member to another. All address modes on MC68000 family processors can be generally divided into four main categories: *data*, if an address mode may refer to data operands; *memory*, if the address mode may be used to refer to operands in memory; *control*, if the processor needs absolutely no knowledge of the size of the operand prior to calculation of the effective address; and *alterable*, if the mode may refer to writable operands (see table 4). Since it is possible to refer to an alterable data operand in memory, it follows that any given mode may be classified in more than one category.

The address modes in table 4 are exactly the same for the MC68000, MC68008, MC68010, MC68012, and MC68020 microprocessors. These modes provide a substantial amount of flexibility and power. For instance, the (An)+ and -(An) modes allow for the maintenance of up to eight stacks per task, a particularly attractive capability in the artificial intelligence arena. To these modes, the MC68020 adds one more mode: memory indirect. The memory indirect mode has a large number of variations and can best be illustrated by the syntactical expressions

(([bd,An],Xn.size\*scale,od) and ([bd,An,Xn.size\*scale],od)

In these new modes, bd and od refer to optional sign-extended 8-, 16-, or 32-bit base and outer displacements; An, to an optional base address register (A0-A7); Xn, to an optional index register (D0-D7 or A0-A7); size, how much of the index register is to be used (16 or 32 bits); and scale, to a scaling factor for the index register (1, 2, 4, or 8).

(continued)

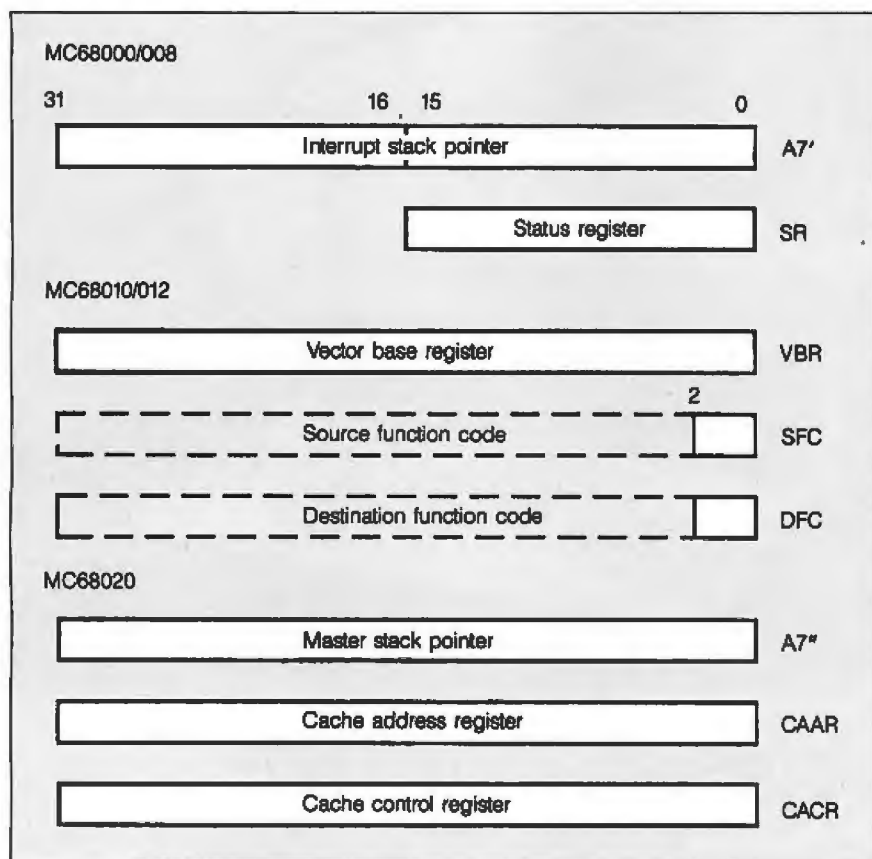

Figure 3: The supervisory programming model.

Table 2: A comparison of supervisory resources.

|                          | MC68000/008 | MC68010/012 | MC68020 |
|--------------------------|-------------|-------------|---------|
| <b>Status register</b>   |             |             |         |
| Hardware trace bits      | 1           | 1           | 2       |
| Supervisor state bit     | yes         | yes         | yes     |
| Interrupt mask bits      | 3           | 3           | 3       |
| Stack pointer select     | no          | no          | yes     |
| <b>Stack pointers</b>    |             |             |         |
| Interrupt stack          | yes         | yes         | yes     |
| Master stack             | no          | no          | yes     |
| Vector base register     | no          | yes         | yes     |
| Cache control registers  | no          | no          | yes     |
| Alternate function codes | no          | yes         | yes     |



Because the memory indirect mode allows any of the base displacement, base address register, index register, and outer displacement to be optional, and allows the index register to be added to the address calculation either before or after the first address access (pre- and post-indexing), any conceivable combination of these modes is allowed. This includes displaced memory indirect ([bd],od), data register indirect (Dn); and reg-

ister doubly indirect ([Rn]).

The addition of these new modes, however, in no way impacts the compatibility of the earlier modes. Any address mode legal for the MC68000, MC68008, MC68010, and MC68012 operates exactly the same on the MC68020.

#### VIRTUAL OPERATION

Due to the internal architecture of the processors, there are three basic ma-

chines: the MC68000/008 architecture, the MC68010/012 architecture, and the MC68020 architecture. In a nutshell, any user-level code written to execute on the MC68000/008 will execute unchanged on any of the other processors, and any user-level code written to execute on the MC68010/012 will execute unchanged on the MC68020. This upward compatibility applies even to the binary level. The major difference between the processors insofar as exception processing is concerned is in the state frame information that is stored as a result of an exception in support of virtual memory and virtual machine operation.

Virtual memory is a technique that allows all tasks executing on a processor to behave as if each had at its disposal the entire addressing range of the processor, regardless of the amount of physical memory present in the system. Virtual machine is a technique in which all processor and system resources required by a task appear to be present, even if not implemented. To support the virtual memory capability, any given instruction must be "abortable" and in some manner "restartable."

For example, suppose that task A is executing a 32-bit memory-to-memory MOVE instruction and the physical piece of memory required for the destination operand is not currently available. The fetch of both the instruction and the source operand are successfully accomplished, but when the write to the destination is attempted, the memory manager indicates a "not-resident" fault by means of a bus error or fault line to the processor. The processor must then save the state of task A, find an empty piece of memory (possibly by swapping a currently resident piece to a disk), load the target piece of memory from the disk, restore task A, and allow the MOVE instruction either to restart or complete. So, from the time of the fault until the completion of the MOVE instruction, task A was not executing but has no indication of this fact.

Although all MC68000 family processors have the "abort" capability

(continued)

Table 3: A comparison of instruction sets.

|                                  | MC68000/008 | MC68010/012 | MC68020 |
|----------------------------------|-------------|-------------|---------|
| Data movement                    | 7           | 9           | 9       |
| Arithmetic/logical               | 17          | 17          | 18      |
| Binary-coded decimal             | 5           | 5           | 7       |
| Single operand                   | 9           | 9           | 9       |
| Shift and rotate                 | 8           | 8           | 8       |
| Bit manipulations                | 4           | 4           | 4       |
| Bit-field manipulations          | 0           | 0           | 8       |
| Branches (16 conditions)         | 3           | 3           | 3       |
| Exception-related                | 5           | 7           | 8       |
| Control                          | 12          | 13          | 20      |
| Coprocessor generic instructions | 0           | 0           | 7       |
| Total                            | 70          | 75          | 101     |

Table 4: The base architecture address modes.

| Mode                                          | Syntax   | Data | Memory | Control | Alterable |
|-----------------------------------------------|----------|------|--------|---------|-----------|
| Data register direct                          | Dn       | •    |        |         | •         |
| Address register direct                       | An       |      |        |         | •         |
| Address register indirect                     | (An)     | •    |        | •       | •         |
| Address register indirect with post-increment | (An)+    | •    | •      |         | •         |
| Address register indirect with pre-decrement  | -(An)    | •    | •      |         | •         |
| Address register indirect with displacement   | d(An)    | •    | •      | •       | •         |
| Address register indirect with index          | d(An,Rx) | •    | •      | •       | •         |
| Absolute short                                | xxx.W    | •    | •      | •       | •         |
| Absolute long                                 | xxx.L    | •    | •      | •       | •         |
| PC relative with displacement                 | d(PC)    | •    | •      | •       | •         |
| PC relative with index                        | d(PC,Rx) | •    | •      | •       | •         |
| Immediate                                     | #xxx     | •    | •      |         |           |

Dn refers to any of the eight 32-bit data registers, D0-D7.

An refers to any of the eight 32-bit address registers, A0-A7.

Rx refers to any 32-bit register, D0-D7 or A0-A7.

d refers to an 8- or 16-bit sign-extended displacement.

+, - refer to the automatic post-incrementing/pre-decrementing of the specified address register by 1, 2, or 4 depending on the size of the target operand (1, 2, or 4 bytes).





# SAVE ON THESE PRINTERS

ON THESE  
IN STOCK



## NX-10 .... CALL

### STAR MICRONICS

NX-10 (NEW) CALL  
 NB-15 (NEW) CALL  
 SB-15 (NEW) CALL  
 SG-15 367  
 SD-10 319  
 SD-15 438  
 SR-10 469  
 SR-15 578  
 SB-10 589  
 Powertype 297

## EPSON

LX80 209  
 FX85 369  
 DX10 207  
 HI80 355  
 HS80 298  
 FX286 529  
 LO800 529  
 LQ1000 659

## TOSHIBA

P1340 469  
 P351 1149  
 P341P 969  
 P341S 999  
 351 Sheet Feeder 529

## SEIKOSHA

SP-1000 VC (C-64) 185  
 SP-1000 A Centronics 197  
 SP-1000 I IBM 197  
 SP-1000 AS RS-232 197  
 SP-1000 AP Apple IIc 197  
 BP-5200 J 649  
 SP-1000 ribbon 8 50  
 BP-5200 ribbon 12 50  
 BP-5420 999

## BROTHER

HR-15XL-P 359  
 HR-15XL-S 359

## DIABLO

D25 549  
 D80 1 F 2395  
 P-32 CO 1 699  
 P-38 1749  
 C-150 999  
 635 1029

## C. ITOH

1550 SP, Call  
 D1040 Call  
 Prowriter Jr Call  
 Prowriter 8510 SP, Call

1080 .... \$199

## PANASONIC

1060 199  
 1091 228  
 1092 325  
 3131 257  
 3151 399  
 1592 439  
 1595 NEW

## SILVER REED

EXP 420 P 209  
 EXP 600 P 489  
 EXP 800 P 649

## JUKI

Juki 6100 339  
 RS232 Serial Board 55  
 6100 Tractor 119  
 6100 Sheet Feeder 209  
 Juki 6300 757

## OKIDATA

Okimate 10 179  
 182 214  
 192 348  
 193 563

## LEGEND

1080 Call  
 1380 258  
 1385 289  
 808 148

## CITIZEN

MSP-10 268  
 MSP-15 377  
 MSP-20 355  
 MSP-25 528  
 120-D 195  
 Premier 35 469

## MONITORS

### TEKNIKA

MJ-10 175  
 MJ-22 250  
 MS-305 RGB NEW

### AMDEK

300 Green 118  
 300 Amber 128

### SAKATA

SG 1000 12" Green 99  
 SA 1000 12" Amber 109  
 SG 1500 12" Green TTL 119  
 SA 1500 12" Amber TTL 129  
 STS-1 Tilt stand 29

### THOMSON

CM36512V1 269  
 CM36632 159

### ZENITH

ZVM 1220 95  
 ZVM 1230 95  
 ZVM 1240 149

### COMMODORE

1902 Color CALL  
 1802 Color CALL

### PRINCETON GRAPHICS

MAX-12 Amber 175  
 HX-12 RGB 458  
 SR-12 RGB 575

## DISKETTES

### MAXELL

5 1/4" SSDD 11.99  
 5 1/4" DSDD 15.99

### VERBATIM

5 1/4" SSDD 9.99  
 5 1/4" DSDD 13.99

### SUNKYOUNG

SKC 5 1/4" SSDD 11.99  
 SKC 5 1/4" DSDD 13.99

DISK NOTCHERS... \$7.95!!

### BONUS

5 1/4" SSDD 6.99  
 5 1/4" DSDD 8.99

## MISCELLANEOUS

### DUST COVERS

PC-AT 2 pc 10.99  
 PC-XT 2 pc 10.99

### QUADRAM

Gold quadboard 399  
 Silver quadboard 229  
 Quadboard 199

### JOYSTICK

Tac 10 (Ap/Pc) 22.95

### STB

EGA Plus 329

### AST

Six Pack Plus 209

## MODEMS

### US ROBOTICS

Password 1200M 189  
 Password 1200F 229  
 Password 300M 139  
 Password 300F 139  
 Courier 2400 395

### HAYES

Smartmodem 300 133  
 Smartmodem 1200 377  
 Smartmodem 1200B 347  
 Smartmodem 2400 598

COMPUSERVE... 18.95

### ANCHOR

Volkmodem 55  
 Volkmodem 12 179

## DRIVES

### TYMAC

MDD-840 3 1/2" Drive  
 Apple Drive 840K 289

### TANDON

320K 5 1/4" Drive 115

### INDUS

GT Atari Call

### COMTEL

Enhancer 2000 (C-64) 155

## IBM-PC COMPATIBLE

### SUBLOGIC (IBM)

Jet Simulator 34.95  
 Scenery Disks EA 14.95  
 Set 1-6 69.95

### SSI (IBM)

Battle for Normandy 24.95  
 Knights of Desert 24.95  
 Tigers in Snow 24.95  
 Computer Baseball 24.95  
 Carrels & Cutthroats 24.95  
 OP Market Garden 29.95  
 50 Mission Crush 24.95

### BRODERBUND (IBM)

Bank St Writer 48.95  
 The Print Shop 34.95  
 Graphics Library 1 22.95  
 Ancient Art of War 27.95  
 Champ Lode Runner 22.95  
 Karateka 22.95

### ACTIVISION (IBM)

Borrowed Time 24.75  
 Mindshadows 24.75  
 Music Studio 29.95  
 Alter Ego 29.95

### SYNAPSE (IBM)

Synstack 64.95  
 Essex 28.95  
 Wizard of Wall St 28.95  
 Brimstone 28.95

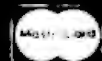

TO ORDER



CALL TOLL FREE 1-800-233-8760  
 In PA 717-494-1030  
 Customer Service 717-494-1670

or send order to  
 Lyco Computer  
 P.O. Box 5088  
 Jersey Shore, PA  
 17740

### RISK FREE POLICY

In-stock items shipped within 24 hours of order. No deposit on C.O.D. orders. Free shipping on prepaid cash orders within the continental U.S. Volume discounts available. PA residents add sales tax. APO, FPO, and international orders add \$5.00 plus 3% for priority mail service. Advertised prices show 4% discount for cash, add 4% for MasterCard and Visa. Personal checks require 4 weeks' clearance before shipping. Ask about UPS Blue and Red label shipping. All merchandise carried under manufacturer's warranty. Free catalog with order. All items subject to change without notice.

# TOLL FREE 1-800-233-8760

Inquiry 211

LYCO COMPUTER MARKETING & CONSULTANTS

via the bus error (BERR) input of the processors, the MC68000 and MC68008 are not virtual memory processors and therefore do not have all the features necessary to support virtual memory. Specifically, insufficient internal processor state information is available on receipt of a bus fault to allow recovery of the faulted instruction. The other family members (MC68010, MC68012, and MC68020),

however, save sufficient state information to allow complete restoration of the faulted instruction. The faulted instruction should be recovered by one of two methods: *instruction restart*, in which the processor is "backed up" to the start of the instruction that caused the fault, or *instruction continuation*, in which the faulted instruction is allowed to complete execution from the point of the fault. The choice of

method may seem to be a matter of computer science dogma, but actually it is of practical importance. The advanced address modes on the MC68000 family and the desire to protect the user from "processor thrashing" caused the designers of the MC68000 family to choose the instruction continuation method.

**INSTRUCTION CONTINUATION**

Processor thrashing can be a very debilitating problem for virtual memory systems. The example used above can also be used to illustrate this problem. In the example, it was assumed that the op code and source operand fetches occurred without incident, but a fault was taken on the operand write. Since most memory replacement algorithms look for unmodified segments to be swapped out (because these segments don't need to be written to a disk prior to releasing the memory space), a good candidate can be the page containing the source operand. If this segment is chosen to be swapped with the destination page, then when the instruction is restarted (rather than continued), the instruction will once again fault—this time for the fetch of the source operand. Thrashing has now begun, with the source and destination areas continually being swapped with one another (since no writes to memory will ever occur), and the instruction will never complete. Some replacement algorithms also factor the "age" of an area into the selection process, so the thrashing will normally be limited to two restarts. However, most operating systems will dispatch a new task while waiting for the disk subsystem to fill the requested area, and therefore the newly filled area will be "aged" somewhat by the time it finally gets used. Instruction continuation, utilized by the MC68010, MC68012, and MC68020, completely alleviates this problem because once an area has been successfully accessed, it is never needed again by that instruction.

Due to the virtual requirements and the need to accomplish this virtuality without massive operating system code, the MC68010, MC68012, and MC68020 have larger stack frames

# IF YOU STILL USE PAPER FORMS TRY FORMMANAGER II!

Name John Smith      Date 11/11/86  
 Address 111 Board Way  
 City San Francisco  
 State CA      Zip 94111

| Prod. No.  | Description | Price | QTY | Total   |
|------------|-------------|-------|-----|---------|
| 123-333-33 | Gadget      | 10    | 100 | 1000.00 |
| 232-32-32  | Widget      | 1     | 40  | 40.00   |
|            |             |       |     | 1040.00 |

**MEET FORMMANAGER II.** It can help automate your paper office. More than a data manager, FormManager II lets you generate forms and organize them easily. You simply lay out your forms on the screen and fill in the data. FormManager II can calculate the tax due, total amount or even set up conditional calculations. More than 26 mathematical functions are included.

FormManager II can print on pre-printed forms or just print on any plain paper. With a laser printer, you can even use different fonts on the same page.

**HERE ARE SOME HIGHLIGHTS:**

- Generate or use dBase III™ data files.
- Lay out forms on the screen with Forms Editor.
- Use the cursor keys to move from field to field.
- Fill in data easily with error checking.
- Print on pre-printed forms.
- Print on any plain paper with lines and boxes.
- Sort, search and modify any data records easily.
- Do complex calculation or even conditional statements.
- Report writer summarizes all your records.

**SPECIAL LIMITED TIME OFFER ONLY \$99**

\*\*\*\*\*

**Attention, MS FORTRAN, PASCAL, C Programmers,**

Forms Designer programming tool can save you time and effort producing professional screen forms. Don't struggle with the formatted I/O for screen data entry. Just use our Forms Editor to lay out the forms and call our library routines to do the job.

Comes with Forms Editor, runtime library, sample programs and library source code for PASCAL and C.

**To Order Call  
408-262-1054**

Only **\$275.**

dBase III is a trademark of Ashton-Tate, Inc.  
 FormManager and Forms Designer are trademarks of HIT Software, Inc.

**bit** BIT Software, Inc.  
 P.O. Box 360619  
 Milpitas, CA 95035

associated with the bus error exceptions (see figure 4). On the MC68000/008 processors, very little information must be saved for bus errors because the MPUs accommodate system faults rather than virtual faults. The MC68010/012/020 processors, on the other hand, save more internal information in support of instruction continuation. These variances in stack frames are buried in the exception handlers operating in the supervisory mode of an operating system. Only those exception handlers that deal with the maintenance of the supervisory stack or expect values at specific offsets on the supervisory

stack are affected by the stack differences.

Thus, any exception handler code that is written to execute on one processor will require only minor or no changes to execute on another family member processor. These software changes are a normal part of upgrading a system, since memory management systems are typically upgraded from one system to the next—particularly when going from a non-virtual memory environment to a virtual memory environment. However, the specific type of memory management implemented has no bearing on the compatibility, since the processor

*The instruction continuation method protects the user from processor thrashing.*

itself is not affected by the memory management scheme chosen.

**PHYSICAL BUS INTERFACE**

All members of the MC68000 family use the same simple asynchronous  
*(continued)*

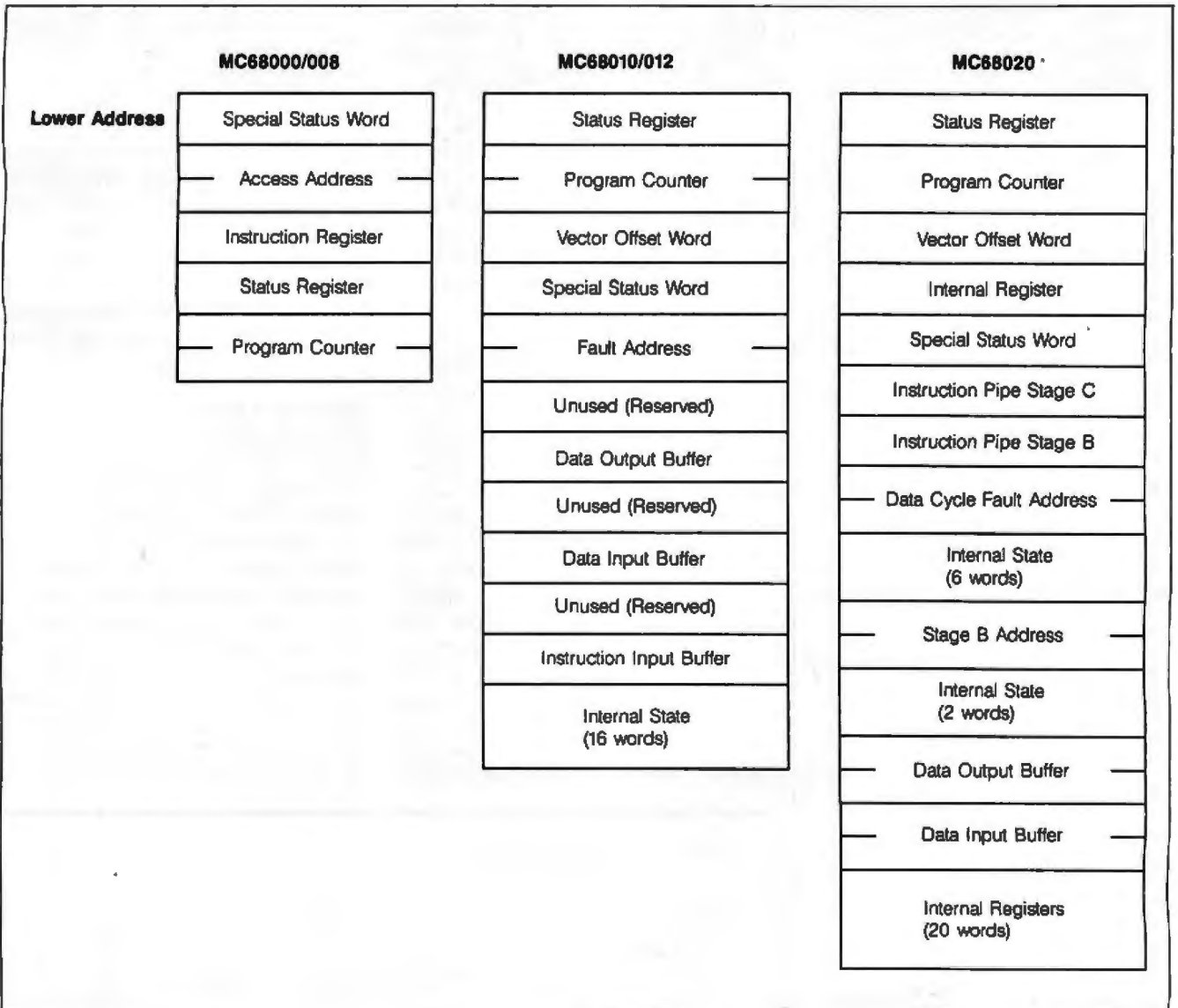

Figure 4: Bus error stack frames.

# 68000 Reasons to Upgrade Your Apple II ...

Transform your Apple II, II+ or Apple IIe into a powerful 32-bit supermicro. Simply plug in a PDQ 68000 coprocessor and PDQ highspeed RAM card; ProDOS and DOS acceleration and utility software is included.

## the PDQ Super-32 System

The Highest Performance Apple II 68000 Coprocessor

### Boosts Apple II Performance

PDQ's Applesoft acceleration is compatible with most off-the-shelf ProDOS and DOS Basic software, such as BPI General Accounting. PDQ's lightning-fast disk emulation results in dramatic performance improvements with Appleworks and other popular programs. ProDOS applications can use PDQ's time and date functions. And PDQ's printer buffering allows printing to occur while the Apple is free to perform another task.

### Hosts Advanced 32-bit Software

In addition to enhancing standard Apple software, the PDQ System also provides access to a multitude of 68000-specific applications. Optional applications include CP/M 68K with C, the UCSD 68000 PASCAL System, 68000 FORTH, FORTRAN and LISP, and many others. PDQ'S 68000 Macroassembler/Editor is an integrated 68000 development system.

### In Use Worldwide

ETC has been shipping advanced 68000 products for the Apple II since 1983. No other company offers a more complete, proven family of 68000 products.

### Products with Integrity

- 15 day money back guarantee
- 5 year parts warranty, 1 year labor
- PDQ RAM cards include PDQBASIC, PDQRAM and PDQSPool software

|                             |        |
|-----------------------------|--------|
| PDQ 10Mhz 68000 Coprocessor | \$449. |
| PDQ 256K RAM Card option    | \$169. |
| PDQ 1MEG RAM Card option    | \$399. |
| PDQ 2MEG RAM Card option    | \$729. |
| PDQ Macroassembler/Editor * | \$ 99. |
| PDQBASIC+ 68000 Compiler *  | \$ 79. |
| UCSD 68000 PASCAL System *  | \$ 99. |
| CP/M 68K with C language *  | \$290. |

(\*requires 256K minimum PDQ memory)

Order your PDQ Super-32 System today by calling Enhancement Technology, or send your check or money order to

Enhancement Technology Corporation  
P.O. Box 1267  
Pittsfield, Massachusetts 01201

(413) 445-4219



Advanced 68000 coprocessors

## The MC68010/012 implemented the loop mode and support for program breakpoints.

bus interface to the outside world. On an asynchronous bus, the processor starts the bus cycle, and the external world controls the length of this cycle. Because of this, each portion of the memory subsystem (including memory-mapped peripherals) can respond to the bus cycle in its own optimum amount of time. The basic signals for the MC68000 data transfer bus are address strobe (AS), which indicates valid addresses; data strobe (DS), which indicates valid data during a write cycle; and data transfer acknowledge (DTACK), which is the external handshake signal used to cause the termination of a bus cycle. These signals are present in one form or another on all of the processors (see table 5).

The MC68000/010/012 processors use two data strobes (upper and lower data strobes, UDS/LDS), which act as byte selects to the memory subsystem, whereas the MC68008/020 processors use only a single data strobe. The MC68008, with its 8-bit data bus, doesn't need byte selects and requires only a single data strobe. The MC68020, due to the presence of the encoded operand size pins (SIZ0/1) also requires only a single pin. The operand size pins communicate to the external world the size of the operand remaining to be transferred by the MC68020's internal bus controller. Because of the hardware convention employed, these operand size

pins may be combined with the low-order two address bits to generate the needed byte selects. The MC68020 dynamic bus sizing feature, which is enabled by encoding the data transfer acknowledge signals (DSACK0/1), allows the memory port size to change from 8 to 16 to 32 bits on a bus-cycle-by-bus-cycle basis (with one undefined-reserved encoding). Also, the MC68020 supports operand misalignment to the byte level.

The major difference in the external bus cycles is that the MC68000/008/010/012 execute a minimum bus cycle in four clock cycles, while the MC68020 executes its minimum cycle in only three clock cycles (see figures 5 and 6). Because of the asynchronous nature of the bus, it is a simple matter to mount an MC68020 on an adapter board that is plug-compatible with any other of the MPUs, and the MC68020 can be plugged into an MC68000, MC68008, MC68010, or MC68012 socket and can operate the bus of an existing system. Thus, hardware compatibility is maintained within the family, and any peripheral device that works with an MC68000 also works with any of the other family members.

### SPECIFIC FAMILY ENHANCEMENTS

Aside from the MC68010 architecture's support of virtual memory and virtual machines, the MC68010/012 also implemented a form of caching called "loop mode" to assist in the execution of repetitive functions such as block moves and string operations. This loop mode allows certain code sequences to be latched in the processor's internal pipeline, thus allowing two-clock-cycle accesses of the instructions—a 50 percent savings—while at the same time freeing band-

Table 5: Transfer bus signals.

| Signal Name<br>Function   | MC68000 | MC68008 | MC68010/012 | MC68020  |
|---------------------------|---------|---------|-------------|----------|
| Address strobe            | AS      | AS      | AS          | AS       |
| Data strobe               | UDS/LDS | DS      | UDS/LDS     | DS       |
| Data transfer acknowledge | DTACK   | DTACK   | DTACK       | DSACK0/1 |
| Operand size              | n/a     | n/a     | n/a         | SIZ0/1   |

width on the external data transfer bus. The sequences are composed of a 2-byte instruction, such as MOVE or ADD, which is followed immediately by a decrement and branch on condition (DBcc) instruction back to the 2-byte instruction. When the processor recognizes this sequence, it simply recycles the instructions and performs only data accesses to the outside world until the loop is terminated.

In addition to the loop mode, the MC68010/012 implemented special support for program breakpoints. Here, the recognition of a breakpoint bit pattern (one of eight specific illegal instruction encodings) causes the processor to execute a specific CPU space bus cycle during the exception processing for the illegal bit pattern to indicate that a breakpoint has been reached.

The MC68020 takes both of these features (loop mode and breakpoints) one step farther. The MC68020 has an on-chip 256-byte instruction cache, which increases overall processor performance from 40 percent to 80 percent, depending on the locality of reference exhibited by the code being executed. Code showing the greatest locality of reference (e.g., short loops) will show the greatest performance improvement by turning on the cache, while code that exhibits less (or no) locality of reference (long loops or in-line code) will show less (or no) performance increase. The cache is implemented on the MC68020 as a direct-mapped 64-entry by 32-bit cache. The supervisory programmer has control over this new resource by means of the cache control register.

The MC68020 enhancements to the MC68010 breakpoint function not only cause the processor to run the breakpoint acknowledge bus cycle just as before but also allow external hardware to supply a 16-bit instruction op code to be executed in place of taking the illegal instruction trap. This means that the MPU can execute the breakpoint a fixed number of times, substituting the replacement op code each time through the loop until the count expires and the breakpoint halts the loop.

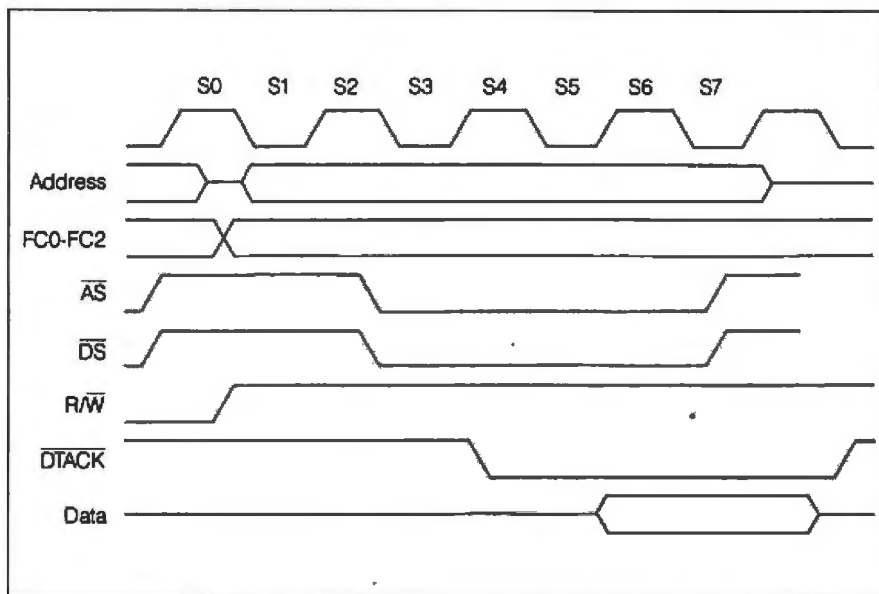

Figure 5: The READ bus cycle for the MC68000, MC68008, MC68010, and MC68012.

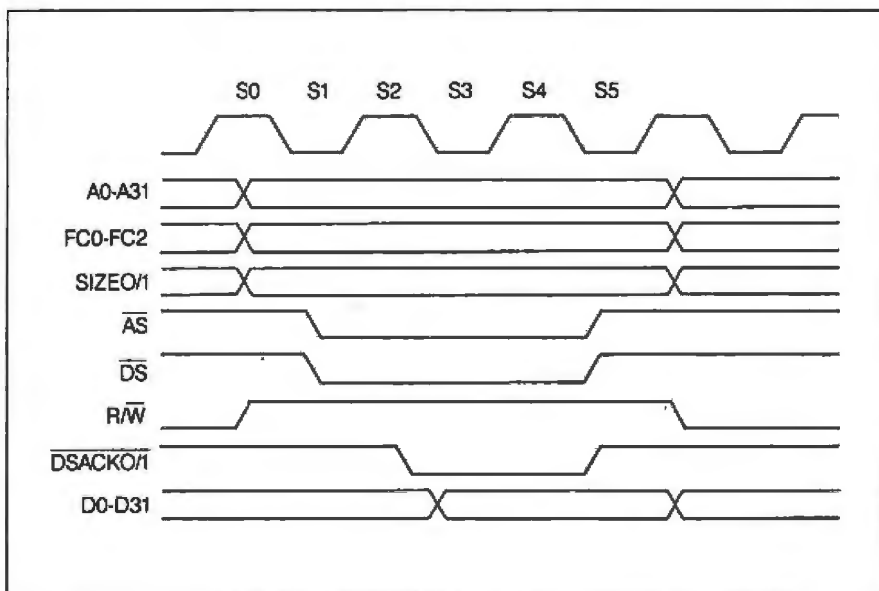

Figure 6: The READ bus cycle for the MC68020.

The MC68020 is the first processor in the family to offer inherent support for coprocessors. This coprocessor interface allows any coprocessor developed for the MC68020 also to be used on any other of the family members. This is accomplished by making the maintenance of the coprocessor interface reliant on standard read/write bus cycles. Because the interface is generic in nature, new processor designs will not require reworking

existing coprocessors, and new coprocessor designs will not require reworking existing processors. In fact, the coprocessor interface gives users of the microprocessor an opportunity to develop their own custom coprocessors.

The extensibility offered by the coprocessor interface is one of the most powerful features of the MC68000 family architecture. Both the pro-

(continued)

## The MC68020 includes microcode support for access permission levels.

processor and coprocessor share in the maintenance of the interface, with each performing those chores for which it is best suited: The processor feeds commands to the coprocessor, transfers data, and calculates effective addresses, and the coprocessor performs its own specialized functions, be that floating-point mathematics, robotics control, Fourier transforms, graphics functions, or anything else. While the MC68020 offers implicit microcode support for the coprocessor interface, emulation of the interface protocol allows coprocessors developed specifically for the

MC68020 to be used as memory-mapped coprocessors (as opposed to CPU-mapped) on the MC68000 and MC68008 or as either memory-mapped or CPU-mapped coprocessors on the MC68010 and MC68012.

The MC68020 also includes microcode support for access permission levels, allowing an operating system (in conjunction with external hardware) to support much finer granularity of permission levels than just user versus supervisory. This feature can support up to 256 levels of permission. A new memory management device, the MC68851, provides the hardware to support eight simultaneous breakpoints (with loop counts up to 256) and up to eight levels of access permission.

In addition, the MC68020 has full 32-bit ALUs and a 32-bit barrel shifter for improved performance on arithmetic, logical, and bit-field instructions. A restructured instruction pipeline with an intelligent, decoupled bus

controller allows a high degree of concurrency in instruction execution with external bus activity.

### CONCLUSIONS

In the final analysis, the name of the game is compatibility. And the bottom line of compatibility between members of the MC68000 family shows that, for user code, all family members are 100 percent upwardly compatible for object code, while supervisory-level code only requires changes in supervisory-level exception handlers that use specific information on the supervisory stacks. Hardware compatibility is also good. In fact, an MC68010 can be directly inserted into an MC68000 socket, and an MC68020 could also be used with the appropriate adapter board.

The MC68000 family provides not only high performance in a commercial microprocessor, but also compatibility, protecting the user's software investment. ■

# This is all it takes to get IBM, Apple, Tandy, Macintosh and Compaq talking to each other.

## And it's simple and inexpensive.



Now a powerful GridNet™ Local Computer Communications Network is as close as your nearest electrical outlet.

Thanks to GridComm's Communicators, virtually any

office can create its own high speed, error-free GridNet™... instantly! There's no need to purchase special system software. And there's none of the expense and inconvenience of installing additional wiring. Because a GridNet™ utilizes your existing electrical grid as a highly-effective data transmission medium.

And a GridNet™ will support IBM PC, XT, AT, and all IBM compatibles, Apple and Macintosh, Hewlett-Packard, Tandy, AT&T, Epson, NEC...all the most popular

micros and peripherals, in the same network. Freely sharing data, with complete connectivity and effective compatibility.

The cost? As much as 60% below that of specially-wired systems.

Find out just how easy it is to increase your office's productivity. See your local dealer, or contact "The Great Communicator" for more information.



For information call 203-790-9077. P.O. Box 2779, Danbury, Connecticut 06813-2779

Trademarks IBM, PC, XT, AT/International Business Machines Corp — Apple/Apple Computer Inc — Macintosh/McIntosh Laboratory Inc — Tandy/Tandy Corp — Compaq/Compaq Computer Corp — Hewlett-Packard/Hewlett-Packard Co — Epson/Epson America Inc — AT&T/American Telephone and Telegraph Co — NEC/NEC Home Electronics (U.S.A.) Inc

# OUR PLUG-IN CARD GIVES YOU PLUG-IN CONTROL.

**PC $\leftrightarrow$ 488** allows your IBM PC/XT/AT or compatible to control IEEE-488 instruments.

## WHAT ADDITIONAL SOFTWARE DO I HAVE TO BUY?

None. **PC $\leftrightarrow$ 488** supports all popular programming languages including interpreted and compiled BASIC, TBASIC™, Microsoft® Pascal, Turbo™ Pascal, C, and FORTRAN. You can use Tektronix® Standard Codes and Formats and emulate HP controller statements.

**PC $\leftrightarrow$ 488** also runs IBM IEEE-488 software as well as application programs.

## IS IT DIFFICULT TO USE?

You just plug it in. **PC $\leftrightarrow$ 488** is totally self-contained with all software packaged in read only memory. Documentation includes a complete tutorial and programming reference, plus more than thirty application programs.

## WILL IT WORK WITH ALL MY INSTRUMENTS?

You bet! More than 500 companies, including every major instrument manufacturer in the U.S. and Europe, are currently using **PC $\leftrightarrow$ 488**.

## WHAT'S THE BOTTOM LINE?

That's the best part. **PC $\leftrightarrow$ 488** costs just \$395 including software support for all popular programming languages, extensive applications library, and the programming and reference manual. Order today by calling (617) 273-1818 or Telex 247316.



**cec**

Capital Equipment Corporation  
10 Evergreen Ave., Burlington, MA 01803.  
(617) 273-1818, Telex 247316.

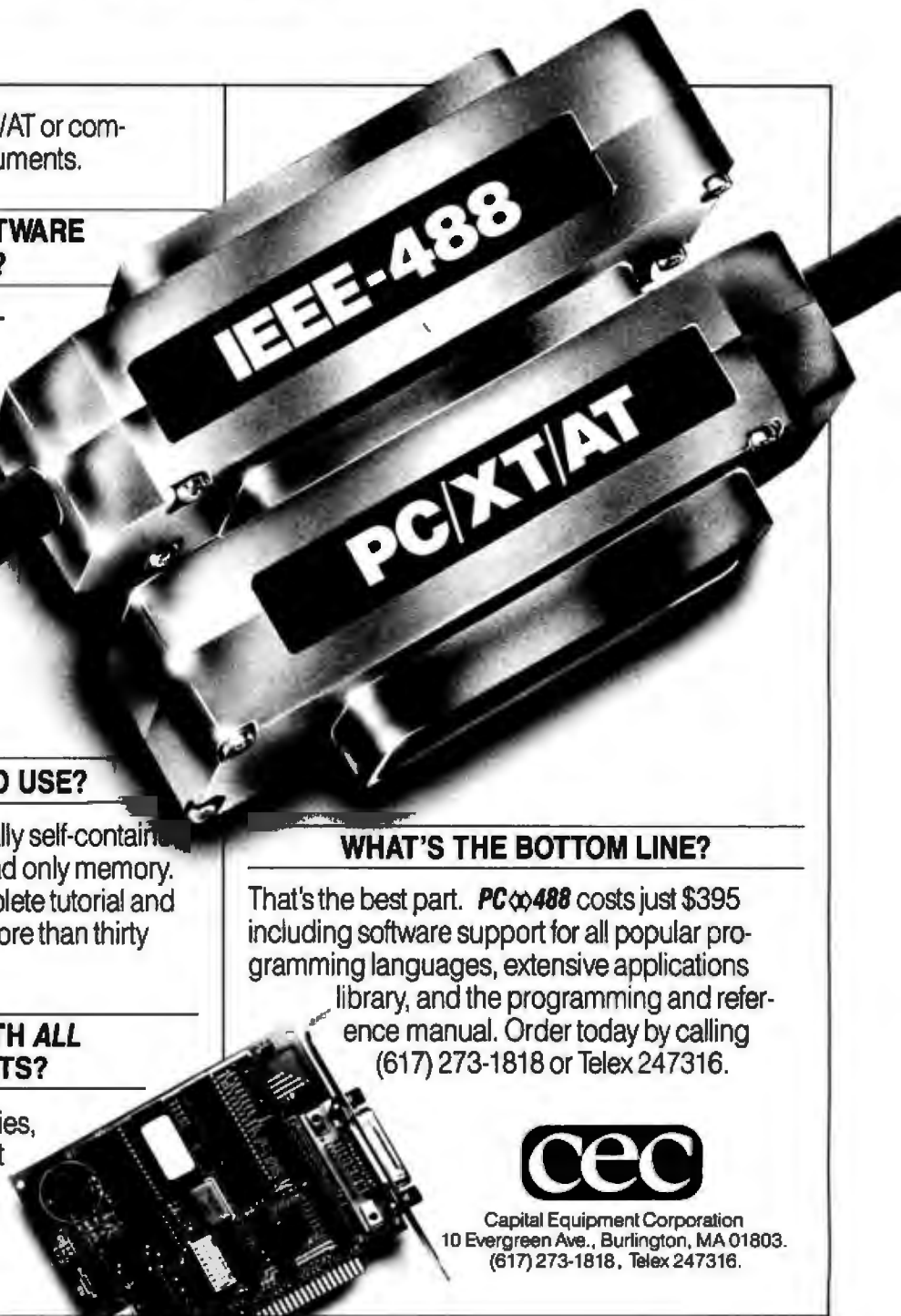

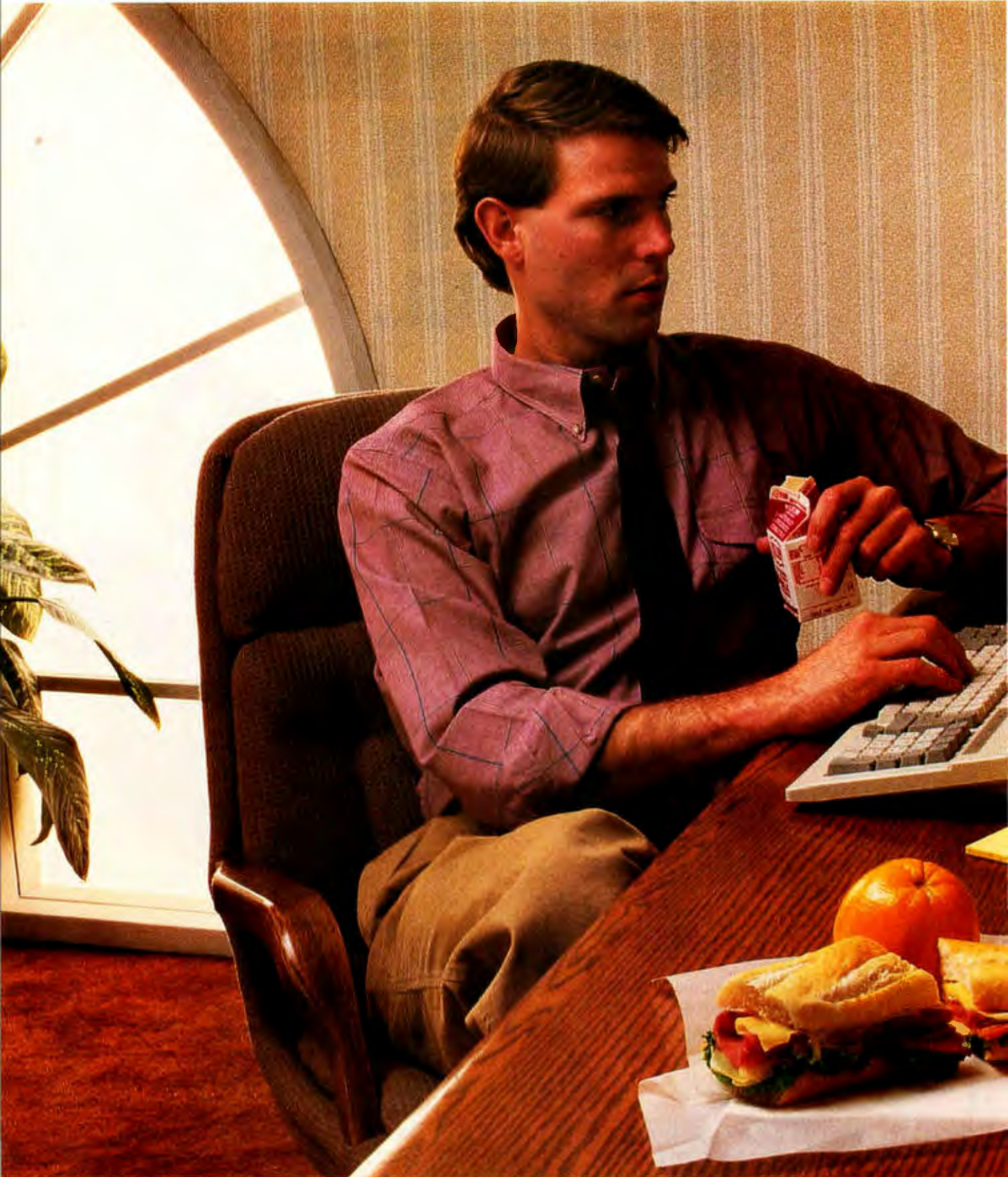

# POWER LUNCH.

**Introducing the new power in AT-class personal computers. The NEC Advanced Personal Computer IV.**

You're very serious about personal computers. You'd rather work through lunch than sit in some lazy cafe.

You're a Power User. And the NEC APC IV™ is the one machine that won't leave you power hungry.

It's built for compatibility and speed, with your choice of 6 MHz or 8MHz processing speeds at the flick of a switch.

It's built for looks, with an incredible 800 x 560 screen resolution.





And it's built for power, with 5 versatile internal storage slots to accommodate two 1.2 MB floppies, two 40 MB hard disks, and a tape back up allowing you the flexibility to tailor the APC IV to your storage requirements.

Plus, the APC IV has the power of NEC behind it. The \$10 billion leader in computers and communications. So you never have to worry about support.

The new NEC APC IV. Because sooner or later, you're going to have to take it to the limit. For more information, call NEC at 1-800-343-4419 (in MA 617-264-8635). NEC Information Systems, Inc., Dept. 1610, 1414 Massachusetts Avenue, Boxborough, MA 01719.

*Take it to the limit.*

**NEC**

Inquiry 253

Actually, we give you two things free.  
Our source code. And your freedom.

Just buy part or all of our excellent integrated business accounting system, the SBT Database Accounting Library.

We'll give you our source code absolutely free.

Which, in turn, gives you the freedom to customize our software to fit your business needs.

Say, for instance, you want to change the way a management report is formatted. Our free source code enables you to change it.

What's more, the change will be quick and simple because our software is written in easy-to-use dBASE.

In fact, the entire SBT Database Accounting Library runs with dBASE III or dBASE II,\* so you get the power and flexibility of those best-selling programs. Plus the freedom to use any computer that runs dBASE.

The SBT Database Accounting Library.  
Great software and freedom. All in the same box.

Call today for our demo disk and brochure.  
(415) 331-9900.

**THE SBT DATABASE ACCOUNTING LIBRARY.**

|               |                           |       |
|---------------|---------------------------|-------|
| dProfessional | Time & Billing            | \$395 |
| dOrder        | Sales Order processing    | \$195 |
| dInvoice      | Billing/Inventory Control | \$195 |
| dStatement    | Accounts Receivable       | \$ 95 |
| dPurchase     | Purchase Order            | \$195 |
| dPayable      | Accounts Payable          | \$295 |
| dPayroll      | Payroll/Labor             | \$395 |
| dLedger       | General Ledger/Finance    | \$395 |
| dAssets       | Asset/Depreciation        | \$295 |
| dProject      | Project/Job Accounting    | \$395 |
| dProperty     | Tenant/Unit Management    | \$395 |
| dBackup       | Menu/Backup               | \$ 65 |

MultiNet versions additional \$200 per module



Three Harbor Drive  
Sausalito, CA 94965  
(415) 331-9900

Call today for the name of the SBT consultant  
in your area.

# Free source code in every box.



Compiled and Multi-User versions also available. dBASE III and dBASE II are registered trademarks of Ashton-Tate, Inc. Copyright 1985, SBT Corporation.

# ATARI ST SOFTWARE DEVELOPMENT

BY MICHAEL ROTHMAN

*A survey of the TOS operating system  
that comes with the Atari ST*

THE ATARI ST is one of several recently introduced microcomputers that use the Motorola MC68000 microprocessor. In this article I'll describe the organization of the ST's operating system, called TOS, and show some ways the 68000 influences it. TOS is approximately 200K bytes. Its organization is somewhat confusing because it has three parts that partially overlap in functionality. The two main parts, GEM (Graphics Environment Manager) and XBIOS (Extended BIOS), were originally designed independently and have somewhat different purposes. GEM, a complete operating system developed by Digital Research, is meant to support applications that are portable to other machines (at this writing, GEM has also been implemented on the IBM PC and compatibles).

The Atari-written XBIOS is meant to support ST-specific capabilities not accessible through GEM. For example, the ST's sound chip can be accessed only through the XBIOS. But in some cases, the differences between GEM functions and XBIOS functions are subtle. (For example, GEM and the

XBIOS each have a function to read or write sectors to devices. The XBIOS function assumes the actual ST disk and is knowledgeable about its physical characteristics; the GEM function supports a number of devices that are logically but not physically similar.)

The third part of TOS, the Atari-written Line A Handler, overlaps almost entirely with the graphics routines of GEM—indeed, GEM graphics routines call the Line A Handler to do their work. The Line A Handler will let programmers write faster graphics routines than with GEM.

I've organized this article around the various parts of TOS, which means that you will sometimes encounter similar functionality discussed in two different places. (See figure 1.)

## **GEM**

Most people probably identify GEM with the icons, menus, and windows of the GEM user interface, called the Desktop. The Desktop, however, is not technically part of the operating system. It is an application, automatically invoked by the operating system

after the system boots.

GEM includes the GEM disk operating system (GEMDOS), the GEM Virtual Device Interface (the VDI—a powerful set of graphics routines), and the GEM Application Environment Services (the AES—a selection of special libraries designed to support the distinctive GEM user interface).

## **GEMDOS**

GEMDOS contains the basic input/output system (BIOS), a disk file handler, and a number of functions to support peripheral devices, memory allocation, and the system clock. The BIOS handles low-level character I/O to five different devices: the printer, an auxiliary device (the RS-232C port), the console, a MIDI port for use with music synthesizers, and the keyboard. The routines read or write a single character to these devices or return status information.

*(continued)*

*Michael Rothman is the manager of software development at Spinnaker Software (1 Kendall Square, Cambridge, MA 02139). He has been programming tools for microcomputers since 1979.*

The BIOS contains a single routine to read and write to appropriate devices on a sector basis (i.e., floppies, hard disks, networks). Two routines detect whether media in such devices have changed and return a map of the devices actually present.

Another routine returns a pointer to the BIOS parameter block (BPB) for a particular drive. The BPB is a block on the disk containing certain disk parameters, such as the number of bytes per sector or the number of directory entries. It is loaded into RAM when the disk is first accessed. The ST BPB is software-compatible with an MS-DOS BPB, right down to the 16-bit quantities in the BPB, which are written in low-byte, high-byte order—8086 style! (The 68000 orders quantities with the high byte in the lowest memory address.) Using the 8086's ordering of the 16-bit quantities in the BPB was presumably done to make porting GEMDOS from the 8086 to the 68000 easier.

Finally, the BIOS contains a routine to set the 68000's exception vectors in the low end of memory, a routine that returns the system timer value, and a routine to set or get the state of Shift and Control keys on the keyboard and the mouse buttons.

**THE FILE HANDLER**

GEMDOS supports a hierarchical file system similar to that of MS-DOS. The file-handling functions are

- Create, open, read, write, seek in, close file.
- Get, set file attributes.

- Create, delete, get, or set a sub-directory.
- Get disk free space.
- Directory search, file rename.

**THE REST OF GEMDOS**

The remaining GEMDOS functions let you

- Handle character I/O on the standard input and output.
- Check the status of a peripheral device.
- Get and set time and date.
- Terminate an application.
- Allocate or deallocate a memory block.

**THE VIRTUAL DEVICE INTERFACE**

GEM's graphics routines, known collectively as the VDI, provide a systematic way to handle a large number of graphics primitives in a device-independent fashion.

Graphics primitives are drawn by software that is tuned to the particular hardware at hand. The software does not simply move a prestored block of pixel data into memory; instead, it takes a mathematically described notion, like a circle with a diameter *x*, and calculates what pixels to change. Thus, if the lower-level software is properly written, closely equivalent results can be produced on different devices.

A wide variety of primitives have been defined in the VDI, and you can instruct the software to draw them with various attributes by using the portable VDI routines (the portable portion is sometimes called the

Graphics Device Operating System, or GDOS). A number of device drivers have been written to support the primitives across several devices.

The VDI routines can "think" in either raster coordinates (RC) or normalized device coordinates (NDC). The raster coordinate system corresponds to the actual target's screen resolution. Thus, if you are working on the ST in its highest resolution, 640 by 400, you can call the VDI routines to place and size objects in terms of this resolution. Alternatively, you can use normalized device coordinates, which are always 0 to 32,767 in both directions, and the software will adjust for the particular device. The trade-off for the additional portability is that the software must do a transform on the object being drawn. The NDC space origin also differs from RC space in that it starts in the lower left corner rather than in the upper left corner of the device.

**WRITING AN APPLICATION USING THE VDI**

The first step in using the VDI is to specify the devices for graphics output. An application must always call the Open Workstation routine for each graphics device that the VDI routines will subsequently manipulate. This function takes an array containing the user's requested defaults for graphics characteristics such as line style, color, character size, fill color, and so on. It is here the developer also specifies the choice of NDC or RC coordinates.

In addition to a device identifier (handle), the routine passes back two large arrays (combined into one in the C language binding) that tell you the device's characteristics (e.g., the number of colors it supports and the size of its pixels in microns) and what VDI functions and attributes it supports.

For convenience, the VDI also provides the ability to open virtual screen workstations so that you can maintain several different sets of default characteristics for the screen device. Each of these workstations is attached to the real screen: Just change which one you specify in your subsequent VDI

(continued)

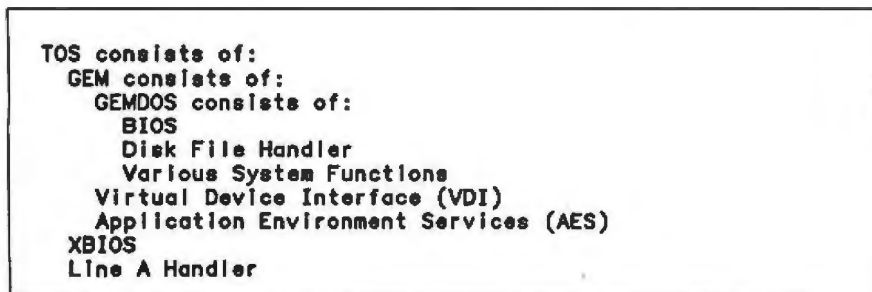

Figure 1: Organization of TOS. GEM is an operating system in its own right, written by Digital Research and implemented across other machines such as IBM PCs and compatibles. The XBIOS and Line A Handler parts of TOS were written specifically for the Atari ST and provide faster and in some cases the only access to the capabilities of the ST.

# Contemporary Electronics Series

The fast, easy and low cost way to meet the challenges of today's electronic innovations. A unique learning series that's as innovative as the circuitry it explains, as fascinating as the experiments you build and explore.

From digital logic to the latest 32-bit microprocessor, the McGraw-Hill Contemporary Electronics Series puts you into the electronic picture one easy step at a time. Fifteen unique Concept Modules, sent to you one every 4-6 weeks, give you a handle on subjects like optoelectronics, robotics, integrated circuits, lasers, fiber optics and more.

Each Concept Module goes right to the heart of the matter. You waste no time on extraneous material or outdated history. It's a fast, efficient, and lively learning experience... a non-traditional approach to the most modern of subject matter.

### Unique Interactive Instruction

With each module, you receive a McGraw-Hill Action Audio Cassette. Each tape is a dynamic discussion that drives home the key facts about the subject. Your learning

With your first module, you get this solderless breadboarding system. You'll use it throughout the series to build electronic circuits and bring concepts to life.



experience is reinforced through interaction with vividly illustrated text, audio cassettes, and actual electronic experiments. Indexed binders preserve backup material, notes, and tapes for convenient referral.

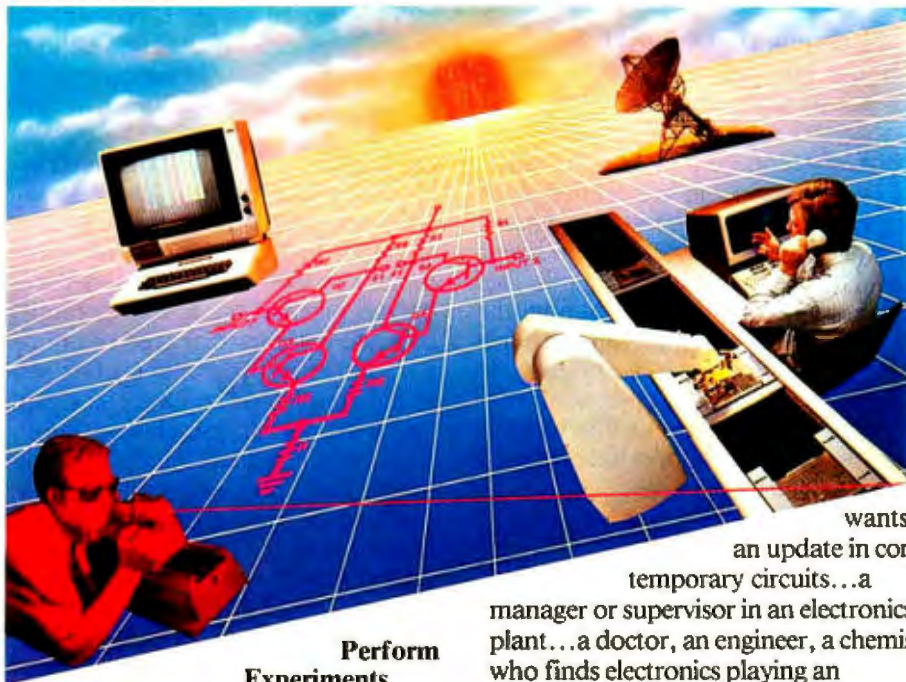

### Perform Experiments in Contemporary Electronics

Throughout your series, laboratory experiments reinforce every significant point. This essential experience... dynamic, hands-on demonstrations of theory in practice... will help you master principles that apply all the way up to tomorrow's latest VLSI (Very Large Scale Integrated) circuitry.

In your very first module, you'll use integrated circuits to build a digital oscillator, verifying its operation with a light emitting diode (LED). You'll learn to identify passive and active components, understand concepts common to all electronic circuits.

### For Anyone Interested in Electronics

The Contemporary Electronics Series is designed for anyone from hobbyist to professional. It's for you if you're looking for new fields of interest... if you're a teacher who

wants an update in contemporary circuits... a manager or supervisor in an electronics plant... a doctor, an engineer, a chemist who finds electronics playing an increasingly important role in your work. It's even for electronics engineers or technicians who feel their training needs freshening up. It's the quickest, most convenient, probably least expensive way to do it. And the only one that gives you hands-on experience.



### 15-Day No-Risk Trial

To order your first module without risk, send the postage-paid card today. Examine it for 15 days under the terms of the order form and see how the Contemporary Electronics Series gets you into today's electronics. If card has been used, write us for ordering information.



McGraw-Hill  
Continuing Education Center  
3939 Wisconsin Ave.  
Washington, D.C. 20016

routine, and the defaults will change appropriately.

The VDI functions themselves are too numerous to describe in detail, but most of them can be considered under three headings: graphics primitives, attribute functions, and text functions.

### GRAPHICS PRIMITIVES

You can draw graphics primitives, such as a square, a polyline, or a rounded rectangle, after specifying the appropriate attributes for each. Size and endpoints are defined in the chosen coordinate system and passed to the routine. Several of the primitives have their own routines, but most of them are grouped under the Generalized Drawing Primitive function. Primitives can be grouped to form more complex objects, and sophisticated graphics can thus be built.

The primitives supported on the ST are

*Polyline:* Draws straight lines connecting endpoints defined in an array passed to the routine.

*Polymarker:* Only the endpoints are drawn, and several different graphics (markers) are available to represent those points.

*Text:* Note for novice programmers: isn't it nice to know you have been using a graphics primitive all along?

*Filled area:* The area is a complex polygon, again specified in an input array.

*Contour fill:* A seed fill.

*Generalized Drawing Primitive:* The GDP is a single entry point for the following primitives: bar, circle, arc, pie, ellipse, elliptical arc, elliptical pie, rounded rectangle, and filled rounded rectangle. If you are programming in C with the Atari-supplied developer's package, these are bound as separate functions.

*Justified text:* Can be justified left or right.

### ATTRIBUTE FUNCTIONS

The attribute functions of the VDI manipulate characteristics of the graphics primitives. The developer can set color for both fills and lines. The polyline width is variable, as are the type of line (e.g., dashes or dots can

be substituted for a solid line) and the end type (arrow, squared, or rounded). The polymarker function, which essentially lets you draw a connect-the-dots figure, is supported by an attribute function to change the type of "dot" or marker.

One of the most important attributes that can be set is the writing mode. This determines the relationship of a new image to the raster area it overlays. When you draw a new graphic, whatever the method, you can think of it as a mask of 1s and 0s laid over the display. Each corresponding pixel on the device will be affected. In the simplest case (the replace mode), each pixel under a 1 on the mask is set to the currently selected color for that type of primitive, and each pixel under a 0 is set to the current background color. But the developer can also choose one of three other modes. In transparent mode, only the pixels under 1s are changed. In reverse transparent, only the pixels under 0s are changed. And in XOR mode the mask value is exclusive-ORed with the value on the display. (Twelve additional modes are available through the Line A Handler, described below.)

All the attribute functions take effect for all subsequent relevant graphic operations, until the developer changes the attributes once again.

### TEXT FUNCTIONS

The VDI provides two ways to handle text. One is an Alpha mode with its own set of functions, which on the ST implements an 80-column by 25-row text mode (in high and medium resolution). Alpha mode is not compatible with most of the other VDI functions; that is, you cannot display other graphics with text in this mode.

Much more interesting is text handling within the normal graphics mode, where text and graphics can be completely intermixed. The VDI supports two basic text output functions (regular and justified) and a sophisticated set of attributes, including multiple fonts (two are built into the ST, more have been developed by third parties). The developer can change the character height absolutely (in terms of the chosen graphics coordi-

nate system) or in "points," the system used in print shops. The baseline of the character can be set at various angles (thus allowing rotated characters—on the ST, only multiples of 90-degree rotation are supported). And the characters can be thickened, skewed, underlined, outlined, or shadowed. In addition, text attributes include the standard VDI characteristics such as color and write mode.

### THE GEM APPLICATION ENVIRONMENT SERVICES

The AES is an umbrella name for several libraries of routines, most of which implement various data abstractions for the developer. That is, some of these "services" gather together functionality available elsewhere in GEM to express useful concepts, such as windows or events.

But the AES also includes the part of GEM that manages the interaction between application and certain system capabilities that run concurrently. As a developer, you rarely need to think about this limited multitasking, precisely because it is limited and exists mainly to service system needs. Those needs are the desk accessories and the Screen Manager.

GEM supports several desk accessories: tasks that are selected by the user from drop-down menus, each of which occupies its own window. It also supports the Screen Manager, an application that runs concurrently with whatever else is going on and monitors user interaction with the menus and window borders.

The AES functions also comprise an event library, a window manager, several libraries for managing certain graphic data structures, a scrap library, a shell library, and a resource library.

### THE EVENT LIBRARY

Macintosh developers will be familiar with the concept of an event manager. On that machine, the ideal program is seen as a loop. During each pass through the loop, the Mac waits for any one of several "events" specified by the developer, usually keyboard activity or mouse movement/selection, responds appropriately, and

(continued)

# With one Hayes Transet 1000<sup>®</sup> you can do three things at once.



## Think

*You can keep working with your computer.*



## Communicate

*While receiving electronic messages from your modem.*



## Print

*While your printer is printing another job.*



© 1986 Hayes Microcomputer Products, Inc.

\*Manufacturer's estimated retail price.

*We call it triple tasking.<sup>™</sup>* Transet 1000 helps your productivity, by allowing you to perform three separate computer tasks. Simultaneously. No more waiting for one task to be completed before you can begin another. And no more wasted time!

Transet 1000 keeps working for you—even when your computer is turned off. Because it has its own independent memory, Transet 1000 can serve as an electronic mailbox. Your files and incoming messages received through your modem remain stored overnight,

or whenever you're away from the office. When you return, you can print out your mail without turning your PC on. Or, read it on your PC screen and print out only selected messages. You can even read your mail from any remote PC or terminal with a modem.

Before now, you would have had to buy several add-on devices to do

all this. And *that* could be costly.

But no more. Transet 1000 does it all—for a surprisingly low price. It costs only \$399\* for the 128K model, which stores up to 90 pages. And only \$549\* for the 512K version, with up to 360 pages of storage.

So wait no more. If you need this flexibility in your operation, you should have a Transet 1000. See your authorized Hayes dealer for a demonstration. Or contact Hayes for information at 404-441-1617.

Hayes Microcomputer Products, Inc., P.O. Box 105203, Atlanta, Georgia 30348.

# Hayes<sup>®</sup>

Say yes to the future

then goes to the top of the loop.

Although GEM is much less radically tied to a particular programming style, the event library has a similar function on the ST. At any point in your program, you can specify an event or events you are interested in waiting for, and the multitasking dispatcher will suspend your application until one of those events occurs. The events included could be a simple keystroke or perhaps the straying of the mouse cursor into and out of a rectangle defined by your application.

Giving your program the information it needs to do its part is the job of the message events. To wait for certain events, you call a routine specific to the event in question. For more complex events, particularly those concerning user interaction with screen windows, you call a routine that waits for a "message" from the AES. A message is a multibyte code that is placed in a buffer whose address you pass to the routine. Pre-

defined system messages tell you, for example, that the user has taken an action that necessitates redrawing part of one of your windows. (For example, the user has moved a window that was partially covering a second window. The second window is now more exposed, and the newly exposed area should be redrawn.)

**THE WINDOW LIBRARY**

To quote the GEM documentation, "A window is an area with clearly defined boundaries." Anyone who has worked with the Macintosh or one of the user interfaces that mimic it will be comfortable with the GEM window concepts, which (as of this writing) included the familiar title bar, close box, scroll bars, and size box. The creation, care, and feeding of windows is handled by the routines in the window library. In general, the GEM division of responsibility for the user interface is that the developer is expected to handle and update the work area in-

side a window's frame while GEM handles the drawing and updating of the frame itself, including, for example, the scroll bars, the title bar, etc. [Editor's note: A program that illustrates a fair amount of window work is available, along with the two listings printed in this article, in a variety of formats. See the insert card following page 368 for details.]

**LIBRARIES TO SUPPORT THE USER INTERFACE**

The AES contains a number of routines concerned with manipulating various graphic data structures that your application can use for a standard user interface. For example, the File Selector Library provides a standard dialog box that lists the files on a disk device and allows you to select one. The Graphics Library is concerned mainly with drawing boxes on the screen. For example, it will draw an expanding box outline that your application can use to make a window or other rectangular object appear to



**A Personal Language**

When it comes to problem solving, the APL\*PLUS System is the undisputed leader.

That's because the APL\*PLUS System works with you. It goes far beyond what application software like Lotus® or dBASE® could possibly ever offer. And, it won't tie you down with the details of standard programming languages.

The APL\*PLUS System is a personal language, with productivity features that help you concentrate on getting answers,

rather than struggle with intricate calculations and modeling.

With it you can manipulate tables of numbers as easily as single numbers and get quick results from your computer using short, simple statements.

When you've reached the limits of other packages, move up to the APL\*PLUS System. It's a powerful and flexible tool that grows with you as your needs become more sophisticated. With over 200 built-in

applications—like graphics, report formatting and communications—you have all the tools at your fingertips to quickly and easily solve those seemingly impossible problems.

Best of all, the APL\*PLUS System interfaces well with software packages you're already using—like databases, spreadsheets, and graphics packages. The APL\*PLUS System also makes it easy to link those packages that aren't



grow quickly out of some other object. This is what the Desktop does when you click on a disk icon and it "grows" into the disk's file window.

The Object Library is a macro facility that lets you create complicated graphic structures and link them in a single "object tree." For example, say you want to display a small rectangular box within a somewhat larger box on the screen and you also want to place text in the smaller box. You can do all this by calling the appropriate VDI graphics primitives. But alternatively, you can use the Object Library of the AES, which will let you define the whole thing in a well-documented tree structure. This has the advantage that the entire tree can be repeatedly drawn and reused in the application with only a single call each time. Furthermore, you can specify that only certain levels within the tree will be drawn.

The routines in the library support the construction of the tree and the

reordering or deleting of its nodes. The library also offers various kinds of user interaction with on-screen objects, such as a routine that will tell you what object is currently under the mouse cursor and another one that lets you edit text in an object.

The Form Library uses object trees to implement more sophisticated user interactions. A form is an object tree designed for user input. A good pre-defined example of an object tree is the simple form that appears on the Desktop if the user decides to format a disk. The form is a box containing text that asks the user to confirm the format request and two small boxes containing the words O.K. and Cancel. (Boxes of this sort that contain mutually exclusive options are called "radio buttons.")

To use a form, the program calls the basic form routine, with an index of the desired object tree as argument. The AES takes over until the user selects an object that the developer

has defined as an "exit object" (such as the O.K. or Cancel boxes in our example). Until that time, the AES handles the user's input, which can be of three types: the radio buttons, "check boxes"—boxes containing options that are not mutually exclusive, or text. On exit from the form routine, the application can examine the form to see what changes have taken place.

**THE RESOURCE LIBRARY**

Applications can share objects and object trees between applications or keep them conveniently modular through use of the Resource Library. For developers, Atari provides the Resource Construction Set, which allows on-screen construction of objects and other types of resources.

**THE SCRAP LIBRARY**

The Scrap Library allows developers to share certain kinds of data among applications. It supports the AES im-

(continued)

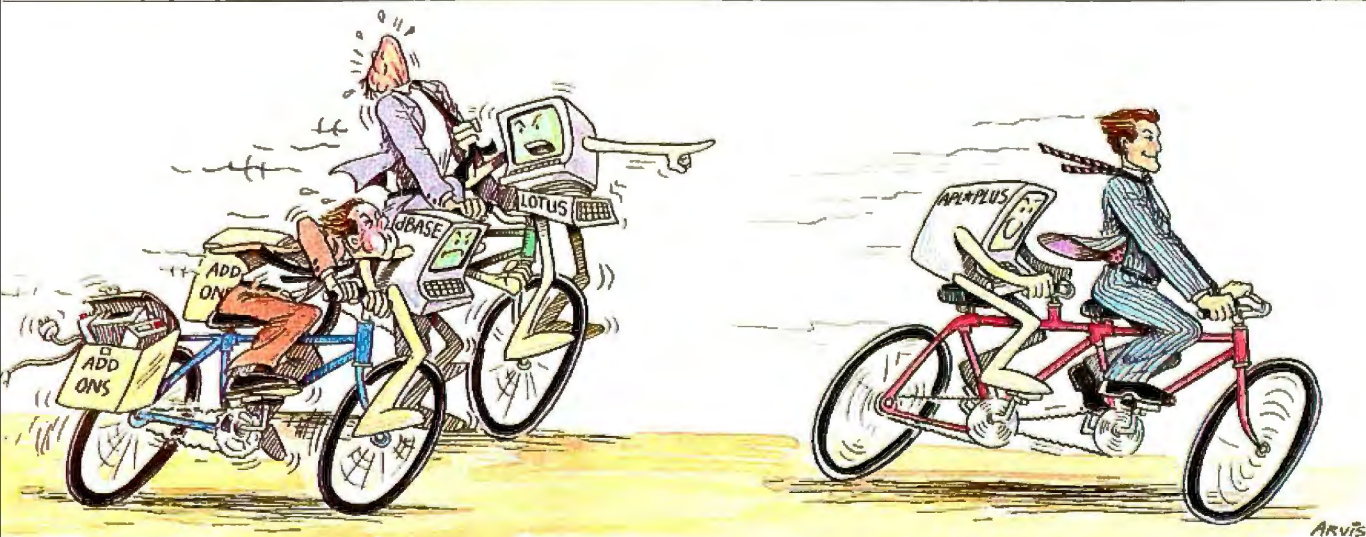

**The APL★PLUS® System and You.**

currently talking with each other. With all this problem-solving power, it's no wonder STSC's APL★PLUS System is the personal choice of so many business professionals—financial planners, business analysts, actuaries, scientists, mathematicians, engineers, statisticians, and consultants. Especially since the APL★PLUS System is available on a full range of computers from desktops to mainframes.

Put the power, speed, and flexibility of the APL★PLUS System to work for you. See your local dealer today to get your APL★PLUS System. If they don't have it, refer them to STSC or call STSC toll-free, (800) 592-0050. In Maryland or Canada, (301) 984-5123.

Available nationally through Softset, Micro Central, and distributors worldwide. Dealer inquiries welcome.

*Problem-Solving at the Speed of Thought*

**STSC** STSC, Inc.  
2115 East Jefferson St.  
Rockville, MD 20852

APL★PLUS is a service mark and trademark of STSC, Inc. PLUS★WARE is a trademark of STSC, Inc. Lotus and dBASE are registered trademarks of Lotus Development Corporation and Ashton-Tate, respectively.

**A PLUS★WARE™ PRODUCT**

©1986 STSC, Inc.

Listing 1: This is a routine to format a floppy disk on the ST. If the formatting is successful, the routine will return a 0.

```

/* #define DEBUG 1 */
#include <osbind.h> /* C bindings for OS routines */

#define HITRACK 79 /* Highest numbered track */
#define SECTORS 9 /* Sectors per track */
#define MAGIC 0x87654321L /* Required by Flopfmt() */
#define VIRGIN 0xE5E5 /* Pattern to write to sectors */
#define ILEAVE 1 /* Interleave factor */
#define DISKTYPE 2 /* Single side, 80 track */
#define NOLOAD 0 /* No loader code */
#define RANDOM 0x1000000L /* Protobt makes a random */
#define BOOTSECT 1 /* Side 0, sector 1 */
#define TRACK0 0 /* Track for boot sector */
#define SIDE0 0 /* Format side 0 */

extern void errprint(); /* error notification routine */

format(devno)
int devno; /* device holding media to format */
{
/* Automatic variables */
/* count tracks */
register int i;
/* buffer for track, protoboot */
register char *buf;
/* success in format? */
register int succ, totsucc = 0;
/* doesn't do anything */
long filler;

/* Code */
/* Allocate memory for track. The ST formats one track at
a time and requires sufficient RAM to verify that track in
memory. Malloc is a GEMDOS call. */
buf = Malloc(8192L);
if (buf == 0L)
{
#ifdef DEBUG
errprint(0, "Insuff memory for format");
#endif
return(-1);
}

/* Format each track. VIRGIN is the value to write to the
newly formatted track. This particular value (0xE5E5) is
suggested in the documentation, but many values are
possible. Flopfmt is XBIOS. */
for (i=HITRACK; i>=0; i--)
{
succ = Flopfmt(buf, filler, devno, SECTORS,
i, SIDE0, ILEAVE, MAGIC, VIRGIN);
totsucc += succ;
}

/* Release memory. GEMDOS */
Mfree(buf);

/* For the purposes of this routine, I won't accept any bad
sectors. But, if there were any, their numbers would have
been left in the buffer after each track was formatted.
Alternatively, I could have retried or recorded the bad
sectors if I were developing my own file system. */

```

(continued)

plementation of several standard data types. If you use these, your application can exchange information with other applications through a cut-and-paste mechanism.

### THE SHELL LIBRARY

The Shell Library contains routines to allow the chaining of applications.

### THE EXTENDED BIOS

The XBIOS provides more direct access to the ST's hardware than anything in GEM (which, after all, has to be portable). The XBIOS provides functions to read, write, verify, and format the floppy disks on a sector basis. Unlike the BIOS read/write function, these are not device-independent but are designed for the floppy disk drives only. They work for single- or double-sided drives. The format routine gives the caller specific information on bad sectors. Listing 1 is a routine to format an entire disk.

### SCREEN PARAMETERS

The XBIOS also handles various video screen parameters. The ST screen memory occupies 32K bytes in memory. Initially, the physical screen base address is set to the top 32K bytes of memory, but the XBIOS has a routine to set that base on any 256-byte boundary. You can also set a logical base that the GEM and Line A graphics routines will use as their understanding of where the screen memory begins. Other routines let you set the screen resolution to one of three values:

640 by 400 pixels, monochrome  
640 by 200 pixels, 4 colors  
320 by 200 pixels, 16 colors

TOS knows what kind of monitor is attached to the system and will refuse to set the monochrome resolution if the color monitor is attached, or vice versa.

Two other XBIOS routines let you set the ST's palette. The palette has 16 entries. Three bits of information are stored for each entry for each of the three primary colors, red, green, and blue. Therefore, the lowest and highest values for each palette entry are (in octal) 0 and 777. In other

(continued)

# Explore AI on your PC

Smalltalk/V transforms your PC into a versatile AI workstation

Only Smalltalk/V lets you experience the thrill of a responsive AI workstation while learning artificial intelligence techniques and using them to create practical applications.

**"Smalltalk/V gives me the feel of an AI workstation on my PC."**

—Darryl Rubin,  
Technical Editor,  
AI Expert  
Magazine



**"Smalltalk/V is the highest performance object-oriented programming system available for PCs."**

—Dr. Piero Scaruffi  
Chief Scientist  
Olivetti Artificial Intelligence Center

**\$99.00**

## Smalltalk/V Features

- High-performance object-oriented programming
- Integrates object-based and rule-based programming with object-oriented Prolog
- A user-extensible, open-ended environment
- A responsive graphical user interface
- Supports exploratory programming and prototyping
- Class hierarchy with inheritance creates highly re-useable code
- Smalltalk source code included, with browser windows for easy access and modification
- A huge toolkit of classes and objects for building a variety of applications
- Object-swapping creates virtual memory on hard or RAM disk
- Bit-mapped graphics with bit and form editors
- A sophisticated source-level debugger
- Automatic change log for easy recovery from errors
- Powerful directory/file browser system for organizing DOS files
- Optional communications interface to Unix™ and other systems
- Access to other languages and DOS functions
- DOS command shell
- Detailed owner's manual designed for both beginners and advanced programmers

Watching someone use an AI workstation is a vision of what the computer was meant to be. Fingers dance across the keys as windows dilate, shift, overlap, and disappear on the bit-mapped display. Ideas spring to life as program fragments execute, are modified, expanded, combined and tried again in a creative arabesque of text and graphics. The interface vanishes, man and machine are one. Smalltalk/V brings that experience to your IBM-PC.

**"We use Smalltalk as our primary language for teaching artificial intelligence."**

—Dr. John Pugh  
Director, School of Computer Science  
Carleton University

Of the three main AI languages, Smalltalk, LISP, and Prolog, only Smalltalk was intended for individual use on a personal computer. Only Smalltalk was designed to provide a match between human and computer models of reality. Only Smalltalk is easy to learn, easy to read, and easy to use.

**"We found Smalltalk/V excellent for developing advanced decision-support tools based on decision analysis and AI techniques."**

—Dr. Samuel Holtzman,  
Professor, Stanford University

Smalltalk/V is pure object-oriented programming — a powerful tool for designing frame/script-based knowledge representations, inference engines, expert systems, simulation environments, intelligent interfaces, network control software, communications interfaces, and much more.

Methods, our character-based Smalltalk, is now available for \$79. It has all of the features of Smalltalk/V except graphics, rules, source-level debugger, and object-swapping. However, it supports color, includes the communication package, and does not require a mouse.

BYTE and BIX are trademarks of McGraw-Hill, Inc. IBM, IBM-PC, and IBM PC-AT are trademarks of International Business Machines Corporation. Unix is a trademark of Bell Laboratories.

Inquiry 107

**YES!** I want to turn my PC into an AI workstation. Send me . . .

Smalltalk/V . . . . . \$99

Communications for Smalltalk/V . . . \$49

Methods (including Communications) . . . . . \$79

Shipping and Handling . . . . . \$

CA residents add applicable sales tax . . . . . \$

TOTAL . . . . . \$

Shipping and Handling  
U.S., Canada, and Mexico . . . . . \$ 5.00  
Elsewhere . . . . . \$15.00

I enclose  Check  Money Order

Credit card information  MC  VISA

Number: \_\_\_\_\_ Expiration: \_\_\_\_\_

Signature \_\_\_\_\_

Name: \_\_\_\_\_

Street Address: \_\_\_\_\_

City/State/Zip: \_\_\_\_\_

Phone: \_\_\_\_\_

NOT COPY PROTECTED, 60-DAY MONEY-BACK GUARANTEE  
ON-LINE USER-SUPPORT CONFERENCE ON BYTE'S BIX™

Smalltalk/V requires DOS and 512K RAM on IBM PCs (including AT) or "compatibles," a Microsoft or compatible mouse, and a OGA, EGA, Hercules, or AT&T Hi-Res graphic controller.



5200 West Century Boulevard  
Los Angeles, CA 90045 (213) 645-1082

**800-222-8324**

**Hard Drive Blowout!**

10 Meg  
\$369

20 Meg  
\$395

30 Meg  
\$595

Seagate All Drives Seagates w/ Controller

**Other Specials**

- 20 Meg Hardcard (uses 1 slot) .... \$599
- 20 Meg Seagate for "AT" ..... \$549
- 30 Meg for "AT" ..... \$549
- 20 Meg Tape (Teac) w/cont. & soft \$595
- 65 Meg Tape (3m) w/cont. & soft .. \$695

**MONITORS**

- MITSUBA**
- 510A TTL Amber ... \$99
  - w/Tilt & Swivel Stand
  - 160A Composite
  - 12" ..... \$99
  - Amber w/Tilt & Swivel Stand

- SAMSUNG**
- Amber TTL 12" ..... \$89
  - Green TTL 12" ..... \$85
  - Amber
  - Composite 12" ..... \$79
  - Green Composite ... \$79

**brother.**

- M1509 NEW**
- M-1109 ..... \$195
  - HR-15XL ..... \$360
  - HR-25 ..... \$499
  - HR-35 ..... \$680
  - Twinriter-5 Dual Head ..... \$ Call



**EPSON**

- LQ-800 ..... \$545
  - LQ-1000 ..... \$765
  - LQ-1500 ..... \$999
- Accessories Available

**Epson Products**

- LX-80 ..... \$220
- FX-80+ ..... \$259
- FX-85 ..... \$ Call
- JX-80 ..... \$349
- FX-286 ..... \$ Call

**Okidata**

- 182 ..... \$299
- 192 ..... \$399
- 193 ..... \$599
- 84 ..... \$699
- 2410 ..... \$ Call

**Panasonic**

- KXP 1080 .... \$199
- KXP 1091 .... \$238

**BLOWOUT**

**Computers (IBM Compatibles)**

- |                          |                       |      |       |
|--------------------------|-----------------------|------|-------|
| IDS PC-XT 8088           | Base                  | Mono | Color |
| IDS Turbo 8 Mghz         | \$595                 | 795  | 995   |
| 2 Drives MS-Dos          | \$649                 | 895  | 1095  |
| IDS AT                   |                       |      |       |
| 11.2 Meg Floppy/M.S. Dos | 1495                  | 1695 | 1895  |
| Leading Edge             | Call for Lowest Price |      |       |
| AT&T 6300                | Call for Lowest Price |      |       |
| Epson Equity I, II, III  | Call for Lowest Price |      |       |

**Everex Products**

- Everex 1200 Modem ..... \$149
- Everex Edge Card ..... \$199
- (Mono-Graphics-Color)
- Everex Mini Magic Card ..... \$129
- (W/384k 1/2 slot)
- Everex Magic Multi-function ..... \$99
- (Six Pac Clone)

**CARDS & ACCESSORIES for IBM**

- Mono/Printer \$95.00
- Color/Printer \$99.00
- Mono/Graphics/Printer \$99.00
- RS-232 ..... \$59.00
- RS-232/Clock \$69.00
- Parallel ..... \$59.00

**1-800-222-8324**

**COMPUTERS INTERNATIONAL**  
**6619 U.S. 1 Miami, FL 33143**  
**IN FLORIDA CALL (305) 667-5936**

**In Chicago: Suite 240**  
**343 West Erie, Chicago, Illinois 60610**

**ATARI ST SOFTWARE**

```

if (totsucc != 0)
{
#ifdef DEBUG
errprint(totsucc, "format failed");
#endif
return(-1);
}

/* Now we need to put a boot sector on the disk. */
/* Allocate a 512-byte buffer */
buf = Malloc(512L);
/* Prototype a boot sector in that buffer. The second
parameter is a serial number for the disk. The value I
have chosen asks the XBIOS to generate a random number.
XBIOS */
Protobt(buf, RANDOM, DISKTYPE, NOLOAD);
/* Write out the boot buffer to track 0, side 0. Last
parameter is how many sectors to write. */
succ =
Flopwr(buf, filler, SIDENO, BOOTSECT, TRACK0, SIDE0, 1);
/* Throw away memory */
Mfree(buf);

/* Return success or failure */
return (succ);
}

```

words, your 16 colors can be selected from a total of 512.

**SOUND**

Four routines in the XBIOS manipulate the ST's sound chip, which is the Yamaha Programmable Sound Generator (PSG) YM2149. The sound chip has two general-purpose I/O ports, which the BIOS uses for both floppy selection and some serial port functions; two of the routines are concerned solely with setting bits in one of these ports.

The chip has three sound channels and 16 registers. The third routine lets you set the registers to select

- The frequency for each channel.
- The volume for each channel.
- Either white noise or pure tone for each channel, or a combination.
- One of 16 envelope shapes.

- The frequency with which the envelope is applied to the basic sound waveform.

The last two points are of some interest: Although the PSG cannot manipulate the components of a sound envelope directly (i.e., the attack, decay, sustain, and release values), the ability to switch between different preset envelope shapes and manipulate their frequency gives you the ability to produce unusual sounds.

The final sound routine, `dosound()`, gives you access to a mini control language for the sound chip that is implemented in the TOS software. By developing a list of commands, you can set any register on the chip, specify a sequence of tones, volume changes, envelopes, or any of the other parameters available through the chip. The `dosound()` routine sets a pointer to an area of RAM where you have placed such a list of sound commands. The software takes over and runs your commands at 50-Hz intervals (actually every fourth instance of a 200-Hz interrupt that is set up off the 68901 timer chip and used by TOS for a number of functions). One of the commands allows you to specify how many ticks should go by until the next command is executed.

**THE LINE A ROUTINES**

The Line A Handler is not part of GEM but the result of Atari's realization that it could provide faster access to some of the routines that support the GEM VDI. These routines are assumed to be used from the assembly language level. They are known collectively as the Line A Handler because access is through the 68000's unimplemented instruction exception handling. The 68000 recog-

(continued)



# How I work three times faster without raising a sweat.

accounting, finance, and other business professionals. And the only company offering a full line of turbos. They've even got a super high-performance PCturbo 286e with *five* times the speed of the PC. Nice to know, in case the work really piles up.

**ORDER YOUR TINYTURBO TODAY.  
IT WILL PAY  
FOR ITSELF IN FOUR WEEKS.**

**I** always considered myself a 'power' PC user. But waiting for the system to load and recalculate spreadsheets, post accounts, and sort databases, was holding me back.

Then I installed Orchid's TinyTurbo 286 high-performance accelerator. It's tiny in size: just a half slot card. And tiny in price. But there's nothing tiny about the performance: now my programs run three to four times faster than before. So I get AT performance without the AT price. And without the downtime of transferring my files to a new system.

I count on my PC every day. So I was glad to learn that TinyTurbo 286 is made by Orchid—the leading manufacturer of turbo products for

|                     | IBM XT                     | WITH TINYTURBO              |
|---------------------|----------------------------|-----------------------------|
| Post 700 accounts   | 12 sec/acct<br>(2.3 hours) | 3.5 sec/acct<br>(0.7 hours) |
| Sort 10,000 records | 25.4 minutes               | 14.9 minutes                |
| Spreadsheet recalc. | 44 seconds                 | 14 seconds                  |
| Integer calculation | 10 minutes                 | 3 minutes                   |

I used to panic when my boss asked me to work up some additional reports an hour before a big meeting. Now I just smile and say, "no sweat."



**WHEN YOU SAY TURBO,  
YOU MEAN ORCHID.**

# TinyTurbo 286™

TinyTurbo 286 and PCturbo 286e are trademarks of Orchid Technology  
IBM is a registered trademark of International Business Machines Corp

47790 Westinghouse Drive, Fremont, CA 94536  
(415) 490-8586 TELEX 709289

Inquiry 258

# WHEN YOU NEED ACCESS TO FULL MEMORY, STRUCTURE, COMPATIBILITY WITH GW- & PC-BASICA, OR WHEN YOU NEED THE POWER AND FLEXIBILITY OF C OR PASCAL...



... You need BetterBASIC. The BetterBASIC compiler has become the standard by which other BASICs are evaluated. BetterBASIC is completely compatible with GW-BASIC and PC-BASICA when running on IBM PC's and true clones. You can load and run your existing BASIC programs in BetterBASIC. It uses standard MicroSoft syntax and gives you more than 150 additional statements such as XREF, DEFINE WINDOW, MAKE MODULE, and PROCEDURE. In benchmark comparisons, BetterBASIC is five times faster than interpreted BASIC. There is optional 8087/80287 math chip support, and an optional Runtime System to create stand-alone

EXE. files. BetterBASIC is not copy protected. Technical support is provided for all registered users.

See for yourself why Dick Aarons of *PC Magazine* said "BetterBASIC may be the best of all BASIC programming worlds" and selected BetterBASIC as "Editor's Choice" (Oct. 29, 1985).

|                              |       |
|------------------------------|-------|
| BetterBASIC                  | \$199 |
| 8087/80287 Math Chip Support | \$99  |
| Runtime System               | \$250 |
| Sample Disk with Tutorial    | \$10  |

Ask your dealer or call to order:

**1-800-225-5800**

In Canada, call 416-469-5244

**Summit Software Technology, Inc.™**  
106 Access Rd. Norwood, MA 02062

BetterBASIC is a registered trademark of Summit Software Technology, Inc. IBM PC, XT, AT are registered trademarks of International Business Machines Corp. Microsoft is a registered trademark of Microsoft Corp. Tandy is a registered trademark of Tandy Corp.

*Better*  
**BASIC™**

Inquiry 335

**\$25 REBATE — ACT NOW!**  
BetterBASIC is offering a \$25 REBATE to its customers. Ask your participating dealer, or phone **1-800-847-7078** for a dealer near you. Offer expires Oct. 31, 1986

nizes op codes beginning with the bits 1010 (hexadecimal A) as unimplemented instructions and jumps through a special exception vector, which in the ST points to these routines.

Because they were not originally intended for public access, use of these routines is not as easy or as consistent as is the case with the other entry points. Basic usage involves setting some of the values in a large data structure and then kicking off the Line A exception handler by defining a word op code whose first 4 bits are 1010 and whose last 4 bits specify which routine is desired.

The Line A routines give you faster access to graphics using the VDI and a few additional features, including a sprite facility and the ability to apply additional logical changes to raster objects while copying them from one place to another. You can mix and match Line A Handler and VDI routines, but this can be a little tricky,

since your Line A variables may be affected by your VDI calls.

There are 16 Line A routines:

- 0 Initialization
- 1 Put Pixel
- 2 Get Pixel
- 3 Line
- 4 Horizontal Line
- 5 Filled Rectangle
- 6 Line-by-Line Filled Polygon
- 7 BitBlt
- 8 TextBlt
- 9 Show Mouse
- 10 Hide Mouse
- 11 Transform Mouse
- 12 Undraw Sprite
- 13 Draw Sprite
- 14 Copy Raster Form
- 15 Seedfill

About half of the Line A routines are concerned with graphics primitives similar to those in the VDI. The mouse manipulation functions are fairly boring and obvious. (Transform Mouse sounds neater than it is—it just

changes the cursor representing the mouse position.) Let's take a closer look at the other routines.

**BIT BLTING (ROUTINES 7 AND 14)**

Raster operations involve a rectangular area of the raster, or video screen image. You often want to put a rectangular image (a bit-mapped object) on the screen and define the relationship it will have with the image that is already there "under" the rectangle being placed on the screen. For example, you may wish to say that certain pixels in the object are to be treated as transparent: Whatever is "below" them on the screen will not be changed and will therefore "show through" the new rectangle.

Additionally, you would like to be able to set the new rectangle down at an arbitrary coordinate on the screen. Unfortunately, many schemes for representing an image in memory are

*(continued)*



**STAY LONGER IN EUROPE ON THE MONEY YOU SAVE TOURING EUROPE IN YOUR NEW MERCEDES-BENZ.**

Plan to make European delivery of a new Mercedes-Benz part of your 1986 European vacation plans. Select any 1986 gasoline or diesel model,\* pick it up at the factory European Delivery Center—and embark on a deluxe driving vacation. Avoiding costly rentals while saving on the price of your new Mercedes-Benz. Send coupon for a free European Delivery brochure today.

\*Subject to availability.

Send coupon to: MHAU86-5  
 Mercedes-Benz of North America, Inc.  
 Marketing Communications Division  
 One Mercedes Drive, Montvale, NJ 07645



Name \_\_\_\_\_  
 Address \_\_\_\_\_  
 City \_\_\_\_\_  
 State \_\_\_\_\_ Zip \_\_\_\_\_

© 1986 Mercedes-Benz of N.A., Inc., Montvale, NJ.

*Listing 2: This trap handler is the sort you might use if you were programming the ST in 68000 assembly language or were using a high-level language and needed to write a binding for access to a BIOS, XBIOS, or GEMDOS function. The functions assume the C calling conventions; that is, if there are any parameters, they are assumed to have been pushed onto the stack in reverse order and to be no smaller than a word. The number of the routine itself must be pushed last, just before the trap call. If you are developing using the C provided in Atari's developer's kit, this process will be transparent, since a set of bindings is available that makes TOS calls look just like ordinary C function calls.*

```
; At entry, any arguments for the function have been pushed
; on the stack in reverse order, C-style. Then the
; function number was pushed. Finally this routine was
; called, so as you enter, the return address of the caller
; is on top of the stack.
```

```
retsv: ds.l ; some memory for a long variable
```

```
traprtn:
 move.l (a7)+, retsv ; Save the return address,
 ; because the OS functions don't
 ; expect it.
 trap #13 ; Trap to the BIOS function. (BIOS
 ; is available through trap 13,
 ; XBIOS through 14, GEMDOS through
 ; trap 1.)
 move.l retsv, -(a7) ; Put the return address back on
 ; stack.
 rts ; Return to caller.
```

often constructed for the hardware's convenience. The ST's screen memory, for example, consists of a word's worth of one plane of information, followed by a word of the next plane, and so forth, until 16 pixels for each plane have been defined. Then you start again with the first plane.

To simplify the job of manipulating the screen memory on the ST, a bit blter (bit-mapped block transfer) is provided. A bit blter can be software or firmware or both to support logical raster operations. On the ST, in the VDI and the Line A routines, a moderately complex data structure known as a memory form lets you define a raster and a rectangle within the raster so that the blter can manipulate it. One item in the form is a pointer to the actual image data. The rest of the fields specify things like the number of planes and the size of the rectangle. You need two of these memory forms for your bit-bling operations: one for the source raster and one for the destination.

An intriguing aspect of the memory form is the specification of the total raster representation that your object

is part of. This may be the actual screen memory if the bit-mapped object is currently on the screen. But it can also be a virtual screen of any size (word-aligned in the x dimension) up to that of a real screen. Probably the most common bit-blt operation copies from a source memory form with a virtual screen just big enough to hold the bit-mapped object, to a destination memory form pointing at the real screen. But for arcade-style applications in particular, many more complicated arrangements can be imagined: for example, blting from various game objects to an entire virtual screen being prepared for display. And you can blt from one part of the screen to another.

The Line A BitBlit is sophisticated. There are 16 logical operations you can apply between the source and destination. If you define a pattern, you can perform a logical AND of the pattern with the source and combine the result with the destination.

### **SPRITES (ROUTINES 12 AND 13)**

These sprites are not spectacular, and they're not in hardware. But they are

convenient, and you can have as many as you want. The Line A sprites are two-color (foreground/background). They are 16 pixels wide and 16 lines high. A sprite can be plotted onto the screen relative to any one of its pixels. When you call Draw Sprite, you specify a buffer to save the screen area covered by the sprite; when you undraw, the routine can restore the screen. Nothing to write home about, but nice nonetheless.

### **WHAT DO YOU USE?**

What is the place of the varied pieces of TOS in a typical application? Well, if you are willing to stick to GEM, you can access most of the ST's power. And you have the advantage of programming for a consistent virtual machine with a well-documented graphics model and a well-known user interface. Also, you will have an application that is portable to other systems supporting GEM. The non-GEM pieces give you more direct access to the ST hardware. And in some cases (such as sound), they give you the only access.

There are no restrictions on the developer who wants to mix and match. The VDI and AES functions on the ST are accessed through libraries of glue routines that you link with your application. Entry to the BIOS, XBIOS, and GEMDOS routines is actually achieved through the 68000's trap handlers (see listing 2). If you develop in C, bindings are available so that access to any TOS routine is simply a function call.

I have enjoyed software development on the Atari ST. I suspect my pleasure has something to do with the ST's peculiar combination of operating system routines. There are just enough traditional concepts to stave off the programmer's fear of coming obsolescence and just enough exciting new concepts to challenge creativity. Development has a clean, modular feel to it. The abstractions available in the operating system, particularly in GEM, are clear and consistent. These abstractions don't force you in any particular direction; if what you really want is to make the ST look like an old-fashioned, user-hostile machine, you can do it. ■



# New GPS Series: Tek sets the pace with SmartCursors™ and push-button ease.

Work faster, smarter, with two new general purpose scopes from Tektronix. The four-channel, 100 MHz 2246 and 2245 set the new, fast pace for measurements at the bench or in the field. They're easy to use and afford, by design.

**On top: the 2246 with exclusive integrated push-button measurements.** Measurements are accessed through easy, pop-up menus and implemented at the touch of a button. Measure peak volts, peak-to-peak,  $\pm$  peak, dc volts and gated volts with new hands-off convenience and on-screen readout of values.

SmartCursors™ track voltmeter measurements in the 2246 and visually indicate where ground and trigger levels are located. Or use cursors in the manual mode for immediate, effortless measurement of waveform parameters.

**Both scopes build on performance you haven't seen at the bandwidth or prices.** Lab grade features include sweep speeds to 2 ns/div. Vertical sensitivity of 2 mV/div at full bandwidth for

| Features              | 2246                                                    | 2245     |
|-----------------------|---------------------------------------------------------|----------|
| Bandwidth             | 100 MHz                                                 | 100 MHz  |
| No. of Channels       | 4                                                       | 4        |
| Scale Factor Readout  | Yes                                                     | Yes      |
| SmartCursors™         | Yes                                                     | No       |
| Volts Cursors         | Yes                                                     | No       |
| Time Cursors          | Yes                                                     | No       |
| Voltmeter             | Yes                                                     | No       |
| Vertical Sensitivity  | 2 mV/div                                                | 2 mV/div |
| Max. Sweep Speed      | 2 ns/div                                                | 2 ns/div |
| Vert/Hor Accuracy     | 2%                                                      | 2%       |
| Trigger Modes         | Auto Level, Auto, Norm, TV Field, TV Line, Single Sweep |          |
| Trigger Level Readout | Yes                                                     | No       |
| Weight                | 6.1 kg                                                  | 6.1 kg   |
| Warranty              | 3-year on parts and labor including CRT                 |          |

low-level signal capture. Plus trigger sensitivity to 0.25 div at 50 MHz, to 0.5 div at 150 MHz.

Accuracy is excellent: 2% at vertical, 2% at horizontal. And four-channel capability includes two channels optimized for logic signals.

**Best of all, high performance comes with unmatched convenience.** You can see it and feel it —in the

responsive controls and simple front-panel design, in extensive on-screen scale factor readouts, and in simplified trigger operation that includes Tek's Auto Level mode for automatic triggering on any signal.

**Contact the Tektronix office or sales representative nearest you for complete details.** Each scope is backed by Tek's three-year warranty, plus excellent documentation, training programs and outstanding service support — worldwide.



Featuring four channels, flexible triggering, extensive CRT readouts and push-button ease of use, the new Tek 2246 (left) and 2245 (above) bring high-quality, low-cost analysis to diverse applications in digital design, field service and manufacturing.

**Tektronix**  
COMMITTED TO EXCELLENCE

# HOW FAST CAN THE 80386 MAKE YOUR WORKSTATION GO?

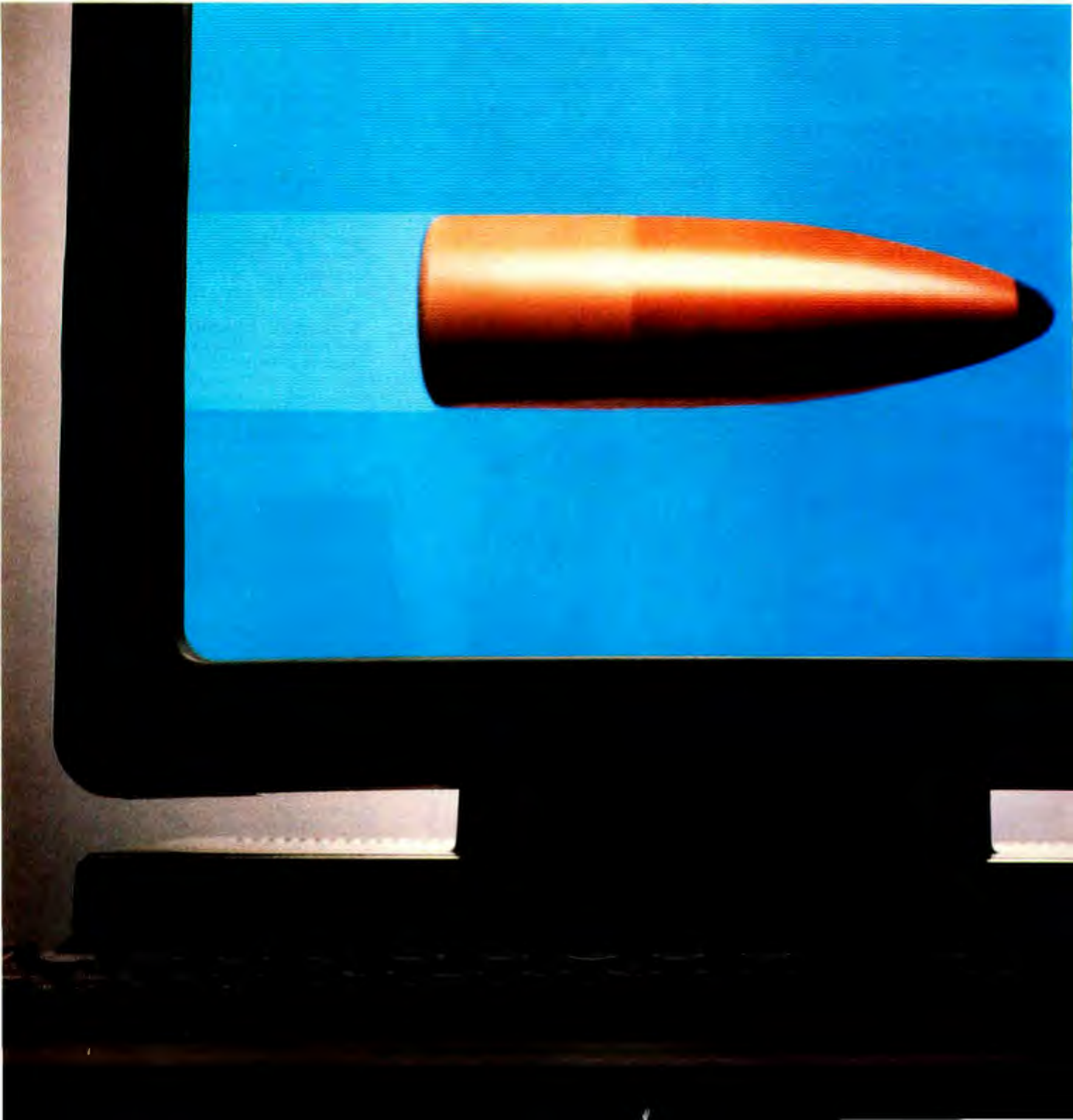

Faster than any other 32-bit microprocessor can. In technical terms that's 4 MIPS. 4 MegaWhetstones. With 4 Gigabytes.

Fast enough to have a sudden and lethal impact on your competition.

To achieve its blazing speed, the 80386 has six-stage pipelining, which

allows the standard 16 MHz part to deliver over 6100 Dhrystones per second.

That's nearly four times the Dhrystone performance of a VAX\* 11/780, or 4 VAX MIPS.

And with the 80386 you don't sacrifice all that performance for demand-paged virtual memory. Because of its on-chip paging unit and transparent paging cache, the 80386 can do a full virtual to physical address translation without the performance penalty of non-pipelined, off-chip designs. Giving you 4 MIPS of deliverable UNIX\*\* performance.

Of course, to achieve performance like that, you need a bus that's faster than a speeding bullet.

Like our 2 clock bus that provides a 32 Megabytes per second transfer rate.

That's the highest performance of any microprocessor bus.

So what more could advanced system designers ask for?

Blistering 4 Mega-Whetstones per second performance for superb graphics and number crunching. Only the 80386 uniquely teams with Weitek's 1167 floating point coprocessor to deliver the highest numerics

performance on the market.

And of course all this comes in a 64 Terabyte virtual address space with a 4 Gigabyte linear address space.

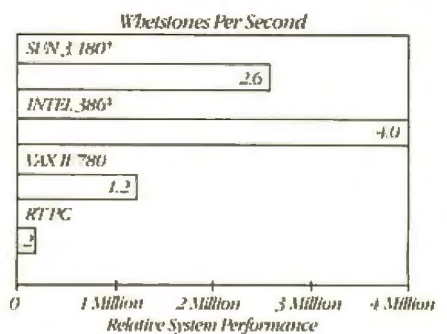
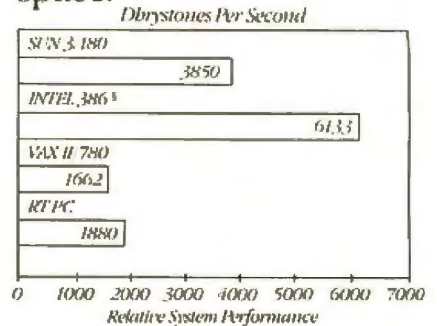

§ Intel 386 MULTIBUS<sup>®</sup> 1 16 MHz Starter Kit.  
 † With Weitek 1164, 1165 floating point chip set.  
 ‡ With Weitek 1167 floating point coprocessor.  
 Source: Refer to Intel 80386 Benchmark Report.

Finally, for your silver bullet, add to all this \$6 billion worth of DOS software. And watch how fast it runs on your 4 MIPS, 4 MegaWhetstones UNIX machine.

To find out more, attend one of our 80386 Seminars. Call your local Intel sales office for details.

Or call (800) 548-4725 for complete technical information.

Get all the ammunition you need to make your next system a success.

**intel<sup>®</sup>**

\*VAX is a registered trademark of Digital Equipment Corp.  
 \*\*UNIX is a trademark of AT&T Bell Laboratories.  
 © 1986 Intel Corporation

# Announcing BYTE's New Subscriber Benefits Program

Your BYTE subscription brings you a complete diet of the latest in microcomputer technology every 30 days. The kind of broad-based objective coverage you've read in this issue. *In addition*, your subscription carries a wealth of other benefits. Check the check list:

## DISCOUNTS

- ✓ 13 issues instead of 12 if you send payment with subscription order.
- ✓ One-year subscription at \$21 (50% off cover price).
- ✓ Two-year subscription at \$38.
- ✓ Three-year subscription at \$55.
- ✓ One-year GROUP subscription for ten or more at \$17.50 each. (Call or write for details.)

## SERVICES

- ✓ **BIX:** BYTE's Information Exchange puts you on-line 24 hours a day with your peers via computer conferencing and electronic mail. All you need to sign up is a microcomputer, a modem and telecomm software.
- ✓ **Reader Service:** For information on products advertised in BYTE, circle the numbers on the Reader Service Card enclosed in each issue that correspond to the numbers for the advertisers you select. Drop it in the mail and we'll get your inquiries to the advertisers.
- ✓ **TIPS:** BYTE's Telephone Inquiry System is available to subscribers who need *fast response*. After obtaining your



Subscriber I.D. Card (see TIPS information adjacent to Reader Service cards), dial TIPS and enter your inquiries. You'll save as much as ten days over the response to Reader Service Cards.

- ✓ **Disks and Downloads:** Listings of programs that accompany BYTE articles are now available free on the BYTEnet bulletin board; and on disk or in quarterly printed supplements (see reply cards in this issue).
- ✓ **Microform:** BYTE is available in microform from University Microfilm International in the U.S. and Europe.
- ✓ **BYTE's BOMB:** BYTE's Ongoing Monitor Box is your direct line to the editor's desk. Each month, you can rate the articles via the Reader Service

Card. Your feedback helps us keep up to date on your information needs.

- ✓ **Customer Service:** If you have a problem with, or a question about, your subscription, you may phone us during regular business hours (Eastern time) at our toll-free number: 800-258-5485. You can also use Customer Service to obtain back issues and editorial indices.

## BONUSES

- ✓ **Annual Separate Issues:** In addition to BYTE's 12 monthly issues, subscribers also receive our annual IBM PC issue free of charge, as well as any other annual issues BYTE may produce.
- ✓ **BYTE Deck:** Subscribers receive five BYTE postcard deck mailings each year—a direct response system for you to obtain information on advertised products through return mail.

To be on the leading edge of microcomputer technology and receive all the aforementioned benefits, make a career decision today—complete and mail in a subscription card or, call toll-free weekdays, 8:30am to 4:30pm E.S.T.: 800-258-5485.

*And... welcome to  
BYTE country!*

**BYTE**  
THE SMALL SYSTEMS JOURNAL



# AMIGA ANIMATION

BY ELAINE A. DITTON AND RICHARD A. DITTON

*Bringing graphics to life on the Amiga*

COMPUTER ANIMATION is the process of displaying a series of images on a video screen. The images can be displayed in the same spot on the screen for static animation or moved about the screen for dynamic animation. Animation in general consumes a large portion of a system's available processing power and memory space. Usually, though, trade-offs can be made between the amount of memory space and the amount of processing power required.

The Commodore Amiga has specific hardware that makes the task of animation consume less CPU processing. The sprite DMA (direct memory access) channels allow a relatively small image to be moved and altered by changing just a few locations in memory. The Blitter is a high-speed hardware device used for copying or merging image data and drawing lines. Because the colors in the Amiga are stored in registers, a special form of animation called color animation is possible.

In this article we will briefly discuss the various aspects of animation on the Amiga and the facilities provided in the Amiga ROM Kernel to generate graphic images. In conclusion, we will

describe our methods of programming animation on the Amiga.

## THE DISPLAY

The first thing that must be specified is the background on which the animation will take place. This is done by defining a View structure, which describes the characteristics of the display (see figure 1). The View consists of one or more ViewPorts, each with specified height, width, display mode, image data, colors, and position on the screen. ViewPorts must be vertically stacked and separated by at least one blank line. The width should be specified as either 320 or 640 pixels. Two or more ViewPorts of different horizontal resolution can exist on the screen at the same time. The ViewPort points via RasInfo to the Bit-Map structure, which in turn points to the actual bit planes of image data (figure 2). The number of bit planes determines the maximum number of colors. The ViewPort also points to the ColorMap, which is interpreted depending on the mode.

## SPRITE ANIMATION

Sprites are hardware "objects" that are independent of the background

display. The Amiga can have eight sprites, each 16 pixels wide and any number of lines high (figure 3). Even though there are only eight sprites, each one can be reused after its horizontal endpoint has been reached on the screen. Each sprite can have 3 colors plus transparent, or you can attach two sprites to have 15 colors plus transparent.

A sprite is displayed on the screen by specifying its  $x,y$  coordinates and a pointer to the memory area that describes the formed image. To animate a sprite you only have to change either of the coordinates or the pointer to the image data. Since you only have to change a few bytes to move or alter the image, sprite animation takes very little CPU processing.

The Amiga ROM Kernel provides several routines for manipulating the hardware sprites. GetSprite allocates a hardware sprite for exclusive use of the requesting task. ChangeSprite

*(continued)*

Elaine A. Ditton and Richard A. Ditton (Free-Radical Software, 1323 South Yale Ave., Arlington Heights, IL 60005) are president and vice president of Free-Radical Software, a company specializing in consumer software and computer graphics consulting.

# One fast solution to disk format problems

**Diskmaker® translates disks quickly.**

If you work with many different computers and disk formats, one Diskmaker® will pay for itself by rapidly converting hundreds of different formats.

Diskmaker® transfers are fast, disk-to-disk; no modems or other special software necessary. Does not tie-up expensive computer systems to convert disks.

Diskmaker® handles all common disk sizes: 8", 5¼", and 3½". Transfers can be made among PC DOS, MSDOS, CP/M, UNIX, word processing and phototypesetting systems.

Ongoing support features several software updates each year to stay abreast of new systems as they are introduced.

Diskmaker® comes complete with drives, software and extensive manual (requires only monitor and keyboard). Six months warranty.

For more information, write:  
 New Generation Systems, Inc.,  
 9510A Lee Highway, Fairfax, VA 22031.  
 Telex 750417 NEW GEN SYS. Or call:  
 (703) 471-5598



## DISKMAKER®



## AMIGA ANIMATION

changes the pointer to the image bit map of a reserved sprite. MoveSprite modifies the *x,y* coordinates of the sprite. FreeSprite returns a reserved sprite to the system.

To use the hardware sprites in the animation system, the Amiga ROM Kernel defines a structure known as the VSprite (for "virtual sprite"). Information about the sprite such as color data, collision detection, and double buffering is contained in the VSprite structure.

Sprites are extremely easy to animate but have limitations that you must consider. A limited number of sprites are available, and each sprite is of limited size. Therefore, if you have to animate a large area, sprites will not be appropriate. An individual sprite can have only 3 colors and attached sprites can have 15 colors, whereas the background display can have up to 32 colors. The SPRITES mode bit in the ViewPort structure must be set if you are using VSprites or hardware sprites.

### BACKGROUND ANIMATION

The simplest type of background animation uses the XOR trick. For in-

stance, if you XOR an area of the screen with a pattern, the pattern appears on the screen with a different color from the background (figure 4). The original background can be restored by XORing in the same position with the same pattern. This method is fast because no data is actually being moved. The Amiga drawing mode COMPLEMENT supports this idea. It is limited because all the bit planes are complemented so that the resulting color is always determined by the background color. You can obtain more color control if you selectively XOR bit planes. Unless you choose the colors in the registers carefully, the overlapped portion of XOR images will be a different color than either of the images.

The method most often used to animate complex background images is to move the actual blocks of data. This method takes up the most CPU time, but the Amiga assists with the hardware Blitter. The Blitter uses up to four DMA channels to move data 4 to 10 times faster than the 68000 microprocessor.

The routines BitBitMap and ClipBlit copy rectangular areas from one sec-

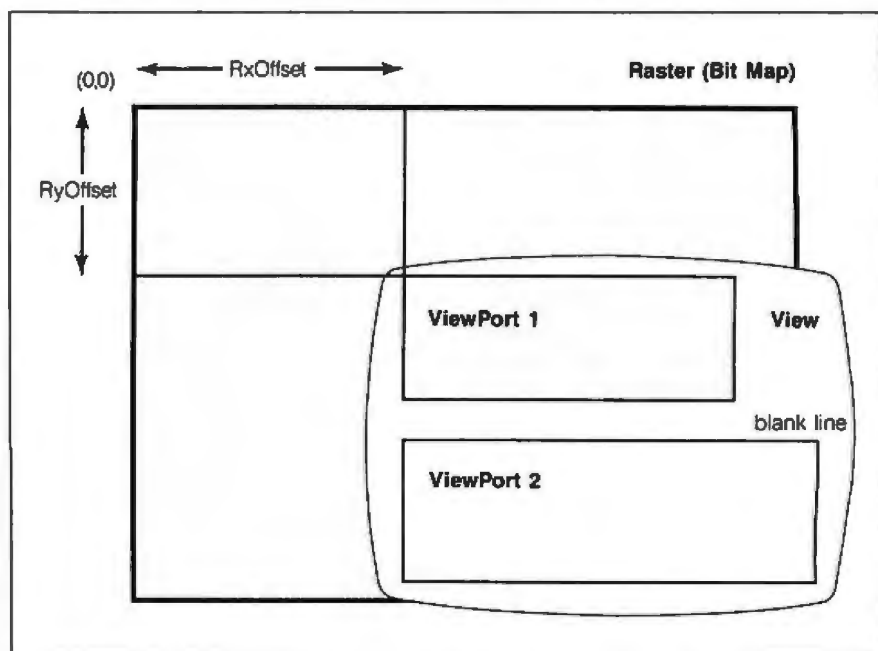

Figure 1: The View structure, which defines the display characteristics of the Amiga, consists of one or more ViewPorts, which must be separated by at least one blank line. The values RxOffset and RyOffset determine which portion of the background bit map is displayed in a ViewPort.

## AMIGA ANIMATION

tion of chip memory to another. Blt-BlitMap takes bit maps as arguments and will blit only specified bit planes. ClipBlit works with the RastPort structure and within the multitasking system. It will not destroy data of another task's overlapping window. Both routines use minterms, 8-bit values that determine how the source rectangle

is moved into the destination area.

If you want the object to do more than just animate in a stationary position, you must save the background underneath the object so that it can be restored. If more than one object is moving across another, the data moves must be processed in last-in/

(continued)

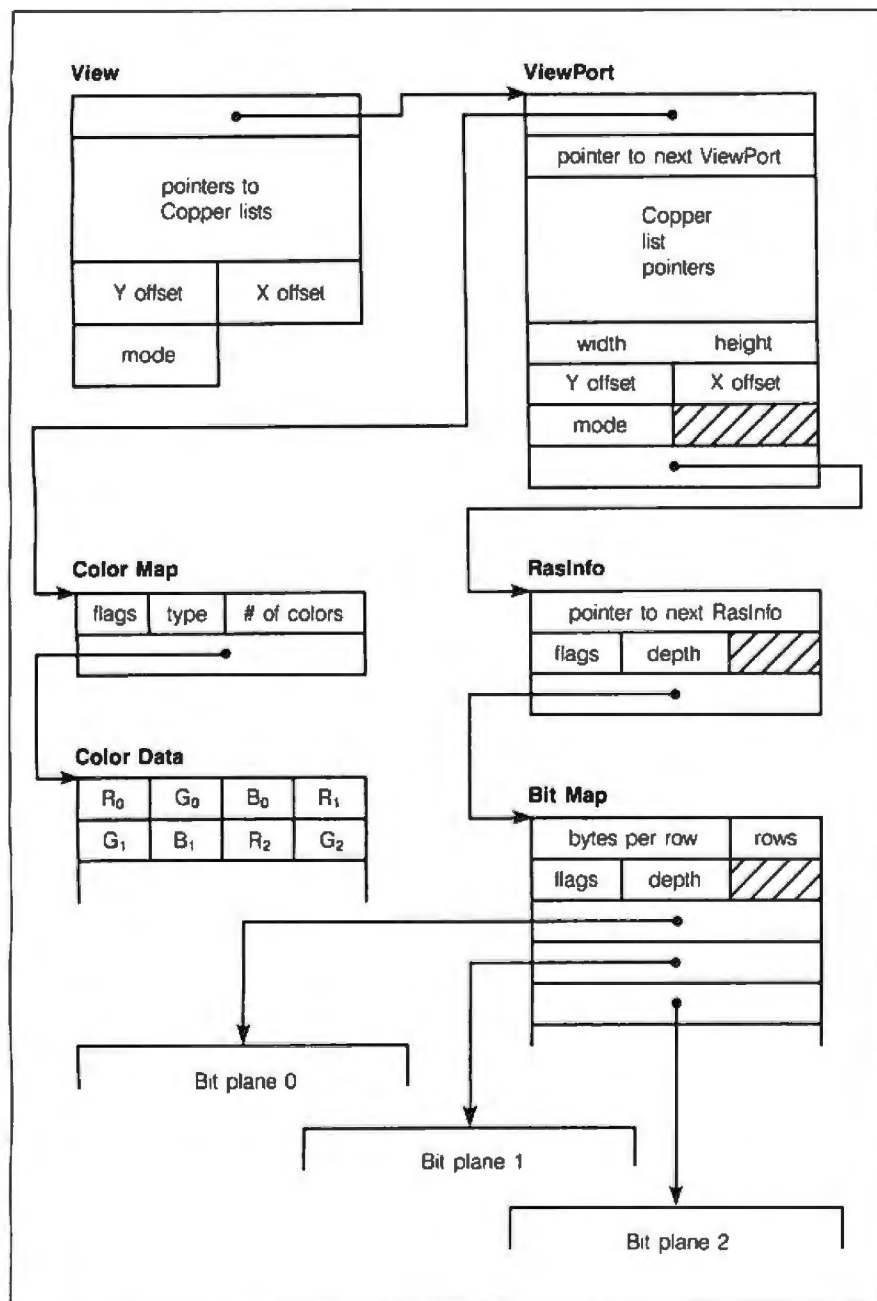

Figure 2: The ViewPort structure contains pointers to the ColorMap, which tells the system which colors to use in the ViewPort, and to RasInfo, which tells the system where the BitMap is located. The BitMap structure contains pointers to from one to six bit planes representing from 2 to 64 colors, respectively.

## FORTH

The computer language for increased...

**EFFICIENCY**

reduced....

**MEMORY**

higher.....

**SPEED**

### MVP-FORTH SOFTWARE

Stable...Transportable...

Public Domain...Tools

### MVP-FORTH PROGRAMMER'S KIT

for IBM, Apple, CP/M, MS/DOS, Amiga, Macintosh and others. Specify computer. \$175

**MVP-FORTH PADS**, a Professional Application Development System. Specify computer. \$500

### MVP-FORTH EXPERT-2 SYSTEM

for learning and developing knowledge based programs. \$100

**Word/Kalc**, a word processor and calculator system for IBM. \$150

Largest selection of FORTH books: manuals, source listings, software, development systems and expert systems.

Credit Card Order Number: 800-321-4103 (In California 800-468-4103)

Send for your FREE FORTH CATALOG

**MOUNTAIN VIEW PRESS**

PO BOX 4656 Mountain View, CA 94040

first-out order. Two moving and overlapping objects would be processed in this order: (a) save background 1, (b) place object 1, (c) save background 2, (d) place object 2, (e) restore background 2, (f) restore background 1.

If the animation object is not rectangular and you want the background to move behind the actual shape of the object, you can accomplish this by using the Blitter. First, the Blitter will OR all the bit planes of the object together to form a mask describing the shape of the object. Any of the colors can be chosen as the background color to be ignored in the mask. The Blitter will then AND the mask with each bit plane of the object to create an image of the object with a background of zero. It then inverts the mask and ANDs it with the background bit planes, creating an object-shaped hole. Now the Blitter will OR the object into the background in the hole. This procedure can be written as

$$D = AB + \bar{A}C$$

where A is the object mask, B is the object, C is the background, and D is the new animation frame. That is, the new frame is replaced with the object wherever the object mask is true, and with the background wherever the object mask is not true.

To implement this "cookie-cutter" operation, object and background data addresses are loaded into the Blitter source data registers BLTXDAT (where x equals A, B, or C, as above) and the minterm resulting from the above equation is placed in the BLTCON0 hardware register. The same thing can be accomplished by dividing the operation into two parts and using the BltBitMap function, which will take two sources at a time.

When the Amiga changes an image in memory, it does so by altering one bit plane at a time. Because of the finite period of time it takes to modify each bit plane, a moving object will tend to have its bit planes separate across the screen. Another problem occurs if the program starts drawing new information where the video beam is passing. This results in a screen consisting partly of old material and partly of new. If the two

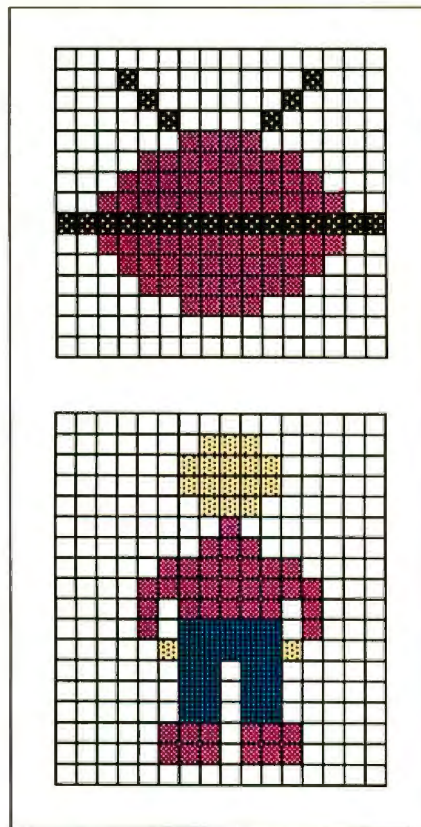

Figure 3: Hardware sprites, graphic objects that can move independently of the background display, may be up to 16 bits wide, any number of bits high, and up to three colors plus transparent.

frames are very different, it can look quite bad. The solution to both problems is to double-buffer the screen. That is, the system displays one memory space while drawing in another memory area. The pointers to the two areas are switched when the drawing has been totally completed, and the screen retains visual integrity. This method uses twice the amount of screen memory, so double-buffering a screen with four bit planes will use an additional 32K of chip memory.

Another way the Amiga facilitates animation is by supporting horizontal and vertical scrolling. If you simply change the RxOffset and RyOffset of the ViewPort structure (see figure 1), the screen will display a different portion of the background data. No memory is moved, so the scrolling is fast and smooth. One quirk of the scrolling, however, is that it disables hardware sprites 6 and 7.

If you set the ViewPort to Dual-Playfield mode, you will have two independently controllable playfields, one with a higher priority than the other. Each playfield can have up to seven colors plus transparent. A moving background outside an airplane window is the type of effect possible with this technique.

### COLOR ANIMATION

Color animation is a special form of animation with fairly limited applications. By changing the Amiga color registers in a regular sequence, a properly formed image will appear to flow on the screen. This effect is well suited to animating a flowing river or billowing smoke. Since color animation uses very little processing power or memory, it can provide for simple effects without utilizing many resources.

### THE AMIGA ANIMATION SYSTEM

The Amiga ROM Kernel graphics animation system classifies sprites (VSprites) and background (or Blitter) objects (Bobs) as graphics elements (GELs). The graphics animation routines automatically handle some of the topics just discussed. If your animation sequence needs both Bobs and VSprites, and if you need to utilize most of the features of this system, it might simplify your job. However, this system does add a lot of overhead, and you may find you have more control if you write your own application-specific routines.

A Bob is an extension of the information contained in the VSprite structure (height, collision-handling information, position, and pointers to the data). The Bob structure handles the information unique to the background such as drawing sequence, image mask, save and restore background information, and double buffering. You can determine the order of drawing for each Bob or allow the system to draw them in *y, x* positional order. The system will first draw the Bob with the lowest *y* value. If two Bobs have the same *y* value, then the Bob with the lowest *x* value is drawn first. Objects drawn later overlap objects drawn earlier.

In order to have the system auto-



matically save the background to be restored after moving the Bob to a new location, you must set the SAVEBACK bit in the variable sprFlag of the VSprite structure and set the variable SaveBuffer to the address of a memory location. To "cookie-cut" the Bob into the background, set the OVERLAY bit and define the ImageShadow mask. To double-buffer, a Bob pointer is set in the Bob structure to a structure called DBufPacket. This structure contains information that helps keep track of the background in the current drawing buffer for correct restoration. If any of the Bobs are double-buffered, all the Bobs must be double-buffered.

Four variables describe the boundaries of a rectangle that will clip the Bob. If the GEL has passed completely outside the clipping region, the GELGONE flag will be set. If this GEL is no longer needed, you may delete it from the GEL list to speed up the

overall processing. The SAVEBOB bit can be set to tell the system not to erase the old image of the Bob, which gives a "paintbrush" effect as the Bob moves. Once all of the GELs are moved or changed, they must be sorted with the routine SortGList and finally displayed with the routine DrawGList. DrawGList makes up a Copper instruction list.

The Amiga animation software supports a set of structures and routines that will animate Bobs. The AnimOb (animation object) is the top-level data structure that organizes the AnimComps (animation components) and contains the registration point in the display relative to which of its component Bobs are drawn. The AnimComp is a component of the animation that contains the actual imagery, such as an arm, leg, or other part of the complete object. The AnimOb structure contains the initial position of the object, its velocity and acceleration in the x and

y directions, a pointer to the first of a linked list of AnimComps, and a pointer to a special animation routine. The AnimComp contains a pointer to the next AnimComp in the sequence and a timer to tell the system when to switch. After the two structures are set up, calling the Animate function sets the animation in motion.

The Amiga animation software supports sequenced drawing and motion control, which can be used separately and together. In sequenced drawing, each view is a modification of the preceding view. This is particularly useful with an animation that is cyclical in nature, like walking. One step in a walking sequence would be a sequenced drawing. To make the object look like it's moving, each new view is positioned farther from a common reference point. After the animation has completed one cycle, the AnimOb must be moved a certain

(continued)

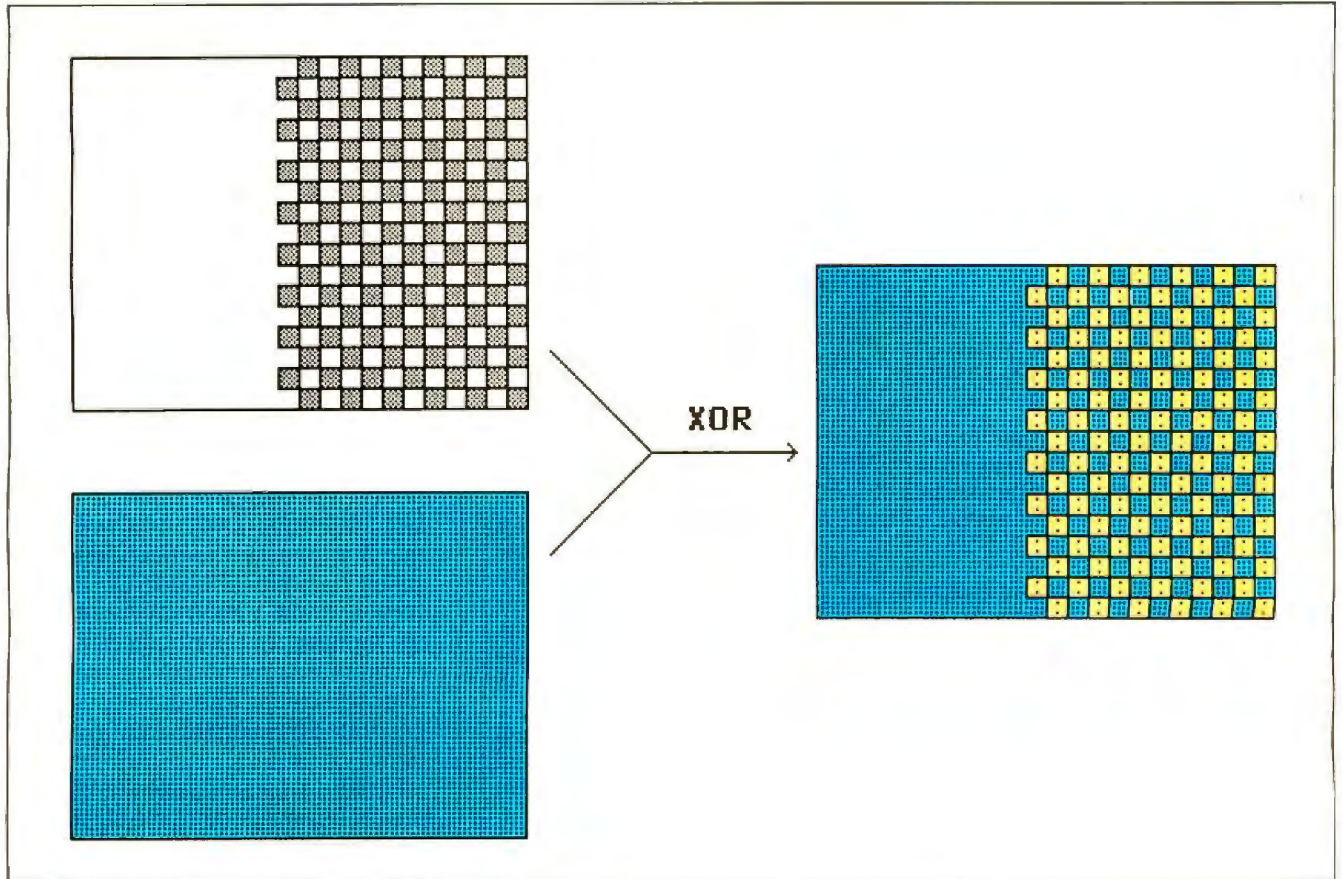

Figure 4: One form of background animation on the Amiga involves using a pattern to XOR an area of the background. The pattern will appear on the screen with a different color than the background.

## AMIGA ANIMATION GLOSSARY

**ANIMOB:** A data structure that brings many AnimComps together in a whole object.

**ANIMCOMP:** An expansion of a Bob to allow the Bob to function as part of an AnimOb.

**BIT MAP:** A structure that contains pointers to bit planes and defines the width and depth of the bit-plane data.

**BIT PLANE:** An area of memory that defines the color of the pixels displayed on the screen. Each bit plane multiplies the number of possible colors in the display by 2. If one bit plane is used for a display, only two colors are possible. If two bit planes are used, four colors are possible. A maximum of five bit planes can be used in a low-resolution display and four bit planes in a high-resolution display.

**BLITTER:** A specialized hardware device that performs high-speed data copying and line drawing. The Blitter can perform up to 256 logic operations on three data sources while copying to a destination.

**BOB:** A Blitter object that is a software version of the hardware sprite. Bobs are not restricted to the size or color limitations of a sprite.

**CHIP MEMORY:** The lower 512K bytes of memory on the Amiga, which can be directly accessed by the custom chips.

**COLOR MAP:** A list of the red, green, and blue values that are attached to a ViewPort and loaded into the Amiga color registers when that ViewPort is being displayed.

**COPPER:** One of the Amiga's custom coprocessor chips, it controls the entire graphics system. The Copper can alter the registers, reposition sprites, change the color palette, update the audio channels, and control the Blitter. The Copper frees the 68000 to execute program logic rather than updating the display screen. The Copper has only three commands: WAIT until the beam reaches a specific screen position, MOVE a value into a register, and SKIP the next instruction if the beam is past a specified screen position.

**GEL:** A graphic element that can be manipulated by the graphic animation routines in the Amiga ROM Kernel. VSprites, Bobs, AnimComps, and AnimObs are all GELs.

**IFF:** Interchange Format File, the standard format for data written to files on the Amiga. This standard allows for data to be easily exchanged among development tools and products.

**MINTERM:** An 8-bit value that determines the logic operations to be performed by the Blitter during a data transfer operation.

**RASTPORT:** A data structure that contains information needed for manipulating the graphics display with the Amiga ROM Kernel routines. The drawing pen colors, drawing mode, area fill pattern, text attributes, font, pen position, and line pattern are stored in the RastPort.

**SPRITE:** A hardware graphics object that is defined and manipulated independently of the background display. The Amiga has eight sprites that are 16 pixels wide by any number of lines high. Each sprite can have 4 colors, or two sprites can be attached for a 16-color sprite. Scrolling the background or displaying more than 320 pixels per line in low resolution or 640 pixels per line in high resolution causes the last two sprites to be unusable.

**VIEW:** A structure that defines an entire screen display. The View contains a pointer to a list of ViewPorts and the *x* and *y* offsets for this screen.

**VIEWPORT:** A structure that defines a horizontal section of the display screen. Multiple ViewPorts can be displayed on a single screen if there is at least one blank line between ViewPorts. Each ViewPort contains a unique color map, display mode, width, height, *x* offset, and *y* offset for its portion of the display screen. A scrolling background can be created by changing the *x* and *y* offsets contained in the ViewPort structure.

**VSPRITE:** A virtual sprite, the method of describing the actual hardware sprites for use in the Amiga animation system.

distance to keep the apparent motion smooth. This distance is contained in the AnimOb structure.

Motion-control animation specifies objects that have independently controllable velocities and accelerations. The velocity and acceleration values are treated as 16-bit fixed-point binary fractions that have the form *vvvvvvvvv.fffff*. The slowest possible speed is one pixel every 64 frames. Each call to Animate causes the acceleration values to be added to the velocities.

The drawing precedence for AnimObs objects is determined by the precedence of the Bobs that make them up. The animation system automatically updates the precedence in the Bob structures for each frame to reflect the order of the first sequence. If more than one AnimOb is on the screen, one complete object can have precedence over another by linking the last Bob of the first AnimOb to the first Bob of the second AnimOb. In this way, you can make one object appear to pass in front of another.

Both the AnimOb and AnimComp structures can have pointers to user-supplied routines that are called every time Animate() is called and can cause any change in the animation sequence.

### TIMING

To animate an object on the Amiga without flicker, you have to understand how the image is formed on the screen. The entire screen is redisplayed 60 times a second. The time period between the drawing of the last line of the previous screen and the first line of the next screen is called the vertical blank. During the vertical blank period on the Amiga, the sprites, Copper, and bit-plane pointers are initialized for the next display screen. The screen is then generated from top to bottom, left to right.

Flicker is caused when a display area is being altered at the same time the area is being written to the screen. To avoid this, your animation routines must complete all updates before the beam reaches the display area or after the beam has left the display

area. The current beam position can be determined by calling the routine VBeamPos.

Under the multitasking system of the Amiga, each task is given 4/60 second to execute before the task is preempted to execute the next task of the same priority. This can play havoc with any attempt to perform smooth animation, since your animation routines may not be executed in a regular time frame. One method of getting around this problem is to increase the priority of your animation task to a high level or use the Forbid() function to defeat the multitasking system and allow the animation to execute exclusively in the Amiga.

Another method is to attach a sub-routine onto the vertical blank interrupt chain. This increments a counter, which can then be checked to determine the number of frames that have been displayed since the last animation update. The animation routines can then use this value to correctly position the animation objects.

**MEMORY USAGE**

In one of our applications we have a scrolling background that is four screens wide and five bit planes deep, requiring a total of 160K bytes. We use six sprites to form one moving image. Each animation step uses approximately 1K byte. If the moving image has 40 steps, just the image and background data would consume 200K bytes of memory.

As you can see, it is practically imperative to add the additional 256K-byte memory expansion to the internal 256K on the Amiga to accommodate the operating system and any significant piece of animation. Currently, only the lower 512K bytes of memory are available to the custom chip hardware. If additional RAM is added via the 68000 bus, accessing image data from there will be slower than accessing data stored in the lower 512K bytes because all image and sound data must still be transferred to the lower 512K bytes to be used.

**MATERIALS AND METHODS**

We would like to briefly describe how we have developed animation on the

*The mechanics of creating animated graphics are difficult, and good animation results only when artist and programmer take the system to its limits to produce visual effects.*

Amiga. We are using the Lattice IBM-PC-to-Amiga cross-compiler and the Metacomco assembler and linker to develop our programs. We wrote our own PC-to-Amiga parallel transfer program because we found the one supplied with the Amiga developer's kit to be too slow. Developing large programs on the Amiga itself will be difficult until additional RAM and a good hard disk are available. Adequate debuggers for the Amiga are only now becoming commercially available.

The art for our animation was drawn using Deluxe Paint by Electronic Arts. Once again, we wrote our own routines to extract the data from the IFF file generated by Deluxe Paint and convert it directly into an assembly file. Then we used the structures and functions described earlier to program the animations.

**CONCLUSION**

The mechanics of creating animated graphics can be difficult enough, and the result is only as good as what you see in the end. If a car wheel in an animated sequence is rotating too fast for the speed of the background passing by, the animation will not reflect what you intended it to reflect. Good animation is created by both artist and programmer taking the system to its limits to produce visual effects. In this regard, the possibilities for animation on the Amiga are very exciting. ■

**CompuPro Solves the Network Puzzle**

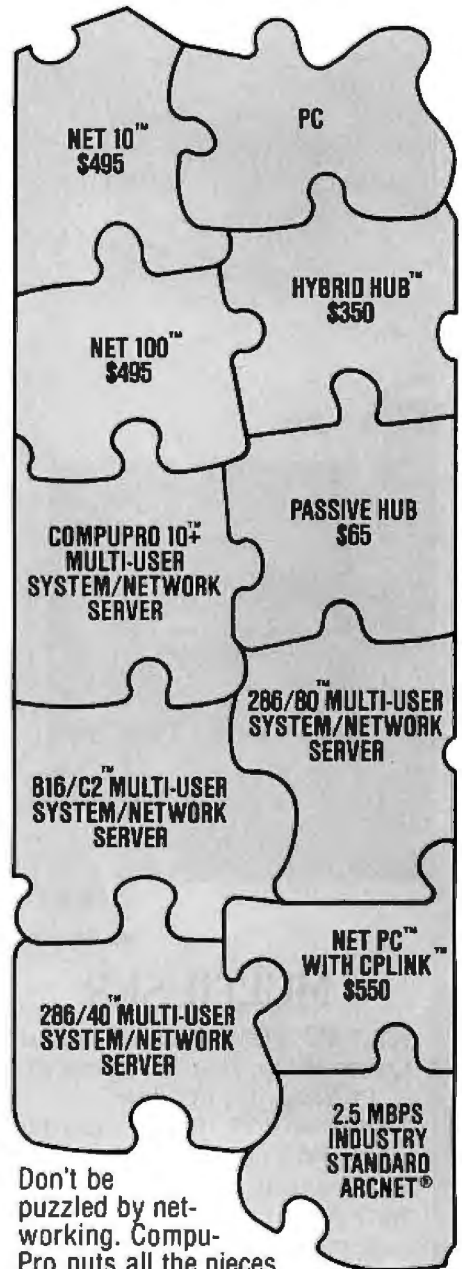

Don't be puzzled by networking. CompuPro puts all the pieces together — our high performance multi-user systems simultaneously double as network servers for IBM® PCs. Move up to a true multi-user system and save your investment in existing PCs. To find out how CompuPro can solve your networking puzzle, call today for the name of your nearest dealer.

**CompuPro™**

Viasyn Corporation  
26538 Danti Court, Hayward, CA 94545-3999 (415) 788-0909

Suggested list prices, subject to change without notice.

Trademarks CompuPro 286/80 286/40 10 Plus 816/C2 NET 100 NET 10 NET PC HYBRID HUB Viasyn Corporation IBM International Business Machines Corporation ARCNET Datapoint Corporation CPLINK ComputerNet A/S

# Multuser & LAN Solutions

## For IBM PC/XT/AT

*Now!*



"We weren't using our PC/AT effectively until we connected Kimtron terminals."  
 Dr. Ed Generazio  
 NASA

### MULTIUSER

**KT-7/PC<sup>2</sup>** PC Work-a-like Terminal  
 Compatibility: Multilink Advanced<sup>3</sup>,  
 PC-Slave/16<sup>4</sup>, PC-Slave<sup>12</sup>  
 Display: 80 x 25, IBM PC character  
 set, PC look-a-like attributes, 14"  
 green or amber  
 Keyboard: AT style std. IBM  
 scan/ASCII codes.  
 5161/AT style opt.  
 Pages of memory: 1 std. 2 or 4 opt.  
 Communications: 2 bi-directional  
 RS-232C serial (data & printer)  
 ports  
 Operating systems: works with  
 PC-DOS<sup>1</sup>, MS-DOS<sup>5</sup>, QNX<sup>6</sup>,  
 UNIX<sup>7</sup>, XENIX<sup>8</sup>, THEOS<sup>9</sup>, PICK<sup>9</sup>,  
 and Concurrent DOS<sup>10</sup>.  
 Retail price: \$695.00  
**QUARTET<sup>2</sup>** 4-port I/O card,  
 RS-232C  
 Retail price: \$299.00

### LAN

**K-Net<sup>2</sup>** Local Area Network  
 Software Compatibility: IBM's  
**NetBIOS<sup>1</sup>**, Token-Ring<sup>1</sup>, PC  
 Network<sup>1</sup>, Novell's Advanced  
 Netware<sup>11</sup>, Kimtron's K-Net<sup>2</sup>  
 Access Method: CSMA/CD  
 Topology: Distributed Bus  
 Data Rate: 1 million bps (baseband)  
 Cable: Twisted-pair/phone wire  
 Distance: Up to 4000 ft.  
 Addressable users: Up to 255  
 Physical: Half-sized card  
 Operating systems:  
 PC-DOS<sup>1</sup>/MS-DOS<sup>5</sup> 2.0 or later  
 Dedicated file server: Not needed  
 Multiuser solutions supported:  
 Multilink Advanced<sup>3</sup>,  
 PC-Slave/16<sup>4</sup>, PC-Slave<sup>12</sup>  
 Other features: message  
 communication and print  
 spooling  
 Retail price: \$395.00

### WORKSTATIONS

**KW-1** 8088, 4.77 MHz, 256 Kbytes  
 Retail price: \$995.00  
**KW-2** 8088-2, 8 MHz, 256 Kbytes  
 Retail price: \$1,195.00  
**KW-3** 80286, 6 or 8 MHz,  
 256 Kbytes  
 Retail price: \$1,995.00  
 All the above include: AT style  
 keyboard, 8 slots, built-in K-Net<sup>2</sup>  
 with remote boot. Upgradeable to  
 "complete" PC. Monitors, video  
 boards, additional memory, and  
 other keyboard layouts are also  
 available.  
 (800) 828-8899  
 (408) 436-6550 (In CA)  
 1705 Junction Ct., Bldg. #160  
 San Jose, California 95112

**Kimtron**

Trademarks: <sup>1</sup>IBM <sup>2</sup>Kimtron <sup>3</sup>Software Link <sup>4</sup>Alloy <sup>5</sup>Microsoft <sup>6</sup>Quantum <sup>7</sup>Bell Labs <sup>8</sup>THEOS Software <sup>9</sup>PICK Technologies <sup>10</sup>Digital Research <sup>11</sup>Novell <sup>12</sup>ADC  
 © Copyright 1986 by Kimtron Corp.

# AMIGA VS. MACINTOSH

BY ADAM BROOKS WEBBER

*A programmer's comparison of the system calls  
on two 68000-based machines*

I HELPED IMPLEMENT the True BASIC language system on the Macintosh. The project has been completed for some time now and we've all recovered our perspective and good humor, but at the time I felt that if I saw that smiling "Welcome to Macintosh" message one more time I would scream. It was in this frame of mind, on my way to see the Amiga for the first time, that I wrote out a list entitled "Why I Hate the Macintosh."

That incident led to this article. I have now completed the same project on the Amiga and have many gripes about that machine, too. In this article I compare the system software of the two machines.

Implementing a language system is a good way to get to know a machine. True BASIC is not just a compiler and interpreter, it's a screen editor, a graphics program, and a number cruncher. It makes sounds, it prints, it manipulates files—in short, it uses most of a system's software. My comparison of the Macintosh and the Amiga is necessarily limited, but I have tried to choose areas that are of general interest and that are represen-

tative of the differences between the two machines. These are the user interface, graphics primitives, printers and other devices, multitasking, and memory management.

## THE USER INTERFACE

The user interface of a system is usually examined from the user's point of view. You ask, "Is it intuitive? Is it powerful? Is it forgiving of error?" as you consider how to communicate with a program. I am interested in another point of view: What does a program have to do to communicate with the user? For some machines, communicating with the user means reading characters from the keyboard and writing text to the screen. Adding windows, menus, and mouse operations makes things more complicated.

Just how complicated is shown by the Macintosh user interface software, which determines the structure of every Mac program more or less completely. The program must have a main loop that is executed as often as possible, usually 60 times a second. (One rule of thumb: The quality of system software is inversely propor-

tional to the number of things a program must do "as often as possible.") The main loop checks for events like keystrokes, mouse clicks, and disk insertions and responds to them.

Responding to an event is usually a lot of work because the Mac's user interface software provides little assistance. Figure 1 shows, in pseudocode, a simple example of what a program must do to allow a window with a scroll bar to change in size—something that most Mac programs have to deal with. The system software does offer significant help in two areas of user interface: text editing and file access. TextEdit is a subsystem that provides a mechanism for displaying and editing text in a window. (True BASIC doesn't use TextEdit, but only because we have our own internal string-handling procedures.) For

*(continued)*

Adam Brooks Webber (39 South Main St., Hanover, NH 03755) is a design engineer for True BASIC Inc. He has a B.A. in mathematics from Dartmouth College and was involved with operating system and language system development there before going to work for True BASIC.

file access, the system software provides the Standard File Dialog, which gives a graphic display of the contents of a disk and allows you to choose a file. It's an excellent tool and almost all Mac programs (including True BASIC) use it.

Intuition, the Amiga user-interface software, supports two different mechanisms for communicating with the user. The console device is the simpler of the two. From your point of view the console device looks like a no-frills window, but from the program's side it looks like a terminal. The program gets a sequence of characters as input and sends off a sequence of characters as output. Mouse clicks and other nontextual input come through the console device as special ANSI-defined character sequences. The console device is a very easy way for text-only applications to communicate with the user. It is especially useful for prompt-based applications

like those typical of UNIX and the IBM PC.

The Amiga's other, more powerful user interface mechanism is the Intuition Direct Communication Port, or IDCMP. The Amiga Executive allows tasks to communicate with each other through message ports; an IDCMP is a message port that has a program at one end and Intuition at the other end. Events are communicated to the program through the port. This is a very flexible scheme: The program can poll the IDCMP, or it can arrange to run only when there is some event for it to work on, or it can spawn a separate task to handle events. And the events themselves are much more straightforward to handle—figure 1 shows in pseudocode what an Amiga program using an IDCMP must do to allow a window with a scroll bar to change in size. The program can get more control of the resizing process if it wants to, but for most programs

(including True BASIC) it works almost automatically.

In future revisions of Intuition I'd like to see something like the Mac's Text-Edit for displaying and editing text in a non-console-device window and some kind of file interface like the Standard File Dialog. But in spite of these deficiencies, I prefer the Amiga user interface. It is more flexible and usually requires less work on the part of the program.

**GRAPHICS PRIMITIVES**

The Amiga has more in the way of graphics special effects than the Macintosh. It has color, many different screen depths and resolutions, and special-purpose animation hardware. I suppose there's no comparison when it comes to games, simulations, art programs, and that crowd. But for a language system what I really want is a complete, logical set of basic graphics primitives. I want the system software to handle straightforward drawing on the screen. In this area the Macintosh system software excels.

The Mac knows how to draw rectangles, rounded rectangles, polygons, ellipses and arcs, and general closed figures. These basic objects can be outlined, filled in with any black-and-white pattern, or inverted (turning black pixels in the area to white and vice versa). The Mac can also draw lines and write text in software-definable fonts. The Macintosh graphics subsystem, called QuickDraw, supports a mechanism for recording graphics operations in a compact way and then playing them back.

The Macintosh doesn't support flood-fill. Flood-fill is what the "paint can" does in MacPaint: Starting at some point, the program colors in the screen, stopping at whatever boundary lines it comes across. True BASIC and several other programs accomplish this with custom software. (Note: The new 128K ROMs from Apple do support flood-fill.) Another weakness is the ellipse-drawing algorithm used by the Mac: An ellipse that is substantially longer on one axis than on the other is drawn unconnected, with frequent perforations. This means that such an ellipse cannot be flood-

| Amiga                                               | Macintosh                                                                    |
|-----------------------------------------------------|------------------------------------------------------------------------------|
| Anything happen?<br>Yes, your window is a new size. | Anything happen?<br>Yes, the mouse button was pressed.                       |
| Fine.                                               | Where was it pressed?<br>In the resizing box.                                |
|                                                     | If the window isn't frontmost, make it frontmost.<br>OK.                     |
|                                                     | Otherwise, what size does the user want?<br>This size.                       |
|                                                     | Hide the scroll bar.<br>OK.                                                  |
|                                                     | Change window sizes.<br>OK.                                                  |
|                                                     | Change scroll bar to the location and size I've calculated.<br>OK.           |
|                                                     | Redraw the scroll bar.<br>OK.                                                |
|                                                     | Remember to redraw the part of the window whose size I've calculated.<br>OK. |

Figure 1: Comparisons (in pseudocode) of a program's actions and the operating system's responses to a user event for both the Amiga and Macintosh. The user attempts to resize a window that contains a scroll bar.

filled—it leaks! Plenty of published ellipse-drawing algorithms don't have this undesirable property.

The Amiga's graphics primitives are less well developed than the Mac's. The Amiga knows how to draw rectangles and polygons. Objects can be outlined, filled with any multicolored pattern, or inverted. Sometimes the machine can perform a combination of these operations, like outlining with one color and filling with another, in one pass. The Amiga does support flood-fill. It draws lines and supports software-definable fonts. However, it does not draw ellipses or any other curved figures at all.

Figure 2 summarizes the graphics primitives of the two systems. The Amiga graphics software strongly reflects the Amiga graphics hardware. The hardware helps the system draw lines and rectangles, so lines and rectangles are well represented; other figures are not.

Another example of this kind of hardware-oriented design is the software interface to the blitter. The Amiga's blitter is a custom chip that does bit-aligned data manipulation. One of its many duties is moving screen images around. The strictest hardware limitation is imposed on the blitter: It can access only the lowest 512K bytes of memory. That's fine, that's what hardware is all about; but the software that uses this hardware should relax that restriction. It doesn't. One of the things you might want to do with a lot of memory is to store lots of images in it. This is possible on the Amiga, but you have to copy those images down into the lowest 512K of memory before any of the graphics routines will touch them.

For these reasons I prefer the Macintosh graphics primitives. They're well chosen, and they have natural interfaces. The Amiga graphics software is very powerful, in its idiomatic way, and it cooperates well with the hardware. Is it too much to ask that it cooperate with the programmer too?

**DEVICES**

A printer is the programmer's bane. Printers are so similar on the outside that it seems ridiculous not to support a large variety of them—but they're all

annoyingly different on the inside. Both the Amiga and the Macintosh try to get around the problem of printing by offering device independence. This means that the system software deals with the problem by offering a single device interface, regardless of what is connected to the computer.

To a program running on the Macintosh, the printer looks like a video screen. The program draws onto this screen just as if it were the video display, and the system software takes care of translating those operations into something the printer will understand. This makes good sense, but in practice it doesn't work out well at all.

The different Apple printers (and there are really only two) accept different subsets of the graphics primitives, so an operation that prints on the Imagewriter may produce no effect on the LaserWriter. The program is substantially involved in setting up, adjusting, paginating, and disposing of the special printer "screen." All this overhead is acceptable for a program that is printing complicated graphics, but for an ordinary text-only printing program like True BASIC, it's a lot of work.









An especially odd aspect of printing on the Macintosh is printing "in the background." Programs can allow you to do other things while the printer is busy. To do this, the program gives the Printing Manager (the software to handle printing operations) a procedure that it can call as often as pos-

sible. The program calls the Printing Manager, and the Printing Manager calls the program over and over to lend it processor time, and then when printing is done the Printing Manager returns to the program. This is ridiculous, but it's the Mac's lack of multitasking that is at fault, not the printing software—and multitasking is discussed in more detail below.

The Amiga offers several ways to use the printer. One is specifically designed for programs that print text only. Using this method, the program deals with the printer as if it were a file. The printer can be opened, written to, and closed just like a part of the file system. Special fonts and other features of the printer can be activated by the Amiga's printing software, which generates the required control sequences for the specified printer. Programs that need even more control over printing can access the printer driver directly. For printing graphics, the program passes the printer driver the same image used by the graphics primitives, rather like the Mac's scheme but a bit less automatic. [Editor's note: The Amiga uses printer-specific drivers that perform the conversion from generic primitives to hardware-specific control sequences. You select the driver that fits your printer from a variety of printer drivers supplied with the system disk.]

For other devices, like the serial port, the Amiga uses the same two-level scheme: The device can be

(continued)

|        |  |  |  |  |  |  |  | text                                                                                  |
|--------|-------------------------------------------------------------------------------------|-------------------------------------------------------------------------------------|-------------------------------------------------------------------------------------|-------------------------------------------------------------------------------------|--------------------------------------------------------------------------------------|---------------------------------------------------------------------------------------|---------------------------------------------------------------------------------------|---------------------------------------------------------------------------------------|
| draw   | <input type="checkbox"/>                                                            | <input type="checkbox"/>                                                            | <input type="checkbox"/>                                                            | <input type="checkbox"/>                                                            | <input type="checkbox"/>                                                             | <input type="checkbox"/>                                                              | <input type="checkbox"/>                                                              | <input type="checkbox"/>                                                              |
| fill   | <input type="checkbox"/>                                                            | <input type="checkbox"/>                                                            | <input type="checkbox"/>                                                            | <input type="checkbox"/>                                                            |  | <input type="checkbox"/>                                                              | <input type="checkbox"/>                                                              |  |
| invert | <input type="checkbox"/>                                                            | <input type="checkbox"/>                                                            | <input type="checkbox"/>                                                            | <input type="checkbox"/>                                                            | <input type="checkbox"/>                                                             | <input type="checkbox"/>                                                              | <input type="checkbox"/>                                                              | <input type="checkbox"/>                                                              |

= Amiga                       = Macintosh

Figure 2: A comparison of the graphics primitives supported by each machine.

*Consistent, high-level  
access to a variety  
of devices is a  
strong point of the  
Amiga that has almost  
no counterpart  
in the Macintosh.*

opened as a file for simple access, or it can be manipulated directly for more complicated operations. The Amiga's parallel port and RAM disk device also use this method. Consistent, high-level access to a variety of devices is a strong point of the Amiga that has almost no counterpart in the Macintosh. For example, the Mac's serial port is accessed only through a low-level driver. (Actually, it's accessed through two low-level drivers, one in ROM and one in RAM; but the latter seems hardly more than a debugged version of the former.)

#### MULTITASKING

A multitasking system is one that runs several independent programs at once, giving each the impression that it is the one and only. The Macintosh system software does not support multitasking. Given this, how do the Mac's desk accessories appear to operate as independent programs?

Desk accessories are parasitic. They depend on the currently running "host" program for almost everything. The program must call the ROM routine `SystemTask` as often as possible, which in turn calls the various desk accessories so that they can perform whatever periodic things they do. The program must also notice that certain events (keystrokes, mouse clicks, and menu selections) belong to a desk accessory and must pass those events along to it.

This arrangement makes the application responsible for starting up desk accessories. A program that allows the use of desk accessories

must find out which ones are available, create a menu listing them, and start up any desk accessory selected by the user. This means that desk accessories interact badly with the rest of the system and waste more programmer time than anything else I can think of on the Mac. Every program on the Mac becomes a frantic conspirator in the multitasking cover-up. Well, almost every program—some just give up on desk accessories, and others (like MacPaint) sharply restrict their use.

The only thing worse than supporting a desk accessory is being one. Desk accessories are hard to write because they're constructed so differently from the host programs they depend on. They're written as device drivers—which means, among other things, that they are table-driven, that they have to be small (about 8K bytes at the most), and that they have to be very careful not to alter the environment they work in.

One thing a multitasking system does is to mediate between programs that want to use the same device at the same time. If one program is using, say, the printer, another program will be told that the printer cannot be used right now. No such orderliness exists on the Macintosh. The Control Panel is a desk accessory that allows you to change (among other things) the volume of the Macintosh's sound. If a program is using the Sound Driver to make sound at the same time that the Control Panel is trying to change the sound volume, they often end up in a permanent battle for control.

The Amiga supports true multitasking. This is visible to the user, who sees that several programs can be run at once, but it can be nearly invisible to the program. There are no "desk accessories" on the Amiga because almost any program can run concurrently with any other. The program should practice moderation and not, for example, count to a million just to let some time go by. But even a greedy program like that could operate as one of several tasks, because the system software ensures that every task gets processor time. The system also mediates device ac-

cess, so that problems cannot be caused by having two programs accidentally access a device at the same time. The only thing a program really needs to be polite about is memory usage, because any program could take up all available memory if it wanted to. A multitasking system really needs a more sophisticated plan for memory management than this, and, as you'll see, I have one in mind.

The Macintosh should have had multitasking. I can't stress enough what a big contribution it makes to the elegant design of system software. The Amiga has an excellent multitasking system, and I think it will have twice the product life of the Macintosh because of it.

#### MEMORY MANAGEMENT

The architecture of the 68000 processor requires a stack, which is an area of memory used for subroutine addresses and other last-in/first-out data. Since the Mac and the Amiga both use the 68000, both have stacks; but the multitasking Amiga needs a separate stack for each task, and this results in a memory arrangement very different from that of the Macintosh.

The Macintosh has one stack, which grows from the top of memory down to a preset limit. It has two *heaps*, the system heap and the application heap. (Heaps are areas of memory for blocks that, unlike stack blocks, need not be freed in any particular order.) The system heap is small and cannot grow; it is used mostly by system software and is preserved across runs of a program. The application heap can grow up to a preset limit (the same limit toward which the stack is growing, from the other side). The application heap is reinitialized each time a program is run, so programs need not remember to deallocate blocks when they are shutting down.

Many heap blocks on the Macintosh *float*; that is, the system software may decide to move a data block without consulting the program that allocated that block. Often it will move all allocated blocks to one end of the heap so that all free memory is in a

(continued)



WE TOP IBM BEAUTIFULLY



**I** BM's Personal Computer is the standard of the industry, but a Thomson monitor gives your IBM's great body a beautiful face. A Thomson monitor atop your IBM simply outperforms the IBM Color Display.

Here's proof:

Who is Thomson? Thomson is a six billion dollar multi-national company. Unlike our competition, we design and build our own monitors with stringent quality control. We offer monochrome or color monitors from TV-grade to high resolution.

| FEATURE                     | THOMSON .38mm COLOR | IBM COLOR DISPLAY | BENEFIT             |
|-----------------------------|---------------------|-------------------|---------------------|
| Dot pitch (in mm)           | .38                 | .43               | Superior resolution |
| Screen                      | Non-glare           | Glare             | Less eyestrain      |
| Switch for green/amber text | Yes                 | No                | Improved legibility |
| All major controls up front | Yes                 | No                | Greater convenience |
| Warranty                    | 1 yr.               | 90 days           | Greater confidence  |
| List Price                  | \$549               | \$680             | A bargain           |

Call 1-800-325-0464. In California call 1-213-568-1002 (Monday-Friday, 9 a.m. to 5 p.m. PST) for your local Thomson dealer, and start looking at a beautiful face.

**THOMSON**   
A SIGHT FOR SORE EYES.™

© 1986 Thomson Consumer Products Corporation 5731 W. Slauson Avenue, Suite 111, Culver City, CA 90230  
Thomson is a trademark of Thomson S.A. IBM is a registered trademark of International Business Machines Corp. IBM model number 5153. List prices in effect on February 18, 1986.

continuous piece at the other. This helps reduce fragmentation and so conserves memory. Figure 3 shows a sample Macintosh memory layout.

One problem with the Mac's memory management scheme is the preset limit that divides the stack from the heap. The program has to decide where that limit is going to be—once set, it cannot easily be altered. For many programs it is difficult, if not un-

natural, to set such a permanent fence. True BASIC can't tell what kind of memory demands the user is going to make: Running a BASIC program that uses big strings would use a lot of heap memory, but running one that's heavily recursive would use a lot of stack. Another problem is the complexity introduced by the floating blocks. Naturally, there's a way for programs to find the current location of

a floating block, but the current location isn't current for very long and it's easy to make mistakes.

The most irritating problem with the Mac's memory management is that the stack can easily grow down past the limit and wipe out part of the heap. The system software uses some unspecified amount of stack space in addition to the amount used by the program. This makes it doubly difficult to determine when the stack is growing too low. There is virtually no way to guarantee that the stack won't overwrite the heap, and most programs merely try to make it as unlikely as possible.

The Amiga's memory management places everything at fixed locations in one heap: Data blocks do not float. Some memory is not accessible to the custom hardware, so programs need to explicitly request chip-accessible memory (that is, available to the graphics chips) if they want it. Each task has a stack, which is usually rather small (less than 8K bytes), and each task has to cope with the same problem of noticing when the stack is full. The operating system does not use the task's stack at interrupt time, which makes it somewhat easier to avoid stack disasters.

One drawback of the Amiga's memory management is that a program must remember exactly what heap blocks it allocated and must de-allocate them before shutting down. If it doesn't, the memory cannot be reused until the system is reinitialized (as by turning the machine off and then back on). The small, fixed maximum size for task stacks is also a nuisance. Most annoying is that other tasks may have allocated immovable blocks at any location in the heap, so a program cannot count on finding large continuous pieces of memory free. This is part of the reason why task stacks are usually so small—they have to be small enough so the program can be pretty sure of being able to allocate one.

Considering the design constraints of the Amiga, I don't see how the memory management software could have been much better. It's simple and fast, unlike the Mac's memory

(continued)

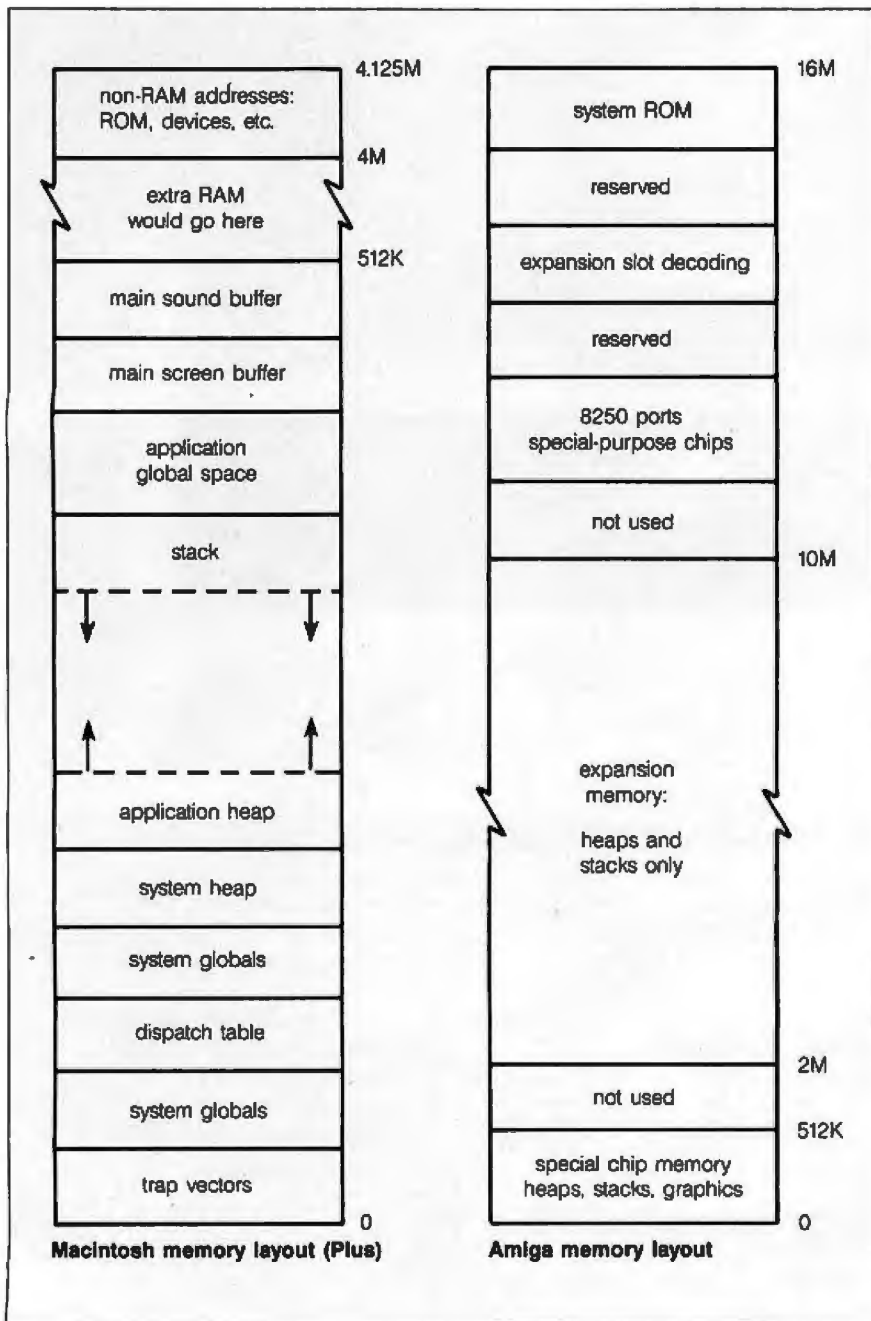
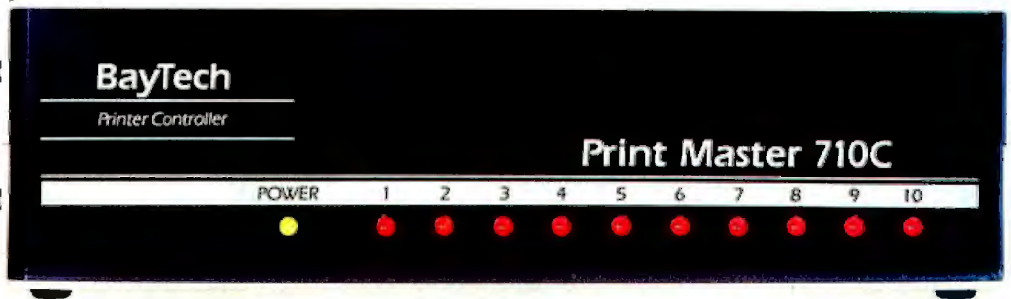

Figure 3: A comparison of the Amiga and Macintosh memory maps.

# PRINTER SHARING AND PRINT BUFFERING ALL IN ONE VERSATILE UNIT

Print Master from BayTech is an intelligent printer controller that connects between your computers and printers. It allows you to share one printer automatically, contend for multiple printers automatically, or switch between several printers by sending a simple code. Plus, Print Master's built-in buffer spools data until your printer can receive it.



## A VERY FLEXIBLE PRINTER SHARER

You configure Print Master's ports for any combination of printers and computers by answering questions from the easy-to-follow menus. For example, with the ten-port Print Master, nine computers can share one printer, eight computers can share two printers, seven computers can share three printers, and so on, to one computer which can share nine printers. You can also menu-select these features: the baud rate, word size, stop bits, parity, and XON/OFF handshaking; the disconnect time-out; and form feeds. Ports may be configured individually to translate for printers and computers using different configurations. All changes you make are saved in non-volatile memory.

## PRINT MASTER'S BUFFER KEEPS YOU WORKING

Since Print Master can accept data faster than your printer, you can dump a print job into Print Master's 512K buffer and then go on to another project. All connected users can send data to this common pool buffer, and they can be doing it at the same time, even if no printer is available. Data is stored in the buffer until it can be sent on a first-in-first-out basis to

the selected printer. If you need more memory, Print Master is optionally available with one megabyte buffer.

## CONTROL PRINT OUTPUT FROM YOUR COMPUTER

If several users are sharing one printer, printer sharing is completely automatic. There are no codes to send. You simply perform your normal print operation. If you are sharing several identical printers, connection is also

automatic. Again, you perform your normal print operation and are connected to the next available printer on a first-come-first-serve basis. Print Master will send data to all printers simultaneously to keep your printers running at full capacity.

If you are sharing several different printers, such as a letter printer, a laser-jet and a plotter, you do your normal print routine but insert a short printer select code (which you can define yourself) as the first characters of your data. The data is then routed to the selected printer. It's that easy.

## CHOOSE SERIAL OR PARALLEL MODELS

706A (6 parallel ports), \$795.  
706C (6 serial ports), \$795.  
706D (4 parallel/2 serial), \$795.  
708D (6 parallel/2 serial), \$895.  
708C (8 serial ports), \$895.  
710C (10 serial ports), \$995.  
Additional 500K buffer, \$249.

Want more details? Call or write BayTech at P.O. Box 387, Bay Saint Louis, MS 39520. Telex 910-333-1618. Phone 601-467-8231 or

**800-523-2702**

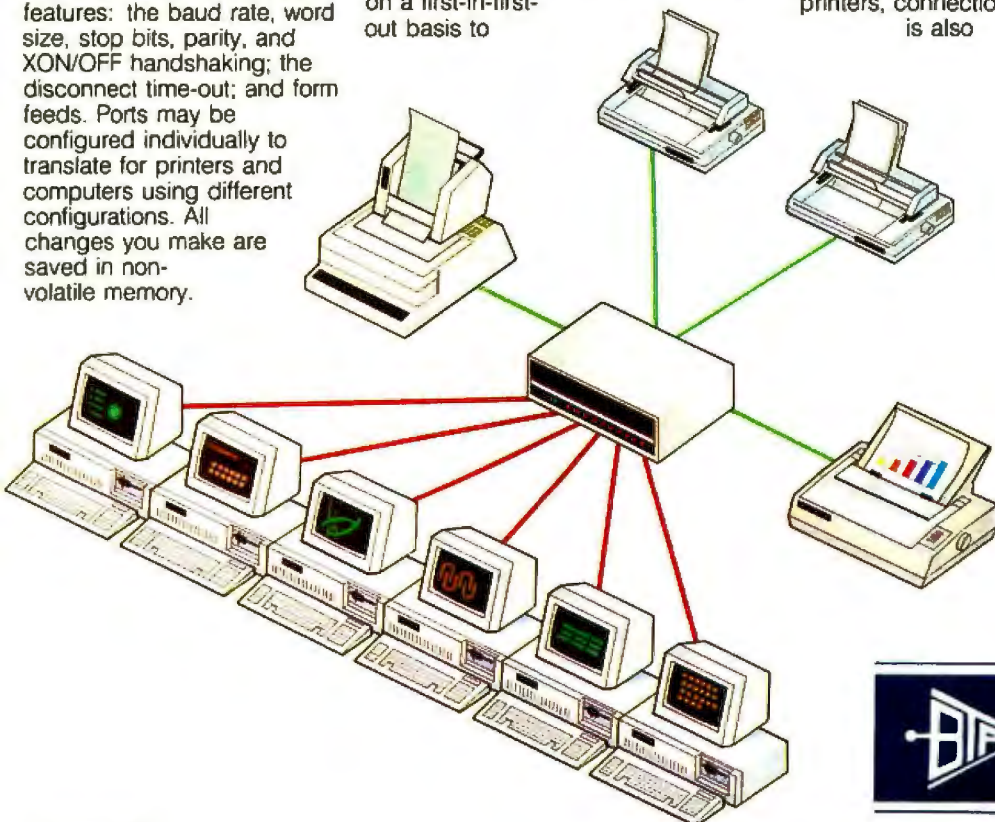

**SUNDA 10-5** **PROMPT DELIVERY**

**ATARI PRINCE** **Apple II**

**LAP TOP COMP.**  
 Kaypro NEC 8401 \$1049.00  
 Toshiba T-1100 \$1299.00  
 Toshiba 3100 \$1599.99

**COMMODORE**  
 Comm 128 \$1799.99  
 Comm 1571 \$1799.99  
 Amiga w/col. Mon. 1902-A \$2879.99

**MONITORS**  
 NEC Multi-Sync 514.99  
 PGS HX 12 399.99  
 PGS MAX 12 149.99  
 Taxan 630 409.95  
 IBM Col. Mon. 469.95  
 PGS HX-12E 639.99  
 Comrex Col. w/aud 139.99

**BROTHER SPECIALS**  
 Brother TF-50 89.99  
 Brother CF-100 124.00  
 Brother TF-300 119.00  
 Brother CF-300 199.99

**IBM PC** 640k 2 Floppies \$1049.00  
**IBM PC** 256k 10 Meg. Dr. \$1299.00  
**IBM XT-268** Dual Flopp \$1599.99  
**IBM XT-268** 360k 10 Meg Dr \$1799.99  
**IBM AT** Unenhanced \$2879.99  
**IBM AT** Enhanced \$2879.99  
**AT&T 6300** 640k 10 Meg Drive 1 Flopp. w Mon. \$1999.00  
**AT&T 6300 Plus** 640k 30 Meg Dr \$1399.99  
**SPERRY** PC - HT \$2649.99  
**SPERRY** PC - 11 44 Meg \$2649.99

**Brother HR15-XL** \$249.99  
**Brother HR-35** 189.99  
**Brother M-1109** 329.99  
**Brother M-1509** Call  
**Brother Twinwriter 5** 1849.99  
**Brother of Tr-50** 229.99  
**w/purchase of Tr-50** 329.99  
**Canon LBP-200S** Call  
**Citizen MSP-10** 344.99  
**Citizen MSP-20** 2879.99  
**Citizen MSP-25** 362.99  
**Epson FX-85** 1029.99  
**HP Laserjet Plus** 449.99  
**HP Pro Printer** 1019.99  
**IBM Quietwriter II** 449.95  
**IBM Pro Printer** 469.95  
**IBM P-6** 619.95  
**NEC 8850** Call  
**NEC 8850** 214.99  
**Okidata 193** 399.95  
**Okidata 292** 619.95  
**Okidata 293** 214.99  
**Okidata 2410** 399.95  
**Star SG-10C** 639.99  
**Star SG-321** 639.99  
**Toshiba 341** 639.99  
**Toshiba 351** 639.99  
**w/purch. of Tractor Feed** 639.99

**GUARANTEED LOWEST PRICES**  
**COMPUTER: 1-800-874-1235**  
**VIDEO: 1-800-223-6779**  
**COMPUTER: 1-800-223-6779**  
**VIDEO: 1-800-223-6779**

**TOLL FREE OUT OF N.Y. IN N.Y. CALL (718) 237-2828**  
**S'nW ELECTRONICS & APPLIANCES**  
 633 Bedford Ave, Bklyn, NY 11211

**HOURS: Mon-Thurs. 9-6**  
**Fri. 9-7, Sun. 10-5, Sat. Closed**

**C.O.D. Accepted**  
 • Credit Card accounts charged at time of order  
 • Add ships. hand. ins.  
 • Prices subject to change without notice  
 • Qty. limited  
 • Not responsible for typographical errors

AMIGA VS. MACINTOSH

management software, which, though it reduces memory fragmentation, is complex and slow. What I'd like to see in future machines is some memory management hardware. Mainframes have had the benefit of virtual memory systems for the last 20 years, and it's time this technology made it to micros. When people think of virtual memory systems they often think of *paging*, the automatic use of disk space as an extension of RAM. But with memory so inexpensive, who wants to page to a floppy disk? The real benefits of memory management hardware are *segmentation* and *access control*.

Segmentation means that memory is grouped into logical areas, not physical ones. There might be a segment for the stack and a segment for the heap. Hardware would take care of mapping these continuous logical areas into possibly noncontiguous pieces of RAM and would prevent them from ever running into each other. Access control means that the segments can be restricted for certain kinds of operations: A segment containing scratch space could be examined and altered but not executed, while a segment containing instructions could be examined and executed but not altered. Memory management hardware like this may never become an absolute necessity for single-user systems, but it would certainly make software development easier and more fun. I'd like to see it in future machines from Apple and Commodore.

CONCLUSION

Both of the 68000-based machines have excellent system software in places, but the Amiga is the winner in five of my six areas of comparison. The Amiga software is a bit thin: For example, it could use a more complete set of graphics primitives. But the Amiga's shortcomings are minor in comparison with some of the Macintosh's deep-rooted problems. The Macintosh lacks multitasking but tries to fake it, and it insists on a complicated user interface but leaves much of the work up to the application. These are serious drawbacks, and it is difficult to imagine elegant repairs for them. ■

**DataSaver 400**  
**Standby UPS**



Power protection for the most powerful micro-computer systems with peripherals is here, now, with the 400 Watt DataSaver. Protect your investment in application software and hardware with reliable, continuous power. 90 and 200 Watt capacities and international models are also available.

**Cuesta Systems Corporation**  
 3440 Roberto Court  
 San Luis Obispo, CA 93401  
 TLX: 4949381 CUESTA

©1985, Made in U.S.A.  
 Write or call 805/541-4160  
 Dealer, O.E.M. inquiries invited

**Upgrade  
Your Lotus 1-2-3,  
Framework, Symphony,  
Enable Or Smart Software  
For Only \$155! Call For Details.  
Act Now! Offer Expires Nov. 30, 1986.**

Available in English Language Version Only

# INTRODUCING OPEN ACCESS® II™

THE FULLY INTEGRATED BUSINESS SYSTEM  
WITH THE WORLD AT YOUR FINGERTIPS

Open Access II is a new, super-program which can perform virtually every managerial and business task you'll ever need with performance and ease-of-use unheard of in the industry.

Open Access II combines an extremely powerful relational database and superior spreadsheet with data communications, word processing, 3-dimensional graphics, and time management. Information is conveniently changed from module to module.

Open Access II's Database features an effective and flexible report generator and user definable screens. "Programmer," our new Database language, features simple interacting English-like commands to produce your customized applications.

Open Access II's Spreadsheet offers a unique combination of business problem solving capabilities; including goal-seeking, and an advanced table look-up command. Professional business presentations are easily produced by the enhanced graphic capabilities.

Open Access II's improved Word Processor can merge data from Spreadsheet or Database easily to produce reports, mail merge and graphic presentations.

Inquiry 320 for End-Users.  
Inquiry 321 for DEALERS ONLY.

Open Access II's data communications provides you with the capabilities to handle any of your micro computer communications needs. All of Open Access II's modules work together and data is easily communicated to the rest of the world.

**BEST OF ALL,  
THE PRICE**

**\$595.** U.S. Version Only

Open Access II's super program is also available in the network version. Ask for details. Call (619) 450-1526 in California, or (800) 521-3511 if outside California for your nearest authorized dealer or distributor and expand your business base with Open Access II, the fully integrated business system.

**SPI**

**SOFTWARE PRODUCTS INTERNATIONAL**

10240 Sorrento Valley Road  
San Diego, California 92121  
(619) 450-1526  
For Your Authorized Dealer  
In California

**(800) 621-7490**  
Outside California  
**(800) 521-3511**

© 1986 Software Products International, Inc. All rights reserved.  
Open Access is a registered trademark of Software Products International, Inc.  
Open Access II is a trademark of Software Products International, Inc.  
Lotus 1-2-3 and Symphony are registered trademarks of Lotus Development Corp.  
Framework is a registered trademark of Alpha-Tek.  
Enable is a trademark of The Software Group.  
Smart is a trademark of Inspira Software, Inc.  
Tandy is a registered trademark of Tandy Corp.

\*Price: U.S. Version Only

## Open Access II Comparison Chart

|                       | Database | Form Query | Report Generator | Query Processor | Relational Database | Graphics | 3-D Graphics | Spreadsheet | Goal Seeking | Word Processor | Communications | Time Management | Price                   |
|-----------------------|----------|------------|------------------|-----------------|---------------------|----------|--------------|-------------|--------------|----------------|----------------|-----------------|-------------------------|
| <b>Open Access II</b> | ✓        | ✓          | ✓                | ✓               | ✓                   | ✓        | ✓            | ✓           | ✓            | ✓              | ✓              | ✓               | <b>595<sup>00</sup></b> |
| Lotus 1-2-3           |          | ✓          |                  |                 |                     | ✓        |              | ✓           |              |                |                |                 | 495 <sup>00</sup>       |
| Symphony              | ✓        | ✓          | ✓                |                 |                     | ✓        |              | ✓           |              | ✓              | ✓              |                 | 695 <sup>00</sup>       |
| Framework             | ✓        |            | ✓                | ✓               |                     | ✓        |              | ✓           |              | ✓              | ✓              |                 | 695 <sup>00</sup>       |
| Enable                | ✓        |            | ✓                |                 |                     | ✓        | ✓            | ✓           |              | ✓              | ✓              |                 | 695 <sup>00</sup>       |
| Smart                 | ✓        |            | ✓                |                 |                     | ✓        | ✓            | ✓           |              | ✓              | ✓              |                 | 895 <sup>00</sup>       |

**NETWORK VERSION  
AVAILABLE**





# Reviews

---

|                                                                        |            |
|------------------------------------------------------------------------|------------|
| <b>REVIEWER'S NOTEBOOK</b><br><i>by Jon Edwards</i> .....              | <b>261</b> |
| <b>THE FRANKLIN ACE 2200</b><br><i>by Albert S. Woodhull</i> .....     | <b>263</b> |
| <b>THE LEADING EDGE MODEL D PC</b><br><i>by Stan Miastkowski</i> ..... | <b>269</b> |
| <b>THE XEROX 6060</b><br><i>by Wayne Rash Jr.</i> .....                | <b>275</b> |
| <b>THE C. ITOH TriPRINTER</b><br><i>by Robert D. Swearengin</i> .....  | <b>283</b> |
| <b>THE TURNER HALL CARD</b><br><i>by Jonathan Angel</i> .....          | <b>287</b> |
| <b>TURBO PROLOG</b><br><i>by Namir Clement Shammas</i> .....           | <b>293</b> |
| <b>SOFTWARE CAROUSEL</b><br><i>by Mark Haas</i> .....                  | <b>299</b> |
| <b>PARADOX 1.1</b><br><i>by Rusel DeMaria</i> .....                    | <b>303</b> |
| <b>WORDPERFECT 4.1</b><br><i>by Ricardo Birmele</i> .....              | <b>311</b> |
| <b>REVIEW FEEDBACK</b> .....                                           | <b>315</b> |

---

THE FRANKLIN ACE 2200 is an Apple IIe/IIc clone, but Albert S. Woodhull reports that the system differs from other members of the Apple family. The two disk drives are integrated and the keyboard is detached. He has found the system to be well built and highly compatible, but two expansion slots may not satisfy all users.

The Leading Edge Model D PC is an IBM PC clone with a long list of standard features. Stan Miastkowski reports that the computer is a very good value, with the lack of a higher processor speed being its main deficiency.

According to Wayne Rash Jr., the Xerox 6060 is virtually identical to the AT&T PC 6300. He was very pleased with the system's quiet and quick operation, although you should consider seriously his comments about obtaining affordable support.

Apart from a defective cover catch, Bob Swearengin enjoyed working with the C. Itoh TriPrinter. The price is not cheap, but the 9-wire print head can produce a variety of typefaces, the output is fast, and the overall print quality is very good.

Jonathan Angel takes a brief look at one of many memory-expansion boards for IBM PC compatibles. The Turner Hall Card adds 256K bytes of memory, a clock/calendar, and software to let you set up a print spooler or a RAM disk. Even if you are considering a similar board, his discussion on installation should interest you.

Namir Clement Shammas reviews Turbo Prolog, a language that may do for Prolog what Borland's first language did for Pascal. He enjoyed the language's environment, its very fast compiler, and its support for screen and window management, but he has important reservations concerning its nonstandard implementation.

Software Carousel is a virtual memory manager that lets you load up to 10 applications at the same time. Mark Haas suggests that the \$49.95 package has some minor limitations, but you might appreciate the fact that you can use any available main storage memory to hold inactive partitions.

Rusel DeMaria looks at Paradox 1.1, a relational database that combines a powerful script language, keystroke macros, and a complex relational data structure. The result is a powerful database well worth a look.

Finally, Ricardo Birmele examines the latest version of WordPerfect, which includes a wide variety of improvements and new features. Users of word processors will have little to criticize here.

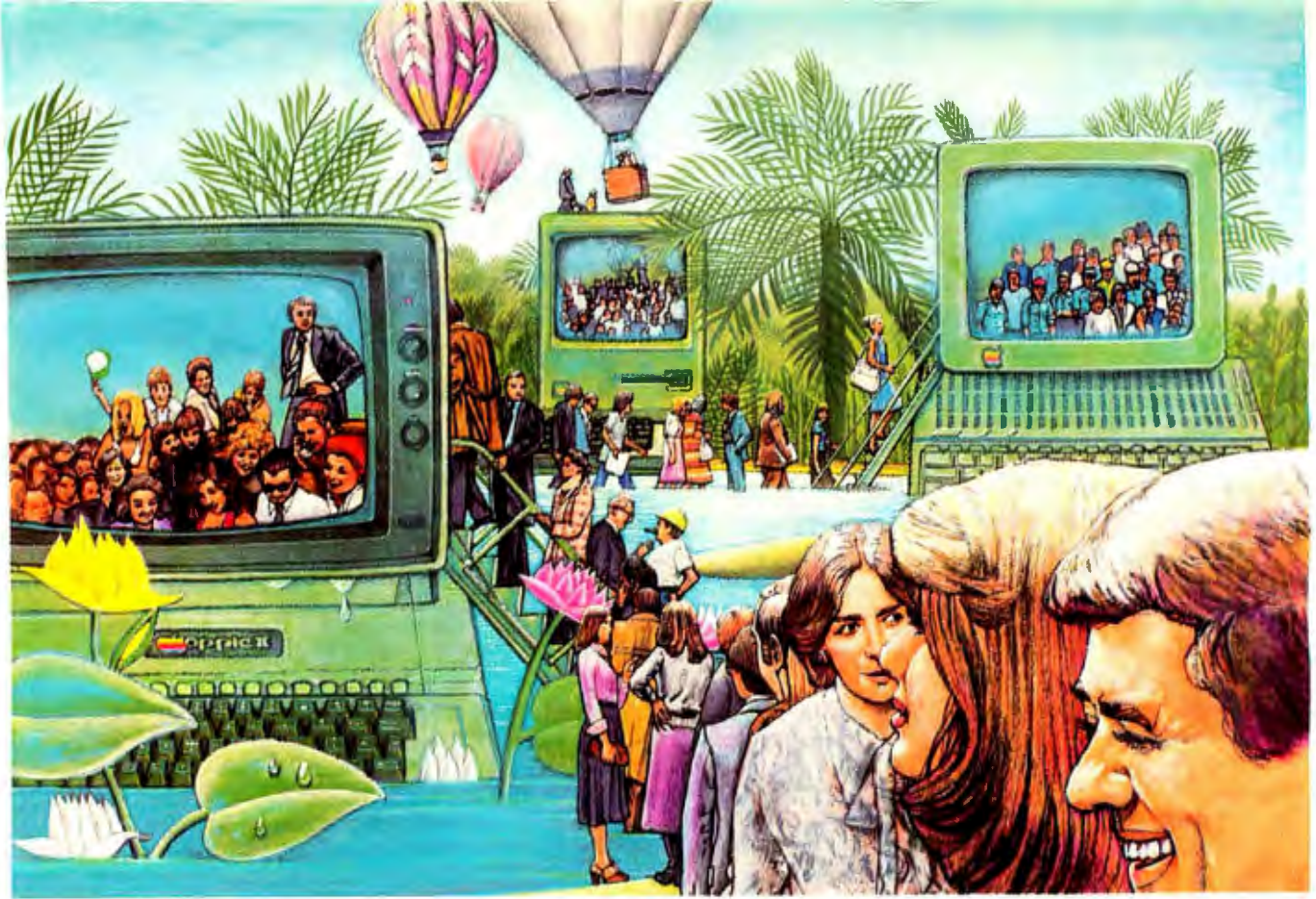

# USE THE BRAINS YOUR APPLE WASN'T BORN WITH.

## Right at your fingertips in CompuServe's Apple® Forums.

Join the CompuServe **Apple II and III Forum** to swap everything from tall tales to short cuts with other users, and explore thousands of classic programs stockpiled since 1979.

Swap programs and files with fellow Mac owners in our **Macintosh® Users Forum**. Questions? You'll get answers from the experts here!

Visit the **Macintosh Developers Forum**. Get updates to the "Inside Macintosh Software Supplement." Interact with the Mac "team" in Cupertino.

The **Apple User Groups Forum**, supported by Apple Computer, unites officers of Apple user groups—"ambassadors" for hundreds of thousands of Apple-active enthusiasts worldwide.

### Easy access to free software.

- Download *First-rate, non-commercial, user-supported software and utility programs.*
- Take advantage of CompuServe's

*inexpensive weeknight and weekend rates (when Forums are most active, and standard online charges are just 10¢ a minute).*

- Go online in most major metropolitan areas with a local phone call.
- And receive a **\$25.00 Introductory Usage Credit** with purchase of your CompuServe Subscription Kit.

### Information you simply can't find anywhere else.

Use the *Forum Message Board* to send and receive electronic messages, and pose specific questions to Apple owners.

Join ongoing, real-time discussions in a *Forum Conference*—with Apple luminaries like Bill Atkinson, Doug Clapp, Dan Cochran, Jean-Louis Gasse, Mark Pelczarski, John Sculley and Steve Wozniak.

Search *Forum Data Libraries* for free software, user tips, transcripts of previous CompuServe online conferences and more.

### Enjoy other useful services like:

- **Popular Computer Magazines**—electronic editions, for your reading pleasure. Including *Apples Online*, which reprints

*articles from leading user group newsletters nationwide and other Apple-related publications.*

- **Other CompuServe Forums**—supporting *Jazz™* and other *LOTUS®* products. *Microsoft®, MicroPro®, Borland International®, Ashton-Tate®,* and other software. Also *Pascal, Basic, C, Forth, Assembly* and other programming languages.

### All you need is your Apple computer and a modem ... or almost any other personal computer.

To buy your Subscription Kit, see your nearest computer dealer. Suggested retail price is \$39.95. To receive our free brochure, or to order direct, call 800-848-8199 (in Ohio, call 614-457-0802). If you're already a CompuServe subscriber, type GO MAUG (Micronetworked Apple Users Group) at any ! prompt to see what you've been missing.

## CompuServe®

Information Services, P.O. Box 20212  
5000 Arlington Centre Blvd., Columbus, Ohio 43220

**800-848-8199**

In Ohio, Call 614-457-0802

An H&R Block Company

Inquiry 76



# R·E·V·I·E·W·E·R'S N·O·T·E·B·O·O·K

---

This month I intended to provide a quick look at the best and brightest products from the 1986 National Computer Conference in Las Vegas, but the show was disappointing. Attendance was down, and very few new microcomputer products were shown. However, I vowed that I'd never return from a show cynically proclaiming that there was nothing there.

Therefore, I'm happy that Alloy (100 Pennsylvania Ave., Framingham, MA 01701, (617) 875-6100) showed its Bi-Turbo board, a dual-tasking accelerator for IBM PCs and compatibles. The plug-in card has an 8-MHz V20 processor, 1 megabyte of RAM, and a dedicated serial port. Bundled software allows you use the board to perform two separate tasks simultaneously. The software also provides disk caching.

Alloy recommends that you have 640K bytes of RAM in your system, although the board will operate with less memory. Note, however, that DOS 3.1 and the Bi-Turbo operating system take up approximately 142K bytes of your system's RAM, and you must have both a hard disk and DOS 3.0 or later. The software supports monochrome and CGA, but not EGA. A review of the board is now being written and should appear in *BYTE* this winter.

We hoped to find evidence of new products for the Amiga and the Atari ST at NCC, but the best source was the pile of packages waiting back at the office. For the Amiga, Byte by Byte Corporation (3736 Bee Cave Rd., Suite 3, Austin, TX 78746, (512) 328-2983) has just released Informer, a powerful and innovative database manager. With it you can store, organize, and access text and graphic information. A display utility lets you view the content of files, in-

cluding standard AmigaDOS text files and IFF format graphics. Byte by Byte claims that the database functions best with files that are prepared with it.

Byte by Byte has also just released its expansion chassis for the Amiga. For \$1795, you obtain 1 megabyte of reserve memory (in addition to the 8 megabytes of RAM accessible through the expansion port), a battery-powered clock and calendar, and 5 DMA expansion slots. The chassis, which also will support up to three half-height devices including a hard disk, has a 200-watt power supply and will autoconfigure under Kickstart/Workbench 1.2. The unit, which includes a 20-megabyte hard disk, will sell for \$3195.

For the Atari ST, Batteries Included (30 Mural St., Richmond Hill, Ontario, Canada L4B 1B5, (416) 881-9816) has released Time Link, a time management system, and Thunder, a Borland Lightning-like spelling checker. Time Link, which is also available for the Macintosh, lets you organize time-related information. The information you enter into the database is stamped with a time, allowing you to organize and structure your time or simply keep track of any time-based information. More advanced aspects of the utility allow you to compile information in separate categories over a period of time. You could, for example, use the tool to keep track of regular expenses.

We first saw Thunder at COMDEX in Atlanta, but it has now been released. Dubbed "The Writer's Assistant," Thunder provides a real-time spelling checker and a macro facility very much like PRD+ that uses abbreviations to speed up your typing. It also includes several writing tools for analyzing your prose and counting your words.

Finally, some reviews business. We are, as always, concerned with providing you with the best reviews in the business. And, of course, we want to provide as many reviews as possible. We have therefore organized a large number of comparative reviews of IBM PC and PC AT clones, PC AT multifunction boards, modems, printers, expansion boards, and, when possible, languages. You will begin seeing more of these comparative reviews in the next few issues, and I certainly want to hear what your reactions are.

We obviously have no desire to sacrifice our comprehensiveness or our user perspective, and I think that we have done well. We will be able to review far more products than ever before, and all of you who have walked the aisles at the larger computer shows know how important that can be.

However, our readers are the best judges. If you can, write me a quick note (c/o *BYTE*, One Phoenix Mill Lane, Peterborough, NH 03458) to let me know how you feel about the direction of the Reviews section. After all, we are trying to serve you.

As for more immediate concerns, we are organizing a comparative review that will pit the new IBM PC Convertible against the Zenith Z-180, the Bondwell 8, and the Toshiba T1100 Plus. The review should be very exciting, especially since all of these machines are currently competing for government contracts. There will also be a Product Description of the IBM PC Convertible in our special IBM issue this fall. In addition, we are preparing comparative reviews of 18-pin dot-matrix printers, EGA boards, three new BASICs for the Macintosh, and much more.

—Jon Edwards  
Senior Technical Editor, Reviews



# TITAN UP YOUR ACT

**\$1695**  
GIVES YOU  
ALL OF THESE FEATURES

## COMPUTITAN

Model No. MPC-2100A

- PC/AT COMPATIBLE
- 80286 CPU, OPTIONAL 80287
- SOFTWARE SELECTABLE 6- OR 8MHz CPU SPEEDS
- 640 KB RAM ON BOARD, EXPANDABLE TO 1MB
- ONE 1.2 MB FLOPPY DRIVE
- SIX FULL SLOTS AND TWO HALF SLOTS
- PSA BIOS
- MS-DOS 3.2 & GW BASIC
- 84 KEY AT - STYLE KEYBOARD
- 192 WATT POWER SUPPLY
- FCC CLASS "B"



COMPLETE EGA AT SYSTEM  
FOR ONLY AN ADDITIONAL

**\$269**

## M.E.G.A.

Model No. MBC-EGA-P

- IBM EGA COMPATIBLE - EMULATES THE FEATURES OF THE IBM COLOR GRAPHICS ADAPTER, ENHANCED COLOR GRAPHICS ADAPTER AND MONOCHROME DISPLAY ADAPTER
- 256 KB RAM BUFFER
- LIGHT PEN INTERFACE
- PARALLEL PRINTER PORT
- FCC CLASS "B"
- MODEL NO. MBC-EGA/M-SP FEATURES ENHANCED EGA CARD WITH HERCULES GRAPHICS ABILITY AND AN RS-232C SERIAL PORT-\$345.

## MITAC'S COMPUTITAN / M.E.G.A. ENHANCED GRAPHICS SYSTEM PUTS ON A DAZZLING DISPLAY

PC/AT & EGA COMPATIBLE

If all you want out of a computer is a fancy typewriter/calculator, this ad was not written for you—but if you see the computer as the powerful aid to creative thinking that it is, read on:

—because Mitac's CompuTitan/Enhanced Graphics System will take you and your colleagues out of the dreary monochrome wasteland into a splendid world of clear, precise, brilliant color and give you all the speed and storage capacity you need to shape mountains of data—and your ideas—into a creation all your own.

Here in the same package are combined Mitac's PC/AT compatible CompuTitan and the M.E.G.A. (Mitac Enhanced Graphics Adapter). Together they provide the perfect complement to the EGA-compatible display of your choice—and TRW will provide speedy and reliable service for all Mitac products throughout North America! Call the toll-free number below for the address of the Mitac distributor in your area.

**mitac**

When reliability is a decisive factor

Mitac Inc. No. 585 Ming Sheng E. Rd., Taipei, Taiwan, ROC TEL (02) 501-8231; TLX 20261 MECTAC, 11942 TAIAUTO, FAX: 886-2-501-4265.

American Mitac Corp. 3385 Viso Ct., Santa Clara, CA. 95054. TEL (408) 988 0258, 988-7508; TOLL FREE: 1-(800) 321-8344 TLX. 910-338-2201 MECTEL, FAX: 408-980-9742.

IBM PC/AT and EGA are registered trademarks of International Business Machines Corporation. MS-DOS is a trademark of Microsoft Corp.

Hercules is a registered trademark of Hercules Computer Technology.



# THE FRANKLIN ACE 2200

BY ALBERT S. WOODHULL

Although the Franklin ACE 2200 is an Apple IIe/IIc clone, its package is different from that of any member of the Apple II family. The two disk drives are integrated into the main unit, and the keyboard is detached. Franklin supplies its own disk operating system, and the internal firmware, including Franklin BASIC, is different from that of an Apple II. However, the ACE 2200 is designed to be a work-alike of an Apple IIe or IIc, with a 65SC02 microprocessor, built-in 128K-byte memory, graphics at low, high, and double-high resolution, expandability with standard Apple II peripheral cards, and the ability to run most programs written for the Apple II family.

## PHYSICAL CHARACTERISTICS

The ACE 2200 is a well-built system. The two half-height 5¼-inch floppy disk drives have indicator lights to show activity and read/write status. The front panel has five indicator lights labeled Power, Diag, Disk Error, Dbl Hi Res, and CPU. I particularly like the Disk Error light; it flickers when disk errors are detected. This provides a useful early warning that a floppy disk is getting unreliable.

All the standard interfaces (keyboard, printer, game controller, and monitor) are attached by connectors to the backpanel, and there are cut-outs for mounting additional connectors. From the rear panel, you can access a volume control for the built-in speaker. This is a nice idea, particularly for a family computer that might be used for playing games with sound effects. Also on the rear panel are four

## *An inexpensive Apple II clone with a detachable keyboard and integrated disk drives*



option switches for selecting an alternate character set and several other configuration options. The rear panel does not provide AC power outlets for the monitor or the printer.

You access the inside of the computer by removing two small screws from the rear panel and sliding the cover forward. The front panel and the disk drives remain attached to the cover, and several cables connect the drive assembly and front panel to the motherboard. This makes it difficult to open the machine. This problem may not bother many users, but for those who do a lot of work that requires switching interface cards, it may become annoying. Apple's easy access to the peripheral slots would have been a welcome feature in the ACE 2200.

When I opened the cabinet, I was surprised to see that there are over 110 integrated circuits on the main board. Recently the trend has been to rely on small numbers of specialized chips, but Franklin does not take this path with the ACE 2200. This means that if a malfunction can be identified, a long wait to obtain a part available only from the manufacturer is unlikely. On the other hand, however, most of the integrated circuits, except for RAM, ROM, the microprocessor, and a few other specialized chips, are soldered directly to the board. Thus, a local service person will not find it easy to locate a malfunction by systematically swapping chips.

## THE KEYBOARD

Although I am not a skilled touch typist, the Franklin's keyboard seemed adequate to me. The two least-used punctuation keys, the backslash (\) and single left quote (') keys, are located outside of their usual placement area, but otherwise the layout is standard, and the keys are full-size. The keyboard is connected to the main unit by a coiled cable that can easily be stretched out to five feet or more. It is very lightweight, and you can easily operate it with it resting on your lap.

At boot-up, the keyboard is in Caps

*(continued)*

Albert S. Woodhull (School of Natural Science, Hampshire College, Amherst, MA 01002) received his bachelor's degree from MIT and his Ph.D. from the University of Washington. He is currently an associate professor of computer studies and biology at Hampshire College.

**Franklin ACE 2200**

**Company**

Franklin Computer Corporation  
Route 73 and Haddonfield Rd.  
Pennsauken, NJ 08110  
(609) 488-0600

**Size**

Main unit: 15¾ by 13½ by 4 inches

**Components**

**Processor:** 65SC02 8-bit processor; 1.023 MHz clock speed

**Memory:** 128K bytes of RAM; 24K bytes of ROM

**Display:** Apple-compatible 40- or 80-column by 24-line text display; low-, high-, and double-high-resolution graphics; standard composite video output; provisions for RF modulator to allow use of standard television set

**Keyboard:** 90 keys, including full uppercase and lowercase alphabetic; numeric keypad; 12 function keys; open- and closed-F (equivalent to Apple's open- and closed-Apple keys)

**Disk storage:** Two 5¼-inch half-height floppy disks, format and capacity identical to Apple II; disks can be formatted for 40 tracks for about 15 percent more capacity, but Apple compatibility is lost

**Expansion:** Two internal connectors provided for standard Apple peripheral cards; expansion connector provided for an external expansion chassis, which has four additional slots

**I/O interfaces:** Composite video output, keyboard, game controller, serial printer interfaces standard; mounting holes for seven additional connectors provided

**Software**

Franklin BASIC in ROM, Franklin DOS 2 version 5.0, several utility programs

**Documentation**

User's reference manual, 150 pages  
Technical reference manual (not supplied with the review model)

**Price**

\$999

**SYSTEM FEATURES**

MEMORY SIZE (K BYTES)



DISK STORAGE (K BYTES)

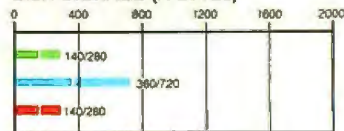

**DISK ACCESS IN BASIC (IN SECONDS)**

WRITE



READ

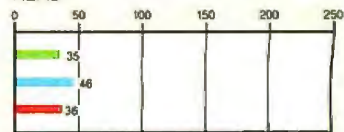

**BASIC PERFORMANCE (IN SECONDS)**

SIEVE

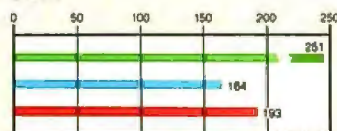

CALCULATIONS

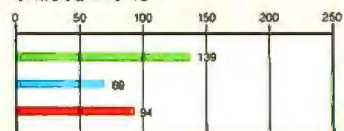

**SYSTEM UTILITIES (IN SECONDS)**

40K FORMAT/DISK COPY



40K FILE COPY



**SPREADSHEET (IN SECONDS)**

LOAD



RECALCULATE



FRANKLIN ACE 2200 IBM PC APPLE IIe

In the Disk Access in BASIC graph, a 64K-byte sequential text file was written to a blank floppy disk and then read. (For the program listings, see BYTE's *Inside the IBM PCs*, Fall 1985, page 195.) In the BASIC Performance graph, the Sieve column shows how long it takes to run one iteration of the Sieve of Eratosthenes prime-number benchmark. [Editor's note: This program had to be adjusted to run on the ACE 2200—see text.] The Calculations column shows how long it takes to do 10,000 multiplication and 10,000 division operations using single-precision numbers. The System Utilities graphs show how long

it takes to format and copy a disk (adjusted time for 40K bytes of disk data) and to transfer a 40K-byte file using the system utilities. [Editor's note: The Disk Access and System Utilities benchmarks were performed using Apple's ProDOS. The ACE 2200 is supplied with Franklin's DOS 2 version 5.0, an Apple DOS 3.3 clone with improved disk I/O. As a sample comparison, an Apple IIe performing the Write benchmark in Apple DOS 3.3 required 180 seconds, while the ACE 2200 running Franklin DOS 2 ran the benchmark in 125 seconds.] The IBM PC was tested with PC-DOS 2.0.

Lock mode, which is signaled by a status light. Initially, the numeric-mode light is off, indicating that the numeric keypad is functioning as a cursor control pad. In addition to the usual cursor movements, this keypad provides several other screen-oriented commands and single-key-stroke execution of BASIC RUN and LIST commands. The closed-F and open-F keys duplicate the functions of the Apple's closed- and open-Apple keys. There are also 12 function keys, which will be examined later along with Franklin BASIC, since a special BASIC command is the only documented way to set them up.

### THE MONITOR

The ACE 2200 that I reviewed came equipped with a green-phosphor Franklin monitor. The computer generates a standard composite video signal, so any other composite input monitor or a standard television with an RF modulator would work with the system. The ACE 2200 monitor's housing matches the main cabinet, and it tilts and swivels over a wide range. The resolution is excellent—the specifications indicate that it has a 22-MHz video bandwidth. I did have some trouble adjusting the contrast and brightness. After I adjusted the vertical size so that Apple Logo graphics produced a true circle, the dots making up the characters fused horizontally but not vertically, giving them an unpleasant beaded appearance. I decided to decrease the vertical size when I used text.

The extremely short cable supplied with the monitor was a nuisance because of my frequent need to open the cabinet. The monitor cable, like all the cables supplied, has large ferrite cores on each end to suppress RF interference, but I decided to risk using another longer cable I had. Since I have cable television, I had no problems with interference.

### EXPANDABILITY

The ACE 2200's expansion capabilities lie somewhere between those of its two Apple competitors. The Apple IIe has an internal bus with seven connectors available for various peripherals, and it requires interface cards

for the disk drive, printer, and serial communications. The Apple IIc has no peripheral card slots, but the interfaces for the disk drives, printer, and serial communications are built in. In the ACE 2200, the disk controller and the parallel printer interfaces are built in, and two additional peripheral card slots are available. One of these slots functions as slot 2 and is intended for use with a serial communications interface. The other slot can be jumpered to be addressed as either slot 4 or slot 7.

The ACE 2200 also allows an expansion chassis to be attached by a connector, which is accessible by removing a small cover on the right-hand side of the cabinet. This provides slots for four additional peripheral cards. (My review machine was not provided with an expansion chassis.)

I tested the ACE 2200 with several of the peripheral cards I normally use in my Apple. I used an Advanced Logic Systems CP/M Card and a Synetix Flashcard RAM disk extensively with no trouble. I wrote most of this review on the ACE 2200 with MINCE, a CP/M word-processing program.

While testing a Microsoft Softcard, I noticed an unusual flickering of some of the dots on the video display. This effect disappeared after the system had been running for a while. It also vanished during disk accesses, when the 6502 microprocessor is handling I/O and the Z80 is inactive. The Taurus 8 large-format floppy disk controller I normally use with my Apple also worked well with the ACE 2200 under CP/M with either of the Z80 coprocessors.

I had one major hardware compatibility problem: An Apple Co-op Big Board (a 1-megabyte RAM disk) would not work properly in the ACE 2200. The system would not boot properly when the Big Board was in place, and the screen display was torn, as if there was a serious disruption of the video sync timing.

The problems with the Big Board and the Softcard indicate that the ACE 2200's internal timing and video signal generation are significantly different from that of the Apple II+, which works well with both cards. Purchasers of the ACE 2200 who intend

to use a coprocessor or an extended memory card should make sure that they have chosen compatible cards.

### FIRMWARE AND SOFTWARE

From my observations of the cabinet's insides, I found that the ACE 2200 has a total of 24K bytes of firmware in ROM. This includes a machine language monitor that is called in the same way as the Apple's machine language monitor (by a CALL-151 from BASIC). There is absolutely no mention of the monitor commands in the user's reference manual. The commands to examine, alter, and move memory contents seem to work exactly as they do in the Apple II series, but other commands, including the one used to disassemble 6502 code, are missing.

One aspect of the firmware that didn't work properly was the graphics screen dump. I have a Star Micronics Gemini-10 printer, which is one of four printers for which a screen dump command is supplied. However, trying to dump the screen pattern generated by Franklin's diagnostics program did not work.

### FRANKLIN BASIC

Franklin BASIC is also supplied as part of the firmware. Franklin claims that its BASIC is compatible with Apple-soft BASIC, but it has one documented extension and one documented omission. I found a few other differences, two of which may be serious problems.

The extension is the FKEY command, which allows you to set each of the 12 function keys to generate a unique string when pressed. The only limitation is that the total number of characters in the strings for all the function keys must be less than 233. A program containing FKEY statements will hang up on an Apple, but portability of this function is not really a necessity, since you would use it primarily in the Hello program that executes at boot-up.

The documented omission of Franklin BASIC is that it does not recognize commands related to cassette tape storage (the ACE 2200 has no tape interface). Since the days of cassette

(continued)

storage are now long gone. I don't think these commands will be missed.

One feature that the manual doesn't describe is that you can enter BASIC programs using either uppercase or lowercase keys. When you list the program, you see the BASIC keywords in lowercase, and the other parts of your program are displayed as they are entered. I particularly like this feature because it adds clarity to the listings. BASIC programs originally written on an Apple are also listed in this manner. There is a potential pitfall, however, if you want to write a program on the ACE 2200 that will also run on an Apple. In Franklin BASIC, variable names are saved in the form in which they are entered; thus, a and A are distinct variables. The Apple cannot recognize lowercase variable names, however. A program with lowercase variables can be listed and edited on an Apple, but it won't run. For Apple compatibility, you must enter variable names in uppercase.

A more serious problem occurred when I attempted to run a program I had written that lists text files to the console or printer. The program refused to run on the ACE 2200 when the 80-column display was active. As the screen scrolled, the text near the top became blanked out, and eventually the program crashed. ASCII blanks seem to be written into the Franklin BASIC program memory. I was able to list only the first line of the BASIC program, and many commands would not work until I rebooted. This problem did not occur when I used the ACE 2200's 40-column display mode, however.

This program uses no undocumented tricks of Applesoft BASIC, but it does output dummy characters to the display to get around the Apple quirk in which the first character sent to the output following a `get` command is not displayed. This bug is well known and likely to be encountered in commercially available Apple programs, and a good Apple clone should be able to handle it.

I ran into a problem with Franklin BASIC while testing it with the Sieve of Eratosthenes benchmark. The standard BYTE Sieve program uses a 7000-element array. On the Apple II+

with Apple DOS 3.3, this uses almost all available memory. On the ACE 2200, the problem isn't just that the machine has less memory available for the array; Franklin BASIC incorrectly executed the DIM statement without issuing an "Out of Memory" error message. Editing the program to decrease the array size to 6000 elements resulted in a correct run. Running with the array size at 8000 was, of course, not possible, but in this case, the machine properly reported "Out of Memory."

Clearly, there are two serious problems here. Since ACE 2200 owners will depend on software written for the Apple, they may be disappointed by programs that use all available memory. Moreover, it is unacceptable for a machine to fail to detect over-allocation of storage when running a high-level language.

#### DISK OPERATING SYSTEM

Franklin Corporation supplies its Franklin DOS 2 version 5.0 with the ACE 2200, along with several utility programs for disk and file copying, hardware diagnosis, and disk verification. I didn't find any problems with the DOS, and it seems to be able to read and write text files considerably faster than Apple DOS. The Franklin DOS recognizes the hyphen (-) as a smart run command (as in Apple's ProDOS), which allows you to run an executable file by typing a dash before its name. This will work whether the file is a machine language or BASIC program, or an EXEC file.

Franklin DOS 2 also supports formatting and using 40-track disks, which provides about 15 percent more storage capacity on a disk than the Apple standard. Several DOS utility programs also provide a menu option, which implies that double-sided disks are supported. However, this isn't mentioned in the documentation, and I'm not sure whether Franklin plans to sell machines with double-sided drives in the future.

The problems with memory allocation that I observed while running the Sieve of Eratosthenes benchmark are apparently not in the DOS but in BASIC itself, since the problems occurred whether I booted with Franklin

DOS 2 or with Apple DOS 3.3 (see page 264 for details). This means, of course, that a ROM update will be needed to correct the problem.

#### SOFTWARE COMPATIBILITY

I was able to successfully boot and run five different Apple operating systems: Apple DOS 3.3, ProDOS, Pascal, and two versions of CP/M. In addition, I tested some Apple games on the ACE 2200. Many of these are copy-protected, which usually involves some kind of nonstandard disk interface. In every case, I found that a disk that would boot on my Apple II+ would also boot satisfactorily on the ACE 2200.

I had one failure running a commercial program, however. Spinnaker's Snooper Troops booted properly, but crashed early with an "Out of Memory" error message. This seems to be an example of a program that needs all the memory an Apple can provide.

The ACE 2200 documentation says that Apple Integer BASIC is not supported, but I found that an Apple DOS disk, which loads Integer BASIC into RAM at boot time, worked properly, and some Integer BASIC programs also ran properly. An exception was the public domain TED II+ 6502 editor/assembler program, which is an Integer BASIC program that contains an embedded machine language portion. The program did not list or assemble files correctly.

#### DOCUMENTATION

A 150-page user's reference manual was supplied with the review machine. I found this manual useful and accurate, but I wanted much more detail. Everything I needed to know to set up and configure the ACE 2200 was there, and many of the machine's advanced features were covered. However, there were major gaps, including the complete lack of mention of the machine language monitor commands. No mention is made of how to configure the programmable function keys to work under CP/M. It is an exaggeration to call this book a reference manual.

The manual does suggest that Apple reference manuals should be consulted for additional information.

This is valid advice, but it raises some questions about what one should expect from a manufacturer.

The user's reference manual refers to a companion technical reference manual, but the latter was not supplied with my machine. Even though every user may not need the technical details that such a manual would contain, most users will end up with some problems that they need to ask an expert about. My experience has been that when technical information is not part of the package that the purchaser receives, it is often not available to the dealers or service people either.

**CONCLUSIONS**

Although there is a definable niche for the Franklin ACE 2200 between Apple's IIc and IIe, it is a narrow one. Even though the IIc is not supposed to be expandable, additional memory and Z80 coprocessors are available as piggyback boards that plug into an existing chip socket on the main circuit board. Experienced users will surely advise those who are attracted by the ACE 2200's cost advantages over the Apple IIe that two expansion slots may not be adequate.

The Franklin ACE 2200 does have some appeal. Physically, it is a nice package. I like the detachable keyboard and the single cabinet with integrated disk drives. Franklin's DOS is a significant improvement over Apple's painfully slow DOS 3.3 for reading and writing text files. Standard operating systems, such as Apple's ProDOS and Pascal and (with a coprocessor) Digital Research's CP/M, are all usable as well.

On balance, however, I don't think I would buy an ACE 2200 for myself. Problems that could affect every user are burned into ROM—the flawed Franklin BASIC cannot be replaced simply by booting a different disk. I also find the Franklin Monitor program inadequate. In addition, I found that the RAM disk that I use to increase the performance of my Apple would not work in the ACE 2200. Users who could carefully define their software and hardware needs might find a combination including the ACE 2200 and selected peripherals suitable for their work, however. ■

Attention all FX80, FX100, JX, RX, & MX owners:  
**You already own half of  
a great printer**

**Now  
Only  
\$79.95**



Dealer  
inquiries  
welcome.

Now for \$79.95 you can own the rest. You see, today's new dot matrix printers offer a lot more.

Like an NLQ mode that makes their letters print almost as sharp as a daisy wheel. And font switching at the touch of a button in over 160 styles. But now, a Dots-Perfect

upgrade kit will make your printer work like the new models in minutes— at a fraction of their cost.

And FX, JX and MX models will print the IBM character set, too.

So, call now and use your Visa, MasterCard, or AmerEx. Don't replace your printer, upgrade it!

**1-800-368-7737**  
In California: 1-800-831-9772



**Dots-Perfect**  
Dresselhaus

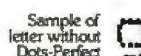

837 E. Alosta Ave., Glendora, CA 91740 Tel: (818) 914-5831  
An upgrade kit for EPSON FX, JX, RX, & MX printers

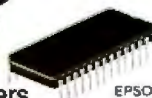

EPSON is a trademark of EPSON America, Inc

**POWERFUL INCIRCUIT EMULATION,  
Priced Within Your Budget. THAT'S NICE!™**

**Get 95% of what you get from the Big Guys,  
For 10% of the cost.**

You get full-speed, real-time execution. Operates up to 10 MHz with 16 hardware breakpoints, 8K bytes of overlay RAM, histogramming and up and down loading of S-record files.

Designed for system development, troubleshooting, debugging or testing in the lab, field, or at home, NICE 68000 simply plugs into the target μP socket and any RS-232 terminal or terminal emulator.

Send check, money order, or VISA/MASTERCARD to NICE, 215 Fourier Ave, Fremont, CA 94539; CODs accepted.

At \$1795.00\* NICE 68000 offers the best emulator price/performance.



For information, call 800-NICOLET\* (800 642-6538) or 415 490-8300 (in California).

**NICE Nicolet**

\*Other NICE emulators are available for the Z80, 8088, 8085 and NSC800 starting at \$550.00.

NICE is a trademark of Nicolet. Z80 is a trademark of Zilog, Inc.

# SYNCmodem<sup>TM</sup> is your SNA or BSC Gateway

## Features:

- PC/XT/AT bus compatible
- Auto-dial/auto-answer
- Tone or pulse dial
- Supports Bisync or SDLC links

## 3 Models:

- 201  
(2400 baud)
- 212AT/201  
(1200 and 2400 baud)
- 208  
(4800 baud)

## Description:

SYNCmodem is an IBM PC, XT or AT bus compatible interface card capable of operating as a synchronous modem or as a synchronous interface card.

SYNCmodem is ideal for remote PC-to-mainframe or PC-to-PC communications. It comes fully integrated with 3780Plus<sup>TM</sup>, CLEO-3270 SNA or BSC, and CLEO-5250 SNA software packages.

3780Plus allows fast and efficient file transfers, over common phone lines, between your PC and any micro, mini, or mainframe that supports 2780/3780 Bisync protocol.

CLEO-3270 SNA or BSC and CLEO-5250 SNA allow your PC to emulate a remote 327x or 525x terminal device. All you need is a phone line.

The 212/201 modem includes the Mirror asynchronous software package in addition to your selected CLEO SNA or BSC package.

For details call 1(800)233-CLEO.  
In Illinois 1(815)397-8110.

**CLEO** 

CLEO Software  
a division of Phone 1, Inc.  
1639 North Alpine Road  
Rockford, IL 61107  
TELEX 703639

CLEO is a registered trademark of CLEO Software.  
SYNCmodem and 3780Plus are trademarks of CLEO Software.

Inquiry 66







# THE LEADING EDGE MODEL D PC

BY STAN MIASTKOWSKI

*An inexpensive, well-built  
IBM PC clone with a long list  
of standard features*



The Leading Edge Model D PC is the closest thing to a "plug in and run" IBM PC clone that I have seen. Standard features include a monochrome (amber or green) monitor, two 5¼-inch floppy disk drives, 256K bytes of RAM, serial and parallel ports, monochrome and RGB display adapters, and a clock/calendar. The basic Model D retails for \$1495 and comes with an impressive 15-month warranty. A printer is the only addition you will need to make the Model D into a complete system, although you can also add a RAM upgrade to 640K bytes, an 8087 arithmetic coprocessor, and a 20-mega-byte hard disk drive. You can also purchase the Model D with a 14-inch 640- by 200-pixel RGB monitor in place of the monochrome monitor.

The Model D has many useful features. The system unit and the monitor both come with extra-long (10-foot) AC power cables. The power supply's fan is extremely quiet. The power and reset switches are on the front of the system unit, and the monitor's power, brightness, and contrast controls are on the front of the monitor. The system unit even has a depression in which the monitor sits comfortably.

## INSIDE THE SYSTEM UNIT

Despite the small footprint of the Model D (a full five inches narrower than the IBM PC), you still have plenty of room for expansion, because the

parallel and serial ports and display adapters are built into the motherboard. The Model D power supply is rated at 130 watts, which is enough power for the system and most additional boards. There are four full-length expansion slots available, enough for most environments. As you might expect in a system this compact, the components on the motherboard are closely packed.

The system unit cover slides forward off the machine after you remove five screws. The motherboard, which contains all memory and circuitry for ports, completely covers the bottom of the case. The disk drives and power supply sit on a shelf mounted above

the board. To gain access to the entire motherboard, you must unplug the disk drive cables and power supply connectors, remove four screws from the front of the shelf and five from the back, and then lift out the power supply and disk drive assembly. The entire process takes about three minutes. The only potential problem is that you must keep track of three differently sized screws.

The position of the 4.77-MHz 8088 processor (in the middle of the motherboard just in front of the four expansion slot connectors) made it impossible for me to use an 80286 expansion card. The connector that replaces the 8088 just wouldn't reach, no matter which slot I used. The motherboard also has an empty ROM socket next to the BIOS ROM. You can install up to 32K bytes of ROM.

In addition to a 6-pin connector for a light pen, there are several configuration jumpers on the motherboard. They enable and disable the monitor controller, set the interrupt level of the clock, enable and disable the I/O controllers, and set the installed RAM and ROM size.

The standard 256K bytes of RAM comes on easily accessible memory chips on the front of the mother-

*(continued)*

Stan Miastkowski (P.O. Box 548, Peterborough, NH 03458) is a freelance writer, northeast bureau chief for Newsbytes, and editor in chief of the McGraw-Hill Micro-computer Handbook.

## Leading Edge Model D PC

### Company

Leading Edge Hardware Products Inc.  
225 Turnpike St.  
Canton, MA 02021  
(800) 343-6833

### Size

5½ by 14 by 15½ inches; 43 pounds

### Components

**Processor:** 4.77-MHz 8088

**Memory:** 256K bytes, expandable to 640K bytes

**Mass storage:** Two double-sided 360K-byte 5¼-inch floppy disk drives

**Display:** 12-inch green- or amber-phosphor monochrome display standard; dual-mode display adapter

**Keyboard:** IBM PC compatible; 83-key layout

**Expansion:** Four 62-pin, full-length IBM PC-compatible slots

**I/O interfaces:** Parallel printer; RS-232C; clock/calendar

### Software

MS-DOS 3.1; GW-BASIC; diagnostics disk; demonstration disk; Leading Edge word processor

### Options

20-megabyte hard disk drive; 14-inch RGB monitor; 384K-byte memory upgrade; 8087 numeric coprocessor

### Documentation

Operator's guide  
Guide to MS-DOS  
Guide to GW-BASIC

### Price

Basic configuration: \$1495  
With RGB color monitor: \$1895  
With 20-megabyte hard disk and monochrome monitor: \$1895  
With 20-megabyte hard disk and RGB color monitor: \$2295

## SYSTEM FEATURES

MEMORY SIZE (K BYTES)

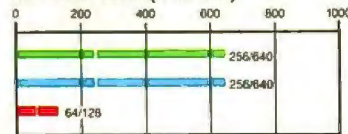

DISK STORAGE (K BYTES)

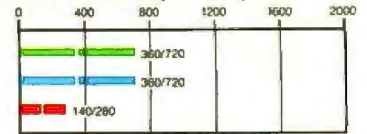

DISK ACCESS IN BASIC (IN SECONDS)

WRITE



READ



BASIC PERFORMANCE (IN SECONDS)

SIEVE

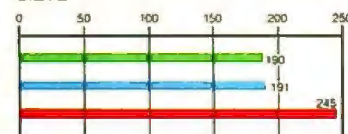

CALCULATIONS

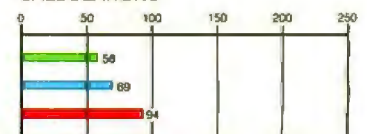

SYSTEM UTILITIES (IN SECONDS)

40K FORMAT/DISK COPY

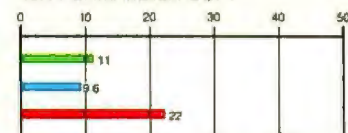

40K FILE COPY



SPREADSHEET (IN SECONDS)

LOAD



RECALCULATE

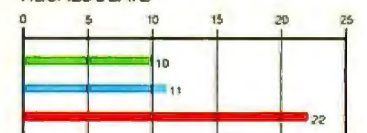

■ LEADING EDGE PC (MODEL D) ■ IBM PC ■ APPLE IIe

The Memory Size graph shows the standard and optional memory available for the computers under comparison. The Disk Storage graph shows the highest capacity for a single floppy disk drive and the maximum standard capacity for each system. The graphs for Disk Access in BASIC show how long it takes to write and then read a 64K-byte sequential text file to a blank floppy disk. (For the program listings, see BYTE's *Inside the IBM PCs*, Fall 1985, page 195.) The Sieve graph shows how long it takes to run one iteration of the

Sieve of Eratosthenes prime-number benchmark. The Calculations graph shows how long it takes to do 10,000 multiplication and 10,000 division operations using single-precision numbers. The System Utilities graphs show how long it takes to format and copy a 40K-byte file using the system utilities. The Spreadsheet graphs show how long it takes to load and recalculate a 25- by 25-cell spreadsheet in which each cell equals 1.001 times the cell to its left. The spreadsheet used was Microsoft's Multiplan.

# We Put More Printers In Business Than Anyone Else.

## High Resolution 24-Pin Printer Sales, 1982-1985



Sales of 24-pin dot matrix printers have increased substantially over the past several years. Dot matrix printers account for over 60 per cent of the total printer industry sales. TOSHIBA has the largest percentage of all the industry's 24 pin print head printer sales.

There are more Toshiba 24-pin dot matrix printers installed in major corporations, as well as in medium and small companies, than any other brand.<sup>1</sup>

More than Epson.<sup>2</sup> More than NEC.<sup>3</sup> More than Brother.<sup>4</sup> More than Fujitsu.<sup>5</sup> That's because Toshiba gives you more.

Our P351's printhead, for instance, lasts up to two times longer than anyone else's.



The P351



The P351C

In Touch with Tomorrow

# TOSHIBA

Toshiba America, Inc., Information Systems Division

And during its long life it will give you letter quality printing at 100 CPS, drafts at 288 CPS and picture-perfect dot-addressable graphics.

The P351 emulates Qume Sprint 11<sup>5</sup> and IBM Graphics<sup>6</sup>, and most major software packages utilize its expanded command set. Plus, you can add over 40 downloadable type fonts on both disks and plug-in cartridges.

The P351 is compatible with the IBM PC<sup>7</sup> family and goes about doing its job in the quietest manner possible.

If you need color graphics capability, there's the new P351C. The 24-pin printhead we pioneered and perfected produces high-resolution presentation graphics on paper for reports and on transparencies for projection.

The P351C will also create multicolor transparencies for all software compatible with the IBM Color Printer<sup>8</sup> and can output graphics from Microsoft Chart.<sup>9</sup>

So when it comes time to select a printer for your office, why not consider the Toshiba P351 or the new P351C. They're both good for business.

For the name of the Toshiba dealer nearest you, call 1-800-457-7777.

\*Installed base figures from Dataquest. 1. Epson is a registered trademark of Epson Corporation. 2. NEC is a registered trademark of Nippon Electric Corporation. 3. Brother is a registered trademark of Brother International Corporation. 4. Fujitsu is a registered trademark of Fujitsu America, Inc. 5. Qume 11 is a registered trademark of Qume Corporation. 6, 7, 8. IBM Graphics, IBM PC and IBM Color Printer are registered trademarks of International Business Machines Corporation. 9. Microsoft Chart is a registered trademark of Microsoft Corporation.

board. There are four rows of 64K-bit chips, two rows of which are in sockets. To upgrade the system to 640K bytes, you need only remove the 64K-bit chips from the sockets, replace them with 256K-bit RAM chips, and change a jumper. The operator's guide includes complete and clear instructions for the change.

### DISPLAY OPTIONS

The connectors for the monochrome monitor, color monitor, RS-232C serial port, and parallel ports are clearly marked on the rear panel of the Model D. Between the monochrome and color jacks is a single-throw switch used to select either port, eliminating setup problems. You can circumvent the switch in software by using the familiar MODE command or the Model D MS-DOS's COLOR or MONO commands.

The monochrome adapter is Hercules-compatible; you can therefore display graphics on the monitor in varying shades of green or amber. Resolution is 720 by 348 pixels. The display has a nonglare surface and can tilt up and down. Both text and graphics characters are crisp and of high quality.

### DISK DRIVES

The standard Model D comes with two double-sided 360K-byte 5¼-inch floppy disk drives, mounted one over the other. A mechanical switch on the front of each drive locks the drive

door closed after you insert a disk. The switches are not absolutely necessary, especially since you don't have to throw the switches to use the drives, but they do keep a disk from being inadvertently removed at an inopportune time.

The optional 20-megabyte hard disk drive replaces the 10-megabyte drive available with early model Ds, with no additional cost for the extra 10 megabytes. This drive replaces the second floppy disk drive. The hard disk controller uses one of the four expansion slots. If you want a hard disk but also want to keep your second floppy disk drive, you might consider one of the increasingly popular hard-disk-on-expansion-card systems.

### KEYBOARD

The 83-key QWERTY keyboard has an IBM Selectric layout with large Return and Shift keys (see photo 1). The keyboard feel is excellent, better than many of the more expensive keyboards. However, there are no sounds when you hit a key. The keyboard itself weighs enough to keep it firmly planted on the typing surface, and it comes with a 6-foot coiled cord.

### SOFTWARE

The Model D comes with MS-DOS 3.1, GW-BASIC, a demonstration disk, a diagnostics disk, and the Leading Edge word processor.

The demonstration disk is an adjunct to the operator's manual and

uses the monochrome card's graphics to walk beginners through the features and capabilities of the Model D.

The diagnostics disk has twelve standard tests that you can run individually or all together. The tests are well designed and include copious status messages that tell you how long the tests will take and how they are progressing.

To test compatibility, I ran a number of commonly used applications, including WordStar, MultiMate, PFS:Access, and a few games. I experienced no difficulties. To test the Model D's hardware compatibility, I used a modem board and an extended graphics adapter, and I replaced the floppy disk controller. Everything worked flawlessly. When I needed to change jumpers, the instructions in the operator's manual were easy to understand.

### DOCUMENTATION

Three manuals come with the Model D: an operator's guide, a guide to MS-DOS, and a guide to GW-BASIC.

Although the 110-page operator's guide isn't expensively produced, it's one of the best introductory texts I've seen. The manual gives excellent instructions on setting up and getting started. There's a substantial section on possible problems and their cures, as well as a short introduction to MS-DOS and subdirectories. The book finishes up with clear, well-illustrated instructions on installing additional memory and a hard disk. The other manuals are also of high quality.

Although there is no technical manual for the Model D, more detailed information is easy to obtain. There is a toll-free support number, and the technical support people are knowledgeable and helpful.

### SUMMARY

The Leading Edge Model D PC is a thoughtfully designed and well-built IBM PC clone. Its long list of standard features makes it stand out from the pack. The lack of a higher processor speed (see page 270) is perhaps its greatest shortcoming. However, at nearly half the cost of a comparably equipped IBM PC, the Model D is a superb value. ■

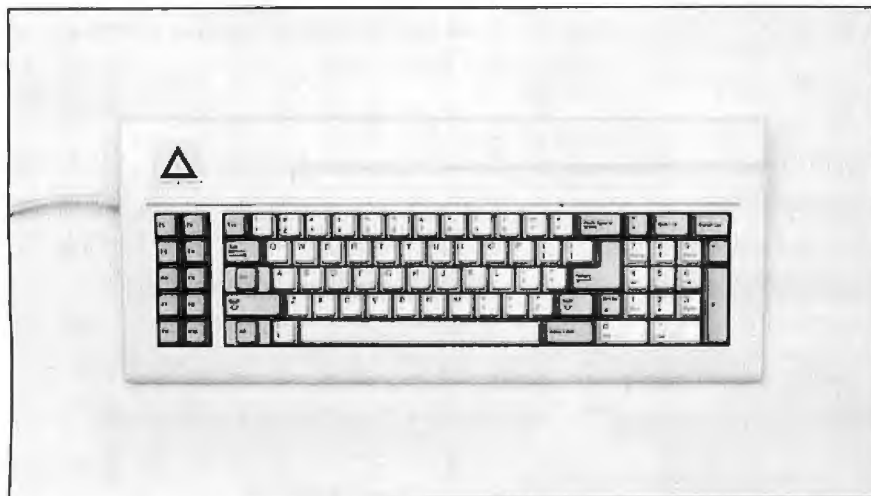

Photo 1: The Model D's 83-key QWERTY keyboard.

# ANYONE CAN BUILD A CLONE, BUT... ONLY PANASONIC® GIVES YOU A BUSINESS PARTNER.™

Introducing the desktop computers that can make your life easier:  
the Panasonic Business Partner and Panasonic Business Partner 286.  
Call 1-800-PIC-8086 for the dealer nearest you.  
You'll agree: **THE EASIER, THE BETTER.**



**Panasonic**  
Office Automation 

# For \$295 you can draw your own conclusions.

**Drafix 1. The first high performance CAD software everyone can afford.**

Low-cost, high performance computer-aided design & drafting (CAD) software is finally available for use on your PC.

There's never been a professional CAD package so complete at such a low cost.

Drafix 1 from Foresight Resources. Only \$295.

**Powerful, full-featured second generation CAD software.**

Drafix 1 offers all of the capabilities you expect to find in packages costing \$2,000 or more.

This is not simply a souped-up paint package. Drafix 1 is a breakthrough in design that organizes sophisticated CAD functions into smooth, fast operations. All of the drawing, designing and editing functions that designers demand from a serious CAD tool are included in Drafix 1.

**A breakthrough in screen design and visual user interface.**

Drafix 1 features the best organized screen design ever devised. Very simply, it displays all the information you need, all of the time.

The entire menu hierarchy is displayed constantly. There's no need to memorize commands or search for menus.

Snap-mode options are continually shown on the left screen border and can be selected "on the fly" by either pointer device or a single keystroke. Roll-down screens provide quick access to the virtually unlimited drawing, display and editing options.

And it's all controlled by a versatile three-button mouse, or digitizer, with on-screen prompts so each button function is clearly defined.

**AutoCAD<sup>®</sup> compatible for easy expansion.**

If you or someone in your company already uses AutoCAD, Drafix 1 offers an inexpensive way to add to your capability.

The optional Drafix 1/AutoCAD file exchange utility permits transfer of drawings between Drafix 1 and AutoCAD.

It's the perfect, low-cost alternative for increasing your drafting and design capacity.

**Unbelievable low bundle prices.**

To get you up and running we offer two special hardware bundles — all the equipment you need at prices you won't believe.

Get Drafix 1 with your choice of Torrington's Manager Mouse or the LOGIMOUSE<sup>™</sup> C7 for just \$395.00.

Or get Drafix 1 with the SummaSketch 12" x 12" digitizer tablet with stylus for just \$650.00.

**Order today. Take advantage of our 30-day, money back guarantee.**

We're so certain you'll like the performance and versatility of Drafix 1 you're welcome to try it risk free for 30 days. If you're not completely satisfied, return it to us for a full refund.

Find out just how good CAD software can be. For only \$295.00.

Use our toll-free number and any major credit card to order your copy of Drafix 1 today.

## SPECIFICATIONS

### Code specifications

Language: C  
File graphics  
Flamingo font database  
Capacitor support  
PC DOS/MS-DOS 2.1 or later

### Drafix 1 Features

Name  
Units  
PI markers  
Arcs & circles  
Node text  
Polygons & ellipses  
Symmetrical & nested

### Item attributes

16 per color  
255 Layers  
8 Linetypes  
12 font fonts  
32 PI marker types

### Screen Display

Zoom/Plot/Full  
8 View views  
Slide navigation  
Grids/offset

### Metric & English Standards

Engineering/International/Architectural (SI) etc

### Project drawing info

Automatic input  
Keyboard and cursor  
Absolute/Relative/Point

### Snap Modes

Endpoint  
Midpoint  
Intersection  
On/Off  
Quadrant  
Tangent  
Arc center

### Transfer/Copy

Layer  
Rotate  
Scale  
Mirror  
Join

### Modify/Edit

Attributes  
Break/Join  
Erase/Undo  
Trim  
Stretch  
Erase  
Explode symbols & polylines

### Auto hatching

polyline/hatch

### Auto Dimensioned

Linear/Algebraic/Aligned  
Angular  
Diameter  
Leader Notes  
Ordinate

### Draw & Restore

Check/Isolate/Unfreeze  
Copy/Paste  
Distance & angle  
Area & perimeter

### Item Wasting

Hardware  
Computers  
IBM PC XT AT and compatibles  
Real 8000 Plus  
System Requirements  
— 512K RAM  
— 80-232 Comm port  
— Mouse or digitizer  
— Capacitor recommended

### Drafix 1 Display Boards

IBM CGA EGA and compatibles  
 Hercules, and a wide range of graphics boards

### Printers & Plotters

IBM printer/plotter devices supported

### Plotters

All popular printers & C-dot  
— supported  
— 1 inch graphics option available

### Protocols

All popular local and net protocols  
— supported



Order Now! Call Toll-Free!

**1-800-231-8574**  
Ext. 150

- Drafix 1 CAD Package \$295
- Drafix 1 with Mouse \$395
- Torrington LOGIMOUSE \_\_\_\_\_
- Drafix 1 with SummaSketch tablet \$650
- AutoCAD File Exchange Utility \$ 95

Dealer inquiries welcome

Check, money order, Visa and MasterCard accepted

**FORESIGHT**  
RESOURCES CORP.<sup>™</sup>

932 Massachusetts  
Lawrence, KS 66044  
913/841-1121

AutoCAD is a trademark of Autodesk, Inc.  
IBM PC/XT/AT are trademarks of the IBM Corp.  
SummaSketch is a trademark of SummaGraphics, Inc.  
Manager Mouse is a trademark of Torrington Company.

Inquiry 128



# THE XEROX 6060

BY WAYNE RASH JR.

The Xerox 6060, which is virtually identical to the AT&T PC 6300 (see the review by Bob Troiano in the December 1985 BYTE), provides quiet, unobtrusive, and very fast operation. The machine is based on an Intel 8086 microprocessor running at 8 MHz. The 8086 uses a 16-bit data path, allowing faster operation than the 8-bit data path in the IBM PC. For some applications, the Xerox 6060 is nearly three times as fast as the IBM PC. The 6060's main problem is its very costly support.

Besides the exterior color, the biggest difference between the 6060 and the AT&T PC 6300 is the monitor. Like other Xerox computers, the 6060's monochrome screen is black and white. Green and amber apparently are not available. There is also a noticeable difference in the software supplied with the Xerox 6060. Along with MS-DOS, you get a menu-oriented user interface that performs most MS-DOS functions.

## THE SYSTEM UNIT

The Xerox 6060 system unit is about two-thirds the size of the IBM PC. My review unit contained a half-height 10-megabyte hard disk drive and a 360K-byte floppy disk drive. Both drives are very quiet. My floppy disk drive had a strong ejection spring. In many cases it ejected the floppy disk to the keyboard and sometimes to the floor.

A pilot light and a reset switch are directly beneath the disk drives. If you have one of those programs that turns your screen off after a few minutes, it's nice to be able to tell at a glance

## *A fast-running machine with an Intel 8086 microprocessor and a 16-bit data path*



whether the machine is really off or if the screen is just blank.

The rear of the Xerox 6060 contains the power switch, the communications ports, the keyboard connector, and the monitor connector. The housing for the cooling fan protrudes slightly over the main unit. The parallel and serial connectors are next to each other near the bottom. Both connectors are DB-25s. The monitor connects to a third DB-25 located on the rear of an expansion board. Four screws allow you to remove both the top and bottom of the machine.

Like the AT&T PC 6300, the Xerox 6060 has its motherboard beneath the bottom panel. You must remove the bottom of the computer to change switch settings or to add a math coprocessor. As unlikely as it

seems, this is more convenient than the access to the inside of many other machines. Once the bottom is off, you have clear, unobstructed access to the entire motherboard. Most of the circuitry is soldered in place rather than socketed, so you won't be able to do much with the motherboard other than change the switch settings.

The backplane contains seven expansion slots that will accept most IBM PC-compatible expansion boards. Two slots also have an additional connector that allows use of the full 16-bit data path from the 8086 microprocessor. The additional connectors are arranged and located differently from those on the IBM PC AT, eliminating any chance of using PC AT expansion cards in the 6060.

The disk controller and an optional memory-expansion card each take one of the seven slots. At the far left edge of the case is the graphics card, into which the monitor is plugged.

## THE KEYBOARD

The Xerox 6060 keyboard is identical to that of the AT&T PC 6300. The rear of the keyboard can be raised and lowered to three different angles. The keys are arranged like those on the IBM PC, although the Caps Lock and Num Lock keys have LEDs to indicate when they are active. The touch of the

(continued)

Wayne Rash Jr. is a member of the professional staff of American Management Systems Inc. (1777 North Kent St., Arlington, VA 22209), where he consults with the federal government on microcomputers.

## *Xerox has extensively modified some MS-DOS system utilities.*

keys is quite light. At the rear of the keyboard is a connector for the mouse.

### THE MOUSE

The two-button optical mouse works with Screenmate, the MS-DOS shell (see description below). The left button indicates a selection; the right button confirms acceptance. You slide the mouse on a piece of gray cardboard that comes supplied with it. An optical sensor on the mouse's underside determines direction using the dots created by the cardboard's half-tone. The mouse is very sensitive to movement, and I obtained better results by using *Washington Post* want ads instead of the gray cardboard.

### THE MONITOR

I found the screen of the Xerox 6060, which is black with white letters, tiring to use for long periods. I talked to people who had used this screen all day, and they complained of headaches. I would recommend that you consider buying the color monitor from Xerox or the monochrome monitor and card from AT&T.

Because the monitor receives its power through the same DB-25 connector that provides the video signal, you will probably have difficulty using a third-party monitor. The characters are not the same as the IBM character set, but they do not seem as strikingly clear as those used by AT&T. A monitor stand allows you to tilt and swivel the screen.

### USING THE XEROX 6060

The complete installation process for the hard disk-equipped review machine took about 20 minutes. It takes almost no training to start and run the computer. I was able to use the system before I looked at the documentation. When you turn on the system, it performs a number of self-diagnostic tests and reports on their out-

come. The Xerox logo then appears for a few seconds, followed by the Screenmate main menu. You can use function keys or the mouse to control the menu functions.

The Xerox 6060 is so fast that you may change some of the ways you use your software. For example, you may want to slow down Framework menus so you won't miss the animation of the windows.

I used all my IBM PC application software in the 6060 without incident, although many programs ran faster than they do on other machines. In some cases there are special installation programs for the AT&T PC 6300. If this is the case, use these special programs, since the PC 6300 is essentially identical to the 6060.

Despite software compatibility, the Xerox 6060 is not totally compatible with the IBM PC. Since the 6060 has a 16-bit data path, it requires special memory-expansion boards. Thus, third-party memory and multifunction boards may not run properly, or they may not have the use of all their functions. A Tall Tree JRAM-2 board, for example, functions properly except that it does not recognize the extra memory, and the memory-related software for the board will not function.

### THE SCREENMATE SHELL

With MS-DOS, Xerox includes Screenmate (which is called XMATE on the disk), a command-processing shell that provides all the functions from a menu. The Screenmate menu will respond to input from the keyboard or from the mouse.

Nearly any MS-DOS command or program can be run from within Screenmate, but at times, such as when copying files, it is more difficult than simply typing the command at the command level. The only way that I was able to copy files while using Screenmate was to copy one file at a time. I was also unable to set the system clock from within Screenmate, despite following the directions exactly.

Xerox has modified a few of the MS-DOS system utilities extensively. The MODE command, for example, refers you to the Xerox program Configur,

which allows you to set up the communications ports by using a menu. You can even convert from codes designed for one type of printer to those of another. While you gain some additional functions, you lose the control that the original commands give you. I think it would have been preferable to retain the utilities in their original form so that advanced users would have access to them.

Eliminated are two MS-DOS commands: the ASSIGN command, which lets you reassign disk drives, and the GRAPHICS command, which lets you print graphics screens using the Prt Sc key. This last function is replaced to some extent by the Xerox device drivers, which translate a program's codes to those of another printer.

Whatever the trade-offs from the changes to the system utilities may be, one definitely useful change is Xerox's on-line help files. Most of the programs Xerox modified will let you get more information about the command by pressing a key for help.

### DOCUMENTATION

Xerox has rewritten the standard MS-DOS documentation. The result is a set of manuals that should be understandable to most beginners but is insufficient for more advanced users.

The Screenmate manual serves more as a tutorial than as a reference manual. The manual has an index, but it is limited to a cross-reference of Screenmate operations. Less-used operations, such as partitioning the hard disk, are in the appendixes.

The Screenmate manual is well written, and all operations are clearly explained. New users should have no trouble following its procedures.

Like the Screenmate manual, the MS-DOS manual presents explanations in the form of a tutorial, a small disadvantage when you only need to locate a discussion on a single command. Of course, the use of menus to control operations lessens the need to understand command syntax. The index of the MS-DOS manual is somewhat more complete.

The hardware and setup manual is excellent. It explains each step clearly and completely with fine illustra-

(continued)



**Xerox 6060**

**Company**

Xerox Corporation  
1301 Ridgeview Dr.  
Lewisville, TX 75067  
(214) 420-7200

**Size**

15 by 15½ by 15¼ inches

**Components**

**Processor:** Intel 8086

**Memory:** 256K bytes, expandable to 640K bytes

**Mass storage:** Two half-height 360K-byte 5¼-inch floppy disk drives, or one floppy disk drive and a 10-megabyte hard disk drive

**Display:** 12-inch white phosphor, 80 characters by 25 lines; color is optional

**Keyboard:** 83 keys, 10 function keys; indicator lights on Caps Lock and Num Lock keys

**Expansion:** Seven slots, two of which are 16-bit

**I/O interfaces:** One serial and one parallel port

**Software**

MS-DOS 2.11; Screenmate shell (XMATE)

**Documentation**

MS-DOS manual, Screenmate manual, hardware and setup manual

**Price**

Basic system with two floppy disk drives and 256K bytes of memory: \$2605

Basic system with one floppy disk drive, a 10-megabyte hard disk drive, and 256K bytes of memory: \$2810

Basic system with one floppy disk drive, a 20-megabyte hard disk drive, and 512K bytes of memory: \$3505

**SYSTEM FEATURES**

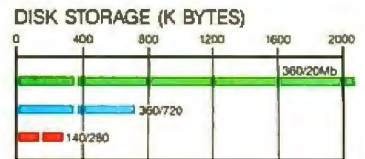
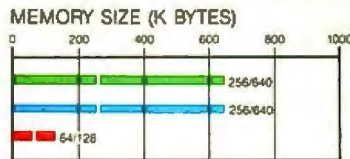

**DISK ACCESS IN BASIC (IN SECONDS)**

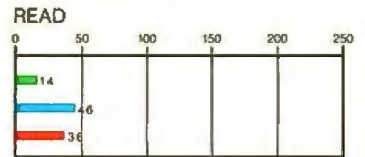
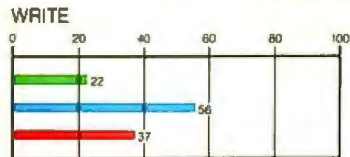

**BASIC PERFORMANCE (IN SECONDS)**

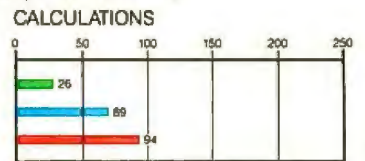
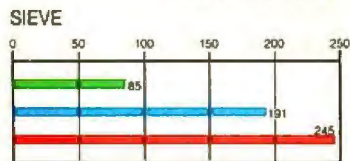

**SYSTEM UTILITIES (IN SECONDS)**

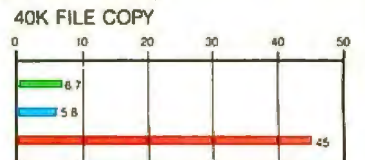
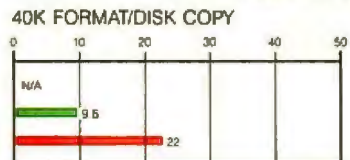

**SPREADSHEET (IN SECONDS)**

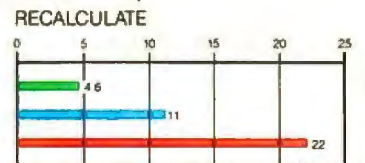

■ XEROX 6060 ■ IBM PC ■ APPLE IIe

The Memory Size graph shows the standard and optional memory available for the computers under comparison. The Disk Storage graph shows the highest capacity for a single floppy disk drive and the maximum standard capacity for each system. The graphs for Disk Access in BASIC show how long it takes to write and then read a 64K-byte sequential text file to a blank floppy disk. (For the program listings, see BYTE's *Inside the IBM PCs*, Fall 1985, page 195.) The Sieve graph shows how long it takes to run one iteration of the Sieve of Eratosthenes prime-number benchmark. The Calculations

graph shows how long it takes to do 10,000 multiplication and 10,000 division operations using single-precision numbers. The System Utilities graphs show how long it takes to format and copy a 40K-byte file using the system utilities. The Spreadsheet graph shows how long it takes to load and recalculate a 25- by 25-cell spreadsheet in which each cell equals 1.001 times the cell to its left. The spreadsheet used was Microsoft's Multiplan. The Xerox 6060 did not come with a copy of GW-BASIC; the tests were done with AT&T's version of BASIC.

tions. However, I was displeased with the printer installation section, which would have you believe that you can only install a Diablo or Xerox printer, which is not the case.

The hardware manual and both of the software manuals are deficient in one significant area—the proper handling of problems. The user is left entirely at the mercy of a local dealer or Xerox representative.

**SUPPORT**

The main problem with the Xerox 6060 is the cost of repair. A bad floppy disk drive will cost over \$900 to repair, according to one Xerox invoice that I saw. The labor cost \$85, and \$855 was charged for a standard 5¼-inch drive. In another repair job, Xerox charged \$5339 to replace a hard disk and the CPU board.

**BENCHMARKS**

Owing to its full 16-bit processor running at 8 MHz, the Xerox 6060 is very

fast, and in some operations it is almost as fast as the IBM PC AT (see page 277 for details). The hard disk and disk controller, which have their own 8085 processor, are also faster than most of the competition's. Disk accesses from the hard disk seem to be significantly faster than those from an IBM PC XT or compatible.

The most notable improvements in operation involve the tests that measure processing speed. The Calculations and the Sieve of Eratosthenes benchmarks ran on the 6060 in nearly one-third the time that they ran on the IBM PC.

Disk format and disk copy times are significantly slower than those for the IBM PC because Xerox has changed the disk format utility so that it automatically does a verification of the entire disk, whether it's desired or not.

**CONCLUSIONS**

Like the AT&T PC 6300, the Xerox 6060 is a speedy machine. It runs

well, operates with most IBM software, and is generally unobtrusive.

You will have to decide if you like the Screenmate shell, the optical mouse, and the black-and-white screen. Note that you can never get away from Screenmate entirely, since many of the system utilities retain their menu-driven front ends. You may be forced to work your way through several layers of menus when all you really want to do is issue a simple command, such as to change the data rate on the serial port. It's just too bad that Xerox eliminated some of the standard system utilities from MS-DOS.

Overall, I was pleased with the capability and speed of the Xerox 6060. It takes the needs of the infrequent or unskilled user into account, and it serves this type of user better than nearly any other machine. The biggest question mark is service, and you should consider this before buying the system. ■

**Program with PANACHE**  
MSDOS, PCDOS IBM PC, XT, AT compatibles.

Program generation with power, sophistication, and especially

**Style**



**Form Editor:**

- All Techniques minimize keystrokes.
- Automatic multi-dimensional array recognition.
- Automatic field naming.
- Wordstar™ compatible editor.
- Diagonal cursor movement.
- Pop-Up Windows/Menus.
- Multi-File Clipboard.
- Crash recovery.

**Writes Programs in "C"**

Order Toll Free  
**1-800-624-8711**  
In SC call  
1-803-278-3811

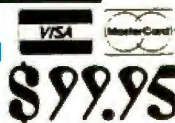

UNIX is a trademark of AT&T Bell Laboratories.  
Wordstar is a trademark of Micropro Int'l Corp.

**Program Generator:**

- Writes "C" Code.
- Does not generate reams of case statements like other similar products.
- Generated code is ultra-efficient.
- Supports all standard data types and user-defined types.
- Custom code independence - Code that you add is isolated from other changes.
- Files feature B+ Tree index support.
- Partitioned screens support scrolling, flat, and cyclic forms, and Pop-Up menus.

Generated programs use supplied library routines and can use your favorite commercial libraries as well.  
**Fitting solutions to digital problems...**

**Library Packages:**

- "C" source for all routines.
- B+ Tree Manager features:
  - Optimized fan-out for each key type.
  - Secondary key GETNEXT support.
  - User-defined ordering for keys.
- Open File Cache places no limit on the number of files open at a time.
- Disk-Based Garbage Collector handles variable length records and multiple indexes per file.
- Window/Menu manager is call-compatible with UNIX™ curses package.
- Generic list processor.

**Digitit Inc.**

105 Clearwater Rd.  
Belvedere, SC 29841

# EVERYTHING SYMPHONY WAS SUPPOSED TO BE.

**AVAILABLE NOW  
ONLY \$84.95  
WITH A 60-DAY  
MONEY BACK  
GUARANTEE**

In One Totally Integrated Package:

- Word Processing With Spell Checker
- Communications
- Spreadsheet
- Database
- Graphs

- Extremely easy to learn and use
- Data is interchangeable with all modules and other products
- Windows allow quick movement between tasks
- Four background, one foreground mode. Can print on two printers or plotters and two communication devices (modem and main-frame direct connection) all at the same time.
- Artificial Intelligence features reduce the number of keystrokes required to perform tasks
- Upgradable software and data to UNIX and XENIX

- **Package contains:** one plastic box, one illustrated reference manual, one program disk, one sample diskette, keycaps and user support plan
- **System Requirements:** IBM PC or compatibles, 512K, two 360K diskette drives, color or mono display
- Twenty-four hour Hotline Support (optional)



Multiple windows allow quick movement between tasks.

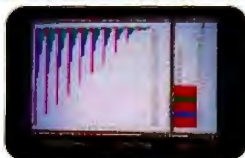

Colorful graphic representations

**What the experts say:**

"I can safely say that I have yet to come across a package which demonstrates such functionality combined with such an innovative approach to the man-machine interface. ABLE are to be congratulated on producing a product which achieves a very high standard of excellence."

—Michael D. Bove, DATA GENERAL

"The best multi-purpose product I have evaluated. Multi-tasking works great, able to print, make an on-line connection and edit a document at the same time."

—Robert Lawrence, ITT INFORMATION SYSTEMS

**A B L E**

*International*

ABLE Int'l is a longtime, innovative supplier of software for micro and minicomputers.  
301 North Main Street  
Pueblo, Colorado 81003 USA  
Telephone 303-544-9600. Telex 650-2154286

## ABLE *One*

To order, call 1-800-826-1907.  
In Colorado call 1-800-826-4784.  
Order 24 hrs. a day

**60-Day Money Back Guarantee\***  
These prices include shipping to all U.S. cities. All foreign orders add \$10 per product ordered.

Not copy-protected \$84.95  
(CO res. add \$5.52 tax per copy)  
Quantity: \_\_\_\_\_ at \$84.95  
Amount: CO res. 6 1/2% tax \_\_\_\_\_  
Payment: VISA MC BankDraft  
Check AmEx Diner's  
Credit Card Exp. Date: \_\_\_\_\_  
Card #: \_\_\_\_\_

Name: \_\_\_\_\_  
Shipping address: \_\_\_\_\_  
City: \_\_\_\_\_  
State: \_\_\_\_\_  
Zip: \_\_\_\_\_  
Telephone: \_\_\_\_\_

COD's and Purchase Orders WILL NOT be accepted by ABLE. Colorado residents add 6 1/2% sales tax. Outside USA add \$10 and make payment by bank draft, payable in US dollars drawn on a US Bank.  
\*If you find that this product does not perform in accordance with our claims and representations, within 60 days of purchase, call our Customer Service Dept. and we will gladly arrange for a refund.

What's missing from this picture?



# Plenty.



While IBM\* offers only one 80286-based personal computer, COMPAQ® offers three. And no matter which COMPAQ Personal Computer you choose, each gives you more.

### Three choices

For example, the COMPAQ DESKPRO 286® has speed, storage and performance that meets or exceeds the IBM desktop. For users who need computing to go, the COMPAQ PORTABLE 286® is the most powerful portable on the market today. And the smaller, lighter, 80286-based COMPAQ PORTABLE II™ combines extraordinary power and value. Both portables are full-function. They all run at 8 MHz. And all reflect the quality, compatibility and expandability COMPAQ is famous for.

### More options

When upgrading, there's room for up to four half-height internal storage devices in our desktop; only three in theirs. Our maximum 70 Megabytes of high-performance fixed disk storage beats their 60. Plus, both COMPAQ 286 Computers offer an internal tape back-up, an option that IBM simply doesn't offer.

### More standard features

IBM does offer a way to connect their desktop computer to a monitor, printer or external modem—but only if you pay extra. COMPAQ *builds in* these extras. Just as we build in shock isolation systems to protect data. We also build in high-resolution text *and* graphics so you need only one monitor, not two. What's more, true compatibility makes COMPAQ Computers ideal for connecting to mainframes, minicomputers or to networks.

### The picture is clear

COMPAQ refuses to compromise. That's why our user satisfaction is highest in the industry. That's why we're the world's second-leading brand of business personal computers. And why COMPAQ rose to FORTUNE 500 status faster than any other company in history.

For a free brochure or the location of your nearest Authorized COMPAQ Computer Dealer, call 1-800-231-0900 and ask for operator 22. In Canada call (416) 449-8741.

IBM\* is a registered trademark and IBM Personal Computer-AT™ is a trademark of International Business Machines Corporation. ©1986 COMPAQ Computer Corporation, all rights reserved.

## COMPAQ®

It simply works better.

# We Dared To Go Beyond RAM.

## FEATURES

### THE CACHE BOARD

Intelligent host adapter interface for hard disk drive.

### COMPATIBILITY

Apple II+, IIe and IIe enhanced systems. Most SCSI hard disk drives.

### KEY FEATURES

**Cache Memory**-replaces mechanical disk access with electronic data transfer.

**Z-80 processor**-Maintains 256K of "most frequently accessed data" in real cache memory. Automatic save function minimizes data loss.

**DMA**-Transfers data faster than RAM. Cuts booting time in half.

### SUPER CHARGE YOUR SIDER

Specific testing with Sider hard drive resulted in not only substantially faster data accessing but also improved performance of the drive itself.

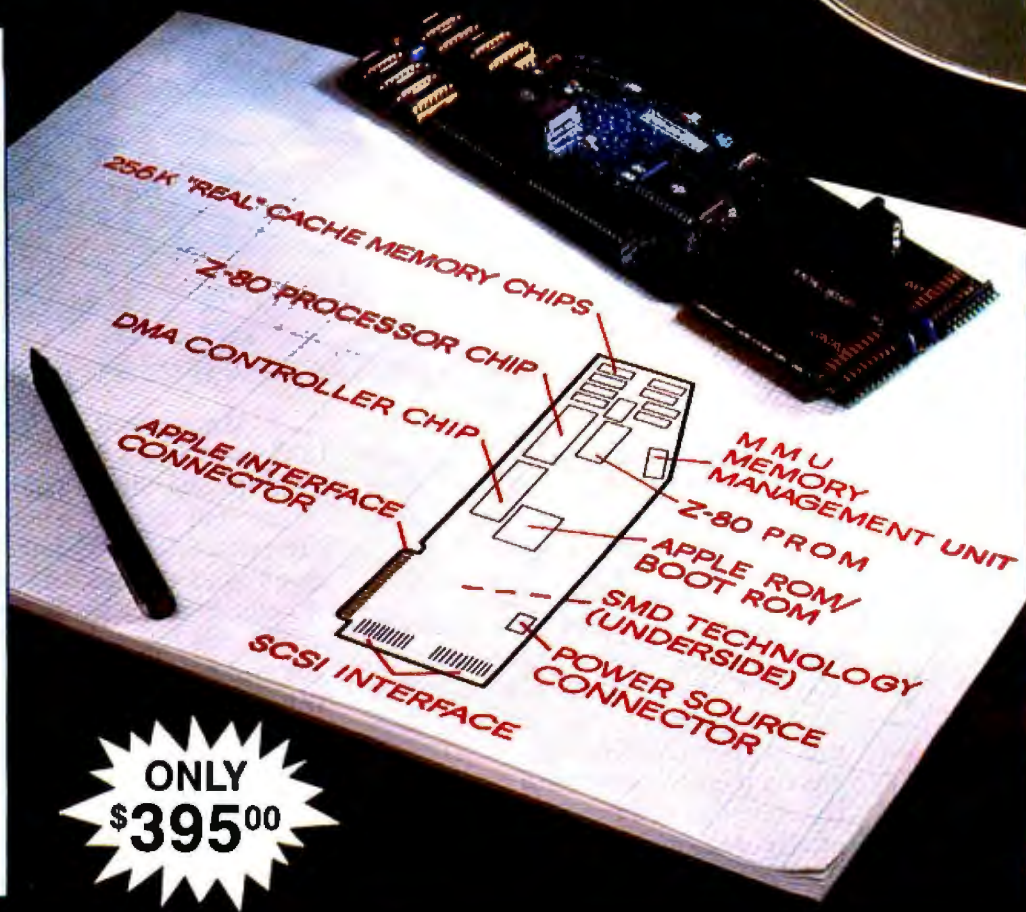

ONLY  
**\$395<sup>00</sup>**

### ATTENTION APPLE II USERS:

The Kache Board is an *intelligent* host adapter interface for hard disk drives.

### KACHE BOARD DEVELOPMENT

It took over two years of research and development, and long hours of testing to make this product a reality. Ohio Kache Systems dared to go beyond RAM to bring hard disk users a new standard in performance — The Kache Board.

### SUPERIOR TO RAM

It's superior to RAM disk, thanks to the use of Cache Memory, Direct Memory Access (DMA), and an on-board microprocessor. When you combine these features with the performance of hard disk drives, you're looking at an *overall 25%-30% decrease in access time and the virtual memory environment of a minicomputer such as the VAX.*

### KACHE BOARD PERFORMANCE



- Kache Board Performance
- RAM Performance
- Apple Performance with Hard Disk Drive
- Apple Performance

### CONTINUOUSLY INCREASING PERFORMANCE

As more data files reside in Cache, the performance of the Kache Board continues to improve beyond that of RAM disk. An increasing number of disk access requests are replaced by electronic data transfer from "real" cache memory (see graph above).

### AVAILABLE SOON

Available soon: Kache Boards for IBM and IBM compatible systems.

### DIRECT FROM DEVELOPER

The Kache Board is available exclusively from Ohio Kache Systems on a direct mail basis only. For more information on the Kache Board write for our free brochure. Or call us toll free at:

**1-800-338-0050**

We think you'll be as excited about this new product as we are!



Ohio Kache Systems Corp.

4166 Little York Road

Dayton, Ohio 45414-2566

513-890-3913

© Ohio Kache Systems is a developer of computer enhancement products.

OKS, Kache Board and the OKS logo are trademarks of Ohio Kache Systems, Inc.

Apple is a registered trademark of Apple Computers, Inc.

IBM is a registered trademark of International Business Machines, Inc.

Sider is a trademark of First Class Peripherals, Inc.

VAX is a trademark of Digital Equipment Corp.



# THE C. ITOH TRIPRINTER

BY ROBERT D. SWEARENGIN

*A hefty printer that  
produces speedy drafts and  
high-quality graphics*

The TriPrinter by C. Itoh is a hefty printer that produces pica, elite, condensed, italic, double-wide, double-high, bold, underlined, superscript, and subscript typefaces. It can also produce combinations of these typefaces (see the box on page 284). The printer lets you program dozens of functions such as print quality, pitch, and lines per inch using 11 membrane buttons on the flat front panel. You read the printer's current status on a three-digit LED display. If anything goes wrong, you'll know immediately; the machine has several alarms, including one that signals overheating.

All these features come with a considerable price tag: \$1895. The TriPrinter is not for the casual user.

## SETTING UP

Getting the TriPrinter out of the box and onto a sturdy stand is the hardest part of setting up; the unit is 22 inches wide, 16½ inches deep, and 4½ inches high. It weighs almost 39 pounds. After setting up, you simply lift the lid and plug in the matching interface and font cartridges.

The interface cartridge for the Model 20 TriPrinter (the IBM and Epson graphics-compatible version, which I reviewed) has the standard Centronics parallel interface. Serial interfaces come with the Model 10, which is for DEC computers, and the Model 40, designed for the Apple Macintosh. The Model 30, which emulates CIE and Printronix 300- and 600-line-per-minute printers, uses both parallel and serial interfaces. The font cartridges for all models are in Courier, a clean and readable type-

face. No other typefaces are available. The cartridge interface sets sell for \$75, or \$245 with the optional 16K-byte buffer.

The TriPrinter's ribbon cartridges snap in easily. The cartridges cost \$35 each, or \$210 for six. This sounds expensive, but the bidirectional nylon ribbons each provide 15 million impressions.

The printer's built-in tractor feed is the best design I've encountered, although it makes paper a bit more difficult to load. The rear-fed paper snaps into the bottom of the tractor feed, goes around the platen, and snaps again into the top. The double grip may be an example of over-engineering, but this printer will probably be feeding paper long after other printers have jammed or worn out.

The mechanism works smoothly and can accommodate paper up to 16 inches wide. You can also feed paper from a slot on the bottom of the printer. In this case, the paper goes around the platen and attaches to only the top side of the tractor feed.

The printer performs five self-diagnostic tests. One initializes the EEPROM to factory-specified default values for all functions. Another test prints a menu of current default values. A standard sliding-character test, in which each line begins one character over from the line above it, includes graphics. A single-character test repeats the letter or number you select, and a mixed-character test includes all the type variations: bold, underline, italics, etc.

The front panel is well designed but takes considerable time to get accustomed to because of its numerous programming options. Each button represents a function and a numeric value. For example, the Reset (0) button returns the printer to its previous state. The Mode (1) button readies the printer for function changes, and the Test (2) button activates the test mode. Additional buttons change commonly used functions without requiring you to change the Mode (1) switch: Forms (3) changes form length, Font (4) changes draft and letter quality, CPI (5) changes pitch, LPI (6) changes lines per inch, TOF (7) controls top of form.

*(continued)*

Robert D. Swearingin (P.O. Box 1743, North Adams, MA 01247) is a professor of English and journalism and a freelance author.



**C. Itoh TriPrinter (Model 20)**

**Type**  
Dot-matrix impact printer

**Company**  
CIE Terminals  
2505 McCabe Way  
Irvine, CA 92714  
(714) 660-1421

**Size**  
22 by 16½ by 4½ inches  
39 pounds

**Features**  
Draft and letter-quality text  
IBM and Epson graphics-compatible  
Highest speed: 258 cps (BYTE benchmark)  
2K-byte buffer; additional 16K bytes optional

**I/O Interfaces**  
Parallel or serial

**Documentation**  
90-page spiral-bound user's manual

**Price**  
\$1895

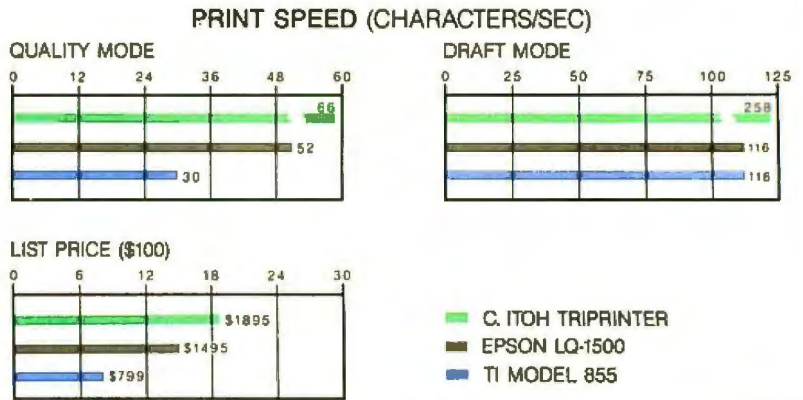

A comparison of the C. Itoh TriPrinter with the Epson LQ-1500 printer (see the review in the December 1984 BYTE) and the TI Omni 800/Model 855 printer (see the review in the January 1985 BYTE). Each printer has a fast-draft mode and

a slower high-quality mode, among others. The Print Speed benchmark involves printing 50 rows of 80 As each at a pitch of 10 characters per inch in draft and quality modes. The prices shown include a tractor-feed mechanism.

This is the C. Itoh TriPrinter,  
letter quality.  
This is underlined.  
**This is boldface.**  
*This is italics.*  
***This is boldface italics.***  
**This is double-wide.**  
**This is double-high.**

and LF (8) controls line feed.

This process sounds complicated but is actually fairly simple. The printer EEPROM stores 49 fields, each representing a function with a menu of options. For example, field 34 is the print-direction function. Options on this field menu are number 1 for bi-directional (the factory default) and number 2 for unidirectional printing. To change from bidirectional to unidirectional printing, you simply punch the Mode (I) button and enter 34. The LED always displays the default, which in this case is 1. You then enter 2, and the display changes accordingly. The printer sends the change to the nonvolatile EEPROM, and unidirectional printing becomes the new default. This ability to change makes the printer extremely flexible; you can tailor any number of defaults for a specific application. The new settings you choose remain until you initialize the EEPROM to return to the

original factory defaults.

All function changes from the control panel go to the EEPROM. You can also change functions with control codes from your computer; these changes go only to the printer's 8K bytes of RAM and remain in effect until you turn the power off. The printer reverts to EEPROM defaults at the next power-up.

**SPEED AND QUALITY**

The TriPrinter is fast, although its throughput was considerably less than the rated maximum instantaneous speed of 350 cps (characters per second) in draft mode and 87.5 cps in letter-quality mode. On the standard BYTE 4000-character benchmark test, which involves printing 50 lines of 80 As, the TriPrinter's throughput at 10 pitch was 258 cps in draft mode and 66 cps in letter-quality mode. The speed was about the same on a 60-column one-page American

English first-order random approximation (see "The Art of Benchmarking Printers" by Sergio Mello-Grand, February 1984 BYTE).

I found the overall printing quality to be good. The 9-wire print head can produce a 9- by 8-pin matrix in draft mode, a 17- by 16-pin matrix in letter-quality mode, and 144 by 144 dots per inch on graphics. Keeping in mind that such judgments are always somewhat subjective, I'd rate the draft quality as standard. The letter quality is quite acceptable, but not as dense as daisy-wheel printing. I was pleased with the graphic reproduction of both large black designs and smaller intricate figures with fine lines.

**DOCUMENTATION**

The TriPrinter's step-by-step installation instructions are clear and easy to understand, and the user's manual is packed with technical information. The chapters on operation and pro-



gramming are thorough and detailed.

However, the manual is not written for novices, and more detailed explanations would have been helpful in several places. Also, the organization of the manual could be improved. For example, when you've finished installing the printer, you must flip over some 20 pages to find the information about the printer's self-diagnostic tests. Furthermore, there's no index—a serious omission.

### PROBLEMS

A sliding aluminum catch on the left side of the TriPrinter locks the cover open for loading paper and making other adjustments. The catch on my printer got stuck several times, preventing the cover from closing properly and triggering the "cover open" alarm. I tried to do some gentle adjustments with no success. Finally the catch fell off. I had no problem closing the lid after this, but I had to prop it open to change the paper. The company says it is aware of the problem and is replacing the catches with improved ones.

The printer's noise level is acceptable; it's rated at less than 58 decibels. However, the noise itself is somewhat harsh. I'd recommend using an acoustic cover for operating the printer in quiet environments.

### CONCLUSIONS

Aside from the defective catch on the cover, the TriPrinter is well constructed. Once you spend the time to learn how to operate the control panel, you can easily exercise the printer's many options. It's hard to think of any necessary features that aren't already built in. I liked the TriPrinter and enjoyed using it.

The price tag, however, raises a very serious question about the TriPrinter, particularly with its 9-wire print head. A number of printers with denser matrices sell for considerably less money, although the specified print-head life of one billion dots per wire should provide longtime, high-volume data-processing and graphics use, with the letter quality as an added bonus. If its features fit your needs, the TriPrinter is certainly worth comparing with other high-end printers. ■

## Expand Your Computer's Capability . . . Instantly!

TSP-IBM '79  
(3 Port Switch)

### Now You Can Send Data to as Many as Four Peripherals at the Touch of a Button!



Via West Data Switches do away with recabling forever. Simply connect between your computer and printers, modems, plotters, terminals, networks, etc. and direct data to the peripheral you want at the touch of a button!

Our switches fit all types of computers and cable connectors. This includes code activated switches for keyboard control. Both serial and parallel versions are available in 2, 3, and 4 port configurations.

X Switches are also available.

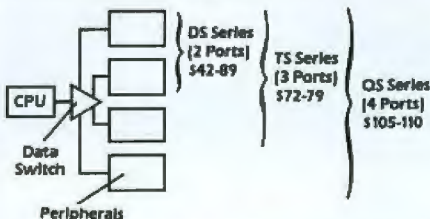

Over 22 switch types in stock for Apple, Macintosh, IBM PC/AT/386/387, WANG, and compatibles. We also offer a full line of cables and connectors. Custom orders are welcomed. All orders shipped freight collect. Add \$4/Unit for postpaid delivery. Checks, Visa or MasterCard accepted. Arizona residents add 7%. Dealer inquiries invited.

**VIA WEST, Inc.**  
"The Interface Company"

534 North Stone Ave.  
Tucson, Arizona 85705  
**(602) 623-5716**

IBM and IBM PC/AT-International Business Machines Corp. Macintosh and Apple-Apple Computer, Inc. Wang-Wang Laboratories, Inc.

**Prices Start as Low as \$42!**

## A **CROSTALK** <sup>®</sup> **SuperKlone** <sup>™</sup>



**MIRROR** <sup>™</sup> provides:

- Crosstalk XVI compatibility
  - Background communications
  - Built-in text editor
  - Automatic logon script generation
  - Transaction log
- AND MUCH MORE...



1210 E. Park Ave. • Tallahassee, FL 32301  
For information call 1-904-878-8564  
TLX: 6714280 KLOM

The Age of KlonWare Has Arrived

Shipping/handling ..... 5.00  
(COD orders add \$3.00)  
International shipping/handling ..... 18.00  
Florida residents must add 5% sales tax



To Order Call **(904) 878-8564**

Distributed in Canada by:  
Saraquay Software Distributors,  
Telephone: (416) 923-1500

Distributed in the UK by:  
Trisoft Ltd. Telephone: (0629) 3021

Distributed in the Scandinavia by:  
UNIC, (Norway)  
Telephone: 02 38 39 10

Distributed in Australia by:  
Delta Computer Systems Pty Ltd,  
Telephone: (02) 633-4055  
P.C. Extras Pty. Ltd.,  
Telephone: (02) 319-2155

**MIRROR** <sup>™</sup>  
**\$69.95**

Site Licensing Available  
60-Day Money-back Guarantee  
Not Copy Protected

MIRROR is available for the IBM PC/AT and compatibles running MS-DOS 2.0 or higher. MIRROR, KlonWare and SoftKone are trademarks of SoftKone Distributing Corporation. Crosstalk XVI and Microsoft are registered trademarks of Microsoft, Inc.

# CAD and Mouse...



## ...Manager Mouse.™

The serious mouse for the serious graphics and CAD user. Remember —all mice are not created equal—

Torrington's Manager Mouse is the only mouse that can answer yes to all these questions:

- Can it sustain extended use without maintenance?
- Can it operate on a variety of desktop surfaces at any angle?
- Is it conveniently portable with no external power supply, no special pads?

- Does it have a unique, patented independent suspension system for trouble-free performance?

- Can it be used with Lotus 1-2-3™?\*
- A mouse by any other name?  
You can't be serious.

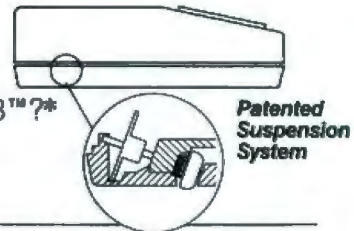

### Manager Mouse can be used with these CAD programs:

**AutoCAD™    CadPlan™    drafix 1™    EE Designer™    Procad™    smARTWORK™**  
**CADKEY™    CADVANCE™    EasyCAD™    Generic CADD™    RoboCAD-PC™    VERSACAD™**

And these popular graphics programs:

**Freelance™    EnerGraphics™    Harvard Presentation Graphics™\*    DO-IT™    EGA PAINT™**  
**Telepaint™    Dr. HALO™    ClickArt Personal Publisher™    IPRINT™**

**Call 1-800-982-0030 for the Manager Mouse dealer near you.**

\*Specify Manager Mouse with KeyFree.™

Manager Mouse and KeyFree are registered trademarks of The Torrington Company. AutoCAD of Autodesk, Inc.; CADKEY of Micro Control Systems Inc.; CadPlan and CADVANCE OF Calcomp; ClickArt Personal Publisher of T/Maker Company; DO-IT of Studio Software Corp.; Dr. HALO of Media Cybernetics, Inc.; drafix 1 of Foresight Resources Corp.; EasyCAD of Evolution Computing, Inc.; EE Designer of Visionics Corp.; EGA PAINT of RIX SoftWorks, Inc.; EnerGraphics of Enertronics Research, Inc.; Freelance of Graphic Communications Inc.; IPRINT of Indigo Software Ltd.; Lotus 1-2-3 of Lotus Development Corp.; Generic CADD of Generic Software, Inc.; Harvard Presentation Graphics of Software Publishing Corp.; Procad of Procad Systems, Inc.; RoboCAD-PC of Robo Systems Corporation; smARTWORK of Wintek Corporation; TelePaint of LCS Telegraphics. VERSACAD of T + W Systems, Inc.

## **TORRINGTON**

Part of worldwide Ingersoll-Rand



# THE TURNER HALL CARD

BY JONATHAN ANGEL

## *Simple-to-install and inexpensive memory expansion for IBM PCs and compatibles*

The IBM PC and many compatibles were designed when 256K bytes was considered an ample amount of memory. Adding more memory to these machines requires installing an expansion card. Most expansion cards are already loaded with optional parallel and serial ports. However, the typical IBM PC user already has a parallel and a serial port. Adding a typical multifunction card could be expensive overkill.

One solution to this problem is the Turner Hall Card, which expands the IBM PC's memory by 256K bytes without adding any unwanted extras. The card also includes a clock/calendar and software to let you use the extra memory for print spooling or as a RAM disk.

### INSTALLATION

To keep the price down, Turner Hall has kept the circuitry on this card simple. This makes installation relatively easy for most users. If you have a 256K-byte IBM PC XT, the Turner Hall Card is the simplest expansion card you could possibly install. All you have to do is remove the PC XT's cover, fit the Turner Hall Card into the short expansion slot, and put the cover back on. Your PC XT will now have 512K bytes of memory, a clock, plenty of room for expansion, and you won't have had to change any switch settings or move any jumpers.

The only mistake you could make during installation is to put the card in its expansion slot backward. This is possible because the card is so short and doesn't have a backplane connector. The owner's manual cautions against this potential problem.

If your computer is not an IBM PC XT you will, at the very least, have to alter DIP switches on the motherboard to let your computer know about the new memory you have installed. This is no more than you would have to do with any other card.

However, some aspects of the Turner Hall Card make installation complicated if your IBM PC is not fitted with 256K bytes of memory. Most memory-expansion boards have a bank of DIP switches that let you select a variety of load addresses; the Turner Hall Card has only a jumper that sets its load address at either 256K or 512K bytes.

Thus, if your IBM PC does not already have 256K bytes of memory, you must add either chips or another expansion card to bring the machine's

memory up to the first address. If your IBM PC already has 512K bytes of memory, adding the Turner Hall Card will bring the memory up only to the DOS limit of 640K bytes.

For machines that already have memory between 256K and 512K bytes, there are three options. First, you can disable some of your existing memory to bring it down to 256K bytes. Second, you can add RAM with another expansion card to bring it up to 512K bytes and then install the Turner Hall Card. You would then have 768K bytes of RAM, of which only 640K bytes could ordinarily be used. Third, you can add the Turner Hall Card memory between 256K and 512K bytes and set switches, if available, on your other expansion card to make sure its memory address starts at above

512K bytes.

Turner Hall's documentation takes you through all these steps with good tables and illustrations. It also shows you how to disable the clock on the card if your IBM PC already has one.

### SOFTWARE

The Turner Hall Card comes with software for activating the clock, which is a device driver (CLOCK.SYS). You do not have to slow booting by cluttering your AUTOEXEC.BAT file with another program name. You can simply add the line

DEVICE = CLOCK.SYS

(continued)

Jonathan Angel (678 Tennyson Ave., Palo Alto, CA 94301) is a freelance writer and columnist.



# COMPUTER WAREHOUSE

CALL TOLL FREE **1-800-528-1054**

**FREE** **FEDERAL EXPRESS**

**Air Express Shipping**

See Details Below

**HARDWARE**

**NOW**

**BEST PRICES**

**No Charge for Bank Cards**

**PRINTERS**

|                      |        |
|----------------------|--------|
| Brother All Models   | Call   |
| Cannon Laser Printer | \$1949 |
| Citizen MSP-10       | \$279  |
| MSP-15               | \$379  |
| MSP-20               | \$315  |
| MSP-25               | \$479  |
| Premier 35           | \$479  |
| Diablo D-25          | \$489  |
| 635                  | \$1035 |

**EPSON**

|                            |        |
|----------------------------|--------|
| All Printer Models         | Call   |
| Fujitsu                    | Call   |
| IBM Proprietary            | \$399  |
| Juki                       |        |
| 6100                       | \$349  |
| 6300                       | \$669  |
| NEC 3510, 3550, 3515, 3530 | \$729  |
| 8810, 8830, 8850           | \$1039 |
| P6                         | \$959  |
| P8                         | \$429  |
| P7                         | \$609  |

**OKIDATA**

|                    |       |
|--------------------|-------|
| All Printer Models | Call  |
| Panasonic 1080     | \$199 |
| 1091               | \$239 |
| 1092               | \$309 |
| 1592               | \$425 |
| KXP3151            | \$399 |

**STAR MICRONICS**

|                               |       |
|-------------------------------|-------|
| All Printer Models            | Call  |
| Toshiba 321 Parallel & Serial | \$449 |
| 341                           | \$769 |
| P351 Parallel & Serial        | \$969 |
| Laser Printer                 | Call  |

**KEYBOARDS**

|                 |       |
|-----------------|-------|
| Keytronics 5151 | \$159 |
|-----------------|-------|

**PLOTTERS** Epson HI-80 Call

**DISKETTES**

|                       |       |
|-----------------------|-------|
| Maxell MD-2 (Qty 100) | \$100 |
| Sony MD/2 (Qty 100)   | \$119 |

**MONITORS**

|                    |      |
|--------------------|------|
| Amdex All Monitors | Call |
| NEC All Monitors   | Call |
| Princeton Graphics | Call |
| Zenith All Models  | Call |

**VIDEO TERMINALS**

|                    |       |
|--------------------|-------|
| Gume QVT Green 101 | \$299 |
| OVT Amber 101      | \$314 |
| Wyse 30            | \$299 |
| 50                 | \$419 |
| 75                 | \$559 |
| Wyse 85            | \$439 |
| Wyse 350           | \$859 |
| Zenith Z-22        | \$455 |
| Z-29A              | \$569 |
| Z-49               | Call  |

**MODEMS**

|                       |       |
|-----------------------|-------|
| Anchor Automation     |       |
| Signalman Express     | \$235 |
| Practical Peripherals |       |
| Practical 1200 Baud   | \$124 |

**HAYES**

|                          |       |
|--------------------------|-------|
| All Modems               | Call  |
| Prometheus All Models    | Call  |
| US Robotics Courier 2400 | \$379 |
| Password 1200            | \$180 |
| Microlink 2400           | \$379 |

**DISK DRIVES**

|                        |        |
|------------------------|--------|
| Imega Bernoulli 10 meg | \$1249 |
| Bernoulli 20 meg       | \$1649 |
| Bernoulli 40 meg       | \$2329 |

**SEAGATE**

|                      |       |
|----------------------|-------|
| 20 meg w/Western I/O | \$395 |
|----------------------|-------|

**BOARDS**

|                               |       |
|-------------------------------|-------|
| AST Advantage                 | \$329 |
| Rampage AT                    | \$445 |
| Rampage PC                    | \$239 |
| Six Pack Plus                 | \$159 |
| Hercules Color Card           | \$149 |
| Graphic Card                  | \$179 |
| Intel Above Board PC (1110)   | \$239 |
| Above Board AT (2010)         | \$329 |
| Above Board PS/AT (2110)      | \$369 |
| Maynard Hardcard              | \$549 |
| Paradise Modular Graphic 06-1 | \$239 |
| Five Pak                      | \$115 |
| Plus Development              |       |
| Plus Hard Card 20 Megabyte    | \$669 |
| Quadram Gold & Silver Boards  | Call  |
| Quadlink                      | \$329 |
| Quad EGA+                     | \$359 |
| Tec Mar Graphics Master       | \$445 |
| Captain No Memory             | \$169 |

**COMPUTERS**

|                        |        |
|------------------------|--------|
| <b>IBM</b>             |        |
| PC 1 Drive 256K        | \$1199 |
| XT 1 Drive 256K        | \$1729 |
| XT 1 Drive 20 Meg 640K | \$2169 |
| AT/68                  | \$2849 |
| AT/386                 | \$4449 |
| <b>COMPAQ</b>          |        |
| Portable II-2 Drive    | \$1649 |
| Toshiba T-1100         | \$1299 |
| T-1100 Plus            | Call   |
| T-3100                 | Call   |

**PANASONIC**

|                          |        |
|--------------------------|--------|
| Sc Partner Dual Drive    | \$1309 |
| Exec. Partner Dual Drive | \$1899 |

**TOSHIBA**

|        |      |
|--------|------|
| T-1100 | Call |
|--------|------|

**SPERRY**

|              |        |
|--------------|--------|
| Sperry IT    | \$1999 |
| Other Models | Call   |

**WYSE**

|                 |        |
|-----------------|--------|
| Wyse pc 1100-1  | \$979  |
| Wyse pc 1100-20 | \$1539 |

**Zenith Computer Products**

**SAVE Up to 50%**  
All Models Call

**COPIERS**

|              |       |
|--------------|-------|
| <b>Canon</b> |       |
| (((PC)))     |       |
| Canon PC-20  | \$719 |
| Canon PC-25  | \$939 |



**\$449**

**MIT SYSTEMS Turbo PC/XT**

256 Memory, One 360K Brand Name Floppy Drive, 135 Watt Power Supply, Slide Case, AT Style Keyboard, 8 MHz Clock Speed, (Keyboard Selectable), 8 Expansion Slots

## SOFTWARE

### IBM PC and 100% Compatibles

**TRAINING**

|                   |      |
|-------------------|------|
| Flight Simulator  | \$28 |
| PC Logo           | \$75 |
| Typing Instructor | \$28 |
| Typing Tutor III  | \$28 |

**LANGUAGES**

|                              |       |
|------------------------------|-------|
| C Compiler (Microsoft)       | \$249 |
| Fortran Compiler (Microsoft) | \$195 |
| Lattice C Compiler           | \$242 |
| Macro Assembler (Microsoft)  | \$84  |
| Pascal Compiler (Microsoft)  | \$166 |
| Quick Basic 2                | \$55  |
| Run C Interpreter            | \$65  |
| Turbo Pascal w/8087 & BCD    | Call  |
| Turbo Database Tool Box      | \$30  |

**PROJECT MANAGEMENT**

|                               |       |
|-------------------------------|-------|
| Harvard Total Project Manager | \$262 |
| Microsoft Project             | \$219 |
| Super Project Plus            | Call  |
| Timeline 2.0                  | \$209 |

**COMMUNICATIONS**

|                        |            |
|------------------------|------------|
| CompuServe Starter Kit | Best Price |
| Crosstalk XVI          | \$92       |
| MS Access 1.01         | Call       |
| PFS Access             | \$76       |
| Remote                 | \$92       |
| Smartcom II            | \$83       |

**INTEGRATIVE SOFTWARE**

|                       |       |
|-----------------------|-------|
| Enable 1.1            | \$319 |
| Framework II          | Call  |
| Smart Software System | \$379 |
| Symphony              | Call  |

**GRAPHICS**

|                              |       |
|------------------------------|-------|
| Charlmaster                  | \$199 |
| Diagram Master               | \$185 |
| Energraphics 2.0             | \$269 |
| In-A-Vision                  | \$249 |
| Microsoft Bus Mouse          |       |
| w/PC Paintbrush 3.0          | \$106 |
| Microsoft Chart              | \$164 |
| Microsoft Serial Mouse       | \$119 |
| Newsroom                     | \$31  |
| PC Draw                      | \$199 |
| Click Art Personal Publisher | \$99  |
| PC Mouse w/Dr Halo II        | \$99  |
| PC Paint w/Mouse             | \$115 |
| PFS Graph                    | \$76  |
| Printmaster                  | \$29  |
| Signmaster                   | \$132 |
| Turbo Graphix Tool Box       | \$30  |

**WORD PROCESSORS**

|                                 |       |
|---------------------------------|-------|
| Leading Edge Word Processor     | \$48  |
| Leading Edge W/P w/Spell & Mail | \$72  |
| Lightning                       | \$55  |
| Microsoft Word 3.0              | Call  |
| Multimate Advantage             | Call  |
| PFS Write w/Spell Checker       | \$78  |
| Wordstar w/Tutor                | \$162 |
| Wordstar Pro Pack               | \$233 |

**Word Perfect (Ver.4.1) \$196**  
**Wordstar 2000 + 2.0 \$278**

**UTILITIES**

|                            |      |
|----------------------------|------|
| Copy II PC                 | \$19 |
| 1 DIR                      | \$46 |
| Fastback                   | \$86 |
| Printworks 3.1             | \$48 |
| Printworks                 | \$36 |
| Sidack                     | \$30 |
| Sidack (Unprotected)       | \$47 |
| Sidack - Superkey (Bundle) | \$85 |
| Travelling Sidack          | \$39 |
| Turbo Prolog               | \$54 |
| Sideways 3.1               | \$34 |
| Superkey                   | \$39 |

**SPREADSHEETS**

|                         |       |
|-------------------------|-------|
| Lotus 1-2-3             | Call  |
| Multipan                | \$108 |
| Spreadsheet Auditor 2.0 | \$82  |
| VP Planner              | \$48  |

**Supercalc 4** Call

**MONEY MANAGEMENT**

|                            |      |
|----------------------------|------|
| Dollars & Sense w/Forecast | \$94 |
| Tobias Managing Your Money | Call |

**DATA BASE MANAGEMENT**

|                        |       |
|------------------------|-------|
| Clipper                | \$335 |
| Cornerstone            | \$67  |
| dBase II               | Call  |
| dBase III Plus         | Call  |
| Extended Report Writer | \$74  |
| Knowledgebase II       | \$279 |
| Nutshell 2.0           | \$59  |
| PFS: File              | \$76  |
| PFS: Report            | \$67  |
| Quickcode              | \$138 |
| QuickReport            | \$138 |
| Reflex                 | Call  |
| Think Tank             | \$91  |

**R:Base 5000** \$245

Many other titles available.

Inquiry 84 for MS DOS Products. Inquiry 85 for all others.

# COMPUTER WAREHOUSE

Order Line: 1-800-528-1054  
Order Processing: 602-224-9345  
2222 E. Indian School Rd.  
Phoenix, Arizona 85016  
602-954-6109

Store Hours: Mon-Fri 10-5:30  
Saturday 9-1  
Order Line Hours: Mon-Fri 7-5:30  
Saturday 9-1  
Order Processing Hours: Mon-Fri 10-3

Product shipped in factory cartons with manufacturer's warranty. Please add \$6.00 per order for UPS ground shipping on orders up to 10 lbs. Orders 10 lbs. and under you pay for ground service, receive air service at no extra charge. Available on orders 11-30 lbs \$17 for air service. Prices & availability subject to change without notice. Send cashier's check or money order...all other checks will delay shipping two weeks.

**Turner Hall Card**

**Company**

Turner Hall Publishing  
10201 Torre Ave.  
Cupertino, CA 95014  
(408) 253-9607

**Computer**

IBM PC, XT, AT, or compatible with at least 256K bytes of RAM and one vacant expansion slot

**Features**

256K-byte memory expansion, clock/calendar, and software for print spooling and RAM disk

**Documentation**

28-page owner's manual with documentation for RAM disk and print spooler

**Price**

\$99.95

to your CONFIG.SYS file, and the on-board clock will be automatically activated when you turn your computer on. Furthermore, the clock can be permanently reset simply by using the date and time functions in DOS; many competing boards require their own software to do this.

The RAM disk and print spooler programs (RAMDISK.SYS and SPOOL.COM) do not come with the board. Instead, Turner Hall sends them to you after you register your purchase. The documentation for these programs comes as a disk file that you must print.

RAMDISK.SYS gives you a RAM disk that is variable in size from 64K to 360K bytes but limited to holding a maximum of 32 files. SPOOL.COM gives you a print spooler that can be as small as 1K or as large as 64K bytes. Unlike some spoolers, you can vary its size or delete it from memory without rerunning the program. You can also pause it to change paper. I

found that it worked with SideKick and SmartKey II without conflict.

**CONCLUSIONS**

The Turner Hall Card is reasonably priced and supported by superior documentation and software. The workmanship is good, but the 256K-byte RAM chips are soldered in place. However, Turner Hall will give you a new card if anything fails during your first year of ownership.

The only major flaw is that the card's starting memory addresses are set only at 256K or 512K bytes. This is too limiting; other expansion cards offer much more flexibility.

I would recommend the Turner Hall Card particularly to computer users who don't want to study manuals and flip switches. For users of 256K-byte IBM PCs, XTs, ATs, and compatibles, it is a simple and economical way to upgrade memory. The card would also be useful in any machine that lacks full-length expansion slots. ■

# Effortlessly.

Inquiry 394 for End-Users  
Inquiry 395 for DEALERS ONLY



That's how easy it is to implement on the Apple Macintosh the enormous volume of applications written in dBase III for the IBM PC. Using dMac III, you can develop applications on the Macintosh and transfer them to the PC where they can be implemented under dBase III. With dMac III, the IBM PC and the Apple Macintosh work as a smooth running, tireless team.

• *dMac III's nearly limitless range of power includes:*

- \*Up to 2,000 procedures per procedure file
- \*Up to 2,000 memory variables
- \*Up to 2,000 fields per record
- \*Up to 253 bytes per field

• *Like dBase III, dMac III features a powerful programming language that offers Macintosh users the ability to create professional business applications.*

• *dMac III shares data with other major Macintosh software packages... in both directions*

• *To run dMac III you need:*

- \*Apple Macintosh or Macintosh plus with 512 KB RAM
- \*two disc drives or one disk drive and a hard disk

• *dMac III is immediately available at a suggested retail price of \$495.00*

For your authorized dMac III dealer contact:

FORMAT SOFTWARE, INC.  
11770 Bernardo Plaza Ct. Suite 217  
San Diego, CA 92128  
(619) 487-6946

IBM is a trademark of the IBM Corporation  
Macintosh is a trademark licensed to Apple Computer, Inc.  
dBase III is a trademark of Ashton-Tate, Inc.

## dMac III makes the exchange smoothly and in stride.

# AT Power, Toshiba-Style.



# The Toshiba T3100.



Try tucking this into a drawer when you're done! Until now, you had to be tied to your desk in a tangle of cables and hardware to get AT power. Toshiba's T3100, on the other hand, puts AT performance anywhere you want.

Toshiba technology improves on AT functionality: The T3100 gives you the power of an IBM® PC-AT™ in a lean, 15-pound computer that looks superb on your desk, and slips into a drawer when you don't need it. Take it home, take it to a meeting, take it around the world—wherever your work takes *you*.

## Don't let its size fool you.

The T3100 is less than a third the size of the Compaq™ Portable II, yet every bit as powerful. It uses the same 80286 microprocessor as the AT, and is fully IBM-compatible, so you can share data with the other desktop computers in your office. The T3100's 10MB internal hard disk gives you ample storage for sophisticated applications. A dual-voltage power supply lets you plug in and go to work just about anywhere in the world. And Toshiba built in an advanced gas plasma screen, to give you the clarity and brightness of a CRT display—without the bulk.



*Compact is as compact does: The T3100 is less than a third the size of the Compaq Portable II.*

## More memory for more applications.

The T3100's full 640KB RAM lets you work with the most popular IBM PC/XT™ and AT software: Integrated financial and analysis programs, large spreadsheets, lengthy documents, electronic filing and more. A built-in 720KB diskette drive handles the new industry standard 3½" diskettes. Each IBM-compatible pocket-sized disk holds *twice* as much information as a conventional 5¼" diskette! And you can easily transfer data to and from other desktop computers using Toshiba's optional external 5¼" diskette drive.

Trademarks: PC-AT, PC/XT—International Business Machines Corporation; Compaq—Compaq Computer Corporation; MS-DOS—Microsoft Corporation. Registered Trademarks: IBM—International Business Machines Corporation; Hayes—Hayes Microcomputer Products, Inc.; SuperKey and SideKick—Berland International, Inc.

## "Big" system expansion options.

Like any full-function desktop system, the T3100 grows with your computing needs. Toshiba offers a full line of internal



*Software, everywhere: The T3100 runs the most popular applications written for the IBM PC/XT and AT.*

and external options, including an expansion chassis with 5 IBM-compatible slots, and an internal 300/1200 bps Hayes®-compatible modem.

## The next generation of computing is here. And it sure would look great on your desk. Or away from it.

Desktop computing will never be quite the same again, thanks to Toshiba's advanced CMOS and proprietary gate array LSI technology. The T3100 is backed by our reputation for high quality electronics, and by our 110-year commitment to technological excellence.

See where desktop AT power is headed.

The T3100 is *here now!* Call:  
**1-800-457-7777**

for your nearest  
Toshiba dealer.

**Now!**  
Includes  
SideKick®  
and SuperKey.®

In Touch with Tomorrow

# TOSHIBA

TOSHIBA AMERICA, INC., Information Systems Division

### Specifications:

- IBM PC-AT compatible
- 80286 processor, running at 8MHz or 4 MHz
- 640KB RAM, extendable to 2.6MB
- Built-in 10MB hard disk
- Built-in 720KB 3½" diskette drive
- MS-DOS 2.11 operating system
- High-resolution gas plasma display
- IBM Color Graphics Adapter (CGA) compatible
- 80 × 25 character display
- 640 × 400 bit-mapped graphics display
- RGB, parallel, serial and external diskette drive ports
- Carrying case, MS-DOS,™ BASIC included
- Full-sized 81-key keyboard
- 110/220 VAC switch-selectable power supply
- 12.2" W × 3.1" H × 14.2" D
- All this—and only 15 pounds



# A FRIEND INDEED.

Face it. Everybody needs somebody sometime. And even the best PC occasionally needs help with faulty power.

So give your hard disc or critical-use system LINE 2® power conditioning. And eliminate those nagging problems that your PC can't prevent. Like voltage sags and surges. Brownouts. Spikes.

LINE 2 Power Conditioners are designed

specifically with your PC in mind. High inrush currents don't affect them. Neither do power problems. And they're amazingly economical.

A LINE 2 Power Conditioner can be your PC's best friend. And a friend in need is a friend indeed. Call us today at (619) 279-0831, or contact your local Square D distributor.

## TOPAZ®

A Subsidiary of Square D Company





# TURBO PROLOG

BY NAMIR CLEMENT SHAMMAS

## *An easy-to-use nonstandard implementation of Prolog for the IBM PC*

In March, Borland International entered the arena of artificial intelligence languages by launching its Turbo Prolog compiler. This review looks at version 1.0.

### ENVIRONMENT

Turbo Prolog provides an excellent interactive environment in five windows. The top window is a one-line horizontal main menu that offers options that let you edit, compile, and run a program; set up the compile options; perform file-related operations; alter the window setups; and quit.

A message window informs you of current activities. These include messages related to file I/O and compilation progress. The dialog window is active when you run a program. It accepts input from the user and displays results. The trace window is active only when a program (or portions of it) turns on the trace option. This window lets you follow the Prolog program in execution step by step. Turbo Prolog does not make a more advanced debugger available.

You can adjust the color, size, and location of the windows and save the updated configuration in a special file for a permanent setup.

The built-in Turbo Prolog editor is very similar to that of Turbo Pascal or WordStar in nondocument edit mode. Turbo Prolog also provides a pop-up auxiliary edit window that lets you view or edit another Turbo Prolog source file. You can make nested calls to the auxiliary edit window, and the environment correctly recalls previous files once you have finished editing the current file.

### COMPILER

The Turbo Prolog compiler lets you compile and run programs in memory or create external program files. Com-

pilation in memory is very fast and attempts to approach the immediate interaction of a Prolog interpreter.

If the compiler detects an error, Turbo Prolog activates the editor window, points out the location of the offending syntax, and displays an accompanying compiler message that is highlighted at the bottom of the window. One problem with this is that the error message is truncated if it is longer than the width of the editor window (although you can adjust the size of the window, as mentioned above). The Turbo Prolog manual lists the error messages but offers no additional explanation or remedies, and some of the compiler error messages are unclear.

When you create compiled program files, Turbo Prolog offers two alternatives. If the program you are compiling is relatively small, you can create an EXE file (executable at the DOS prompt) from within Turbo Prolog. This makes the compiler create an object file and then call for the Microsoft linker, LINK.EXE, to produce the EXE file. Following the linking phase, you are prompted to either run the new Prolog program or go back to the Turbo Prolog environment. I found that it is best to go back to Turbo Prolog, exit from it, and then run the compiled program. I discovered that attempting to run programs using extensive recursion while having Turbo Prolog resident in memory invariably resulted in an "insufficient memory" run-time error. For large programs, you should select the op-

tion to create object files, exit from Turbo Prolog, and resume linking under DOS.

The Turbo Prolog compiler has 10 directives to fine-tune its operation. Among these directives are ones that allow you to set the size of the in-

ternal code array, include source code from another text file, display an analysis of your program as it is being compiled, suppress the Control-Break or Control-C options for program interruption, suppress compiler warnings, set up a modular software project, and trace the program flow.

Turbo Prolog programs can interface with programs compiled in Pascal, C, FORTRAN, and assembly language. This allows you to write routines more efficiently in any of the above languages and then call them from a Turbo Prolog program.

### LANGUAGE

The syntax of Turbo Prolog differs significantly from that of standard Prolog. Being a Pascal/Modula-2 programmer, my initial reaction was one of delight. Turbo Prolog is more structured and enforces data type checking, which makes the source listings much more readable than those of standard Prolog.

A Turbo Prolog program is divided into declaration sections, some of which are optional. The first program declaration section is the domains, where local user-defined types and lists are declared. The global domains section makes data types accessible by other program modules. The predicates section defines local predicate names and the number and type of arguments for each predicate.

*(continued)*

Namir Clement Shammass (4814 Mill Park Court, Glen Allen, VA 23060) is a freelance writer and programmer.

**Turbo Prolog**

**Type**  
Programming language

**Company**  
Borland International Inc.  
4585 Scotts Valley Dr.  
Scotts Valley, CA 95066  
(408) 438-8400

**Format**  
Two 5¼-inch disks; MS-/PC-DOS format

**Computer**  
IBM PC, two disk drives, 384K bytes of memory, and PC-DOS version 2.0 or later

**Documentation**  
225-page user's manual

**Price**  
\$99.95

The global predicates section declares predicates accessible by other program modules. The optional goal section allows you to specify a consistent goal. If you want to try a variety of goals one at a time, this section is omitted and you are prompted for a goal at run time. Programs compiled into files must have a goal section. The database section specifies the predicates to which facts are added during run time.

The clauses section is the last program declaration section and contains all the facts and rules. All the clauses in this section must be consistent with the declaration in the predicates section. Turbo Prolog does not allow you to define predicates that have the same names as built-in predicates, even if the numbers and types of arguments are different.

Turbo Prolog supports the following basic data types: characters, integers, real numbers, strings, symbols (also known in Prolog as atoms), and files. Symbols and strings can be used interchangeably, but internally they are handled differently. There are two additional special types: `regdom`, which is used with BIOS-related predicates to access the 8088 microprocessor registers, and `dbasedom`, which is used in conjunction with the limited dynamic database.

Turbo Prolog provides predicates for data type conversion and simple string manipulation. Standard Prolog uses symbols or instantiated variables for I/O redirection, making it more flexible than Turbo Prolog. Turbo Prolog supports the list structures, which are declared by using the syntax `list name = data type *`

**BUILT-IN PREDICATES**

Turbo Prolog contains a wealth of built-in predicates, many of which come from Turbo Pascal. These predicates perform math operations, reading, writing, screen handling, string handling, and type conversion. There are also file system, system-level, and language predicates.

Turbo Prolog supports the absolute value, square root, random-number generator, logarithmic, and trigonometric functions. It provides the MOD and DIV operators, as well as bit manipulation predicates to perform AND, OR, NOT, XOR, and shifting (left and right) operations.

The reading predicates allow the input of different data types, something not needed in standard Prolog. The write predicate is "overloaded," allowing the output of multiple arguments of different types and a formatted output. Redirecting I/O is achieved by using the `readdevice` and `writedev` predicates.

The file system predicates enable a program to open a file for reading, writing, and adding data. Sequential and random access files are also supported. The file position pointer in random access files can be taken in reference to the beginning or the end of a file.

Turbo Prolog's screen- and window-handling predicates for text and high-resolution graphics allow you to control the screen cursor and create, remove, select, and clear windows. High-resolution graphics come with basic plotting and line-drawing predicates as well as turtle graphics commands.

Since Turbo Prolog is a data-typed implementation, a number of predicates are provided for type conversion. These predicates perform conversions between characters, strings, integers, real numbers, and uppercase

and lowercase characters.

The implementers of Turbo Prolog paid attention to low-level access. The predicates included in this category allow a variety of tasks, such as setting and reading the system time and date, calling the IBM PC BIOS, invoking the Turbo Prolog editor, executing a DOS command from within a Turbo Prolog program, performing port I/O, and POKEing and PEEKing bytes or words in the memory.

**DYNAMIC DATABASE**

Artificial intelligence languages, applications, and expert systems rely heavily on databases to store and retrieve accumulated information. Standard Prolog is characterized by its ability to incorporate a wide variety of user input (clauses, rules, and facts) into its database at run time. The absence of strict type checking and predicate checking in standard Prolog implementations offers superior flexibility over Turbo Prolog in this regard.

Turbo Prolog's attempt to offer such a dynamic database is hampered by both data type and predicate checking. The Turbo Prolog predicates that are involved in the dynamic database must be specified in the database section before program run time. This severely limits the flexibility that Prolog was meant to offer. The implementation deviates from the spirit of Prolog by its lack of a genuine database. Moreover, Turbo Prolog has no garbage collection routine to reclaim memory left vacant by retracted, or deleted, facts.

Turbo Prolog does not implement a number of standard Prolog predicates. These omissions are important because they have done away with some powerful Prolog features. For example, list equality test has been rendered very limited by Turbo Prolog, and complex data (such as mixed integers) is more difficult, and sometimes impossible, to define.

**MODULAR PROGRAMMING**

Turbo Prolog allows you to build modular programs. For these programs you need to use the compiler's project directive and include to include a file containing the global domains and predicates. You create a

Table 1: Benchmark tests for Turbo Prolog. Tests reflect the speed of Turbo Prolog in compiling programs and the run-time speed of the compiled programs. Turbo Prolog seems to assign a good stack size to allow deeply nested recursion. Floating-point operations and mathematical functions use the 8087 chip.

| Test           | Source File (bytes) | EXE File (bytes) | Memory Compile (seconds) | Compile and Link (minutes:seconds) | Run Time (minutes:seconds)                                |
|----------------|---------------------|------------------|--------------------------|------------------------------------|-----------------------------------------------------------|
| List Reversal  | 844                 | 46,637           | 2                        | 1:22                               | 0:11                                                      |
| Floating Point | 610                 | 46,478           | 2                        | 1:23                               | 0:42                                                      |
| Sieve          | 955                 | 46,541           | 3                        | 1:22                               | 0:03                                                      |
| Math Functions | 1469                | 49,321           | 4                        | 1:23                               | sqrt 0:06<br>ln 0:16<br>exp 0:28<br>atan 0:19<br>sin 0:18 |
| Factorial      | 634                 | 46,313           | 2                        | 1:20                               | 0:24                                                      |
| Tower of Hanoi | 598                 | 46,229           | 2                        | 1:21                               | Height 5 0:03<br>7 0:16<br>10 2:14                        |
| Disk Write     | 585                 | 46,184           | 2                        | 1:21                               | 0:54                                                      |
| Disk Read      | 448                 | 47,915           | 2                        | 1:23                               | 0:29                                                      |

librarian file for each modular program project. This is a simple text file that lists all the names of the modules involved. The compiler generates a file containing the symbols table for each module involved.

**BENCHMARKS**

I carried out a number of benchmarks on Turbo Prolog using an IBM PC XT with 512K bytes of memory, an 8087 math coprocessor chip, and a 20-megabyte hard disk drive running PC-DOS 3.1.

The List Reversal test reverses a list of 50 integers 30 times. The Floating Point test, which is similar to the standard BYTE benchmark, repeats a series of four basic operations 5000 times. The Sieve test extracts the prime numbers from the range of numbers from 1 to 100. The process is repeated 10 times. The Math Functions test clocks the speed of the square root, natural logarithm, exponential, arctangent, and sine functions. Each function is evaluated 1000 times using a fixed argument. The Factorial test evaluates the factorial of ten 1000 times. This tests the speed of a simple type of recursion. The Tower of Hanoi program tests recursion and the speed of screen output. The program accepts a variable tower height.

The Disk Write test is the Prolog version of the standard BYTE test. It

writes 512 blocks of 128 characters to a text file on an empty disk. The Disk Read test is the Prolog version of the standard BYTE test. It reads 512 blocks of 128 characters from a text file stored on a floppy disk that contains no other files.

Table 1 shows the results of the benchmark tests. The Floating Point and Math Functions tests, by virtue of their speed, seem to automatically use the 8087 coprocessor, although the Turbo Prolog manual does not mention 8087 chip support. (The manual also incorrectly lists the arctangent function as arctan instead of atan.)

Turbo Prolog programs running as compiled EXE files seem to have access to a larger recursion stack than programs running within the Turbo Prolog environment. Turbo Prolog programs enjoy fast execution speed and larger stack size (relative to other Prolog interpreters), which permits deeper recursion levels.

**CONCLUSION**

Turbo Prolog is an implementation with many good features: a very good interactive environment, a fast compiler and compiled programs, support for screen and window management, high-resolution graphics, low-level access, and mathematical functions.

However, Turbo Prolog has a Turbo Pascal flavor in its compiler and strong

data typing that create an identity problem for the language. Turbo Prolog's lack of a genuine dynamic and flexible database is its main weak point. Strict data type checking weakens Turbo Prolog's ability to perform more advanced symbolic processing. The lack of many important Prolog predicates deprives you of enjoying the unique features of standard Prolog language. Some programs written in the standard language syntax must be "hacked" before running with Turbo Prolog, while others may prove to be unportable.

Borland International claims that Turbo Prolog is a large superset of the W. F. Clocksin and C. S. Mellish definition of the language (*Programming in Prolog*, 2nd edition, Springer-Verlag, 1984). A glance through the language reference book disproves this claim. Turbo Prolog has enough changes from standard Prolog to earn it the name of "Turbo Paslog." As such, I do not recommend it if you are seriously considering becoming a Prolog programmer.

*Editor's note: The programs used in the benchmark tests of Turbo Prolog are available for downloading from BYTE.net Listings (see the insert card following page 368). To run them you will need an IBM PC with 384K bytes of memory, PC-DOS 2.0 or later, and Turbo Prolog. The programs have been grouped together in a single file called TBPROLOG.TST. ■*

# Princeton. The in



## Here are some of the reasons why

**Full EGA and CGA support.** Princeton EGA monitors bring you 64 brilliant colors and bright sharp images in enhanced graphics mode, with 640 x 350 resolution. Your EGA software never looked better. Plus our HX-12E and HX-9E automatically switch from EGA to CGA mode, when needed.

**Compatibility.** Princeton monitors are 100% compatible with leading personal computers like IBM®, Compaq®, and more. No matter what system you have, there's a Princeton monitor that's right for you.

**Quality Image.** A .28mm dot pitch (the finest dot pitch of all leading EGA displays), bright colors, and sharp resolution give Princeton monitors a quality image that cannot be beat.

**Easy Viewing and Ergonomic Design.** Princeton monitors are designed for easy use, too. You get easy viewing with the HX-12E's black matrix tube and etched

nonglare screen. The lines are crisp, the characters sharp, and the colors even, so you're more productive. Controls are located on the front, where you can reach them.

**Reliability.** Princeton monitors are designed and manufactured to meet your most demanding needs. Only the finest components are used. The result: dependable performance day in and day out.

**Value.** No other monitor gives you more for the money than Princeton. Compare for yourself. Feature for feature there's not a better value around.

**Availability.** Princeton monitors are as easy to get your hands on as they are easy to use. You can find them at computer stores around the world.

**Reputation.** More and more, people are making Princeton Graphic Systems their number one choice in personal computer displays. Because people know Princeton delivers the ultimate in compatibility, reliability, and performance.

# best choice EGA monitors.



For the no-compromise enhanced graphics monitors, look for the Princeton Graphic Systems name. Princeton delivers everything you need in a quality EGA display, from crisp, clear, full EGA support to rugged reliability. When you choose Princeton you choose the best.



**HX-9E.** The first IBM compatible 9" high resolution color monitor to support EGA. Has a .28mm dot pitch black matrix tube and etched nonglare screen for sharp, crisp displays and features a built-in tilt/swivel stand and green/amber switch.

**HX-12E.** The first IBM compatible high resolution color monitor to support EGA with a .28mm dot pitch. The HX-12E builds on the award winning features of the HX-12 and features 640 x 350 resolution for sharp, crisp text and colorful graphics.

## PRINCETON<sup>®</sup>

GRAPHIC SYSTEMS  
AN INTELLIGENT SYSTEMS COMPANY

601 Ewing Street, Bldg. A Princeton, NJ 08540, Telex: 821402 PGSPRIN, (609) 683-1660, (800) 221-1490, Ext. 804

*Ready for the Ultimate?*

**A**DVANCED MS-DOS<sup>®</sup>. If you're a seasoned assembly-language or C programmer, familiar with Intel's 8086/8088/80286 microprocessors, you want detailed information on MS-DOS<sup>®</sup> that speaks to your level of experience.

Here, from Microsoft Press and Ray Duncan, is the kind of high-level, advanced information you need to write robust,

high-performance MS-DOS<sup>®</sup> applications. Now you can explore each of the MS-DOS<sup>®</sup> functions and special features in detail, comparing and contrasting the various versions along the way. Scores of detailed programming examples — isolated code fragments and complete utility programs — illustrate each feature. And a wealth of reference information on all the functions and interrupts, error

codes, IBM ROM-BIOS, and the Lotus/Intel/Microsoft Expanded Memory Manager awaits you. ADVANCED MS-DOS<sup>®</sup> — let your experience shine. \$22.95. Available wherever books and software are sold. Microsoft Press, 16011 NE 36th Way, Box 97017, Redmond, Washington 98073-9717



**MICROSOFT.  
P R E S S**



# SOFTWARE CAROUSEL

BY MARK HAAS

Software Carousel, by SoftLogic Solutions, is a virtual memory manager that allows you to have up to 10 applications loaded and available for use. Only one program at a time can actually run, however. Unlike multitasking environments such as Quarterdeck's Desqview, Software Carousel programs that are not on-screen are in a state of suspended animation. For instance, you can start recalculating a large spreadsheet, switch to another program, and then return to find the recalculation continuing from the point where you left it. Nothing happens to your spreadsheet while you are away from it.

## USE OF MEMORY

Unlike many multitasking systems, Software Carousel allows each program, when it is running, to use all the available memory in your system. Thus, you could load your spreadsheet program six times to work on six different worksheets requiring 512K bytes of memory (assuming you have sufficient memory to store inactive partitions) and still be able to load and use four more programs with equal memory requirements. Software Carousel does this by setting up to 10 virtual compartments, called partitions, in memory to be used by the applications. This functionally turns your computer into 10 computers. Each time you switch between applications, it's like turning to another machine that is already running that application. There is no connection between the partitions, however. You cannot, for example, move data from one program to another as you can with systems like Microsoft Windows.

The active partition is loaded into what SoftLogic Solutions calls lower

## *A virtual memory manager that allows you to shift between programs instantly*

memory. This is the main RAM addressed by DOS, which can be up to 640K bytes. Several smaller partitions can coexist in lower memory, making switching between them faster. Larger partitions need to be swapped in and out of lower memory from some other storage area.

Software Carousel can utilize any available main storage memory for holding inactive partitions. On any machine you can access up to 640K bytes of RAM, the normal DOS limit. With an IBM PC AT compatible, you can have Software Carousel use up to 16 megabytes of extended memory to hold inactive partitions. With an IBM PC XT compatible, you can have the software use up to 8 megabytes of expanded memory using the Lotus/Intel/Microsoft (LIM) standard. Any machine can use up to 6.4 megabytes of available hard disk space to hold inactive partitions.

You can determine how much memory, up to the limit of available RAM, each application will have access to. You wouldn't want to assign 512K bytes of memory to a BASIC partition, for example, since anything above 64K bytes would never be used. However, you may want to have 512K bytes of memory assigned to a partition to run a program like Lotus 1-2-3. Other programs may have different memory requirements. In general, it is best to use as little memory as possible for any given application. This will improve Software Carousel's overall performance.

The user's manual might lead you

to believe that you can set up a partition to hold 640K bytes of memory. However, it will actually be less. DOS itself usually takes up between 25K and 35K bytes. Software Carousel uses about 75K bytes, and resi-

dent software, like SideKick, can take up much more. What remains is the maximum memory that you can assign to any partition. Software Carousel gives you some flexibility with this. For example, you can load memory-resident programs like SideKick and Keyworks selectively into individual partitions, freeing up memory for other partitions. You can also make these programs available from all partitions.

## SETTING UP

Before you can use Software Carousel, you must first install and initialize it. Because of SoftLogic Solutions' copy-protection method, you can install Software Carousel only three times. However, the company will provide purchasers with a non-copy-protected disk at no charge. Installing Software Carousel onto my hard disk was easily handled by a batch file provided on the master disk. After installation, I noticed in my root directory several additional "hidden" files that were associated with the copy protection.

After installation you must determine how much memory you want in each partition and where the inactive partitions will be stored. You can assign any amount of memory for each partition, in 16K-byte chunks, for up to 10 partitions. Some partitions

*(continued)*

Mark Haas (55 Franciscan Way, Kensington, CA 94707) is an editor and computer consultant. He is a former managing editor for BYTE.

**Software Carousel****Type**

Virtual memory manager

**Company**

SoftLogic Solutions Inc.  
530 Chestnut St.  
Manchester, NH 03101  
(603) 627-9900

**Computer**

IBM PC or close compatible with 192K bytes of RAM, one disk drive, and PC-DOS or MS-DOS 2.0 or later. A hard disk is recommended.

**Price**

\$49.95

can be left empty. This, in turn, determines the total system memory requirement. If, for example, you chose to have five partitions with 512K bytes, three partitions with 384K bytes, and two partitions with 64K bytes, your total system memory requirement would be 3840K bytes.

You also have to decide where you are going to get that much memory. If you are using an IBM PC XT compatible, you have at most only 640K bytes of RAM, and you must get the rest of the required memory elsewhere. You can use an AST RAMpage card or a similar expanded memory card. If you have another card that does not use the LIM standard, you can turn it into a RAM disk and use that. Or you can use a hard disk, although this results in the poorest overall system performance. If you have an IBM PC AT compatible, you can also use the machine's extended RAM, which is up to 16 megabytes. You can assign the memory requirements to your resources in any combination.

Finally, you can name each memory partition, if you find this useful. You can give the partitions any names you like, and the names will appear as part of the DOS prompt to remind you where you are. Otherwise, they will simply be numbered.

The partition sizes, the resource allocation, and the optional partition

names can all be saved for subsequent use in an ASCII file, which can be modified at any time using most text editors. You can also add commands to this file to customize other functions of Software Carousel, such as reassignment of command keys (to avoid conflicts with other applications) and to automatically load applications into each partition, including multiple command lines. This is similar to having an AUTOEXEC.BAT file for each partition. Once you have Software Carousel running, you can change partition sizes and names.

**USING SOFTWARE CAROUSEL**

After Software Carousel has been set up on your computer, you can call it up manually by entering CAROUSEL or automatically by including it in your AUTOEXEC.BAT file. The software takes about one minute to load, initialize, and load an application into the first memory partition. By pressing a two-key combination (which you can define), you can switch to another partition. If you are in a partition for the first time, you will see DOS load again. Then, if the partition is set up for it, the appropriate application will load and run.

The speed at which you can move from one partition to another depends on how much lower memory you have, how large the partitions are, and what type of backup memory you are using to hold the unused partitions. Large partitions will move more slowly than small ones; only one 512K-byte partition can exist in lower memory at once, while several 64K-byte partitions will fit at once and eliminate the need to swap partitions. A hard disk is the slowest device for holding unused partitions, while extended and expanded memory are the fastest. The slowest time that I experienced was about 15 seconds to swap a large (448K-byte) partition from a hard disk. However, when I was using a 256K-byte partition together with two 64K-byte partitions, no swapping was needed, and the change took about 2 seconds.

SoftLogic Solutions says that Software Carousel will run with most resident software, including SideKick and ProKey. I had no problems using Soft-

ware Carousel with a variety of commercial and public domain resident software. If you load these programs before running Software Carousel, they will be available in all partitions. On the other hand, if you load them from a particular partition, they will be available only in that partition.

**CONCLUSIONS**

Software Carousel has some limitations. It will not work with programs that boot directly without DOS (like Flight Simulator) or that use another DOS (like CP/M-86 or the p-System). Some software has limited compatibility with Software Carousel. For instance, programs that grab the keyboard like WordVision and Smartcom II will run in a partition, but since Software Carousel cannot receive the required key sequence to change partitions, you must first exit the program to do so. Communications software can be a problem, too. While you may be able to switch partitions from within your communications software, you probably won't be able to change while you are on-line without fouling up the communications link. I was able to do this only while the system I was connected to was at a prompt. If I changed partitions while data was moving in either direction on the communications link, or if line noise caused data to move, I could not resume communications when I returned to that partition.

Some other types of software can change graphic controller video modes without informing DOS. These programs will cause problems, too. Finally, Software Carousel does not work well with dual-display systems. If you change displays while going from one partition to another, you may have a problem when you return to the first display.

These limitations are minor, especially when compared to Software Carousel's benefits. Being able to, for instance, write in one partition, switch to another partition to run a BASIC benchmark, do some more writing, switch to a third partition to use a Lotus 1-2-3 spreadsheet, change again to go on-line with BIX to get some information, and return to my word processor is a marvelous timesaver. ■



# GORILLA EGA

Genoa makes your PC look better.

**Outselling the rest,  
because it's the best.**

Genoa Systems Corporation, the bold new leader of the PC Generation, brings you the Spectra-EGA. Genoa is a company that is built on technological innovation and engineering excellence.

Unlike the "Other Companies", Genoa controls its own future through continuous research and development.

Backed by a major multinational concern with vast assets in the billions. **GENOA IS HERE TO STAY!!**

Sales Offices in California, Texas, Georgia, & New York.

Key distributors in Europe.



Genoa Systems Corporation  
73 East Trimble Rd.  
San Jose, CA 95131  
(408) 945-9720  
FAX (408) 434-0997

Inquiry 142



# A LASER PRINTER SHARING UNIT WITH 256K BUFFER AND 8 USER INPUTS FOR UNDER \$800?



That's right! Now up to eight PCs, word processors, CAD systems, or whatever can share two printers automatically.

In addition to eight serial input ports, the PSU-81B gives you two output ports — one serial, one parallel — that can operate simultaneously.

You also get lots of other convenient features, including a pause button, clear button, memory test, TOF, and of course, a 256K dynamically allocated buffer.

So for under \$800, make your laser printer eight times more cost effective.

Check into our new PSU-81B, and other low-cost automatic printer sharing units, from the leaders in data communications technology.

Call or write WTI today for a complete catalog. In California, call (714) 979-0363. Telex 467741.

**800-854-7226**

**wte: western telematic inc.**  
2435 South Anne St., Santa Ana, California 92704



# PARADOX 1.1

BY RUSEL DEMARIA

## *This relational database has versatile features as well as a powerful script language*

Paradox, a relational database by Ansa Software, balances contradictory features: a powerful script language (the Paradox Application Language, or PAL) against automatic keystroke recording of scripts; and a complex relational data structure against the intuitive query by example, which I will explain later. Paradox uses 512K bytes of RAM in conjunction with virtual disk file management. It does not take advantage of expanded RAM cards (like Intel's Above Board), and it does not work with memory-resident programs.

### USING PARADOX

Initially Paradox seems rather familiar, with its Lotus 1-2-3-type command line (opened using the F10 Menu key) and tabular format (one record per row and one field per column). Creating a new database is also familiar. You simply name the fields and choose alphanumeric, numeric, integer, dollar, or date types. Some validity checking is automatic; for instance, numeric fields will not allow alphabetic entries. Later you can define additional validity checks for maximum or minimum values, default values, table lookups, or specific field masks. You can also format number and date fields in several ways.

Your first interaction with a file (which Paradox refers to as a table) will probably be the View option, which puts a table on the screen. After selecting this mode, you type the name of the table you want to see or press Return for a listing of available tables. You can use the cursor keys to highlight your selection. If you type the first letter of the desired table name, the listing automatically compresses to show all tables beginning with that letter. If there is only

one such table, the command executes. While you are viewing a table, its name heads the list when you perform other commands. You can view up to 16 overlapping tables at once, moving from one to another using the Up Image (F3) and Down Image (F4) keys.

Even after entering data, you can rearrange, redefine, insert, or delete fields and change key-field assignments. I found the edit mode to be versatile and easy to use, although I had to get used to the idiosyncrasies of Alt-F5, which puts you in character-edit mode, and Ctrl-Backspace, which clears a field for a new entry. If you define key fields, Paradox automatically sorts according to key order. You can also resort into a new table. If a table has no key field, you can sort it to virtually any depth. Paradox then lets you choose whether to sort to a new table or within the existing table. Because Paradox creates temporary files on disk during a sort, the speed of the sort depends on the type of disk drive you are using (see table 1).

### QUERY BY EXAMPLE

Query by example is the most significant feature of Paradox. It allows you to examine, modify, and filter data from multiple tables without using convoluted syntax-sensitive commands. Paradox performs simple queries with astonishing ease and intuition. Selecting Ask from the main menu and then selecting a table displays the query form for that table. The query form is similar to the nor-

mal tabular view. Field headings are at the top of each column with space beneath them for filling in selection criteria. To select information from several tables, you display a query form for each.

Entering find, insert, or delete in the leftmost column initiates these operations globally using the criteria you set. The insert command will take values from selected fields in one table and insert them into another (the add command is similar). The delete command will remove a selected set of records from a table. Deleted records are stored in a special table; therefore, you can back out of the operation by inserting the table of deleted records.

A simple query usually includes some fields selected to be displayed in the answer along with some selection criteria. Multiple table queries use what Paradox calls examples. These are temporary variables that link tables on a common field while expressing the relationship between the tables that you want displayed in the answer. An example does not really have to correspond in length or data type to its field. For instance, you could use a word as an example in a numeric field, or a number in an alphabetic field. After the example and other conditions of the query have been entered, Paradox writes and executes the program needed to answer the query. Other database programs require you to write the search program. Paradox not only writes it for you, but it also uses heuristic goal-reduction techniques to minimize the search time.

(continued)

Rusel DeMaria (443 Lilikoi Rd., Haiku, HI 96708) is a freelance writer and computer consultant.

**Paradox 1.1**

**Type**  
Relational database

**Company**  
Ansa Software  
1301 Shoreway Rd.  
Belmont, CA 94002  
(415) 595-4469

**Format:**  
Three 5¼-inch disks; not copy-protected

**Computer**  
IBM PC with at least 512K bytes of available memory; color or monochrome monitor; two floppy disk drives or one floppy disk drive and one hard disk drive

**Documentation**  
*User's Guide, PAL User's Guide, Introduction to Paradox, Quick Guides for Lotus and dBASE users*

**Price**  
\$695

You can select multiple criteria using AND, OR, EITHER...OR, or NOT operators. You do this by using examples and by placing criteria in the query forms. You can also use the powerful *changeto* command for altering values in a field. You can search for literal values, wild-card strings, or ranges. You can also use the *like* command to search for strings that are similar to the input criterion (useful when you aren't sure of a spelling, for instance). The *QuerySave* option creates an executable PAL script of the current query. You can use this script repeatedly either alone or within other PAL scripts.

You can create calculated fields from the query form. In fact, this is the only way to create a permanent calculated field. (A calculated field created on an input form does not become a permanent field in the table.) To recalculate a calculated field, you must run the query again.

A whole range of calculation and summary commands add power to queries but further complicate the query process. The more complex your queries become, the stronger your fundamental understanding of the uses of examples and checkmarks and their proper placement must be. For those willing to learn query by example thoroughly, however, Paradox can become a powerful and multifaceted tool.

**FORMS**

If you don't want a tabular listing of your file, you press the *Form Toggle* (F7) key. Paradox then displays a standard form, a simple listing of all fields, and allows you to define up to nine custom forms. Each form can be up to 15 screens long. You can use regular, display-only, and calculated fields, or a special record-number field. Display-only fields are useful for repeating field information on other pages. You can choose from an impressive list of mathematical, scientific, financial, and other functions to create calculated fields. One limitation, however, is that you cannot format calculated fields. For instance, if you are calculating a dollar amount, the amount will not display in dollar format. This is an annoying drawback.

You can also create borders using single- or double-lined boxes or any ASCII character. You can move fields or entire areas within the form, create different video display characteristics, and display or suppress field names.

A fairly simple definition process lets you create a special form for entering data into more than one table at a time. Pressing the *Do-It!* (F2) key posts the data in the appropriate tables. This added feature is very handy, but it is not without its limitations. Although you can determine where the data will go, you can't determine how it will be processed. For example, if you sold some products and needed to update an inventory file, you could do this only from within a PAL program (explained below), not from standard Paradox. Another missing feature is automatic table lookup, which is the ability to complete entries by entering data in one field. For instance, only a fairly convoluted PAL procedure can take a customer number and automatically fill in the name and address. Also, unlike the Paradox norm in which changes in a table automatically update associated files, changing a table associated with a multientry form invalidates the form; you must redefine it.

**REPORTS**

The Paradox report generator is potent but, like the queries, using it becomes more difficult as you attempt to release more of its power. You can generate an *Instant Report* at any time. This is a simple tabular print-out of the table you are working on. You can also custom-design reports that are up to 2000 characters wide. Paradox will separate these wide reports into separate pages for paste-up. You can even use Paradox for simple mail-merge and form-letter processing.

First-time database users may find the Paradox reports confusing. Paradox bands are similar to what some programs call partitions. The difference is that a partition simply defines a section of a report, while a band actually defines a concentric area, visually displayed on-screen,

(continued)

# PERFORMANCE

## THAT IS OUT OF THIS WORLD...



**\$389<sup>00</sup>**  
MODEL 2000 20MHz  
DUAL TRACE

**\$549<sup>00</sup>**  
MODEL 3500 35MHz  
DUAL TRACE DELAYED SWEEP

## ...AT A DOWN TO EARTH PRICE

At last! Truly affordable test equipment with no compromise in design, and features you would expect to find only on oscilloscopes costing hundreds of dollars more! JDR Instruments presents two, new, high-performance models backed by a two year warranty and technical support which is only a phone call away. Perfect for the technician or advanced hobbyist, both models feature Dual Trace capability and a variety of operating and triggering modes, including CH-B Subtract and X-Y operation.

MODEL 2000 has a 20 MHz bandwidth and 20 calibrated sweeps ranging from .2s to .2 $\mu$ s. A convenient built-in component tester provides additional diagnostic power.

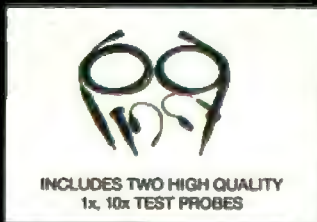

MODEL 3500 features a 35 MHz bandwidth and exceptional 1mV/DIV sensitivity. Delayed sweep and variable holdoff allow stable viewing of complex waveforms.

**ORDER TOLL FREE**  
**800-538-5000**  
**800-662-6279 (CA)**



### JDR INSTRUMENTS

1224 South Bascom Avenue  
San Jose, California 95128 (408) 995-5430

## The outer bands of a report control all the inner bands.

which may contain several other bands. One advantage of the band concept is that it allows any subdivision or partition to have its own header and footer. A disadvantage is that bands can become confusing with complex reports. The report band controls the header and footer information for the entire report. Other bands include the page, group, and table bands. The table band is at the center with all the others surrounding it. It defines fields and field headers. Surrounding the table band, the group bands control the sorting and grouping of the data in the table band. Since the band concept is concentric, group bands can contain up to 16 other group bands. The outer bands control all the inner bands.

You can create groupings for individual field values, ranges of field values, or a particular number of records. For instance, it would be easy to divide a sales report by date and subdivide it alphabetically by product. Another band could produce a space or other divider at regular intervals.

The sales report would contain three group bands: one for date, one for product, and one to control the divider.

The lower section of a band displays subtotals. In the example above, you could easily subtotal sales by date. You can also create summary fields to count records or to give statistical summaries of each group or of the whole report. You can create calculated fields anywhere on the report.

Many standard reports use the tabular setup, but you can design your own reports to write checks, fill in standardized forms, or do form letters. Paradox's free-form report feature lets you create variable-width fields so data can appear within text without distorting the results.

Paradox does not generate multi-table reports. The only way to create a report that contains data from multiple tables is to create a new table from a query. Still, the query process is fast and easy enough to be an effective alternative, unless you are short on disk space and don't have room for a new table.

Another problem with Paradox forms and reports is that each associates with only one table. Although you can borrow table structures when creating a new table, you can't do this when defining forms or reports. In-

(continued)

Table 1: Benchmark results. (Times are in seconds.)

|                           |             |       |
|---------------------------|-------------|-------|
| File load:                |             |       |
| Bernoulli Box (1.38)*     | 1.2,1.2,1.2 | (1.2) |
| Floppy disk drives (3.4)* | 1.5,1.7,1.7 | (1.6) |

\* First time file was loaded. Next three times are subsequent loads. Time in parentheses indicates average load time. (Paradox builds a special internal directory to locate tables as they are used, thus optimizing later retrievals.)

|                               |                |        |
|-------------------------------|----------------|--------|
| Sort test (within same file): |                |        |
| Bernoulli Box                 | 25.4,25.6,25.4 | (25.5) |
| Floppy disk drives            | 82.80,80       | (81)   |

|                                 |             |       |
|---------------------------------|-------------|-------|
| Find last record in table:      |             |       |
| Bernoulli Box (nonindexed)      | 22,23,23    | (23)  |
| Bernoulli Box (indexed)         | 3.6,3.5,3.6 | (3.6) |
| Floppy disk drives (nonindexed) | 104,104,105 | (104) |

(Home/End keys instantly find first and last record in present table.)

## Advanced Authorized Dealers (Eastern U.S.)

**Aardwolf Microsystems**  
217 East 85th, Suite 102  
New York, NY 10028  
212/538-7840

**Advanced Information Systems, Inc.**  
1336 Edna S.E.  
Grand Rapids, MI 49507  
616/243-1312

**Archive Systems, Inc.**  
1876 N.W. 2nd Ave.  
Boca Raton, FL 33431  
305/393-4602

**Corporate Micros, Inc.**  
333 West 52nd St., Suite 1204  
New York, NY 10019  
212/315-2853

**Crest Systems, Inc.**  
2101 Magnolia Ave., Suite 208  
Birmingham, AL 35205  
205/328-4882

**Fast Forward, Inc.**  
129 Adams Street  
Louisville, KY 40206  
502/589-0301

**ICS Software**  
P.O. C. 359015  
Brooklyn, NY 11235  
718/743-4050

**INACOMP Computer Centers**  
700 Flemington Road  
Schaumburg, IL 60195  
312/519-1900

**Micro City Computers**  
110 West 31st Street  
New York, NY 10001  
212/563-6110

**Mitech Corporation**  
#1 Perimeter Park South, Suite 335-S  
Birmingham, AL 35243  
205/967-0605

**Modular Management Systems, Inc.**  
451 Bloomfield Ave.  
Caldwell, NJ 07006  
201/228-3838

**National AI Lab, Inc.**  
1800 Century Blvd., Suite 770  
Atlanta, GA 30345  
404/633-3900

**Network Data Systems, Inc.**  
3419 Pierson Place  
Flushing, MI 48433  
313/732-6340

**PC Connection, Int'l. Inc.**  
8709 S.W. 132 Street  
Miami, FL 33178  
305/235-8966

**PRISM Computer & Consulting  
Services, Inc.**  
2100 Riverchase Center, Suite 420  
Birmingham, AL 35244  
205/988-5111

**Don Sivitz & Associates**  
435 Dayton Street  
Cincinnati, OH 45214  
513/421-1105

**Southeastern Systems, Inc.**  
619 East Price Ave., Suite #12  
Gastonia, NC 28054  
704/866-8048

**TENMAST SOFTWARE SYSTEMS**  
1015 Richmond Road  
Lexington, KY 40502  
606/268-0995

**TRIMARC Systems, Inc.**  
11716 Parklawn Drive  
Rockville, MD 20852  
301/231-4991

**Open Computer Systems**  
4701 N.W. 72nd Avenue  
Miami, FL 33166  
305/594-2980



# To Over 30,000 Installations, MultiLink® **MEANS** Multi-User.

At over 30,000 sites, as many as one-quarter of a million users tap into the power of MultiLink® Advanced everyday.

Since 1981, they've come to rely on our multi-tasking, multi-user system for compatibility with their favorite software, and the ability to share disks, files, printers, and programs in a *true* PC-DOS environment.

From the largest of the Fortune 500 to the smallest in small business, MultiLink® has provided a cost-effective multi-user solution that's available from no one else.

**MultiLink® Means Cost-Effective Timesharing on a PC.** MultiLink® Advanced utilizes the principle of timesharing by sharing a central PC's peripherals, files, and processor time among nine users. Up to eight inexpensive terminals can be connected to a single non-dedicated IBM PC, XT, AT or 100% compatible using standard RS-232 ports. Each terminal effectively emulates a PC having up to 512K RAM.

PC-Shadow® Workstations, shown below, even have an AT look-alike, as well as work-alike, keyboard, display, and serial port. In addition, password-protected remote access via modem can be made with either dumb terminals or PCs running our terminal emulation software.

**MultiLink® Means PC-DOS Compatibility with a Software-Driven System.** Lotus 1-2-3, Symphony, WordStar, dBASE III, & Multimate are just a sampling of the wide variety of PC-DOS software that's fully compatible.

Our software-driven system is also IBM NETBIOS compatible, so programs that are written for IBM's Token Ring will run on our multi-user system, as well.

**MultiLink® Means Multi-User to Leading Computer Publications.** Whether you read *PC Magazine*, "MultiLink® Advanced delivers on...convenience, speed, and flexibility," or *InfoWorld*, "If you want a low-cost multiuser system with up to eight terminals, MultiLink® Advanced is worth a serious look," it becomes clear that MultiLink® Advanced is a formidable contender in the multi-user marketplace.

**See What MultiLink® Can Mean to You.** Learn, firsthand, how our multi-user system can benefit your company. Call The Software Link TODAY for complete information and the authorized dealer nearest you. MultiLink® Advanced is \$495 and comes with a money-back guarantee.

## MultiLink® ADVANCED



THE SOFTWARE LINK, INC.

8601 Dunwoody Place, Suite 632, Atlanta, GA 30338 Telex 4996147 SWLINK

CALL: 404/998-0700

Dealer Inquiries Invited

THE SOFTWARE LINK, INC./CANADA

250 Cochrane Drive, Suite 12 Markham, Ontario L3R 6B7  
CALL: 416/477-5480

Inquiry 317



MultiLink® is a registered trademark of The Software Link, Inc. MultiLink® Advanced PC-Shadow® are trademarks of The Software Link, Inc. IBM PC, XT, AT, PC-DOS, Token Ring, & NETBIOS are trademarks of IBM Corp. WordStar, dBASE III, Multimate, Lotus 1-2-3 & Symphony are trademarks of Lotus Development Corp. Ashton-Tate, Multimate International are trademarks of Lotus Development Corp., respectively.



123

System Disk

Lotus

## THE APPLICATION GENERATOR AND RUNTIME MODULE

**P**aradox is already an excellent database, but Ansa continues to improve and augment it. The newest additions to Paradox are the Application Generator (ApGen) and the Runtime module.

ApGen is an elaborate PAL script designed to create well-structured code. The whole program is menu-driven and easy to follow. Using ApGen, you can create Paradox menus and submenus up to 10 levels deep with up to 15 selections per menu and 15 tables per application. By choosing combinations of tables and scripts, you can design sophisticated Paradox environments. The resulting scripts are not only efficiently coded for you, but many standard error-trapping routines are automatically included. For instance, whenever you design a report to go to a printer, code is automatically included to warn the user if the printer is not ready to print.

There are a few limitations to ApGen. Its applications contain many individual files, including scripts, databases, and forms, all of which must be in the same subdirectory as the ApGen files. The manual recommends that you

use a separate subdirectory for each application. Although ApGen automatically creates a script to copy the application to a different disk or directory, file management would have been easier if ApGen had been able to consolidate some of these files.

Although you can use PAL to modify any script you create with ApGen, these modifications will be lost if you use ApGen to modify the application. In addition, you can't use the table view from within ApGen, although you can add scripts or hard-coded routines that do. When editing records in multi-table environments, the tables must contain key fields. Finally, you must have at least 1.8 megabytes of available memory on a hard disk to install ApGen, and at least 640K bytes of RAM to run it.

ApGen is easy to use; you create and select tables just as you would with Paradox. You can design reports and forms or borrow them from existing examples. You can also create selection criteria using familiar query forms and design customized help screens.

ApGen runs much slower than Paradox, perhaps because it is a PAL script

and not a compiled program. Despite its sluggish responses, the program is useful, especially for nonprogrammers who would never be able to put together a sophisticated application without this kind of help. Systems developers will find that ApGen saves them a lot of time when coding applications, and it creates an excellent framework from which they can further customize their efforts.

After you finish creating an application, you can use Paradox Runtime to run it, even without Paradox installed. Ansa will supply this run-time package for only \$9.95.

There are very few limitations to the Paradox Runtime package. Basically, it can run any Paradox script or application. Typing `PDOXRUN <filename>` is all that is necessary to run an application. The Runtime files are quite large and fill the better part of two floppy disks; therefore, Runtime would be most useful in a hard disk environment. However, Runtime will run Paradox scripts and applications but not the main body of the Paradox program.

About all that is missing now is a Paradox compiler.

stead, you must make a macro script out of the definition process itself.

### PAL

PAL (the Paradox Application Language) is a powerful programming language that contains a full set of mathematical, statistical, transcendental, and financial functions. It is easy to create a PAL script with the full-screen editor provided with Paradox. In addition to having a syntax that should be sufficiently familiar to dBASE and R:base programmers, PAL offers sophisticated menu generation, password protection, definable procedures and procedure libraries, and an array structure that can capture entire Paradox records, even when the data types are inconsistent. PAL also has a debug mode that is activated automatically when a script fails to run properly.

I found that I had to program with

PAL to accomplish some of my goals with Paradox, but most users will not need to do much programming. If you want to use PAL, you can record keystroke macros and then read them into your PAL script. This saves having to learn the whole language, and examining recorded macros can help you to understand the PAL syntax.

### SUMMARY

Paradox has several other strong points, including an incremental Undo feature; exit to DOS (DOS shell); fast import and export to and from ASCII, Lotus 1-2-3, Symphony, dBASE II and III, pfs:File, and DIF formats; keystroke macros; and convenient date, arithmetic, and string handling.

For the most part, Paradox lives up to Ansa's claims of easy-to-use power, although it can become difficult as its operations become more complex. Paradox rivals programs like dBASE

and R:base and may even be more suitable for many database projects. Within its self-imposed limitations, Paradox offers tremendous power, and a little dabbling with PAL can produce wonderful results. With the addition of Ansa's \$9.95 Runtime module, Paradox can become a program for turnkey system design at a reasonable cost (see the text box "The Application Generator and Runtime Module" above).

Learning Paradox is not an effortless process, but the manuals are informative and the help screens are adequate. Especially pleasing are the short manuals that are included to get Lotus 1-2-3 users and dBASE users up to speed quickly.

I was impressed with the versatility and forgiving nature of the program. For intense but intuitive relational data processing, Paradox performs very well indeed. ■





# C FEVER *catch it!*

It's becoming an epidemic . . . everyone is switching to C! First there were a few hackers, then came the college students, next the major software houses, and now the rest of the programming world. Programmers everywhere are infected with the desire for SPEED, POWER, and PORTABILITY.

It's time to face the inevitable. You're going to catch the fever too! When you do, give us a call. We've got the best cure — an illustrated guide to the C language, plus a complete program development system. Everything you need to master the C programming language . . . all at a price that's less than the cost of a book!

But don't let this price fool you. Our system is powerful; it compiles twice as fast as the others, is completely standard, and it's very easy to use. Most C compilers are designed for wizards. We have designed ours for you!

**What do you get for a mere \$39.95?**

- A 450 Page book filled with sample programs, plus . . .
- A fast, standard, full featured C compiler that supports all data types and the latest features like bit fields, enumerations, structure assignment, and passing/returning structures.
- A fast linker that loads separately compiled files, searches libraries, and builds an executable program.
- An extensive library of more than 170 functions (including the standard C functions and the computer specific functions that provide direct access to the operating system and BIOS).
- Tools that allow you to optimize your programs for minimal space or maximum speed.

**Works on all MSDOS/PCDOS and all CP/M Z80 COMPUTERS! (Not Copy Protected!)**

*The Powerful Mix*  
**C COMPILER**  
*Harness the Power of the C Language with this full featured Compiler*

**Incredible Value**  
**\$39.95**  
AT ONLY **With 30 Day**  
**Money-Back Guarantee**

**Operators are standing by . . . Please use this Number for ORDERS ONLY!**  
**CALL TOLL FREE FOR RUSH ORDER DELIVERY!**

# 1-800-523-9520

**IN TEXAS, PLEASE CALL TOLL FREE 1-800-622-4070**

For Technical Support Please call 1-214-783-6001

MIX Software, Inc / 2116 E. Arapaho / Suite 363 / Richardson, Texas 75081

**Or contact our Worldwide Distributors direct in:**

Canada: Saragway Software 1-416-923-1500 Switzerland: DMB Communication CH-1-825-53-29  
Australia: Techflow 047-586924 France: Info/Tech 1-43-44-06-48

## Split Screen Text Editor

**an Incredible Value \$29.95**  
AT ONLY (Not Copy Protected! Works on all MSDOS/PCDOS and CP/M Z80 Computers)

Our high powered editor is great for editing high level languages. It works just like Micropro's Wordstar<sup>SM</sup> but macros allow you to create your own custom editor, and the split-screen feature lets you edit two files at the same time.



**The MSDOS/PCDOS version is loaded with special features:**

- Execute any DOS command or RUN other programs from the editor.
- Quickly edit files as large as 300,000 characters.
- Compile MIX C programs directly from memory. The editor automatically positions the cursor to the first error in your program.



**ASM UTILITY**  
**an Incredible Value \$10**  
AT ONLY

Call assembly language routines from your C programs. The ASM utility works with Microsoft's MASM or M80 assembler. Macros make it easy! Works just as if you were calling a C function, and you can even call C functions from assembly language. Lots of useful assembly language functions are included as examples.

## RUSH REPLY ORDER FORM!

**Please check method of payment:**

Check  Money Order  MasterCard/VISA  
Your Card #: \_\_\_\_\_

Expires \_\_\_\_\_

**Shipping Charges:** (No charge for ASM Utility)

**In the U.S.A.:** Add \$5.00 per Order.

**In CANADA:** Add \$10.00 per Order.

**OVERSEAS:** Add \$10.00 per Text Editor.

Add \$20.00 per C Compiler. Add \$30.00 for combined C Compiler and Text Editor.

**Operating System: (Check one)**

CP/M Z80  MSDOS/PCDOS

Specify Your Computer Name \_\_\_\_\_

Specify Disk Format \_\_\_\_\_

NAME \_\_\_\_\_

Telephone A/C (\_\_\_\_\_) \_\_\_\_\_

Street \_\_\_\_\_

City \_\_\_\_\_

State \_\_\_\_\_

Country \_\_\_\_\_ ZIP \_\_\_\_\_

**MIX software** 2116 East Arapaho Suite 363 Richardson, Texas, 75081

**Ask about our Volume Discounts!**  
Call 1-214-783-6001

| Description                          | Quantity | PRICE   | Total Order |
|--------------------------------------|----------|---------|-------------|
| Split-Screen Text Editor             | _____    | \$29.95 | \$_____     |
| C Compiler                           | _____    | \$39.95 | \$_____     |
| C and Text Editor (Special)          | _____    | \$54.95 | \$_____     |
| ASM Utility                          | _____    | \$10.00 | \$_____     |
| Texas Residents Add 6.125% Sales TAX |          | \$_____ | \$_____     |
| Shipping Charges (See at Right)      |          | \$_____ | \$_____     |
| <b>TOTAL OF YOUR ORDER:</b>          |          | \$_____ | \$_____     |



## QNX: With any other OS, your personal computer is asleep at the switch.

If real-time performance is the key to the next generation of small systems, task-switching is the key to real-time performance.

QNX task-switching has been measured using standard Intel benchmarks. Here are the results:

| OS     | Computer  | Processor  | Task Switches/Sec |
|--------|-----------|------------|-------------------|
| QNX™   | IBMAT     | 8Mhz 80286 | 2800              |
| QNX™   | IBM PC    | 5Mhz 8088  | 787               |
| XENIX™ | Intel-286 | 5Mhz 80286 | 203               |
| UNIX™  | CODATA    | 8Mhz 68000 | 187               |
| XENIX™ | ALTOS     | 5Mhz 8086  | 96                |
| UNIX™  | FORTUNE   | 6Mhz 68000 | 95                |

The margin by which QNX outperforms UNIX-based systems is not accidental. QNX architecture is unique among multi-tasking small computer operating systems because it is modular, not monolithic. On the PC, this distinction is decisive: UNIX system overhead and processing demands sap any computer smaller than an AT.

Because QNX was developed specifically for smaller computers, not "kluged" from an OS written for larger computers, its structural advantages are apparent. QNX was the first multi-tasking, multi-user OS for the IBM PC (1982), the first again for the AT (1984) and the first networking OS for the PC and the AT (1984). For the foreseeable future,

QNX will remain the only real-time multi-user, multi-tasking OS for the PC, the AT and compatibles.

As a networking OS, only QNX provides integrated performance at the fundamental level of inter-task communications. The tasks need not be on the same machine: the messaging is network-wide.

A task responsible for handling an A/D converter on one machine can provide data and accept requests from tasks on any other machine. For this reason only QNX can

implement true distributed processing, distributed file systems and distributed devices, with no need for a central file server.

Since QNX is modular, programmers can easily adapt and enhance the OS itself by adding their own system task. PC-DOS 2.1 or 3.1™ can run as one of QNX's many tasks.

With over 20,000 QNX systems installed worldwide, QNX is the undisputed standard for real-time microprocessor applications.

|                        |                                                                                                                              |                    |                                                                                                                                                   |
|------------------------|------------------------------------------------------------------------------------------------------------------------------|--------------------|---------------------------------------------------------------------------------------------------------------------------------------------------|
| <b>Multi-User</b>      | 10 serial terminals per PC, AT.                                                                                              | <b>C Compiler</b>  | Standard Kernighan and Ritchie.                                                                                                                   |
| <b>Multi-Tasking</b>   | 40 (64) tasks per PC (AT).                                                                                                   | <b>Flexibility</b> | Single PC, networked PC's, Single PC with terminals, Networked PC's with terminals. No central servers. Full sharing of disks, devices and CPU's. |
| <b>Networking</b>      | 2.5 Megabit token ring.<br>255 PC's and/or AT's per network.<br>10,000 tasks per network.<br>Thousands of users per network. | <b>PC-DOS</b>      | PC-DOS runs as a QNX task.                                                                                                                        |
| <b>Real Time</b>       | 2800 task switches/sec (AT).                                                                                                 | <b>Cost</b>        | From US \$450.<br>Runtime pricing available.                                                                                                      |
| <b>Message Passing</b> | Fast intertask communication between tasks on any machine.                                                                   |                    |                                                                                                                                                   |

For further information or a free demonstration diskette, please telephone (613) 726-1893.

The only multi-user, multi-tasking networking operating system

**QNX** for the IBM PC, AT and compatibles.  
By Quantum.

XENIX is a registered trademark of the Microsoft Corporation. Unix is a registered trademark of AT&T Bell Labs. IBM PC, AT, XT and PC DOS are trademarks of IBM Corp.

Quantum Software Systems Ltd., Moodie Drive High Tech Park, 215 Stafford Road, Unit 104, Ottawa, Ontario, Canada K2H 9C1

# WORDPERFECT 4.1

BY RICARDO BIRMELE

## *A word processor with a thesaurus, a dictionary, and many editing tools*

This latest version of WordPerfect from WordPerfect Corporation is an improvement over version 3.0, which I reviewed in the December 1984 BYTE. While it retains many of the useful features of its previous versions, WordPerfect 4.1 has many new and impressive features.

### **IMPROVED FEATURES**

A number of WordPerfect's old features have been improved. The block command highlights the text contained within a block to be moved; remembering what is included within the block is no longer necessary. Previous versions of WordPerfect let you work on two documents at a time and move text between them, but they required you to go through menus. Now switching between two documents is accomplished by pressing a dedicated key, making the operation much faster.

Now you also have the choice of having two documents appear on two different screens, or as two windows on one screen.

If you need to switch to another program, you can do so by exiting to DOS from within WordPerfect. You can then run the other program, leave it, and return to your place in WordPerfect by typing EXIT.

Footnotes can still occupy the traditional bottom of the page, or you can put them at the end of a document. Notes can be up to 16,000 lines (approximately 300 pages) long. They can be numbered in sequence (with WordPerfect keeping track of the numbers as you insert or delete other notes) or marked by asterisks or number signs.

WordPerfect protects you from your errors better than before. For instance, a big help in error protection is the

Undelete feature. A group of characters that you erase before moving the cursor is saved to a buffer. From there the characters can be recalled with two keystrokes. This also provides a shortcut for cutting and pasting small amounts of text.

Directory listings are still alphabetized, but WordPerfect now has a number of added features. For instance, you can look at a file's contents without having to actually load the file. You can also search through the files within the directory for a word or word pattern.

An undocumented feature of the directory is the ability to batch-print or batch-delete. If you have a number of files that you want deleted or printed, you simply move the cursor to highlight the name of each file and press the asterisk key. Then you enter a command to either delete or print, and WordPerfect will do it all at once.

### **SPELLING DICTIONARY**

WordPerfect's spelling dictionary now has 100,000 words (without taking up more disk space than the smaller old dictionary), and it has room for you to add about 10,000 words of your own. The dictionary includes some common legal and medical terms, which will be a bonus for some business users.

The dictionary works by comparing the document on your screen with three lists of correctly spelled words. The first list contains common words that are in the main spelling file. If a word is not found there, the dictionary

goes to the second list, which contains less common words that are also in the main spelling file. Finally, the dictionary checks with the third list, which contains words that you have entered in the dictionary yourself.

One of the most difficult errors to find in a document on a computer screen is the same word inadvertently typed twice. WordPerfect's dictionary looks for this kind of error while it checks for correct spelling.

If the dictionary finds a misspelled word, you can have it automatically corrected by selecting it from a list of numbered words on your screen. You can also use the dictionary to look up words that you are not sure of by pattern matching (for instance, checking all words beginning with *ind*) or by phonetic spelling. WordPerfect also includes a utility, SPELL.EXE, which allows you to easily manipulate any part of the dictionary.

After the dictionary is finished proofing your text, it tells you how many words the document contains. If you simply want a quick word count while you are still writing, one keystroke when you are in WordPerfect's dictionary mode will give it to you.

### **EDITING TOOLS**

WordPerfect has an outlining facility that you can use as an outline processor. It will also automatically number paragraphs or whole sections of text.

One error that many beginners make is not saving their work. WordPerfect 4.1 helps out by automatically saving your work into a special file if you choose. You can set up this facility

*(continued)*

Ricardo Birmele (P.O. Box 1166, Bothell, WA 98041) is president of The Cantilever Group.

**WordPerfect 4.1**

**Type**

Word processor

**Company**

WordPerfect Corporation  
266 West Center St.  
Orem, UT 84057  
(800) 321-4566

**Format**

Five 5¼-inch disks

**Computer**

IBM PC, XT, or AT with at least 256K bytes of memory; color or monochrome monitor; two floppy disk drives or one floppy disk drive and one hard disk drive

**Documentation**

User's manual

**Price**

\$495

ty as a default or when you first start the program.

WordPerfect lets you create tables of contents and indexes almost automatically. You simply indicate that you want a particular word or phrase from the text included in them. WordPerfect will also keep track of individual items to be incorporated into the table of contents or index while you modify a document's text.

Two other useful editing tools are the new Redline and Strikeout features. With Strikeout, you can mark text that you may want to delete later by having a dash overwritten on each letter. Redline text—text that is added, but you aren't sure you want to keep in—is marked by a vertical bar to its left. Both Strikeout and Redline text can be deleted automatically before a final printout.

WordPerfect also has a thesaurus that will look up a word you specify and provide you with choices for its replacement. You can also scroll through successive lists of words until you find the word you want.

**MERGE FACILITY**

WordPerfect 4.1's merge facility is second to none. It will do the usual merging of mailing lists and boilerplate letters, but it also allows input from the console during a merge. In addition, WordPerfect can pick up the date from your computer's system calendar and insert it automatically into your text.

**ADDITIONAL FEATURES**

WordPerfect's programmers have gone out of their way to make word

processing simple by anticipating the way users work. For example, when you press F3-Help, you have two choices: You can press any function key to get an explanation of what that key does, or you can press any letter key to get an alphabetical index. This index lists WordPerfect's features, the key that executes each feature, and the name that WordPerfect calls each key. Because Help is so easy to use, this program becomes almost second nature very quickly.

WordPerfect 4.1 has a new version of the PRINTER.EXE utility, which lets you drive almost any printer. If your printer doesn't appear on the list, you can define it in exhaustive detail by going through a simple fill-in-the-blanks process. You can use any of the 194 already defined printer patterns, or you can modify the installation of any included printer. The process is very easy to complete.

A Convert utility allows you to transform WordStar files to ASCII files. This utility also lets you interface data between WordPerfect and database programs. I used it to insert data generated from a Reflex database into a text file with no difficulty.

**DOCUMENTATION**

WordPerfect 4.1's documentation is divided logically into step-by-step tutorial and reference chapters. The more involved functions, like mail merge, math functions (which are much like a spreadsheet), and special features, are discussed in separate chapters. Each of the program's commands is clearly explained with an illustration color-coded to the keyboard template.

**CONCLUSION**

Usually, updates to established programs are simple bug fixes or rehashes of the previous versions. This is not the case with WordPerfect 4.1. It retains all the good points of its earlier versions, especially things like its clean screens and fast response to keyboard input (see the benchmark results in table 1). In addition, WordPerfect's capabilities have been increased. It will do anything you can reasonably require a word processor to do. ■

Table 1: Benchmark results (in seconds).

|                     | WordPerfect 4.1 | WordStar 3.3 | Microsoft Word 3.0 |
|---------------------|-----------------|--------------|--------------------|
| Program load        | 12.8            | 9.5          | 24.3               |
| Load 4000-word file | 4.2             | 4.2          | 5.7                |
| Save 4000-word file | 15.6            | 26.7         | 30.0*              |
| Cursor through file | 75.7            | 48.6         | 90.1               |
| 4000-word search    | 8.7             | 12.5         | 18.2               |
| 400 replacements    | 12.8            | 25.3         | 85.7               |

\*average time using MS-DOS 3.1



# THE GREAT ESCAPE!

**FROM IVORY TOWERS AND  
COLD COMPUTER ROOMS TO  
THE WARMTH OF YOUR OFFICE.**

**Artificial intelligence for business  
has arrived in a revolutionary new  
product . . . Guru.**

At last, artificial intelligence designed especially for business! Guru brings together expert system capabilities of artificial intelligence, the productivity of familiar business computing tools and the ease of communicating with your computer using menus, commands or plain English. All available in a single, integrated program.

Guru works like human experts, considering uncertainties, reasoning through forward and backward chaining, asking for more information when needed, and explaining its recommendations.

Guru's expert system works hand-in-hand with all the familiar business computing tools like spreadsheets, statistical analysis, business graphics and a programming language, always available for both expert consultation and your everyday business computing needs.

Best of all, you won't need to learn LISP or PROLOG or buy fancy computers . . . Guru runs on your PC and communicates in plain English! Guru is artificial intelligence that means business.

For more information, call or write Micro Data Base Systems, Inc./Marketing & Sales, P.O. Box 248, Lafayette, IN, 47902, 317/463-2581, Telex 209147 ISE UR.

# GURU™

ARTIFICIAL INTELLIGENCE THAT MEANS BUSINESS.



# 50

# 7

## What if...

**YOU COULD SAVE A BIG FIFTY DOLLARS ON THE NEW QUIETJET PLUS PRINTER?**

If your old printer is beginning to sound like an industrial chain saw, you should give a listen to the new QuietJet Plus printer from Hewlett-Packard. It gives you quiet operation and superb printing quality at a very affordable price. And for a limited time, you can get a \$50 rebate on any QuietJet Plus you buy.

Just visit your HP dealer for a QuietJet Plus demonstration. You'll see its near letter perfect printing quality. And how its wide carriage lets you print a wide range of documents, from short memos to long spreadsheets. You'll hear—or *almost* hear—how incredibly quiet it is. So quiet that you can carry on a normal telephone conversation without being disturbed.

The QuietJet Plus represents the kind of business computing innovations you've come to expect from the company that never stops asking, "What if...?"

So if your printer is breaking the sound barrier, just call 1800 367-4772, Dept. 276C for the Hewlett-Packard dealer nearest you.



**HEWLETT  
PACKARD**

*Business Computing Systems*

Offer expires 9/30/86. Rebate available when submitted with proof of purchase and official form available at participating dealers and from HP sales reps. Void where taxed, restricted or forbidden by law. © 1986 Hewlett-Packard Company PG6038T9

Inquiry 161

## EXPEROPS5

"ExperOPS5" by William Jacobs (July) references the OPS5+ product and indicates that it is owned by Artelligence Inc. This is incorrect. OPS5+ is the exclusive property of Computer Thought Corporation.

GLENN CARTER  
Plano, TX

*Computer Thought (1721 West Plano Parkway, Suite 125, Plano, TX 75075) now owns OPS5+ following a legal settlement with Artelligence Inc. Version 3.0 sells for \$1850.*

Jon Edwards  
Senior Technical Editor, Reviews

## PANASONIC EXEC. PARTNER

Having purchased a Panasonic Exec. Partner, I was quite interested in the review (April). My impression of the machine roughly parallels Rich Malloy's. However, I have a few observations to add.

The Exec. Partner is a "quickie" design by Panasonic to put its plasma display technology to consumer use. The system ROM and BIOS seem to be taken directly from the Sr. Partner, and the motherboard looks very similar to the one inside the Sr. Partner as well. Since the 8086 is in a socket, I tried for a performance upgrade with a NEC V30 chip. However, it didn't work. I continually got a PIT (programmable interface timer) fault message with more than one chip. I heard there is a "mystery" component on the motherboard that needs to be changed, but I was unable to find the needed information, and I had my 8086 reinstalled.

I agree with the author that the internal printer is of marginal use. Still, from a convenience point of view, no one can argue with having a printer built into a machine. If the printer could be induced to use regular bond or tractor-feed paper, it would be much more useful.

If a printer that uses normal paper cannot be adapted to the machine, Panasonic should get rid of it. Then there would be room for three full-length IBM expansion slots or six half-size cards. With all the half-size expansion cards that are emerging, there would be plenty of room for customizing the machine.

The long memory check on power-up is

annoying, but I think it could be bypassed with a proper setting on the motherboard DIP switch. I find that Peter Norton's SI utility gives some strange readings every now and then. This may be related to the difficulties the author had running SideKick. However, I have experienced no such problems with SideKick.

The annoying habits of the display are more of a system ROM problem than a hardware problem. However, Panasonic has demonstrated a full-color version of its plasma screen. Add an EGA chip set and you have a very impressive machine.

CHARLES KUHLMAN  
Berlin, West Germany

## AT&T UNIX PC

As a current user and programmer of a UNIX PC, I noticed a few mistakes in the review of the AT&T UNIX PC by Alastair J. W. Mayer (May). The article is based on the old UNIX operating system (version 2.0), which is slower than the current version 3.0 (if you have 2.0, AT&T will give you a free upgrade to 3.0). An example of the higher speed of the current version is the resizing of windows, which the author stated took 2 seconds with 2.0. It now takes under 1 second with 3.0.

The motherboard is available with 512K bytes or 1 or 2 megabytes of RAM. A memory-expansion card with up to 2 megabytes of RAM can be added, which brings the system up to 4 megabytes. Currently, 20-megabyte, 40-megabyte, and 67-megabyte hard disk drives are available. A point worth noting is that all hard disk drive and floppy disk drive accesses are done through direct memory access; thus, the microprocessor will not be slowed down.

The UNIX PC can read MS-DOS files as stated in the review, but it can also run most MS-DOS applications with the use of the DOS-73 expansion card. This card contains an Intel 8086 processor as well as the ability to support the 8087 math coprocessor. The card also allows you to maintain full multiprocessing.

The author said there was a need for a graphics package to create device-independent graphics. This is already available with an industry-standard GSS-Toolkit.

A point that was not mentioned was that

the PC is well suited for a multiuser environment. AT&T recommends that five users can be added, although up to nine can be connected.

Additional software is available that was not listed in the review, including dBASE III, Multiplan, WordStar 2000, Smart, File-it, 3270 SNA Emulator, GSS-Chart, FORTRAN, COBOL, BASIC, and more.

DOUGLAS J. GARDNER  
Adelphi, MD

*Editor's note: For information on upgrading from version 2.0 to version 3.0, call the AT&T UNIX PC software upgrade coordinator at (900) 432-6600.*

## ITT XTRA XP

I found the review of the ITT XTRA XP by John D. Unger (July) very well done and informative, although there is one statement that I hope you can expand upon.

The sentence states, "The ITT XTRA XP is essentially a hardware upgrade of the IBM PC XT." Is this correct, or should it say "hardware upgrade of the ITT XTRA?" What are the hardware differences between the ITT XTRA and the XTRA XP?

ROBERT A. MARGADONNA  
Sea Bright, NJ

*The main difference between the ITT XTRA and the ITT XTRA XP is their central processors. The XTRA XP uses an 80286 CPU the same processor as the IBM PC AT, whereas the ITT XTRA uses an 8088 CPU like the IBM PC and PC XT. However, the rest of the XP is designed to be compatible with the IBM PC or PC XT rather than with the PC AT. The 80286 enables the XP to run IBM PC or XT software faster than the ITT XTRA and the IBM PC or PC XT. The net result is that both the XTRA and the XTRA XP are compatible with the IBM PC XT, but because of its CPU and memory design, the XP can run programs much faster than the standard ITT XTRA.*

—John D. Unger

REVIEW FEEDBACK is a column of readers' letters. We welcome responses that support or challenge BYTE reviews. Send letters to Review Feedback, BYTE, One Phoenix Mill Lane, Peterborough, NH 03458. Name and address must be on all letters.

**Smart.  
Power and  
friendliness for  
custom  
applications.**



# The difference is power.

If there's one thing dBase users have learned — the hard way — it's that there's a huge difference between *power* and *usable power*.

Which, in a nutshell, is the difference between dBase III Plus and The Smart

Data Base Manager.

Both are full-featured, multiuser data bases. But Smart is much easier to learn, easier to use, and easier to program. Not to mention faster and more functional.

That's not just our opinion. In March,

*Software Digest*

ranked Smart as the Most Powerful among all 15 leading relational data bases. Smart also topped dBase III Plus in tests of speed, versatility, error handling, and ease of learning.

Custom applica-





**The difference is more than power.**

|                                                     | Smart Data Base | dBase III Plus |
|-----------------------------------------------------|-----------------|----------------|
| • Revisable Applications                            | Yes             | No             |
| • Multi-table Access                                | Yes             | No             |
| • Nested Menus                                      | Yes             | No             |
| • Custom Reports                                    | Yes             | No             |
| • Automatic Protection Against LAN "Deadly Embrace" | Yes             | No             |
| • Built-in Communications                           | Yes             | No             |
| • Not Copy Protected                                | Yes             | No             |
| <b>List Prices:</b>                                 |                 |                |
| single-user                                         | \$ 495          | \$ 695         |
| 4 user-LAN                                          | 1,290           | 1,690          |
| 10 user-LAN                                         | 3,060           | 3,680          |

**Ask for a Smart Demo-Pack.**

Now for just \$19.95, you can experience the complete Smart System on your single-user PC or LAN workstations.

The Demo-Pack includes all of Smart's powerful features, along with a complete set of disk tutorials. To order, just call toll-free 800-438-7627 and ask for Dept. BD (in Canada or Kansas call 913-492-3800).

Once you see the difference, you'll get Smart.

tions are painless with Smart. Its built-in programming language relies on simple English commands.

A powerful "Remember" feature lets anyone, even non-programmers, reduce long-winded routines to a single keystroke.

Smart also includes built-in asynchronous communications, cus-

tom menus, password protection, and a time-saving "Browse" mode.

There *are* two ways you could make Smart more powerful than it already is: (1) by adding it to any number of workstations on a local area network, and; (2) by integrating it with *The Smart Spreadsheet*, and *Smart Word Processor*.



**The Smart Data Base Manager**

© 1986 Innovative Software, Inc.

Inquiry 171



A. D. K. W.

# Kernel

---

|                                                                                                      |     |
|------------------------------------------------------------------------------------------------------|-----|
| <b>COMPUTING AT CHAOS MANOR:<br/>A BUSY DAY</b><br><i>by Jerry Pournelle</i> .....                   | 321 |
| <b>ACCORDING TO WEBSTER:<br/>TWO FINE PRODUCTS</b><br><i>by Bruce Webster</i> .....                  | 335 |
| <b>BYTE JAPAN:<br/>PERSPECTIVES ON HARDWARE AND<br/>SOFTWARE</b><br><i>by William M. Raike</i> ..... | 351 |
| <b>BYTE U.K.:<br/>TURBOCHARGING MANDELBROT</b><br><i>by Dick Pountain</i> .....                      | 359 |
| <b>APPLICATIONS ONLY:<br/>SING YE MACPRAISES</b><br><i>by Ezra Shapiro</i> .....                     | 367 |

---

IN HIS POEM "EPITHALAMION," Edmund Spenser includes the following line: "Ah! when will this long weary day have end." Jerry Pournelle was probably ready to utter this on the day he describes in his article, a day that was typical of his heavily traveled month. In between his peregrinations, he did have a day at home. Of course, you say, a day to rest and see his family. No such luck. Numerous things to accomplish made for an exhausting day—but he did get everything done. This column also covers what Jerry found of interest at the Spring COMDEX in Atlanta.

The title of According to Webster refers to Bruce's *two* products of the month: Turbo Prolog from Borland International and LightspeedC from Think Technologies. Bruce is impressed with Turbo Prolog, a development system for the IBM PC and compatible machines. He believes it is Borland's best product since Turbo Pascal. LightspeedC, a development environment for the Macintosh, goes a long way toward making C Bruce's language of choice on the Mac. Bruce also reviews the predictions he made last January (probably because most of them have proven to be correct).

Bill Raike begins his column by mentioning some computer applications he has found in unlikely places—a noodle shop? He then goes on to describe two interesting products he saw at the annual Microcomputer Show in Tokyo. The Vectra-D Dual-Mode Workstation is from Yokogawa Hewlett-Packard. The company has combined two computers into one, letting you use both English and Japanese modes. The second product is Yamaha's Piano Player, a piano and computer rolled into one.

This month's BYTE U.K. is a continuation of Dick Pountain's last column, which was in July. There, he touched briefly on the topic of dynamic load balancing, a programming technique that can be used to optimize performance in parallel computing systems. This month, Dick goes deeper into this technique. To illustrate it, he looks at a graphics demonstration program written in Occam. This program draws views of the Mandelbrot set.

Ezra Shapiro has not been a fan of the Macintosh—for many reasons. However, he admits that he is being won over to the machine because of the excellent software that is appearing. In almost every application category, Ezra finds at least one first-rate Mac product. He is not sure whether More from Living Videotext is an outline processor or an operating system, but he does find it a spectacular piece of software. FullPaint, a program from Ann Arbor Softworks, is a lot like MacPaint. But it is also loaded with significant enhancements that make it a richer and more useful program.

# CONNECT



**IBM DISPLAYWRITER to IBM 5520 to IBM OS/6 to IBM S/36 to IBM 8100 to IBM PROFS to WANG OIS to WANG VS to CPT to LANIER to NBI to MICOM to DEC WPS to XEROX to LINOLEX to COMPUGRAPHIC to QUADREX to NCR to DEC VAX to CP/M to DATA GENERAL to UNIVAC to BURROUGHS to HONEYWELL to IBM PC/386**

**FLAGSTAFF ENGINEERING** can connect your incompatible computer systems using diskette, tape, communications, or printed media. We have developed many low cost systems to help you transfer files and documents between different computer systems. Our "FILE", "WORD", and "TYPESETTING CONNECTION" products can read and write most of your 8", 5¼", and 3½" diskette formats. The "PROTOCOL CONNECTION" can provide RS232 communications between your different computers. The "TAPE CONNECTION" system is a 9-track tape drive that can read and write your files on 800, 1600, or 6250 BPI magnetic tape. Since 1982, we have installed thousands of conversion systems at customer locations around the world. Call us today for help in connecting your systems.



**Flagstaff  
Engineering**

1120 W. Kaibab  
Flagstaff, AZ 86001  
Telephone 602-779-3344  
Telex 705609 FLAGEN



# A BUSY DAY

BY JERRY POURNELLE

## *A long day is representative of what Jerry's month was like*

It has been a day. I'll explain.

I was on the road most of last month, and this one wasn't much different. Some time ago I accepted an engagement to speak at the U.S. Navy's Micro Convention—more on that later—and every year I go to the annual meeting of the American Association for the Advancement of Science. When Tom Clancy, author of the successful *Hunt for Red October*, heard I was going to be out his way, he arranged for me to go with him to the Navy's flight center at Patuxent River in Maryland, where we got to climb around in the latest aircraft. I wouldn't have missed that for worlds, but it used up two more days.

The Navy Micro Convention was in Virginia Beach. That isn't quite the end of the earth, but on a clear day you can probably *see* the end of the world from there. Returning involved flying with Agony Airlines out of Norfolk. I had two days at home, then we were off to Philadelphia for the AAAS. While I was here I worked on the final edit of *Legacy of Heorot* and left it for Larry Niven to finish. I also worked all night on the final report of the Citizen's Advisory Council on National Space Policy, since it had to be in Washington before the first of June.

I came back to find galley proofs of the new release of *The Mercenary*, most but not all of *Heorot* done, a zillion BIX messages about the Council report, an Atari 1040ST, the usual four tons of software, and 28 telephone messages. One was from our editors at Simon and Schuster: they wanted the final manuscript of *Heorot* right away. So did my agent, who was traveling to England and had a really good offer for British rights, only he'd have to take a manuscript with him. Another was from Ken Sheldon, my long-

suffering BYTE editor, who really would like to know when he'd get this column (already two weeks late).

*Heorot* existed—more or less—on disk, but what was needed was paper copies. Some day, I hope, that won't be necessary. I ought to be able to deliver books on disk or by telephone. Alas, not yet: I'd have to print the book out, and *now*.

It was clearly time to use every bit of computer power available.

### **SPELLING, ANYONE?**

It wasn't easy, but I got everything done in one day.

First things first: our manuscript had never been through a spelling checker. You might think that with three authors—Larry Niven, Jerry Pournelle, and Steven Barnes—all working with computers to produce this book, there wouldn't be many errors. One of the great things about writing with little computers is that you can not only write faster, you can write *better*, since it's so very much easier to make changes. Given the rush, surely we could leave the rest to copy editors?

I suppose we could have, but Larry and I have had sad experiences with copy editors who not only didn't catch the real mistakes but decided they could write better sentences than we can. We have developed the theory that the fewer genuine errors, the less incentive for the copy editor to make needless changes; which means that *everything* goes through the spelling checker, even if it's a 565-page manu-

script that has to be printed and ready for Federal Express in one day.

First thing, then, was to fire up the Golem, our big CompuPro 286/Z80 machine. The Golem has 2 megabytes of M-Drive/H RAM disk mem-

ory; more than enough to hold all of *Heorot* as well as The Word Plus complete with dictionaries. Since a good part of a spelling program's activity involves long searches through files, a RAM disk speeds things up something wonderful.

The Word Plus allows you to use multiple dictionaries: the main dictionary, an update dictionary, and a special dictionary that can be dedicated to this particular manuscript. The update dictionary is needed because you can't add words to the program's main word list; that's encoded to allow very fast searching. The special dictionary is great because I can fill it with stuff unique to this book: character names, slang expressions, and stuff like that.

When I was ready to begin, I turned on Big Kat, the Kaypro 286i. While the Golem was working on the text files, I used Big Kat to connect to BIX and clean up some of my BIX mail. Of course, this was clearly the wrong day to quit using Crosstalk; that is, I'd intended to check out Mirror, the Crosstalk clone program, but I sure wasn't about to do *that* in the middle of a crisis.

It all worked quite well. *Heorot* is organized into 34 chapters of about 20K bytes each. It took The Word Plus a little more than a minute to read a chapter, make a list of unique words,

*(continued)*

*Jerry Pournelle holds a doctorate in psychology and is a science fiction writer who also earns a comfortable living writing about computers present and future.*

*I didn't have the  
foggiest notion of  
what to do next.  
I'd never had  
trouble with the  
Printer Optimizer.*

sort them, and check them against the three dictionaries in use. During that minute I could answer a BIX mail inquiry or read a couple of items in a conference. Then I'd turn back to the Golem and deal with the spelling situation.

The early chapters took more attention, of course, since I started with a blank special dictionary. I had to build it up, adding character and place names and slang. Even so, I found I could get a chapter done in five minutes, one of which I'd spent on BIX.

Once I had ten chapters done it was time to print.

#### **CRITICAL JOB DETECTOR**

When we designed my new offices, we included a small soundproofed room with its own air conditioning. I was tired of being in the same room with a machine gun; the printers would lurk in their own special place. It would be inconvenient to have printers at a distance, but it sure would be quieter.

By the time we were actually building, though, I had the HP LaserJet printer; and it's so quiet that there's no need to put it elsewhere. It does generate a bit of heat, but fans take care of that.

The LaserJet is normally connected to Big Kat and to Zeke II, the ancient CompuPro Z80 I write all my books on. Actually, neither machine is connected to the printer: they both connect to the Printer Optimizer, which is a box full of memory that connects to Big Kat by a parallel port and to Zeke II by a serial port. It's very handy: whichever computer is sending, the

Optimizer catches what's being sent and puts it off into the LaserJet. The Optimizer can also translate various print formats into stuff the LaserJet understands; if you have a LaserJet, you probably ought to have an Optimizer.

However, the Optimizer, like most electronic equipment, is apparently furnished with a "critical job detector." I say this because I've had that Optimizer for more than a year now and *never* had one iota of trouble with it; but today was different.

My plan was to connect the Golem to the Optimizer. This is simple enough: I just get an RS-232C cable (I buy mine from Inmac, a pricey but reliable mail-order supply house) and run it across the floor. The Golem isn't normally connected to any printer. Once a month I roll the NEC Spinwriter out to write checks because the LaserJet doesn't take tractor feed, but normally the Golem's jobs don't include printing. If I really need for him to produce hard copy, it's easy enough to string the cable; both Zeke II and the Golem talk to the Optimizer at 9600 baud with the same handshaking protocols and such, so I just unplug Zeke's cable and plug in the Golem's.

Having connected the cable, it was time for a test: the Golem runs under Concurrent CP/M. Do a Control-P and type a couple of characters to be sure things worked right—

And the Optimizer began to squeal.

The first rule is Don't Panic. Machines know when you're scared. It's that "critical job detector" circuit. Work carefully. . .

Maybe I'd connected something up wrong. Better test it; but first, go over to Big Kat and do a "print screen" just to be sure the Optimizer and the LaserJet are working.

More squeals. The Optimizer just wasn't going to accept input.

I didn't have the foggiest notion of what to do next. I'd never had trouble with the Optimizer. Of course, I'd never had such a critical job before.

"Usually," I told myself, "usually it's a cable." Check all cables. No luck, of course. Next, look at everything very calmly and carefully—aha. Normally the Optimizer's little LED display

blinks to tell you whether it wants to print serial or parallel (it can be connected to two different printers as well as two computers). It wasn't blinking. It wasn't doing anything.

Hmm. Time to open it up and look inside. That's easy enough. Now push down all boards and tap all chips. No luck. Then I noticed: the Optimizer has a small lithium battery. This lets it remember what it's supposed to do even when you've turned off the power. The Optimizer seemed to have forgotten something. Could that be it? If that battery is dead I'm in real trouble, but suppose the contacts to it are corroded? Worth a try, anyway. I rotated the battery in its holder, then reprogrammed the Optimizer.

Voilà! Suddenly everything worked fine. Screen dump came through. Connect the Golem, do a Control-P; works fine.

The moral of the story is that if you're very, very careful and stay very, very calm, you can defeat the critical job detector.

#### **AN ORGY OF PRINTING**

From there on things were easy. I had one more glitch: I'd never put a version of WRITE configured for the HP LaserJet onto the Golem. Attempting to print to a LaserJet with a program that thinks it's talking to an NEC Spinwriter will produce interesting results: it fills the LaserJet with form feeds, so that even if you halt input into the printer you'll get a dozen or so sheets of paper with one or two lines of garbage. The only way I've found to stop things when they get that far is to turn the LaserJet off, which usually results in a paper jam. Fortunately, paper jams are easy to clear.

Installing a new version of WRITE took less than five minutes. After that it was a piece of cake. At eight pages a minute the LaserJet can print a chapter about as fast as I can check the spelling, so after I sent over the ten chapters I'd already done, things went very smoothly. You do have to keep the LaserJet's paper tray filled, and that has to be done at its convenience: if you try to add paper while it's printing, you get a paper jam. The good news is that the LaserJet remem-

*(continued)*

# THE PROGRAMMER'S SHOP

helps save time, money and cut frustrations. Compare, evaluate, and find products.

## RECENT DISCOVERY

TurboHALO Graphics for Turbo PASCAL - respected, mature, full. 150 HALO routines, up to 16 colors, medium or high resolution, multiple fonts. IBM CGA and EGA, Hercules, AT&T DEB, more. PC \$ 99

## AI-Expert System Dev't

Arity System - incorporate w/C. PC \$295  
 Experteach - Improved, samples PC \$399  
 EXSYS - Improved. Debug, file & external program access. PC \$339  
 Insight 2+ - dB2, language MS \$879  
 Others: APES (\$359), Advisor (\$949), ES Construction (\$100), ESP (\$845), Expert Choice (\$449)

## AI-Lisp

BYSO - Common, MacLISP compatible 250+ functions, fast. PC \$150  
 GC LISP Interpreter - "Common", rich. Interactive tutorial Call  
 Microsoft MuLisp 85 MS \$199  
 PC Scheme LISP - by TI. SCHEME has simple, "orthogonal" syntax. PC \$ 95  
 TLC LISP - classes, compiler. MS \$225  
 TransLISP - Good for learning MS \$ 75  
 WALTZ LISP - "FRANZ LISP" - like, big nurns, debug, CPM-80 MS \$149  
 Others: IQ LISP (\$155), UNX LISP (\$59), IQC LISP (\$269)

## AI-Prolog

ARITY Standard - full, 4 Meg Interpreter - debug, C, ASM PC \$ 350  
 COMPILER/Interpreter-EXE PC \$ 795  
 With Exp Sys, Screen - KIT PC \$1250  
 MacProlog by Programming Logic Systems MAC \$ 295  
 MicroProlog - enhanced MS \$ 229  
 Prof. MicroProlog - full memory MS \$ 359  
 Prolog-86 - Learn Fast MS \$ 95  
 Prolog-86 Plus - Develop MS \$ 250  
 TURBO PROLOG by Borland PC \$ 79  
 Others: Prolog-1 (\$365), Prolog-2 (\$1795)

## Editors for Programming

BRIEF Programmer's Editor - undo, windows, reconfigure PC Call  
 C Screen Editor - w/source 80/86 \$ 75  
 EMACS by UniPress - powerful, multifile, MLISP. Source: \$949 \$299  
 Epsilon - like EMACS PC \$169  
 Kedit - like XEDIT PC \$109  
 Lattice Screen Editor-multiwindow multi-tasking Amiga \$100 MS \$109  
 PMATE - power, multitask 80/86 \$149  
 Red Editor CPM \$ 95  
 XTC - multitasking PC \$ 85

## FEATURE

Smalltalk-80 - "Official" Xerox licensed version. Compatible with Smalltalk-80 v2 running on other systems. Compiler, complete graphics interface, debugger, windows, text and graphics editor, source. Protected mode, RAM access. Requires PC AT PC \$995

## 700+ Programmer's Products

The Programmer's Shop carries every programmer's software product for MSDOS, PCDOS, CPM, Macintosh, Atari, and Amiga systems. We help you choose the best tools for you. Most popular products are in stock, available for quick delivery. We will gladly special order a product for you at no charge - just allow a few extra days for delivery. Need Cross Compilers, Translators, or the right Fortran compiler? Ask us.

### Our Services:

- Programmer's Referral List
- Compare Products
- Help find a Publisher
- Evaluation Literature FREE
- BBS - 7PM to 7AM 617-826-4086
- Dealers Inquire
- Newsletter
- Rush Order
- Over 700 products
- National Accounts Center

## C Support-Systems

Basic-C Library by C Source MS \$139  
 C Sharp - well supported, Source, realtime, tasks PC \$600  
 C ToolSet - DIFF, xref, source MS \$ 95  
 Lattice Text Utilities PC \$ 99  
 The HAMMER by OES Systems PC \$179  
 PC LINT - checker. Amiga \$89, MS \$119  
 SECURITY LIB - add encrypt to MSC. C86 programs. Source \$250 PC \$125

## Fortran & Supporting

Forlib+ by Alpha - graph, comm. \$ 59  
 MACFortran by Microsoft - full '77 \$229  
 MS Fortran - well liked, solid \$219  
 No Limit - Fortran Scientific \$119  
 PolyFortran - xref, pp, screen \$149  
 Prospero - '66, reentrant \$349  
 RM/Fortran - enhanced "IBM Ftn" \$395  
 Scientific Subroutines - Matrix \$149

## MultiLanguage Support

BTRIEVE ISAM MS \$199  
 BTRIEVE/N - multiuser MS \$469  
 CODESIFTER - Execution PRO-FILER. Spot bottlenecks. MS \$109  
 Dan Bricklin's Demo Program PC \$ 65  
 HALO Graphics - 115+ device interfaces, rich, printer. Specify language interface PC \$229  
 Microsoft Windows Software Development Kit PC \$399  
 PANEL - data validation, no royalties Xenix \$539, MS \$239  
 Pfinish Performance Analyzer MS \$249  
 PLINK-86 - a program-independent overlay linker to 32 levels. MS \$249  
 PLINK-86 PLUS - incremental MS \$369  
 PolyLibrarian MS \$ 85  
 PVCS Version Control MS \$329  
 Screen Sculptor - slick, thorough PC \$ 99  
 ZAP Communications - VT 100, TEK 4010 emulation, file xfer. PD \$ 95  
 ZView - screen generator MS \$219

## Atari ST & Amiga

We carry full lines of Manx, Lattice, & Metacomco.

Call for a catalog, literature and solid value

800-421-8006

THE PROGRAMMER'S SHOP™

128-B Rockland Street, Hanover, MA 02339

Mass: 800-442-8070 or 617-826-7531 7/86

## RECENT DISCOVERY

Lattice RPG II Compiler - Run RPG II programs developed for the System III or system 32/34/36 with little or no change in source code. Screen gen, ISAM, & direct files. No royalties. PC \$639

## C Language-Compilers

AZTEC C86 - Commercial PC \$499  
 AZTEC C65 - Personal Apple II \$199  
 C86 by CI - 8087, reliable MS \$299  
 Lattice C - from Lattice MS \$339  
 Lattice C - from Lifeboat MS \$289  
 Mark Williams - w/debugger MS \$399  
 Microsoft C 3.0 MS \$259  
 Q/C 88 by Code Works - Compiler source, decent code, native MS \$125  
 Wizard C - full, fast. MS \$389

## C Language-Interpreters

C-terp by Gimpel - full K & R, .OBJ and ASM, large progs. MS \$249  
 INSTANT C - Source debug, Edit to Run-3 seconds MS \$389  
 Interactive C - interpreter, editor PC \$255  
 Introducing C - learn C fast, self paced tutorial PC \$109  
 Run/C Professional - Run/C plus create add-in libraries, load/unload them. MS \$189  
 Run/C Lite - improved MS \$109

## C Libraries-General

Blackstar C Function Library PC \$ 79  
 Blaise C Tools 1 (\$109), C Tools 2 \$ 89  
 C Essentials by Essential PC \$ 85  
 C Food by Lattice-ask for source MS \$109  
 C Utilities by Essential - Comprehensive screen graphics, strings. Source. PC \$139  
 C Worthy Library MS \$295  
 Entelekon C Function Library PC \$119  
 Greenleaf Functions - portable, ASM \$139  
 PforC by Phoenix - objects PC \$299

## C Libraries-Files

FILES: C Index by Trio - full B + Tree, vary length field, multi compiler /File is object only MS \$ 89  
 /Plus is full source MS \$349  
 C to dBASE - with source MS \$139  
 CBTREE - multiuser record locking, sequential, source, no royalties MS \$ 99  
 CTree by Faircom - no royalties MS \$339  
 dbVISTA - full indexing, plus optional record types, pointers, Network. Object only - MS C, LAT, C86 \$159  
 Source - Single user MS \$429  
 Source - Multiuser MS \$849  
 dBASE Tools for C PC \$ 79  
 dbc Isam by Lattice MS \$199

## FEATURE

APT - Active Prolog Tutor. - Guides you in building applications interactively. Arity, Borland, Prolog-86 compatible. PC \$ 65

Note: All prices subject to change without notice. Mention this ad. Some prices are specials. Ask about COD and POs. All formats available. UPS surface shipping add \$3 item.

Inquiry 279

bers which page it messed up in the paper jam and does that page again once you have the paper tray filled and the jam cleared.

By this time I'd caught up with most of the BIX mail, and the special dictionary for *Heorot* was doing a lot of the work, so that I could check a chapter's spelling in four minutes or so, meaning that I could now relax a bit. I thought of firing up Zeke II and beginning this column, but I didn't.

What I did manage was to get one copy of *Heorot* done in time for Federal Express to come get it. The spelling check was worth it, too: there were 6 to 10 errors per chapter, including inconsistent spelling of character names, and once a character apparently changed sex without an operation, or would have if The Word Plus hadn't caught it.

So. That's done. Now to do the column.

#### WORD PROBLEMS

Of all the spelling checkers I've used, I like The Word Plus best; but it does have some problems. For one thing, it doesn't know any plurals, and it doesn't know the full conjugations of most verbs: it knows "analyze" but not "analyzes" and "dog" but not "dogs." By now I've put most of those into the update dictionary, but it can be annoying while you're building it.

There are also bugs in the dictionary. The worst one is that any word that contains the root "cen" will be reported as wrong; somehow Oasis got "cei" in there as the root, so The Word Plus believes "ceitered" is correct but not "centered." I've found a couple of other odd anomalies like that. Once in a while, too, The Word Plus wants to run two dictionary words together, which makes no sense.

For all that, The Word Plus is fast. It can find suggested words quickly, and it's very responsive to user control. I wish Oasis would update the main dictionary, but whether that happens or not, The Word Plus is the spelling-check program I recommend.

#### SPRING COMDEX

The Spring Computer Dealers Exposition, better known as COMDEX, hap-

pens in Atlanta. Every year I say I'm not going, but I always do, lest I fall even further behind. Of course, keeping up in this crazy business is impossible, just as it's impossible to see everything at a COMDEX. I hope I didn't miss anything important, but I probably did.

From what I did see, four products stood out. First, Sayette Technology (an Eastman Kodak company) has a wonderful gadget called the Sayette System 10. It's a transparent gizmo about the size of a loose-leaf notebook. You lay it on top of your ViewGraph overhead projector and run cables to your IBM PC-compatible computer. Now anything that appears on the PC screen will get projected onto the ViewGraph screen.

There are limits. No color, to start. On the other hand, it will translate color output into 16 shades of monochrome, so this isn't a severe handicap.

Many places, such as the civil engineering department at the U.S. Air Force Academy, have developed really nifty software that can be used to demonstrate engineering and science principles. Up to now, projectors that could handle computer output have been very costly, so most schools couldn't afford one. Students either have to huddle around a computer screen or take the instructor's word for what's happening. The new Eastman projector will change all that. At present it sells for less than a thousand dollars. I expect that price to fall. I also expect to see some kind of adapter for the Macintosh, after which this thing is going to have a real impact on education.

#### AT&T PC 6300 PLUS

My second pick of the show is the AT&T PC 6300 Plus.

I don't know what to do about AT&T. The company has really great technological capabilities. I freely confess to being a Bell Labs fan. Moreover, AT&T is one of the few companies with both the finances and the technical resources to be real competition to IBM, something this industry sorely needs.

With all that going for them, AT&T needs only one hit in the small com-

puter market. The company may have it with the 6300 Plus, which is a 98 percent PC AT-compatible box that happens to be faster than an AT and also happens to speak UNIX. More than that, the 6300 Plus can run one job under MS-DOS and simultaneously do UNIX tasks. It's also a rather handsome piece of equipment, with a sensible design, unlike the AT&T PC 7300 (now called the UNIX PC), which takes an acre of desk space and has a keyboard cable coiled so tightly it can drag the desk to your chair.

The 6300 Plus I saw had terrific graphics. Text on the color screen was large, clear, and as steady as anything I've seen in monochrome.

In a word, I was impressed.

The AT&T people said they'd get me a 6300 Plus, and I confess I'm rather eager. Certainly it could take the place of Big Kat, and it could possibly become the main machine here.

That's the plus side.

On the minus side, AT&T could take marketing lessons from just about anybody, including some companies in Chapter 11. That isn't just in the computer field, either. As I was writing this, I got what must have been my tenth call from AT&T urging me to choose them as my long-distance carrier. The only problem is that I *already* chose them. Both by mail and every time they called before. I'm afraid I screamed at the poor chap on the phone. I also told him that the next time AT&T calls me, I'm going to change to anyone *but* them. Think that will work?

AT&T does believe in telephones. They believe so much that they don't put addresses on their press releases. They do give phone numbers, of course, both office and what they say is the home number of their press officer. Calling that after business hours gets an answering machine. I wonder: do they figure people will call for an address? And do they need the business?

#### ATARI ST

My third pick of the show was the Atari ST; the software base for this machine continues to grow, and it's now quite clear not only that Atari will sell a lot of them but that the third-



## CHAOS MANOR

party support base is growing.

For example, Mind Mine Computer Center has kits to upgrade the 520ST to a full megabyte and also to install a permanent battery-backed clock/calendar. Installing the calendar requires pulling a chip and inserting it into a piggyback board. The instructions are clear, and anyone but a certified klutz could do it. The memory expansion is a bit more difficult and requires soldering. Mind Mine warns that it's no job for a novice. I agree, but the instructions are very clear, and it's a lot easier to use their kit than to expand the 520ST by piggybacking chips, as many have done. With those provisos, I recommend both boards and look forward to Mind Mine's future efforts.

Another Atari product I have no trouble recommending is Zoomracks from Quickview Systems. Zoomracks was written by Paul Heckel, the author of *Elements of Friendly Software Design* (Warner Books, 1984), which was my book of the month a year or so ago. It's a kind of database program that's the simplest thing in the world to use. Remember a few years ago when the Execuscan Scan Card systems were all the management rage? I sure do; I bought several of them and even gave a few as presents. Alas, like most such organization schemes, the paperwork was too much, and my leatherbound Execuscan systems languish on bookshelves. Zoomracks, though, is very like Execuscan except that it's computerized, meaning that it's very simple to set up racks of "cards," label the racks, and put whatever you like on the cards. It really works on the Atari. There's a version for the IBM PC, too; it's a bit slow, but fast enough on an AT. With that reservation, very much recommended. You'll hear more about Zoomracks in the future.

More Atari software: a ton of stuff from Antic Software, ranging from some of the most absurd joke programs to Maps and Legends, which has lots of maps and map-drawing tools. Antic specializes in low-cost software that comes without manuals. Alas, they've also set things up so that most of their help files have to be printed out, and I don't have a printer

(continued)

**"BRIEF is simple to learn and use and extremely sophisticated"**

**PC Magazine, July 1986**

## Tailor Program Editing to Your Style

- A high-level, readable **Macro Programming Language** - allows customization for programming languages . . . Complete, unlimited variables, etc.
- Edit **multiple files of unlimited size** (2 Meg is OK)
- **Multiple Windows** on screen with different or same file, fragments, etc.
- A bona-fide **UNDO** stack (up to 300) of all operations; deletions, reading files, search, translate, more.
- Reconfigurable keyboard
- Full "regular expression search" - wild cards, complex patterns
- Adjustable line length - up to 512.
- **Keystroke macros** - for common typing sequences
- Suspend BRIEF to execute, *exit to DOS* - run another program (like a compiler, dir, XREF, DIFF, or DEBUG) then resume BRIEF session
- **Compiler-specific support** like auto indent, syntax check, compile within BRIEF

**Only \$195**  
**Call 800-821-2492**

**Solution Systems™**

335-B Washington St.  
Norwell, MA 02061  
617-659-1571

Full Refund  
if not satisfied  
in 30 days.

### Recent Survey Data

- 88% of survey respondents were more productive with BRIEF than other editors.
- 50% were more productive with BRIEF than their previous editor in 5 hours or less.
- 72% were performing all operations in 2 hours.

For PC, AT, compatibles or Tandy 2000.

**Answer: 1040ST™**

**Question: Which computer is the first in the world to give you 1 Megabyte of power for under \$1,000?**

The 1040ST is a major breakthrough in personal computers. Indeed, it's the world's first computer with an original list price that represents less than \$1 per kilobyte.

To give you an idea of what an extraordinary accomplishment that is, let's look at the price-per-kilobyte figures for some well-known competitors.

The Macintosh™, for example, comes in at over \$4 per kilobyte, the Amiga™ is over \$5 per kilobyte and the PC AT™ is a whopping \$9.

In contrast, the 1040ST comes in at an incredible 98 cents per kilobyte and a total price of just \$999<sup>95</sup> for the complete system: CPU, disk drive and high-resolution monochrome monitor.

ATARI and 1040ST are trademarks of Atari Corp.  
Amiga is a trademark of Commodore-Amiga, Inc.  
AT is a trademark of International Business Machines, Inc.  
Macintosh is a trademark licensed to Apple Computer, Inc.  
© 1986 Atari Corp.

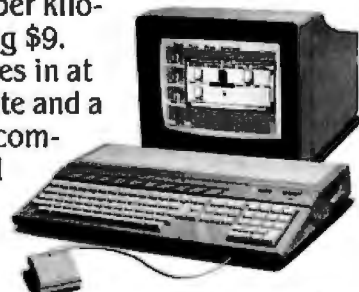

**ATARI™**

## Run Protected Software from a Hard Disk.

ZeroDisk  
ZeroDisk  
ZeroDisk  
ZeroDisk

ZeroDisk lets you run dozens of popular business software packages without floppies. Call us for the latest list of software it handles. ZeroDisk needs an IBM PC or XT or AT or compatible, running under DOS version 2.0 or higher. It occupies 15k bytes of memory. ZeroDisk is not copy-protected.

ZeroDisk is revised monthly. You may get revisions for an \$18 US trade-in fee.

To order ZeroDisk, send a check for \$75 US, or call us with your credit card. We will ship the software within a day.



**Quaid Software Limited**

45 Charles Street East  
Third Floor  
Toronto, Ontario M4Y 1S2  
(416) 961-8243

assigned to the Atari just now. On the other hand, much of their stuff is self-explanatory.

I could go on, but surely the point is clear: Atari ST software pours forth like a flood. The Atari is here to stay and delivers more computer power for the buck than anything else that I know of.

### AMIGA

My top pick of Spring COMDEX was the Amiga.

The Amiga did have some problems. For instance, when Ken Sheldon and I approached the Atari booth, they practically ran out to grab us; I stood in the Amiga booth for 15 minutes before anyone spoke to me. Atari software was demonstrated by hackers; most of the Amiga software was demonstrated by clerical employees from Commodore headquarters.

None of that really mattered. What was important was that the Amiga booth was jammed. I could feel the excitement. It reminded me of the early days of microcomputers. Moreover, once I got past the clerks and secretaries, there were plenty of real hackers.

Mike Lehman, who originally wrote Pascal MT+ and was later a vice president of Digital Research, has started a new company called Maxisoft. The product is MaxiPlan, a combination spreadsheet and database with chart capability. MaxiPlan knows how to do a lot of statistical calculations. It will make databases and charts, and it will talk to you through the Amiga's speech synthesizer. You'll spend a while on the manual—this thing is powerful, and the instructions can be complicated—but it's worth the investment. Highly recommended.

TDI Software has Modula-2 compilers for both the Atari and Amiga machines. The Atari version is a new release that fixes some problems with the original. Both versions work and should make it simpler to transport programs from Atari to Amiga. Long-time readers know I'm a Modula-2 fan; this is a reasonable implementation, and TDI is working to make it better. The chief problem is the documentation: TDI needs to give more and better examples of just how to

write and compile simple programs. Pournelle's law of software documentation: You can't have too many examples. I wish TDI would learn it.

The Amiga is known for its graphics; one of the best graphics programs is Deluxe Paint by Electronic Arts. Alas, they use an obnoxious copy-protection scheme. That's its only real fault; otherwise, Deluxe Paint is glorious. There's just very little you can't do with it. You can color-cycle portions of your drawing, so that waterfalls have running water; zoom in for fine details; and suchlike. It's a lot of fun. EA also has various games, some interesting, some boring.

Mindscape is another company that has developed some interesting Amiga software. The Halley Project is a spaceflight game that's part arcade but largely strategic; it helps to know something about planetary astronomy.

Activision has a whole bunch of Amiga software, including Music Studio, which I haven't much got into but which looks wonderful, and a series of illustrated text adventure games, including Hacker, which some say is the most difficult adventure of that type ever written.

In other words, there's a great deal of Amiga software: business, games, educational, programming tools. That, however, wasn't the real hit.

What was really impressive was the Amiga Sidecar, a box that turns an Amiga into a 99 percent PC-compatible. Moreover, since the Amiga is a multi-tasking machine, they were able to run PC software as just one job. It was eerie to watch Flight Simulator running as if on a PC and still see the famous Amiga bouncing ball in the background and a word-processing program running in the foreground. The Sidecar has both 8088 and 8087 chips and is supposed to sell for significantly less than a thousand dollars. An Amiga plus Sidecar plus hard disk would be one of the most powerful combinations around, and I had no problem designating that the number one pick of Spring COMDEX.

### PROBLEMS

One problem I've had with the Amiga is that while I kept hearing about all

the new software for it, I never got any. Commodore's people sent catalogs, while the Atari people sent software. At COMDEX, Bob Pariseau, vice president for software development and one of the original Amiga development team, promised to fix all that. He also arranged to get me a Sidecar as soon as it was available. I left COMDEX convinced that the Amiga was likely to be the product of the year.

Two weeks later, Commodore laid off nearly 200 people, including Bob Pariseau. There were 55 Amiga people in the West Coast office; 20 were let go. Moreover, many who didn't leave immediately were put on notice; others, seeing the handwriting on the wall, quietly began sending out their résumés. The rumor I hear is that the investment bankers want Commodore to reduce their payroll by 50 percent; given Commodore's financial situation, the company is in no position to argue.

The question, then, is whether Commodore has—and can keep—enough high-tech people to support the Amiga properly. Commodore says they can. So do Amiga enthusiasts.

Me, I don't know. The situation is made vastly more complicated because many of those laid off were required to sign, as a condition for getting a few more severance benefits, a particularly severe—I would say obnoxious—nondisclosure agreement, the first term of which is that the agreement itself is secret. This has made it very difficult to get a decent picture of what has really happened at Commodore, and as I write this in early June I don't think anyone knows.

So, I like the Amiga, and I was much impressed by the enthusiasm of the Amiga people at COMDEX. Of course, even then the Commodore top brass must have known that many of those enthusiasts wouldn't be with the company two weeks later. By the time you read this, we may know the end of the story. I can't say I'm very fond of Commodore's management, but I do wish the Amiga well. It's a heck of a machine.

**NAVY MICRO**

The Navy Micro Convention at Virginia Beach was quite an interesting af-

fair. The exhibitions tended to be dominated by Zenith, which is hardly surprising since Zenith is furnishing the armed services with most of their personal computers. Indeed, the demand for the new Zenith Z-248 PC AT clone is so great that I can't get one. Real Soon Now, they tell me.

One absolutely fascinating product at the Navy Micro exhibition was from Eastern Computer. I don't even know the product's name: I have a brochure, but it's all in Chinese.

What Eastern makes is a board for the IBM PC, XT, or AT that, coupled with their 24-pin printer, will let your machine write Chinese—using an ordinary PC keyboard.

You enter Chinese into the machine by keystrokes or phonetically. That is, I watched James Cheng of Eastern Computer type in

TKNL YFEMBNG

which resulted in Chinese characters appearing on the PC (monochrome)

screen. He could also have typed in "Zheng Su-ting," which is phonetic for the same result: his name.

Clearly this system isn't much use unless you know Chinese; but if you have ever seen a Chinese mechanical typewriter, with its great number of keys and different platen wheels, you'd appreciate just how revolutionary Eastern's board is. With traditional Chinese typewriters, really fast typists are lucky to do about 10 words a minute; Cheng tells me that with his system they get up to 40 or 50 words a minute.

If you're thinking of publishing in Chinese, you'll want to give Eastern a call.

**HOW'S THAT?**

I met Wayne Rash at the Navy Micro show. Wayne works for American Management Systems and also does reviews for BYTE and other computer magazines. I'd corresponded with him

*(continued)*

**Answer: 1040ST™**

**Question: Which computer was specially designed for people who hate to wait?**

Let's face it, any time you spend waiting on a computer is time wasted. That's why Atari® built the 1040ST with a sizzling clock speed of 8 MHz.

And with 1024K bytes of Random Access Memory, the ST™ gives you an incredible combination of power and speed. (The PC AT™, for example, has 512K of memory.)

So you'll spend time working on your ST, instead of waiting on it.

In addition, the 1040ST costs an amazingly low \$999<sup>99</sup>, which makes it the first computer in the world to deliver 1 Megabyte of memory for under \$1,000. (The PC AT costs about \$4,500.)

So if you haven't checked out the ST yet, what are you waiting for?

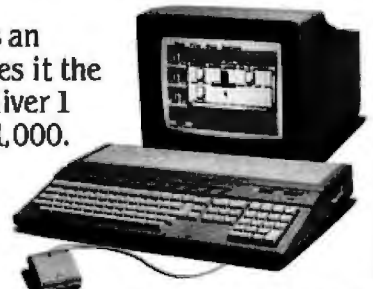

ATARI, ST, and 1040ST are trademarks of Atari Corp. AT is a trademark of International Business Machines, Inc. © 1986 Atari Corp.



# If Resolution Is A Numbers Game... So Be It.

---

From 480 dots x 200 lines up to 720 dots x 480 lines  
fH scanning from 15.75 to over 25.00 KHz.

**F**or over a decade, NANA O has been producing the finest monochrome and color monitors for OEM's worldwide. Now our high resolution monitors are available right from the source—factory direct. The quality, selection, and prices are beyond compare. But please do.



- 30 different models
- Broad range of features
- Monitors to fit almost every computer and configuration (including the IBM PC/AT and AT&T 6300)
- Designed, built, sold and serviced by NANA O

## NANA O

NANA O USA Corporation  
373 G. Vintage Park Drive Foster City, CA 94404 (415) 341-7055  
Dealers and VAD/VAR Inquiries Welcome

on BIX, but until I got to Virginia Beach I'd never met him.

I'm glad I did. He has some fascinating stories. One of the best concerns the HP Integral.

The Integral came with a single floppy disk and was supposed to do UNIX—which came on several disks. Needless to say, that setup didn't work very well. You could, however, get an external hard disk for the machine. Wayne got one. Now the problem was to format it. HP had furnished a format program, but it didn't seem to work. Finally he called HP.

It took a while, but eventually he found someone who knew how to do it. It seems you were supposed to start the format program, and as soon as it began to run, quickly disconnect the data cable. After that the lobotomized hard disk would happily format itself.

I don't see very many HP Integrals any more. I think I can guess why.

#### T.N.T.

A couple of weeks ago, someone on BIX came up with the notion that a bunch of hackers should work together on BIX to design a program. There followed considerable discussion as to what that program should be. Eventually someone suggested an indexing program, which generated more discussion on what features such a program might have.

Before they could settle the details, Bruce Tonkin of T.N.T. Software leaped in. First he gave a long list of features an index program ought to have. Then he announced that he would write it. A week later he announced that he had written it.

"It" turned out to be My Index, a whole series of programs that, working together, produce an index. The only requirements are that you're running PC-DOS and that your text editor/word processor be able to "print to disk," so that the index program can figure out what page things are on by counting form feeds. Once you have that you can get started with the indexing.

The first program in My Index makes a list of unique words in the document. A second program will then remove common words you

don't want to index. You can also go through the list with a text editor and eliminate words by hand; and to make life simpler, Tonkin provides you with a file of common words you're unlikely ever to want indexed. From there you proceed step by step, until you have an index.

It won't be what I consider a professional index, with sublevels, and phrases, and suchlike; but it has its uses. Back when we were doing computer books (something I've just about given up), I'd have been extremely happy with My Index as the starting point for a full index; it would have saved days of work.

My Index works best with Tonkin's MyWord! text editor, which itself is about as much bang for the buck as you're likely to find in a word-processing program. Like all T.N.T. software, MyWord! and My Index have ridiculously low prices compared to the competition. If you run CP/M, TRSDOS, or PC-DOS, you definitely

ought to have the T.N.T. catalog; there's an awful lot of good stuff in there.

#### FANTASY

ProSoft has once again improved their already excellent Fantasy desktop publishing program for PCs. I'm running their demo on Big Kat as I write this, and it's impressive. Fantasy has a whole bunch of fonts, 60 small pictures like file cabinets and little shapes; and it works with a variety of printers, including the Epsoms, HP's Laserjet and Thinkjet, and most other standards.

It does kerning—that is, tucks small letters in under the wing of large ones—proportional spacing, and all the other stuff you'd expect. In addition to the 28 fonts that come with Fantasy, some 300 more, and 400 pictures, are available separately. At \$69.95 for the basic program, Fantasy is quite a bargain. If you're thinking

*(continued)*

### Answer: 1040ST™

### Question: Which computer builds in multiple features instead of hidden costs?

It seems that a lot of our competitors design stripped down computers, and then charge extra for every feature and upgrade you add.

Atari® doesn't do that, because we believe the features and level of performance you want should be built in to begin with.

That's why the 1040ST gives you a full Megabyte of memory. While the competition only gives you the chance to spend big dollars trying to improve their memories.

Another trick they use is to make sure their interfaces don't meet industry standards, so you're locked into their system. In contrast, the ST™ uses standard interfaces across the board, such as the RS-232C port for serial modem communications and the parallel interface for an industry standard printer.

Of course, the ST's best built-in is the price, which is an incredible \$999<sup>99</sup>!

ATARI, ST, and 1040ST are trademarks of Atari Corp.  
© 1986 Atari Corp.



# ATARI®

of publishing a newsletter, you could do a lot worse.

**REPORTS PLUS**

One of the people I met at Spring COMDEX was Sue Currier, president of Softsync. She'd arranged to meet me in the press lounge at an ungodly hour in order to tell me about Reports Plus, a program intended to rival Borland's Reflex.

She began talking about the program. It will take SuperCalc3, Lotus 1-2-3, R:base, dBASE, or other files and transform them in interesting ways to generate and format reports. It would sell for \$99 and is all menu-driven to make it simple to use. No programming required.

It all sounded good, but then came the fatal question. "Copy-protected?" I asked her, thinking that I would just

get it on the record.

"Uh, well—we're thinking about it," she said.

There followed 15 minutes of conversation. It turned out that the review copy she'd brought to hand me was indeed copy-protected with one of those crazy schemes that let you install it on your hard disk.

"Not me," I said. "You won't get that stuff within miles of *my* hard disk."

The upshot was that I refused the copy and told her to get back to me if they decided to remove the protection scheme. Three weeks went by. Then came a box from Softsync: a copy of Reports Plus and a letter explaining that they'd decided to put the program out unprotected. It also explained that the program, called twenty/twenty in Britain, had won some competitions against Reflex and Paradox over there.

What with running around to Navy Micro and AAAS, I haven't had a lot of opportunity to work with Reports Plus; but what I have seen I like a lot. I've already used it to reformat some expense reports I put up with SuperCalc3, and it's certainly easy enough to use. It comes with both demonstration and tutorial disks, and so far I haven't found any glitches. I've become somewhat used to Reflex, but I had no trouble adapting to the Reports Plus method.

All in all, Reports Plus is a formidable rival to Reflex.

**AT-STYLE KEYBOARD**

A lot of people hate the IBM PC keyboard. Certainly I do, and I've said so often enough.

I have it on good authority that the designer of the IBM PC AT's keyboard was given explicit instructions to "make it so that d\*\*n Pournelle won't trash it in his column." They succeeded, too: the PC AT's keyboard is pretty good.

Robert Solomon at Data Desk International thought so too, and he brought out an AT-style keyboard for the PC called the Model 8700. There's also a version available for AT compatibles.

It's a good keyboard. Good feel: the keys have tactile feedback. No mush

(continued)

**NEW!**

For Your IBM PC or Compatible

**RightWriter™ Version 2.0**

**THE Intelligent Grammar and Style Checker**

RightWriter is a new tool to help you produce lean, powerful BUSINESS WRITING. RightWriter uses advanced artificial intelligence technology to flag errors in GRAMMAR, STYLE, USAGE, and PUNCTUATION. RightWriter is the first office automation package aimed at producing better writing, not more writing.

- **Messages are Inserted** directly into text to point out possible errors and problem areas.
- **Easy to Use** — only one command to learn, your word processor does the rest.
- **Works with Leading Word Processors** — including WordStar®, Volkswriter®, PFS:write®, MultiMate®, and others.
- **Readability Index** — measures the reading grade level of the document using the D.O.D. standard Flesch-Kincaid formula.
- **Uncommon Word List** — lists misspelled, slang, and uncommon words.
- **Recommends** — never decides. RightWriter is a writing aid. The final decision is always left to you.

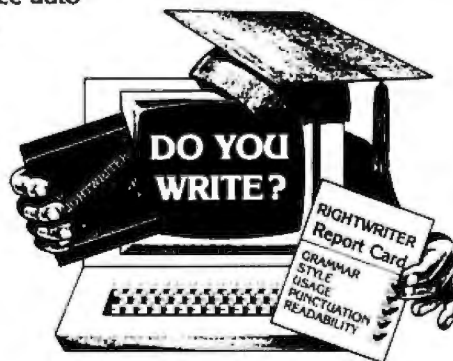

"... RightWriter is an idea whose time is long overdue."  
 Phil Wiswell — PC Magazine

"RightWriter is an excellent, low-cost, eye-opening software package..."  
 Inside Word Management

"The documentation is among the best I have seen."  
 Jim Pile, Soft Sector

**Price \$95.00**

Available from your local dealer or:  
 DECISIONWARE, INC./RightSoft Division  
 2033 Wood St. • Suite 21B  
 Sarasota, FL 33577  
 Phone Orders Call: (813) 952-9211  
 Add \$4 for shipping and handling.  
 VISA & MASTERCARD accepted  
**30 Day Money Back Guarantee**

RightWriter is a trademark of DecisionWare, Inc., WordStar is a trademark of MicroPro International Corporation, MultiMate is a trademark of MultiMate International, PFS:write is a trademark of Software Publishing Corporation, Volkswriter is a trademark of Lifetree Software, Inc.

Inquiry 103 for End-Users.  
 Inquiry 104 for DEALERS ONLY.

# If you think you can't afford a UNIX<sup>®</sup> system, we've got a \$160 surprise.

## Turn your PC into a multi-user system.

Convert your IBM PC-AT (or compatible) into a multi-user/tasking UNIX work station—at *absolutely the best price anywhere*, any time. Based on the AT&T-certified UNIX System V/286, the MICROPORT SYSTEM V/AT is designed for use in virtually any computer environment, from office automation to software development.

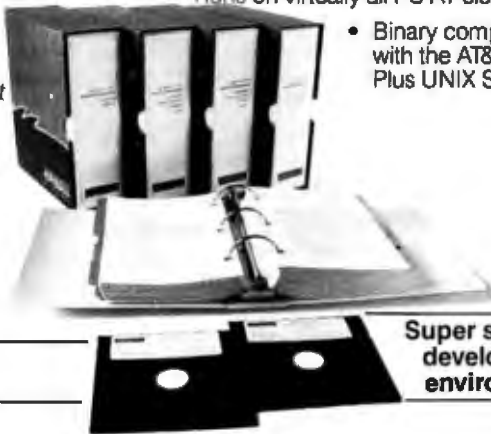

## Over 200 utilities come standard.

Grep, awk, sort, split, cut, paste, vi and ed (and many more) now let you search and modify files, make use of electronic mail, emulate terminals, calculate electronically, convert data and publish.

SYSTEM V/AT is more than a look-alike. It was derived from AT&T's own UNIX System V release 2 iAPX286. It thereby contains standard System V features the competitors don't support, such as the powerful symbolic debugger, sdb, the shell-layering job-control facility and the F77 Fortran compiler, as well as programming tools such as ctrace, cflow, and bs. Also standard is File System Hardening which greatly reduces data loss in a power failure.

## Want some more features?

- Console driver providing ANSI terminal interface for monochrome, CGA, Hercules and EGA cards.
- Multiple Virtual consoles allow up to four virtual windows of operation.
- Record and File Locking
- Supports the 286's 16 megabyte virtual address space and fully utilizes its other advance features.
- Supports all standard IBM drive types and most non-standard hard-disk drives.
- Requires only one hard-disk partition, and allows DOS to reside on the same hard disk.
- Provides utilities to transfer files to-and-from DOS file systems.

- Dynamic disk buffer allocation provides RAM disk performance for systems with large memory configuration.
- Runs on virtually all PC-AT clones.
- Binary compatible with the AT&T 6300 Plus UNIX System.

## Super software-development environment

We've provided everything: Make, yacc, lex, sccs, cflow, ctrace plus every standard System V software-development tool. The F77 Fortran compiler. And the AT&T Portable C compiler for the 286. Both C and Fortran compilers generate 287 instructions directly—for systems not containing 287 math coprocessors, a kernel-resident IEEE-compatible 287 emulator is provided. The large-model code produced by the compiler is among the densest and fastest currently available.

## So, how do we do it?

MICROPORT offers SYSTEM V/AT at a fraction of the price of the competitors simply because we build on the generic System V/286 product from AT&T. This entire utility package from the certified release has been copied directly to SYSTEM V/AT—without so much as a recompile. Not only does this mean that MICROPORT can offer SYSTEM V/AT at a remarkable low price, it also *guarantees* a level of quality present in few (if any) other UNIX-system implementations. (And, since our staff was part of the group that implemented the standard System V/286 port for Intel, MICROPORT can offer comprehensive support for the system, as well.)

## And a dollar change

The price is even better than you thought. Order right away and we'll return one silver dollar just as rapidly, with your product shipment. (If you'd like a little more time we'll apply that dollar to the cost of a brochure—which we'll send right away too.)

## 90 DAY MONEY BACK GUARANTEE

# And a dollar change.



**To order:** Complete the information below. Your attractively-packaged and fully-documented order will be shipped within two weeks.

**MICROPORT SYSTEMS, INC.**  
4200 Scotts Valley Drive  
Scotts Valley, CA 95066  
408/438-UNIX or 800/PC2-UNIX (outside CA)

## SYSTEM V/AT

- RUNTIME SYSTEM** Includes the SYSTEM V/AT operation system and over 200 utilities, for two users  
QUANT \_\_\_\_\_ **\$160.00**
- SOFTWARE DEVELOPMENT SYSTEM** The complete Software Generation System for 286 development.  
QUANT \_\_\_\_\_ **\$169.00**
- TEXT PREPARATION SYSTEM** Includes nroff, troff, spell and other programs.  
QUANT \_\_\_\_\_ **\$169.00**
- THE COMPLETE SYSTEM** Contains all three packages indicated above  
QUANT \_\_\_\_\_ **\$439.00**
- OPTIONAL** three to eight-user upgrade  
QUANT \_\_\_\_\_ **\$99.00**

Subtotal \_\_\_\_\_

(CA residents add 6.5% tax per copy) \_\_\_\_\_

Shipping and handling charges (In the USA, \$14.00, in Canada, \$18.00, and in Europe, \$110 \_\_\_\_\_)

**TOTAL DUE:** \_\_\_\_\_

NAME \_\_\_\_\_

TELEPHONE \_\_\_\_\_

ADDRESS \_\_\_\_\_

CITY \_\_\_\_\_

STATE \_\_\_\_\_ ZIP \_\_\_\_\_

COUNTRY \_\_\_\_\_

VISA  MASTERCARD  BANK DRAFT  CHECK

CARD NUMBER \_\_\_\_\_ EXP DATE \_\_\_\_\_

Send a brochure only and keep me on your mailing list, please.



M I C R O P O R T

**TURBO PROGRAMMERS-**

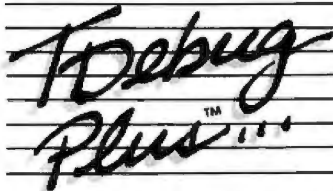

**... CUTS DEBUGGING FRUSTRATION.**

TDebugPLUS is a new, interactive symbolic debugger that integrates with Turbo Pascal to let you:

- **Examine and change variables** at runtime using symbolic names - including records, pointers, arrays, and local variables;
- **Trace and set breakpoints** using procedure names or source statements;
- **View source code** while debugging;
- **Use Turbo Pascal editor and DOS DEBUG commands**

TDebugPLUS also includes a special MAP file generation mode fully compatible with external debuggers such as Periscope, Atron, Symdeb, and others - even on programs written with Turbo EXTENDER

An expanded, supported version of the acclaimed public domain program TDEBUG, the TDebugPLUS package includes one DSDD disk, complete source code, a reference card, and an 80-page printed manual. 256K of memory required. Simplify debugging! \$60 COMPLETE.

**TURBO EXTENDER™**

Turbo EXTENDER provides you the following powerful tools to break the 64K barrier:

- **Large Code Model** allows programs to use all 640K without overlays or chaining, while allowing you to convert existing programs with minimal effort; makes EXE files;
- **Make Facility** offers separate compilation eliminating the need for you to recompile unchanged modules;
- **Large Data Arrays** automatically manages data arrays up to 30 megabytes as well as any arrays in expanded memory (EMS);
- **Additional Turbo EXTENDER tools** include Overlay Analyst, Disk Cache, Pascal Encryptor, Shell File Generator, and File Browser.

The Turbo EXTENDER package includes two DSDD disks, complete source code, and a 150-page printed manual. Order now! \$85 COMPLETE.

**TURBOPOWER UTILITIES™**

"If you own Turbo Pascal, you should own TurboPower Programmers Utilities, that's all there is to it." Bruce Webster, *BYTE Magazine*

TurboPower Utilities offers nine powerful programs: Program Structure Analyzer, Execution Timer, Execution Profiler, Pretty Printer, Command Repeater, Pattern Replacer, Difference Finder, File Finder, and Super Directory.

The TurboPower Utilities package includes three DSDD disks, reference card, and manual \$95 with source code; \$55 executable only.

**ORDER DIRECT TODAY!**

- **MC/VISA Call Toll Free** 7 days a week. 800-538-8157 x830 (US) 800-672-3470 x830 (CA)
- **Limited Time Offer!** Buy two or more TurboPower products and save 15%!
- **Satisfaction Guaranteed** or your money back within 30 days.

For Brochures, Dealer or other Information, PD, COD - call or write:



478 W Hamilton #196  
Campbell, CA 95008  
(408) 378-3672  
M-F 9AM-5PM PST

The above TurboPower products require Turbo Pascal 3.0 (standard, 8087, or BCD) and PC-DOS 2.X or 3.X, and run on the IBM PC/XT/AT and compatibles.

at all. It has a Selectric layout. There's a two-year warranty. To make the deal even better, it comes with Borland International's SuperKey keyboard enhancer bundled in.

This is about as good a keyboard deal as you're likely to find, provided that you're willing to put up with having your numeric keypad double as your arrow keys through the use of Num Lock. That, of course, is what IBM decreed, so Data Desk didn't have much choice if they wanted to copy the PC AT keyboard; and of course it does save weight.

Alas, I find it something of a royal pain, and after using the Data Desk keyboard for a month or so, I went back to my big Enigma Research keyboard. The Enigma does *not* have as good a feel as the Data Desk, and if I get to where I'm writing books on a PCompatible, I'll probably switch back to the Data Desk; but for BIX-ing and game playing and spelling checking and all the other stuff *except* writing for hours on end, the Enigma is just one whorl of a lot more convenient. In any event, I have absolutely no hesitation in recommending the Model 8700.

**ORCHIDS**

Last minute department: Orchid Technology keeps coming up with more and better stuff to keep your PC from becoming an anvil. Now they have a 286 upgrade for your IBM PC XT. It won't work on your older PC. Actually, it will, but you'll need to upgrade the power supply; kits for doing that are advertised all over the place, so that shouldn't be difficult.

With the Orchid Pcturbo 286e, your XT will run programs around twice as fast as will a normal PC AT, which makes it about five times as fast as a normal PC. Orchid also makes the ECCELL, a memory board that not only finds memory errors but corrects them. (The name is an acronym for error correction.)

I'll have more about Orchid's new stuff in a later column. We've been using the Pcturbo 186 board for two years now without glitches; I've no reason to believe we won't have as good an experience with the Pcturbo 286e as soon as I get a new power

supply into Lucy Van Pelt, our (quite old) IBM PC.

**WINDING DOWN**

Barry Workman tells me he's selling lots of copies of FTL Modula for CP/M; and by the time you read this, he expects to have an IBM PC version. Meanwhile, Tony Pietsch says he'll have WRITE for the PC done very soon; and another associate is trying to port WRITE onto the Atari ST. It all sounds good to me.

The game of the month is Time Bandit from Michtron Inc. Michtron makes a lot of software for the Atari ST. Time Bandit on the ST is the best arcade-type computer game I have ever seen, either on a home computer or in an actual arcade. It has some 11 dungeons, each with four levels. I haven't *begun* to master the silly game. I haven't quit trying, either. Watch out, Starship *Excalibur*, here I come! Full speed ahead, and damn the Watch Tribbles. . .

The book of the month has to be the report of the Citizen's Advisory Council on National Space Policy. It has to be, because it has taken up just about every spare moment I have.

The Council consists of some 50 aerospace experts and meets irregularly at Larry Niven's house. I'm chairman, in part because they figure they can stick me with writing the final report, which indeed got done at 6 a.m. on the morning we left for Philadelphia and the AAAS meeting.

This year's Council meeting was different: long before we had the actual meeting, we got many of the issues settled through conferences on BIX. G. Harry Stine, who's collaborating with me to turn the Council report into a book (*America: A Spacefaring Nation Again*; Baen Books, late 1986), will probably do an article on how we used BIX before and after the meeting. We learned a lot, including some of the strengths and weaknesses of electronic conferencing. More on that another time; but I guarantee you we'd not have accomplished half what we did if it hadn't been for BIX.

The computer book of the month has no author: it's *Programmers at Work, First Series* from Microsoft Press (1986,



## ITEMS DISCUSSED

|                                                                                                                                                                |                                                                                                                                                                                                                                                       |                                                                                                                                                                                      |
|----------------------------------------------------------------------------------------------------------------------------------------------------------------|-------------------------------------------------------------------------------------------------------------------------------------------------------------------------------------------------------------------------------------------------------|--------------------------------------------------------------------------------------------------------------------------------------------------------------------------------------|
| <b>AMIGA SIDECAR</b> .....Price not announced<br>Commodore Business Machines Inc.<br>1200 Wilson Dr.<br>West Chester, PA 19380<br>(215) 431-9100               | <b>Data Desk International</b><br>7650 Haskell Ave., Suite A<br>Van Nuys, CA 91406<br>(818) 780-1673                                                                                                                                                  | <b>REPORTS PLUS</b> .....\$99<br>Softsync Inc.<br>162 Madison Ave.<br>New York, NY 10016<br>(212) 685-2080                                                                           |
| <b>AT&amp;T PC 6300 PLUS</b> .Starts at \$4755<br>AT&T Technology Systems<br>Computer Systems Center<br>4513 Western Ave.<br>Lisle, IL 60532<br>(800) 247-1212 | <b>MODEL 9000 KEYBOARD</b> .....\$350<br>Enigma Research<br>4534 Vista Del Monte, No. 104<br>Sherman Oaks, CA 91403<br>(818) 784-0343                                                                                                                 | <b>SAYETTE SYSTEM 10</b> .....\$1200<br>Sayette Technology<br>1133 Mt. Tead Blvd.<br>Rochester, NY 14606<br>(716) 458-0177                                                           |
| <b>CHINESE CHARACTER GENERATOR</b> .....\$495<br>Eastern Computer<br>600 Lynnhaven Parkway<br>Virginia Beach, VA 23452<br>(804) 340-2496                       | <b>MODULA-2 COMPILER</b><br>(Atari ST) .....\$79.95<br>developer's version .....\$149.95<br><b>MODULA-2 COMPILER (Amiga)</b> \$89.95<br>developer's version .....\$149.95<br>TDI Software<br>10410 Markison Rd.<br>Dallas, TX 75238<br>(214) 340-4942 | <b>THE HALLEY PROJECT</b> .....\$44.95<br>Mindscape<br>3444 Dundee Rd.<br>Northbrook, IL 60062<br>(800) 221-9884                                                                     |
| <b>DELUXE PAINT</b> .....\$99.95<br>Electronic Arts<br>2755 Campus Dr.<br>San Mateo, CA 94403<br>(415) 571-7171                                                | <b>MUSIC STUDIO</b> .....\$59.95<br><b>HACKER</b> .....\$44.95<br>Activision<br>P.O. Box 7287<br>Mountain View, CA 94039<br>(415) 960-0410                                                                                                            | <b>THE WORD PLUS</b> .....\$150<br>Oasis Systems<br>2765 Reynard Ave.<br>San Diego, CA 92103<br>(619) 453-5711                                                                       |
| <b>FANTASY VERSION 2</b> .....\$69.95<br>ProSoft<br>7298 Bellaire Ave., Box 560<br>North Hollywood, CA 91603<br>(818) 765-4444                                 | <b>MY INDEX</b> ....Price not announced<br><b>MYWORD!</b> .....\$35<br>T.N.T. Software<br>34069 Hainesville Rd.<br>Round Lake, IL 60073<br>(312) 223-8595                                                                                             | <b>TIME BANDIT</b> .....\$39.95<br>MickIron Inc.<br>576 South Telegraph<br>Pontiac, MI 48053<br>(313) 334-5700                                                                       |
| <b>MAPS AND LEGENDS</b> .....\$34.95<br>Antic Software<br>524 Second St.<br>San Francisco, CA 94107<br>(415) 957-0886                                          | <b>PC TURBO 286E</b> .....\$1195<br><b>ECCELL (IBM PC AT)</b> \$595 to \$1660<br>Orchid Technology<br>47790 Westinghouse Dr.<br>Fremont, CA 94539<br>(415) 490-8586                                                                                   | <b>UPGRADE KIT</b> .....\$199.95<br><b>CLOCK/CALENDAR KIT</b> .....\$49.95<br>Mind Mine Computer Center<br>13256 Northeast 20th St., Suite 4<br>Bellevue, WA 98055<br>(206) 641-6138 |
| <b>MAXIPLAN</b> .....\$150<br>Maxisoft<br>2817 Sloat Rd.<br>Pebble Beach, CA 93953<br>(408) 625-4104                                                           | <b>PRINTER OPTIMIZER</b> .....\$369<br>Applied Creative Technology<br>2156 West Northwest Highway<br>Dallas, TX 75220<br>(214) 358-4800                                                                                                               | <b>ZOOMRACKS</b><br>for Atari ST or IBM PC ....\$79.95<br>Quickview Systems<br>146 Main St., Suite 404<br>Los Altos, CA 94022<br>(415) 965-0327                                      |
| <b>MODEL 8700 KEYBOARD</b><br>for PC compatibles .....\$99.95<br>for PCjr .....\$119.95                                                                        |                                                                                                                                                                                                                                                       |                                                                                                                                                                                      |

\$14.95), and it consists of interviews with a whole bunch of hackers, including Dan Bricklin (VisiCalc), Andy Herzfeld (Macintosh OS), Bill Gates (Microsoft BASIC), Wayne Ratliff (Vulcan, which became dBASE II), and many others. Quite readable and provides good insight into the varieties of

hacker mentality.

I am now out of space, which is just as well because I'm also out of time: it's 2 a.m., and this has to be at BYTE by dawn. (I'll use BIX to send it.) Of course, it first must go through the spelling checker.

As I said, it's been quite a day. ■

*Jerry Pournelle welcomes readers' comments and opinions. Send a self-addressed, stamped envelope to Jerry Pournelle, c/o BYTE, One Phoenix Mill Lane, Peterborough, NH 03458. Please put your address on the letter as well as on the envelope. Due to the high volume of letters, Jerry cannot guarantee a personal reply.*

# A MEGABYTE FOR DOS!

MicroWay is the world's leading retailer of 8087s and high performance PC upgrades. We stock a complete selection of 8087s that run from 5 to 12 MHz. All of our coprocessors are shipped with a diagnostic disk and the best warranty in the business - one year! We also offer daughterboards for socketless computers (NEC PC) and 287Turbo which increases the clock speed of the 80287 from 4 to 10 MHz. Our NUMBER SMASHER/ECM™ runs at 12 MHz with a megabyte of RAM and achieves a throughput of .1 megaflops with 87BASIC/INLINE, Intel For-

tran, or Microsoft Fortran. Software reviewers consistently cite MicroWay software and 8087 expertise as the best in the industry! Our customers frequently write to thank us for recommending the correct software and hardware to meet their specific needs. They also thank us for our same-day shipping! In addition to our own products which support the 8087 and 80287, we stock the largest supply of specialized software available. For more information call us at

**617-746-7341**

## NUMBER SMASHER/ECM™ THE FASTEST ACCELERATOR CARD AVAILABLE

gives you 12 MHz speed in two modes: 704K or one megabyte of "Extended Conventional Memory." MEGASWITCH MMU and MegaDOS software make it possible to run DOS applications with up to 1015K using PC compilers, AutoCAD and Lotus 1-2-3. Does not require EMS software. Totally compatible. Priced from \$599 with 512K to \$1199 for complete package. Optional 8087-12... \$295

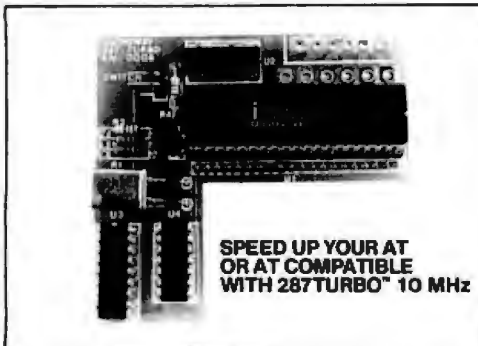

**SPEED UP YOUR AT  
OR AT COMPATIBLE  
WITH 287TURBO™ 10 MHz**

# MicroWay® 8087 Support

For the IBM PC, PC XT, PC AT and Compatibles.

**A2D-160™** MicroWay's Data Acquisition Board performs 160,000 12 bit Analog to Digital conversions per second! Includes software drivers. The fastest 12 bit A to D board available. For the IBM PC XT and compatibles. .... **\$1295**

**87SFL™** MicroWay's Scientific Function Library contains 170 scientific and engineering functions. Callable from most 8087 compatible compilers ... First Language **\$250**; Additional **\$100**.

**MATRIXPAK™** manages a **MEGABYTE!** Written in assembly language, our runtime package accurately manipulates large matrices at very fast speeds. Includes matrix inversion and the solution of simultaneous linear equations. Callable from RM or MS Fortran, MS Assembler, or 87BASIC/INLINE. .... each **\$99**

**87FFT™** Written in assembly language, performs Forward and Inverse FFTs on real and complex arrays which occupy up to 512 Kbytes of RAM. Also does convolutions, auto correlations, hamming, complex vector multiplication, and complex to radial conversions. Callable from most 8087 compatible compilers. .... **\$200**

**87FFT-2™** performs two-dimensional FFTs. Ideal for image processing. Requires 87FFT **\$100**

**FASTBREAK™** employs the 8087 to increase the speed of Lotus 1-2-3™ Version 1A or 1A\* by up to 36:1 ..... **\$79**

**87Verify™** For users who have to be absolutely sure of their results! This background task periodically performs an 8087 accuracy and stress test. .... **\$49**

|                                       |              |
|---------------------------------------|--------------|
| Microsoft Fortran V 3.31 .....        | <b>\$209</b> |
| IBM Professional Fortran .....        | <b>\$565</b> |
| Ryan-McFarland Fortran V 2.0 .....    | <b>\$399</b> |
| NAG Fortran Library .....             | <b>\$300</b> |
| Grafmatic for Fortran or Pascal. .... | <b>\$125</b> |
| MultiHalo Graphics (1 language) ..... | <b>\$189</b> |
| LABTECH NOTEBOOK. ....                | <b>\$745</b> |
| UnkelScope .....                      | <b>\$549</b> |
| INTEL ABOVE BOARD .....               | <b>CALL</b>  |
| JRAM, AST, MAYNARD .....              | <b>CALL</b>  |

**MegaPage™** The only Intel-Lotus EMS board which comes with two megabytes of cool-running, low power drain CMOS RAM installed. Includes RAM disk, print spooler, disk cache, and EMS drivers. For the IBM PC, XT & compatibles. .... **\$549**

**MegaPageAT/ECC™** EMS card for the PC AT and compatibles includes Error Correction Circuitry. With ECC, 11 RAM chips cover 256K so the user never encounters RAM errors. With 1 megabyte CMOS **\$799**; with 3 megabytes CMOS **\$1295**. Optional serial/parallel daughterboard. .... **\$95**.

**DFixer™** Our disk utility which thoroughly checks PC or AT hard disks for bad sectors and updates the MS DOS file allocation table accordingly. Solves the AT hard disk problem! ... **\$149**

**Optimizer™** Optimizes the way your hard disk or floppy stores its files. Speeds up accesses by recombining fragmented files. .... **\$49**

**DCache™** Our disk caching software speeds up your I/O by storing repetitively used tracks in memory. The amount of memory used can be selected in 64 Kbyte banks. .... **\$49**

**87MACRO/DEBUG™** Contains all the pieces needed for writing 8087/80287 assembly code & MicroWay's 87DEBUG debugger. **\$199**

**OBJ-ASM™** A multipass object module translator and disassembler. Produces assembly language listings which include public symbols, external symbols and labels commented with cross references. Ideal for patching object modules for which source is not available. .... **\$200**

**87BASIC™** includes patches to the IBM BASIC or MS Quick BASIC Compiler for USER TRANS-PARENT 8087 support. Provides super fast performance for all numeric operations including trigonometrics, transcendental, addition, subtraction, multiplication, and division. .... each **\$150**

**87BASIC/INLINE™** converts the output of the IBM BASIC Compiler into optimized 8087 inline code which executes up to seven times faster than 87BASIC. Supports separately compiled inline subroutines which are located in their own segments and can contain up to 64 Kbytes of code. This allows programs greater than 128K! Requires the IBM BASIC Compiler Version 1 and a Macro Assembler. Includes 87BASIC ... **\$200**

**MICROWAY UDI** runs RTOS or RMX compilers under DOS. .... **\$300**

## 8087 UPGRADES

All MicroWay 8087s include a one year warranty, complete MicroWay Test Program and accurate installation instructions.

**8087 5 MHz** ..... **\$109**  
For the IBM PC, XT and compatibles.

**8087-2 8 MHz** ..... **\$149**  
For Wang, AT&T, DeskPro, NEC, Leading Edge.

**80287-3 5 MHz** ..... **\$179**  
For the IBM PC AT and 286 compatibles.

**80287-6 6 MHz** ..... **\$229**  
For 8 MHz AT compatibles.

**80287-8 8 MHz** ..... **\$295**  
For the 8 MHz 80286 accelerator cards.

**NEC V20, V30** ..... **\$16, \$30**

**64K RAM Set 150ns** ..... **\$10**

**256K RAM Set 150ns** ..... **\$29**

**256K RAM Set 120ns** ..... **\$39**

**128K RAM Set PC AT** ..... **\$49**

**287Turbo™ 10 MHz** If you own an AT, Deskpro 286 or AT compatible, this is the card you need to get reasonable numeric performance. It plugs into your 80287 socket and includes a specially driven 10 MHz 80287. The card comes in three configurations. The IBM AT version includes a hardware RESET button ..... **\$450**

**287Turbo 8 MHz** ..... **\$369**

**87/88Turbo™** is a stubby card which includes a clock calendar and a speed controller which changes the speed of your motherboard from 4.77 to 7.4 MHz. Its use requires your PC to have a socketed 8284. Typical speed increase is 1.6 to 2.0. The card overcomes slow hardware by slowing up only when such devices are accessed and running at full speed otherwise ..... **\$149**  
Optional 8087-2 ..... **\$149**

**286TurboCache™** This new MicroWay accelerator uses 8K of cache memory and 80286/80287 processors to provide an average speed increase of 3:1 for most programs. Call for specifications and benchmarks ..... **\$595**

Call for our complete catalog of software which supports the 8087.  
In London, please phone 223-7762

**MicroWay** P.O. Box 79  
Kingston, Mass.  
02364 USA  
(617) 746-7341



# TWO FINE PRODUCTS

BY BRUCE WEBSTER

It's now mid-May as I write this; wonder of wonders, I'm going to get this column in on time. It should make the folks back at Peterborough happy; I know it's a relief for me. Maybe I can make a habit of it.

There have been a few columns in which I haven't picked a product of the month; this is the first time I've picked two: Turbo Prolog (from Borland International) and LightspeedC (from Think Technologies). Both deserve it, and I considered sliding one back a month to avoid "diluting" the honor. But I felt that both also deserved timely coverage (or at least as timely as anything with a three-month lead time can be), so here they are.

## STANDARD DISCLAIMER

Since I am about to say some nice things about a product from Borland International, I thought I would once again make it clear that I have had business dealings with Borland in the past. I wrote most of Turbo Tutor back in 1984, and I contributed to the rewrite of Turbo Tutor early last summer. In both cases, I was paid a lump sum for my work in lieu of any royalties, so there was and is no ongoing financial connection with Borland. If you feel that somehow invalidates or makes suspect what I've written below, fine. Frankly, I feel a little silly even mentioning this. However, over the last several months I've had people accuse me of a suspicious bias for or against (a) Apple, (b) Atari, (c) Commodore, (d) all of the above, so I thought I'd make everything clear right from the start. And for those of you who are curious, the answer is (e) none of the above.

## PRODUCT OF THE MONTH: TURBO PROLOG

When I first got my hands on Turbo Pascal a few years back, it excited me as few software products had. With all its quirks, bugs, and rough edges, it represented a real breakthrough in computer software and set Borland on the path to becoming a major power in the microcomputer software industry. Borland has come out with many products since then—perhaps too many—and none have excited or impressed me as much as Turbo Pascal did, though most have been successful. And even though I have copies of just about everything Borland has put out, Turbo Pascal has been the only product I've used for any length of time.

Well, I can now say "Borland's done it again!" and really

## *Turbo Prolog* from Borland and LightspeedC from Think

mean it. As I'm sure most of you are aware (wouldn't you like to get just a percentage point or two of Borland's ad budget?), Borland has released Turbo Prolog, a Prolog development system for the IBM PC and compatibles.

[*Editor's note: See a review of Turbo Prolog on page 293.*] It requires 384K bytes of memory, can actually be run on a one-floppy-drive system (and works nicely on a two-drive system), and runs under MS-DOS/PC-DOS 2.0 or later. It is an actual compiler, capable of producing stand-alone applications (.EXE files). It comes with two disks: one contains the actual Prolog system; the other has more than 60 example programs. Much of the manual, which is over 200 pages, is dedicated to a Prolog tutorial. Turbo Prolog is not copy-protected and sells for the amazing price of \$100 (less a nickel).

What's so interesting about Prolog in the first place? Well, it's a nonprocedural language that allows (requires) you to specify a set of rules, data, and relationships, then tries to find answers to goals that you give it. It is so different from procedural languages (Pascal, C, FORTRAN, BASIC, etc.) that it takes a radical shift in thinking to move over to it. I freely admit that I haven't made the shift yet, even though I've worked through the first six chapters, following the tutorial and keying in all example programs. Of course, the fact that I was using C on the Macintosh and FORTH on the Amiga during the same time period might have had something to do with the cognitive dissonance I've had to deal with.

Listing 1 shows a simple Turbo Prolog program. The domains section defines any data types specific to the program itself. The predicates section defines any relationships between domains. The clauses section gives actual implementations of predicates. These can be facts, like the various assertions of likes, or they can be rules, like the definition of the predicate friends.

For example, given the program in listing 1, you could specify a few different goals. If you asked for the goal likes(X,reading), the program will find names X such that likes(X,reading) is true; in this case, the values returned for X are eva and george. You could ask for the goal likes(eva,X), which would return the solutions reading and biking. For a different approach, you could ask likes

*(continued)*

Bruce Webster, a consulting editor for BYTE, is reached c/o BYTE, P.O. Box 1910, Orem, UT 84057, or on BIX as bwebster.

# ACTOR debut in one month.

There's a better way to program coming in October.

It's like an advanced research system. Instead of data structures and procedures, it uses active objects. But it produces finished, useful programs. Not experiments.

It's easy to optimize, and it has a new way to reclaim unused memory. As a result, it runs so fast on microcomputers, it's good even for real-time control.

And it's built around Microsoft® Windows, which help when you write your programs. And when other people use them.

It's called ACTOR™ and it will perform like nothing you've ever seen. To find out more about it, just call.



**The Whitewater Group**™

906 University Place, Evanston, IL 60201  
(312) 491-2370

## Little Board™ /186... \$495 High Performance, Low Cost PC-DOS Engine

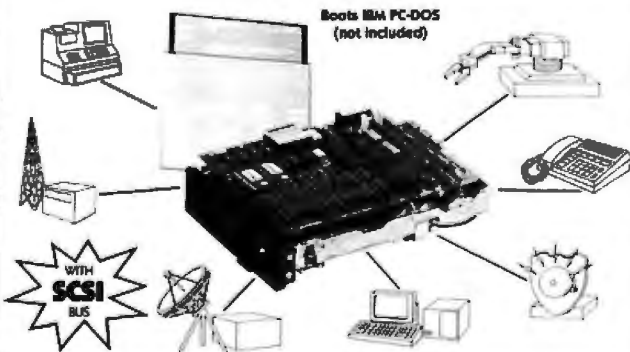

Boots IBM PC-DOS (not included)

- Three times the COMPUTING POWER of a PC
- Data and File Compatible with IBM PC, runs "MS-DOS generic" programs
- 8 MHz 80186 CPU, DMA, Counter/Timers, 519K RAM, zero wait states, 16-192K EPROM
- Mini/Micro Floppy Controller (1-4 Drives, Single/Double Density, 1-2 sided, 40/80 track)
- 2 RS232C Serial Ports (50-38, 400 baud), 1 Centronics Printer Port
- Only 5.75 x 7.75 inches, mounts directly to a 5-1/4" disk drive
- Power Requirement: +5VDC at 1.25A; +12VDC at .05A; On board -12V converter
- SCSI/PLUS™ multi-master I/O expansion bus
- Software Included:
  - PC-DOS compatible ROM-BIOS boots DOS 1.x and 3.x
  - Hard Disk support

**NEW OPTIONS AVAILABLE**

- EXPANSION/186 with:
  - 519K additional RAM
  - 2 Sync/Async RS232/492 serial ports
  - Battery backed Real Time Clock
  - 8087 Math Co-Processor
  - Buffered I/O Bus
- SCSI/IDP for STD BUS
- PROTO/186: prototyping adapter
- CONCURRENT DOS: Multitasking/Multi-user (2/4) Operating System



IBM®, IBM Corp., 80186®, Intel Corp.

67 East Evelyn Ave. • Mountain View, CA 94041 • (415) 962-0230 • TELEX 4940302

## ACCORDING TO WEBSTER

Listing 1: A simple Turbo Prolog program.

```
domains
 person, hobby = symbol
predicates
 likes(person,hobby)
 friends(person,person)
clauses
 likes(gregg,gerbils).
 likes(eva,biking).
 likes(george,reading).
 likes(eva,reading).
 likes(azra,driving).
 likes(phil,flying).

 friends(X,Y) if
 likes(X,Z) and likes(Y,Z) and X <> Y.
```

(phil,flying), which would return the solution TRUE; likewise, the goal likes(gregg,driving) would return FALSE. Similar goals can be specified for the predicate friends. The goal friends(eva,X) will return the solution george.

When you boot up Turbo Prolog, you first notice the user interface. It's a multiwindow, keyboard-controlled, menu-driven system that works smoothly and well. Your environment consists of five windows. The top one, the menu bar, is fixed and unchangeable. It lists your main commands—Run, Compile, Edit, Options, Files, Setup, and Quit—which you can execute by typing the first letter of each command or by using arrow-key selection. Three of the commands (Options, Files, and Setup) have pop-down menus that let you select options by the first letter or by arrow commands. Some commands (like Load File) will open up other windows (like when you need to enter a filename). You can always travel back up the chain of windows by pressing the Escape key.

All the action takes place in the other four windows. The window names—editor, dialog, messages, and trace—may clue you as to their function. You actually enter and modify your Prolog programs in the editor window. You interact with your running Prolog program in the dialog window; that is, all program input and output take place here. You can see which clauses are being invoked in the messages window, while the trace window gives you a more detailed step-by-step evaluation of your program's execution if you have the trace function enabled. You can resize and relocate all four windows using the arrow keys, then save your custom setup.

The editor window accepts both a WordStar subset of commands (Control-X, Control-S, etc.) and commands from the function keys and arrow keys. The window automatically does horizontal and vertical scrolling as needed while you type or move through your text. A Help key (F1) brings up a pop-up window from which you can get a description of the basic set of editing commands.

When you have entered your program, you hit the Escape key to get out of the editor window, then you type "C" (for Compile) or "R" (for Run). In both cases, the pro-

(continued)

# The BCC52 packs an entire development and acquisition system into a single dose.

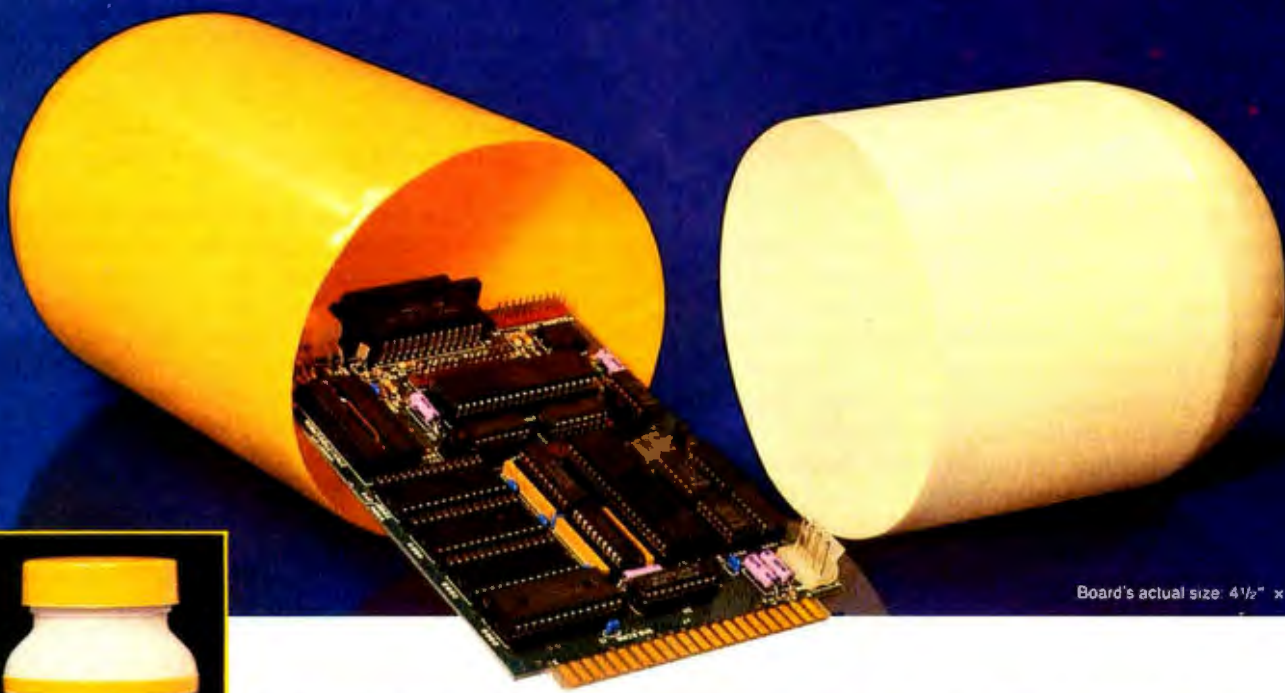

Board's actual size: 4 1/2" x 6 1/2"



#### The BCC52 Computer/Controller

Eases control upsets  
when used as:

- 1) A single board controller or
- 2) The heart of a fully configured data acquisition & control system.

#### Indications for use:

When a single controller board or a complete development and acquisition system is needed.

#### Active Ingredients:

Intel 8052 8-bit processor, 8K floating point ROM resident control BASIC, 3 on-board parallel I/O ports,

Serial terminal port (auto baud rate select), Serial printer port, Socketed for 48K bytes RAM and EPROM, 2 interrupts, Expandable to 64K bytes each of data and program memory, On-board intelligent 2764/27128 EPROM programmer.

**Dosage:** Take either a single board or an entire system to provide control relief.

#### CAUTION:

This product has proven to be habit forming.

Now available without prescription  
from Micromint for only

**\$152\***

\* 100 quantity OEM price

CALL TOLL FREE

**1-800-635-3355**

In Connecticut call: 1-871-6170

**Micromint, Inc.** 25 Terrace Drive, Vernon, Connecticut 06066 TELEX: 643331



# AT LAST: Professional Typesetting Capability For PC Users

With **PC $\TeX$** <sup>TM</sup> — the best-selling full implementation of Professor Don Knuth's revolutionary typesetting program  **$\TeX$** .

**FINEST Typeset Quality Printing From:**  
dot matrix      laser      phototypesetter

$$\sum_{i=1}^{\infty} \frac{1}{i} \begin{pmatrix} a_{11} & \dots & a_{1n} \\ a_{21} & \dots & a_{2n} \\ \vdots & \ddots & \vdots \\ a_{m1} & \dots & a_{mn} \end{pmatrix} \int_{-\infty}^{\infty} e^{-x^2} dx$$

**WIDEST Range Of Output Device Drivers:**

- Epson FX, LQ
- HP LaserJet\*
- Toshiba
- Apple LaserWriter
- Corona LP-300\*
- APS-5 phototypesetter
- Screen preview, with EGA or Hercules card

**MOST COMPLETE Product Offering:**

**PC $\TeX$**  (not copy protected) includes the following:

- Our specially written *PC $\TeX$  Manual*, which enables you to start using  **$\TeX$**  right away.
- Custom "macro packages" that provide formats for letters, manuals, technical documents, etc.
- The  **$\LaTeX$**  document preparation system, a full-featured macro package for preparing articles, books, reports, etc., and  **$\LaTeX$  User's Manual**.
- **$\AMS\text{-}\TeX$** , developed by the *Amer. Math. Society* for professional mathematical typesetting.

Site licenses, volume discounts, and interfaces to PC Paintbrush, PC Palette, FancyFont and Fontrix are also available.

**PRICED FROM ONLY \$249.00!**

(Printer drivers and interfaces additional.)



**Laser printer,  
fonts & software  
from \$2995.00**

For IBM PC/XT, AT or compatible, DOS 2.0 or higher, and 512K RAM. Hard disk required for printer drivers and fonts.  
\*HP LaserJet and Corona require additional interface boards.

For more information call or write:

**Personal  $\TeX$ , Inc.**

20 Sunnyside, Suite H, Mill Valley, CA 94941 (415) 388-8853

This ad, with space for the photograph, produced by **PC $\TeX$** . Typeset on the Epson FX80, the Corona LP-300 laser printer, and the Autologic APS-5 phototypesetter.

$\TeX$  is a trademark of the American Mathematical Society. Manufacturers' product names are trademarks of individual manufacturers.

## ACCORDING TO WEBSTER

gram is then compiled; in the latter case, it is also executed. If an error is found during compilation, the editor window becomes active, the cursor is placed at the offending location, and an error message is displayed across the bottom of the window. The error message vanishes as soon as you hit any key; unfortunately, the message is often wider than the editor window, and any attempt to scroll the text over to make the message visible results in the message's departure.

When the program compiles correctly and is executed, control passes to the dialog window. Any program output shows up here; likewise, any input takes place in this window. If you have defined a goal (or goals) within your program, running it initiates an attempt to solve those goals. If you have no defined goal (as is the case with the program in listing 1), the program asks you for one; you can then type in an appropriate goal, for instance, likes(phil,X). If you make an error in the goal, the cursor is positioned at the offending spot and an error message appears at the bottom, much like compiler errors in the editor window. And like the editor window, the dialog window is often too narrow for the error message to be readable, and the message disappears as soon as you type anything.

One of the nicest features of Turbo Prolog is that you can bounce directly between the dialog and editor windows. Pressing F9 will take you from the dialog window into the editor; F10 will take you out of the editor window, incrementally compile any changes made, and (if successful) take you to the dialog window. Incremental compilation is a key to the speed of the Turbo Prolog interface. In effect, Turbo Prolog remembers most of what it has compiled. When you change a clause, it usually has to recompile only that one clause. This makes for quick development, allowing you to try out different ideas and add different rules.

Some strong points of Turbo Prolog are the trace and debug features, which let you single-step through your programs, seeing just what clause is being evaluated at any moment and what values your program is using at that point. You can even turn tracing off and on again within your program, so that you don't have to step through sections that you've already debugged.

Another asset is the long list of predefined predicates that not only make for a full Prolog implementation but also give you easy access to screen I/O, graphics, system calls, arithmetic functions, and string handling. Furthermore, Turbo Prolog has the capability of calling external predicates written in assembly language, C, or Pascal. Note that you can't call routines written in version 3.0 of Turbo Pascal; however, version 4.0 (due out sometime in the future) will produce linkable code files that can be called.

The manual is generally well written, more so than many of the Borland documents. The style is clear and readable, and it is well organized. I have only two complaints. First, more examples would have helped, especially in the early chapters. Prolog is such a different language from the ones I and many other programmers have used, that it would help a lot to see the best approaches to different problems

(like loops). Also, the exercises given in the book are probably easy for a Prolog programmer with any experience, but they can prove to be tough for someone (like me) who's just learning Prolog and has no good idea of where to start.

I had done a little Prolog programming before receiving Turbo Prolog, using Chalcedony Software's PROLOG-V Plus interpreter. But I'm not qualified to judge how good the implementation is, so I showed it to two instructors—Dr. Dan Olsen and Gary Stokes—at Brigham Young University who have worked with Prolog. They were impressed with the implementation itself, especially its speed and completeness, and also with the development environment. They said it was superior to the Prolog systems they've been using (including an implementation on a VAX-11/780 minicomputer), and they are looking at switching to Turbo Prolog for class use. Stokes also took a program that he was unable to debug on the VAX and got it quickly running using the trace features of Turbo Prolog.

Their main complaint about Turbo Prolog involves the limitations on having a program expand its own clauses (or rules). You can add facts, like the assertion likes(eva,reading); you cannot, however, define new rules or expand on old ones. This, I suspect, stems from the compiled nature of Turbo Prolog programs. An interpreter has an easier time accepting new rules, since it is maintaining the source code somewhere in memory, to which the program can add new definitions. For stand-alone Turbo Prolog programs to do the same, they would have to somehow include the compiler (or a subset thereof) in the code file, which would greatly increase memory and disk requirements.

The biggest question about Turbo Prolog is how much demand there is for it out there. My first inclination is that there wouldn't be much, especially since the folks most likely to buy it—do-it-yourself programmers—are going to be firmly entrenched in procedural thinking and will have difficulty switching over to the appropriate mind-set. On the other hand, the demand for Pascal compilers was grossly underestimated at the time Turbo Pascal hit the market or, more accurately, the positive qualities of Turbo Pascal radically enlarged the market. The same may be true of Turbo Prolog; given its performance, quality, and low price, it may well create a much larger market than might otherwise exist.

The other big question in my mind concerns the problems that Turbo Prolog is best suited to solve. I don't have a good feeling for the type of problems that Turbo Prolog addresses and the ways in which it might solve them better than, say, Turbo Pascal. This is probably due more to my own ignorance (which, as always, I'm trying to eliminate) than anything, but it will remain a question until I know enough to answer it myself.

Even with those questions, Turbo Prolog may be as significant a leap in software design as Turbo Pascal represented three years ago. I am not sure that the height of that leap is obvious, for a number of reasons. First, there are few Prolog programmers in the microcomputer world,

(continued)

NEW!



turboMAGIC™ turns your ideas into state-of-the-art programs.

Your productivity increased, or your money back!

Let your imagination run wild! It's easy with turboMAGIC. Input forms. Report forms. Help windows. Pop-up menus. Pull-down menu systems. And more! turboMAGIC will turn 15 minutes of your time into code that would take you hundreds of hours to write. Whether you're a professional or just a beginner, you need turboMAGIC.

It's POWERFUL!

It's FLEXIBLE!

It's FAST!

It's MAGIC!

**MAGICscreens.** A revolutionary breakthrough! Screens update automatically to show relationships among fields. Dependent values change and unneeded fields disappear before your eyes. You get easy-to-read screens.

**MAGICwindows.** For truly flashy programs! Pop-up windows at the touch of a key. And when necessary you'll scroll within framed windows for help or data entry.

**MAGIChelp.** Everywhere! Get automatic bottom-line help and a help window for each field of input forms. And you'll have a help window for each option of a menu. You have more than 200K of context-sensitive help in turboMAGIC!

**MAGICkeylines.** A class act! At the touch of a key the bottom line changes to remind you of your full, customized function-key setup.

All this magic and more is in turboMAGIC. Put it in your programs too! turboMAGIC makes it easy. Here's how:

**Full-Featured Editor - WordStar-like. Absolutely the best!**

- Arrows ● repeat ● color ● box (automatic turns/intersections)
- Block ● reformat ● color ● move ● copy ● read ● write
- Centers ● current page ● line ● text in a box
- Colors ● menu selection ● all systems supported ● no flicker
- Graphics ● menu selection of extended ascii characters
- Printing ● customized graphics character translation ● fonts

**Flexibility - never before seen in a code generator!**

- Up to 66 lines in a form.
- Full WordStar-like editing for input forms.
- Your form image stored either in a typed constant or in a picture file. turboMAGIC can even combine several picture files into one.
- Field types galore: numeric (bounds checking) ● date (validity check) ● character (you can specify the legal input set) ● string (fill character, case conversion, justification, and a picture facility that lets you add your own format elements) ● boolean ● male/female ● yes/no ● dollar amount ● social security ● telephone ● zip code ● numeric with automatic increment ● menu (your options appear at the tap of a key). You want more types? turboMAGIC lets you add your own.

**Free Bonus!** We'll give you an impressive screen/printer installer for the programs you create with turboMAGIC. And we'll also send you some valuable demo programs FREE!

Wouldn't you like some magic? Order turboMAGIC today. Only \$99.00. You have nothing to lose with our 30-day full money-back guarantee. CALL NOW! 1-800-225-3165 (Outside Alabama, orders only) or 205-342-7026 (VISA & MC welcome, no PO, no COD)

Requires: Turbo Pascal 3.0 and an IBM PC/XT/AT or compatible 256k RAM minimum

Not copy protected.



Sophisticated Software Inc.  
6586 Old Shell Road  
Mobile, AL 36608 (205) 342-7026

Trademarks:  
Turbo Pascal — Borland International  
WordStar — MicroPro International

THE AFFORDABLE  
**BAR CODE READER**

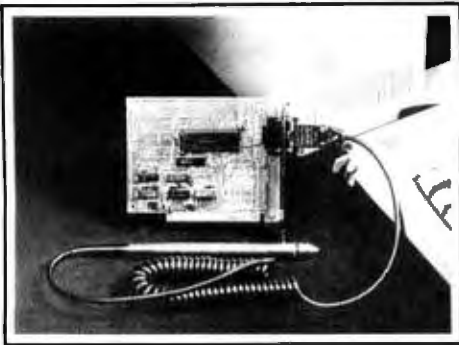

**THE BCR-1000 BAR CODE READER DELIVERS  
UNPARALLELED PERFORMANCE AT A BREAKTHROUGH PRICE**

- IBM-PC/XT/AT and Compatibles
- Compatible With All Keyboard Styles
- Stainless Steel Wand
- Reads All Major Bar Code Symbolologies
- Network Compatibility
- Auto-Discriminates Between Codes
- Non-Contact Scanner Option
- Extremely High First Read Rate
- User-Friendly Menu-Driven Support Software
- Superb Component Reliability
- Scans Over 160 10-Digit Codes in One Minute
- Five Foot Extension Cord For Wand
- Attractive Quantity Pricing
- Two-Year Service Warranty



**SEAGULL SCIENTIFIC SYSTEMS**

601 University Avenue, Suite 150  
Sacramento, CA 95825  
(916) 485-7320

**DeSmet C**

*now with 32-Bit Pointer Option*

**C88..... still \$109**

The editors' choice for fast compilation and execution. The price/performance winner in all major C benchmarks since 1983. Includes Compiler, Assembler, Binder, Librarian, Execution Profiler and Full Screen Editor. Supports both disk and memory resident Overlays. Contains both 8087 and Software floating point support. Full STDIO library.

**Large Case Option.....\$50**

Makes a great C Compiler even better. Adds 32-Bit Pointers to C88 so you can utilize all of your PC. Groups scalar and static data for fast access. Supports the D88 debugger.

**D88.....\$50**

Gain most of the benefits of an interpreter while losing none of the run-time speed of the C88 compiler. Display C source and variable contents during execution. Set breakpoints by function name or line number. Examine and set variables by name using C expressions.

order direct from:

**C Ware Corporation**

505 W. Olive, Suite 767, Sunnyvale, CA 94086 U.S.A.  
(408) 720-9696 — Telex: 358185  
We accept VISA, MasterCard & American Express

at least compared to the number of Pascal programmers who were around when Turbo Pascal came out, so there aren't nearly as many people who can appreciate what Borland has done. Second, Turbo Pascal has spoiled us, both with respect to what we generally expect from compilers and what we specifically expect from Borland. Third, Prolog is such a different language from what most of us grunt-work programmers are using that it's hard to compare its capabilities to those of the languages (C, Pascal, BASIC, etc.) we've been using. I suspect it will be a few years before we can evaluate just what Borland has released here: a curiosity or a milestone.

My recommendation: If you're at all interested in artificial intelligence, databases, expert systems, or new ways of thinking about programming, by all means plunk down your \$100 and buy a copy of Turbo Prolog. I plan to keep using it.

**PRODUCT OF THE MONTH: LIGHTSPEEDC**

I mentioned LightspeedC in my column last month, and it certainly deserves more coverage. For those of you unfamiliar with it, LightspeedC is a C compiler—or, more accurately, a C development environment—for the Macintosh. It produces native 68000 code and stand-alone applications, including desk accessories. It requires 512K bytes of memory and 800K bytes of storage (RAM disk, floppy disk, hard disk, or any combination thereof). The manual claims that you could get by with a single 400K-byte disk drive, but save yourself a lot of grief and make sure you have at least 800K bytes (two single-sided floppies, one double-sided floppy, etc.). It comes with three single-sided disks; one has the actual system, one has examples, and one has utilities and libraries. As for the manual, it's about 400 pages long, is large and readable, and can occasionally be convinced to stay open, though it helps to hold it down with other books, disk drives, rocks, etc. The product is not copy-protected and sells for the reasonable price of \$175.

In LightspeedC, the basic development unit is called the project. A given project, represented on the desktop by a LightspeedC icon, is a collection of C source files, object code libraries, and other projects. You can add files to a project, remove them from the project, and group them into segments. (Before you ask, no, you can't add a project to itself. When you ask to add files to a project, the file-selection box is smart enough to screen out that project as well as all files already added to the project.) You can also set the project to one of four types: application (the default), desk accessory, device driver, and code resource. By using the project approach, LightspeedC performs a lot of bookkeeping and other project management for you, eliminating the tedium of tracking lots of different files.

When you start up LightspeedC, either directly or by double-clicking on a project icon, you come up in a standard Mac environment: desktop, menus (seven in all), and a window listing the files that comprise the current project. You can then double-click on any of the source file-names and go into the editor to make additions and



ACCORDING TO WEBSTER

changes. If you're creating a new source file for your project, you can open up a new (untitled) file, edit it, save it out under some name, then add that file to the project. The editor itself is a simple, clean, Mac-style editor: not too many features, but I haven't found any bugs yet, either. I started opening up files for editing to see how many I could have open at the same time. Once I got 12 open, I started moving and resizing windows, then I closed them all. No problems. Also, the editor is not a separate "mode" from the compiler and linker; you can have editing windows open at all times.

So far, so good, but nothing terribly spectacular or innovative. That comes when you decide to compile and run your program. The first time through, LightspeedC compiles each of the source code modules. The compiler is fast, especially if you're running off a hard disk or a RAM disk. On my system (512K Mac, old ROMs, MacBottom 20-megabyte hard disk), it took just 40 seconds to compile some 3000 lines in four separate source code files. This included the time to open and close each file and to save the object code out to disk.

If an error is encountered during compilation, that file is brought up in an editing window (if it's not already there), the cursor is positioned at the start of the line with the error in it, and a window is brought up at the top of the screen describing the bug. You must acknowledge the error by clicking in that window, and you can then correct the error and restart the compilation. The error messages are sometimes maddeningly vague ("Syntax error" seems to be a favorite catchall); on the other hand, I've always managed to figure out just what the error is, and I'm still a relative neophyte when it comes to C.

LightspeedC starts to show its strengths when you have to recompile your program. It knows which files you have modified and which you haven't and recompiles accordingly. But wait! It's even smarter than that. If you edit a file not listed in the project window—like an ".h" include file—it will recompile only the source files that include that file. And if you edit a file not used by the project, none of the source files are recompiled. Someone—I assume it was Michael Kahl, principal author of LightspeedC—did an outstanding job of making the recompilation algorithm very intelligent. At the same time, you are not locked in by that algorithm. At any time, you can force a recompilation of any or all source code files. You can also force it to reload any library files from the disk. It then performs an incredibly fast link, based, I suspect, on linkage information being held in memory and updated during the compilations. If that isn't successful, it pops up an error window ("Link failed") at the top of the screen and also brings up a text window with the unresolved references. Again, you can use that information to track down your problems, correct them, and start a recompilation.

Once your program compiles and links, you can execute it without ever leaving LightspeedC. Your program takes over the computer, but when it exits (providing it hasn't crashed the system), it returns control back to LightspeedC, not the Finder. At this point, you can create a

(continued)

# New Tools For Mac Developers

"This two volume set is a *must* for anyone serious about programming the Mac. They contain information not found anywhere else, and cover the real-life problems of a software developer."



David Smith, Publisher  
MacTutor

It's all here — tips, techniques, strategies, advanced topics. These books explore mac plus ROMs, print manager, speech drivers, clipboard, and much more.

## THE COMPLETE BOOK OF MACINTOSH ASSEMBLY LANGUAGE PROGRAMMING

Vol. I, 608 pages, \$25.95; Vol. II, 416 pages, \$22.95.

For your two volume set contact your local bookstore or call 312-729-3000.

**Scott, Foresman & Co.,**  
Professional Publishing Group  
1900 E. Lake Ave., Glenview, IL 60025

### HARMONY COMPUTERS

2357 CONEY ISLAND AVE., (BET. AVES. T & U) BKLYN, NY 11223  
800-VIDEO84 or 800-441-1144 or 718-627-1000



Commodore 128  
**\$269.95**  
STAR NX-10  
**\$219.00**

PANASONIC 1091  
**\$211.95**  
IBM (268)  
**\$1449.00**

#### "PRINTER SPECIALS"

|                          |      |                     |     |                      |      |
|--------------------------|------|---------------------|-----|----------------------|------|
| Brother HI 15XL          | 279  | Okidata 192         | 319 | Star 50 10           | 264  |
| Brother HR35 (Compaq C4) | 399  | Okidata 193         | 454 | Star 50 15           | 386  |
| Citizen MSP 10           | 269  | Okidata 292 w-INTFC | 468 | Star SR 10           | 418  |
| Epson LX80               | 189  | Okidata 293 w-INTFC | 603 | Star SR 15           | 530  |
| Epson L800               | 452  | Panasonic KXP 1091  | 212 | SR 10 SR 15 Sheertee | 99   |
| Epson LO 1000            | 669  | Panasonic KXP 1092  | 289 | Star SB 10           | 469  |
| Epson FX 85              | 328  | Panasonic KXP 3131  | 234 | Star SB 15           | 8099 |
| Epson 286                | 479  | Panasonic KXP 3151  | 389 | Star Read Exp 850    | 279  |
| IBM Proprinter           | 379  | Panasonic KXP 1080  | 187 | Star Read Exp 800    | 819  |
| Juki 5100                | 459  | Panasonic KXP 1992  | 459 | Toshiba 1540         | 349  |
| NEC 3150                 | 699  | Pana 1591           | 559 | Tosha 340            | 638  |
| NEC 8850                 | 1029 | Star NX-10          | 210 | Toshiba 351          | 949  |
| NEC P6                   | 448  | Star SQ-15          | 331 | Toshiba 321          | 434  |
| NEC P7                   | 610  |                     |     |                      |      |

### WOW! WOW! WOW!

| IBM                     | ATARI                  | MONITORS             |      |
|-------------------------|------------------------|----------------------|------|
| AT Unenhanced           | 120 XE                 | Ambra 300 Green      | 113  |
| AT Enhanced IBM         | 65 SE                  | Ambra 300 Amber      | 119  |
| AT Enhanced IBM 30 Meg  | 1027 Printer           | 310 Amber            | 129  |
| IBM Monitor             | 1050 Drive             | Color 600            | 386  |
| IBM PC No drives        | Alan White             | Color 722            | 454  |
| PC XT 286               | Compaq Printer         | Princeton HK12       | 394  |
| PC XT Clone             | 520 ST Color System    | Princeton HK12E      | 479  |
| IBM Pro Printer         | 520 ST B & W System    | Princeton Max 12E    | 148  |
| AST Sys Pack 384K       | ST 520 Keyboard        | SR12                 | 126  |
| Hercules Color          | ST 520 Drive           | Scan Double          | 159  |
| Hercules Monochrome     | ST 520 B & W Monitor   | Taan 230             | 149  |
| Color Card              | ST 520 Color Monitor   | NEC Multisync        | 509  |
| Multifunction Card      |                        |                      |      |
| IBM #1                  |                        |                      |      |
| IBM 1.2M                | Hayes 1200             | COMPAQ               |      |
| Teconer Graphics Master | Hayes 1200B w Smartcom | Portable 256K 2-360K | 1499 |
| 8087 Chip               | Hayes 300              | Portable 256K 1-300K | 1999 |
| 80287 Chip              | Hayes 2400             | 1-20MB Hard          | 1499 |
| Evesex Graphics Edge    | Hayes 2400B w Smartcom | Deskpro 640K 1-360K  | 1999 |
| Evesex Edge             | Macromodem 2E          | 1-20MB Hard          |      |
| Evesex Graphics Packet  | Prometheus 1200        |                      |      |
| Joystick for IBM        | Prometheus 1200B       | COMMODORE            |      |
|                         | Prometheus 1200B       | Commodore 128        | 270  |
|                         |                        | 1571 Drive           | 230  |
|                         |                        | Commodore 64         | 149  |
|                         |                        | 1541 Disk Drive      | 172  |
|                         |                        | 1802 Monitor         | 168  |
|                         |                        | 1902A Monitor        | 274  |
|                         |                        | MSP 1000 Printer     | 228  |
|                         |                        | Compaq Printer       | 109  |

Leading Edge Model D 256K 2 Dr Monitor \$1199  
Leading Edge Model D 30188 w monitor \$1495  
Commodore Amiga 256K, DOS Mouse Amiga color monitor \$999

800-441-1144

Items reflect 4% cash or check discount. For your protection we check for stolen credit cards. MC & VISA welcome. Personal checks cause 4 week delay. Shipping & Handling charge extra. Price and availability subject to change without notice.

# IBM PC AT performance! PCjr price!

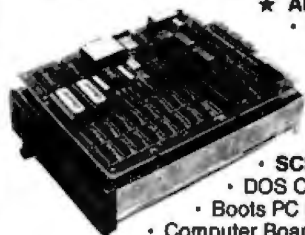

- ★ **AMPRO Little Board/186**
  - 8Mhz 16 Bit 80186 CPU
  - 512K RAM—No Wait-States
  - 2 Serial Ports 50-38.4K Baud
  - Parallel Printer Port
  - 4 Drive Mini/Micro-Floppy Controller
  - SCSI Bus Hard Disk Interface
  - DOS Compatible ROM-BIOS
  - Boots PC DOS 2.x, 3.x
- Computer Board Assembled and Tested with Tech Manual and DOS utilities...**\$489**

- ★ DRI Concurrent DOS 4.1 Multi-User O/S...**\$395**
- ★ Expansion Board for 512K (1Mb total) 8087-1 Socket, Real-Time Clock, 8530 SCC 2 Channel RS232/422, Buffered Expansion Bus and more...from **\$149**
- ★ AMPRO Little Board (Z80) Same as 80186 board but Z80A CPU, 64K RAM, 16K EPROM, CP/M 2.2 & ZCPR3 and manuals...**\$239 (\$279 w/SCSI)**
- Enclosures w/Power Supply...from **\$99**
- Mini/Micro Floppy Drives...call for current price
- XEBEC or SEAGATE SCSI Drives—Low power 1/2 Ht Drive w/built-in Controller 10/20Mb...**\$449/\$599**
- Terminals: WYSE, QUME, KIMTRON...from **\$395**
- Power supplies, cables, connectors in stock

Complete technical support. Complete systems available. Write or call for more information. Most orders shipped same day.

VISA, MasterCard, Money Order, C.O.D. Checks allow two weeks. Purchase orders and bids welcome. Prices F.O.B. Buffalo Grove, IL.

IBM PC AT, PCjr, PC DOS are trademarks of International Business Machines Corporation. Concurrent DOS is a trademark of Digital Research, Inc. Xebec Out is a trademark of Xebec, Inc.

**DISKS PLUS** 356 Lexington Drive  
Buffalo Grove, IL 60089-2312  
tlx: 650 249 2139 MCI UW  
INC (312) 537-7888

## ACCORDING TO WEBSTER

*The real beauty of LightspeedC  
appears when you make a  
change to a working project.*

stand-alone code file by selecting the appropriate menu option; it takes only a few seconds for the executable file to be created. You can also use a project to create a library file, which can then be used in other projects.

The real beauty of LightspeedC appears when you want to make a change to a working project. You edit the appropriate source file and then select the Run option in the project menu (or type Cmd-R). That one source code file is recompiled (usually in a matter of seconds), all necessary relinking is done, all the windows are closed (saving any files currently being edited), and the updated program is launched. For example, I changed one line in the largest of the four modules in my program, then typed Cmd-R. Total elapsed time until the program was running and waiting for my commands: 20 seconds.

How good is the code produced by LightspeedC? I can't say with great accuracy, since I haven't run any benchmarks through it yet. What programs I have run would indicate that the code speed is generally comparable to the other Mac C compilers (Consulair, Aztec, Megamax); but I still plan to run some tests and report on them when I can. Code files seem to be fairly small, too.

What are some of the features and extensions that LightspeedC offers? Well, for starters, it's a superset of Kernighan and Ritchie's C, including structures, enumerated data types, and bit fields. Data type sizes are as follows:

|              |                     |
|--------------|---------------------|
| char         | 8 bits              |
| short        | 16 bits             |
| int          | 16 bits             |
| long         | 32 bits             |
| float        | 32 bits             |
| short double | 64 bits             |
| double       | 80 bits (full IEEE) |

LightspeedC supports the Mac operating system and Toolbox routines, though it apparently doesn't support AppleTalk (as of this writing). It has about 200 other pre-defined functions in other libraries (math, unix, stdio, strings, etc.) to provide compatibility with other C systems. In-line assembly language is not supported; however, a utility is provided to convert Macintosh Development System (MDS) object files to libraries acceptable to LightspeedC. LightspeedC also provides a plain-vanilla I/O interface (using stdio.h) that turns the Mac into a standard terminal; if you include the unix library, you get simple cursor control and graphics functions. In either case, the QuickDraw procedures appear to still work in "terminal" mode. LightspeedC supports resource files (and includes a copy of RMaker). It also comes with the Macsbug debugger and instructions on how to use it. And it even has

(continued)

## Expansion Chassis / Sub-System

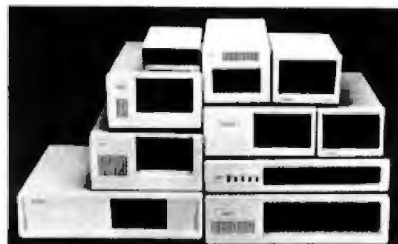

### Specification

| Model No. | No. of Slot | Space for 1/2 Height Drive | Power Supply (Watts) | Dimension DxWxH(cm) | Price |
|-----------|-------------|----------------------------|----------------------|---------------------|-------|
| M-1*      | 0           | 1                          | 50                   | 30 x 15 x 6.5       | \$139 |
| M-2       | 3           | 3                          | 100                  | 42 x 25 x 16        | \$299 |
| M-3       | 5           | 3                          | 100                  | 39 x 30 x 15        | \$239 |
| M-4       | 12          | 2                          | 100                  | 40 x 39 x 14        | \$289 |
| M-5       | 0           | 2                          | 45                   | 39 x 18 x 15        | \$149 |
| M-6       | 0           | 1                          | 50                   | 26.5 x 18 x 13.5    | \$169 |
| M-7       | 5           | 2                          | 100                  | 38.5 x 30 x 13.5    | \$299 |
| M-8       | 0           | 2                          | 45                   | 39.5 x 18 x 13.5    | \$149 |
| M-9       | 0           | 2                          | 60                   | 38.5 x 49 x 9       | \$249 |
| M-10      | 8           | 4                          | 135                  | 43 x 49 x 14        | \$239 |

\*Extra space for a stand alone controller

EXT and RCY Adapters (Interface Computers & Chassis)... \$149

**ORDER TOLL FREE: (800) 826-0267**  
**In California Call (415) 651-3355**  
**DEALER INQUIRIES INVITED**  
**SOURCE ELECTRONICS CORP.**  
 45277 Fremont Blvd., Unit 6  
 Fremont, CA 94538

Telex: 279366

Fax: (415) 791-0935

Inquiry 391 for End-Users.  
 Inquiry 392 for DEALERS ONLY.

# Aztec C ... The Best C

## Frees the genius in you

You've got a great idea . . .

. . . you're ready to write your programs.

You don't want to be sidetracked by all the paperwork. With Manx Aztec C and the ingenious **make** function, your creative processes won't get bogged down in program administration and housekeeping. Manx Aztec C has the most sophisticated, hardworking program administrator available to you. Once you've described your project, adding new features or enhancements is simple. You never have to concern yourself with the repetitive, tedious task of rebuilding your systems.

The development process moves quickly. Compiles, assemblies, link edits . . . all finish in record time.

Manx Aztec C is the fastest, most efficient C development system in the industry. Benchmarks show it . . . reviews commend it . . . users praise it.

You're ready to test the program. You're ahead of schedule. The Manx Aztec C Source Level Debugger shows you the exact C language statement giving you a problem. You fix the problem quickly . . . you're still ahead of schedule.

You've got some time for fine tuning. The Manx Aztec C Profiler examines your program, tells you where the slow spots are and validates your test procedure. A few changes and it's exactly what you wanted.

You've made it!

**Aztec C is available for MS-DOS/PC DOS. Call for details on Macintosh, Amiga, Apple II, CP/M-80, CP/M-86, TRS-80, ROM and others.**

To order, or, for information

**Call Today**

**1-800-221-0440**

In NJ or outside the USA call  
**(201) 542-2121**

30-day satisfaction guarantee. Special Discounts are available to professors, students, independent developers, and on a "trade-in" basis. Site licenses.

# MANX

Manx Software Systems  
One Industrial Way  
Eatontown, NJ 07724

MS is a registered TM of Microsoft, Inc., CP/M TM DRI, HALO TM Media Cybernetics, PANEL TM Roundhill Computer Systems, Ltd., PHACT TM PHACT Assoc., PRE-C, Plink-86 TM Phoenix, db Vista TM Raina Corp., C-terp, PC-lint, TM Gimpel Software, C-tree TM Faircom, Inc., Windows for C TM Creative Solutions, Apple II, Macintosh TM Apple, Inc., TRS-80 TM Radio Shack, Amiga TM Commodore Int'l

Inquiry 217

" . . . a superb linker, a profiler, an assembler, and a set of development utilities are only the beginning of this package . . . performed admirably on the benchmarks, with short compile times and the best link times in this review . . . includes the most professional make utility . . . documentation is clear and complete. There is no doubt that this is a valuable and powerful programming environment." **Computer Languages Feb. '86**

" . . . execution times are very good, close to the best on most tests . . ." **PC Tech Journal Jan. '86**

" Easily one of the fastest compilers overall . . . library provides a lot of flexibility . . . generates small .EXE files." **Dr. Dobbs Journal Aug. '85**

|                                              |               |
|----------------------------------------------|---------------|
| <b>C'Prime (Compiler, Assembler, Linker)</b> | <b>\$ 99.</b> |
| <b>Aztec C 86-d Developer's System</b>       | <b>\$299.</b> |
| <b>Aztec C 86-c Commercial System</b>        | <b>\$499.</b> |
| <b>PC ROM (8086, 68000, 8080, or 6502)</b>   | <b>\$750.</b> |

Third Party Software for Aztec C: HALO, PHACT, C-tree, PRE-C, Windows for C, PC-lint, PANEL, Greenleaf, db Vista, C-terp, Plink-86, FirstTime, C Util Lib, and others.

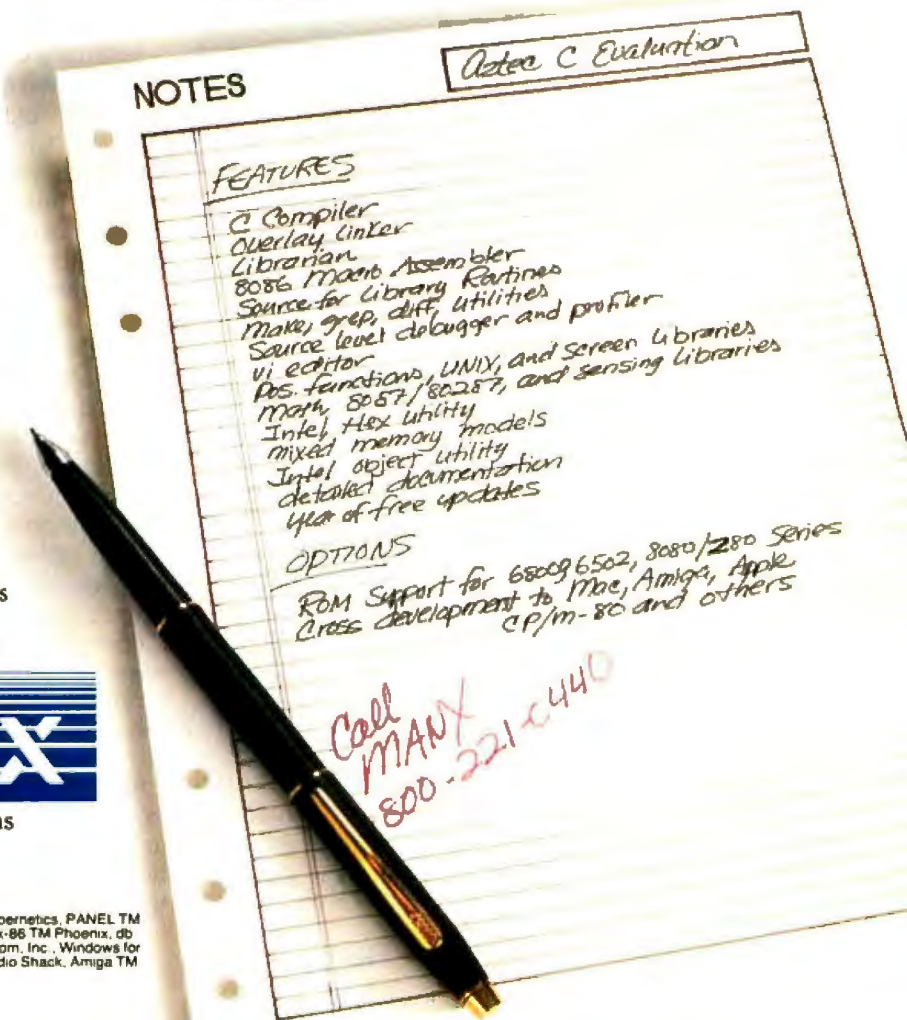

# 210 Years Ago Boston Was The Starting Place Of An Important Revolution...



## LaserActive '86

Tradeshow and concurrent conferences.



**...In 1986 it's the site of an  
important evolution.**

Interactive Video and Optical Storage Systems have gone through the revolutionary stage of new technology development.

The incredible potential for software, database, and problem solving applications awaits only a spark from your mind! Come see the industry's leading companies display over 100 applications that expand the characteristics, capabilities, and capacities of computers to create entire new markets. Come learn what it takes to program and work with this new exciting, laser-read media. Be an early part of the evolution of the revolution at LaserActive '86.

- Seven concurrent conferences covering everything from beginning with optical storage systems to applying their use to the needs of major vertical markets.
- A special conference sponsored by Howard Sams' Books will cover programming for this new media. Don't miss the new Howard Sams' book, *CD-I and Interactive Videodisc Technical Reference Guide*.

### For Immediate Information:

Call: 305/768-2778

Write: POB 3415

Indialantic, FL 32903

Inquiry 195 for Howard Sams' book only.

ACCORDING TO WEBSTER

---

*If I had to own just one  
C compiler for the Mac—indeed,  
just one compiler—it would  
probably be LightspeedC.*

---

a profiling utility to help you see where your program is spending most of its time.

The single greatest weakness with LightspeedC isn't the product itself, it's how big and poorly organized the manual is. It's difficult to dig out the information that you need and that is usually (but not always) there. More than half the manual is devoted to documenting the 200-plus library functions (a few per page, listed in alphabetical order) as well as the calling sequences for the Mac routines (listed according to the manager groupings of *Inside Macintosh*). The irony is that the ordering for both sets of routines probably should have been the other way around. If you are a programmer, you probably already know the name of the Mac routine and just want to find the calling sequence; the manual forces you to find out what manager it's in. If you're looking for a particular C library function, you probably know what you want the function to do, but not necessarily what its name is, especially if you're not a whizbang C programmer. Given the penchant for cryptic C function names (quick! guess what the following functions do: atol, cputs, getuid, iscsymf, sbrk, sci\_d, strpbrk, ttyn, vsprintf), you may have to resort to thumbing through some 162 pages of function descriptions to find the one you need.

For an experienced Mac C programmer, this and other organizational problems are probably no more than an annoyance. However, for an experienced programmer who is not particularly familiar with either C (like me) or the Mac, it's frustrating; for someone familiar with neither, especially if said person isn't an experienced programmer, it would probably be a nightmare. Which is really a shame, since LightspeedC strikes me as an excellent environment for learning C and programming on the Mac.

Those of you familiar with my column know that I am not enamored of C, but LightspeedC goes a long way toward making it my language of choice on the Macintosh (and, of course, LightspeedC my compiler of choice), despite the Pascal/C interface problems that confront all C compilers on the Mac. If I had to own just one C compiler for the Mac—indeed, just one compiler—it would probably be LightspeedC. Until someone comes out with a comparable Pascal development system.

### PREDICTION UPDATE

In my January 1986 column (which was actually written in September 1985), I made a series of predictions about how the microcomputer industry would develop during the coming year. Much to my surprise (and delight), most

(continued)



**The inventors of the 3.5" drive  
recommend only one floppy disk.  
Theirs.**

If your computer has 3.5" drives, it has a little bit of Sony. Because Sony invented the 3.5" drive technology that has taken floppy disk memory all the way to two megabytes.

So nobody knows better than Sony how important high standards are for producing 3.5" floppy disks. But then, Sony invented those, too, as well as the most demanding methods for making 3.5" disks.

Such as the Sony Vivax™ magnetic medium, with the high coercive force necessary to suppress the "noise" that can cause disk error. And the Sony DDL™ binder system for incredibly even dispersion of magnetic particles on the disk surface. Then there's Sony's burnishing expertise that eliminates microscopic projections as small as 1/1,000,000th of a millimeter.

But the best reason to trust only Sony is your irreplaceable data. After all, you'll be storing six times the information on a disk that's one-third smaller than a 5.25" floppy. That's why we recommend only one floppy disk for our 3.5" drives. The Sony.

**SONY®**  
THE ONE AND ONLY.

© 1984 Sony Corporation of America. Sony, Vivax, DDL, and The One and Only are trademarks of Sony.

Inquiry 323

# New Quark<sup>SM</sup>/PC Single Board Computer



Base model 5.75" x 8"  
Only \$ **495.**

Quantity discounts available

- IBM PC<sup>®</sup> compatible single board computer mounts to 5 1/4" drive
- Includes Floppy Disk & Color Graphics CRT Controllers plus more

**Also includes:** Legal BIOS • Boots PC DOS<sup>®</sup> 2.1 • Printer Port • 2 Serial Ports • 256K RAM • Clock Speed at 4.77 MHz • Alphanumeric and Graphics Modes for Color Video Controller • Standard IBM<sup>®</sup> Keyboard Port.

**Options include:** 512K RAM • Piggyback I/O channel OEM Expansion Board • XT- Compatible Hard Disk SCSI interface • Real Time Clock with battery-back-up • Clock speed of 9.5 MHz (twice as fast as a PC)

The Megatek Quark/PC is for OEM and end user applications that require PC compatibility in a compact single board computer. The Quark/PC BIOS will run most IBM PC<sup>®</sup> software including Flight Simulator and Lotus<sup>®</sup>. To meet your specifications a set of options let you add memory, speed and an XT-compatible hard disk interface. Not only does it quickly mount to a 5 1/4" drive, it also comes with floppy disk and CRT color graphics controllers — all for just \$495.

To order or enquire call us today. Dealer enquiries welcome. Megatek Computer Technologies (416) 745-7214 150 Turbine Drive Weston, Ontario M9L 2S2 Telex: 065-27453 U.S. Address: 1051 Clinton St., Buffalo, N.Y. 14206 Distributors: NCS Electronics Varese, Italy • SES Electronics Nordlingen, Germany • Perdix Microtronics Biggin Hill, U.K. • Microcomputing Ghent, Belgium • Asp Microcomputers Melbourne, Australia.

Quark is a registered trademark of F and K MFG. CO LTD. IBM, IBM PC and PC DOS are registered trademarks of International Business Machines Corp. Lotus is a registered trademark of Lotus Development Corp. MS-DOS is a registered trademark of Microsoft Corp.

**megatek**

of those predictions have been coming true within the past month or two or at least appear to be headed in that direction. To wit:

- The Apple IIe/IIc is losing ground to the Amiga and the Atari ST (though not nearly as fast as I thought it would); in response, Apple is working on the IIx (which may be out by the time you read this) and will probably cut prices on the IIe and IIc to well below the \$600 level, especially as Christmas approaches.

- Apple has committed itself (in its annual report, no less) to an open-architecture Mac. Apple has made no official statements on what the open Mac will have, but the grapevine indicates slots, a 68020 processor, faster disk drives, more memory, a larger display, and possibly even color. And, I suspect, a fan.

- John Scully told analysts that all future Macintosh products would be capable of running both UNIX and MS-DOS. Also, at least one third-party vendor should be shipping UNIX System V for the Macintosh around the time this column sees print.

- Analysts are generally pleased with Scully's commitment to MS-DOS and UNIX (and with Apple's direction in general), especially since (according to said analysts) it gives Apple a better shot at getting into corporate markets. Apple stock now stands (this is mid-May, remember) at around \$32/share, up substantially from last fall and more than double its low value during the last year.

- Commodore showed (at COMDEX/Atlanta) the Sidecar, an MS-DOS box with an 8088 processor, an IBM PC-compatible BIOS, expansion slots, and 5 1/4-inch disk drives. (Atari is also developing an MS-DOS box for the ST, but I didn't predict that.)

- In addition to Apple's open commitment to UNIX, sources at both Atari and Commodore have indicated that future products will include UNIX-based systems, or at least systems with UNIX (or a look-alike) as an option.

- The 68000 family is having a good year, though the leading edge of the market already seems to be shifting away from the 68000 to the 68020 (bypassing the 68010 completely). Motorola is apparently selling all the 68020s it can make (and then some). And anyone not making an IBM PC compatible appears to be choosing the 68000 (with the exception of the IIx, which apparently will use the 65816).

- IBM announced (finally!) the PC Convertible, its laptop computer, which does, indeed, look to be decently designed; the surprise is that the pricing and marketing appear to be better than average, though I wonder how hard IBM will actually push the machine. The only other announcements have been slight improvements (along with price cuts) on the XT and AT, mostly to catch up with the clone makers. And speaking of the clone makers. . .

- During the last week or so, articles in the *Wall Street Journal*, *Newsweek*, and elsewhere have focused on the cheap, well-built IBM PC compatibles that are flooding the MS-DOS market and are threatening to (as a group) pass IBM unit sales by the end of this year or early in 1987. It has reached the point where the name "IBM" on the front

# Customize Your Keyboard

- Eliminate Confusion
- Reduce Training Time
- Increase Productivity

Need Custom Keytops?  
Call us at 602 634-7515

**Hooleon**  
CORPORATION

P. O. Box 201, Dept. BY,  
Cornville, AZ 86325



**KEYTOPS**—Kits to support most software, including:

- \_\_\_ PC to 5251 \$21.95
- \_\_\_ PC to 5520 \$29.95
- \_\_\_ DisplayWrite 3 \$21.95
- \_\_\_ WordPerfect 4.1 \$29.95

**KEY EXPANDERS** Touchdown™ key expanders enlarge small, critical keys (Return, Shift, Backspace, etc.) on the IBM PC and look-alikes to full-size, AT-style keys. Full kit has 12 separate expanders. Mini-Kit: Enter/Ret, both shifts, backspace. All kits support LED where needed. Must specify keyboard

Language conversions available!  Send me FREE INFORMATION

Specify Keyboard Make/Model. \_\_\_\_\_

Name \_\_\_\_\_

Address \_\_\_\_\_

City, St., Zip \_\_\_\_\_

VISA  MC # \_\_\_\_\_ Exp. \_\_\_\_\_

Visa or MC orders: 602 634-7515 Same Day Shipment • U.S. Postage Paid



Inquiry 162 for End-Users.  
Inquiry 163 for DEALERS ONLY.

ACCORDING TO WEBSTER

ITEMS DISCUSSED

**LIGHTSPEEDC** .....\$175  
 Think Technologies Inc.  
 420 Bedford St.  
 Lexington, MA 02173  
 (617) 863-5593

**TURBO PROLOG** .....\$99.95  
 Borland International  
 4585 Scotts Valley Rd.  
 Scotts Valley, CA 95066  
 (800) 255-8008 (outside California)  
 (800) 742-1133 (in California)

panel is seen as a liability in some market segments because it usually means higher prices and lower performance.

Okay, so where did I mostly go wrong? Well, the ST and Amiga have not been runaway successes, though both appear to be selling better than competitors and detractors wish to believe. And I'm not sure there's been the "big upswing" in the home market that I predicted. On the other hand, this is only May; that surge may hit at Christmas. That (together with production problems) has probably held down sales of the Amiga and the ST; given the lack of reliable sales figures from either firm, though, it's hard to judge. The open Mac appears to be slower coming to market than I thought it would be and may not even show up until early next year. But it is coming.

The big question right now is the ultimate impact of the layoffs at Commodore, which included some key people at the Commodore-Amiga (Los Gatos) facility. This could be an honest-to-goodness belt-tightening move, such as Apple made back in 1985 (to good effect). Or it could signal serious trouble at Commodore. By the time you read this, you should have a better idea of which it is. My guess? I think Commodore and the Amiga will still be around come September.

**IN THE QUEUE**

Well, it looks like next month may be Round 3 of the 68000 wars. I now have for a few brief weeks a Prodigy 4 from Levco, which I mentioned a few columns ago under the name Super Mac 20. From the outside, it looks like a regular Mac; on the inside, it's got a 16-megahertz 68020 processor, a 68881 floating-point coprocessor, 4 megabytes of RAM, and a 20-megabyte hard disk (running on an SCSI interface). I also hope to line up Computer System Associates' 68020/68881 expansion board for the Amiga, as well as General Computer's HD-2000 upgrade for the Macintosh. And Apple wants to swap the plain-vanilla 512K Mac that they've been lending me for a Mac Plus. I've got some software products I want to get to as well, including Multi-FORTH, Aztec C, and TDI Modula-2 for the Amiga. But, as always, I'm making no promises. Until then, I'll see you on the bit stream. ■

8086  
8088  
Now  
68000

AMX

8080  
Z80  
6809

## Real-Time Multitasking Executive

- No royalties
- Source code included
- Fault free operation
- Ideal for process control
- Timing control provided
- Low interrupt overhead
- Inter-task messages

**Options:**

- Resource Manager
- Buffer Manager
- Integer Math Library

■ Language Interfaces :

|      |         |  |  |
|------|---------|--|--|
| C    | Pascal  |  |  |
| PL/M | Fortran |  |  |

■ DOS File Access :

|            |  |  |  |
|------------|--|--|--|
| CP/M-80    |  |  |  |
| IBM PC DOS |  |  |  |

AMX is TM of KADAK Products Ltd  
 CP/M-80 is TM of Digital Research Corp.  
 IBM, PC DOS are TM of IBM Corp.

|                            |  |  |                  |
|----------------------------|--|--|------------------|
|                            |  |  |                  |
| <b>AMX for 8080</b>        |  |  | <b>\$ 800 US</b> |
| 8086                       |  |  | 950              |
| 6809                       |  |  | 950              |
| 68000                      |  |  | 1600             |
| Manual (specify processor) |  |  | 75               |

**KADAK Products Ltd.** (604) 734-2796  
 Telex: 04-55670  
 206-1847 W. Broadway, Vancouver, B.C., Canada V6J 1Y5

OEM DESIGN/DEALERS WELCOME!!

99% Hayes compatible 300/1200

BEST ON THE MARKET

ONLY \$129

FOR DEALERS OR GROUP USER ...\$85 each

(Minimum purchase over 100 units)

ALPHA CONCORD

MODEM

- Auto dial, auto answer (tone or pulse)
- 8 status indicators & switch selectable
- Auto speed selection (0-300, 1200 tps)
- Speaker with volume control
- Aluminum case, with adaptor

6 MONTH WARRANTY

NEW !! 2400 MODEM

MODEM \$229

BUILD YOUR PORTABLE XT/AT

AT/XT PORTABLE \$119

(Price is for CASE only.) Add \$27 shipping.  
 Full size keyboard  
 9" monitor, 130 watt power supply extra

Replacement & 99% Compatible

AT COMPATIBLE MOTHERBOARD

\$360

(Price do not include any INTEL IC)  
 XT MAINBOARD \$125

AT/XT KIT

AT \$279  
XT \$169

(Price include only case, power supply, & keyboard)

CONCORD Technology Ltd.

47 W. Broadway, Van., B.C. Canada V5Y 1P1  
 Ph. (604) 879-3555 or 879-7419

FACTORY PRICES ON

EGA CARD \$210

**THE CMO ADVANTAGE**

**HOME COMPUTERS**

**MODEMS**

**TO ORDER  
CALL TOLL FREE  
1-800-233-8950**  
DEPARTMENT A109  
TELEX 5106017898

OR MAIL YOUR ORDER TO:  
**COMPUTER MAIL ORDER**  
Department A109  
477 E. Third Street  
Williamsport, PA 17701



**POLICY Inquiry 82**

Add 3% (Minimum \$7.00) shipping and handling. Larger shipments may require additional charges. Personal and company checks require 3 weeks to clear. For faster delivery use your credit card or send cashier's check or bank money order. Pennsylvania residents add 6% sales tax. All prices are subject to change and all items are subject to availability. Defective software will be replaced with the same item only. Hardware will be repaired or replaced at our discretion within the terms and limits of the manufacturer's warranty. We cannot guarantee compatibility. All sales are final and returned shipments are subject to a restocking fee.

**EDUCATIONAL INSTITUTIONS  
CALL TOLL FREE  
1-800-221-4283**

**CANADIAN ORDERS**

1-800-268-3974

Ontario/Quebec

1-416-828-0866

In Toronto

1-800-268-4559

Other Provinces

TELEX: 06-218960

2505 Dunwin Drive,  
Mississauga, Ontario  
Canada L5L1T1

All prices shown are for U.S.A. orders. Call the Canadian Office for Canadian prices

**THE CMO ADVANTAGE**

- Next day shipping on all in-stock items.
- Orders from outside Pennsylvania save state sales tax.
- There is no limit and no deposit on C.O.D. orders.
- There is no extra charge for using your Visa or MasterCard and your card is not charged until we ship
- No waiting period for cashier's checks.
- We accept purchase orders from qualified corporations. Subject to approval.
- Educational discounts available to qualified institutions. (See the toll free educational phone number above.)
- FREE CATALOG MEMBERSHIP

**ATARI**

|                   |          |
|-------------------|----------|
| 85XE (64K).....   | \$89.99  |
| 130XE (128K)..... | \$129.00 |
| 520ST (512K)..... | \$369.00 |

**520ST Monochrome System**

- 520ST with modulator
- disk drive
- mouse
- logo
- Basic
- Neochrome Sampler
- monochrome monitor

LOW, LOW SYSTEM PRICE  
**\$54900**

**520ST Color System**

- 520ST with modulator
- disk drive
- mouse
- logo
- Basic
- Neochrome Sampler
- color monitor

LOW, LOW SYSTEM PRICE  
**\$76900**

|                                |          |
|--------------------------------|----------|
| 800XL 64K.....                 | \$69.99  |
| 1010 Recorder.....             | \$49.99  |
| 1050 Disk Drive.....           | \$129.00 |
| 1020 Printer.....              | \$29.99  |
| 1027 Letter Quality Pntr.....  | \$119.00 |
| M301 Direct Connect Modem..... | \$39.99  |

**APPLE**

|                      |          |
|----------------------|----------|
| APPLE IIe.....       | CALL     |
| APPLE IIc.....       | CALL     |
| IIc LCD Display..... | \$249.00 |

**COMMODORE**

- Amiga Package**
- 512K
  - 2 - 3 1/2" DS Disk Drives
  - Amiga RGB Monitor..... **\$1599.00**

- C64 Package**
- C64
  - C1541
  - Taxan 220..... **\$499.00**

- C128 Package**
- C128
  - C1571
  - NAP8562 Monitor..... **\$779.00**

**C128 Computer.....\$269.00**

**C1571 (Disk Drive for C128).....\$249.00**

**C1902 (RGB 13" Monitor for C128).....CALL**

**C1670 (Modem for C128)\$179.00**

C1530 Datasette..... \$39.99

C1660 Auto Modem..... \$59.99

Xetec SuperGraphix 8K..... \$69.99

Micro R&D 128/64 Interface..... \$54.99

C128 Universal Monitor Cable..... \$9.99

**PORTABLE COMPUTERS**

**NEC**

|                                |          |
|--------------------------------|----------|
| PC-8401 LS.....                | \$699.00 |
| PC-8231 Disk Drive.....        | \$599.00 |
| PC-8221A Thermal Printers..... | \$149.00 |
| PC-8281A Data Recorder.....    | \$99.99  |

**SPECIAL**

- NEC 8201 Computer
- 8K Ram Cartridge
- 300 Baud Modem..... **\$37900**

**SHARP**

|                                    |          |
|------------------------------------|----------|
| PC-1350.....                       | \$149.00 |
| PC-1281.....                       | \$149.00 |
| PC-1500A.....                      | \$169.00 |
| PC-1250A.....                      | \$89.99  |
| CE-125 Printer/Cassette.....       | \$129.00 |
| CE-150 Color Printer Cassette..... | \$149.00 |
| CE-161 16K RAM.....                | \$129.00 |
| PC-7000 PC Compatible.....         | CALL     |



|                               |          |
|-------------------------------|----------|
| 41CV.....                     | \$139.00 |
| 41CX.....                     | \$199.00 |
| HP 11C.....                   | \$49.99  |
| HP 12C.....                   | \$75.99  |
| HP 15C.....                   | \$75.99  |
| HP 16C.....                   | \$89.99  |
| HPIL Module.....              | \$98.99  |
| HPIL Cassette or Printer..... | \$359.99 |
| Card Reader.....              | \$143.99 |
| Extended Function Module..... | \$63.99  |
| Time Module.....              | \$63.99  |

We stock the full line of HP calculator products

**ACCESSORIES**

**AMARAY**

|                              |         |
|------------------------------|---------|
| 80 Column Printer Stand..... | \$14.99 |
|------------------------------|---------|

**CURTIS**

|                              |         |
|------------------------------|---------|
| Side Mount SS-1.....         | \$19.99 |
| Side Mount AT SS-2.....      | \$34.99 |
| Universal Stand SS-3.....    | \$19.99 |
| Diamond SP-1.....            | \$29.99 |
| Emerald SP-2.....            | \$39.99 |
| Sapphire SPF-1.....          | \$49.99 |
| Ruby SPF-2.....              | \$59.99 |
| Universal Printer Stand..... | \$14.99 |
| Static Mat.....              | \$29.99 |

**DATA SHIELD**

|                                  |          |
|----------------------------------|----------|
| 300 Watt Backup.....             | \$379.00 |
| 500 Watt Backup.....             | \$589.00 |
| Turbo 350 Watt Backup.....       | \$449.00 |
| P125 Power Director.....         | \$99.99  |
| P150 Power Director w/Modem..... | \$119.00 |
| 585 Surge Protector.....         | \$89.99  |
| 5100 Surge Protector.....        | \$79.99  |

**KENSINGTON**

|                     |          |
|---------------------|----------|
| Master Piece.....   | \$99.99  |
| Master Piece +..... | \$119.00 |

**KEYTRONICS**

|                              |      |
|------------------------------|------|
| KB5150/KB5151/KB5151Jr.....  | CALL |
| KB5152B/KB5153/KB5149Jr..... | CALL |

**MEMORY CHIPS**

|                     |              |
|---------------------|--------------|
| 4164 RAM Chips..... | (ea.) \$1.99 |
| 128 RAM Chips.....  | (ea.) \$4.99 |
| 256 RAM Chips.....  | (ea.) \$3.99 |

**Polaroid**

|                                |           |
|--------------------------------|-----------|
| Palette.....                   | \$1399.00 |
| Power Processor.....           | \$229.00  |
| Illuminated Slide Mounter..... | \$39.99   |
| Polacolor 2 Pack film.....     | \$18.99   |

**DISKETTES**

**GENERIC**

|                   |         |
|-------------------|---------|
| 5 1/4" DS/DD..... | \$10.99 |
|-------------------|---------|

**IBM**

|                                            |         |
|--------------------------------------------|---------|
| 5 1/4" DS/DD floppy disks (Box of 10)..... | \$25.99 |
|--------------------------------------------|---------|

**maxell**

|                                 |         |
|---------------------------------|---------|
| 3 1/2" SS/DD (10).....          | \$18.99 |
| 3 1/2" DS/DD (10).....          | \$29.99 |
| 5 1/4" MD-1 SS/SD (10).....     | \$11.99 |
| 5 1/4" MD-2 DS/DD (10).....     | \$16.99 |
| 5 1/4" MD-2-HD for AT (10)..... | \$29.99 |

**SONY**

|                                     |         |
|-------------------------------------|---------|
| MD1-5 1/4" SS/SD (10).....          | \$9.99  |
| MD2-5 1/4" DS/DD (10).....          | \$13.99 |
| MD2HD-5 1/4" High Density (10)..... | \$28.99 |
| MFD1-3 1/2" SS/DD (10).....         | \$18.99 |
| MFD2-3 1/2" DS/DD (10).....         | \$29.99 |

**Verbatim.**

|                    |         |
|--------------------|---------|
| 5 1/4" SS/DD.....  | \$12.99 |
| 5 1/4" DS/DD.....  | \$24.99 |
| Disk Analyzer..... | \$24.99 |

**DISK HOLDERS**

**AMARAY**

|                                 |         |
|---------------------------------|---------|
| 50 Disk Tub 5 1/4".....         | \$9.99  |
| 30 Disk Tub 3 1/2".....         | \$9.99  |
| 100 Disk Tub 5 1/4" w/lock..... | \$19.99 |

**INNOVATIVE CONCEPTS**

|                            |         |
|----------------------------|---------|
| Flip'n File 10.....        | \$2.49  |
| Flip'n File 50.....        | \$11.99 |
| Flip'n File Data Case..... | \$9.99  |

**ANCHOR**

|                                  |          |
|----------------------------------|----------|
| Volkmodem.....                   | \$59.99  |
| Volkmodem 300/1200.....          | \$139.00 |
| Signalman Express.....           | \$209.00 |
| Lightning 2400 Baud.....         | \$329.00 |
| Express (PC Hallicard).....      | \$149.00 |
| 6480 (64/128) 300/1200 Baud..... | \$129.00 |
| 520 1200 BPS (Atari ST).....     | \$139.00 |
| Lightening Hall Card (PC).....   | \$349.00 |
| Omega 80 (Amiga).....            | \$139.00 |

**AST**

Reach 1200 Baud Half Card. \$399.00

**DIGITAL DEVICES**

AT300 - 300 Baud (Atari) \$99.99

**EVEREX**

1200 Baud Internal (IBM/PC)..... \$149.00



|                       |          |
|-----------------------|----------|
| Smartmodem 300.....   | \$139.00 |
| Smartmodem 1200.....  | \$389.00 |
| Smartmodem 1200B..... | \$359.00 |
| Smartmodem 2400.....  | \$589.00 |
| Micromodem IIe.....   | \$149.00 |
| Smart Com II.....     | \$89.99  |
| Chronograph.....      | \$199.00 |
| Transet 1000.....     | \$309.00 |



|                     |          |
|---------------------|----------|
| Smart Cat Plus..... | \$299.00 |
| J-Cat.....          | \$99.99  |
| Novation 2400.....  | \$499.00 |

**PRACTICAL PHERIPHERALS**

|                               |          |
|-------------------------------|----------|
| 1200 Internal.....            | \$139.00 |
| 1200 External.....            | \$169.00 |
| 1200 Multifunction Modem..... | \$269.00 |

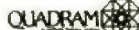

|                    |          |
|--------------------|----------|
| Quadmodem II       |          |
| 300/1200.....      | \$299.00 |
| 300/1200/2400..... | \$499.00 |



|                                  |          |
|----------------------------------|----------|
| MPP-1064 AD/AA (C-64).....       | \$69.99  |
| 1200 AT (Atan 8 Bit).....        | \$149.00 |
| 1200 ST (520 300/1200 Baud)..... | \$149.00 |

**DRIVES**

**OMEGA**

|                            |           |
|----------------------------|-----------|
| A210H 10 + 10.....         | \$1995.00 |
| A220H 20 + 20.....         | \$2499.00 |
| Save on 10 & 20 Cartr..... | CALL      |

**TALLGRASS**

25, 35, 50, 80 meg (PC)..... from \$1299.00

**IRWIN**

T110 Tape Back-up..... \$449.00

**EVEREX**

60 Meg Internal Backup System..... \$799.00

20 Meg Streamer..... \$699.00

**MOUNTAIN**

Hard Drives..... CALL

Hard Card 20 MB..... \$699.00

Hard Card 30 MB..... \$999.00

Tape Back-Up..... CALL

**PRIAM**

40, 60 MB Inner Space..... CALL

Shared Data..... CALL

Shared Space..... CALL

**RACORE**

1500 Expansion Chassis..... \$379.00

1500 Chassis w/DMA..... \$429.00

2101 256K Memory..... \$179.00

2100 512K Memory..... \$199.00

**CMS**

10 Meg with controller..... \$369.00

20 Meg with controller..... \$469.00

Rambo-AT..... \$229.00

**ALLIED TECHNOLOGY**

Apple II, III +, IIe 1/2 height..... \$109.00

**INDUS**

Atari GT..... \$189.00

C-64 /128 GT..... \$189.00

**MSD**

SD1 C-64 Single..... \$219.00

SD2 C-64 Dual..... \$469.00

**TANDON**

320K 5 1/4" (PC)..... \$99.00

**TEAC**

320K 5 1/4"..... \$99.00



**SOFTWARE FOR IBM**

**PRINTERS**

**MULTIFUNCTION CARDS**

**IBM Inquiry 82**

**ANSA SOFTWARE**

Paradox.....\$499.00

**ASHTON-TATE**

Framework II.....CALL  
dBase III Plus.....CALL

**BATTERIES INCLUDED**

Iegur Portfolio.....\$159.00

**BORLAND**

Lightening.....\$59.99  
Sidekick (unprotected).....\$57.99  
Reflex.....\$59.99  
Travelling Sidekick.....\$44.99  
Turbo Prolog.....\$64.99

**CENTRAL POINT**

Copy II PC-Backup.....\$29.99  
PC Option Board.....\$84.99

**DECISION RESOURCES**

Chartmaster.....\$229.00  
Signmaster.....\$159.00  
Diagram Master.....\$209.00  
Map Master.....\$269.00

**FIFTH GENERATION**

Fast Back.....\$89.99

**FUNK SOFTWARE**

Sideways.....\$44.99

**HARVARD SOFTWARE INC.**

Total Project Manager.....\$269.00  
Presentation Graphics.....\$239.00

**IMSI**

PC Mouse/Dr. Halo.....\$119.00

**LIFETREE**

Volkswriter III.....\$149.00

**LIVING VIDEOTEXT**

Think Tank.....\$109.00  
Ready.....\$64.99

**LOTUS**

Symphony.....CALL  
1-2-3 Version 2.....CALL

**MECA SOFTWARE**

Managing Your Money 2.0.....\$99.99  
Manage Your Market.....\$89.99

**MICROPRO**

WordStar 2000.....\$239.00  
WordStar 2000+.....\$289.00  
WordStar Pro. w/GL Demo.....\$189.00

**MICROMIM SOFTWARE**

R-Base 5000.....\$359.00  
Clout 2.0.....\$129.00  
R-Base System V.....\$469.00

**MICROSOFT**

Flight Simulator.....\$34.99  
MultiPlan.....\$129.00  
Word 3.0.....\$279.00  
Mouse.....\$139.00

**MICROSTUF**

Crosstalk XVI.....\$89.99  
Crosstalk Mark IV.....\$149.00  
Remote.....\$89.99

**MULTIMATE**

Multi Mate Word Proc.....CALL  
Advantage.....\$269.00

**NOUNEMON**

Intuit.....\$69.99

**NORTON**

Norton Utilities 3.1.....\$57.99

**ONE STEP**

Golf's Best Pinhurst.....\$34.99

**PFS: IBM**

Proof.....\$59.99  
File/Graph.....(ea.) \$84.99  
Report.....\$74.99  
Write/Proof Combo.....\$84.99

**THE SOFTWARE GROUP**

Enable.....\$349.00

**SATELLITE SYSTEMS**

Word Perfect 4.1.....\$219.00

**SORCIMMIUS**

Accounting AP/AR/GL/IN/VOE.....(ea.) \$299.00  
SuperCalc III.....\$219.00  
EasyWriter II System.....\$239.00  
Super Project.....\$219.00  
SuperCalc 4.....\$329.00

**SUBLOGIC**

Jel.....\$37.99

**Canon**

A40,A50,A55.....from \$239.00  
LBP-8A1 Laser.....\$1999.00

**CITIZEN**

MSP-10 (80 col.).....\$279.00  
MSP-15 (132 col.).....\$419.00  
MSP-20 (80 col.).....\$349.00  
MSP-25 (132 col.).....\$469.00  
MSP-35 (LQ).....\$449.00

**C. ITOH**

Prowriter 1550P.....\$299.00  
Starwriter 10-30.....\$299.00  
3500 Tri Pntr.....CALL

**corona**

Lazer LP-300.....\$2199.00

**DIABLO**

D25 Daisywheel.....\$549.00  
635 Daisywheel.....\$1099.00  
D80IF Daisywheel.....CALL

**daisywriter**

2000.....\$699.00

**EPSON**

Homewriter 10, LX-80.....CALL  
FX-85, FX-286, RX-100.....CALL  
DX-10, DX-20, DX-35.....CALL  
SQ-2000, HI-80, HS-80, AP-80.....CALL  
LQ-800, LQ-1000.....CALL

**JUKI**

6000 Letter Quality.....CALL  
6100 Letter Quality.....CALL  
6200 Letter Quality.....CALL  
6300 Letter Quality.....CALL  
6500 Letter Quality.....CALL  
5510 Dot Matrix Color.....CALL

**LEGEND**

860 Dot Matrix 100 cps.....\$179.00  
1080 Dot Matrix 100 cps.....\$259.00  
1360 Dot Matrix 130 cps.....\$289.00  
1385 Dot Matrix 165 cps.....\$339.00

**NEC**

3000 Series.....\$779.00  
8000 Series.....\$1099.00  
ELF 360.....\$399.00  
P560, P660, P760.....CALL

**OKIDATA**

182, 183, 192, 193, 2410, 84.....CALL  
Okimate 10 (Specify C64/Atari)\$189.00  
Okimate 20(IBM), 282, 283.....CALL  
Okidata 93.....\$299.00

**Panasonic**

KX1080.....\$199.00  
KX1091.....\$239.00  
KX1092.....\$359.00  
KX1592.....\$469.00  
KX1595.....\$659.00

**QUADRAM**

Quadjet.....\$199.00  
Quad Laser LS-1000.....CALL

**SILVER-REED**

500 Letter Quality.....\$239.00  
550 Letter Quality.....\$299.00  
800 Letter Quality.....\$699.00

**star**

SG-10C (C64 Interface).....CALL  
SB/SD/NX/NL/SR Series.....CALL  
Powertype Letter Quality.....CALL

**Texas Instruments**

T1850.....\$529.00  
T1855.....\$639.00  
T1865.....\$799.00

**TOSHIBA**

P321 (80 column).....\$489.00  
P341 (132 column).....\$749.00  
P351 (132 column).....\$1049.00

**AST**  
RamVantage.....\$349.00  
Rampage-PC.....\$299.00  
Six Pack Premium.....\$219.00  
Six Pack Plus.....\$169.00  
I/O Plus II.....\$139.00  
Advantage-AT.....\$369.00  
Preview Mono.....\$299.00  
PC Net Cards.....\$379.00  
5251/11 On-line.....\$669.00  
5251/12 Remote.....\$579.00  
5251/11 Plus.....\$719.00

**dea**  
IRMA 3270.....\$839.00  
IRMA Print.....\$999.00  
IRMA Smart Alec.....\$779.00

**SEVEREX**  
Edge Card.....\$259.00  
Graphics Edge.....\$219.00  
Magic Card II.....\$159.00  
Magic Card I.....\$99.99  
EGA Video.....\$299.00

**HERCULES**  
Graphics.....\$199.00  
Color.....\$159.00

**IBEA Associates**  
IDEA 5251.....\$549.00

**INTEL**  
PCNC8087 5MHz.....  
PCNC8087-2 8 MHz.....  
PCNC80287 6 MHz AT.....CALL  
PCNC80287 8 MHz AT.....FOR  
1010 PC-Above Board.....YOUR  
1110 PS-Above Board.....PC  
2010 AT-Above Board.....  
2110 AT-Above Board-PS.....

**MYLEX**  
The Chairman.....\$439.00

**PARADISE**  
Color/Mono Card.....\$149.00  
Multi Display Card.....\$199.00  
High Res Mono.....\$169.00  
Autoswitch EGA.....\$379.00  
Modular Graphics Card.....\$269.00

**PERSYST**  
Bob Board.....\$359.00

**QUADRAM**  
Quadport-AT.....\$119.00  
Liberty-AT (128K).....\$349.00  
The Gold Quadboard.....\$449.00  
The Silver Quadboard.....\$239.00  
Expanded Quadboard.....\$159.00  
Liberty.....\$309.00  
QuadSprint.....\$499.00  
QuadLink.....\$399.00  
QuadColor.....\$199.00  
Quadboard-AT.....\$399.00  
8600 E.G.A. card.....\$399.00

**STB**  
EGA Plus.....\$329.00

**TECMAR**  
Captain - 64.....\$199.00  
Graphics Master.....\$469.00

**VIDEO-7**  
EGA.....\$349.00

**INTERFACES**

**AST**  
Multi I/O (Apple II).....\$139.00

**DIGITAL DEVICES**

Ape Face (Atari).....\$39.99  
U-Print A (Atari).....\$49.99  
U-A16/Buffer (Atari).....\$69.99  
U-Call Interface (Atari).....\$39.99  
U-Print C (C64).....\$44.99  
P-16 Print Buffer.....\$69.99  
U-Print 16 Apple IIc.....\$79.99

**MICRO R & D**

Apple IIc Parallel.....\$49.99  
Kaypro 2000 Parallel.....\$49.99  
CG4/128.....\$54.99

**Orange Mikro**

Grappler CD (C64).....\$89.99  
Grappler Plus (Ite, IIc).....\$89.99  
Grappler C (IIC).....\$89.99  
Grappler 16K (Ite, II+).....\$139.00

**PRACTICAL FORMERALS**

Graphicard.....\$69.99  
Serial Card.....\$99.99  
Microbuffer II + 64K.....\$169.00

**QUADRAM**

Microfazer.....from \$139.00  
Elazer (Epson).....from \$79.99

**IBM PC SYSTEMS**

Configured to your specifications.  
**Call for Best Price!**

IBM-PC, IBM-XT, IBM-AT

**AT&T 6300**.....CALL

**corona**

PPC400 Dual Portable.....\$1199.00  
PPCXT 10 meg Portable.....\$1799.00  
PC40022 Dual Desktop.....\$1289.00  
PC400-HD2 10 meg.....\$1799.00

**KAYPRO**

KP-2000 Portable.....CALL  
Kaypro PC.....CALL

**PC100 IBM CLONE**

640K MB-256 installed, 150 Watt Power Supply, XT Keyboard, 360K Floppy, 20 Meg Hard Drive.....\$999.00

**SPERRY**

Sperry-AT.....as low as \$1749.00  
Sperry-IT.....as low as \$2699.00  
Call for Specific Configuration!  
All Models.....CALL

**ZENITH**

PC-138 Series, PC-148 Series, PC-158 Series, PC-160 Series, PC-171 Series, AT-200 Series.....CALL

**MONITORS**

**AMDEK**

Video 300A Amber.....\$129.00  
Video 310A Amber TTL.....\$159.00  
410 TTL Amber or Green.....CALL  
Color 600 Hi-Res. RGB.....\$399.00  
Color 722 Dual Mode.....\$529.00  
Color 725.....\$619.00  
Color 730.....\$749.00

**MAGNAVOX**

515 RGB/Composite.....\$299.00  
613 TTL Green.....\$99.99  
623 TTL Amber.....\$99.99

**NEC**

JB1280G TTL Green.....\$129.00  
JB1285A TTL Amber.....\$129.00  
JC1401 Multi Sync RGB.....CALL

**PRINCETON**

MAX-12 Amber.....\$169.00  
HX-12 12" RGB.....\$459.00  
HX-12E Enhanced.....\$549.00  
SR-12 Hi-Res.....\$589.00  
SR-12P Professional.....\$649.00

**QUADRAM**

8400 Quadchrome I.....\$449.00  
8420 Amberchrome.....\$169.00  
8460 Quadchrome Enhanced.....\$499.00

**TAXAN**

115 12" Green.....\$119.00  
116 12" Amber.....\$129.00  
121 TTL Green.....\$139.00  
122 TTL Amber.....\$149.00  
220 14" Color Composite.....\$179.00  
620 640x200 RGB.....\$399.00  
630 640x200 RGB.....\$469.00  
640 720x400 RGB.....\$527.00

**ZENITH**

ZVM 1220 Amber.....\$99.99  
ZVM 1230 Green.....\$99.99  
ZVM 1240 IBM Amber.....\$149.00  
ZVM 1330 RGB.....\$459.00  
ZVM 1360 RGB.....\$529.00  
ZVM 1380 E G Comp.....CALL

**COMPUTER MAIL ORDER**



### DR. JACK PURDUM

Get the proven product from the man who wrote the books on "C".

#### C Programming Guide

After reading the 1st edition, Jerry Pournelle (BYTE Magazine) said: "I recommend this book... Read it before trying to tackle Kernighan and Ritchie." The second edition expands this best seller and walks you through the C language in an easy-to-understand manner. Many of the error messages include references to this book making it a perfect companion to Eco-C88 for those just starting out with C.

\$20

#### C Self-Study Guide

(Purdum, Que Corp.) Designed for those learning C on their own. The book is filled with questions-answers designed to illustrate many of the tips, traps, and techniques of the C language. Although written to complement the Guide, it may be used with any introductory text on C.

\$17

#### C Programmer's Library

(Purdum, Leslie, Stegemoller, Que Corp.) This best seller is an intermediate text designed to teach you how to write library functions in a generalized fashion. The book covers many advanced C topics and contains many useful additions to your library including a complete ISAM file handler.

\$22

#### CED Program Editor

CED now supports on-line function help. If you've forgotten how to use a standard library function, just type in the name of the function and CED gives you a brief summary, including function arguments. CED is a full screen editor with auto-flagging of source code errors, multiple windows, macros, and is fully configurable to suit your needs. You can edit, compile, link, and execute DOS commands from within the editor. Perfect for use with Eco-C88. For IBM PC, AT and look-alikes.

\$29.95

#### C Source for Standard Library

Contains all of the source code for the library functions that are distributed with Eco-C88, excluding the transcendentals and functions written in assembler.

\$10 (\$20 if not with order)

#### Developer's Library

Contains all the source code for the standard library, including transcendental and assembler functions. Available with compiler purchase only.

\$25 (\$50 if not with order)

#### Ecosoft Inc.

6413 N. College Ave.  
Indianapolis, IN 46220

# THE FIRST PROFESSIONAL 'C' COMPILER FOR UNDER \$60.00

Limited Time Offer  
**FREE**  
CED TEXT EDITOR WITH  
"BUILT-IN" FUNCTION HELP.

## NOTHING IN THIS PRICE RANGE EVEN COMES CLOSE.

"Ecosoft's Eco-C is going to turn some major heads."

"Eco-C is the first compiler reviewed that has clearly begun implementing the coming ANSI standard. Eco-C supports prototyping."

"Eco-C performed well on all the benchmarks, generating code that was quite comparable to that of compilers 10 times as costly."

from:  
Christopher Skelly  
Computer Language,  
Feb., 1986

"The driver program is another strength: it compiles and links a list of files and provides a simple MAKE capability."

"This compiler does handle syntax errors much better than average—no avalanche of spurious messages here."

from:  
William Hunt  
PC Tech Journal,  
Jan., 1986

"Eco-C88 is a high-quality package... comparable to systems costing much more."

"Eco-C88 is one of the fastest..."

"It is convenient to use, works well, and produces acceptably compact and fast programs."

from:  
Dr. David Clark  
Byte, Jan., 1986

#### Minimum System Requirements:

To use Eco-C88 Release 3.0, you must have:

1. An IBM PC, XT, or AT-compatible computer with monitor.
2. 256K or more memory.
3. Two 360K disk drives, or a hard disk.
4. PC or MSDOS 2.1 or later to include the MSDOS linker.

Eco-C88, mini-make, memfiles and CED are trademarks of Ecosoft Inc.  
IBM is a trademark of International Business Machines.  
UNIX is a trademark of Bell Labs.  
MSDOS and MASM are trademarks of Microsoft.  
Inquiry 116

Full-featured C compiler. Supports all C features, data types (except bit fields), and operators.

New Language Enhancements. You also get prototyping, enum and void data types, plus structure passing and assignment.

Tiered Error Checking. All syntax errors are automatically flagged, but you can select the level of "link-like" semantic error checking you want.

Complete Standard Library. Over 200 functions, many of which are System V compatible for greater source code portability.

Screen and Memory Functions. Now you can write programs that use color, cursor addressing, even ones that let you design your own graphics functions. You also get memfiles™ that allow you to access memory outside the normal data segment as a file.

8087 and 80287 Support. If you have one of these math chips, your programs will take immediate advantage of it. If you don't have one, the code automatically switches to software floating point.

Full Screen Editor. The CED editor is a full screen editor with multiple windows, macro commands, on-line function help, plus a full set of editing commands. (Requires a true IBM PC compatible.) You can edit, compile, link, and execute programs from the editor which greatly reduces development time.

Includes a cc and mini-make™. The UNIX-like cc makes compiling programs a snap. You can run cc from within the CED editor.

ASM or OBJ Output. You can select assembler or relocatable output from the compiler. Both are MASM compatible and ready for use with the MSDOS linker to produce EXE files.

|        | Eco-C88 | Lattice | Computer Inn. C86 | Microsoft | Mark Williams |
|--------|---------|---------|-------------------|-----------|---------------|
| sieve  | 12      | 11      | 13                | 11        | 12            |
| fib    | 43      | 58      | 46                | 109       | —             |
| deref  | 14      | 13      | —                 | 10        | 11            |
| matrix | 22      | 29      | 27                | 28        | 29            |

Computer Language, Feb., 1985, p. 79. Reproduced with permission.

Orders only: **1-800-952-0472**

#### ORDER FORM CLIP & MAIL TO: Ecosoft Inc., 6413 N. College Ave., Indianapolis, IN 46220

- C Compiler \$59.95
- C Programming Guide \$20.00
- C Self-Study Guide \$17.00
- C Programmer's Library \$22.00
- CED Program Editor \$29.95
- C Source for Standard Library \$10.00 (\$20.00 if not with order)
- Developer's Library \$25.00 (\$50.00 if not with order)

SHIPPING \$4.00

TOTAL (IND. RES. ADD 5% TAX)

PAYMENT:  VISA  MC  AE  CHECK

CARD # \_\_\_\_\_ EXPIR. DATE \_\_\_\_\_

NAME \_\_\_\_\_

ADDRESS \_\_\_\_\_

CITY \_\_\_\_\_ STATE \_\_\_\_\_

ZIP \_\_\_\_\_ PHONE \_\_\_\_\_

# ECOSOFT

# PERSPECTIVES ON HARDWARE AND SOFTWARE

BY WILLIAM M. RAIKE

## *Advanced hardware— why hasn't software managed to catch up?*

This is the season of the annual Microcomputer Show in Tokyo, and with it came several interesting new computer products. Surprisingly, while NEC and, to a lesser extent, Fujitsu often dominate the show, this year neither company introduced new computers. The most interesting new computer, the Vectra-D, came from YHP, Hewlett-Packard's Japanese company. Yamaha displayed a fascinating gadget, a piano and computer rolled into one. But even when I'm not going to computer shows, I'm still on the lookout for other computer applications in less likely spots.

### **HIGH-TECH FLAVOR**

It's hard to paint a meaningful picture of modern-day Japan in words. When I visit the U.S., most people there seem to imagine Japan as either a high-tech wonderland or as a semi-mystical land of peaceful meditation, martial arts, and traditional handicrafts. Sometimes, all the realities overlap in amusing, if somewhat jarring, ways.

For instance, one way many Japanese briefly escape the crowded conditions of most Tokyo offices and businesses is to stop in at the local coffee shop in midafternoon. These tiny shops, called *kissaten*, are found everywhere, and they provide a place to meet clients, relax with coworkers, or just duck out of the office to read a book or magazine over a quiet cup of coffee. The proprietor of one such nook in the Shibuya district of Tokyo decided to attract customers by offering a new service: word processing. He installed several personal computers on a large central table, and

customers are encouraged to use them, gratis, for whatever purpose they choose while sipping coffee and nibbling cakes. According to the manager, the idea seems to have worked; people often come in just to find out how a word processor works and return when they discover how easy it is to operate one. And so far, no one has spilled coffee over the keyboard or smeared pastry on the screen!

But one nearby noodle shop, confronted with competition from its neighbor, may have had the last word when it decided to give itself a "new media" edge. It decided to take advantage of rapidly dropping prices by buying a FAX (facsimile) machine; now I can send in my order for traditional Japanese *soba* or *udon* noodles directly from my home FAX machine!

### **PERSPECTIVE ON SOFTWARE**

Just last month I was lamenting the lack of hardware and/or software that would allow IBM Personal Computers and their work-alikes to process Japanese-language text. Despite the fact that a number of Japanese computer manufacturers have developed IBM PC AT-compatible computers for the U.S. market, the number of IBM PC-compatible machines sold in Japan is minuscule compared to the sales of the NEC PC-9801 series, for example. IBM Japan Ltd. offers its Model 5550 and 5540 workstations,

which are popular office computers in many banks and large corporations here. (Recently the company announced upgraded models based on the 80286 microprocessor, the same chip used in the PC AT.) But these computers aren't directed toward the personal computer market, they aren't PC-compatible, and they carry substantially higher price tags than most personal computers.

The reason for so few IBM PC and PC AT machines and work-alikes being sold here is no mystery. I've pointed out several times in this column that you can't expect to sell large numbers of computers in Japan if those computers can't handle the Japanese language. Hardware produced by the leading personal computer manufacturers (NEC, Fujitsu, Oki, Sanyo, Sharp, Hitachi, and others) is very powerful and has undergone a long and arduous winnowing process in the fiercely competitive Japanese market. Demands include extensive and sophisticated Japanese-language processing features that are built into the hardware, as well as more familiar hardware features like fast microprocessors, massive on-board RAM, large floppy disk and hard disk capacities, and extensive interfacing capability.

However, . . . about software. Now it's true that hundreds upon hundreds of

*(continued)*

*William M. Raiké, who has a Ph.D. in applied mathematics from Northwestern University, went to Japan in 1980 looking for 64K-bit RAMs. He has been there ever since as a technical translator and a software developer. He can be contacted c/o BYTE, One Phoenix Mill Lane, Peterborough, NH 03458.*

*Computer users  
are becoming more  
demanding in  
terms of what  
they want their  
software to do.*

Japanese-language application software packages are available for Japanese personal computers. These include word processors, spreadsheets, database managers, graphics programs, business and accounting programs, integrated software packages, communications programs, and so on, not to mention games. That's over and above the large amount of imported generic MS-DOS and CP/M

software (including many compilers, interpreters, assemblers, utilities, and other software development packages) that runs perfectly well on Japanese personal computers. But all that software is merely a drop in the bucket compared to the enormous number of packages you can choose from if you have a PC, a PC AT, or a work-alike.

The growth in the level of sophistication of the new software products developed for computers that obey the de facto IBM standard is mind-boggling. And I say that from the viewpoint of having used and developed software for more than 25 years! The increasing power and range of available software has an explosive positive-feedback effect, with users becoming more demanding in terms of what they want software to do. Also, the number of people buying and using the software is dramatically expanding.

Japanese software, in comparison,

hasn't yet shown this growth curve. Japanese-language software products have not approached the circulation (numbers of copies in use) of products like WordStar, Lotus 1-2-3, Smartcom, SideKick, or ProKey. Except for word-processing software, Japanese-language versions of Multiplan, SuperCalc, and dBASE II are among the most popular application packages. This doesn't necessarily discredit the creativity of the Japanese software industry; rather, a large part of the reason for the low circulation is simply the low volume of mutually compatible computers, like those found in the IBM PC family.

Regular BYTE Japan readers know that my latest in a series of Japanese computers is the Fujitsu FM-16 $\beta$  and that I'm very happy with it. But I don't heavily use its Japanese-language features, and I can't help feeling occasional twinges of regret at not having access to the flood of useful software

*(continued)*

# The Complete 68020 C Compiler System.

**\$595 under DOS**

**\$1390 under XENIX**

**\$2790 under UNIX**

Superior compiler diagnostics help you minimize recompilation and locate errors precisely. It's fully documented and backed by professional support services.

**YOU WON'T FIND A MORE COMPLETE PACKAGE —**  
Includes a full 68020 macro assembler, type-checking linker,  
and all the utilities you need to put your program in ROM.

## Software Development Systems, Inc.

3110 Woodcreek Drive, Downers Grove, IL 60515

Call today (312) 971-8170

In England call UnitC, Ltd., (0903)205233

UNIX is a trademark of AT&T.  
XENIX is a trademark of Microsoft.

Prices subject to change without notice.  
Call for host machine availability.

*Train for the Fastest Growing Job Skill in America*

# Only NRI teaches you to service and repair all computers as you build your own 16-bit IBM-compatible micro

Now that computers are firmly established in offices—and in homes, too—the demand for trained computer service technicians surges forward. The Department of Labor estimates that computer service jobs will actually *double* in the next ten years—a faster growth rate than any other occupation.

## **Total systems training**

No computer stands alone... it's part of a total system. And if you want to learn to service and repair computers, you have to understand computer *systems*. Only NRI includes a powerful computer system as part of your training, centered around the IBM-compatible Sanyo 550 Series computer.

As part of your training, you'll build this highly rated, 16-bit IBM compatible computer system, assemble Sanyo's "intelligent" keyboard, install the power supply and disk drive, interface the high-resolution monitor and dot matrix printer, even expand the memory from 128K to 256K RAM. It's confidence-building, real-world experience that includes training in programming, circuit design, and peripheral maintenance.

## **No experience necessary—NRI builds it in**

Even if you've never had any previous training in electronics, you can succeed with NRI training. You'll start with the basics, then rapidly build on them to master such concepts as digital logic, microprocessor design, and computer memory. You'll build and test advanced electronic circuits using the exclusive NRI Discovery Lab®, professional digital multimeter, and logic probe. Like your computer system, they're all yours to keep as part of your training. You even get over \$1,000 worth of software, including the popular WordStar and CalcStar.



Your NRI total systems training includes all of this • NRI Discovery Lab® to design and modify circuits • Four-function digital multimeter with audio cassette training • Digital logic probe for visual examination of computer circuits • Sanyo 550 Series computer with "intelligent" keyboard and 360K double-density, double-sided disk drive • High-resolution monochrome monitor • RAM expansion module to give you powerful 256K memory • 120 CPS dot matrix printer with near-letter-quality mode • EasyWriter I, WordStar, CalcStar bundled software • Reference manuals, schematics, and bite-sized lessons.

## **Send for 100-page free catalog**

Send the post-paid reply card today for NRI's 100-page full color catalog, with all the facts about computer training. Read detailed descriptions of each lesson, each experiment you perform. See each piece of hands-on equipment you'll work with and keep. And check out NRI training in other high-tech fields such as Robotics, Data Communications, TV/Audio/Video Servicing, and more.

Mail the postage-paid card today, and see how NRI can prepare you for advancement and new careers in the exciting world of electronics. If the card has been used, write to NRI Schools, 3939 Wisconsin Ave., Washington, D.C. 20016.

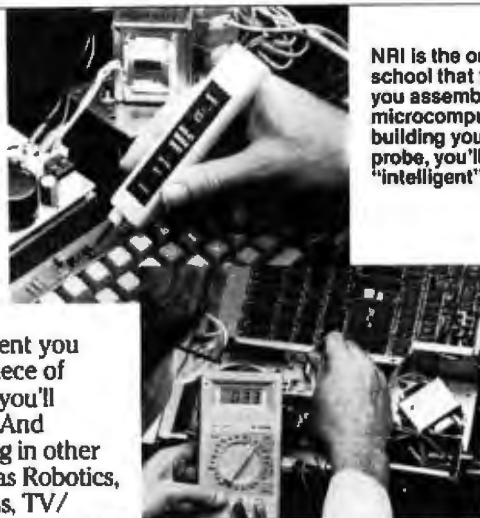

NRI is the only home study school that trains you as you assemble a top-brand microcomputer. After building your own logic probe, you'll assemble the "intelligent" keyboard...

... then install the computer power supply, checking all the circuits and connections with NRI's Digital Multimeter. From there, you'll move on to install the disk drive and monitor.

## **NRI SCHOOLS**

McGraw-Hill Continuing Education Center  
3939 Wisconsin Avenue, NW  
Washington, DC 20016

**We'll Give You Tomorrow.**

IBM is a Registered Trademark of International Business Machine Corporation.

that works only on the PC, the PC AT, or fully compatible machines. In last month's column, I suggested that someone ought to develop an add-on board for the IBM PC to give it Japanese-language processing ability. Besides opening a wedge in the Japanese market for the IBM PC and its clones, it might give me the excuse I need to buy such a machine. And that topic brings me to one of the high-

lights of the recent Microcomputer Show.

**A PC AT WORK-ALIKE**

The Hewlett-Packard people in Japan are called YHP, which stands for Yokogawa Hewlett-Packard. Although it's not their first venture into personal computers here, I wouldn't be a bit surprised if the new Vectra-D Dual-Mode Workstation was the company's

most successful project. What YHP has done with the Vectra-D is to combine two computers into one.

The Vectra-D can work as an IBM PC AT-compatible computer. With an 80286 microprocessor running at 8 megahertz (in contrast to the 6-MHz clock rate that IBM uses), the Vectra-D can run Lotus 1-2-3, SideKick, Top-View, Symphony, Flight Simulator, and others. If you type a command at the operating system level, though, you can switch from "English mode" to "Japanese mode." This turns the Vectra-D into a computer running under version 3.1 of the Japanese-language MS-DOS operating system. As a convinced and enthusiastic RAM disk user, I was happy to hear that YHP supplies RAM disk software that works under both English and Japanese modes. Of course, data files created by a program in one mode are all available to programs operating in the other mode. As you might expect, however, if you try to display files containing Japanese kanji or katakana characters while in English mode, they appear on the screen as garbage.

The kanji ROM contains both the JIS No. 1 and No. 2 character sets, plus a number of additional characters, totaling nearly 7000 characters. Kanji characters are displayed on-screen in a 24- by 24-dot font, which is quite readable. You get 1024- by 768-dot monochrome graphics in Japanese mode, with either 640- by 200-dot or 640- by 400-dot monochrome graphics in English mode. The price you pay for having the Japanese mode on hand is that no color graphics are available, though such options may be available later. YHP wouldn't make any promises. And if you buy a Vectra-D, the price includes a monochrome (green) monitor.

I saw the Vectra-D operating in Japanese mode and running several Japanese-language programs, including the jX-Word word processor and SuperCalc3. YHP says that the R:base Series 5000 database manager will also work, along with GW-BASIC, Lattice C, and a terminal emulator/communications package. In English mode, YHP says that most popular PC AT software will work, although tim-

# Don't you *deserve* the same hard disk backup protection

as GM, GTE, 3M, GE, UPS, Ford, Chrysler, Westinghouse, Polaroid, Shell, Johnson & Johnson, Mobil, Proctor & Gamble, The United Nations, Merrill Lynch, Paine Webber, Rockwell International, Hewlett Packard, Wells Fargo Bank & Caterpillar, Inc.?



We think so.

That's why we created DSBACKUP, a powerful hard disk software utility designed to quickly backup and restore any or all files from an IBM PC/XT/AT or compatible computer, non-IBM compatible

| DSBACKUP v.2.4                          |                 |                |
|-----------------------------------------|-----------------|----------------|
| FASTBACK v.5.03                         |                 |                |
| Runs on Non-IBM compatible MS/DOS PC's  | NO              | YES            |
| Backs up to Syquest cartridges          | NO              | YES            |
| Backs up to Bernoulli Box               | NO              | YES            |
| Backs up to any DOS subdirectory        | NO              | YES            |
| Runs on the Wang PC in native mode      | NO              | YES            |
| Runs on Macintosh and MacPlus           | NO              | YES            |
| Backs up to tape mechanisms             | NO              | YES            |
| Runs on the DEC Rainbow and Victor 9000 | NO              | YES            |
| <b>PRICE</b>                            | <b>\$179.00</b> | <b>\$69.95</b> |

MS-DOS computers, and the Macintosh and MacPlus. Important companies trust their important data to DSBACKUP . . . shouldn't you?

**CALL NOW TO ORDER:**  
**1-800-231-3088**  
 1-312-231-4540  
 In Illinois or Alaska  
**only \$69.95**

**DESIGN SOFTWARE** 1275 W. Roosevelt Rd., West Chicago, IL 60185

MS-DOS is a TM of Microsoft, Inc. Macintosh and MacPlus are TM's of Apple Computer, Inc. Fastback is a TM of Fifth Generation Systems. Wang is a TM of Wang. Syquest is a TM of Syquest. Bernoulli Box is a TM of Iomega. DEC Rainbow is a TM of Digital Equipment Corp. Victor is a TM of Victor.

BYTE JAPAN

If you type a  
command at the  
operating system  
level, the Vectra-D  
switches from  
English mode to  
Japanese mode.

ing problems could conceivably arise as a result of the faster 8-MHz clock rate; there's no switch for selecting between 6-MHz and 8-MHz rates.

The Vectra-D system comes with some impressive hardware as standard equipment. Standard memory is 640K bytes, expandable to 3.64 megabytes. One 1.2-megabyte/360K-byte floppy disk drive is standard; there are two more internal shelves for one more floppy disk drive and one hard disk drive. You can order either a 20-megabyte or a 40-megabyte internal hard disk. The Vectra-D includes seven expansion slots: two are 8-bit bus slots, while the other five are 8-/16-bit bus slots. Both an RS-232C serial interface and a Centronics-type parallel printer interface are standard equipment, along with an RS-422 interface; that will be a handy feature when some of the new (and less expensive) laser printers start appearing on the market. Not surprisingly, the Vectra-D also incorporates an HP-IB interface, useful for interfacing to other Hewlett-Packard equipment. And there's a socket on the main board for installing an 80287 numeric coprocessor.

The price for this kind of power and flexibility is a lot lower than I would have guessed. In a version that comes with one floppy disk drive and one 20-megabyte hard disk drive, and including the high-resolution monochrome monitor as standard equipment, the list price of the Vectra-D is about 1,300,000 yen. (In the past, I've always converted amounts in yen to

(continued)

# How to tackle a 300 page monster.

Turn your PC into a typesetter.

If you're writing a long, serious document on your IBM PC, you want it to look professional. You want MicroTEX. Designed especially for desktop publishers who require heavy duty typesetting, MicroTEX is based on the TEX standard, with tens of thousands of users worldwide. It easily handles documents from smaller than 30 pages to 5000 pages or more. No other PC typesetting software gives you as many advanced capabilities as MicroTEX.

So if you want typesetting software that's as serious as you are about your writing, get MicroTEX. Call toll free 800-255-2550 to order or for more information.\* Order with a 60-day money back guarantee.

**MicroTEX™**  
from Addison-Wesley

Serious typesetting for serious desktop publishers.

\*Dealers, call our Dealer Hot Line: 800-447-2226 (In MA, 800-446-3399), ext. 2643.

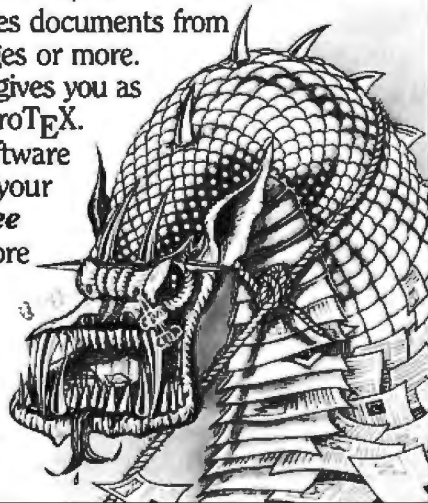

## Copying diskettes will never be easier than pushing one button.

While your computer is busy doing other things, your Victory Duplicator can be making as many as eight copies of a diskette at once — producing up to 400 copies in an hour. DualMaster™ models can even make multiple copies of two different diskettes simultaneously. Just insert the diskettes and press one button.

**Copy different formats, flawlessly.**

An automatic format analysis program makes it possible for the Victory Duplicator to

copy virtually any 5¼, 3½ or 8-inch diskette. The system tests for quality and accuracy at every stage of the process.

**It practically services itself.**

Each drive has a separate controller to maximize up-time. Simple diagnostics to verify drive alignment and industry standard drives allow you to maintain your system without waiting for outside service.

**All at an attractive price.**

Victory Duplicators offer fast copying, serialization,

copy protection, a communications port, a four-month warranty and much more — all for one low price.

**Call 1-800-421-0103.**

Call today for more information. (In Texas, call 512-450-0801.)



**VICTORY ENTERPRISES**  
Technology, Inc.

8910 Research Blvd., Suite B2  
Austin, Texas 78758

© 1986 Victory Enterprises Technology, Inc.

their dollar equivalents. But exchange rates have fluctuated so much in recent months that I feel it will be more useful from now on to give the yen amount directly and to mention the dollar/yen exchange rate only when appropriate.) At today's dollar/yen exchange rate of about 170 yen to the dollar, the Vectra-D carries a price tag of about \$7650. That's a pretty steep price, but not really much

higher than the NEC PC-98XA, for example, which is not compatible with the PC AT.

YHP sees a market for the Vectra-D primarily in companies that want to have access to the world of PC AT software and hardware, including CAD/CAM applications, and yet still provide Japanese-language capabilities within a fully compatible framework—all on a single computer. I

agree, and if YHP's distribution system is up to the challenge, I see a bright future for the Vectra-D. YHP said that it hadn't considered marketing the Vectra-D outside of Japan, but I think it would find a lucrative, if small, market in American universities.

**YAMAHA'S PIANO PLAYER**

Would you believe an upright piano with a 3½-inch microfloppy disk drive and an LED display? The people at Yamaha, who make MSX computers and musical instruments, have managed to reinvent the old-fashioned player piano, and they put in a few new twists while they were at it. For about 930,000 yen (less than \$5500 today), you can buy a piano that will store on a microfloppy disk what you play and at the touch of a button play it again. But simply using a magnetic disk to replace the old-fashioned perforated paper rolls isn't all that the new Piano Player does (that's the name Yamaha has given this gadget). Yamaha has combined modern sensor and servo technology with a high-quality conventional piano. Unfortunately, Yamaha was not very communicative about the details of the sensor and servo techniques they use. But I can verify that this intriguing instrument can accurately reproduce the dynamics, nuances, and phrasing of the original performance, besides simply playing the notes. It's so good that it's eerie.

Yamaha plans to offer a floppy disk library of prerecorded performances to address the home entertainment market, although only a handful of titles are now available. But they'll probably sell a good number of Piano Players to professional musicians. After seeing and being impressed by the Piano Player, one prominent oboe player said, "Imagine how helpful it would be for my accompanist to record one of our rehearsal sessions on disk. After he left, I could continue to practice!"

**NEXT MONTH**

Bill covers the Computex Show in Taiwan and finds surprising prices with a focus on IBM compatibility. The show yields more unexpected happenings, too. ■

Finally, a language that spans the generation gap.



**The language of solutions**

There's only one reason for you to learn a new language—to do your work better and faster. That's exactly what the Arity/Prolog development environment will help you do. Our powerful tools, based on the general purpose programming language Prolog, will speed up your development time significantly and allow you to solve a whole new range of problems.

**No translation required**

What good is a new language if you have to translate all of your existing programs to use it? With Arity/Prolog, you can start speaking a fifth generation language today without giving up the languages you're comfortable with.

Our development environment for the IBM PC family and all MS-DOS compatibles gives you Arity/Prolog, Arity/Expert System, Arity/SQL, and an interface with C, Pascal, Fortran, and Assembly, so you can build right on to your existing applications. You'll be truly multilingual—what better way to span the generation gap?

**It can take you to new places**

You'll discover amazing speed, power, and flexibility using the Arity/Prolog programming environment, with its one gigabyte virtual memory, for conventional applications.

And if you're working in new territories, like expert systems, natural language, or sophisticated database management systems, you'll be speaking the native tongue.

**Speak it Freely**

Our products are not copy protected and we charge no royalties, so you can use them in as many end-user applications as you'd like. Why keep the language of solutions all to yourself?

ARITY CORPORATION  
358 Baker Ave., Concord, MA 01742 U.S.A.  
617-371-1243

Yes, I'd like to be fluent in the language of solutions. Please:

Send me information on Arity products  Add me to your mailing list.

Name \_\_\_\_\_ Title \_\_\_\_\_

Company \_\_\_\_\_

Address \_\_\_\_\_

City \_\_\_\_\_ State \_\_\_\_\_ Zip \_\_\_\_\_

Telephone \_\_\_\_\_

0069a



# Six great reasons to join **BIX** today

- **Over 140 microcomputer-related conferences:**

Join only those subjects that interest you and change selections at any time. Take part when it's convenient for you. Share information, opinions and ideas in focused discussions with other BIX users who share your interests. Easy commands and conference digests help you quickly locate important information.

- **Monthly conference specials:**

BIX specials connect you with invited experts in leading-edge topics—CD-ROM, MIDI, OS-9 and more. They're all part of your BIX membership.

- **Microbytes daily:**

Get up-to-the-minute industry news and new product information by joining Microbytes Daily and What's New Hardware and Software.

- **Public domain software:**

Yours for the downloading, including programs from BYTE articles and a growing library of PD listings.

- **Electronic mail:**

Exchange private messages with BYTE editors and authors and other BIX users.

- **Vendor support:**

A growing number of microcomputer manufacturers use BIX to answer your questions about their products and how to use them for peak performance.

## What BIX Costs . . . How You Pay

ONE-TIME REGISTRATION FEE: \$25

| Hourly Charges:<br>(Your Time of Access) | Off-Peak<br>6PM-7AM<br>Weekdays Plus<br>Weekends<br>& Holidays | Peak<br>7AM-6PM<br>Weekdays |
|------------------------------------------|----------------------------------------------------------------|-----------------------------|
|------------------------------------------|----------------------------------------------------------------|-----------------------------|

|              |                 |                   |
|--------------|-----------------|-------------------|
| BIX          | \$9             | \$12              |
| Tymnet*      | \$2             | \$6               |
| <b>TOTAL</b> | <b>\$11/hr.</b> | <b>\$18/hr.**</b> |

\* Continental U.S. BIX is accessible via Tymnet from throughout the U.S. at charges much less than regular long distance. Call the BIX helpline number listed below for the Tymnet number near you or Tymnet at 1-800-336-0149

\*\* User is billed for time on system (i.e., 1/2 Hr. Off-Peak w/Tymnet = \$5.50 charge.)

BIX and Tymnet charges billed by Visa or Mastercard only.

## BIX HELPLINE

(8:30 AM-11:30 PM Eastern Weekdays)

U.S. (except NH)—1-800-227-BYTE  
Elsewhere (603) 924-7681



We'll  
Send  
You a

BIX User's Manual and Subscriber Agreement  
as Soon as We've Processed Your Registration.  
JOIN THE EXCITING WORLD  
OF BIX TODAY!

## JOIN BIX RIGHT NOW:

Set your computer's telecommunications program for full duplex, 8-bit characters, even parity, 1 stop bit OR 7-bit characters, even parity, 1 stop using 300 or 1200 baud.

Call your local Tymnet number and respond as follows:

### Tymnet Prompt

Garble or "terminal identifier"  
login:  
password:  
mhis login:  
BIX Logo—Name:

### You Enter

a  
byteneti <CR>  
mgh <CR>  
bix <CR>  
new <CR>

After you register on-line, you're immediately taken to the BIX learn conference and can start using the system right away.

## FOREIGN ACCESS:

To access BIX from foreign countries, you must have an account with your local Postal Telephone & Telegraph (PTT) company. From your PTT enter 310600157878. Then enter bix <CR> and new <CR> at the prompts. Call or write us for PTT contact information.

# BIX

ONE PHOENIX MILL LANE  
PETERBOROUGH, NH 03458  
(603) 924-9281

# THIRD GENERATION PROGRAMMERS FROM GTEK

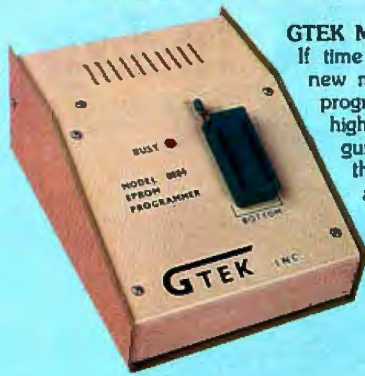

**GTEK MODEL 9000 (E)EPROM/MPU PROGRAMMER**  
If time is money, then let us save some for you. The new model 9000, using its quick pulse algorithms, can program a 2764 in 10 seconds. The 9000 offers higher performance than the competition has even begun to think about. Baud rates to 57,600. Supports thru 512K standard, 8 meg wordwide parts with adapter, Cypress proms, mpu's. NO personality modules. As with our other programmers, RS-232, ASCII data formats, and flexible handshaking make the model 9000 compatible with virtually any computer. Introductory price \$749.

**MODEL 7228 (E)EPROM/MPU PROGRAMMER** The standard by which other programmers are judged. With thousands in the field, the time proven 7228 has become our most popular programmer. Intelligent algorithms standard. Programs a 2764 in one minute. Supports devices thru 512K, mpu's, eeproms, cmos. NO personality modules. Price \$599

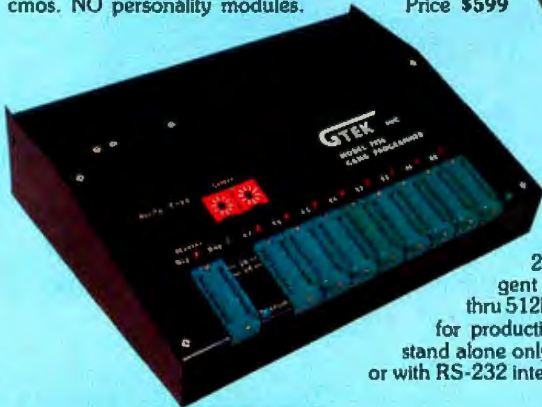

### MODEL 7956 GANG (E)EPROM/MPU PROGRAMMER

The 7956 can program eight 2764's in one minute using intelligent algorithms. Standard support thru 512K, eeproms, cmos, mpu's. A must for production environments. Available in stand alone only configuration for ..... \$979 or with RS-232 interface for ..... \$1099

**MODEL 7128 (E)EPROM/MPU PROGRAMMER** The programmer that won't die. Thousands manufactured since 1982. Supports thru 256K. **PRICE REDUCED** to \$389 including free PGX communications software, a \$95 value.

**MODEL 705** Motorola 68705 family programmer. Transfers object code to 28 and 40 pin mpu's. Single key stroke operation. .... \$299

**MODEL 7324 PAL PROGRAMMER** The 7324 has a built-in compiler. It supports 20 and 24 pin pals by MMI, NATIONAL, and TI, including the new shared product parts 20S10, 20RS10, 20RS8, 20RS4. It operates stand alone or via RS-232 with PALX communications package. Functionally tests parts after programming and securing. External compilers are supported thru JEDEC and AHS object formats. .... \$1499

**MODEL 7322** Same as 7324 but no stand alone capability. .... \$1249

### UTILITY PACKAGES

**PGMX High Speed Communications Package.** For IBM PC, AT and compatibles. Bi-directional data rates to a scorching 57600 bps. Provides flexible manipulation of Intel Hex files, both 8 and 16 bit formats, and binary files. Use with model 9000. .... \$149

**PGX Utility Package.** For PC DOS, CPM, TRSDOS, ISIS, MSDOS. Use with 9000, 7956, 7228, 7128. .... \$95

**PALX Utility Package.** Provides communication, download of Palasm source, JEDEC and AHS object files to models 7324, 7322, 7316 pal programmers. .... \$95

### CROSS ASSEMBLERS and SIMULATORS

You name the cpu, we've got the assembler. Simulators allow target software development and testing on your computer. Versions available for PC DOS, MSDOS, CPM. . Start at \$200

**ERASERS**—We stock both Ultra Violet Products and Spectronics for your selection.

| MODEL | CHIPS | TIMER | LAMP | PRICE |
|-------|-------|-------|------|-------|
| DE4   | 8     | N     | Tube | \$80  |
| PE14T | 9     | Y     | Tube | \$139 |
| C25   | 25    | Y     | Grid | \$349 |
| C50   | 50    | Y     | Grid | \$599 |

### ACCESSORIES

|                                                                  |
|------------------------------------------------------------------|
| <b>CABLES</b> —serial \$30, parallel \$30, custom Call For Quote |
| MODEL 481/482/483 8048 family adapters ..... \$98                |
| MODEL 511/512 8051 family adapter \$174                          |
| MODEL 755/756 8755 adapter ... \$135                             |

**SPECIAL REQUIREMENTS? Call Us For A Quote On Custom OEM Programmers.**

Run CPM Software on Your IBM or IBM Compatible



If you are a CPM user who wants to convert to MSDOS or PC DOS or a PC user who would like access to the thousands of CPM programs in existence, here is the perfect solution to the problem: CPEmulator from GTEK.

CPEmulator is the only field proven emulator which emulates the complete Z-80 instruction set. Terminal attribute emulation is Televideo, Lear Siegler, or the AMSI standard. CPM .COM programs reside under PC DOS and are executable under PC DOS as well as 8086 programs.

Comes complete with COPYCPM, a disk conversion utility which allows transferring data and programs to and from 54 different CPM disk formats. Free CPM utility programs are also included.

Need speed? CPEmulators Speed Kit includes NEC V20 processor. (8080 opcodes only)

CPEmulator Z80 emulator ..... \$199  
CPEmulator 8080 emulator w/V20 .... \$199  
Both versions ..... \$298  
Call GTEK's CPM Hotline 1-601-467-9019

## The Printing Solution: Model 8014 Programmable Printer Switch



Finally a way to have as many parallel printers as you need even when you only have one parallel port. With GTEK's programmable parallel switch, you can expand as you require. Perfect for networks.

With the spooling version, you can allocate available memory to fit your requirements, get multiple copies and more.

Both use ordinary IBM type parallel printer cables, expand one port to four, and may be cascaded in Star or Daisy Chain configurations for as many ports as desired. The desired port is selected with a simple escape sequence. For networks, previous selected port is saved on Port Stack and returned to with Return Escape Sequence. Complete with power supply.

Model 8014 Four port programmable switch ..... **PRICE REDUCED** \$199  
Model 8014-128K spool memory .... \$339  
Model 8014-256K spool memory .... \$399

# GTEK

Development Hardware/Software  
P.O. Box 289, Waveland, MS 39576 U.S.A.  
601/467-8048; telex 315-814 (GTEK UD), INC.

GTEK, PALASM, CPM, MS-DOS, PC-DOS, ISIS, TRSDOS, & CPEmulator are registered trademarks.



# TURBOCHARGING MANDELBROT

BY DICK POUNTAIN

## *An Occam technique to boost performance in parallel computing systems*

In July's column I gave an update on the Inmos Transputer and also touched briefly on the topic of dynamic load balancing, a programming technique that can be used to optimize performance in parallel computing systems. Because the topic deserves more space than I could give it, this month I'll dig a little deeper.

As you'll recall, one issue when dealing with parallel computing systems is to achieve a correct balance between communication time and computation time. With dynamic load balancing, an Occam program can redirect the flow of data at run time to keep the processors as busy as possible and help achieve that balance.

To illustrate this technique, I'll look at a graphics demonstration program written in Occam by Phil Atkin of Inmos's Demonstration Software Group. The program draws views of the Mandelbrot set (see photo), a gorgeous mathematical object that wins hands down the title "Fashionable Demo Program of the Year" and makes rotating three-dimensional cubes look passé.

I won't go into the full mathematics of the Mandelbrot set here. (Anyone who has been on a desert island and wants to refresh their knowledge thoroughly should see A. K. Dewdney's "Computer Recreations" column in the August 1985 *Scientific American*.) Essentially, the Mandelbrot set is generated by iterating a simple function on the points of the complex plane. The points that produce a cycle (the same value over and again) fall in the set, whereas the points that

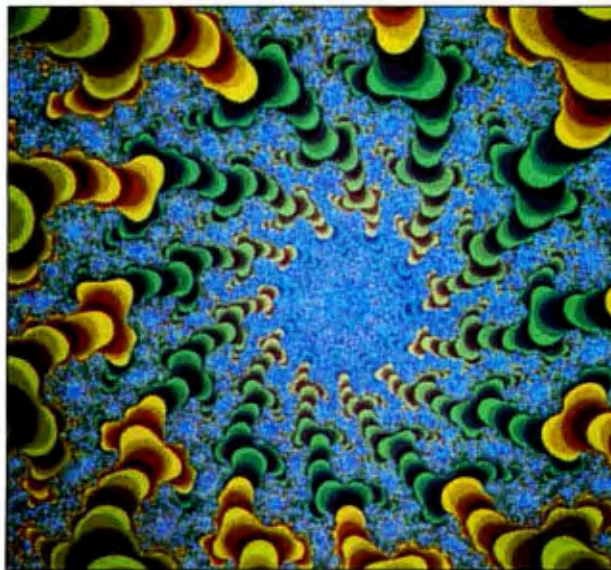

diverge (give ever-growing values) lie outside it. When plotted on a computer screen in many colors (different colors for different rates of divergence), the points outside the set can produce pictures of great beauty. The boundary of the set is a fractal curve of infinite complexity (see "Fractals" by Peter R. Sørensen in the September 1984 *BYTE*), any portion of which can be blown up to reveal ever more astounding detail, including miniature replicas of the whole set itself.

The reason for the sudden popularity of a Mandelbrot program as a demo is that it's hugely computation-intensive but produces a pretty picture that even mathephobes can appreciate—there aren't too many programs like that around. The program requires hundreds of floating-point

multiplications to calculate each individual pixel and is thus a stern test of any processor. Mandelbrot is a stern test even for a parallel computer because we can't predict how long the calculation of any given point will take; the individual processors will be kept busy for truly random periods, which makes simpleminded schemes for sharing out the work load grossly inefficient.

My own program in Turbo Pascal for the IBM PC takes 4 to 8 hours to draw one Mandelbrot screen in four colors (without the benefit of an 8087); a VAX-11/780 takes about an hour. Phil Atkin's program was designed to use several Transputers to draw Mandelbrot sets interactively; you can select an area with the mouse and have it blown up while you wait, typically in 20 to 60 seconds.

I describe the program here not because the world is crying out for faster Mandelbrot sets, but because it illustrates nicely the technique of dynamic load balancing.

### THE MANDELBROT PROGRAM

The program is structured in three main sections: the system controller, the pixel evaluator, and the graphics engine. The system controller takes the *x,y* coordinates of slices of the video display screen and feeds them to the pixel evaluator; the screen is written concurrently in horizontal slices. The pixel evaluator performs

*(continued)*

Dick Pountain is a technical author and software consultant living in London, England. He can be contacted c/o *BYTE*, One Phoenix Mill Lane, Peterborough, NH 03458.

Listing 1: *The outline program in Occam.*

```

CHAN feedSystem, feedGraphics: -- channels for
 -- communication
 -- between the
 -- processes

PAR
 systemController(feedSystem)
 pixelEvaluator(feedSystem, feedGraphics)
 graphicsEngine(feedGraphics)

```

Listing 2: *PLACED PAR lets the three processes be run on three different processors.*

```

CHAN feedSystem, feedGraphics: -- channels for
 -- communication
 -- between the
 -- processes

PLACED PAR
 PROCESSOR 0
 PLACE feedSystem AT link0out:
 systemController(feedSystem)

 PROCESSOR 1
 PLACE feedSystem AT link0in, feedGraphics AT link0out:
 pixelEvaluator(feedSystem, feedGraphics)

 PROCESSOR 2
 PLACE feedGraphics AT link0in:
 graphicsEngine(feedGraphics)

```

Listing 3: *How to map a program onto a pipeline of Transputers.*

```

VAL lineSize IS 9: -- a constant

[lineSize+1]CHAN pipeline: -- channels for communication

PLACED PAR
 PROCESSOR 0
 PLACE pipeline[0] AT link0out:
 systemController(pipeline[0])

 PLACED PAR i = 1 FOR lineSize
 PROCESSOR i
 PLACE pipeline[i-1] AT link0in, pipeline[i] AT link1out:
 pixelEvaluator(pipeline[i], pipeline[i+1])

 PROCESSOR lineSize+2
 PLACE pipeline[lineSize] AT link0in:
 graphicsEngine(pipeline[lineSize])

```

the dirty work of computing the points in the Mandelbrot set, and here is where the dynamic load balancing takes place. The pixel evaluator is, in fact, distributed over an array of processors (10 Inmos B001 Evaluation Cards, each containing one Transputer and 64K bytes of RAM) and works as a pipeline. Finally, the graphics engine (running on an Inmos B00G1E Graphics Card) plots the points on each slice of the screen in 256 colors at an overall screen resolution of 256 by 256 pixels. The outline program in Occam is shown in listing 1.

This program merely says the three processes are to run in parallel and communicate results to each other over the two channels, and it could be run on a single Transputer using pseudoconcurrency. The three processes can, however, be run on three different processors by using PLACED PAR (see listing 2), which specifies where each is to be run.

PLACE...AT maps the logical channel names onto the physical Transputer serial links called link0in and link0out. A program might be mapped onto a pipeline of Transputers as shown in listing 3. An array of channels called pipeline replaces the previous two channels, and the replicator (PLACED PAR  $i = 1 \dots$ ), which works like a FOR...NEXT loop, attaches them to an array of parallel processes that forms the pipeline. This illustrates Occam's use as a hardware-configuration language: if you want to add more Transputers to the system, the only change required in the program is to alter the value of the constant lineSize. A simplified diagram of the 11-processor system is shown in figure 1.

The actual Mandelbrot demo program uses a slightly more complex configuration, in which the pipeline becomes a two-way affair with data flowing in both directions (see figure 2). This means that both raw and processed data flow through the system controller, with the advantage that the system controller can now monitor the output of the system, which is essential for dynamic load balancing. In the actual program, the pixel evaluator needs four channel param-

(continued)



PC Magazine  
Product of the Year!

Not  
Copy-Protected

# HOMEBASE 2.0™

## IMPACTS JUST 80K!

### HOMEBASE 2.0

- Free 800-Line Support  
*7 days a week, 12 hours a day*
- Communications Program  
*with background processing*
- Background Electronic Mail
- Calendar/Appointment System
- Database Management System
- Text Editor
- Name, Address and Phone Rolodex™
- DOS Services
- Cut-and-Paste
- Calculator
- Autodialer
- ASCII Table
- Appointment Alarms
- Template Maker
- Screen Saver
- Notepad
- Onscreen Clock
- Report Generator
- Programmable Hotkeys
- Mailing Label Printer
- Area Code Directory
- Type Ahead Keyboard Buffer
- Expense Reporter

**\$69.95**

### SIDEKICK

- Notepad
- Autodialer
- Calendar
- Calculator
- ASCII Table
- Phone Directory
- Cut-and-Paste

**\$84.95**



### TRADE IN YOUR SIDEKICK!

**\$20**

**REBATE\***

**for SideKick Users**

limited time offer

*SideKick Conversion Program  
Convert your existing  
SideKick® files and  
appointments to  
Homebase!*

\*rebate only applies for product purchased directly from us. No dealers.

### TO ORDER YOUR HOMEBASE CALL NOW

*24 hours a day, 7 days a week*

# 800-523-0764

in California

# 800-323-5335

### 30 Day Money-Back Guarantee\*

\*call for details



Brown Bag Software  
2105 So. Bascom Ave.  
Suite 164  
Campbell, CA 95008

## The pixel evaluator contains three parallel processes.

eters to reflect this two-way data of flow.

### THROUGHROUTING

The most interesting of the three main sections is the pixel evaluator, which does all the hard work and contains three parallel processes itself. One is the actual number-crunching process, *genPixels*, and the other two are *throughrouters*. A throughrouter is a process that merely takes input data and passes it to its outputs unchanged. However, a throughrouter can make an intelligent decision about where to send the outputs. The *pixelEvaluator* process contains one throughrouter for raw screen slices and another for evaluated pixels.

The pixel throughrouter is quite dumb and merely permits finished results to be passed hand to hand along the pipeline to the system controller without being worked on by the

processors they pass through. The screen-slice throughrouter is the smart one and actually performs load balancing. The algorithm it uses is very simple, although the conventional (i.e., sequential) pseudocode shown in listing 4 cannot capture the concurrency that's the essence of the algorithm. This algorithm guarantees that all the processors in the line are kept as busy as possible, yet it need not specify exactly which processor will evaluate any particular screen slice.

The *systemController* process first fills up the pipeline with as many screen slices as it can hold and thereafter supplies a new slice only when it gets an evaluated slice back, indicating that a processor in the line has free capacity. The controller doesn't know (or care) which one got the slice.

To minimize any latency in the system due to the finite time required to communicate results back to the controller, each component process of the *pixelEvaluator* pipeline actually stores an extra screen slice in addition to the one currently being worked on. This means that the number cruncher can be fed as soon as it finishes a

slice, without waiting for the previous result to traverse the pipeline. The number of slices buffered in this fashion is a parameter that the programmer can play with to fine-tune the system.

In Occam, *pixelEvaluator* at its outermost level looks like listing 5. The channels *feedPixels*, *pixelTrigger*, and *pixelsOut* are local to the process and shunt data and messages between its components. *PRI PAR* creates prioritized parallel processes; the first process that follows it has priority over the next, and so on. Low-priority processes can only proceed when higher-priority ones are waiting to communicate. In this case, the effect is to give the *WHILE TRUE* loop high priority (*SKIP* is a do-nothing process).

The *pixelBypass* process is the throughrouter for processed slices on their way back to the graphics engine. This process passes back data to the previous processor in the line, mixing the data neatly into the stream coming from processors that are further down the line (see figure 3). In Occam, this process reads as is shown in listing 6.

(continued)

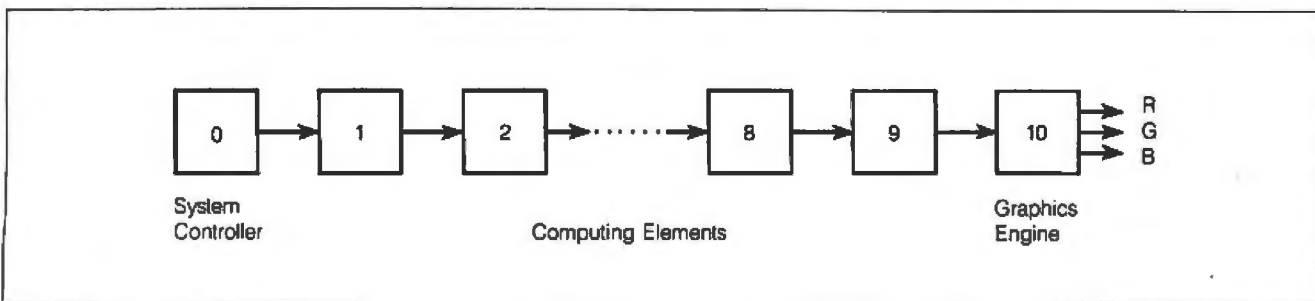

Figure 1: A simplified diagram of the 11-processor system.

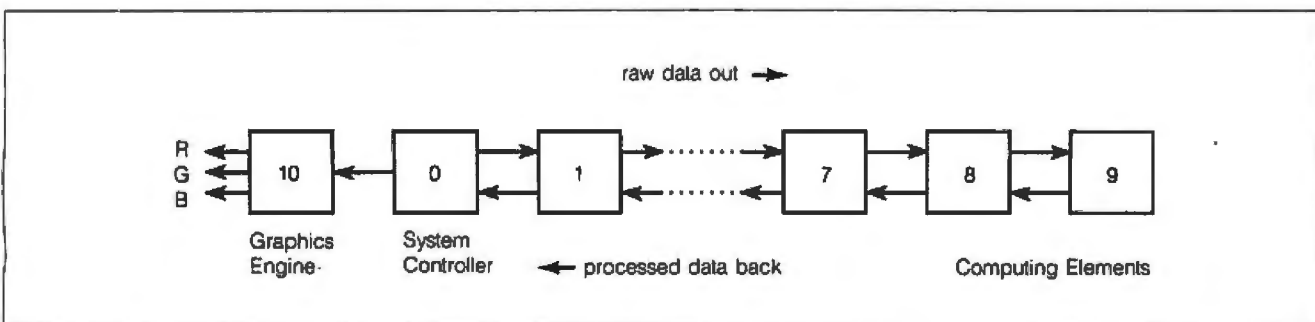

Figure 2: Actual hardware configuration used for the Mandelbrot demo.



# New Version 4.0 FILE RECOVERY SYSTEM™

FOR THE IBM-PC

*"Brown Bag Software's™ File Recovery System™...  
more powerful than the Norton Utility Version 3.1."*  
—PC Magazine

## We May Be Able To Save Your Job Or Your Life

# \$129<sup>95</sup>

**Recover Erased Files**  
**Edit Any Spot On A Disk**  
**Change File Attributes**

**Fix A Damaged File**  
**Menu-Driven and "Goof-Proof"**  
**Context Sensitive Help**

**Recover Data From Physically Damaged Disks**  
**Works On Hard And Floppy Disks**  
**Not Copy-Protected**

- **YES YOU CAN RECOVER ERASED FILES.** Even \*.\* With Brown Bag Software's™ File Recovery System™ for the IBM-PC and compatibles, no programming experience required. If you can erase a file, you can restore it.

- **MENU-DRIVEN and "FOOL-PROOF.."** Do you have "one-of-those" in your office...we do too! That's precisely why we developed Brown Bag Software's™ File Recovery System™ for the IBM-PC and compatibles! Our menu-driven system is a snap.

- **FIX A DAMAGED FILE TOO!** Sometimes files can get "glitched," by a power spike, bumping into the hard disk, dropping the computer on the floor, etc. We understand. That's why we've included a full screen editor to repair any file, hidden or otherwise.

- **IS IT HARD OR FLOPPY?** We don't care. We work with floppy disk, most hard disks, and most IBM-PC compatible computers.

- **HELP IS ONLINE TOO!** We know that most people don't read manuals. (But we include a comprehensive one anyway!) And when you erase a file and need it recovered NOW, you're not in any frame of mind to pour through any manual. We understand. That's why we've put hand-holding online. Just hit the ? key and the help appropriate to where you are and what you want to do is immediately available. The only thing better would be two aspirins!

- **OTHER HANDY TOOLS...HELP; WHERE'D THE FILE GO?** We provide menu-driven tools to change a file's attributes, change disk labels, modify screen color, locate a lost file that you know is somewhere on the disk, but it's lost in a maze of sub-directories (you forgot which).

**WITH YOUR CREDIT CARD, CALL NOW**  
**24 HOURS A DAY, 7 DAYS A WEEK**

## 800-523-0764

IN CALIFORNIA  
800-323-5335

The second part of pixelEvaluator, the smart thruPut process, watches both the stream of raw data and the genPixel process and also maintains a buffer for the extra screen slice. The genPixel process lets thruPut know it has finished evaluating a slice by sending a signal on the channel pixelTrigger. In Occam, a simplified account of thruPut's action is shown in listing 7. In the actual demo program, a simple message protocol permits the contents of command to be used

to control the process (including stopping it, for which no provision is made in listing 7). The demo program also includes a detailed buffering mechanism.

But the main point of interest is the PRI ALT construct, which is how thruPut monitors two channels at once. In an ordinary ALT, whichever channel—pixelTrigger or fromPrev—is ready first gets to input into command (? command signifies an input process), assuming that the relevant

flag—thruPutActive or pixelsActive—is TRUE. In a PRI ALT the same thing happens. However, in the event of a dead heat between the channels, pixelTrigger has higher priority and wins the coconut. Diagrammatically, the processes fit together as shown in figure 4.

### THE NUMBER CRUNCHER

The final component of the pixel evaluator, genPixels, is quite straightforward. It contains a number-crunching process called mandelbrotPixel, which looks pretty much like a Mandelbrot program would look in Pascal (see listing 8).

Anyone who has written a Mandelbrot program will note that the only trick used here is to test the square of the modulus against four to save a square-root calculation. The processes complexMultiply and so on do exactly what their names suggest; they're written using Occam floating-point library routines (Occam can support both 32- and 64-bit reals, to the ANSI/IEEE standard 754). The three dots in ...PROC represent what you would actually see in the Occam editor when the bodies of the PROCs are folded away, ThinkTank style.

The line beginning with [complex]REAL32 demonstrates Occam's way of defining arrays; in this case, the arrays contain two 32-bit reals to represent complex numbers. Occam 2 provides record types in addition to

Listing 4: Pseudocode for the load-balancing algorithm.

```

input a slice of screen
IF my genPixels is busy
THEN pass the slice on unchanged to the next processor in
 the line
ELSE send the slice to my genPixels
pass evaluated pixels on to pixel throughrouter

```

Listing 5: The pixelEvaluator process at its outermost level.

```

PROC pixelEvaluator(CHAN fromPrev, toPrev, fromNext, toNext)
 CHAN feedPixels, pixelTrigger, pixelsOut:
 PRI PAR
 WHILE TRUE
 PAR
 pixelBypass(toPrev, fromNext, pixelsOut)
 thruPut(fromPrev, toNext, feedPixels, pixelTrigger)
 genPixels(feedPixels, pixelsOut, pixelTrigger)
 SKIP
:

```

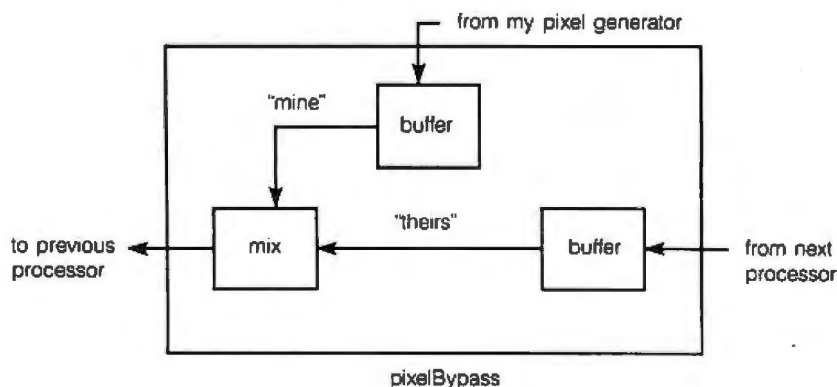

Figure 3: The pixelBypass process.



arrays, but at present they can only be used in communications over channels, as a convenient way to input or output complicated objects.

**LOAD BALANCING**

A most interesting aspect of the genPixel process is that it contains a PRI PAR that does the exact reverse of the one we saw earlier; that is, it sets the Mandelbrot calculating process to lowest priority:

```
PRI PAR
 SKIP

 mandelbrotPixel(etc....)
```

This should surprise you: In a hugely computation-intensive program, we are giving lowest priority to the computational part! The point is that in a parallel computer, computational power is a variable; you can add more processors to get more power. (The speed of this program is, in fact, directly proportional to the number of processors that are employed; doubling the number of processors halves the time it takes to generate a Mandelbrot.)

Keeping all those processors busy (i.e. load balancing) becomes the crux of the problem. In this program, communication must take precedence over computation; if we impede the flow of throughputed data, the latency time increases and the perfor-

*(continued)*

Listing 6: The pixelBypass process.

```
PROC pixelBypass(toPrev, fromNext, fromMe)
 CHAN mine, theirs:
 PAR
 buffer(fromNext, theirs)
 buffer(fromMe, mine)
 mix(mine, theirs, toPrev)
 :
```

Listing 7: A simplified account of thruPut's action.

```
PROC thruPut(CHAN fromPrev, toNext, feedPixels, pixelTrigger)
 INT command:
 BOOL thruPutActive, pixelsActive:
 SEQ
 pixelsActive := FALSE
 thruPutActive := TRUE
 WHILE thruPutActive OR pixelsActive
 PRI ALT
 pixelsActive & pixelTrigger ? command -- genPixels
 -- needs feeding
 IF
 bufferEmpty
 pixelsActive := FALSE -- genPixels
 -- is idle
 TRUE
 ... send buffer contents to genPixels
 thruPutActive & fromPrev ? command -- a new slice
 -- has arrived
 IF
 NOT pixelsActive
 ... send new slice to genPixels and set
 pixelsActive to TRUE
 bufferFull
 ... we can't help, pass new slice on toNext
 TRUE
 ... put new slice in buffer
 :
```

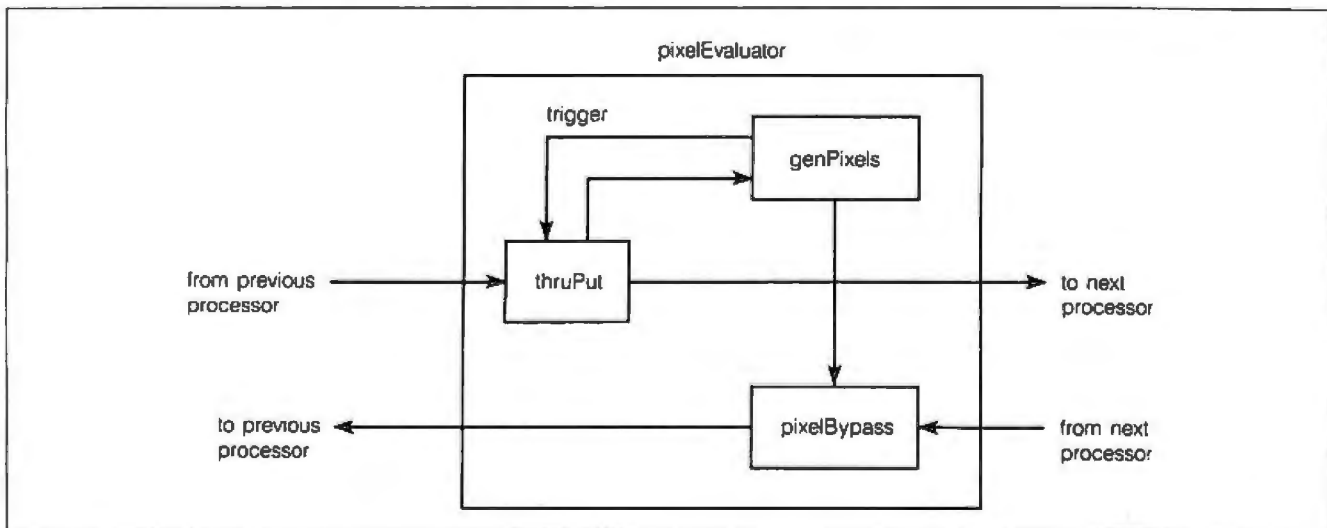

Figure 4: The pixelEvaluator process.

64K ■ 128K ■ 256K

**DRAMS**

80287-8 ■ 80287-3

8087-3 ■ 8087-2

8087-1

BITTNER



ELECTRONICS

899 SOUTH COAST HIGHWAY  
LAGUNA BEACH, CA 92651

(714) 497-6200

CALL NOW FOR **FREE** CATALOG

Inquiry 42

**DATA ACQUISITION TO GO  
INTERFACE FOR ANY COMPUTER**

**FREE IBM SOFTWARE**



Connects via RS-232. Fully IBM compatible. Built-in BASIC. Stand alone capability. Expandable. Battery Option. Basic system: 16 ch. 12 bit A/D, 2 ch. D/A, 32 bit Digital I/O. Expansion boards available. Direct Bus units for many computers.

(201) 299-1615

P.O. Box 246, Morris Plains, NJ 07950

**ELEXOR**

Inquiry 118

**DOUBLE** THE OPTION CAPACITY  
OF YOUR IBM PERSONAL COMPUTER

**PC-XTRA**

- DIRECT EXTENSION OF IBM PC BUS
- NO SOFTWARE CHANGES
- NO HARDWARE MODIFICATION
- STYLING CONSISTENT WITH IBM

Add all these special options that you've been wanting without worrying about filling your plug-in and back panel space



DEALER INQUIRIES INVITED.

\$49.00\* F.O.B. SANTA ANA

\*CALIFORNIA RESIDENTS ADD 6% SALES TAX

**P C HORIZONS, INC.**

1701 E. Edinger, Ste. A6, Santa Ana, CA 92705  
(714) 953-5396

Inquiry 262

Listing 8: The mandelbrotPixel process.

```

PROC mandelbrotPixel(INT color, VAL INT x, y)
 VAL complex IS 2: -- a complex number has
 -- two parts
 -- ... the real
 VAL real IS 0: -- ... and the imaginary
 VAL imag IS 1:

 ... PROC complexMultiply([complex]REAL32 result, a, b)
 ... PROC complexAdd([complex]REAL32 result, a, b)
 ... PROC modulusSquared(REAL32 size, [complex]REAL32
 number)

 [complex]REAL32 z, c, zSquared: -- declare some complex
 -- variables

 VAL zero IS 0.0 (REAL32): -- zero as a REAL32
 -- constant
 VAL four IS 4.0 (REAL32): -- ditto four
 VAL maximum IS 256: -- maximum iterations
 -- for divergence

 INT iterations, size
 SEQ
 z[real] := zero -- set z to 0+0i
 z[imag] := zero
 c[real] := x -- c is the current
 -- point

 c[real] := y
 iterations := 1
 complexAdd(z, z, c)
 modulusSquared(size, z)
 WHILE (iterations < maximum) AND (size <= four)
 SEQ
 complexMultiply(zSquared, z, z)
 complexAdd(z, zSquared, c) -- z^2 + c is the
 -- function

 modulusSquared(size, z)
 iterations := iterations+1
 IF size <= four -- point in set; color
 -- it black
 color := black
 size > four -- point out of set;
 -- color lt

 color := iterations
 :
```

mance drops off drastically as processors wait idly for data. The use of dynamic load balancing relieves the programmer from worrying about the synchronization of distributing the data; the algorithm explained earlier guarantees that data always gets to the hungry processor.

One of the great debates in the parallel processing world concerns hardware topology. Various parties champion their own particular shapes, from doughnuts to hypercubes and all the rest. With the arrival of off-the-shelf computing elements like the Transputer, it's becoming easier to

play around with different topologies and test out the claims. But programs like this one hint that hardware topology might not after all be the most significant determinant of performance.

Certainly much more research is needed on load-balancing algorithms in software. One problem is that many current parallel machines are special-purpose devices that are hard-wired and programmed at microcode level, making such investigation a real chore. High-level languages like Occam can take the sting out of it to a remarkable extent. ■



# SING YE MACPRAISES

BY EZRA SHAPIRO

## *Mac software: the spectacular More and the solid FullPaint*

There's no room on my desk for a Macintosh mouse; a friend has suggested an all-terrain model equipped with giant ribbed tires as the only way to negotiate through the mounds of junk I collect. I don't like the dull, echoing thunk of the Macintosh keyboard; it makes me worry about rousing some angry subterranean being miles beneath the surface of the earth's crust. And I have about as much use for a machine that boots up with a cutesy, happy-face computer icon as I have for an automobile horn that plays "The Yellow Rose of Texas." But die-hard MacSkeptic that I am, I'm being won over by the software.

Apple promised us a blizzard of business programs when it introduced the machine. It never materialized; all we got were scattered flurries. Those of us—including a bunch of folks at Apple—who believed that the only way to guarantee good software was to have lots of it were disappointed. In the mad quest for quantity, nobody mentioned quality.

But that's exactly what we've been getting of late. I haven't seen zillions of Mac programs, but what's been coming in has been first-rate. In almost every application category, I can pick at least one Mac product that runs rings around its MS-DOS competitors. Programmers are figuring out the uneasy balance between friendliness and power, they're mastering the good points—and sidestepping the bad ones—of the Mac ROM, and they're producing excellent software.

If this keeps up, when it comes time for me to pick my next-generation machine, it may well be a Macintosh.

### NEW HORIZONS IN OUTLINING

I'm not sure whether *More* (Living Videotext, \$295) is an outline pro-

cessor or an operating system. The product is an extension of the basic concepts of the original ThinkTank (which started life as an Apple II program before migrating to the IBM PC and the Macintosh), but it packs so many features and self-contained applications that I could see using it to cover the bulk of my regular tasks. In that sense, *More* is a lot like *Framework*, although it's far stronger as an outliner and not as well suited to traditional database management and number crunching. Whatever you do call it, though, *More* is definitely one spectacular piece of software.

If you're familiar with ThinkTank or Ready! under MS-DOS or ThinkTank 512 on the Mac, you've got a good idea of where the program begins. You organize data as an indented outline; any line can be treated as the root of a tree, with subordinate headings and subheadings branching off beneath it. Blocks of flat text or MacPaint drawings can be attached to any heading. By clicking the mouse on a heading and collapsing or expanding the outline, you choose how much detail you want to view at the moment. Reorganization is also a simple mouse operation; select a heading, move the cursor to the new location, hit a command, and the heading with all its subsidiary data is transported to the new spot. So much for the refresher course; if you want the heavy-duty theory, check out my blatherings a couple of years back ("Text Databases" in the October 1984 BYTE).

A number of the enhancements that differentiate *More* from ThinkTank 512 have been lifted from Living Videotext's MS-DOS offerings. These include hoisting (temporarily bringing a section of your outline to full screen for close work), cloning (creating a duplicate of a heading that changes as the original is altered), and mark and gather (selecting a group of headings from different places and pulling them into a new section). The instant recall of outline templates, one of the best ideas in Ready!, has been implemented in true Mac fashion; instead of assigning four outline chunks to function keys, you can install 16 templates (32 with the 1-megabyte Mac Plus) on a pull-down menu. Sample templates for things like address book entries, personal records, daily appointment calendars, and suchlike are included with the program. Ready!'s point-and-dial, which lets you select a phone number for a voice call and have your modem dial it for you, has also been implemented. (I find this a singularly useless feature, but I assume there must be *someone* out there demanding it.)

*More* can handle six outline windows at a time, which can be tiled vertically, horizontally, diagonally, or arranged as you see fit. ThinkTank 512's hot borders, which scrolled your text away from a window's edge if you clicked the mouse anywhere on the border, have been replaced with standard Mac scroll bars.

Now we get to the fun stuff: *More* has moved outlining into presentation graphics. You can now display an outline as either a bullet chart or a tree

(continued)

Ezra Shapiro is a consulting editor for BYTE. Contact him at P.O. Box 170040, San Francisco, CA 94117-0040.

chart. Anyone who has had to prepare transparencies for overhead projection or who has been forced to generate graphics for reports will love this.

You construct bullet charts by selecting an outline; the first heading becomes the title, and subordinate heads become bulleted points underneath it. The whole process can be nearly automatic—any head with subheads becomes a chart. On the Mac screen, choosing the bullet-chart option whisks you from your outline to a display of the chart as it will appear. A palette pops up from which you can select type fonts, sizes, spacing, borders, numbering styles, and so on.

Tree charts are just as simple, only the outline becomes a series of little boxes or circles connected with lines. Another palette lives along the left border; you can choose centered or flush text, line styles, orientation (top to bottom, bottom to top, left to right, right to left), drop shadows, and other options. As tree charts can easily extend over several pages, the charts appear on a grid showing position on a printed page, but the grid can be turned off.

All this stuff can be dumped to a printer (in fact, if you've got a color Imagewriter, you can choose different colors for each level of an outline) or saved in one of several file formats for use by page-makeup or drawing programs. If you'd like to use your Mac as a presentation tool, you can set up a slide show mixing outlines, text documents, bullet charts, tree charts, MacPaint drawings, MacDraw charts, and so on. The show can be orchestrated to bring up screens at timed intervals, or you can control it in a way analogous to controlling a slide projector, clicking the mouse to change screens. If it's a working meeting rather than a formal presentation, you can edit and reorganize the material as you proceed.

The last of the high points I want to touch is computation; you can calculate simple columnar arithmetic within an outline. Let's say you want to record a day's expenses; you'd enter each expense item as a subheading, and the grand total would appear in the title line.

Other reactions. The document editor is as good at text handling as any Mac word processor; I could be quite happy using it as my primary editor. Search functions are slick and well executed, as is output formatting. And while I'm not usually a fan of Mr. Mouse, he's well suited to trundling around an outline, and More provides a complete enough selection of keyboard commands to keep the mouse interruptions to a minimum.

I do have a brief wish list. I'd like to see more on-screen help; this is a big program that can be confusing. Some form of macro facility would be an improvement, and a nice long list of numeric functions (for those of us who are always calculating arctangents and net present value) would broaden the scope of the product.

I'm really sold on the package, but my testing has been done with beta versions 0.46 and 0.47 and a loose-leaf draft of the manual, so I can't vouch for flawless performance. Some of More's functions were not quite finished (point-and-dial would point-and-dial me into a system crash), but the bulk of the program was running, and I didn't spot any bugs that Living Videotext hadn't warned me about. The company's other products have all been pretty thoroughly debugged by the time they've appeared on the shelves, and I'm assuming this one won't be an exception.

Conclusions? This is superb software. An owner of ThinkTank 512 might want to think carefully and look at the list of new features before upgrading, but for everyone else, this is exciting news.

#### BEYOND MACPAINT

MacPaint was the razzle-dazzle part of the original Macintosh package; it was the program that caused heads to turn and eyes to pop, the perfect showpiece you'd use to answer the question, "What does the Mac do that's so special?" It was something more than a game, but something less than a serious artist's tool. As software, it started the juices flowing, whetted the appetite for computer graphics, and made you wonder what was next.

The world has changed since then.

The Mac environment is accepted; it no longer needs to be demonstrated to a disbelieving public. And Apple has stopped bundling MacPaint software with its new machines.

These days, you either have to cadge an illegal copy of MacPaint from a friend or buy it from Apple for 125 bucks (which seems a bit steep for what used to be a freebie). Or you can purchase FullPaint (Ann Arbor Softworks, \$99.95), a program that takes the MacPaint concept to the next generation.

FullPaint looks a lot like MacPaint; in fact, it's so close that only an experienced MacPaint user could tell the difference at first glance. The initial layout and the pull-down menus are almost identical to the original; making the transition from MacPaint to FullPaint is a snap. All the familiar functions have been preserved. You can draw freehand lines or construct hollow shapes in the same variety of line styles, using the same mouse commands and keyboard shortcuts. You can fill screen areas with the same 38 patterns. You can stretch, trace, rotate, invert, and reposition objects; edit patterns and drawings pixel by pixel (what MacPaint calls "Fat-Bits"); and add text in an assortment of type fonts and sizes. FullPaint uses the MacPaint file format, so you can transfer FullPaint artwork to other programs with ease.

However, scratch the surface and FullPaint turns out to be loaded with significant enhancements. Some of them are simply convenience features sorely lacking in MacPaint, but others give you new flexibility and power.

Freed from the tyranny of the original Macintosh's 128K-byte limit, FullPaint lets you edit up to four paintings at once. The four windows can be shown singly, overlaid along a diagonal, or tiled into four postage-stamp boxes. Each painting now is bordered with standard Macintosh scroll bars, so you can slide around a page without having to crank away with the mouse.

You're no longer locked into the MacPaint screen layout. You can zoom a painting to full screen, even eliminating the command line at the top of the display. The two palettes

of tools can be dragged wherever you want them. Tapping the space bar hides them entirely; tapping it again brings them back. Once you've chosen a drawing tool, you can work on your painting without all the visual distractions of MacPaint.

Then you've got a number of new ways to manipulate images: free rotation to any angle, rather than MacPaint's 90-degree flips; Perspective, which lets you shrink or stretch one edge of an object; Skew, which allows you to move one edge (thereby turning a rectangle into a parallelogram, for example); Distort, which lets you pull out one corner of an image or push it in.

Text in a dark region can be entered as white on black. MacPaint is capable only of black on white.

But my favorite improvements are those that add precision controls to the MacPaint shell. First, you can display ruler lines (marked in your choice of inches, picas, centimeters, or pixels) along the top and left edges of any painting. Next, by selecting an option called MouseSpot, you can bring up a small status box that tells you exact cursor position as *x* and *y* coordinates measured in hundredths of units (excepting pixels, where fractions don't make sense) from the upper left corner of the page. Changing the units used in MouseSpot changes the ruler lines and vice versa. MouseSpot also shows the size of the object you're currently constructing, on both axes and along the diagonal. You can slow down the mouse to pixel-by-pixel motion by using FullPaint's MouseCrawl

**ITEMS DISCUSSED**

**FULLPAINT**.....\$99.95  
Ann Arbor Softworks Inc.  
308½ South State St.  
Ann Arbor, MI 48104  
(313) 996-3838

**MORE**.....\$295  
Living Videotext Inc.  
2432 Charleston Rd.  
Mountain View, CA 94043  
(800) 822-3700  
in California. (800) 443-4310

feature. The combination of ruler lines, MouseSpot, and MouseCrawl gives you pinpoint accuracy impossible with MacPaint.

My only real gripe is with the continuation of a major MacPaint annoyance: the invisible grid. You can turn on this feature, which locates objects along lines eight pixels apart, but you can't see the grid. Other graphics programs provide some form of visual reference; this is not the case with MacPaint or FullPaint. The grid is great for aligning text, but without MouseSpot you're practically running blind. I find this particularly frustrating because I see the grid as an important area for future development. Imagine being able to select single or multiple vanishing points, position a horizon line, turn on a grid, and construct drawings in *true* perspective! I guess I'll just have to wait for the next release.

The program seems to be solid—as

well it should, considering how much of its design is borrowed from MacPaint. I was able to crash it only once, after a long series of distortions, and although I tried mightily, I couldn't do it again. The crash, which merely garbaged up one file without bringing down either the system or the software, easily could have been the result of using an older version of the Mac operating system—or phases of the moon; I don't know. Overall, I was pleased with FullPaint's performance.

The documentation is complete and usually comprehensible, in spite of a tendency to use MacSpeak (the jargon of FatBits, scroll bars, double-clicking, and such). The manual even has an index, so I forgive the authors the constant use of "it's" whenever they should have used "its."

Should you buy the product? Well, if you purchase a new, unbundled Macintosh, you'd be foolish not to get FullPaint instead of MacPaint. Not only is FullPaint a richer, more useful program, it's cheaper.

If you already own MacPaint, you ought to spend some time assessing your needs before plunking down a hundred dollars for FullPaint. Do you see MacPaint as merely an entertainment package—cute, but frivolous? On the other hand, do you need the power of full-blown professional CAD software? In either case, FullPaint is off the mark. But if you presently use MacPaint drawings in your work, or just spend a lot of time relaxing with the program, switching to FullPaint will give you capabilities you'll wish you'd had all along. ■

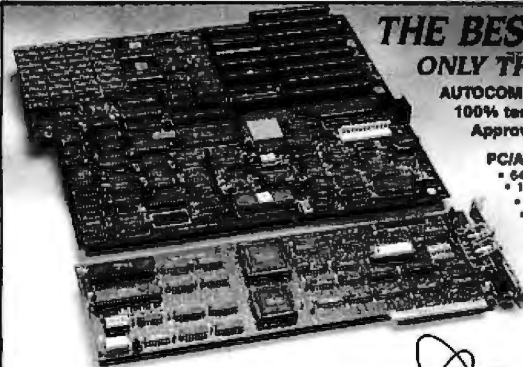

**THE BEST CARE MEANS YOU GET THE BEST PRODUCTS**  
**ONLY THE BEST IS GOOD ENOUGH**

AUTOCOMPUTER is a professional manufacturer in Taiwan. Our complete line is automatically produced and 100% tested by the HP3065 CLHL Auto test system. All of our products are with legal Phoenix bios and FCC Approval. OEMs & VARs inquiries welcome.

- PC/AT compatible including:**
- 640K MAIN BOARD
  - 1.2MB FLOPPY DISC
  - COLOR/GRAPHIC CARD
  - 200W POWER SUPPLY
  - EXPORT PACKING
  - HDD/FDD CONTROLLER
  - 20MB HARD DISC
  - PARALLEL/SERIAL CARD
  - MENU
  - CASE
  - KEYBOARD
- PCXT compatible including:**
- 256K TURBO MAIN BOARD
  - TWO DRIVER
  - DRIVER CARD
  - COLOR/GRAPHIC CARD
  - 135W POWER SUPPLY
  - MENU
  - EXPORT PACKING
  - KEYBOARD
  - CASE
- All kinds of PC XT/AT ADD-ON card**
- AC-T1002 EGA Card with AWARD Bios**
- Supports IBM color graphics & Monochrome Adapters and hercules modes.
  - Bit mapped graphics in four planes.
  - 640x350 resolution for IBM enhancer color display.
  - Full 16 color support in 640x200 & 320x200 pixels for IBM color display.
  - Supports 720x350 pixels for monochrome.
  - Supports 256K byte of memory using 6Kx4 drams.
- AC-T1001 PC/AT Main Board**
- INTEL 6 MHz 80286 microprocessor up-gradable to 8 MHz CPLD.
  - 640K byte standard main memory on board up to 1M bytes.
  - In system can install to 16M bytes.
  - 6 I/O expansion slots: 2 with single 62-pin connector & with dual 62-pin and 36-pin connector.
  - On-board battery socket
  - Manual available.

**AUTOCOMPUTER CO., LTD.**



4F, NO. 5, ALLEY 2, LANE SYH WEI CHUNG CHENG RD. HSIN TIEN, TAIPEI, TAIWAN. PO. BOX: 642 TAIPEI, TAIWAN. TELEX: 11888 APEXELEC TEL: 918-1800-4 FAX: 3948413

(continued from page 26)

tory entries do not change position) should survive sorting using his program.

Thanks for the continuing coverage of Apple topics.

DENNIS DOMS  
Kansas City, MO

Mr. Doms is absolutely correct. The program does not update the parent pointer field found in a subdirectory's header entry.

To fix the oversight, one should modify line 380 of listing 1 (page 124) to include a GOSUB subroutine call as shown below:

```
380 IF A <= C0 THEN
 FOR K=1 TO 39: POKE
 DB+3+B*39+K,ASC(MID$
 (NA$(A),K,1)): NEXT: PRINT ".,,";
 GOSUB 500: GOTO 400
```

Then append to the listing the following lines of code:

```
500 REM THIS CODE IS ADDED TO
 UPDATE THE PARENT
 POINTER
510 REM FIELD OF A
 SUBDIRECTORY
520 REM AT THIS POINT, DL(J) CON-
 TAINS THE BLOCK NUM-
 BER OF THE ENTRY DEFIN-
 ING THIS SUBDIRECTORY.
530 REM THE EXPRESSION (B+1) IS
 THE DIRECTORY ENTRY
 NUMBER WITHIN THE
 BLOCK SPECIFIED BY
 DL(J).
540 IF ASC(MID$(NA$(A),17,1)) <> 15
 THEN RETURN
550 POKE 791, ASC(MID$(NA$(A), 18,
 1)):
 POKE 792, ASC(MID$(NA$(A), 19,
 1)):
 XX = PEEK(791) +
 256*PEEK(792):
 REM XX = BLOCK NUMBER OF
 THE SUBDIRECTORIES
 KEY BLOCK
560 POKE 789, 0: POKE 790, PEEK(790)
 + 2:
 REM ALLOW READING OF THE
 KEY BLOCK INTO $9800,
 AN AUXILIARY I/O BUFFER
570 POKE 776,128: CALL 768: IF
 PEEK(786) <> 0 THEN PRINT
 "ERROR IN READING BLOCK NO.
 ";XX: STOP
580 REM NOW UPDATE THE PARENT
 POINTER AND WRITE IT
 BACK TO DISK
590 YY = PEEK(789) + 256 *
 PEEK(790):
 REM YY = ADDRESS OF THE
```

## AUXILIARY I/O BUFFER

```
600 POKE YY + 4 + 35, DL(J) -
 256*INT(DL(J)/256):
 POKE YY + 4 + 36, INT(DL(J)/256):
 POKE YY + 4 + 37, B + 1
610 POKE 776, 129: CALL 768: IF
 PEEK(786) <> 0 THEN PRINT
 "ERROR IN WRITING BLOCK NO.
 ";XX: STOP
620 POKE 789, 0: POKE 790, PEEK(790)
 - 2:
 REM SET THE I/O BUFFER AD-
 DRESS TO THE ORIGINAL
 BUFFER
630 RETURN
```

ANTONIO C. SILVESTRI  
Springfield, MA

## MAKING RS-232C CONNECTIONS UNIVERSAL

Howard Mark (March Letters, page 30) misunderstood the operation of "hermaphroditic" connectors when he wrote that Pete Klammer's scheme for simplifying the RS-232C tangle (October 1985 Letters, page 22) would not work. He assumed that when two such connectors were mated, pin 1 would contact socket 1, etc. But that is only one way of constructing hermaphroditic connectors.

Suppose instead that a connector has, say, five male pins, numbered 1 to 5, and five female sockets, numbered 11 to 15. When two connectors are mated, pin 1 mates with socket 11, and so on. This allows a completely symmetrical scheme:

## Connector A

|                  |           |
|------------------|-----------|
| Safety Ground    | Pin 1 --> |
| Data-out-from-me | Pin 2 --> |
| I-am-not-busy    | Pin 3 --> |
| I-am-ready       | Pin 4 --> |
| Signal Ground    | Pin 5 --> |

## Connector B

|               |                |
|---------------|----------------|
| >-- Socket 11 | Safety Ground  |
| >-- Socket 12 | Data-into-me   |
| >-- Socket 13 | Are-you-busy?  |
| >-- Socket 14 | Are-you-ready? |
| >-- Socket 15 | Signal Ground  |

## Connector A

|                |               |
|----------------|---------------|
| Signal Ground  | Socket 15 --< |
| Are-you-ready? | Socket 14 --< |
| Are-you-busy?  | Socket 13 --< |
| Data-into-me   | Socket 12 --< |
| Safety Ground  | Socket 11 --< |

## Connector B

|           |                  |
|-----------|------------------|
| <-- Pin 5 | Signal Ground    |
| <-- Pin 4 | I-am-ready       |
| <-- Pin 3 | I-am-not-busy    |
| <-- Pin 2 | Data-out-from-me |
| <-- Pin 1 | Safety Ground    |

I have followed here the (no doubt sexist!) convention that signals go from male pins to female sockets. I have not used the RS-232C circuit names because those assume precisely the distinction between DCE and DTE that this scheme is intended to eliminate. However, the 3-13 connection would correspond to CTS or RTS, and the 4-14 connection to DSR or DTR.

The problem with RS-232C is that it was designed around the quite specific job of connecting a terminal or computer (DTE) to a modem (DCE). Borrowing it to use for serial connections in general has produced the present muddle. As I've shown above, it is possible to create a new standard so that any connector can plug into any other, and this is surely long overdue. So come on, connector manufacturers and standards organizations—it's over to you!

ROBERT LABOURNE

Palmerston North, New Zealand

I read with interest the letter about RS-232C connections in the October 1985 issue. I, too, have long been dissatisfied with RS-232C because of the amount of Brownian motion required in trying various combinations to get box A to talk to box B. Too often the makers of box A and box B simply use the phrase "RS-232C" without giving enough clues to allow the user to make the correct combination. If we make changes to the traditional method, I don't think we should stop with only changing the type of connectors used. I suggest taking each of the pairs that sometimes need to be crossed, and converting each pair to a single wire. Yes, you can send and receive asynchronous DC full-duplex signals on one wire. The basic connection is illustrated:

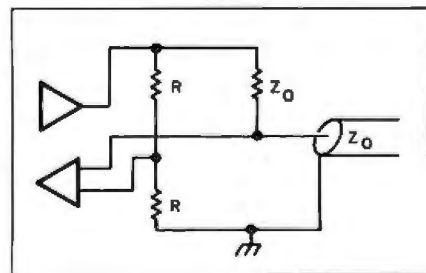

The differential receiver is relatively insensitive to the accompanying transmitter, while it is fully sensitive to signals coming from the cable. The circuit provides the added benefit of terminating the cable in its characteristic impedance at both ends. This method would allow you to connect any two of boxes A, B, or C using the same cable, and without making any jumper changes in any of the boxes. It would not matter if the boxes were computers, ter-

minals, or modems. I don't think there is a need for hermaphroditic connectors; we could just as easily demand that all boxes have female connectors and all cables have male connectors. We could connect a terminal to a computer with a single coaxial cable and a small phone plug.

NEIL R. KOOZER  
Oakland, OR

**SPARKING INTEREST IN PERSONAL SUPERCOMPUTERS**

Inmos is successfully programming their parallel computers in Occam, but I think the natural language/programming environment for a parallel computer is the electronic spreadsheet. Just have the system divide the spreadsheet into groups of cells and assign a processor to each group. The editing tools to create large spreadsheets already exist. There are also much more experienced users of spreadsheets than Occam programmers. And just think how big a spreadsheet could get before you'd have to defeat the "automatic recalculation"! The main extensions needed would be for nonnumeric input and graphics output.

JAMES R. VAN ZANDT  
Nashua, NH

Especially enjoyed Dick Pountain's article on the Inmos Transputer (BYTE U.K.: "Personal Supercomputers," July). Since Sir Clive Sinclair is said to be working on a supercomputer using this chip, what can we expect in 1987 or 1988? If development reaches fruition on the 40-Mb wafer-scale disk, that could make quite a machine combo!

Since the Acorn RISC chips are now being sampled, I hope we can look forward to a BYTE PC board using them.

Pountain mentioned Occam. Are books available discussing this language?

CHUCK TRIER  
Spokane, WA

**JUKI PRINTER MAINTENANCE**

I am writing about a maintenance problem on the Juki 6100. Recently my machine, which has run consistently for three years, began quitting in the middle of a printout. I hit Reset and it would go awhile longer and quit again. The problem worsened until I could only print a few lines before this "check" condition would arise.

Calling my local dealer wasn't too comforting. I was told it would cost \$40 to \$60 per hour just to have someone look at my machine. I had already upgraded the memory myself from 2K to 8K bytes without much difficulty, so I decided to take a look first.

Checking the user's manual, I learned that the "check" condition (the red LED lighting up) results from one of three conditions: when your printer is out of ribbon, out of paper, or when you have depressed the Pause switch. These are all considered "recoverable" errors.

The problem clearly wasn't related to Pause or paper, so it had to be a signal that the printer was out of ribbon. Of course, I already knew that I had ribbon in the printer, but the machine didn't seem

to. I set out looking for a device that was telling the machine that there was no ribbon.

I took out the ribbon cartridge; nothing. I took out the black plastic platform that the ribbon cartridge sits on. Still nothing. Finally, I took out the black spool on the left that the new ribbon feeds from. I saw a little black sensor that was covered with black dust. The bottom of the spool was designed as a reflector for that sensor. It

(continued)



**USRobotics' COURIER 2400™ ...The most dependable at 2400- or 1200-bps**

**Y**ou get 2400/1200/300-bps data communications and every first-class feature you'd expect in an auto-dial, auto-answer modem...at a surprisingly affordable price.

But a modem at any price is only as good as its performance...And that's where Courier 2400 really shines. Don't take our word for it. Ask any of the nearly 2,000 electronic bulletin board system operators who have chosen the Courier 2400 for one of the most demanding modem applications imaginable.

Listen to the unanimous chorus of praise for the Courier 2400 from tough reviewers at more than a dozen highly respected computer magazines.

Consider Courier 2400's performance record—less than one percent of all Courier 2400s sold have been returned for service, a record we challenge the industry to match. And we back up our confidence in Courier 2400

with a full two-year parts and service warranty.

Quality, performance, value—**your** modem should be this good. It is, if it's the **Courier 2400** from USRobotics.



The Intelligent Choice in Data Communications

8100 McCormick Blvd., Skokie, Illinois 60076  
Phone toll free 1 (800) DIAL USR  
In Illinois (312) 982-5001

-----  
 To learn more, send for our  
**FREE booklet: "24 Questions  
 and Answers on 2400-BPS  
 Modems"**  
 NAME \_\_\_\_\_  
 ADDRESS \_\_\_\_\_  
 CITY \_\_\_\_\_  
 STATE \_\_\_\_\_ ZIP \_\_\_\_\_  
 COMPANY \_\_\_\_\_  
 TITLE \_\_\_\_\_  
 PHONE (     ) \_\_\_\_\_  
 PERSONAL USE  BUSINESS USE

was set up with alternating black and silver spokes. The sensor is active when the silver passes over it but not when the black is present, I reasoned. If the spool didn't continue to get alternating signals, the printer could assume the spool wasn't turning and hence the ribbon had run out. I cleaned it and the bottom of the spool before reassembling. The dust was just carbon particles, but it was enough to cause a problem.

I have printed many perfect pages since then and I am still happy with my Juki. I hope that some of your readers can save money and frustration with this knowledge.

MARC J. VERBER

### CORRECTIONS ON RUNGE-KUTTA METHOD

I would like to point out three errors that appeared in "The Runge-Kutta Methods" (April). In table 6, Benku Thomas presents the constants for the Runge-Kutta-Verner seventh-order method. Three of them are incorrect. B(11,4) was -20325/5225, but should read -20032/5225; B(11,6) was -42509/7125, but should read -42599/7125, and B(12,7) was -71681/1166400, but should read -71687/1166400.

These corrections were taken from Thomas's reference 5 at the end of the article. Using these new parameters, this method gives excellent results. For example, solving  $dy/dx = y$  with solution  $y = e^{15} = 3269017.372460315$ . Comparing this to the exact result, the absolute error is  $-1.181 \times 10^{-6}$ , while the error criterion given by the method is  $7.689 \times 10^{-6}$ . This calculation was made using double preci-

sion (8-byte words) with VAX/VMS FORTRAN-77.

FRANCOIS LADOUCEUR  
Montreal, Quebec, Canada

### A CALL FOR HELP

Could you put me in touch with any individuals who are working on the problems of computer applications in archeology?

SEAMUS ROSS  
Institute of Archeology  
Oxford University  
Oxford OX1 1DP, United Kingdom  
Tel. 865-241214

### FOR A BETTER UNIFICATION ADAPTER

I am Japanese and am currently on assignment in Hong Kong. I own three NEC personal computers.

I read BYTE Japan: "An Innovative Program" (May) with great interest. But the article introduces only one operating system unification adapter, while completely ignoring the equal or even better systems for the NEC PC-9801 than EM/3+: Plus-80 and Spark from Canopus Electronics Co. Ltd. and Turbo-V from Kyoto Microcomputer Co. Ltd. I own both systems and am very happy with them.

This might be because William Raike's computer is a Fujitsu, which is said to make up only 10 percent or so of the total 16-bit personal computer market in Japan. Consequently, he can enjoy only limited software availability. The NEC PC-9801 series is doing in the Japanese 16-bit market what the IBM PC and its compatibles are doing in the rest of the world.

I think Mr. Raike's article thus misrepresents the Japanese market for this kind of product, and I would like to tell you and your readers about the other two unification adapters.

The Canopus system includes a Plus-80 card, which has a Z80 running at either 6 MHz or 8 MHz and 64K-byte memory, and software. This has been on the market for three years and the company claims that there are now 6000 users. This system was originally for CP/M-86. The PC-9801 with this board and accompanying software works just like the 8/16 system by CompuPro. The Plus-80's enhanced CCP checks the extension of executable files and switches to the appropriate CPU. Canopus introduced separately sold software called Spark for MS-DOS late last year. With the Plus-80 card and Spark, you can read and write CP/M-80 and -86 disks without any modification. You are in MS-DOS, so you can enjoy MS-DOS's redirection and piping just as with EM/3+.

The Turbo-V system consists of three options: software, V30 ( $\mu$ PD70116), and a 180 card, which employs a Hitachi HD64180 (6.144 MHz) and 64K high-speed RAM. The first two were introduced last October and a 180 card this March. If your PC-9801 includes an 8086 chip, you must get a V30 to replace the original 8086 as well as software. If, however, your PC-9801 is one of the new series with the V30, you can run CP/M-80 and -86 and MS-DOS software only with the Turbo-V software. If you want to run Z80-code CP/M-80 programs, you need a 180 card. This system provides a program called MIA for media conversion. This lets you read and write CP/M-80 and

## NEW FROM LOGICAL DEVICES INC:

### PROMPRO-8X™ Model II

A stand-alone programmer starting at \$895.00 can put you in business to program EE/EPROMs PAL/PLDs,\* Single Chip micros,\* and Bipolar PROMs,\* + EPROM IN-CIRCUIT EMULATION\* capability that can speed up your development time considerably and an RS-232 communications port that lets you integrate it with your IBM PC as a total firmware and Logic development station.

All from a company with an excellent reputation for quality and service.

## A UNIVERSAL DEVICE PROGRAMMER



-86 files while in MS-DOS. My PC-9801 has a V30 and can execute CP/M-80 (8080-code) programs three to four times faster than my old PC-8801 (Z80A-based machine) can.

I understand that EM/3+ comes with a board with a number of chips on it. This is for copy protection. You can copy the software as much as you want, but you cannot run it without this board. The software checks the existence of the board and if there is no board, it terminates the execution. The PC-9801 has only two to four slots (depending on which model) and it is simply outrageous that such a board occupies one of those precious slots. The other system's boards are solid single-board computers, and software is, of course, not copy-protected. EM/3+ is only able to emulate a Z80, while the other two execute the object codes. As the price is in the same range or even less for Turbo-V, I am sure you can easily tell who is the winner.

I hope Mr. Raiké will pay more attention to computer systems other than his own and will cover the Japanese market in wider areas.

MASAKAZU SONE  
Hong Kong

### **SORTING LARGE FILES ON SMALL MEMORY**

A sort that runs in  $O(n)$  time? I know it's theoretically impossible, but it can sometimes be done in practice.

Jonathan Amsterdam touched briefly on a most significant problem at the end of his article "An Analysis of Sorts" (September). In "real world" sorting, internal

memory is rarely sufficient for the sort at hand, and when the sort must use disk space, the "key operations" that determine turn time are no longer comparisons and swapping but disk accesses.

My "real world" involved sorting 50,000 to 60,000 records, each approximately 30 bytes in size, on a DEC 11/73. The sort ran several times a week and if it wasn't done by morning, other users slowed it down to a crawl. With task space limited to 64K bytes, my program could handle only 300 records in memory.

The solution: an algorithm that reads and writes each record twice. First, 300 records are read from the file to be sorted into a memory array. These are sorted by any handy routine (I use Quicksort) and written, in order, into the work file. The process is repeated for the whole input file. The work file now consists of sorted groups of up to 300 records. Further, the groups have been read and written sequentially to reduce head movement time.

Next, the first record in each sorted group is loaded from the work file into the memory array, along with a pointer indicating which group each record came from. The array is sorted, and the lowest entry is written to the final output file. The next record (if any) from that group is read into the first array position, and the array is again sorted by bubbling the new record up to its proper place. This "write and replace" process is repeated until all records of the work file have been transferred to the output file.

Now, I'm sure this technique has a fancy name and is nothing new to many, but it was new to me, and it taught me the power

of the meager space in internal memory. With a 300-entry array, I can sort 90,000 records in two passes, and that's good enough for my real world.

(PS.—A colleague spotted a method of exchanging the contents of two memory locations without using a third location. The trick involves XOR, but I like the BASIC version:  $A = A + B$ ,  $B = A - B$ ,  $A = A - B$ )

JOHN W. WARD  
Waynesburg, OH

### **FIXES**

#### **The Price of BYSO LISP**

In the review of BYSO LISP and Waltz LISP (William Wong's article in the July issue, page 293), we erred on one of the prices. The real price of BYSO LISP version 1.17 is \$150, not \$69.95.

If you'd like more information, contact Levien Instrument Co., Sittlington Hill, P.O. Box 31M, McDowell, VA 24458, (703) 396-3345.

#### **Ordering SPICE Thesis**

At the end of Wolfram Blume's "Computer Circuit Simulation" (July), an editor's note told how you could get a copy of "SPICE: A Computer Program to Simulate Semiconductor Circuits" by Laurence W. Nagel. That information needs updating. Here's how to get a copy of the document. Write a check for \$30 to the Regents of the University of California. Send it to Ms. Cindy Manly, EECS/ERL Industrial Support Office, 497 Cory Hall, University of California, Berkeley, CA 94720. ■

## **LEADER IN DEVICE PROGRAMMING**



\*some devices require optional adaptors.

### **FEATURES:**

- Stand-Alone/RS-232
- 512K bits RAM buffer
- EPROMs 2716-1 MEG
- Capacity: Two EPROMs (set programming)
- Accepts Intel, Mot. Hex files
- Accepts JEDEC files
- Optional Keypad/Alpha display
- Tilt stand and carrying handle
- Works with Exatron IC handler

also available: **UV ERASERS and GANG programmers.**

All products 100% made in U.S.A.

**CALL 1-800-331-7766**

Logical Devices Inc. 1321 NW 65th Place  
Ft. Lauderdale, FL 33309

|                   | TELEPHONE      | TELEX     |
|-------------------|----------------|-----------|
| U.S.A.            | (305) 974-0967 | 383142    |
| Canada East       | (514) 694-7710 | 05-823554 |
| Canada West       | (604) 291-8866 | 04-356533 |
| England           | 0652-688626    | 527339    |
| Italy, Ger., Swss | (02) 688-2141  | 845 79734 |
| Australia         | (03) 560-1011  | 790 35703 |
|                   | (02) 736-1564  | 790 82635 |

## **WITH AN UNUSUAL PRICE TAG: \$895**

# SOFTSTRIP® NOW OFFERS YOU SOMETHING IN NEVER BEFORE AVAILABLE...



CONVENTIONAL DATA HANDLING



THE SOFTSTRIP SYSTEM

## A CHOICE.

Until now you were stuck with disks.

No more. Install our unique STRIPPER™ software on your personal computer today and discover the many benefits of the fastest, easiest, least expensive way to handle information.

STRIPPER lets you print — ON PAPER — your own machine readable Softstrip data strips using your dot matrix printer. The Softstrip System Reader reads that information into a computer rapidly. With STRIPPER and the reader, your PC and printer become part of the most versatile information handling system available.

With this system you can do anything you wish with any data you have in your PC — ON PAPER.

**DATA ENTRY: Why use keystrokes when you can eliminate them with data strips?** Whatever the document - invoices, packing slips, memos, letters, sales reports, the list is endless — simply print a data strip right on the same printed page. Now you have a document that is both human readable and machine readable. A typical document can be entered in only 15 seconds using data strips. And, it ends keystroke errors forever.

**DATA DISTRIBUTION: Why copy disks?** It's time consuming and expensive. Softstrip data strips will end all that. Simply photocopy as many data strips as you like and send them by mail. Data strips ignore folding, coffee stains, ink marks and, by the way,

magnetic fields. And if you're using telecommunications, you can stop making the phone company rich.

**DATA STORAGE AND RETRIEVAL: Why have a file of disks and a file of paper?** Eliminate one with Softstrip data strips. File the data strip with the document. Better still, print the strip right on the document. Then put it in a file or binder.

Retrieval is simple. To find existing data, pull the document and its related data strip from the file. They've been stored together. Then use the reader to enter the data. No more hassle trying to match documents with the right disk — if you can find it.

**DATA TRANSFER: Why bother with cables, modems and phone lines to move files between computers?** A Softstrip data strip generated by an IBM PC can be read into another PC, or compatible, an Apple or even a Macintosh. If you work at home on a Macintosh, make a data strip on your printer, take it into the office and read it into your IBM PC. Simple. And we've created the utilities to let you do that easily. (See Application Notes on opposite page.)

Fascinating, isn't it? Anything you can do with disks can be done with the Softstrip data strip system — faster, easier and at lower cost — ON PAPER.

All you need is STRIPPER software at **\$19.95** and the Softstrip System Reader at **\$199.95**.

**Softstrip**<sup>®</sup>  
COMPUTER READABLE PRINT

The PC  
USER'S  
EDGE

# DATA HANDLING

## SEPTEMBER CASE HISTORY



Nick Turner, editor of *Dr. Dobbs Journal*, has been making his own data strips to back up and store articles, listings and other important materials. Turner notes that the STRIPPER™ software "creates compact, machine readable archives that are immune to dust, dirt and magnetic fields". Strips that Turner prints on his printer are filed in a loose leaf binder, along with the appropriate article. This permits him to pull the strip from the binder and read it back into his computer quickly using the reader. The method saves

disk file space, since once an article has been printed, maintaining it on a disk for revision isn't required.

The STRIPPER system has solved another problem for the busy editor, inter-machine file compatibility. Using the Softstrip® System, Turner can transfer files between his PC-clone and his Macintosh "with a minimum of fuss".

"It's about time we had a way to store files on paper in machine readable form," Turner comments. Mr. Turner's comments are his own and do not reflect the opinion of the publication.

## APPLICATION NOTES

On the other side of this ad we said you can move data between different programs — on paper.

Using Softstrip data strips you can!

For instance move data between AppleWorks and Excel and back. Or Lotus 1-2-3 to and from AppleWorks.

We've created a series of several dozen Application Notes on Softstrip data strips. These lead you through simple steps to make the file transfer as easy as possible.

Here are just a few examples:

- AppleWriter to or from MacWrite.
- dBASE to or from Appleworks.
- WordStar to or from AppleWriter.
- WordStar to or from MacWrite.
- Framework to PageMaker.

And more are coming.

**ACT NOW!! Don't delay.**  
See your local **SOFTSTRIP**  
dealer or call us at 1-800-533-7323.  
In Connecticut: 203-573-0150.

**Users' Groups: Call for  
special User Group deals.**

These strips contain "The IRA Calculator," a worksheet for calculating returns with either Lotus or Excel. To receive the complete Application Note, call 1-800-533-7323, or write to Cauzin.

## CAUZIN

835 South Main Street  
Waterbury, CT 06706  
(203) 573-0150

Inquiry 61

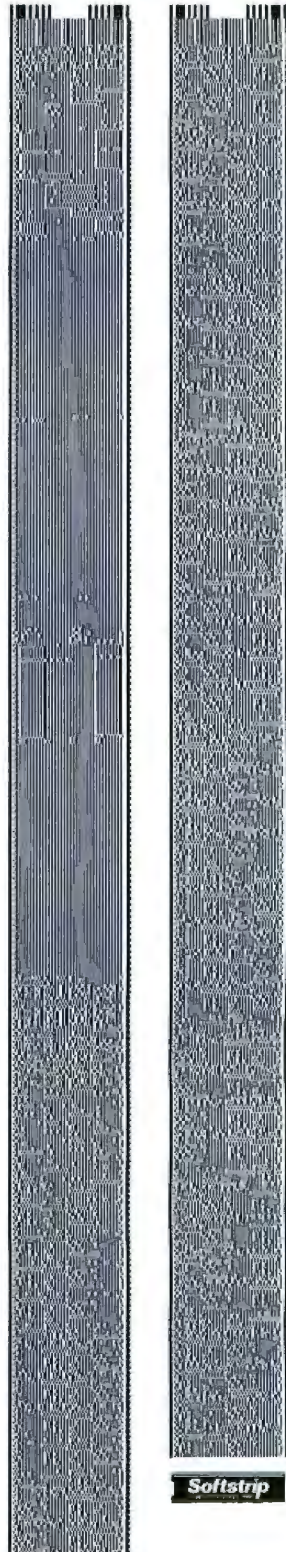

Softstrip

IBM is a registered trademark of International Business Machines Corporation.  
Framework is a trademark and dBASE is a registered trademark of Ashton-Tate.  
PageMaker is a registered trademark of Aldus Corporation.  
Cauzin and Softstrip are registered trademarks and STRIPPER is a trademark of Cauzin Systems Inc.  
WordStar is a registered trademark of MicroPro International Corporation.  
Lotus and 1-2-3 are registered trademarks of Lotus Development Corporation.  
MacWrite, AppleWriter and AppleWorks are trademarks and Apple is a registered trademark of Apple Computer.  
Excel is a product of Microsoft Corporation.  
Dr. Dobbs Journal of Software Tools is published by M&T Publishing, Inc. under license from People's Computer Company.  
Macintosh is a registered trademark of McIntosh Laboratories licensed to Apple Computer Inc.

## Conducted by Jerry Pournelle

### MAC PROS AND CONS

Dear Jerry,

For the past few days, I have been browsing through old copies of BYTE, looking for information that I may have missed the first and second times through and especially to reread your columns. I must say, I learn more every time I reread them. At any rate, I feel compelled to write you after seeing once again your remarks concerning Apple's Macintosh.

I am a Macintosh owner, and I like the machine overall. However, I have to agree with some of your complaints about it. The most important problem with the Mac is the speed of disk access (when using floppies). I once read a rationalization that excused the slow disk access on the grounds that the Mac needs to load so much more information upon return to the Finder. Indeed, I've written a couple of programs in Microsoft BASIC that use disk files, and access times are acceptably quick in that use. However, the fact remains that loading an application is still dreadfully slow.

One problem I have with the Macintosh is one you haven't addressed, the difficulty of really programming an application. You've mentioned that you have Mac-Modula-2 but have never said whether you have done anything with it. I purchased a Pascal compiler from TML Systems of Melbourne, Florida, along with both volumes of *Macintosh Revealed* by Stephen Chernicoff (excellent descriptions of most Toolbox routines). I have since sold the compiler. Why? Your old documentation complaint. The manual that came with the compiler was just about useless, unless you have already done extensive programming in Pascal on the Macintosh. As I consider myself to be a novice as far as programming is concerned, the documents did me no good. I quickly gave up on it, disgusted. Maybe I have a learning impediment or something, but the Mac is *not* easy to program. I now appreciate why it took six months to a year for any decent applications to appear for the machine.

I'm learning MS-DOS out of necessity, since that's most likely what I'll be confronted with when I start working as a programmer, but I want to learn how to program the Macintosh because I love it.

Despite my complaints about the machine, Apple did so many things right, and its implementation of an extremely simple user interface is a step in the right direction. It's unfortunate that most people will never really appreciate the work and energy that goes into a well-designed Macintosh application.

PHILIP E. JURGENSON  
Mankato, MN

*I don't expect there will ever be an end to the Macintosh debate.*

*The first I ever heard of the Mac was when Pamela Clark, then editor in chief of Popular Computing, told me that Apple was coming out with something wonderful that she couldn't tell me about. I continued to hear how great it was; the mountain was in labor. What came forth was the 128K-byte Mac that sold for \$3000, followed by an overpriced upgrade that did nothing for the early loyalists who had bought the original.*

*On the other hand, I agree: Apple changed the micro world forever with the Mac operating system. It was too slow, and some parts of it were too cute, but it sure beat A> all hollow. Unfortunately, much of the machine was dictated by ideology, not reason.*

*It's probably all moot. Apple is moving ahead with a machine related to the Mac in the same way that the new Ford Taurus is related to the Edsel, while Atari and Amiga have 68000 machines that take Apple's innovations and go off in new directions.*

*I love it when a bunch of smart people start competing to give me better machines.—Jerry*

### SALES HELP WANTED

Dear Jerry,

My family manufactures custom aluminum architectural products for domestic and industrial purposes. Our modus operandi is, typically, as follows: Clients phone us and specify a product, say, window series G2. Then they proceed to give us some dimensions, number of shutters, glass thickness, number of units, etc. The salesman, after a brief discussion with the client, elicits any other information

deemed relevant, like cost, practicality, etc. So far, so good. The salesman then provides an estimate based on the cost of the materials and submits it to the client for approval. Invariably, the client requests a change, in which case the salesman must resubmit weeks of work. This is particularly true with industrial clients. Such delays do us no good. Furthermore, salesmen tend to depart frequently, and training new people to perform tedious tasks is no fun. Finally, after the client is satisfied, the salesman prepares a bill of materials that details, down to the smallest rubber washer, the parts to be removed from our inventory and sent off to the site.

Do you know of any software that will eliminate the need for these repetitive calculations? I envisage a situation where a client calls up and presto! an estimate is ready, a bill of materials is available at the press of a button, and the inventory is just waiting to be depleted.

SANJAY A. BULCHANDANI  
Stanford, CA

*General program, no; I'd think you need a special program. Fortunately, it need not be written from scratch. I think it could be handled with an application program in dBASE II, but if I were you I'd go to Guru from Micro Data Base Systems (P.O. Box 248, Lafayette, IN 47902, (317) 463-2581); costly, but worth it given the size of the problem. You'll have to get a programmer to customize, but that shouldn't be too difficult.*

*Guru is a sort of combination expert system and database; I'll have a full review in a later column. Meanwhile, I'm impressed.—Jerry*

### THUMBS UP ON TOP-DOWN PROGRAMMING

Dear Jerry,

I found Mr. Suits's letter to Chaos Manor Mail (March) most eloquent in his criticism of top-down programming. Unfortunately, I couldn't disagree more strongly with both the analogies he chose and the conclusions he drew from them. Musicians tinkering with notes, artists idly sketching, and writers experimenting with the effect of words are not good comparisons for

(continued)

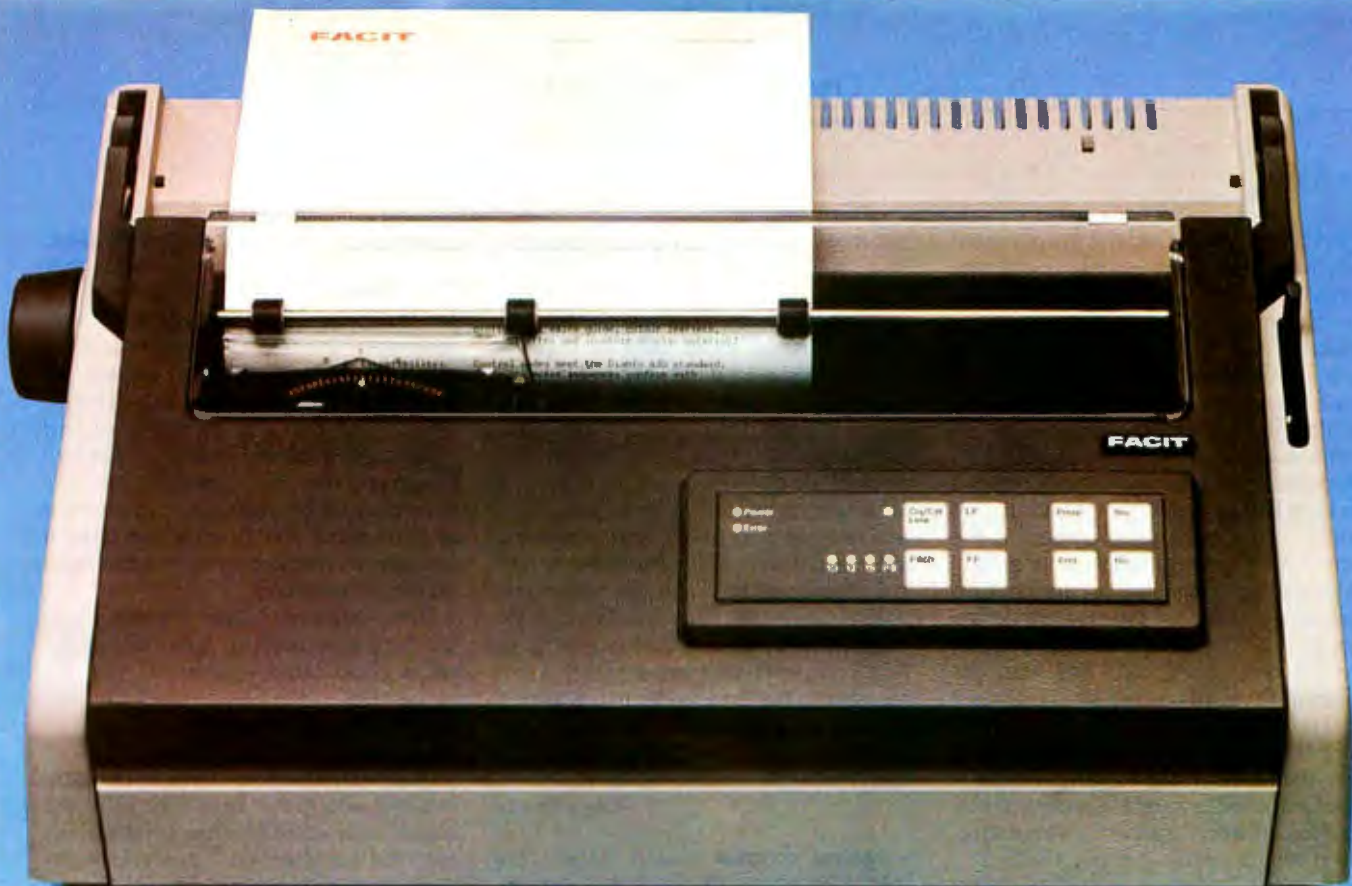

# THE DAISY THAT TAKES YES FOR AN ANSWER

## Yes!

To set up the Facit D2000 daisy-wheel printer, just respond to printed questions using "yes" and "no" keys. This permits almost instant changes between applications and host computers.

- The printer produces very high letter quality printing. And it does it fast - 24 cps.
- Interfaces with most computers including IBM PCs. And with most standard software, too. Both parallel and serial interfaces are available.
- An automatic paper injector takes care of the entire paper loading operation when using fan-fold and single cut sheets.
- The D2000 can be equipped with inexpensive tractor and cut-sheet feeders handling both European and American paper formats.

## No!

There is no other way to produce typewriter quality printings than to use a daisywheel printer.

- The printer won't take up much of your desk space as the footprint is very small.
- No annoying noise is produced thanks to a specially designed, rubber enclosed concrete platen.
- Facit D2000 is not merely a converted typewriter. It is specifically developed for your professional computer printer applications.

## FACIT

Inquiry 420

Head Office: *Facit AB, S-17291 Sundbyberg, Sweden. Phone: (8) 764 3000.*  
 USA: *Facit Inc. P.O. Box 334, Merrimack, NH 03054. Phone: (603) 424-8000.*

AUSTRALIA: EAI Electronics Associates Pty Ltd, 427-3322. AUSTRIA: Ericsson Information Systems GmbH, 0222-613 641. BELGIUM: Ericsson S.A., 02-243 82 11. CANADA: Facit Canada Inc., 416-821-9400. CYPRUS: LBM (Lillytos) Ltd 516 46 34. DENMARK: Facit A/S, 02-92 24 00. FINLAND: OY Facit, 90-420 21. FRANCE: Facit S.A., 1-4780 7117. GREAT BRITAIN: Facit 0634-40 17 21. GREECE: Computer Application Co. Ltd., 01-671 97 22. HONGKONG: Gilman & Co. Ltd., 5-893 00 22. ICELAND: Gisli J. Johnsen HF, 354-64 12 22. INDIA: Forbes Forbes Campbell & Co. Ltd., 22-26 80 81. IRELAND: Ericsson Information Systems Ltd., 75 30 93. ITALY: Facit Data Products S.p.A., 039-63 63 31. JAPAN: Electrolux (Japan) Ltd., 03-479-3411. KOREA: K.D.C. Corporation, 723-8555/8236. THE NETHERLANDS: Ericsson Information Systems B.V., 03480-709 11. NEW ZEALAND: Northrop Instruments and Systems, 501-801 501-219. NORWAY: Ericsson Information Systems A/S, 02-35 58 20. PORTUGAL: Regisconta Sarl, 1-56 00 91. SINGAPORE: Far East Office Eqpts Pte Ltd., 745 82 88. SPAIN: Facit, 91-457 11 11. SWEDEN: Ericsson Information Systems Sverige AB, 08-28 28 60. SWITZERLAND: Ericsson Information Systems AG, 01-391 97 11. WEST GERMANY: Ericsson Information Systems GmbH, 0211-61 090.

good programmers and the environment they work in. While creativity is often involved in programming (or any profession, for that matter), it is not, like true art, a creative end in itself but usually an endeavor with a practical goal in mind. A much better analogy with a programmer would be an architect, whose craft requires discipline, who pursues work with a pragmatic end, and who is not without creative and aesthetic considerations. We would have better programmers if the same risks were involved in writing code as designing a building, where crushed people, not bugs, are the result of design sloppiness. One does not easily imagine an architect saying, "To hell with the blueprint! I've got a hunch two beams will hold this baby just fine." Everyone resents rules and constraints, yet we should recognize their reason for existing. Efficient, free-form code is as rare as arrogant programmers— who think they're above structured programming—are plentiful.

Of course "ideas do not usually jump, full-blown, to the conscious mind;" and yes, "the very *doing*" does help establish the framework or structure of a project. Thus the need for the preliminary design work

that most successful programmers use in their profession. The introductory layout of a Pascal or Modula-2 program is not "ceremony"; it has a purpose. If that purpose is obscure to Mr. Suits or tries his patience ("I find it difficult to begin scanning a Pascal program without thinking, 'Damn it! Get to the point!'"), it's because it helps people to *find* the point. I'm sure most of us have reviewed source code we've written in nonstructured languages years earlier, only to find that something that was easily understandable when fresh in the mind was hard to follow some time after the event. Doubly frustrating is for a second party to wade through the mess. That I wouldn't wish on anybody, yet it happens 10,000 times a day in businesses, schools, and government offices across the country. Old computer languages and bad habits die hard.

JAMES BAKER

*Agreed, completely, and thanks. One thing I like about CBASIC is that you can, if you're so inclined, write highly structured code, with everything declared (the compiler can detect undeclared variables if you tell it to) and generally top-down*

*organization. Not long before he died, my mad friend MacLean said that CBASIC wasn't really BASIC at all; it was far too good. But then he was pretty thoroughly anti-BASIC, largely because in the early days you wouldn't believe the spaghetti that was served as programs.*

*For a job that's to be run once and once only, it hardly matters what language you use. For something you may have to work on again after an absence of six months, you'd better use, if not a structured language, at least good organizational methods.*

*The controversy is over whether or not the language ought to force you to develop good habits.—Jerry*

### Z-100 AND BORLAND

Dear Jerry,

I wanted to thank you for your favorable remarks about the Zenith Z-100 in the March issue of BYTE. The Z-100 has not received the attention it deserves, especially from software vendors. To give an example, I purchased Turbo Pascal last summer. When I attempted to order Turbo Graphix Toolbox for the Z-100, I was told that it was not available and that they were not sure if and when it would ever be available. What is especially irritating is that in the back of my Turbo Pascal reference manual, and on various order forms that came with the package, they specifically mention that Turbo Graphix Toolbox is available for the Z-100. I feel that I was deceived by this material published by Borland. Since they quote you as saying this is a high-quality product, I thought you should be aware of the situation.

ROBERT R. JUNE  
Grand Forks, ND

*The Z-100 with a PCompatible board is still a darned good option, if only because it runs WRITE and a whole mess of other CP/M programs as well as PC-DOS stuff. On the other hand, things flow in the computer world: what was best last year isn't necessarily so this year.*

*Borland told me they were going to do Turbo Graphix Toolbox for the Z-100; apparently they decided not to go ahead, which is a real pity. I hope they'll change their ads, or better yet, put someone on to doing it. Alas, though, since Zenith has sold mass quantities of the 248 (a very good machine) to the government, including the service academies, they've let the Z-100 fall between the cracks. I can understand, given market realities, but it's a pity; I'd hoped that dual-processor machines would reunite the micro users. Oh well.—Jerry ■*

## What is a Best Western?



"My home  
office  
wherever  
I travel."



The right place at the right price.

Make reservations at any Best Western,  
see your travel agent, or call toll-free  
**1-800-528-1234**

"World's largest chain of  
independently owned  
and operated  
hotels, motor inns and resorts"

# With all these SoftLogic Solutions, you could run out of problems.

Now there's a whole family of low-cost, easy to use Softlogic software for the IBM PC, XT, AT, and compatibles. They'll save you time, aggravation, and lots of money. Got a problem? Check out these Softlogic Solutions.



## Software Carousel™—The easy way to move from one program to another.

What a hassle. Saving, exiting, loading, retrieving—just to move from one application to another. With Software Carousel, you can keep up to ten programs loaded and ready to run. Best of all, you can use all your memory in each and every one. Supports AboveBoard™ and RAMpage™, too.

## Disk Optimizer™—Speeds up your disk by cleaning up your files.

You may not notice, but your hard drive is getting slower. Because your files keep getting fragmented and scattered on your disk. Reading, writing, everything takes longer, because your disk is working harder. Disk Optimizer puts back the speed by putting your files back in one piece—where they belong.

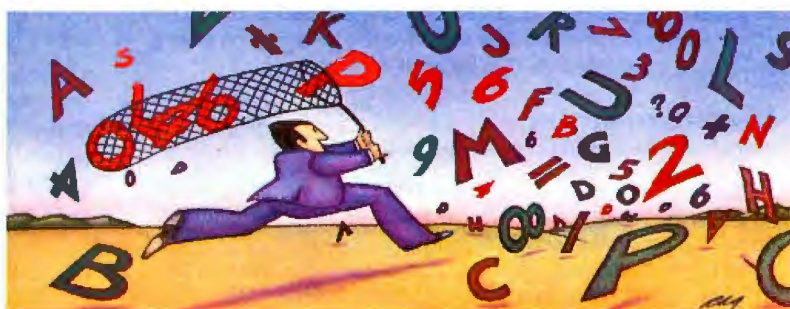

## Cubit™—Packs more of your data onto less disk space.

Filling up your hard disk again? Don't run out and get a bigger drive. Get Cubit, and get up to twice the storage capacity from the drive you already have. Cubit compresses and decompresses word processor, spreadsheet, database, all kinds of files—quickly, safely, invisibly.



## DoubleDOS™—The multitasking software that takes less of everything.

You can spend more money, load more memory, and read more manuals with systems like Top-View™ or Windows™. Or you can get DoubleDOS, the amazingly simple concurrent software environment that lets you and your computer each work on different tasks at once. Nothing could be easier. And nothing costs you less.

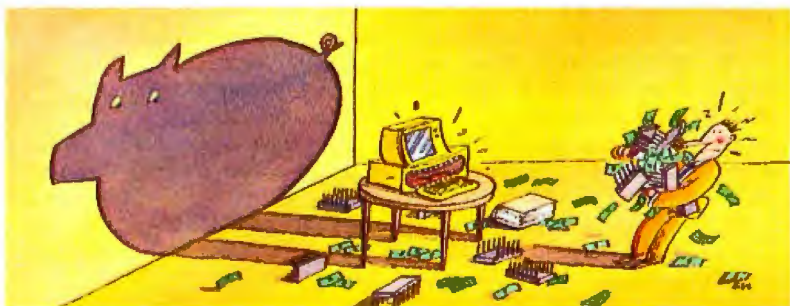

Put your problems behind you. Order these SoftLogic Solutions today.

**\$49<sup>95</sup>\***  
Each

\*Plus \$5.00 shipping & handling.

So why put up with problems? Especially when you can get dependable SoftLogic Solutions for just \$49.95\* each. Ask for SoftLogic products at your computer dealer. Or order directly from SoftLogic Solutions by calling 800-272-9900 (603-627-9900 in New Hampshire).

Order today:  
**800-272-9900**

SoftLogic Solutions, Inc.  
530 Chestnut Street  
Manchester, NH 03101  
800-272-9900 (603-627-9900 in NH)

**SOFTLOGIC**  
SOLUTIONS

BIX is the BYTE Information Exchange, BYTE's ongoing electronic conference. Each month, this section attempts to give readers a glimpse into this constantly evolving, rapidly growing exchange of ideas and information. This month, the conferences covered are Amiga, Atari ST, IBM PC (and clones), Macintosh, and Pascal.

For information on joining BIX, see page 357.

## AMIGA

Once again the Amiga conference has come in as one of the busiest on BIX. This month's selections begin and end with problems, the first concerning a missing text file and the last with troublesome C libraries. In between, there are two discussions on different aspects of using the Amiga for its musical capabilities and a request for advice on making the programming leap from C to assembler.

### DISK SECTOR SURGERY

**amiga/main #3080, from dcoulter [Derek Coulter]**

Help! I've destroyed one of my most important text files by accidentally OPENing the file for output in Amiga BASIC. As you know, OPENing an existing file erases its contents.

Am I right in assuming that the sectors containing what was in the file were not deliberately wiped clean (i.e., zeroed out) by DOS when I OPENed the file? If I am, I wonder if it's possible to look at individual disk sectors directly? If I could do that, I could search each one until I found the text.

I'd be very appreciative if someone would recommend a program (preferably in the public domain that I could download from BIX) that would allow me to read sectors. Or even suggest how a BASIC-bound non-developer Amiga enthusiast like me could do it from Amiga BASIC.

**amiga/main #3093, from rankin [John Rankin]**

**a comment to message 3080**

Yes, there is a program that you can use to do just that. It is called DiskEd and can be found in the "b" directory of some disks. It is designed to allow you to edit a disk sector by sector, which can be useful in cases such as yours. Be aware, however, that it is very difficult to use if you do not have a copy of the "AmigaDOS Technical Reference," and even then the help the manual gives is marginal. If you have patience I am sure that your efforts will prevail. I have repaired several disks that belonged to friends of mine who were in similar situations. It just takes time and a little know-how; be sure to read as much as you can before you start to use this program.

I found my copy of this program on the Amiga Cambridge LISP Disk, so I'm sure that there is probably one available if you look hard enough. Good luck.

**amiga/main #3095, from fnf [Fred Fish]**

**a comment to message 3093**

There is a very nice little public domain disk salvager (called DiskSalv) that has appeared on Usenet and is on my library disk number 20. I believe there is also something similar in the AmigaDOS 1.2 alpha/beta releases.

**amiga/main #3097, from jdow [Joanne Dow]**

**a comment to message 3093**

DiskDoctor is coming in version 1.2. I don't know if it will recover erased data, but it will generally clean up a disk.

**amiga/main #3098, from langeveld [William Langeveld]**

**a comment to message 3093**

DiskEd is not on any standard disk that I know of. It is supposedly a program for developers. Developers are privileged people who get a lot more software from Commodore-Amiga than us common mortals.

**amiga/main #3099, from langeveld**

**a comment to message 3095**

The program that will be released with 1.2 is called DiskDoctor. It supposedly comes on a disk called "The Toolbox" and will initially be handed out only to developers. Later on it might be available for the rest of us, but it is not clear whether that pleasure will be, er, for free.

**amiga/main #3102, from demo9 [Pat Harrington]**

**a comment to message 3095**

I have an alpha of version 1.2 of the OS and hope DiskDoctor will be generally available despite messages here to the contrary. I used it to recover a disk that crashed on me (it contained files I had downloaded on-line) that I couldn't even format. I got the message "Hard error cylinder 0... Format abandoned" before fixing it with DiskDoctor. In other words, it sure seemed to do the trick for me.

**amiga/main #3109, from duck [Dale Luck, Commodore-Amiga]**

It will probably be available only to registered developers. That's one of the reasons to become a registered developer; you get some of these goodies. Please remember that there is a world of difference between something we hacked up to do a quick job and something that is ready as a supportable product. DiskDoctor is once again written in unsupported (to Americans) BCPL.

**amiga/main #3113, from Inoland [Les Noland]**

**a comment to message 3098**

I got a copy of DiskEd with my Amiga Pascal but I certainly wouldn't suggest anyone buy it just to get a copy of DiskEd. That's especially true given the fact that DiskEd is about as much fun to use as receiving a heavy wooden mallet on the cranium.

**amiga/main #3118, from jdow**

**a comment to message 3080**

On reflecting, I don't know how from BASIC, but the trackdisk interface shown in one of the Fred Fish support files (#5 disk) shows individual sector access. With that I bet a modest effort could generate a sector patcher routine. Now, I suspect this might be very hard to do from BASIC, but access is possible.

**amiga/main #3251, from langeveld**

**a comment to message 3080**

Even though your message is two weeks old, you still may want to know that on fishdisk 20 there is a program called DiskSalv, which is supposed to not only fix broken disks but also retrieve deleted files. If you don't have it but still want it, I might be persuaded to upload it to Listings.

*[Editor's note: DiskSalv is now available for downloading from the Amiga library in the Listings section of BIX. Information concerning the fishdisks (public domain software for the Amiga) mentioned above may be obtained by sending a SASE (57 cents postage) to: Fred Fish, 345 Scottsdale Rd., Pleasant Hills, CA 94523.]*



**SOUND SAMPLER**

amiga/main #3025, from jsan [Jez San]

Does anyone know of a sound sampler unit for the Amiga that is actually shipping? I need one very quickly (i.e., tomorrow!)

FutureSound is about 5 weeks away (so the lady on the phone says), which, translated into real terms means 10 weeks. And there are others advertised but I haven't tracked any down.

If not, does anyone know of a decent sampler unit for any other machine, or even a stand-alone synthesizer with sample capability that has provision for uploading and downloading the samples to another host, possibly down the serial port?

amiga/main #3036/3037, from langeveld  
a comment to message 3025

Call Mimetics. They were selling a sound sampler at the last FAUG meeting (a week ago).

The address of Mimetics is

Mimetics Inc.  
P.O. Box 60238 Station A  
Palo Alto, CA 94306  
Tel. (408) 741-0117

Their sound sampler is around \$100. The MicroForge unit should also be shipping, but it is around \$350. I have not actually seen that one, though.

amiga/main #3039, from Inoland  
a comment to message 3025

This is speculative, but you might check it out. I don't know of any sound-sampling devices for the Amiga that are shipping right now, but there is a very reasonably priced sampling keyboard made by Ensoniq, called the Mirage (when I say reasonably priced, I mean for a sampling keyboard, not for just a sampling device—I believe the price is \$1695). I don't know how possible or easy it would be to transfer those samples to the Amiga but you might want to check it out. They do store the samples on 3 1/2-inch disks but I don't know what format they're in. They also advertise that there are sound-editing programs available "for all major personal computers." I doubt that that includes the Amiga at present but who knows?

Ensoniq's particulars: Ensoniq Corp., 263 Great Valley Parkway, Malvern, PA 19355.

In Canada: 6969 Trans Canada Hwy., Suite 123, St. Laurent, Que. H4T 1V8.

In Europe: Ensoniq Europe, 65 Ave. de Stalingrad, 1000 Brussels.

In Japan: Sakata Shokai Ltd., Minami Morimachi—Chu-O Building, 6-2 Higashi-Tenma, 2-Chome, Kita-Ku, Osaka 503.

amiga/main #3124, from grogers [Steve Mueller]  
a comment to message 3039

Actually, the Ensoniq (like the Prophet 2000, Emulator 2, Roland SP units, and the Yamaha samplers) dumps sample data over MIDI (so compatible disk format is no object, *nest-ce pas?*) in a quasi-compatible format. You can't quite read one sample file from another synthesizer (yet). Advantage of Ensoniq? Not much; it uses 8-bit samples. Prophet 2000 uses 16-bit samples. You could probably make an Ensoniq clone with the Amiga, a minimal amount of hardware, and a lot of software.

amiga/main #3147, from cmcmanis [Chuck McManis]

For those of you who are music buffs and are going to be hooking up  
*(continued)*

**COMPETITIVE EDGE**  
631 S. MAIN ST. • PLYMOUTH, MI 48170 • (313) 451-0665

**VELOCITY 286** 10/12 MHZ **\$2995/\$3295**



1024K on MB Par, Ser, Clock, 30 MB Fast Hard Disk 1.2 MB Floppy, DOS 3.2, Enhanced Graphics Adapter.

**BASE AT™ Compatible**  
1.2 Floppy, Floppy/HD Contr. 512K, P/S + Case, Keyboard \$1295

|                                                      |                           |
|------------------------------------------------------|---------------------------|
| CompuPro Ram 22 ... \$446.00                         | Disk/A ... \$446.00       |
| LOMAS Thunder + 512K ... \$895.00                    | 1024K ... \$1046.00       |
| MD-200 Hercules® Compatible mono card .....          | \$ 99.95                  |
| CGP-300 Std color card with Parallel .....           | \$ 89.95                  |
| MF-100 Multi-function card to 384K ØK .....          | \$ 99.95                  |
| Memo 576K Memory board to 576K ØK .....              | \$ 49.95                  |
| MF-3000 Multi-function for AT to 3072K, ØK .....     | \$ 199.95                 |
| FDDA-100 Floppy controller for PC 4 drs .....        | \$ 44.95                  |
| MIO-100 Floppy multi-function card P,5,ØK .....      | \$ 99.95                  |
| DIO-200XT P,5,ØK ... \$69.95                         | DIO-200 AT ... \$72.95    |
| MD-2000XT/AT above board to 2048K, ØK EMS .....      | \$ 149.95                 |
| Vutek EGA, CGA, EGA, Hercules compatible .....       | \$ 325.00                 |
| M-EGA, CGA, EGA compatible (to 10MHz) .....          | \$ 275.00                 |
| Teac FD-55B DB/00 .. \$105.95                        | Teac FD-FF6F ... \$119.95 |
| Seagate ST225 20 MB H.D. ... \$325.00                | ST4038 ... \$589.00       |
| ST4051 ... \$648.00                                  | ST4096 ... \$1295.00      |
| Western Digital AT Floppy Hard Disk Controller ..... | \$ 219.95                 |
| Everex AT Floppy/Hard Disk Controller .....          | \$ 199.95                 |

AT is a trademark of IBM, Ram 22, Disk/A, CompuPro are trademarks or registered trademarks of Viasyn.



**Finally, a proven CAD system for the Amiga**

**DYNAMIC-CAD**

What AutoCAD® can do for the IBM®, Dynamic CAD can do with the Amiga... and a great deal more for less than a fourth of the price!

**E**merging from years of successful problem solving applications in piping, and electronics for the aerospace industry, DYNAMIC CAD has brought a highly advanced and powerful CAD system together with today's most dynamic and versatile micro-computer, the Amiga. DYNAMIC CAD takes full advantage of Amiga's extensive capabilities with color, multiple modes of resolution, mouse functions, and easily accessible pull-down menus.

This is not some promised "vapor-ware." DYNAMIC CAD exists now and comes to the Amiga with a proven track record. The time and money-saving applications of DYNAMIC CAD for engineers and architects are truly astounding. Here is an advanced, 2-D drafting system with isometric capabilities that can be combined with many models of printers, plotters, and digitizers. In getting started you'll have the support of an extensive manual written in understandable English along with working examples as tutorial lessons.



Inquiries invited. (818) 360-3715  
P.O. BOX 3475, GRANADA HILLS, CA 91344

synthesizers to your Amiga even though it already has the best sound capabilities on the market, may I suggest you look at the Yamaha DX-100. I just got one at a recent sale here in Silicon Valley and am quite pleased. It was \$350 and although it can't sample directly it can play back sampled waveforms. Adds another 8 voices to the existing 4 of the Amiga. Now if I could just get a decent music package . . .

**SOUND CHANNEL ALLOCATION**  
 amiga/softw.devlpmt #1779, from cheath [Charlie Heath]

I've been dealing with putting together three separate audio device users (speech, a canned music driver, and a custom sound-effects driver), and have found it difficult to deal with channel allocation. It seems that there is a missing link—once an audio channel has been "stolen" from a user, the user has to explicitly test to find out that that has happened and then must reallocate it.

It seems to me that there should be a "borrow" channel command, which would take the channel when a higher-priority request is made but would automatically restore ownership to the prior owner. Sort of like prioritized multitasking, except it would never time-slice; you would own the channel until a higher-priority request occurs, and you would get the channel back when the higher-priority user released it.

Has anyone else found this to be true? It seems to me that people are now dealing with this in one of four ways: set the priority to MAX, so nobody else can get the channel; ignore the problem—if the channel is allocated by another user, it is never reallocated; test to find out if the channel has been stolen every time an audio command is issued, with a considerable performance penalty and a lot of overhead; test only at convenient places in the code (like at the start of a song or sound effect, etc.).

amiga/softw.devlpmt #1803, from sbennett [Steven Bennett]  
 a comment to message 1779

Alas, we're stuck. Sound channels, once stolen, are not returned. I suspect that this is because the driver was designed more so that the programs using it would allocate the channel, send out a sound (like one note), and deallocate it immediately thereafter. Unfortunately, this does cost a bit in overhead, and I suspect (will have to write a program to test it someday RSN) this overhead is too costly to use. In my stuff, I am being nasty and allocating at maximum priority, at least for now.

I do suspect, however, that simply checking to see if the channel has been stolen for each audio driver call is not too much overhead. If you are running asynchronously (which is generally best for this kind of stuff, unless you like waiting for sounds to finish) then all you have to do is check the error return of the call, which will tell you that the channel requested is not available immediately. Not exactly the nicest method to the driver, but it works.

Once you have discovered your loss, it is up to you to do anything you need to. Usually, this means preceding any call to output to that channel by an attempt to allocate it.

One final note. The list of suggested priorities in the RKM ("ROM Kernel Manual") could be shuffled around a bit but otherwise makes some sense if you really want to be nice to other programs running. Eventually, I'm going to have to see if I can change my program to handle this stuff correctly. But if it is too much time and trouble (and this especially includes overhead), I am going to be nasty and hog the channels anyway, under the assumption that the user is unlikely to run two audio-intensive programs simultaneously. Better that than to have a program that produces less than quality sound.

amiga/softw.devlpmt #1804, from cheath  
 a comment to message 1803

That seems to concur pretty much with what I'd thought. The problem comes when you want to combine two audio drivers into one program, say for digitized sound effects and music. That might not be such a problem if there is a single arbitrator in the program, but unfortunately I've been working with a canned music driver for which I don't even have access to the source code—so I can't build such arbitration in.

amiga/softw.devlpmt #1809, from jdow  
 a comment to message 1804

Only thing I could imagine using sound channels in both of two programs for would be a character in a program—check for sound allocation and flash screen as an alternative—or accompanying music with speech commentary. But then the sync would want to exist between the music and the speech. Hence they'd have to be in the same program.

|                                         |                     |
|-----------------------------------------|---------------------|
| 3 1/2" Disk Labels TFF-FF               | 100/\$8.95          |
| 3 1/2" Disks (DS, DD)                   | 10/\$27.99 1/\$2.99 |
| 3 1/2" Disks (SS, DD) Plain Label Brand | 10/\$20.95 1/\$2.19 |

**CLASSIC IMAGE, INC. - PRESENTS**

DIABLO - Graphic mind challenge game Amiga/Atari™ \$29.95  
 DISK LIBRARY - Now you can File, Catalog, Update, Search, Cross Reference, Report \$49.95

Amiga System Covers - W/mouse/LOGO \$21.95  
 Amiga Disk Cover - 1010 or 1020 with LOGO \$7.99  
 Atari ST System Covers - w/mouse drive/LOGO \$34.95

Paper TFF-FFF White, 9 1/2 x 11, 20lb. 150/\$8.99  
 Paper TFF-FFF White, 9 1/2 x 11, 20lb. 1000/\$22.95  
 Paper TFF-FFF 1/2" Greenbar, 9 1/2 x 11, 18lb. 1000/\$18.99  
 Index Cards - TFF-FFF, 3 x 5 500/\$7.95  
 Rolodex Cards - TFF-FFF, 2 1/6 x 4 500/\$8.95  
 Labels - TFF-FFF, Address 1000/\$5.00

**Dealers Welcome**

S&H-\$2.50 US M.W. RUTH CO., B106  
 S&H-\$4.50 CN Visa 510 Rhode Island Ave.  
 US \$'s only Master Cherry Hill, NJ 08002  
 (609) 667-2526

We stock what we sell, for fast delivery.

Send for FREE CATALOG

ATTENTION PROGRAMMERS - Let us take over the headaches of publishing your software. We are looking for all items related to the "AMIGA" & "ATARI ST".

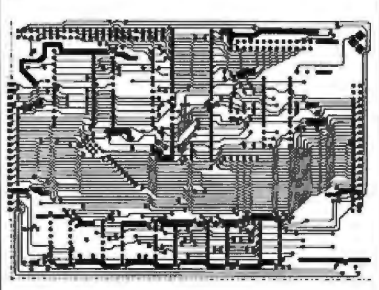

**PC10™**  
 Printed Circuit Layout For The Amiga™

|                                                                                                                                                                                                                                                                                                                                                                                                          |                                                                                                                                                                                                                                                                                                                                                                                 |
|----------------------------------------------------------------------------------------------------------------------------------------------------------------------------------------------------------------------------------------------------------------------------------------------------------------------------------------------------------------------------------------------------------|---------------------------------------------------------------------------------------------------------------------------------------------------------------------------------------------------------------------------------------------------------------------------------------------------------------------------------------------------------------------------------|
| <ul style="list-style-type: none"> <li>• High performance</li> <li>• Semi-automatic routing</li> <li>• Trace yield</li> <li>• Auto clip/dip/skip</li> <li>• 100% cut-1 layers</li> <li>• Full silkscreen</li> <li>• Utilize color</li> <li>• Area minimist</li> <li>• Simplification (zoom)</li> <li>• Interface sketch</li> <li>• Drill matrix checkplot</li> <li>• Camera rdy. vid. plotter</li> </ul> | <ul style="list-style-type: none"> <li>• Powerful workspace operations</li> <li>• B-layer capability</li> <li>• Object Libraries</li> <li>• Multiple pad types</li> <li>• 950 centers</li> <li>• Block operations</li> <li>• Abs. rd &amp; local manipulation</li> <li>• Editing, move copy, delete</li> <li>• Global trace following</li> <li>• Supports hard drive</li> </ul> |
|----------------------------------------------------------------------------------------------------------------------------------------------------------------------------------------------------------------------------------------------------------------------------------------------------------------------------------------------------------------------------------------------------------|---------------------------------------------------------------------------------------------------------------------------------------------------------------------------------------------------------------------------------------------------------------------------------------------------------------------------------------------------------------------------------|

System price -- \$1800 / Functional sample disc \$75 (credit towards purchase)

PC10 © Soltektron, Inc. / Amiga © Commodore, Inc.

TRUST IN A NUMBER OF ENGINEERING UNIVERSITIES FROM PROGRESSIVE FUTURE SOFT CORPUS, INC., 401 S.W. 79TH TERRACE N. LAUDERDALE, FL 33068, (305) 781-3707

**"An Amiga without FutureSound is like the Rolling Stones without Mick Jagger"**

With FutureSound you can record any sound and play it back. Record Mr. Spock off the television, your mother-in-law off the phone, or your own voice narrating your creations. Jumping Jack Flash!

Applied Visions  
 15 Oak Ridge Road  
 Medford, MA 02155  
 (617) 488-3602

**MOVING TO ASSEMBLER**

amiga/softw.devlpmt #1792, from pjohnston [Dale Kuethe]

Can any of you programming geniuses help me out? I am making a transition from C to assembler for reasons of size and speed. (As put in the movie "Top Gun," "I feel the need. The need for speed!") I cannot afford Tech Manuals yet and I learn best from examples anyhow. What I am looking for is the Intuition functions and animation stuff. I have done it all in C before but it is just too bulky and slow. Also, if you have a few seconds (and are feeling very, very generous) it'd be nice if you uploaded your best 3D graphic routines...

amiga/softw.devlpmt #1794, from jdow  
a comment to message 1792

Probably the quickest trick from Lattice C is to run OMD (Object Module Disassembler) on the object code and feed the result to an editor to make it something the assembler would really like. Then start hand-optimizing the results. Of course, the OMD route is moot for Aztec, as it has an assembler stage in the compile. Take that output and again hand-optimize.

amiga/softw.devlpmt #1795, from cheath  
a comment to message 1794

The Manx output is really easy to convert to assembler, since you can just put in "#asm" statements after compiling a "C" function to assembly source. That makes it easy to get function arguments and structure offsets correct. However, the current version of Manx's assembler is not very good for "stand-alone" development. It was really designed to accept the compiler's assembler source output, and not much else. I understand Manx is making some improvements in the assembler for the next update, though.

**AZTEC C LIBRARIES**

amiga/softw.devlpmt #1780, from mikeduffey [Mike Duffy]

Problem: Basically, I get a working program with individual .o files and a non-working program with the same files in a library. No errors on link, just a different-sized program that loads, begins to execute, and then software-error task held. For more info, see "manx.aztec/amiga." Thanks for any help you can offer.

amiga/softw.devlpmt #1782, from frn  
a comment to message 1780

This one bit me once a long time ago. Seems that there are some latent problems in the librarian program, the end result of which is a corrupted executable.

amiga/softw.devlpmt #1784, from langeveld  
a comment to message 1780

That's right, the librarian with 3.20a is next to useless. What does work is to join the .o's together with the DOS command "join." That does mean, however, that all .o's are linked in.

amiga/softw.devlpmt #1789, from cheath  
a comment to message 1784

Are you sure about that, Willy? I thought that only worked for ALink-style libraries, not with Manx. Haven't tried it, though.

amiga/softw.devlpmt #1791, from langeveld  
a comment to message 1789

Yup, have tried it myself. Besides, somewhere in manx.aztec/amiga.c jgoodnow says that it will work the way I described.

amiga/softw.devlpmt #1812, from mikeduffey

Aztec users might want to see manx.aztec/amiga #115 if they are creating programs with large (>64K) data segments for a linker bug that bit me. By the way, rumor has it that Aegis developed its stuff with Aztec. Can w.volkægis confirm or deny this? Since the Aegis products are fairly big, have you encountered any problems when stretching your tools (e.g., Aztec/Lattice/etc.) to the limits?

amiga/softw.devlpmt #1820, from w.volkægis [William Volk, Aegis Software]  
a comment to message 1812

Draw is a big program (150K object) but has a smaller than 64K data segment (almost everything is allocated on the fly). I believe you have to use a linker option (or compile option) to go to the "large data

(continued)

**ANALYZE!**

- PULL-DOWN MENU INTERFACE (MOUSE DRIVEN)
- 256 COLUMNS BY 8192 ROWS
- CONSERVATION OF MEMORY
- FLEXIBLE VIDEO DISPLAY
- POWERFUL ARRAY OF SIMPLE AND COMPLICATED MATHEMATICAL FORMULAS
- SORT/DATABASE FUNCTIONS
- COMMAND MACROS
- DELUXE PRINTABLE GRAPHICS (IFF COMPATIBLE)
- DEDICATED FUNCTION KEYS FOR COMMON COMMANDS
- NATURAL RECALCULATION ORDER
- PRINT FORMATTING AND CONTROL
- PROJECT ICON SUPPORT

**\$149.95**



**MICRO-SYSTEMS SOFTWARE, INC.**  
4301-18 OAK CIRCLE, BOCA RATON, FL 33437  
**(800) 327-8724**

**Quelo® 68000** Software Development Tools

- Motorola compatible macro assembler
- Industry standard
- Mature—first release January 1983
- Source code available

**Amiga and Atari 520/1040ST**  
68000/68010/68020

| Host          | Target      | 68000/68010 package | 68020 package |
|---------------|-------------|---------------------|---------------|
| Amiga         | Amiga       | \$ 99               | \$149         |
| Atari         | Atari       | \$ 99               | \$149         |
| MS-DOS/PC-DOS | Amiga/Atari | 199*                | 249*          |
| CP/M-80       | Amiga/Atari | 199*                | —             |
| CP/M-86       | Amiga/Atari | 199*                | 249*          |
| CP/M-88K      | Amiga/Atari | 199*                | 249*          |

\*Includes corresponding native assembler.

Additional hosts and targets available:  
UNIX 4.2, UNIX V, VAX VMS and external 68xxx boards

Contact Patrick Adams today  
**Quelo, Inc.**  
2464 33rd Ave. West, Suite 173  
Seattle, WA 98199  
phone 208/285-2528 — telex 910-333-8171

Trademarks: Quelo, Quelo, Inc., MS, Microspec Corp., CP/M, Digital Research, UNIX, Bell Labs, Amiga, Commodore-Amiga, Inc., Atari, Atari Corp.

**2 MEGs For Your AMIGA!**

A must for software developers  
Allows more programs to run simultaneously and faster  
Can be used to increase system RAM or for a FAST RAM DRIVE  
Uses standard memory bus architecture to allow for future compatibility  
Allows full use of memory expansion port for additional peripherals

**AX2800 2 MEG RAM Board \$899.00 U.S. (\$1276.00 CDN)**  
**AX1000 1 MEG RAM Board \$729.00 U.S. (\$1035.00 CDN)**

Complete in case, nothing else to buy!  
1 year manufacturer warranty!

**DEALER INQUIRIES INVITED**

Comspec Communications Inc.  
153 Bridgeland Avenue, Unit 5  
Toronto, Ontario, Canada  
M6A 2Y6 (416) 767-0617

Prices shown are F.O.B. Toronto  
AMIGA is a registered trademark of Commodore Business Machines.

model." Aztec default is to use 16-bit offsets from a register (fast and compact). I recommend eliminating global data wherever possible (style consideration).

amiga/softw.devlpmt #1822, from mikeduff  
a comment to message 1820

Most of the nonallocated data is 0x6000 bytes of chess openings in encoded format, so it's not something I'd like to allocate and read off of disk (yet another file for the user to accidentally lose). Incidentally, the large data model does not necessarily mean what you think. You can mix large and small and (in theory) the linker will notify you when a piece of small data cannot be reached (page cc.11 of the Aztec manual).

amiga/softw.devlpmt #1823, from cheath  
a comment to message 1822

Sounds like that big array could easily be accessed from only one file using long pointer addressing. Question is, though, is all the Data put in front of all the UData with the current linker? (Have you thought about putting the chess openings into a "comment" hunk, which would be ignored by the loader but which you could go back to and read explicitly as a file?)

amiga/softw.devlpmt #1824, from mikeduff  
a comment to message 1823

Yeah, from the link map, Data and UData are both in segment 0 (code in 1) with Data first. Thanks for the "comment" hunk suggestion. I can see I am following where others have already worn a trail.

amiga/softw.devlpmt #1825, from cheath  
a comment to message 1824

Actually, I haven't tried the comment hunk deal—but I'd like to know if it works. I've got these nasty data files all over the disk!

amiga/softw.devlpmt #1826, from mikeduff  
a comment to message 1825

Any suggestions for hiding data files and/or determining where all the application-related files live? Somehow, these problems are never fixed until the third or fourth release of the OS (witness MS-DOS, which has yet to get it quite right), but they're quite important for developing robust applications.

amiga/softw.devlpmt #1827, from cheath  
a comment to message 1826

I was hoping to get by with an "assign" and use a pseudo device name within the program. That puts the burden on the user, but what the heck. If the user has put a floppy in with the volume name, it will get accessed automatically; if the user copies it to another disk or hard disk, they gots to include an "assign" in the startup sequence, or something.

**REGISTER A6 AS A FRAME POINTER**  
amiga/softw.devlpmt #1913, from [goodnow (Jim Goodnow)]

I've been doing some looking and thinking about this whole thing with using A6 as the frame pointer. When I originally decided to use A5, I  
*(continued)*

# WiseTEK INT'L, INC.

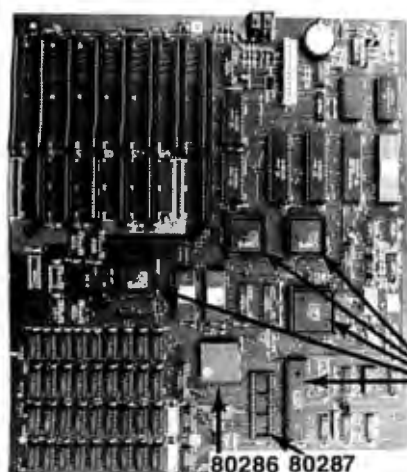

## ← TURBO AT

- 80286 IBM Compatible
- 6 MHz, 8 MHz, or 10 MHz Keyboard Switch
- 5 CHIPS SET—(Lower Heat. Higher Quality)
- 0 or 1 Wait State
- 1 MB Memory
- On Board Battery
- 80287 Socket Ready

## TURBO XT →

- 8088-2 IBM-XT Compatible
- 4.77 MHz or 8 MHz Keyboard Switch
- 4 Layer PC Board
- 640K Memory
- 8087 Socket Ready

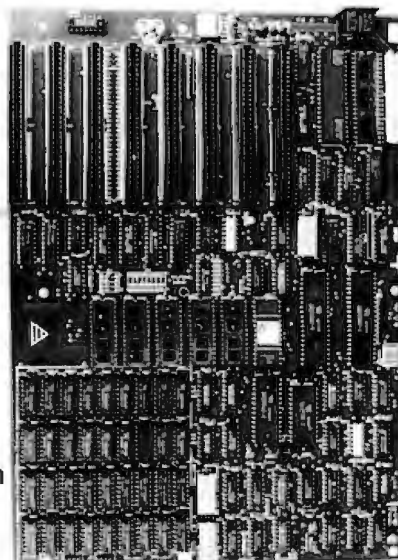

**We are the manufacturer.**  
WiseTEK International, Inc.  
513 Valley Way  
Milpitas, CA 95035

**Distributors, Dealers,  
OEM Welcome**

TEL: (408) 263-1237  
FAX: (408) 263-1870

# Increase your knowledge about all aspects of computers

An absolutely no-risk guarantee.

## Select 4 Books for only \$2<sup>95</sup> and get 2 Free Gifts!



More programs, projects, and ways to use your micro.  
Keep well-informed about the latest books available—and get the *original publisher's edition* at a discount of up to 65% off the publisher's price!



1939 \$24.95    1989 \$22.95    2620 \$25.95    1978P \$17.95

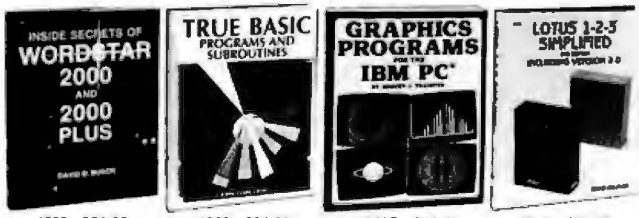

1993 \$21.95    1990 \$24.95    1556P \$15.50    2748 \$21.95



1873 \$21.95    1724P \$13.50    2754 \$28.95    1920 \$22.95

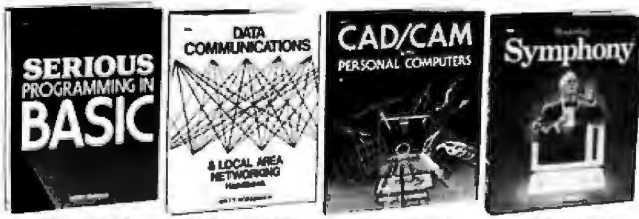

2650 \$21.95    2603 \$25.00    1852 \$21.95    1948 \$22.95



1742 \$24.95    1947 \$25.00    2786 \$18.95    1501P \$15.95

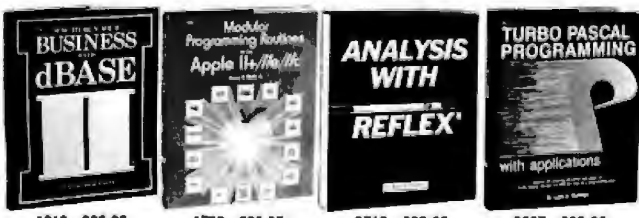

1918 \$26.95    1732 \$23.95    2712 \$22.95    2627 \$23.95

### BUSINESS SOFTWARE

- 2664. Working with DisplayWrite 3 \$24.95
- 1966. Money Management Worksheets for 1-2-3™/Symphony™ \$21.95
- 2688. The Illustrated Dictionary of Microcomputers—2nd Edition \$24.95
- 2674. Mastering Omnis® 3 \$24.95
- 2678. Harvard Project Manager/Total Project Manager: Controlling Your Resources \$21.95
- 2684. SuperCalc® 3: Learning, Using and Mastering \$22.95

### OTHER OUTSTANDING SELECTIONS

- 2668. Advanced Excel™ 26.95
- 1848. Making MS-DOS and PC-DOS Work For You \$19.95
- 2842. 101 Projects, Plans and Ideas for the High-Tech Household \$24.95
- 1874. Unix™ and Xenix® Demystified \$21.95
- 1764. Making CP/M-80® Work For You \$16.95

### OPERATING SYSTEMS

- 1886. Mastering the 68000™ Microprocessor \$22.95

### PROGRAMMING TECHNIQUES

- 1737. The FORTRAN Cookbook —2nd Edition \$18.95
- 1970. True BASIC® —A Complete Manual \$22.95
- 1997. 468 Pascal Problems with Detailed Solutions \$21.95
- 2682. An Introduction to Prolog \$24.95
- 2692. Designing and Programming Personal Expert Systems \$27.85
- 1876. Getting Great Graphics \$25.85

### IBM PC

- 1911. IBM® PC Expansion Guide \$24.95
- 1921P. Serious Programming For The IBM® PC™/XT™/AT™ Paper \$15.95
- 1929. Networking With the IBM® Network™ and Cluster \$29.95
- 1940. 101 Ready-To-Run Programs and Subroutines for the IBM PC® \$16.95
- 1710P. Fundamentals of IBM PC® Assembly Language Paper \$15.50

(Publisher's Prices Shown)  
© 1986 The COMPUTER BOOK CLUB®



## The Computer Book Club®

### FREE when you join!

**Investment Analysis with Your Microcomputer**  
How to speed up and simplify your financial decision-making, including ready-to-run programs! A \$13.50 Value.

**BASIC Statements, Commands and Functions**  
An indispensable pocket guide for every BASIC programmer.



**Membership Benefits • Big Savings.** Save up to 75% on books sure to increase your computer know-how. • **Ironclad No-Risk Guarantee.** If not satisfied with your books, return them within 10 days without obligation! • **Club News Bulletins.** All about current selections—mains, alternates, extras—plus bonus offers and special sales. Comes 13 times a year with hundreds of titles to choose from. • **Automatic Order.** Do nothing, and the Main Selection will be shipped automatically! But . . . if you want an Alternate Selection, or no books at all, we'll follow the instructions you give on the reply form provided with every News Bulletin. • **Bonus Books.** Immediately get Dividend Certificates with every book purchased and qualify for big discounts of 80% to 80%. • **Exceptional Quality.** All books are quality publisher's editions offering the most authoritative information on the latest hardware and software applications.

If card is missing, use this address to join: THE COMPUTER BOOK CLUB®  
P.O. Box 80, Dept. BY-986, Blue Ridge Summit, PA, 17214

# People who deal with "baud" use every bit of McGraw-Hill

Nobody understands the value of good information better than the people who work in computers and communications.

And for those people, no information carries more weight than McGraw-Hill's. We provide the databases, analyses and news that computer and communications professionals rely on to illuminate the workings of their industries.

Everyone in the business keeps up with the latest developments by reading McGraw-Hill maga-

zines. *BYTE*, *Electronics* and *Data Communications* are all required reading in the field. So are books from Osborne/McGraw-Hill.

For people who buy computers (and run EDP operations) the most widely respected source of information is *Datapro*.

*Datapro's* print and on-line directories and reports cover every aspect of computer hardware and software, from mainframes to micros, as well as communications and office automation. There's even

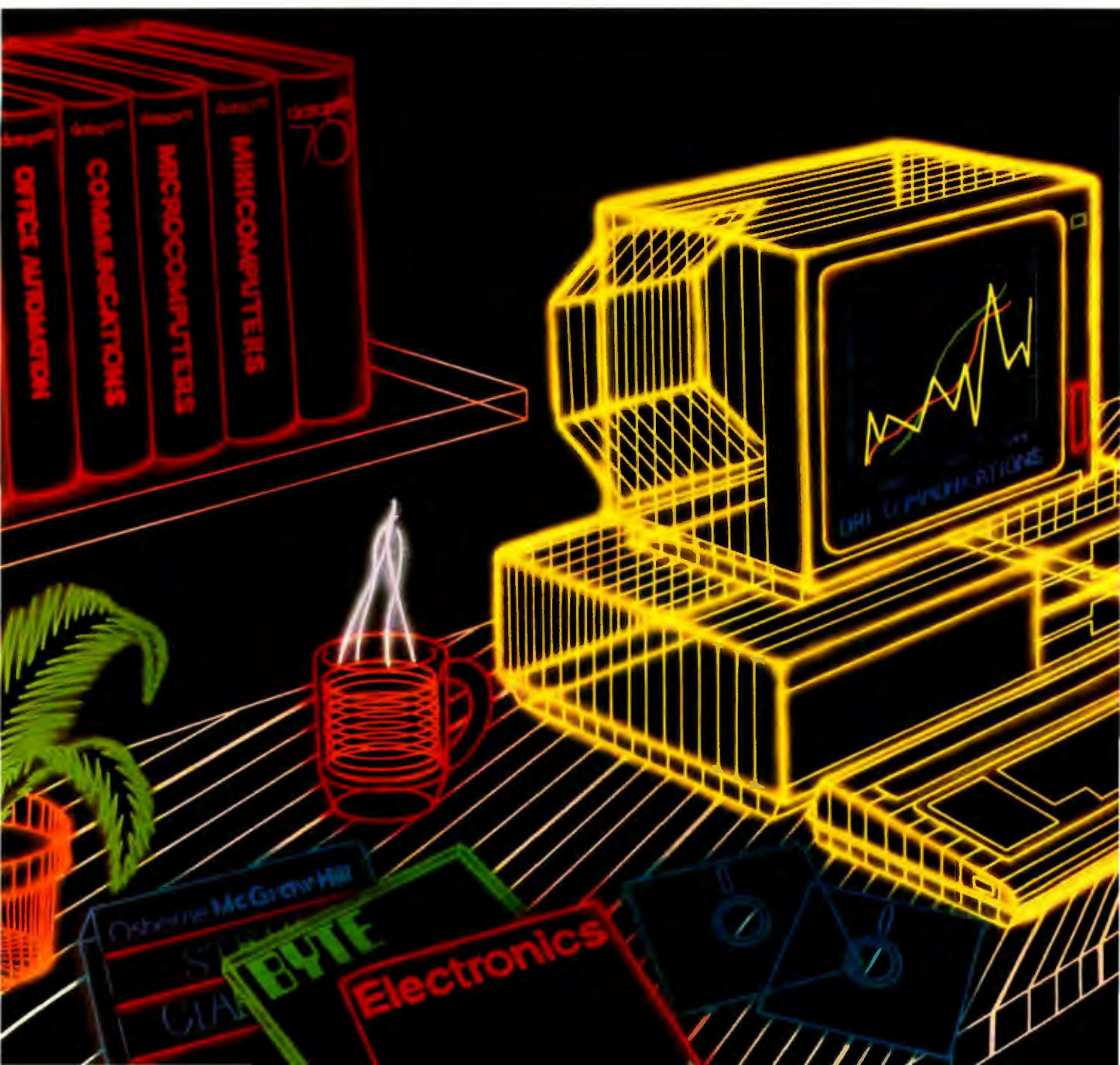

# and "byte" information.

a report on how to protect electronically stored information from piracy.

For people who manufacture or sell microcomputers and micro software, Future Computing is the number one information source for product tests, analyses and comparisons.

People who specialize in communications are wired into CCMI/McGraw-Hill, to receive not only the hard facts on communications tariffs, but also in-depth analyses and bottom-line recommendations,

via print, software and on-line products.

When it comes to turning megabytes into megabucks, nothing computes like McGraw-Hill information.

McGraw-Hill, Inc., 1221 Avenue of the Americas,  
New York, N.Y. 10020.

**McGraw-Hill.**  
Information that leads to action.

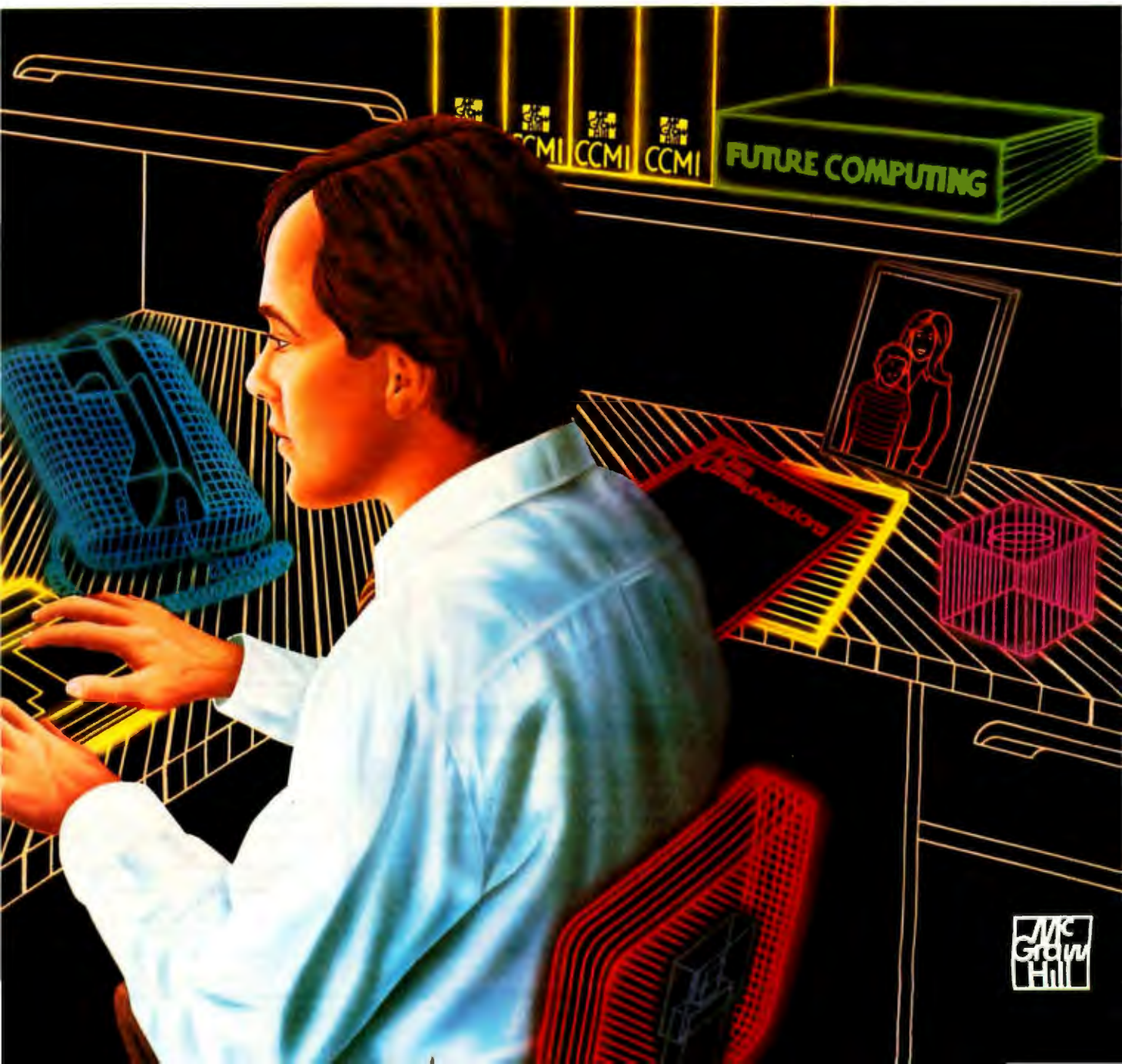

**McGraw  
Hill**

was operating pretty much on my own with no feedback. Now, however, with all youse useful people here, let me put it to you. The question really comes down to speed. Size was originally an issue, but I now have a way of cutting the size down even with A6 being the frame.

To recap the question for those unfamiliar with it, when a C program makes a call to one of the resident libraries, it has to load A6 with the base of the library before calling the function. If A6 is used as the frame, it has to be saved and restored. The difference in code looks something like this:

```

move.l a6(sp) vs. move.l __DosBase,a6
move.l __DosBase,a6 jmp __LVOInput(a6)
jsr __LVOInput(a6)
move.l (sp)+,a6
rts

```

A difference of about 51 cycles. There is also an obvious size difference, but there are other ways around that. The question is whether the 50 to 60 cycle difference is worth the incompatibility problems. Obviously, for most DOS and EXEC calls this is not a problem, but what about GRAPHICS, LAYERS, and INTUITION?? I look forward to any and all comments, since I have to make a decision in the next few days. Thank you.

amiga/softw.devlpmt #1914, from langeveld  
a comment to message 1913

I have a prejudice toward A6 for the frame pointer. Reason: I have both the Aztec C compiler (commercial version) and Absoft FORTRAN. I occasionally want to call C functions from FORTRAN, but Absoft insists that the frame pointer be A6.

Is it possible to make this a switch in the compiler (he asks in full naivete, not really knowing what's involved)?

amiga/softw.devlpmt #1915, from jgoodnow  
a comment to message 1914

A switch would be easy, but the problem is what about all those libraries that were compiled with the switch set to A5, and the assembly language glue routines that have to have one or the other hard-coded in. Part of the problem at the moment is that there are too many

choices: near/far code, near/far data, 16/32-bit ints, A5/A6 frame ptr.

Whoops! Almost forgot, FFP/IEEE/68881, which makes for 16 regular libraries and 48 math libraries. I like giving people a choice, but that's a lot of disks. Unfortunately, my nice-guy nature gets me in these jams! (grumble grumble try to be nice to everybody...)

amiga/softw.devlpmt #1916, from cheath  
a comment to message 1913

Jim—The compatibility issue isn't too important for me, because I don't tend to port a lot of stuff between the compilers. I could see it being a problem for some folks that want to be able to put together object code modules from both compilers—and it sounds like, since your new linker supports the ALink format, that would become a practical possibility RSN.

The only reason I would want A6 to be the frame pointer would be to get an extra register address variable. But I think it's still a win, because if I really need an extra address register I'd be writing in assembler.

Know what else I'd like? With function prototypes, the ability to pass function arguments in registers. But that's a different subject...

amiga/softw.devlpmt #1917, from cheath  
a comment to message 1915

Willy—Prolly your best solution would be to write special binding routines in assembler for the functions you want to call from FORTRAN. That could get a bit sticky if you do much modification (and forget to do a binding and crash and get mad at Jim), but if you have just a few shared routines it oughta work. That assumes, though, that there are no name conflicts between FORTRAN and C library functions...

amiga/softw.devlpmt #1919, from duck  
a comment to message 1913

Graphics and layers use a compiler that has A5 as a frame pointer. However, the C compiler is also modified so that it never uses A6.

I think using A5 as a frame pointer makes sense, but to be strictly compatible you will still need to preserve/restore A6 if it is used.

(continued)

**10 MHz AT COMPATIBLE AMERICAN M/B**

AT Compatible 10MHz computer with 1MB, fixed/floppy disk controller w/cables, 1.2 MB floppy, clock calendar w/battery backup. Performance over 10 on Norton. **\$1795.00**

Above with 20MB fixed drive installed. **\$2184.00**

XT Compatible 8MHz computer with 640KB, 4 layer American M/B, reset switch, floppy disk controller, 2 serial & 1 parallel port, clock calendar w/battery backup, 380 KB floppy drive. Performance 3.0 on Norton w/V20-8. **\$ 895.00**

Above with 20MB fixed drive. **\$1395.00**

Best service and support in the industry — ask our satisfied customers!

Call or write for brochure and price list.

**ADTEK TELECOMMUNICATIONS CORPORATION**  
3706 Realty Road Suite 100  
Dallas, TX 75244 (214) 241-5811

Inquiry 4



**SOFTWARE DEVELOPMENT**

Major software publishing firm with strong national and international marketing capabilities looking for IBM PC based business and accounting software for acquisition or licensing.

Send inquiries to:  
**CMH Software**  
P.O. Box 5526  
Mesa, AZ 85201

Inquiry 97

**VT100 VT220 TEK 4010/14 Emulation from \$89**

GMS emulators turn your PC\* into full-featured DEC Color terminals

True 132 columns. VT100 line graphics  
Softkeys, DOS key  
ASCII and binary file transfer KERMIT  
38400 Baud, ANSI Color  
Fast, Compact (less than 70k). Efficient  
**OPTIONAL 4010/14 GRAPHICS**  
CGA, EGA, Hercules 8300, 3270 support  
Coming soon: TC/IP support, PC4105

Join thousands who have discovered GMS's 4 year record of quality emulation software and support.

**General Micro Systems**  
PO Box 5330  
Minneapolis, MN 55343-1553 USA  
(612) 944-0593

Call for Free Information Package.  
\*Also runs on XT, AT, 3270 PC, jr and compatibles.  
DEC is a trademark of Digital Equipment Corp.

Inquiry 139



# RADICAL

There's never been  
a desktop printer  
like this before.

**The Shape.** Sharp. Sleek. And amazingly adaptable. The Genicom 1000 Series Desktop Printers. Ready for anything from business forms to spreadsheets; word processing to heavy-duty data processing. With letter quality printing at 100 cps. And data processing printing at 200 cps. Open the clamshell casing and look inside. Discover just how simple the future can be.

**The Personality.** IBM<sup>®</sup>, Epson<sup>®</sup>, Diablo<sup>®</sup>—the Genicom 1000 can be all of these printers and more. Because we've built their personalities into plug-in cartridges. Changing personalities is as easy as changing your mind. Simply plug in the personality cartridge of your choice, and your Genicom 1000 is off and running. Working with almost any PC or software program you care to mention. Effortlessly.

Express your personality. With font cartridges that plug right into the front of the printer. Pick your type; you've got hundreds of fonts to choose from. Insert up to three cartridges at once, and vary type styles within the same document.

**The Design.** The Genicom 1000 is the first desktop printer designed with common sense, right down to its built-in printer stand.

The unique design also makes paper loading faster and easier than ever before. Feed tractor paper straight through the bottom. Or from the rear. With Genicom's automatic, zero tear-off bar, no matter how you feed it, you'll never waste a piece of paper again.

When you want to print on letterhead, just feed single sheets of paper, typewriter style. You don't even have to remove the tractor paper.

But the 1000 Series was designed for more than ease of use. It was also designed for performance. Its 18-wire printhead delivers high resolution graphics and word processing printing that can only be called letter quality.

**The Controls.** Easy to adapt. Easy to use. And easy to control. With the Genicom 1000's front panel, total command is at your fingertips. Choose fonts, character spacing, line spacing, form length and print quality with the push of a button. No dipswitches. And no fumbling inside the printer.

**The Track Record.** When it comes to reliability, Genicom stands by its record. We've created a full line of printers: from desktop models to machines that print 800 lines per minute. Our printers have proven their rugged dependability performing for some of the world's largest corporations. Now we're ready to prove it to you.

So stop by your authorized Genicom dealer today and ask for a demonstration of the new

1000 Series; the 1025 and the 1020 for wide column printing. We think you'll agree, these printers are a radical departure from the crowd.

For the Genicom dealer nearest you, call 1-800-437-7468. In Virginia, call 1-703-949-1170.



amiga/softw.devlpmt #1920, from duck  
a comment to message 1916

If you make heavy use of exec calls or graphics calls, you could preload A6 with the vector pointer and get rid of the interface library.

If the compiler itself knows the register calling sequence, maybe by use of the "prototyping" in new standard C, you could generate in-line code to call the library routines.

amiga/softw.devlpmt #1921, from jgoodnow  
a comment to message 1919

If I preserve A6 in the library interface routines, then I might as well use it as the frame pointer. The problem is Aztec C calls Lattice C, which calls Aztec C glue routine. Even if the C functions save A6, so that Lattice C calling Aztec C works, there is still the problem with the glue routines. As pointed out, the problem exists with other languages as well.

amiga/softw.devlpmt #1922, from w.volkægis  
a comment to message 1921

I'd opt for less TStates. . . .

BTW, does the IEEE support include an option for the 68881? I'm surprised at the number of calls we get on the subject.

amiga/softw.devlpmt #1928, from sdb [Scott Ballantyne]  
a comment to message 1913

Jim, having A6 used as the frame pointer would incredibly ease ports from UNIX (PPC) compilers. (It is no fun wading through 3000+ lines of 68K code and dealing with register/frame differences.) In fact, as the compiler is currently set up, it may not be possible to do a port without a complete rewrite (having A4 as a register variable would ease that). I don't know how many others have problems like this, however. On the other hand, for original applications, the current solution seems the best (A5 = frame pointer).

Speaking for myself, and attempting to take advantage of your nice-guy nature, I would love to see yet another switch (yas, indeed) for this. I do think there is more at issue than simply porting code from Amiga C by Lattice and Manx back and forth, or using modules created by one compiler with another.

## ATARI ST

Software seemed to be on the minds of most of the participants in the Atari ST conference this month. The first thread begins as a case of missing memory and evolves into trying to "fool" the GEM graphics mode. The second thread picks up the general topic of graphics, but from a rather different point of view, that of low-level bit manipulation. Accessing BIOS from interrupts, accessing the command line from Modula-2 and making your ST act like a VT52 round out the section.

### MEMORY MAP

atari.st/tech #169, from sprung [Ron Sprunger]

I am trying to use TDI M2 from C-Shell, and some playing around has revealed interesting problems. Dave Beckemeyer sends the C-Shell in two versions, one of which doesn't support GEM programs. Since the TDI compiler and linker are GEM programs, I can't compile or link under that one, but it lets me have about 62K more transient programming area to work with.

The memory is important, because I need a minimum 600K RAM disk to carry all the standard library modules, plus compiler, linker, and

MicroEMACS. If I put the non-GEM C-Shell in AUTO and boot, MDISK tells me it can give me a 702K RAM disk, meaning 298K not available. MDISK is the Michifron RAM disk program. MDISK reserves 128K for TPA, and C-Shell program size is about 67K, leaving 105K unaccounted for, unless C-Shell reserves a bunch.

If I come up on the desktop, MDISK offers me 709K, which seems to be its maximum, even though the docs say 800K. Now GEM programs are supported, and if I go into the GEM C-Shell, MDISK offers only 640K, meaning that the GEM-supporting version of C-Shell seems to need an extra 62K for something.

The reason I mention the details is that if you make yourself too big a RAM disk, then run C-Shell, things seem to be OK, but you are prone to nasty crashes with no error messages.

Now for a (nearly) undocumented feature of C-Shell. The docs on the disk for the non-GEM C-Shell mention that it does not support the "gem" command. The "gem" command is mentioned nowhere else, either in the manual or in the disk docs. Before discovering this, I was running Modula and Linker from C-Shell by simply typing in the program name "modula," etc. I would then come into Modula with a slightly shrunken window and with or without a mouse (by some whim I could not discern). Entering a GEM program without the mouse can mean hangup time if you haven't a valid file on the logged disk, as you can't get to the CANCEL command without a mouse. Anyway, if you want to run a GEM program from C-Shell, type "gem progname" and you're in fine shape.

The MDISK program is not without fault—it requires an extra 15K for each RAM disk it sets up, and it insists on copying any .ACC files plus the desktop.inf file to the created RAM disk, where they haven't the slightest business being.

Can someone tell me where the 90K mentioned above is going?

atari.st/tech #288, from jerryb [Jeremy Brown]  
a comment to message 169

Ron, MDISK copies the .ACC files because you should be using the MDISK in an AUTO folder, where it would copy the files and load them much quicker than from floppy. A better RAM disk is HippoRAMdisk (much better than I hear their C is/was). It allows use in an AUTO folder and accesses a text file where you have the RAM disk size plus a list of all the files you want to automatically copy into the RAM disk. There is a special function to create this file, and you can edit this file later if you wish. In the file copy list, wildcards are supported (as are folders). Whether you can use this special feature from outside an AUTO folder I do not know. I recommend that you look into it. I have also used MDISK and would rather go without. Note: The HippoRAMdisk I am referring to is a post-updated one from before TOS ROMs.

atari.st/tech #289, from sak [Sal Magnone]  
a comment to message 288

Doesn't any program running in the AUTO folder boot into that blasted low-resolution mode? What a bug!

atari.st/tech #291, from sweestrup [Stirling Westrup]  
a comment to message 289

That's right, and I've never found a way around it! If anyone knows how to boot into an AUTO folder program in medium resolution, I want to know about it!

atari.st/tech #292, from jtittsler [Jim Tittsler, Atari Corp.]  
a comment to message 291

The easiest way is to have a program in your AUTO folder ahead of the program you want in medium res that does nothing more than go into medium resolution and then terminate. Remember that programs will

(continued)

# 30 MEGABYTE WARP DRIVE HARD DISK CARD

for your PC, AT or Tandy 1000



PC HARD  
DISK KITS  
20 MEGABYTES  
**\$429**  
30 MEGABYTES  
**\$525**

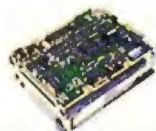

HIGH CAPACITY  
AT & XT  
HARD DISK KITS  
70 MEGABYTES  
**\$1895**  
120 MEGABYTES  
**\$3995**



PORTABLE  
FLOPPY DRIVE  
CAPACITY: 720K  
MF720P **\$295**



TAPE BACKUP  
40 MEG INTERNAL  
MT-40 **\$595**  
40 MEG PORTABLE  
MT-40P **\$695**



TAPE BACKUP  
60 MEG INTERNAL  
MT-60 **\$795**  
60 MEG EXTERNAL  
MT-60E **\$895**



TANDY 1000  
MULTI-FUNCTION  
CARD  
SERIAL PORT/  
DMA CONTRL/  
CLOCK/S12K  
TMF-1 **\$269**



PC/AT OR  
TANDY 1000  
HARD DISK CARD  
21 MEG HARD DISK  
FREE SCSI PORT  
THC-21 **\$675**  
PCHC-21 **\$675**

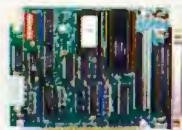

SCSI HOST  
ADAPTER CARD  
CONNECTS YOUR  
PC TO 7 OTHER  
DEVICES  
SCSI-1 **\$190**

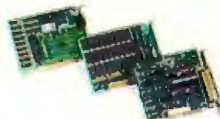

CALL FOR OUR  
FULL LINE OF  
HALF CARDS  
COLOR GRAPHICS  
MEMORY CARD  
FLOPPY  
CONTROLLER  
CALL



LASER BANK  
2000  
2 GIGABYTE  
LASER DRIVE  
CALL

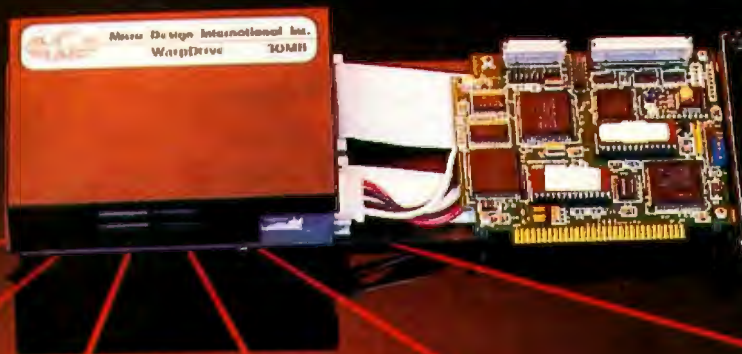

only **\$795**

IBM PC/XT/AT PCWD-30

IMAGINE!!! MDI'S 30 MEGABYTE HARD DISK CARD simply plugs into your system and is ready to run!!!

The Warp Drive works with your existing hard disk drives.

included **FREE**  
with all Hard Drives

Direct/Assist \$49<sup>95</sup>  
R/Assist \$49<sup>95</sup>  
Light Speed \$79<sup>95</sup>

TANDY 1000  
HARD DISK CARD



30 MEG HARD DISK  
TWD-30

IBM IS A REGISTERED TRADEMARK OF INTERNATIONAL BUSINESS MACHINES.

ORDER LINE 800-228-0891  
305-677-8333

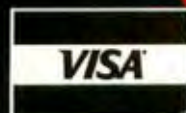

1 YEAR WARRANTY, 30 DAY MONEY BACK GUARANTEE 786

**Micro Design International, Inc.**

6566 University Boulevard, Winter Park, Florida 32792

305-677-8333 telex 332559 MDII ORLUD



# NEW DASH FOR YOU

Your old printer should look so good.

Introducing the ImagEnhancer™ PC add-on board. It enables ordinary monochrome or color dot matrix printers to produce high-quality, plotter-like graphics.

## THE OUTPUT IS OUTSTANDING.

The ImagEnhancer is the perfect way to get presentation-quality graphs, charts and artwork from your old dot matrix printer.

What's more, it comes with a built-in 512K memory. So while your printer is printing one job, you can use your PC for another. Which will improve your productivity tremendously.

And of course, the ImagEnhancer works with the same computer products most everyone works with.

IBM® PCs, XTs, ATs or 100% compatibles with graphics capability. Alps, Epson® or Epson-compatible monochrome or color dot matrix printers. And



The ImagEnhancer PC add-on board brings plotter-like output to dot matrix printers.

Houston Instrument (DM/PL) plotter-compatible software, including Lotus® 1-2-3®, Symphony®, PFS®:Graph and Framework™, among others.

## AND THE PRICE IS RIGHT.

At \$595\*, the ImagEnhancer costs a fraction of what you'd pay for a new plotter. It's simple to install, too. And backed by a one-year warranty.

The ImagEnhancer is a product of Alps America, a U.S. subsidiary of Alps Electric Co., Ltd. of Japan, an International Fortune

## GRAPHICAL Sales

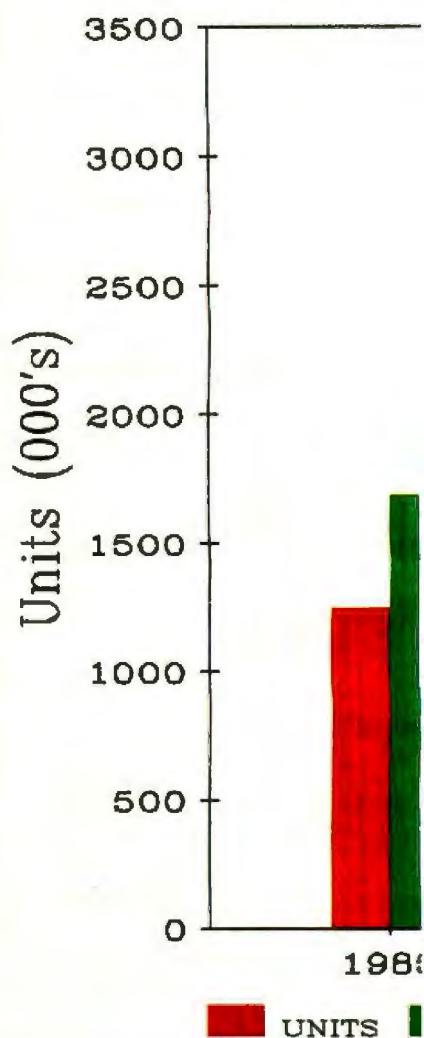

500 company. Other Alps America products include a full line of high-quality printers.

For more information, print samples, or the name of the dealer/distributor nearest you, write to Alps America, 3553 North First Street, San Jose, CA 95134. Or call (800) 828-ALPS. In California, (800) 257-7872. In Canada, (800) 858-2577.

Better yet, send in this coupon along with your payment. And teach your old dot matrix some new tricks.

Inquiry 14 for End-Users. Inquiry 15 for DEALERS ONLY.

# R OLD DOT MATRIX.

## ICS BOARD MARKET

recast - Office/Government

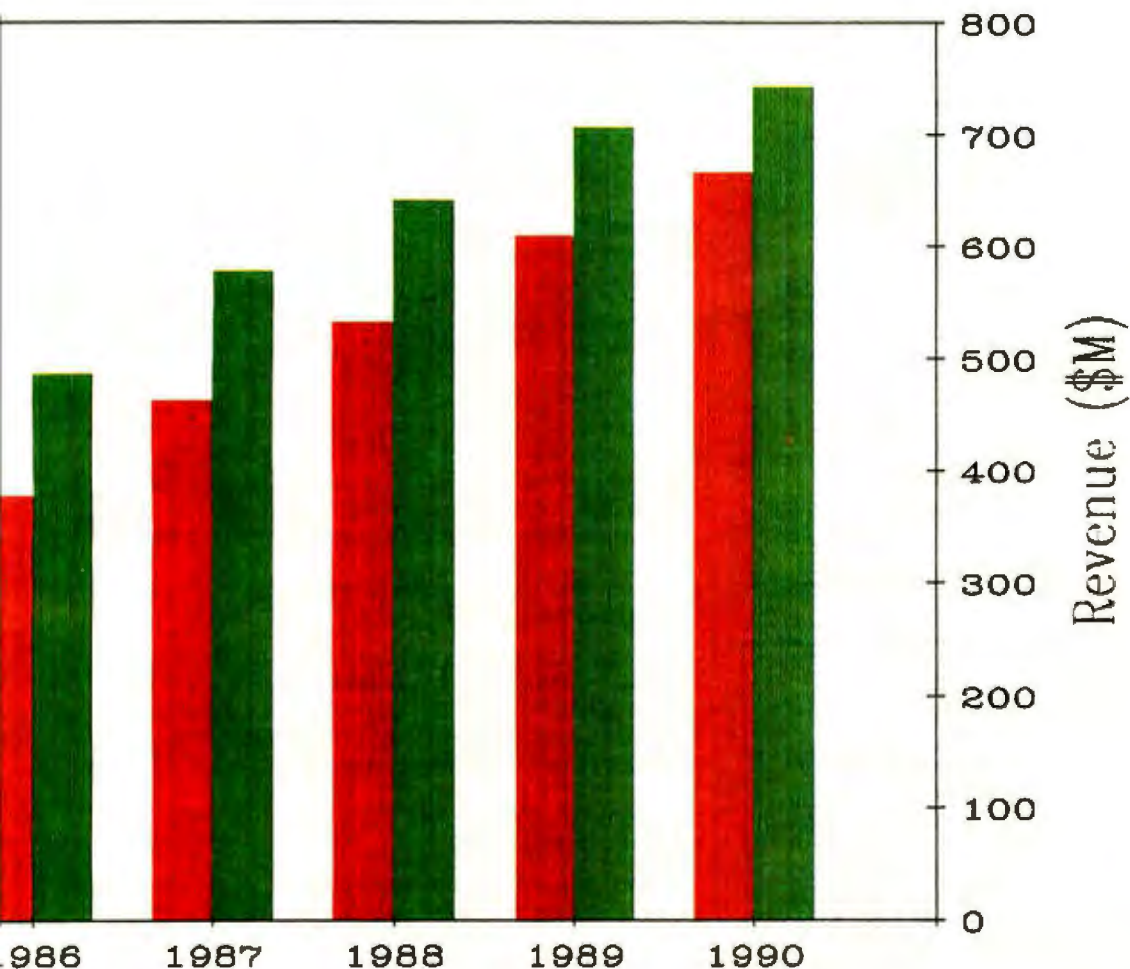

VENUES

Source: Future Computing

*This image was printed with an ordinary color dot matrix printer and the ImagEnhancer PC add-on board. With a monochrome printer, you get the same high resolution in black and white.*

### SO ORDER TODAY.

Name: \_\_\_\_\_

Address: \_\_\_\_\_

City: \_\_\_\_\_

State: \_\_\_\_\_ Zip: \_\_\_\_\_

Phone: \_\_\_\_\_

Send \_\_\_\_\_ ImagEnhancer(s) at \$595 each\*

\*Add \$10.00 shipping and handling for each. California residents add 7% sales tax. Offer available in U.S.A. only.

Method of payment (circle one):

Check Money Order **MASTERCARD** VISA

Card number: \_\_\_\_\_

Exp. date: \_\_\_\_\_

Signature: \_\_\_\_\_

Mail to: Alps America  
3553 North First Street  
San Jose, CA 95134  
Or call (800) 828-ALPS  
In California, (800) 257-7872

**ALPS**  
AMERICA

**NOVAS** BEYOND IBM COMPATIBILITY  
MORE POWER PLUS RELIABILITY

**NOVAS TURBO 286 MOTHERBOARD**

- Fewer ICs For Greater Reliability—Only 36 Compared to IBM's 131
- Dual Speeds—6 & 8 MHz—Keyboard or Jumper Selectable (10 MHz opt.)
- 4 Serial and 1 Parallel Ports On Board Option
- Expandable to 1 Megabyte RAM
- Complete with Setup Program
- Fully Compatible BIOS
- Socket for 80287

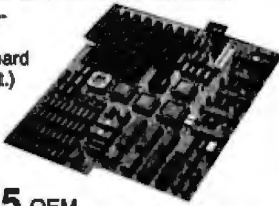

**\$495 OEM**

- 0, 1 Wait State. Jumper Selectable. Hardware reset port.

ALL AT ACCESSORIES AVAILABLE—CALL!

**NOVAS 1000 EGA BOARD**

- Supports EGA, CGA, MDA
- 640 x 350 Pixels EGA
- 640 x 200 Pixels Color
- 320 x 200 Pixels Color
- 720 x 350 Pixels Monochrome
- Parallel Port on Board
- 256K RAM on Board



**\$225**

**NOVAS TURBO 286**

**AT COMPATIBLE SYSTEM . . . \$1445.00**

Include: 640K, 6/8 MHz Turbo Speed (10 MHz opt.), 1 S/1 P, 1.2 Meg. Dr.

COMPLETE NOVAS PC TURBO SYSTEMS AND COMPONENTS IN ANY CONFIGURATION—CALL FOR CURRENT PRICES

OUR QUALITY AND PRICES CANNOT BE BEAT!  
CALL US FOR COMPLETE SATISFACTION

**COMPUTRADE COMPANY**

780 Trimble Road, Suite 605  
San Jose, CA 95131

Tel: (408) 435-2662  
Fax: (408) 435-5458

\* IBM & AT are trademarks of International Business Machines Corp.

**PC/VI**

**Full Screen Editor for MS-DOS (PC-DOS)**

Looking for an Ultra-Powerful Full-Screen editor for your MS-DOS or PC-DOS system? Are you looking for an editor FULLY COMPATIBLE with the UNIX\*VI editor. Are you looking for an editor which not only runs on IBM-PC's and compatibles, but ANY MS-DOS system? Are you looking for an editor which provides power and flexibility for both programming and text editing? If you are, then look no further because PC/VI IS HERE!

The following is only a hint of the power behind PC/VI: English-like syntax in command mode; mnemonic control sequences in visual mode; full undo capability; deletions, changes and cursor positioning on character, word, line, sentence, paragraph or global basis; editing of files larger than available memory; powerful pattern matching capability for searches and substitutions; location marking; joining multiple lines; auto-indentation; word abbreviations and MUCH, MUCH MORE!

The PC/VI editor is available for IBM-PC's and generic MS-DOS based systems for only \$149. For more information call or write:

Custom Software Systems  
P.O. Box 678  
Natick, MA 01760  
617-653-2555

The UNIX community has been using the VI editor for years. Now you can run an implementation of the same editor under MS-DOS. Don't miss out on the power of PC/VI!

\*UNIX is a trademark of AT&T Bell Laboratories.

• BEST OF BIX • **BIX** • BEST OF BIX • BEST

be executed in the same order that low resolution will display them (in COMMAND.TOS). Starting with a new disk/AUTO folder, just copy the medium-res program into the folder first, then the desired program(s).

atari.st/tech #294, from jim\_kent [Jim Kent]  
a comment to message 292

I'm curious about this AUTO folder stuff. Does this mean that if I execute a little program that does a SetScreen((long)-1, (long)-1, 1) and then quits, GEM will be usable with the correct fonts, etc., for later applications programs? I guess the AUTO folder stuff is done before GEM is fully initialized, before the desktop.inf file is read maybe?

This sounds like something perhaps quite useful to many people who need to "trick" GEM a little. Please tell us more!

atari.st/tech #306, from swestrup  
a comment to message 292

Unfortunately, it is *not* possible to create a program that does a set screen call that works from the folder. The reason is simple: The AUTO folder is executed immediately after boot-up. That means that the machine will be in low resolution when it encounters the set screen command. It will note the new resolution to itself and then reboot. While rebooting, it is still in low res and executes the AUTO folder. It makes a note reminding itself to go into medium res and then reboots. If you write a program that cheats by setting the video registers, then there is, as far as I have been able to determine, *no way* to tell GEM that you have changed its resolution and it keeps on using the old fonts, etc.

atari.st/tech #310, from wes.peters [Wes Peters]  
a comment to message 306

Can't you just make your program switch to medium res and then switch back to low res on exit so GEM can do with it what it will? I have a monochrome system so I can't try this out, but can't you just switch modes and then jump through the reset vector stored somewhere in the "biblical" system variables?

atari.st/tech #311, from jim\_kent  
a comment to message 310

Sure, if you don't use GEM inside your program, you can switch it back and forth. I believe you'll have a small problem if there's an I/O error and GEM wants you to cancel/retry, though. Anyway, I switch modes all the time from TOS programs.

**LINE-A ROUTINES**

atari.st/tech #229, from chriskuku [Christoph Kukulies]

I am stuck in a problem due to lack of documentation of the \$1007 (bitblt) (read \$a007). It says in the Line-A document that A6 points to a block of parameters. Maybe someone can give me a layout on these parameter blocks. I wanted to switch the logical screen base with Setscreen(), then draw something hidden with VDI calls, and then perform a vrcopyfm( . . . ) with source\_mfdb and dest\_mfdb set (not equal to zero). vrcopyfm does not work (!), so I turned, like so very often before, to Line-A. Who can help me?

atari.st/tech #232, from jim\_kent  
a comment to message 229

Chris, this is well documented if you have the developer's kit on pages 6 and 7 of the Line-A document. It looks something like:

```
struct blit_block
{
 short b_wd, b_ht;
```

(continued)

# A NEW DIMENSION IN COMPUTER EDUCATION

*"PC TechVideo provides an in-depth overview of the installation of computer components. We use it to train all our technicians and assemblers."*

John Atma, Chief Technician  
for Tech Personal Computers

*"After viewing PC TechVideo, I now understand the basics of how my computer works and was even able to replace the 1.2M drive on my AT at work. PC TechVideo was definitely worth the money."*

Brenda Hudson, Data entry and processor  
for Sark Enterprises

*"PC TechVideo is great. With the help of PC TechVideo, I was able to install a 10MB hard disk on my XT without taking it to an expensive service center."*

Gita Beant, Economics major  
at UC Irvine



**1040 EAST CHAPMAN AVE.  
ORANGE, CALIFORNIA 92666**

**OUTSIDE CALIFORNIA IN CONTINENTAL  
U.S. - PUERTO RICO, HAWAII EX-  
CLUDING ALASKA:**

**1-800-438-8877**

**CALIFORNIA RESIDENTS CALL:  
(714) 771-3560**

**SPECIAL  
INTRODUCTORY  
OFFER  
\$89.95**



**ORDER NOW**

NAME \_\_\_\_\_

ADDRESS \_\_\_\_\_

CITY \_\_\_\_\_ STATE \_\_\_\_\_ ZIP \_\_\_\_\_

PHONE # \_\_\_\_\_

PLEASE RUSH \_\_\_\_\_ COPIES OF  
PC TECHVIDEO IN

VHS  BETA FORMAT

VISA  MASTERCARD  C.O.D.

CHECK/MONEY ORDER ENCLOSED

ADD \$3.50 SHIPPING.

CALIFORNIA RESIDENTS ADD 6% SALES TAX.

PC TechVideo is an innovative set of two 2-hour instructional video tapes which form a complete guide to the IBM® and compatible personal computer systems. Designed for everyone, from the complete novice to the software expert. PC TechVideo provides the viewer invaluable first hand instruction in the installation and maintenance for IBM® and compatible systems.

Part I of PC TechVideo is a complete and comprehensive presentation of prominent features of the PC family including:

Motherboard architecture

Memory Configuration and Addressing  
Monitor Technology  
Floppy and Fixed Disk Technology  
Bus Architecture  
Serial and Parallel Ports

Part II of PC TechVideo shows the details involved in actually installing, configuring, and replacing:

Motherboards  
Power Supplies  
Floppy and Fixed Disks  
Drive Controllers  
Popular Expansion Boards

PC TechVideo provides instruction not found in books or magazines. It is an essential tool for anyone interested in understanding their PC. You can't afford not to have PC TechVideo.

```

short plane_ct;
short fg_color, bg_color;
char op_tab[4];
short s_xmin, s_ymin;
short *s_form; /*pointer to the source pixels */
short s_nxwd, s_nxln, s_nxpl; /*offsets to next word, line, plane */
short d_xmin, d_ymin;
short *dform;
short d_nxwd, d_nxln, d_nxpl;
short *p_addr; /* == NULL for no pattern */
short p_nxln, p_nxpl;
short p_msk;
char pad[24];
}

```

The op\_tab is one of the more cryptic bits of raster logic I've seen. It works with the fg\_color and bg\_color. If you tell me more specifically what you want to do, maybe I can tell you the color/op combinations to try.

atari.st/tech #234, from alexl. [Alex Leavens]  
a comment to message 229

Check over in the GEM conference for commented C source code on using the bit-bit routines from C. The parameter blocks are identical to what you need for the Line-A stuff. The files in question are in gem/listings.st and are CRABSC and MULTBALL.C.

atari.st/tech #296, from chriskuku

Now I'm at the point where I need to know more on the op\_tab[] parameters. Where can I get this Line-A Document (which is obviously more detailed than where my information came from)?

atari.st/tech #299, from jim\_kent  
a comment to message 296

Try making the op\_tab = {4, 4, 7, 7}, fg\_color = color, bg\_color = anything, and s\_nxpl = 0. This will take a single plane source to the dest, making the dest color where there are ones in the source plane, and leaving the dest alone elsewhere.

However, the opcolor combination stuff is probably better described

in the GEM VDI manual (chapter 6) than in the Line-A bit.

I got what documentation I have from Atari. \$300 for the developer's kit... the dread Aicyon compiler, etc., and some documentation.

atari.st/tech #303, from chriskuku  
a comment to message 299

Thank you, Jim, for the quick answer. However, I still require additional information on the meaning of the op\_tab. It seems that the raster-op table in the GEM VDI manual does not correspond to the bit combinations I found. Could you or alexl. be so kind as to send me the necessary information to make bit-block transfers "by hand," that is, any source, any destination, any mode, preferably for monochrome but color wouldn't do any harm. Until I get the Line-A document from Atari you are my only hope.

Another point: What are the xmins, ymins for... clipping?

atari.st/tech #304, from jim\_kent  
a comment to message 303

Indeed, the xmins, ymins are for clipping. Not many things are clipped by it, though. Rectangular area fills are affected.

OK, OK, here's some more stuff on the op\_tab:

- op\_tab[0]—logic employed when foreground and background colors for current plane are both 0.
- op\_tab[1]—when current plane fg\_color bit is 0 and bg is 1.
- op\_tab[2]—when fg is 1 and bg 0.
- op\_tab[3]—when fg is 1 and bg is 1.

Now for the logic...

- 0 D' = 0
- 1 D' = S AND D
- 2 D' = S AND [NOT D]
- 3 D' = S /\*just a plain copy \*/
- 4 D' = [NOT S] AND D
- 5 D' = D /\*kind of futile waste of time normally \*/
- 6 D' = S XOR D
- 7 D' = S OR D
- 8 D' = NOT [S or D]
- 9 D' = NOT [S XOR D]

### 2 Mb EMS RAM / CLOCK FOR IBM PC/XT and COMPATIBLES WITH LIFETIME WARRANTY



**\$199.00 WITH 84K OF RAM**

The Apparat 2 Mb Expanded Memory/Calendar Board allows you the option of using your system memory to the maximum 84K and/or using up to 2 Mb RAM for expanded memory. The expanded memory manager Software, which is provided as separate unit on the Line-A/Atari's Expanded Memory Specification. The clock/calendar board allows you to automatically schedule the date and time on each system power-up.

**ADDITIONAL PRODUCTS —**

- CLOCK/CALENDAR CARD
- PROM B/MASTER (24 or 28 pin)
- COMBO II CARD
- 256K RAM CARD
- 512K RAM CARD
- EXTERNAL HARD DISK
- INTERNAL HARD DISK
- XT HARD DISK UPGRADE
- SHORT S/OT PAR/ISER/CARD FOR PPC AT
- 384K RAM CARD FOR PPC
- 400-DR DISK DRIVES
- AT RAM CARD
- AT COMBO CARD
- CABLES

**Apparat, Inc.**  
4601 South Tamarac Parkway — Denver, Colorado 80237  
(303) 741-1778 — TOLL FREE 800/538-7874

Inquiry 233

### Lean & Mean!

#### Solepak ST Print Spooler/Ram Disk

NOW with the "Solepak ST" print spooler you can:

- print up to 8 files with separate printing qualities at one time.
- configure to any parallel printer with 32 user definable options.
- format your output, vary the print speed, pause/restart printing and much, much more...

The "Solepak ST" ram disk lets you:

- configure up to 1 Mb and 128 files.
- save time with a disk transfer rate of over 10 million bits/second.

"Solepak ST" is the fastest, most versatile and memory efficient professional print spooler and ram disk available for the ATARI ST. FREE CRT sever to help prevent image "bum-in". "Solepak ST" demo at your ST retailer or on BBS's nationwide.

**\$39.95**

**Action Software** - 89 Clementina St., San Francisco, CA 94105 - (415) 974-6638  
Mail orders: please include \$3.00 P&H and Ca. residents add \$2.60 sales tax. VISA, MC OK.

Inquiry 407

### OC8000



**EXPANDS PC PERFORMANCE AT A FRACTION OF NETWORKING COST**

- Adds four to eight serial communication ports to IBM PC, XT, AT or compatibles.
- Standard RS-232 or optional RS-422 ports for increased transmission speed and distance.
- Supported by Xenix, Multi-Link, RTCS, QNX, and other multi-user, multi-tasking operating systems.

**STAR GATE TECHNOLOGIES, INC.**  
Suite 109  
33800 Curtis Blvd. • Eastlake, OH 44094  
Call: (216) 951-3922

Inquiry 328



10 D' = NOT D  
 11 D' = S OR [NOT D]  
 12 D' = NOT S  
 13 D' = [NOT S] OR D  
 14 D' = NOT [S and D]  
 15 D' = 1

So this is the official stuff, but what does it mean? Another example: If you want the (new) destination to be a copy of the source, set  
 op\_tab[0] = op\_tab[1] = op\_tab[2] = op\_tab[3] = 3 bg\_color  
 = fg\_color = anything.

#### USING BIOS FROM INTERRUPTS

atari.st/tech #266, from rchecketts [Rick Checketts]

Has anyone tried calling the Atari ST BIOS from an interrupt routine? I was trying to use the serial I/O routines from within an interrupt, saving registers and using a private stack space, etc., and while the program ran for a while, it bombed for no apparent reason. Any ideas?

atari.st/tech #269, from davjon [David Jones]  
 a comment to message 266

I don't know if this is any help, but I was having similar problems—I was calling some of the sound-oriented BIOS calls in an interrupt routine and kept getting lots of bombs after a while of correct operation. I solved the problem by disabling all interrupts at the start of the routine and enabling them again afterwards. My best guess is that the BIOS re-entrancy rule (no more than 9 levels, I believe) is being violated or something.

atari.st/tech #271, from jim\_kent  
 a comment to message 269

No more than 3 levels of re-entrancy, I believe.

atari.st/tech #273, from sak  
 a comment to message 271

Plus, aren't there 3 or 4 routines that cannot be called during system processing at all? I don't have the guide handy, but I do remember something about using the printer during a BIOS interrupt. (Excuse me, TRAP! Old habits die hard.)

atari.st/tech #278, from rchecketts  
 a comment to message 273

The guide does say something about the printer but my routines didn't try talking to the printer. I did try blocking interrupts, and while this had some effect, it did not cure the problem. I did notice that the crash usually occurred during evtnt\_multi, so I tried flagging that evtnt\_multi was active and skipping the interrupt routine and again this helped; that is, the program ran a bit longer and then bombed. I've worked around it for now by leaving the interrupt just doing timing, etc., and leaving the rest to a fake interrupt that's just called as often as possible. Not an ideal solution. I'd still like to do it right!

atari.st/tech #279, from jtitstler  
 a comment to message 278

Here are some notes on using a BIOS function within an interrupt handler:

#### Nested Traps and Interrupts

Occasionally it may be necessary to make "nested" BIOS calls (for instance, to get keyboard input from a critical-error handler). The BIOS is re-entrant to three levels; the total number of standard and extended BIOS calls may not exceed three. Exceeding this limit will cause the

(continued)

## FORTRAN PROGRAMMERS

Looking for the right PC FORTRAN LANGUAGE SYSTEM? If you're serious about your FORTRAN programming then you should be using F77L- LAHEY FORTRAN.

### Editor's Choice - PC Magazine

- Full FORTRAN 77 Standard [F77L is not a subset]
- Popular Extensions for easy porting of minicomputer and mainframe applications
- COMPLEX\*16, LOGICAL\*1 and INTEGER\*2
- Recursion - allocates local variables on the stack
- IEEE - Standard Floating Point Arithmetic
- IMPLICIT NONE
- Long variable names - 31 characters
- Fast Compile - Increase your productivity
- Source on Line Debugger [Advanced features without recompiling]
- Arrays and Common Blocks greater than 64K
- Clear and Precise English Diagnostics
- Compatibility with Popular 3rd Party Software [i.e. Lattice C]
- Easy to use manual
- Technical Support from LCS

• NEW FEATURE - NAMELIST

## F77L - THE PROGRAMMER'S FORTRAN \$477.00 U.S.

System Requirements: MS-DOS or PC-DOS, 256K, math coprocessor (8087/80287)

FOR MORE INFORMATION: (702) 831-2500



Lahey Computer Systems Inc.

P.O. Box 6091 Incline Village, NV 89450/USA

International Dealers:

|                                 |                    |
|---------------------------------|--------------------|
| England: Grey Matter Ltd.,      | Tel: (0364) 53499  |
| Denmark: Ravenholm Computing,   | Tel: (02) 887249   |
| Australia: Computer Transitions | Tel: (03) 537-2786 |
| Japan: Microsoft, Inc.,         | Tel: (03) 813-8222 |

SERVING THE FORTRAN COMMUNITY SINCE 1967

## BYTE back issues for sale

|       | 1985   | 1986   |
|-------|--------|--------|
| Jan   | \$4.25 | \$4.25 |
| Feb.  | \$4.25 | \$4.25 |
| March | \$4.25 | \$4.25 |
| April | \$4.25 | \$4.25 |
| May   | \$4.25 |        |
| June  | \$4.25 | \$4.25 |
| July  |        | \$4.25 |
| Aug   | \$4.25 | \$4.25 |
| Sept. | \$4.25 |        |
| Oct.  | \$4.25 |        |
| Nov.  | \$4.25 |        |
| Dec.  | \$4.25 |        |

### SPECIAL ISSUES and INDEX

BYTE '83-'84 INDEX \$1.75

1984 Special Guide to IBM PCs [Vol. 9, No. 9] \$4.75

1985 INSIDE THE IBM PCs [Vol. 10, No. 11] \$4.75

Circle and send requests with payments to:

BYTE Back Issues

P.O. Box 328

Hancock, NH 03449

Check enclosed

Payments from foreign countries must be made in US funds payable at a US bank.

VISA  MasterCard

Card # \_\_\_\_\_

Exp. \_\_\_\_\_

Signature \_\_\_\_\_

The above prices include postage in the US. Please add \$.50 per copy for Canada and Mexico; and \$2.00 per copy to foreign countries [surface delivery]. Please allow 4 weeks for domestic delivery and 12 weeks for foreign delivery.

Name \_\_\_\_\_

Address \_\_\_\_\_

City \_\_\_\_\_ State \_\_\_\_\_ Zip \_\_\_\_\_

system to crash.

It is possible to call the BIOS from an interrupt routine. The basic problem is to get around a non-atomicity bug in the BIOS trap handler. Before the interrupt routine can call the BIOS, it must decrement the system variable "savptr" (\$4a2 long) by 46; after the trap, "savptr" must be restored to its original value. The interrupt code is responsible for its own mutual exclusion. This interrupt "level" does not count as one of the three nested BIOS calls.

Applications should not attempt disk or printer I/O from critical-error or interrupt handlers.

#### COMMAND LINE

atari.st/questions #205, from sprung

Can someone give me a quick rundown on the command line? I need to pick it up from Modula. Where is it and what's the format? It must be in these docs somewhere.

atari.st/questions #222, from alexl.

a comment to message 205

Ron, the command line is a simple little thing that sort of allows you to do MS-DOS-like things (like passing parameters to a program). Don't bother with it. Buy Beckemeyer's C-Shell.

atari.st/questions #223, from sprung

a comment to message 222

Thanks Alex—I know *what* the command line is. I need it for my own utilities in M2. I have C-Shell, and I talked with David Beckemeyer about the command line, but he didn't know how I could get it either. All I really need is a simple way to pick up the base page address at run time.

According to the review in May "Antic," Personal Pascal provides the command line, but no sign of it in M2.

atari.st/questions #224, from jtittsler

a comment to message 223

Well, I don't know how to do it from M2, but when a program is invoked, a pointer to the base page of that program is available under the long on the top of the stack. In code (which is a bit easier for me to deal with than English):

```
start: move 4(a7),a0 * a0 now points to the base page
 move.l a0,___base * put the pointer in the C
 * external
```

It is quite possible that the M2 run-time library does something similar.

atari.st/questions #225, from sprung

a comment to message 224

"under the long . . ."—What exactly is in A7? And what does the 4 do to that number? I can pick up the A7 register (or any other), but I'm not clear on how to make that into the base page address.

atari.st/questions #226, from cheath [Charlie Heath]

a comment to message 225

```
move.l 4(a7),___base
```

will take the address that was the last thing put on the stack into "\_\_\_base," which you can reference within the language (assuming M2 has the same underscore convention as C).

atari.st/questions #227, from sak

a comment to message 226

Yeah, but isn't that assuming the M2 run-time library hasn't used the stack already?

atari.st/questions #228, from sprung

a comment to message 227

That seems to be the case—I've been playing around with it and have managed to pick up and reference the address off the stack, but it does not contain the base page address by the time I get it. Sigh. I'll have to pursue it with TDI. Thanks, guys.

atari.st/questions #229, from jtittsler

a comment to message 225

A7 is the stack pointer. It is a very reasonable thing for the run-time library to squirrel away that pointer before it does anything else. For example, in the developer's C compiler that I use, that function is the first thing done in the startup module (GEMS, GEMSTART, MYGEMS, etc.).

#### SCREEN ESCAPE CODES

atari.st/questions #236, from sprung

Can someone tell me where, in the DevPak or elsewhere, to find all the screen and cursor control sequences for the monochrome monitor? Or exactly what it emulates, as I have the VDT book by Stephens. If VT52, my book lacks cursor on and off (which I got from Steve Tether's code) and reverse video.

atari.st/questions #237, from alexl.

a comment to message 236

The screen codes are in the "Hitchhiker's Guide to the BIOS."

atari.st/questions #239, from jruley [Jonathan Ruley]

a comment to message 236

Get the abacus "internals" book—it has a pretty good rundown. The emulation is incomplete VT52.

atari.st/questions #243, from jtittsler

a comment to message 236

The screen escape codes are an (improper) superset of those in the VT52, with a few additions from the H/Z-19 (and a couple more that provide similar functions but are accessible in a 2-character sequence instead of 3). Specifically, for the ones you asked about:

```
ESC e Enable cursor
ESC f Disable cursor
ESC p Enter reverse-video mode
ESC q Exit reverse-video mode
```

Also, someone was asking about wrap/nowrap:

```
ESC v Wrap at end of line
ESC w Discard at end of line
```

One shortcut to erase home is

```
ESC e Clear screen and home cursor (same as ESC h ESC j)
```

## IBM PC AND COMPATIBLES

The majority of this month's IBM PC section is taken up with an involved exploration for the answer to a seemingly simple question. A query concerning a single interrupt provokes lengthy discussion culminating in the dissection of PRINT. In addition to being informative from a systems point of view, this example shows the real nature of on-line conferencing, which allows running discussion without constraints of time or location. This central discussion is bracketed by a short thread on interfacing an Apple color monitor with a PC compatible, and

a more involved thread on the intricacies of calling C language subroutines from inside a BASIC program.

**APPLE MONITOR TO PC CONNECTION**  
 ibm.pc.hardware #806, from rjackson [Robert Jackson]

I have an interesting project that no one around here can help me with. I have an Apple RGB Color Monitor 100 that I would like to hook up to my Z-150 (IBM compatible). My first problem is that I can't find anyone who can tell me if it will work in the first place, much less help me build the necessary cable. If anyone can help, I would appreciate it. I use both computers every day and really miss the color on my Zenith.

ibm.pc.hardware #807, from dmick [Dan Mick]  
 a comment to message 806

Do you have docs on IBM-compatible video output (or Zenith's docs for their board; same thing) and docs on the input connector for the Apple monitor? There are so few signal lines that it seems from examining these docs you could glean what you need, even if you're not an EE.

ibm.pc.hardware #808, from barryn [Barry Nance]  
 a comment to message 806

I haven't the slightest idea of what the connector for the Apple RGB monitor looks like, but here's what the TTL output of a standard IBM Color Graphics Adapter looks like:

|             |                            |   |                |
|-------------|----------------------------|---|----------------|
|             | <----- Ground ----->       | 1 |                |
|             | <----- Ground ----->       | 2 |                |
| TTL Adapter | <----- Red ----->          | 3 | Color Graphics |
| RGBI        | <----- Green ----->        | 4 | RGB Output     |
| Monitor     | <----- Blue ----->         | 5 | 9-Pin D-Shell  |
|             | <----- Intensity ----->    | 6 | Connector      |
|             | <----- Reserved ----->     | 7 |                |
|             | <----- Horiz. Drive -----> | 8 |                |
|             | <----- Vert. Drive ----->  | 9 |                |

ibm.pc.hardware #809, from rjackson  
 a comment to message 808

Thanks for the IBM pinouts. I now have two problems. First, I can't get anyone to tell me for sure if the monitor (frequency- and scan-rate-wise) will really work on an IBM. Second, Apple wasn't kind enough to supply the pinouts for their monitor. That shouldn't be too hard to get, considering the available technical information on the Apple II. If anyone knows whether or not the Apple RGB monitor will work, I'd really appreciate a yea or nay.

ibm.pc.hardware #817, from mfg [Marc Greenfield]  
 a comment to message 809

I have converted an Acorn color monitor to work on my IBM by simply attaching a DIN-9 connector to the circular plug that would normally have attached to an Apple. I think that based on this your monitor should work on your IBM, that is, unless it is a special brand that may work with a special controller. If the pin configuration matches that listed in one of the comments above, then it should work OK.

**INTERRUPT 28H**  
 ibm.pc/software #999, from jcummins [John Cummins]

Anyone know what INT 0x28 does?

ibm.pc/software #1002, from jrobie [Jonathan Robie]  
 a comment to message 999

It isn't used by BIOS, according to my IBM PC Tech Ref manual.

(continued)

# Computers For The Blind

Talking computers give blind and visually impaired people access to electronic information. The question is how and how much?

The answers can be found in "The Second Beginner's Guide to Personal Computers for the Blind and Visually Impaired" published by the National Braille Press. This comprehensive book contains a Buyer's Guide to talking microcomputers and large print display processors. More importantly it includes reviews, written by blind users, of software that works with speech.

Send orders to:

**National Braille Press Inc.,**  
 88 St. Stephen Street, Boston, MA 02115  
 (617) 266-6160

*NBP is a nonprofit braille printing and publishing house.*

## Subscription Problems?

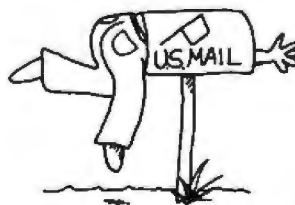

### We want to help!

*If you have a problem with your BYTE subscription, write us with the details. We'll do our best to set it right. But we must have the name, address, and zip of the subscription (new and old address, if it's a change of address). If the problem involves a payment, be sure to include copies of the credit card statement, or front and back of cancelled checks. Include a "business hours" phone number if possible.*

**BYTE**  
 Subscriber Service  
 P.O. Box 328  
 Hancock, NH 03449



# Join **BYTE**: The Book Club for the **Computer Professional**

**PRACTITIONER'S GUIDE TO ADA.** By R. Wallace. 320 pp., 60 illus. This much-needed one-stop info source covers all aspects of ADA, the language, the environments, policies and standards, design strategies, products and vendors! Plus, its unique handbook format provides a concise roadmap that guides you through all the many aspects of this complicated field.  
679/223B \$38.95  
(Counts as 2 of your 3 books)

**SOFTWARE ENGINEERING HANDBOOK.** By the Staff of General Electric Company. 224 pp., 114 illus., outsized 8½ x 11 format. Proven-in-practice methods for tracking, controlling, and reporting each item produced as a part of the software development process are described and demonstrated. Review procedures are covered in detail. A recommended format for the system specification document is also included.  
231/656A \$59.50  
(Counts as 3 of your 3 books)

**HANDBOOK OF SOFTWARE ENGINEERING.** Edited by C. Vick and C. Ramamoorthy. 683 pp., 332 illus. and tables. Emphasizing quality assurance, this first-ever guide shows you how to design, implement, test and maintain virtually any type of software. Ranging from graphic theoretic modeling to software development you see how to apply the latest software engineering techniques in each stage of development.  
583204-6A \$62.50  
(Counts as 3 of your 3 books)

**SINGLE-CHIP MICROCOMPUTERS.** Edited by P. Lister. 231 pp., 102 illus., 25 tables. Comprehensive coverage of the single-chip micros now available, their characteristics and application range. Separate chapters cover Motorola's M6801 & M6805 families, TI's TMS 1000 & TMS 7000 devices, Zilog's Z80, National Semiconductors COPS 400 and Mostek's 16-bit MK 682000.  
380/309B \$39.50  
(Counts as 2 of your 3 books)

**SYSTEM DESIGN FROM PROVABLY CORRECT CONSTRUCTS.** By J. Martin. 392 pp., 155 two-color illus. Covers "Higher Order Software," the breakthrough in system development that translates & refines human thinking until program codes generate automatically.  
583259-3B \$37.50  
(Counts as 2 of your 3 books)

**SOFTWARE PORTABILITY.** By O. Lecarme and M. Pellissier-Gart. 256 pp., 40 illus. A comprehensive guide that provides in-depth, illustrated coverage of all the tools and techniques used to develop portable programs or to transport existing software to other environments. Actual case studies are used to show how these techniques can work for you.  
369/488B \$29.95  
(Counts as 2 of your 3 books)

**ENCYCLOPEDIA OF ELECTRONICS.** Edited by S. Gibilisco. 983 pp., more than 1,300 illus., outsized 8½ x 11 format. From basic electronics terms, amateur radio and microcomputer technology to state-of-the-art digital electronic applications, this massive reference provides practical information on each topic. Contains more than 3,000 alphabetically arranged articles.  
583348-4A \$60.00  
(Counts as 3 of your 3 books)

**COMPARING AND ASSESSING PROGRAMMING LANGUAGES: ADA • C • Pascal.** Edited by A. Feurer and N. Behani. 271 pp., softbound. Enhances your understanding of these languages by comparing their strengths and weaknesses. Contrasts and assesses each so you can choose the best for your application.  
583262-3 \$16.95

Get the competitive edge with the *newest* and the *best* information in your field . . . with books from all the leading publishers.

**STANDARD HANDBOOK OF ENGINEERING CALCULATIONS, 2/e.** Edited by T. G. Hicks. 1,468 pp., 1,292 illus., tables. Now revised, updated, and considerably expanded, this huge handbook provides more than 5,100 step-by-step procedures to solve the kinds of engineering problems you encounter most frequently in your work. USCS and SI are used throughout.  
287/35XA \$59.50  
(Counts as 3 of your 3 books)

**SUCCESSFUL DATA PROCESSING SYSTEM ANALYSIS, 2/e.** By T. Gildersleeve. 369 pp., 117 illus. This completely revised, updated and expanded guide covers the whole process of system analysis. In clear, professional language it covers identifying the problem and developing a cost-benefit analysis to testing the system for acceptability.  
583311-5B \$30.95  
(Counts as 2 of your 3 books)

**PROGRAMMABLE CONTROLLER HANDBOOK.** By R. Wilhelm, Jr. 718 pp., 341 illus. First comprehensive reference on these special-purpose computers that are now the standard solution to most industrial control applications. Special attention is given to the many functions and operations not possible to perform with industrial control relays.  
583244-5B \$49.95  
(Counts as 2 of your 3 books)

**DATA COMMUNICATIONS, NETWORKS AND SYSTEMS.** T. Bartee, Editor-in-Chief. 359 pp., 196 illus. Brings you up-to-date pm digital system design. Shows how they operate and the trade-offs they entail. Covers basic system approaches, network security, error control techniques and common carrier regulations.  
583276-3B \$39.95  
(Counts as 2 of your 3 books)

**DATA STRUCTURES FOR PERSONAL COMPUTERS.** By Y. Langsam, M. Augenstein and A. Tenenbaum. 560 pp., 116 illus. Gives you a solid grounding in high-level programming techniques by combining the elementary concepts of data structures with guidance on structured programming in BASIC.  
583186-4B \$29.95  
(Counts as 2 of your 3 books)

**PROGRAMMING ASSEMBLER LANGUAGE.** By P. Abel. 2nd Ed., 581 pp., 154 illus. and listings. Updated and expanded this carefully detailed study of the 370 mainframe and Assembler covers the essentials of Assembler coding, binary operations, and external storage. Also discusses debugging, floating point operations, macro writing and operating systems.  
583088-4B \$26.95  
(Counts as 2 of your 3 books)

**MULTIPLE PROCESSOR SYSTEMS FOR REAL-TIME APPLICATIONS.** By B. Liebowitz and J. Carson. 383 pp., 150 illus. This definitive guide for the practicing professional covers each of the MPS's major building components, design tools and techniques and implementation methodology. Case histories from both government and industry are included.  
583237-2B \$39.95  
(Counts as 2 of your 3 books)

**New Members  
TAKE ANY 3 BOOKS  
FOR ONLY \$1.00 EACH\***  
Values up to \$89.00

**FROM FLOWCHART TO PROGRAM.** By R. G. Todd  
583600-9 \$19.95

**HOW TO BE A SUCCESSFUL COMPUTER CONSULTANT.**  
By A. Simon  
572/968 \$16.95

**THE THEORY & PRACTICE OF COMPILER WRITING.** By J. Tremblay & P. Sorenson  
651/612B \$43.95  
(Counts as 2 of your 3 books)

**INTRODUCING PC-DOS & MS-DOS.** By T. Sheldon  
565/597 \$18.95

**68,000 MICROPROCESSOR.**  
By W. Triebel & A. Singh  
583613-0B \$34.95  
(Counts as 2 of your 3 books)

**PROGRAMMING WITH TURBO PASCAL.** By D. Carroll  
852908-5B \$34.95  
(Counts as 2 of your 3 books)

**COMPUTER ARCHITECTURE, 3/e.** By C. Foster & T. Iberall  
583278-XB \$38.95  
(Counts as 2 of your 3 books)

**MICROPROCESSOR SYSTEM DESIGN CONCEPTS.** By N. Alexandridis  
583313-1B \$32.95  
(Counts as 2 of your 3 books)

**THE ENCYCLOPEDIA OF ELECTRONIC CIRCUITS.** By R. F. Graf  
583265-8A \$50.00  
(Counts as 3 of your 3 books)

**DESIGN AND ANALYSIS OF DISTRIBUTED REAL-TIME SYSTEMS** By P. J. Fortier  
216/193B \$39.95  
(Counts as 2 of your 3 books)

**THE ADA PRIMER** By P. I. Johnson  
326/266 \$16.95

**ELECTRONICS: CIRCUITS & SYSTEMS.** By S. Madhu  
583292-5B \$39.95  
(Counts as 2 of your 3 books)

**FUNDAMENTALS OF PROGRAMMING LANGUAGES, 2/e.** By E. Horowitz  
583303-4B \$29.95  
(Counts as 2 of your 3 books)

**DATABASE DESIGN, 2/e.** By G. Weiderhold  
701/326B \$41.95  
(Counts as 2 of your 3 books)

**THE MASTER HANDBOOK OF HIGH-LEVEL MICROCOMPUTER LANGUAGES.** By C. Taylor  
583096-5 \$21.95



\* 3 books for only \$1.00 each . . . if you join now for a trial period and agree to purchase three more books—at handsome discounts—during your first year of membership. (Publishers' prices shown)

**VIDEOTEX/TELETEXT.** By A. Alber  
009/570B \$39.50  
(Counts as 2 of your 3 books)

**CICS Made Easy.** By J. J. LeBert  
369/720B \$29.95  
(Counts as 2 of your 3 books)

**COMPUTER PERIPHERALS FOR MINICOMPUTERS, MICROPROCESSORS, AND PERSONAL COMPUTERS.** By C. L. Hohenstein  
294/518B \$39.50  
(Counts as 2 of your 3 books)

**THE HANDBOOK OF COMPUTERS AND COMPUTING.** By A. Seidman and I. Flores  
583138-4A \$77.50  
(Counts as 3 of your 3 books)

**REAL-TIME COMPUTING: With Applications to Data Acquisition and Control.** Edited by D. A. Mellichamp  
582844-8B \$44.50  
(Counts as 2 of your 3 books)

**ASSEMBLERS, COMPILERS, AND PROGRAM TRANSLATION.** By P. Calingaert  
582110-9B \$27.95  
(Counts as 2 of your 3 books)

**PASCAL FOR PROGRAMMERS.** By O. LeCarme & J. Nebut  
369/585B \$25.00  
(Counts as 2 of your 3 books)

**ADVANCED C. PROGRAMMING.** By The Waite Group  
583618-1 \$21.95

## More Books to Choose from

**LEARNING WITH LOGO.**  
By D. H. Watt  
685/703 \$22.95

**MICROCOMPUTER AND MICROPROCESSOR INTERFACING.** By J. C. Cluley  
582585-6B \$27.50  
(Counts as 2 of your 3 books)

**MICROPROCESSOR AND MICROCOMPUTER DATA DIGEST.** By W. H. Buchsbaum & G. Weissenberg  
582835-9B \$29.95  
(Counts as 2 of your 3 books)

**MICROPROCESSOR DATA BOOK.** By S. A. Money  
427/062B \$35.00  
(Counts as 2 of your 3 books)

**BUILD YOUR OWN Z-80 COMPUTER.** By S. Ciarcia  
109/621 \$22.85

**MICROCOMPUTER INTERFACING.** By B. Artwick  
789/436B \$28.00  
(Counts as 2 of your 3 books)

**PRINCIPLES OF INTERACTIVE COMPUTER GRAPHICS, 2/e.** By W. M. Newman & R. Sproull  
463/387B \$45.95  
(Counts as 2 of your 3 books)

**MICROCOMPUTER OPERATING SYSTEMS.** By M. Dahmke  
150/710 \$18.95

**ELECTRONIC ENGINEERS' HANDBOOK, 2/e.** By D. G. Fink & D. Christiansen  
209/812A \$89.00  
(Counts as 3 of your 3 books)

**Z80 USERS MANUAL.** By J. Carr  
582336-5 \$16.95

**INTRODUCING THE UNIX SYSTEM.** By H. McGilton & R. Morgan  
450/013 \$24.95

**HANDS-ON BASIC For the IBM® Personal Computer.** By H. Peckham  
491/78X \$24.95

## Why YOU should join the Byte Book Club™ now!

- **Best and newest books from ALL publishers!** Books are selected from a wide range of publishers by expert editors and consultants to give you continuing access to the best and latest books in your field.
- **Big Savings!** Build your library and save money too! Savings range up to 40% or more off publishers' list prices—usually 20% to 30%.
- **Bonus books!** You will immediately begin to participate in our Bonus Book Plan that allows you savings up to 70% off the publishers' prices of many professional and general interest books!
- **Convenience!** 14-16 times a year (about once every 3-4 weeks) you receive the Club Bulletin FREE. It fully describes the Main Selection

and alternate selections. A dated Reply Card is included. If you want the Main Selection, you simply do nothing—it will be shipped automatically. If you want an alternate selection—or no book at all—you simply indicate it on the Reply Card and return it by the date specified. You will have at least 10 days to decide. If, because of late delivery of the Bulletin you receive a Main Selection you do not want, you may return it for credit at the Club's expense.

As a Club member you agree only to the purchase of three additional books during your first year of membership. Membership may be discontinued by either you or the Club at any time after you have purchased the three additional books.

Fill out the card and mail today! If the card is missing, write to:  
**BYTE BOOK CLUB™, P.O. Box 582, Hightstown, New Jersey 08520-9959**

Where is this interrupt used?

ibm.pc/pc.software #1007, from dmick  
a comment to message 999

My impressions are, from looking at its code and the code for the "transient loader" in DOS 2.1, that it is the loader for COMMAND.COM to initialize the system. Once I have DOS loaded, there's not a single INT 28H to be found anywhere in memory, DOS's or otherwise, which leads me (also) to that suspicion. You might snoop at IBMDOS.COM and see if it's called in that code.

ibm.pc/pc.software #1008, from mjk [Martin Kochanski]  
a comment to message 999

INT 28 is called by DOS repeatedly whenever it gets bored, that is, waiting for the user to type something at the keyboard. INT 28 does nothing whatsoever. But if you have the standard print spooler PRINT.COM installed, then it intercepts INT 28 and copies a little text to the printer before returning to DOS (which tests the keyboard and calls INT 28 again if there's still nothing). It *may* follow that you can use INT 28 for some background purposes of your own, and even that you can call DOS disk routines from within it, but I'm not sure.

ibm.pc/pc.software #1009, from dmick  
a comment to message 1008

Yeah, I was thinking of INT 2EH, which someone asked about earlier. INT 28H does *exactly* nothing (IRET) on the IBM XT and Zenith Z-150, that's right. However, I couldn't find *any* calls, including DOS calls, to it either. I'll look again on both, I guess, and examine PRINT.COM, too. I always thought PRINT used the timer interrupt.

ibm.pc/pc.software #1010, from barryn  
a comment to message 1009

>thought PRINT used the timer interrupt.

I think PRINT uses IRQ7 (hardware interrupt F, at addresses 3C-3F) to tell it when it can send the next character to the printer via INT 17.

ibm.pc/pc.software #1011, from dmick  
a comment to message 1010

That would seem to make any other process (the foreground task) be awfully slow; that is, the CPU is tied up printing chars as fast as it can. OK, OK . . . I'm ripping PRINT apart tomorrow. You guys just won't let me get disinterested in whatever you bring up!

ibm.pc/pc.software #1012, from barryn  
a comment to message 1011

Don't bother tearing it apart . . . just try this experiment: Tell PRINT to print a fairly long file, something that will give you time to do some telecommunications while it's printing. Then, while the print is occurring, use your communications software to log onto a bulletin board somewhere. Watch closely to see if some of the communications characters are dropped. Then hit the button on the printer that de-selects it and watch for the dropped-characters problem to go away.

The missing communications characters are a result of the PRINT program tying up the PC's interrupt processor for too long a time.

ibm.pc/pc.software #1016, from rechnapp [Russell Schnapp]  
a comment to message 1010

I seriously doubt that any IBM/MS software uses IRQ7. It was poorly implemented on early monochrome adapters, and the bad design was copied by too many board makers. The INT 28 hook to PRINT sounds right.

ibm.pc/pc.software #1017, from suer [Sue Rosenberg]  
a comment to message 1016

The following information about INT 28 came from the NBS bulletin board and was posted by Ross M. Greenberg:

INT 28: Internal routine for MS-DOS

This interrupt is called from inside the "get input from keyboard" routine in DOS if, and only if, it is safe to use INT 21 to access the disk at that time. It is used primarily by the PRINT.COM routines, but any number of other routines could be chained to it by saving the original vector and calling it with a FAR call (or just JMPing to it) at the end of the new routine.

**COMPUTER BRIDGE**

♥ **TRY IT FOR FREE** ♥

- Deals, Bids, Declares, Defends and Scores
- Enjoy over a **MILLION Deals** - or your own
- Scoring: Rubber-MPS-IMPS-Chicago-Partials
- Either partnership can optionally Signal
- Runs on either a Color-Graphics or Text Display
- Cancel, Claim, Concede, Hints, Take-Back
- For 1 to 3 players - partners or opponents
- Novice to Advanced Features- for all players
- Newsletter subscription and Owner Tournaments
- Disk: **Not Copy-Protected** - can be Backed-up

Here is what the **Critics** are saying...  
**"RECOMMENDED"** Jerry Pournelle - BYTE JAN 88  
**"A Challenging Opponent"** PC World - NOV 85

**FOR ANY 256K IBM-PC OR COMPATIBLE**  
**THE \$75 BRIDGE PARLOR™ Game**  
 Use it **FREE** for 15 days - then decide

☎ **1-716-865-8412 Today**  
 or Send order to Parlor Software Co.  
 Box 17850, Rochester, NY 14617  
 (No \$4 S&H Charge on Phone orders)

- Same Day Shipping - Dealer Inquires Welcome
- **Guaranteed to be Strongest Available**

**ZIMCO**  
INTERNATIONAL, INC.

- MULTITECH PC CLONE PACKAGE \$799
- w/256K monitor/DOS/ports/clock/more!
- **LOTUS SIGNAL Intro special \$375**
- **IBM/APPLE/HARDWARE/SOFTWARE/ASK US!**
- **BOARDS**
- EVEREX Graphics Edge \$235
- EVEREX Edge \$234
- AST 6 PackPlus 384k \$209
- AST Imagepage 256k \$306
- HERCULES Graphics Card \$280
- **DRIVES**
- SEAGATE 20m w/POXT controller \$440
- SEAGATE 30meg XT 40ms FAST \$540
- MOUNTAIN 20meg Hardcard \$739
- IRWIN 20meg tape backup \$555
- **PRINTERS**
- CANON LaserJet A-1 \$1899
- EPSON FX85 \$335
- OKIDATA 192.193 1339/459
- IBM PROPRINTER/XL \$399/609
- **MODEMS**
- HAYES 1200/1200B/2400 \$359/348/559
- SUPERMODEM 1200 [Hayes comp.] \$169
- **CALL for Catalog & latest PRICES**

**1-800-227-6647**  
 For Technical Support & NYS  
 Call 718-479-7888  
 D&B # 130151913

**DATA ACQUISITION AND CONTROL**

**DATATAKER: \$1897 COMPLETE**



46 Analog/8 Digital Inputs  
 Matches Common Transducers & Sensors  
 Built-in Software/RS-232 Communications  
 Portable  
 Dedicated or Stand Alone

What makes it a best buy?  
 Call or write today:

**ZI-TECH**  
 INSTRUMENT CORPORATION  
 2151 Park Boulevard/P.O. Box 60490, Palo Alto, CA 94306  
 Telephone: (415) 326-2151

Until PRINT.COM installs its own routine, this interrupt vector simply points to an IRET op code.

**ibm.pc.pc.software #1018**, from dmick  
a comment to message 1017

Thanks, Sue! Timely for sure! And thanks for trying to save me the time, Barry, but if it's not obvious by now, I'm kind of obsessive. I'll investigate and find out what all of you are telling me, I guess, although there still seems to be some controversy over INT 28H software call or hardware interrupt.

**ibm.pc.pc.software #1021**, from dmick  
a comment to message 1012

But if PRINT used IRQ7 like you say, the communications ports (IRQ2 and 3) would take precedence, right? What I mean is, wouldn't the serial interrupt interrupt the IRQ7 service routine? Or does the 8237 mask out all eight while it services one interrupt? I forget and don't have my hardware docs handy.

**ibm.pc.pc.software #1022**, from barryn  
a comment to message 1021

Good question. Did you have a chance yet to trace through PRINT.COM to see exactly what's going on?

**ibm.pc.pc.software #1024**, from dmick  
a comment to message 1022

No, but you can bet I will. I did look at my reference for the interrupt controller, though, which is (contrary to what I said before) an 8259A (I've been having problems with my DMA chip, too). Anyway, if a lower-level interrupt comes in while a higher level is being serviced, the 8259A passes the IRQ to the CPU, which will respond if the interrupt mask is enabled (STI). So, if PRINT's hypothetical ISR for IRQ7 does an STI, the comm ISR should execute in the midst of PRINT. I should just shut up until I get to PRINT.

**ibm.pc.pc.software #1028**, from dmick  
a comment to message 1024

ACK! <---Bill the Cat

Gad! PRINT takes over the following vectors:

- 28: Called once from within DOS. I can believe it's from the KB handlers. Just before an exit from the routine, whatever it is.
- 2F: Documented. Unused except by the PRINT system.
- 13: Disk access (!). Seems to be a sort of "isolation" call . . . don't print characters while dinking, maybe?
- 17: Printer. Obvious reasons.
- 05: Print screen. Can't start one unless no print files going. Reasonable.
- 14: Communications (!). Pretty complex. I'll look a little further. I suspect this is to add buffering (and maybe has a bug, Barry).
- 1C: Timer tick. I'll bet this is what does the actual bground/ground context switch to send some chars to printer. Looks that way.

There's a million variables/semaphores involved with this (surprisingly big and complex) routine. I think just for my own information about context switching, I'll probe further . . . but not tonight.

Who asked about this, anyway? Have we answered your question yet?

**ibm.pc.pc.software #1030**, from barryn  
a comment to message 1028

It's past the point of caring who asked about this. It's reached the point of raw, unadulterated curiosity . . .

Let's see. First off, I notice INT F isn't on the list. There goes my original theory out the window.

INT 13? PRINT.COM *does* print from the disk, unlike other spooler programs. I can see why PRINT would need to be "protectionist" about the disk. I wonder if it releases (restores) the previous INT 13 vector when it finishes?

INT 05 . . . I've replaced that one on occasion myself. If PRINT did things by the book, it wouldn't replace the interrupt vector; it would just set the print screen flag (at 0050:0000) to a nonzero value. This is supposed to tell the print screen routine that something is in progress and it had better not dump the screen at this time.

INT 14? Maybe it has to do with being able to redirect parallel output to a printer connected to a serial port. It can't be for buffering purposes . . . the INT 14 routines don't provide any buffering and are pretty useless for communications purposes, except perhaps for setting baud rate and communications parameters. INT 14 should *never* be used for actual send/receive operations.

**ibm.pc.pc.software #1040**, from dmick  
a comment to message 1030

Yeah, INT 14 probably has to do with serial printers. But I meant it *might* be adding the buffering to the ISR that should've been in the BIOS from the beginning, since things are just that much more critical when you've got a PRINT process hogging CPU time. About your comments on INT 05 (print screen) . . . seems like that flag is defined as "there's a screen print" in progress or "error during screen print," which may or may not be generally applicable to printer activity in general. Do any popular applications or languages allow you to interrupt a print procedure with a print screen request? Hmmm . . . guess I've got *another* thing to investigate.

**ibm.pc.pc.software #1042**, from barryn  
a comment to message 1040

If the INT 05 routine leaves a value of 255 in the print screen flag, it's signaling that it ran into an error. However, if the flag has a value of 1 when the Shift/PrtSc keys are pressed, the INT 05 routine will just exit (no action taken). Or if INT 05 is invoked from within an application and the flag is already a 1, it just exits.

**ibm.pc.pc.software #1044**, from dmick  
a comment to message 1042

Yeah, right, but it's *set/read* by the INT 05 routine; that was my only point. (Actually my point was that it was defined to be *set/read* by that guy. Whether or not he's the only one allowed, I don't know.)

**ibm.pc.pc.software #1045**, from barryn  
a comment to message 1044

Well, if I wrote a payroll application that printed checks, I'd be sure to stick a "1" in the print screen flag while I was printing checks. Whether programmers actually go to that extent or not I don't know. I understand a great deal of IBM's "application software" (such as the Assistant series) was ported from System/23 BASIC to the PC, and I doubt if much effort was put into any of the peculiarities of the PC.

**ibm.pc.pc.software #1046**, from dmick  
a comment to message 1045

I know what you mean . . . I'd either set the flag and hope it worked in the next BIOS release or take the INT 05 vector and use my own flag. By the way, WordStar, Lotus 1A, and my favorite program editor all allow print screens while printing.

(continued)

**LINKING BASIC AND C**

ibm.pc/pc.software #1141, from pcl [Peter Cleary]

Hello . . .

I'd like to know if anyone here has tried to make a patch to link C and BASCOM. I have an application that now has to use files to communicate data back from C. I really don't know why they decided not to support BASIC. Many existing BASIC programs could use some optimizing. Meaning C subroutines. If any .ASM wizard has done it, could he/she let me know about it? Thank you.

ibm.pc/pc.software #1142, from gperfect [George Perfect]  
a comment to message 1141

I hooked Microsoft BASIC (compiled) into some Texas Instruments speech driver routines written in Lattice (I think) some years ago. The TI code was designed as standard C libraries so the code should remain sound. Basically, you need to convert arguments passed by BASIC's "CALL func(args)" facility into the format expected by your C compiler. BASIC passes *all* arguments as pointers. Version 5.3 of the Microsoft compiler (and later) passes them on the stack. Where the called C function expects (say) an INT *value*, your conversion routine must push the value *pointed at* by the BASIC argument onto the stack.

On return from C, you must remember to pass back the returned value, if any. I did this by passing an extra argument via BASIC's CALL and stored the result in that.

A couple of ground rules:

- *Never* allow C to modify a BASIC string—at least not its length. BASIC strings are stored with two bytes (an INT) describing the length immediately followed by the string itself. C has no length field but stores a NULL (zero) byte at the end of the string.
- If you pass a BASIC string to the C routine (say, a filename) BASIC actually passes a pointer to its length field. You must increment this pointer by two bytes before passing it on to C.
- Some C routines use quite a lot of stack space; ensure the stack in your main program is adequate or switch to a separate stack (the approach I adopted) before calling C.
- Be wary of calling C functions that allocate memory or perform I/O on standard devices (stdin, stdout, etc.), as these are normally initialized by the C program's startup routine, which will *not* have been called. Some C functions call these routines as side effects; if in doubt, read your library manual.

I hope this helps. If you need any more info, let me know. If necessary, I'll dig out the assembler I wrote to do the job and post it in long.messages.

ibm.pc/pc.software #1144, from btonkin [Bruce Tonkin]  
a comment to message 1142

BASIC strings are passed as a pointer to the string descriptor. On 8-bit versions of BASIC, the first byte pointed to is the string length, and the next two bytes are the location of the actual string. On 16-bit versions (compiled), the first *two* bytes are the length as a signed integer, and the next two are a pointer to the string in the current data segment. Neither the length nor the pointer may be modified except in very special circumstances.

ibm.pc/pc.software #1145, from barryn  
a comment to message 1144

What circumstances, Bruce? I thought it was absolutely forbidden to touch the string descriptor from within an assembler subroutine. If there's a way to do it, I'd sure like to know.

ibm.pc/pc.software #1146, from btonkin  
a comment to message 1145

If the string descriptor points to a file buffer, then the length of the

string or the location of the string may be changed *if* the length can be entirely contained within the file buffer and *if* the string is still within the file buffer after the change. I did it routinely with the CP/M compiler and it'll work in the MS-DOS compiler, too. But be careful! Point it to the buffer *before* you fiddle with it! Also, on the MS-DOS stuff, there's something called a "string back pointer" which can mess things up, though I don't know what it's supposed to do.

If you do garbage collection before you call your routines, and if you save all pointers before you fiddle with the string and restore them before you return, you can get away with fiddling, too. Have fun!

ibm.pc/pc.software #1147, from barryn  
a comment to message 1146

Sounds like walking into the Black Lagoon in the dead of night. . . .

ibm.pc/pc.software #1148, from dmick  
a comment to message 1146

Um . . . the back pointer points backward somehow. I figured this out once, but I believe it's a pointer to the string right behind (earlier defined, or higher in string memory) the one to which it belongs. I forget where it is, though. Seems like it's the last item in the string area (after the actual string data) or before it. I thought it was added to help garbage collection . . . seems like I read this somewhere.

ibm.pc/pc.software #1150, from gperfect  
a comment to message 1144

Apologies, apologies, apologies!

Bruce is quite correct in his description of BASIC string descriptors and I was quite wrong. You can see how long it is since I did any serious work in BASIC. I hope nobody spent any time trying to produce working code with my earlier descriptions. The remaining info is still valid, however.

ibm.pc/pc.software #1152, from gperfect  
a comment to message 1144

I just looked up the correct description for Microsoft BASIC strings in the V5.35 compiler manual. Page 97, paragraph 8 says, "If the argument is a string, the parameter's offset points to four bytes called the string descriptor. Bytes 0 and 1 of the string descriptor contain the length of the string (0 to 32767). Bytes 2 and 3 respectively are the lower and upper eight bits of the string starting address in string space.

"The string start address points to a two-byte flag and a two-byte back pointer (for efficient garbage collection), followed by the actual string. *The compiler string space should not be tampered with, or a 'String Space Corrupt' error may result*" (their emphasis). This is maybe where Dan saw the reference to back pointers and garbage collection.

## MACINTOSH

Confusion over the effects that any of the various upgrades can have on your system has dominated the Macintosh conference, a dominance that is reflected in the selections here. In the midst of the confusion, there is a discussion on the philosophical considerations of compiler design. With this brief exception, the section concerns itself with upgrades, giving attention to (among others) disk formats, cooling fans, and power supplies.

### UPGRADE OBSERVATIONS

macintosh/mac.plus #35, from dpallen [David Allen]

I just upgraded my 512K Mac with the addition of internal and external



drives and new ROMs. I have not upgraded the logic board yet because I need the power from the unupgraded communications port to drive my Macvision and Penmouse+ pad. (Besides which, my dealer doesn't have any right now.)

I have the System Installation disk that was provided with the February 1986 update to "Inside Macintosh." This disk provides system 3.1.1 and an install program that does not work. It gets the wrong date from the 3.1.1 and throws up. Apparently the install program was date-sensitive to either the 3.0 or 3.1 version and Apple forgot to change the date for 3.1.1. If anyone has a quick fix for that one I would appreciate it. Meanwhile, I am using the known buggy 3.0 that comes with the disk drives because I don't want to take the time to reinstall my desk accessories into all my boot disks, which I would have to do if I brute-force-substitute 3.1.1 for the old system file.

In olden days I could remove the Finder from the boot disk when necessary for disk space considerations and just specify the boot program to use. It appears that one must retain the Finder on any boot disk, even when one does not want to use it. At least I am unable to get a boot from a systems file that does not contain the Finder in the same window folder. Is this true? If so, it is really a step backward. I wanted to reduce the size of the RAM disk folder so that everything would fit inside a 339K RAM disk. This I have done with the old system. I can't do it with this one because the Finder insists on coming for the ride even though I told him to stay home and mind the kids.

Is there any way to force the system to find a file outside the current window? It's a pain to have things boggled up just because the system can't find a file that is really there.

Although there is some improvement in disk speed operations, I do not see the whiz-bang speedup that some of my friends with Pluses are remarking about. Is this because I don't have the new logic board yet? I had hoped that things would be faster than they are.

Joe Miller of Koala tells me that the cable/power supply cobbled up by the Thunderscan people will also work for Macvision. Koala plans to provide the self-same cable arrangement as a product in the next couple of weeks. Also coming is a new Morevision program, since the old one will not work with the new ROMs. The older desk accessory software for Macvision *does* work OK with the new ROMs though, so I am not completely out of business with Macvision. Koala is going to add more capability to Morevision when they re-release it to fix the ROM compatibility problem. Look for even better performance from Macvision with this new software. Apparently there has been some hidden capability in the Macvision box that the older software has not addressed.

The folks at Kurta are coming up with a new connector and internal circuit board so that the Penmouse+ tablet will continue to work from the communications port of the Mac Plus. They claim to be able to make their tablet work from the Mac Plus communications port even though the voltages previously available there have been removed. They are also going to drastically improve their Macintosh software to make it much more friendly. (Much needed.) Meanwhile, the Mousepad+ is definitely the Macintosh/Amiga/IBM PC mouse. It uses a cordless stylus with internal battery supply and works really well.

I see that Apple is continuing the charade that great disasters will immediately befall all who attempt to use single-sided disks initialized for two sides. In all the time I have used both sides of single-sided disks with the Apple II (hundreds of disks) I have never had even one failure from the use of the "other" side. The only disk failures I have witnessed were on the "front" side! As one manufacturer explained to me off the record, they don't even know which side of the disk will be the "front" side when the inspection takes place, so they have to be equally careful with *both* sides of the magnetic material. Apparently the only virtue in buying "double-sided" disks is that if you have a failure on the "back" side they will replace the disk under the warranty (big deal), while they won't with a single-sided disk "misused" as a double-

(continued)

## a message to our subscribers

From time to time we make the BYTE subscriber list available to other companies who wish to send our subscribers material about their products. We take great care to screen these companies, choosing only those who are reputable, and whose products, services, or information we feel would be of interest to you. Direct mail is an efficient medium for presenting the latest personal computer goods and services to our subscribers.

Many BYTE subscribers appreciate this controlled use of our mailing list, and look forward to finding information of interest to them in the mail. Used are our subscribers' names and addresses only (no other information we may have is ever given).

While we believe the distribution of this information is of benefit to our subscribers, we firmly respect the wishes of any subscriber who does not want to receive such promotional literature. Should you wish to restrict the use of your name, simply send your request to the following address.

**BYTE Magazine**  
Attn: Circulation Department  
One Phoenix Mill Lane  
Peterborough NH 03458



## Polaroid®

When you're in a spot,  
only Polaroid offers to  
get you out.

### Free DataRescue™ service

| 3 1/2" DISKS                  | 5 1/4" DISKS                  | 8" DISKS                      |
|-------------------------------|-------------------------------|-------------------------------|
| S-Side <b>16<sup>95</sup></b> | D-Side <b>9<sup>95</sup></b>  | S-Side <b>17<sup>95</sup></b> |
| D-Side <b>21<sup>95</sup></b> | D-Den. <b>13<sup>95</sup></b> | D-Den. <b>19<sup>95</sup></b> |
|                               | S-Side <b>15<sup>95</sup></b> |                               |
|                               | D-Side <b>22<sup>95</sup></b> |                               |
|                               | 96tpi                         |                               |
|                               | High Den.                     |                               |

\*Offer Good For  
Polaroid Diskettes  
ONLY

Old Reliable  
the **Diskette Connection™**

\*Delaware 1-800-451-1849  
PO Box 10247 Wilmington, DE 19850  
\*Oklahoma 1-800-654-4058  
PO Box 1874 Bartlesville, OK 73008  
\*Nevada 1-800-621-6221  
PO Box 1213 Boulder City, NV 89005

sided disk. It isn't that they didn't inspect it... they just won't warranty it unless you pay the double-sided price.

Any comments on these observations will be appreciated.

**macintosh/mac.plus #36, from bbayer [Barry Bayer]**  
a comment to message 35

Re: single-sided 5¼-inch disks:

Not only that but Apple uses the *bottom* of the disk, while (I have been told) Tandy uses the *top* (models 1 thru 4, at least). But most catalogs show the SS disk for both.

**macintosh/mac.plus #38, from lloeb [Larry Loeb]**  
a comment to message 35

As was previously stated in another section, to get the installer to work, open it with ResEdit, and open the INSC resource. Change the date string from 9A740CF6 to 9A8B6777 and it should work. See TN76.txt in mac.supplmnt if all else fails.

**macintosh/mac.plus #40, from mcgath [Gary McGath]**  
a comment to message 35

Just got my Mac upgraded today, and updated one of my Finder-less disks by temporarily removing an application to make room (having copied it), running the update, removing the Finder (but using the Minifinder), and then copying the application back. No problem.

**macintosh/mac.plus #41, from dpallen**  
a comment to message 38

Installer script for Mac Plus update has INSC ID=0, which I opened. The only close strings I found were "9A740FF4" and "9874081D." I looked and found that I do not have tech note #76. Any further suggestions, Larry?

**macintosh/mac.plus #43, from lloeb**  
a comment to message 41

TN76.txt is in Listings under mac.supplmnt. Is there a INSC resource in the System you want to update to? If so, change to that string. Keep me posted.

**macintosh/mac.plus #45, from hedges [Tom Hedges]**  
a comment to message 35

Although Apple's comments about single-sided disks being used on both sides are a little like a press release by disk manufacturers, I have had more than a few single-sided disks that failed disk initialization for double-sided and one that passed, wrote OK, and failed to read immediately thereafter (that one was the disaster just like Apple predicted). So watch out.

**macintosh/mac.plus #46, from dpallen**  
a comment to message 45

I, too, have had a couple of failures in initializing disks with the new drives; however, they were accompanied by a peculiar mechanical squealing near the end of the initialization and the initialization failed. The disks would not initialize as single-sided after that either, even when I bulk-erased them.

**macintosh/mac.plus #47, from hedges**  
a comment to message 46

My failure mode was not so dramatic. It got through the format and into the verify pass, then just said it couldn't initialize. If you try again at double-sided, no go; try at single-sided and all will be OK.

**macintosh/mac.plus #48, from scottmac [Scott MacGregor]**  
a comment to message 47

I haven't had failures with single-sided disks yet, although I bought DD/DS when I upgraded. Somewhere I heard a comment that if a single-sided disk had been used a lot, that the other (unused) side had the pressure pad rubbing on it, and this was the most likely reason for not using it as a DS disk. I guess the moral is when using a single-sided as a double-sided, make sure it is relatively new!

**macintosh/mac.plus #49, from lloeb**  
a comment to message 48

That rings true to me and would account for the horror stories one hears. If the pressure pad stuff hits the top head—bad news.

## DECEMBER 1985 UPDATE

**macintosh/tech.talk #183, from rschnapp [Russell Schnapp]**

I know, I'm probably the last one to have bought the "December '85" Mac Software Supplement Additions.

I just tried to use the Installer on the System Installation disk to update a copy of my Paradise MAC 10 boot disk. There was no trouble installing the "External Disk" script. The "Mac Plus" script, though, fails before I can click Install. It says the System file's date is incompatible with the one in the script.

Do I really have to install System 3.1.1 the hard way (i.e., via ResEdit)?

**macintosh/tech.talk #184, from lloeb**  
a comment to message 183

Yup. Change the INSC resource to 9A8B6777 from 9A740CF6. If I had a Plus, I'd verify a script and upload it... but I don't.

**macintosh/tech.talk #185, from rschnapp**  
a comment to message 184

First, is that INSC resource in the script? I assume that's what you mean.

Second, I don't have a Plus, either. Their documentation said that you must perform the Mac Plus update to obtain the new System, Hard Disk 20, etc., even on a 512K Mac.

**macintosh/tech.talk #186, from lloeb**  
a comment to message 185

First, yes. There should be a resource-type INSC in the script.

Second, do you currently have an HD20 file on your startup? Does it load HFS into RAM? The installer is based on purging RAM-based HFS. If you *have* to have RAM-based HFS (because you don't have the new ROMs) I'm not sure the newest system will be of much use to you. Comments?

**macintosh/tech.talk #187, from rschnapp**  
a comment to message 186

Thanks, Larry. I tweaked the INSC resource and the installation worked. Yes, I have the Hard Disk 20 file in my startup. I updated a copy of my MAC 10 boot floppy and booted with mouse button held down (declining auto-mount of the hard disk and System). I then explicitly mounted the hard disk. Voila. It all works. After some investigation, though, I agree that Finder 5.2/System 3.1.1 doesn't really gain me much. I was hoping for the zoom boxes in the Finder, but I guess that is only if you get the 128K ROMs. Most of the really good stuff seems to be only in the ROMs, like menu sorting.

After hearing about the Red Ryder problems with RAM HFS and the new System, I think I'll hold off until I upgrade my ROM/disk. Red Ryder 7.0 still works just fine with 2.1/5.0 RAM HFS.

**COMPILER QUALITIES**

[Editor's note: The messages leading up to #316 dwell on the reputed speed of a not-yet-released compiler.]

macintosh/software #316, from hedges  
a comment to message 306

As a developer I can't understand why everyone is so concerned with compilation speed. Freedom from bugs, quality of code, support for embedded MDS-compatible assembly language in-line all seem to be more important to me. A too-fast compiler may be nice if your marketing strategy is to lure away BASIC hackers to a compiled language (i.e., Turbo Pascal), but a developer on the Mac has to be far beyond that stage. If saving development time is the real objective, then everyone would be demanding a high-quality source-level debugger, because one certainly spends more time debugging than waiting for a slow compiler.

macintosh/software #317, from paul.hoffman [Paul Hoffman]  
a comment to message 316

I agree, hedges. More good compilers will get us more good software from lower-level people. I never saw the "greater good" of Turbo Pascal on the IBM PC until I talked to two people who had bought it for nerdy fun and ended up releasing very good utilities into the public domain. It will probably happen here, too.

macintosh/software #318, from dwiner [Dave Winer, Living VideoText]  
a comment to message 316

Hey—I want a good debugging environment, too! But fast compile

speed is important because it makes it easier to make small tune-ups to your program and test them individually, instead of lumping a lot together. It makes it easier to trap bugs also—because if you changed your otherwise-debugged program in only one place, you should have a pretty good idea where to look for the problem!

Ideally, you should have your source code in one window and the running program in another—and such a fast compile time that you can tune up a program the same way a painter tunes up a painting!

macintosh/software #319, from bwebster [Bruce Webster, Consulting Editor, BYTE]  
a comment to message 316

"...one certainly spends more time debugging than waiting for a slow compiler."

It's exactly the time spent compiling—adding code, increment by increment—that makes fast compilers appealing. You know the old "code-and-go" approach of BASIC hackers? And, of course, I design stuff right the first time, so I spend more time compiling than debugging (...trying to keep a straight face...).

macintosh/software #321, from jbaker [John Baker]  
a comment to message 316

I agree; a fast compiler is nice, but given the choice between a fast compiler that generated mediocre code vs. a slow optimizing compiler that generated superior, high-performance objects, I would take the optimizer any day. The comment about a source-level debugger is also right on. The recently released native code Modula-2 compiler

(continued)

**TAPE BACKUP**



External Internal

- 60MB WANGTEK Tape Backup **\$880 \$794**
- 20MB Cassette Tape Backup **\$699 \$599**

- Backup 20MB in less than 5 minutes
- Image/file-by-file backup and restore
- Menu driven software
- Interchangeable DMA, port address and interrupt

**INCREDIBLE MACHINE-  
INCREDIBLE PRICE!**  
Made in the USA

**QIC-286-QT**



**\$1295**

- Fully IBM Compatible, runs all major software
- 80286 CPU, 6/8 MHz clock calendar
- 512K RAM on motherboard, expandable to 1024K
- 1.2MB or 360K floppy disk drive
- WD combined floppy/hard disk controller
- AT style keyboard
- 192W power supply
- 8 expansion slots
- Clock/calendar with battery backup
- Documentation and setup program
- FCC Class 'B' approved

**MODEM**



**\$128**

**EVEREX  
EVERCOM**

- Comes with Bit-Com Software
- 1/2 size 300/1200 Baud Modem
- Fully Hayes, Bell 103 & 212A compatible
- Supports Com 1,2,3 & 4

- 1200/2400 Baud Internal **\$399**
- 1/2 size modem
- Modem, multifunction card **\$399**

**HARD DISK**

- 20MB Seagate 1/2 Ht. hard disk (with controller) **\*\$379**
- 30MB Seagate 1/2 Ht. hard disk (65 Ms with controller) **\$549**
- 20MB Seagate full Ht. hard disk (40 Ms) **\$589**
- 30MB Seagate full Ht. hard disk (40 Ms) **\$659**

\*C.O.D., VISA, MC only.

**QIC EGA \$259**

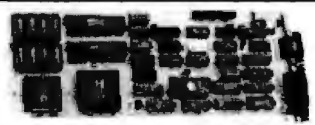

- IBM EGA compatible
- 720 x 348 mono
- 640 x 350, 16 colors
- 640 x 200 color



**800-843-0806 (Sales)**  
**(408) 942-8086 (CA)**  
In Canada call  
**(416) 842-3177**  
Tech Support (408) 942-0856  
489 Valley Way  
Milpitas CA 95035

**GRAND OPENING**  
QIC Research of Chicago  
1926 Waukegan Rd., Suite 3A  
Glenview IL 60025  
(312) 998-8903

**NEC Multisync monitor \$539**

**QIC MONOGRAPHIC**

- 100% Hercules compatible
- Comes with parallel printer port **\$99**
- Everex Edge (mono/color card) **\$239**

MacMETH has such a debugger, the best tool in the package, and I can assure you that a good debugger is far more useful than a fast compiler with a poor or (in the case of many Mac systems) nonexistent source-level debugger.

#### MACINTOSH PLUS POWER SUPPLIES

macintosh/soapbox #575, from hansen [Allan Hansen]

Since I had my 512K Mac upgraded to a Plus, I have had the power supply changed 3 (three!) times. Is that common (is the power supply not able to handle the new drive?) or was I just unlucky? I also had to have the focus redone after the last change. I thought my eyes were going bad.

macintosh/soapbox #576, from bwebster

a comment to message 575

Ouch. And my condolences.

macintosh/soapbox #578, from lloeb

a comment to message 575

I've had mine replaced because of voltage regulator/flyback transformer problems in the sweep circuit. Now I have an inexpensive Radio Shack 3-inch fan sitting in the central depression of the case. No heat problems now! Unless you have AppleCare, may I recommend same?

macintosh/soapbox #581, from hedges

a comment to message 575

I've had one Mac for almost two years and another for 15 months. Neither has ever failed (knock on wood) except a 64K memory chip died (of fright, I think) the night before I got up the nerve to put a Dr. Dobbs-style 512K memory upgrade into it myself. That upgraded 128K machine has since been upgraded with 1MB of memory, an SCSI adapter, and a homebrew 12-bit audio DAC, all of which use lots of power (and it will still drive a MacNifty Audio Digitizer that sucks more juice from the serial port). I guess I've got a good power supply board.

macintosh/soapbox #587, from mdelugg [Michael Delugg]

a comment to message 578

Larry,

Hate sounding *really* dumb, but is the fan set up to pull hot air up and out?? (I would assume, but have learned not to.)

macintosh/soapbox #588, from lloeb

a comment to message 587

The fan I have (3-inch RS #273-242) sucks air through the Mac and pushes it out. That is, the exhaust is away from the Mac. Sitting in the handle, it pulls air through the vent that is sometimes blocked by people putting their keyboard "into" the main body of the Mac. (Go look under the lip on the front. See that vent there?) I prop the whole thing up so one edge of the fan is resting on the top of the Mac and the other on the base of the indentation. It rests on a taped-down tongue depressor (hey, use the materials at hand, right?) so that the vibration isn't transmitted to the case. What I *should* do is make up some triangular rests for a fan and sell them through the back pages of BYTE for a 4000% profit. . .oh well, another business opportunity lost.

My message wasn't at all clear on the how of the fan, so I don't think it was a dumb question at all.

#### MACINTOSH PLUS QUESTIONS

macintosh/mac.plus #108, from jamurphy [Joe Murphy]

I just heard that my Mac Plus upgrade came in (I ordered it through my university consortium about 7 weeks ago) and in a couple days I

am having my Mac upgraded. For those of you who have a Mac Plus or have had their Mac upgraded, I have a few questions:

1) I am using a Hayes Smartmodem. Will that adapter cable work as it should and make my modem usable?

2) Is there a cable available from Apple for use with the Mac Plus and the Imagewriter I?

3) Can I re-initialize my single-sided disks as double-sided?

4) I have heard that many people who have upgraded have quickly had their power supplies fail; anyone have this happen? And if so, did you have one of the original Macs with the bad power supply?

Thanks in advance.

macintosh/mac.plus #109, from lloeb

a comment to message 108

1) Probably.

3) Only if they are relatively new and the stuff from the pressure pad that wipes off on one side of the disk won't foul up the second head. Single-siders have this pressure pad where the new head wants to be.

4) My original 100-day analog board failed because the flyback transformer went, not because of the power supply part. (Mine had dark paper on the side that goes next to the case; the newer ones are white.)

macintosh/mac.plus #110, from jruley [John Ruley]

a comment to message 109

And make sure that you get the latest revision of the software tools (v. 3.0 I think) or you may have some very strange problems!

macintosh/mac.plus #111, from lloeb

a comment to message 110

Ummm. . .do you mean System/Finder? 3.1.1/5.2 is latest semi-stable.

macintosh/mac.plus #112, from jruley

a comment to message 111

Oh, sorry. Yes, the Finder. And I should have said v. 3.2—which we just got. 3.1 has problems with Multiplan (*out of memory* ??).

macintosh/mac.plus #113, from lloeb

a comment to message 112

3.2/5.3 is frozen and out; you're right.

macintosh/mac.plus #114, from jamurphy

a comment to message 113

Yeah, really? When do you think the masses might get their paws on it? Is this version three-quarters done as opposed to 3.1.1, which seemed to be about half done?

macintosh/mac.plus #115, from jruley

a comment to message 114

I checked—version 3.2 is what I've got. It clears up the memory errors in Multiplan nicely—definitely better than 3.1.1 Try your dealer—ours had it but did not burst the packaging and put it in, so we got 3.1.1 in the box.

Which is a long-winded way of saying you have to ask for it!

macintosh/mac.plus #116, from erosenbaum [Ed Rosenbaum]

This is a weird comment about startup screens. First, you convert the straight MacPaint pics with something like "ScreenMaker" by Bill. Then, you stick the screen into the System Folder. Should work fine!

macintosh/mac.plus #117, from Iloeb  
a comment to message 114

It's going to be distributed to all registered developers by Apple.

macintosh/mac.plus #119, from paul.hoffman  
a comment to message 117

Any idea when it will be sent out? And why only to registered developers? Certified developers need it just as much.

macintosh/mac.plus #122, from jruley  
a comment to message 119

As do us mere users. . . .

macintosh/mac.plus #123, from Iloeb  
a comment to message 119

Registered developers pay \$800. They gotta get something.

## PASCAL

The Pascal conference (one of several language-specific conferences on BIX) provides a forum for the exchange of information and opinions about programming. In the messages below, Dave Winer, president of Living Videotext, shares some of what he and other programmers have learned about trying to write "well-behaved" Terminate and Stay Resident ("pop-up") programs. Then there is a short discussion of checking for printer activity from a printer spooler.

### RULES FOR TSR (TERMINATE AND STAY RESIDENT) pascal/source #25, from dwiner [Dave Winer, Living Videotext]

#### Part one

There is a very active group of programmers working on Borland's SIG on CompuServe, studying the technology of resident software. They're also working on a generic "shell" for residency—they include Bela Lubkin, Neil Rubenking, and Kim Kokkonen.

Bob Bierman, an LVT staffer, gave a presentation at the Software Entrepreneur's Forum, discussing the resident technology in Ready!. Mr. Kokkonen attended the meeting and took detailed notes on the presentation. With our permission, those notes were posted on the Borland SIG on CompuServe.

I thought this document would be of interest, so I am forwarding it, with Mr. Kokkonen's permission.

#### Part two

The following is a summary of a talk given by Bob Bierman of Living Videotext. Bob is the chief programmer for Ready!, the memory-resident outline processor. The talk was given on February 11, 1986, at the IBM Special Interest Group of the Software Entrepreneur's Forum in the San Francisco Bay Area. Bob described many of the techniques used to develop a "machine-friendly" memory-resident program. Any confusion in the following is due to the summarizer and not based on any problem of Bob's.

Ready! takes several steps beyond those of earlier memory-resident programs (TSRs). Perhaps most importantly, it allows the bulk of the TSR to reside in expanded memory (LIM EMS). A single version of Ready! self-configures to use EMS or not, depending on its presence in the system. When EMS is used, the kernel of the TSR in normal memory uses only 4K bytes. The rest of the code and data in expanded memory use about 175K bytes.

When the Ready! hot key is pressed, the first step is to determine whether it is safe to interrupt DOS or the application at that time. We

will return to this important issue below. Assuming it is safe, Ready! remaps the EMS page window to access one section of the EMS code. Control is transferred to the EMS page window. Then a 16K page window is used to swap whatever is in the top 160K bytes of normal memory into EMS, while pulling the rest of Ready!'s code and data into the normal memory formally owned by the swapped area. Control is then transferred into normal memory and Ready! executes from there.

The swapping process takes about 1 second on a PC and negligible time on an AT. This swap time is apparently not bothersome to the users of Ready!, who are most happy to get their normal memory back.

The swap of Ready!'s code is made into high memory of the PC to hopefully avoid overwriting other memory-resident programs at the lower end of memory. This would be disastrous since a programmed keyboard interrupt ("hot key") for those other programs would jump into Ready!'s code at some undetermined point. Ready! checks other interrupts at invocation to help avoid this possibility.

The choice of the full swap from EMS to normal memory was not made lightly, according to Bob. The full swap was the weakest of several possibilities considered, but it had the advantage of working on schedule. The swap approach is also the least likely to cause problems when other TSRs take advantage of EMS. Bob pointed out three additional difficulties with executing directly from expanded memory—if the code and data are larger than the 64K window of EMS, the program needs to have a well-defined overlay structure allowing 16K chunks to be pulled in and out of the EMS page window; the disk transfer area (DTA) used by the TSR cannot reside in the EMS page window when an EMS RAM disk is in use; the stack of the TSR should not reside in EMS due to some stack-swapping problems when EMS functions are called.

Ready! also breaks new ground in the way it de-installs itself. Many TSRs will de-install whenever the user asks for it. This may leave holes in DOS's memory allocation structure, leading to problems. Ready! will not de-install itself until it senses that all memory above itself is free. When the user requests de-installation, Ready! sets a flag and then awaits the appropriate time for de-installation. EMS memory is freed up immediately after the request is made.

The trickiest portion of writing the TSR is determining when DOS or the application is interruptible. DOS provides no clean services to make this determination. Bob recommends checking several different monitors before allowing the "pop-up" to occur.

The first step in popping up is detecting the application's hot key. In Ready!, INT 9 is used because they also want to detect some of the keystrokes (like Ctrl-UpArrow) that the BIOS doesn't report. When the hot key is detected by INT 9, a flag inside Ready! is set, but Ready! is not activated.

DOS provides two hooks that should normally allow safe pop-ups. INT 21 function 34 returns a pointer to the InDOS flag in ES:BX. If the byte pointed to is 0, DOS is not active and therefore any DOS call can be made safely. However, function 34 itself cannot be called at any time. This function does a stack switch before returning its result and, apparently due to an oversight of its programmer, it does the stack switch with interrupts enabled. This opens the possibility for function 34 to mess itself up if it is called at the wrong time.

Bob also noted that the InDOS flag is not simply a binary value. It represents a count of "recursions" into DOS.

DOS can also be interrupted at certain times even when the InDOS flag is not 0. While DOS is waiting for keyboard input, the InDOS flag is set to (usually) 1, but at the same time, DOS also continually calls INT 28. Apparently, INT 28 was created specifically to allow the DOS PRINT command to run in the background. In any case, if the TSR watches for INT 28 calls, it is safe to use any DOS function above 9 during the INT 28.

Other monitors must also be checked before invocation. Because

(continued)

many programs use the BIOS calls without going through DOS, it is necessary to check whether the BIOS disk calls (at least) are active. This is done simply by taking over the disk interrupt (INT 13) and setting a flag (within Ready!'s data area) upon entry to the interrupt, and resetting it upon exit from the interrupt. Before popping up based on some other interrupt, Ready! checks its own "InINT13" flag to make sure that no disk access is in progress. Ready! follows the same scheme for several other interrupts.

Looking at the DOS memory map after installing Ready!, it becomes apparent that all of the following vectors are taken over by the program:

- 8 Timer
- 9 Hardware Keyboard
- 10 Video
- 13 Disk
- 16 BIOS Keyboard
- 20 Program Terminate
- 21 DOS
- 25 Absolute Disk Read
- 26 Absolute Disk Write
- 27 TSR
- 28 Background Process

In all likelihood, 8, 13, 21, 25, 26, and 28 are taken over specifically to allow safe pop-ups without disturbing the system. INT 16 is used by Ready!'s "key transfer" scheme to pass keystrokes into DOS or an application (like the cut and paste of SuperKey and SideKick). INT 9 is used to supply special keystrokes and to aid in the pop-up process. INT 10 is used to keep track of the video mode of the system (Ready! turns off the hardware cursor and maintains its own flashing reverse-video block). INT 20 and INT 27 are most likely used to aid in the de-installation process.

This author's guess of the overall pop-up scheme is as follows:

INT 9 is used to set a flag that the hot key (Ctrl-Keypad5) has been pressed or released. On each timer tick, the hot-key flag is checked. If set, the Ready!-maintained inINTxx flags are checked for safeness.

If the INT 21 flag is set or if another "dangerous" BIOS or DOS interrupt is active, activation does not occur at the timer tick.

On each INT 28 call, the hot-key flag is checked. If set, DOS function 34 is also checked to be not greater than 1.

Without actually implementing this, it is a bit hazy but hopefully gets the idea across.

Bob emphasized that while "de-invoking" the pop-up it is just as critical that the safeness flags be monitored as while invoking it.

Ready! keeps no files opened between invocations. Files are opened only when an outline is read or written from memory, and then immediately closed. If all DOS handles are in use, Ready! will not be able to access the disk.

Ready! fully chains all interrupts that it takes over. This means that all interrupt handlers installed before and after it get their chance at the interrupt. Bob recommended that for chaining INT 16, the chaining process use the INT instruction rather than a CALL FAR instruction. By using INT rather than CALL FAR, handlers installed *after* Ready! get another chance at the interrupt. This obviously requires that some flags be set inside Ready! to avoid an infinite recursion, and it is not necessary for most of the interrupts. It is particularly important, however, for INT 16 (keyboard), where macro processors may need to be invoked. It also plays a role in the delaying mechanisms used when passing keystrokes into other applications.

Ready! does not take any special pains to work with programs (such as XyWrite) that take over the keyboard without chaining. Bob believes that any tricks to make these work will cause more problems than they solve. In particular, the SideKick trick of "stealing back" the hardware keyboard interrupt on each timer tick would be a disaster if other programs attempted to do the same thing. Living Videotext is working with

other publishers to get their programs cleaned up and compatible in this sense. They are also trying to set a standard for the scan codes returned for keystrokes not supported by the BIOS.

A few general pointers: According to Bob, the "memory-resident interface code" of Ready! amounts to 12,000 lines of assembly language. Writing a bulletproof and machine-friendly TSR is obviously no job for the weekend hacker! The rest of Ready! is written in Pascal (probably Microsoft, but definitely a linked version of Pascal).

Ready! includes its own "relocator," which fixes up the EXE image of the program when it is relocated from EMS to normal memory.

The resident portion of Ready! could not have been developed on schedule without the ATRON hardware debugger, said Bob. This \$1500 piece of hardware allows you to continue from hard crashes and to investigate the state of the machine to determine what happened. If you can't afford this, at least get an NMI reset card. The "AT Technical Reference—Options and Adapters" is an invaluable guide that many developers do not have.

The PC Network is a disaster for memory-resident programs. It takes over interrupts in a very unfriendly way, and Ready! will not work with it.

A number of the major vendors of TSRs are currently meeting informally to reach some agreement on behavioral standards for TSRs. Watch for some announcements this year. Microsoft is decidedly against TSRs, and as versions of DOS roll by, support for TSRs (such as it is) will wane, while support for true multitasking will improve.

#### SUMMARIZED BY KIM KOKKONEN

pascal/source #26, from dwiner  
a comment to message 25

A list of TSR problem areas (to BIX/Pascal/Source)

Compiled by Living Videotext Inc.  
2432 Charleston Road, Mountain View, CA 94043  
(415) 964-6300

#### Background

This list of problem areas in both resident and nonresident software was compiled during the development of Ready! and describes a policy for writing resident and nonresident software that would eliminate a lot of the problems that users have in running resident software reliably.

In each case, we describe a problem, suggest a solution, and provide an example of program(s) that illustrate the problem area.

- Use of INT 16H (get a keystroke). When an application is running, it should issue an INT 16H to get a keystroke and *should not* just call the vector installed before the application. This allows every program in the chain to see the key request and to take any and all actions that are required [e.g., Word Finder].
- Using a stack in an interrupt routine. Don't set up your own stack in an interrupt routine. This prevents it from being re-entrant and will prevent any routine from invoking at the point your stack is active. Instead, set your stack *only* when you need it *and* when interrupts are off, or in an area that is "protected" from re-entrancy [e.g., Keyworks].
- Don't take control of INT 9 (the hardware keyboard interrupt). There is no reason to, and no program should ever take complete control over the keyboard. If your program wants to use keystrokes that the BIOS does not generate, such as Ctrl-UpArrow, the program should install a routine that chains into the interrupt and generates a new scan code for that keystroke, placing it into the system keyboard buffer just as the BIOS does. If there is just a single keystroke you are looking for to do an invocation (such as a resident program, being activated by a hot key), you should just chain to the interrupt, looking for the keystroke, and when found, it should only set a flag and continue through the in-

# THE BUYER'S MART

## COMMUNICATIONS

### SERIAL COM PROBLEMS?

PCDA — Use your IBM PC or compatible to find com problems between serially linked devices. Shows data xmissions, hardware & protocol errors. \$150. COM WATCHER — Memory resident utility monitors com between your IBM PC and modem/plotter/etc. \$49.00

#### TRIPLE C SOFTWARE

2897 S.W. 13th St., Ft. Lauderdale, FL 33312  
1-305-583-0687

Inquiry 786.

## DATA/DISK CONVERSION

### CONVERT CP/M <-> MS-DOS

Read, write and format CP/M diskettes on an IBM PC or compatible. Over 115 CP/M formats on the menu and you can add your own. Use Convert to copy text and data files (such as WordStar and Dbase II) between CP/M and MS-DOS. Or use it to manufacture CP/M diskettes.

Only \$89 from Software, Inc.  
3545 Chain Bridge Rd., Suite 3  
Fairfax, VA 22030  
703-352-2977

Inquiry 785.

## CONVERSION SERVICES

Convert any 9 track magnetic tape to or from over 600 formats including 3 1/2", 5 1/4", 8" disk formats & word processors. Disk to disk conversions also available. Call for more info. (312) 459-6010

**Pivar Computing Services, Inc.**  
165 Arlington Hgts. Rd., Dept. #B  
★ ★ Buffalo Grove, IL 60089 ★ ★

Inquiry 781.

## INCOMPATIBLE WORD PROCESSORS?

We convert to and from: XEROX, DEC, IBM, LANIER, WANG, CPT, NBI, MICOM, CT, CP/M'S, MULTIMATE, WORDSTAR, WORDPERFECT, DW3, SAMNA. GUARANTEED LOWEST PRICES

Free Test Conversion Available

#### DATA CONVERSION INC.

8310 Caballero Blvd. • Buena Park, CA 90620  
(714) 522-7762 (800) 824-4851 in CA.

Inquiry 884.

## DISK AND TAPE CONVERSIONS

High quality conversion services for Dedicated Word Processors, Mini and Microcomputers. Over 800 3 1/2", 5 1/4", and 8" formats. Also 800-1600BPI tapes. Included: Wang, NBI, CPT, DEC, Vydec, Lanier, OS/6, Xerox, IBM Sys/34/36/38/5520, Mac, Victor, TRS, Apple, NSTAR, IBM PC/AT, HP, and most of the other microcomputers. We can convert directly into word processing software such as: DW3, WP, MS/WORD, WS, Semms, MM, PFS, and many others.

DATA FORMATS, INC. (408) 972-1830

Inquiry 885.

## Disk/Disk • Tape/Disk

Over 600 formats! 3 1/2", 5 1/4", or 8 inch disks; 9 track mag tape; 10 MB Bernoulli cartridge. Data base and word processor translation specialists.

#### Computer Conversions, Inc.

9580 Black Mountain Rd., Ste J  
San Diego, CA 92126  
(619) 693-1697

Inquiry 877.

## DATA/DISK CONVERSION

### CONVERT TAPE TO DISK

We will transfer data from any 1/2" 9-track magnetic tape recorded at 1800 or 3200 bpi to 5 1/4" IBM PC floppies. Diskettes included. Quantity and repeat customer discounts. Fast turnaround. Disk to tape transfers also available.

#### Competitive Rates!

#### Micro Data Services

5 Town and Country Village, Suite 774 • San Jose, CA 95128  
(408) 980-7203

Inquiry 725.

## DUPLICATING SERVICES

**DISKETTE COPYING:**  
3 day turn around, security,  
quality, most popular formats.

**MAG RABBIT/MICHIGAN**  
616-685-6186

Inquiry 738.

## WESTERN TRANSDATA, INC.

Why risk duplicating your important programs on your computer, when our equipment is designed solely to duplicate disks & verify their perfection 100%? Over 600 formats. 3 1/2", 5 1/4" & 8". Plus serialization, copy protection, labeling, packaging, shrink-wrapping and fast, personalized service.

#### WESTERN TRANSDATA, INC.

1701 E. Edinger Ave. A-4  
Santa Ana, CA 92705  
714/547-3383 (collect)

Inquiry 773.

## BLANKET SERVICES

Diskette duplication • Packaging • Stocking/Drop shipping • 48 hour delivery • SUPERLoK copy protection • No mastering fee • No charge for standard labels • Place a blanket order with releases as you need them for any quantity at a fixed price.

#### Star-Byte, Inc.

2564 Industry Lane, Norristown, PA 19403  
215-539-4300 800-243-1515

Inquiry 782.

## "DUPLICATION SOLUTIONS"

MEGASOFT specializes in all of your Diskette Duplication needs. Our "STATE OF THE ART" equipment produces 0 defects of the end product. We also provide \* AUTOLOADERS \* BULK DISKS \* SERIALIZATION \* TECHNICAL SUPPORT \* COPY PROTECTION \* PACKAGE ASSEMBLY and DISTRIBUTIVE SHIPPING

#### MegaSoft

P.O. Box 710, Freehold, NJ 07728  
1-800-222-0490 201-462-7628 (in NJ)

Inquiry 721.

## EDUCATION

### Telependence Course in 'C'

My successful classroom lectures are now on UNIX. Study when and where you want by modem. A professional programmer and teacher will answer your questions. This is the easiest and fastest way to learn 'C'. Limited class size; call soon.

#### The McNamara Lectures

292 9th Ave., San Francisco, CA 94118  
(415) 751-2936 BBS 300/1200

## EMULATORS

### ANSIGRAF

One program emulates both Tektronix™ 4014 and DEC™ VT102. Separate virtual screens for texts and graphics. Xmodem file transfer protocol and full keyboard macros.

Only \$79.95

For more information write or call:

**Grafikon Ltd.** 301-937-3394  
P.O. Box 446, College Park, MD 20740

Inquiry 705.

## 65C02 EMULATOR FOR MACINTOSH

MAC-II emulates an Apple II with 128K of RAM 512K RAMDISK, 2 Superserial Printer and Modem Cards, 80 Column-card, Unidisk Drive Controller, 68000 Extension Card. True emulation, utilizes the ROMS directly from your Apple II (+E,EE). Runs Apple II 3.5 diskettes on 800K Mac drives. Comes with Unidos Transfer programs included. List Price: Dirs. \$149.95.

#### MEACOM

P.O. Box 272591, Houston, TX 77277  
713-526-5706

Inquiry 723.

## GRAPHICS HARDWARE

### HOUSTON INSTRUMENTS PLOTTERS

DMP 40/142 (1 Pen A-B-C-D-size) \$966/\$2577  
DMP-51/52/MP (C, D-size 1/4-Pen) \$3881/\$5031

#### DIGITIZERS

Summagraphics MM1201 complete \$434  
GITCO MD7-1212 complete \$802  
Hitachi HDG-1111B Tiger II w/stylus \$735  
Houston TG-1011 w/power & stylus \$670  
Orchid TurboEGA & NEC Multisync \$1220  
Arist 1 & Mitsubishi 10" monitor \$3113

Large corp & institutional PO's accepted O.A.C  
**ARDEN SYSTEMS, INC.** (213) 478-6707 ext.29  
12335 Santa Monica Bl #240 Los Angeles, CA 90025

## HARDWARE

### \$79 MONO/GRAPHIC/PRINTER BOARD

\* Hercules compatible \* 720 x 348 pixel  
\* Lotus 1-2-3 compatible \* 80 x 25 text  
\* Printer, Monitor port \* 1 year warranty  
\* Light pen port \* In stock delivery  
1 - \$99 2-9 \$89 10 - \$79

#### SUGAR INTERNATIONAL

12015 NE 8th Ste. 3, Bellevue, WA 98005  
(206) 462-9283, Mo-Sa, 9-6

Inquiry 783.

## EPROM/EEPROM PROG. \$250

Programs 2716-27512, 25xx and 68764/65 eproms via RS-232. Also 874x micros and 28xxA & 52Bxx EEPROMs. Automatic baud rate select, built in help menus, no personality modules!

#### 16 BIT I/O MODULE \$75

Low cost control via RS-232 Expands to 512!

#### INTELLITRONICS

P.O. Box 3283, Tustin, CA 92680  
(714) 669-0614

Inquiry 712.

### 8051, 8096, 68HC11, 68008

#### SINGLE BOARD COMPUTERS

We feature a series of single board computers for process control applications. Available as bare boards or assembled and tested. Optional EPROM resident System Monitors and BASIC interpreters are also available.

#### ALLEN SYSTEMS

2151 Fairfax Road, Columbus, OH 43221  
614-488-7122

Inquiry 855.

# THE BUYER'S MART

## HARDWARE

### POWERLINE GREMLINS?? POWER FAILURES??

The MEIRICK STANDBY POWER SYSTEM is the TOTAL SOLUTION to your powerline problems.  
240 watt system - \$385. 400 watt system - \$495.  
800 watt system - \$795

**MEIRICK Inc., POWER SYSTEMS DIV.**  
Box 298, Frisco, CO 80443 303-668-3251

Inquiry 724.

## HARDWARE

### IBM - TOSHIBA PRINTER INTERFACE

- all extended capabilities of the TOSHIBAS available
- bit mapped graphics supported
- Prints all IBM extended ASCII characters
- screen dumps in text and graphics
- escape sequences supported
- popular software supported directly
- "Sideways" and "Pyxel Visuals" support
- dealers welcome \$79.95 (\$2.50 S&H)

**Integrated Data Technologies, Inc.**  
4775 Bunchberry Lane, Colorado Springs, CO 80917  
303-597-5547 MC/VISA

Inquiry 780.

## HARDWARE ADD-ONS

### RS-232 RS-422

- Four Port RS-232 w/software . . . . . \$349<sup>00</sup>
- RS-422/485 Serial . . . . . \$149<sup>00</sup>
- RS-232/422 with 24 Parallel I/O . . . . . \$199<sup>00</sup>
- RS-422 Synchronous . . . . . \$299<sup>00</sup>

Call About Custom Designed Boards  
**Sealevel Systems Inc.**

P.O. Box 1808  
Easley, South Carolina 29641  
**(803) 855-1581**

Inquiry 754.

### MEGABYTES OF MEMORY

Lowest Prices Guaranteed in US. Dealer Inq. Invited  
Fully Populated 2MB Memory Boards  
**TALLTREE SYSTEMS - JRAM BOARDS**

|                        |       |                      |
|------------------------|-------|----------------------|
| JRAM 2                 | \$299 | OPEN 7               |
| JRAM 3 Aboveboard      | 389   | DAYS A WEEK          |
| JRAM AT                | 369   | M-F 9-6              |
| JRAM AT Aboveboard 419 |       | 9-5 9-6              |
| JDISKETTE              | 136   | VISA, MC, AE, CHOICE |
| JLASER 1               | 275   | 703-847-4740         |
| JMODULES               | CALL  | 800-842-2395         |

**Information and Technology Services, Inc.**

Inquiry 770.

### USED APPLES & IBM's

Commodore C-128 — \$225.00  
Laser 128 (new), Apple II+ and IIe — call  
PC-XT Clone — \$475.00

Motherboards & accessories — call  
We buy, sell, & horse-trade — Apple, IBM, & CBM.

**SHREVE SYSTEMS**  
845 Lark Ave., Shreveport, LA 71105  
318-865-6743 4-9 p.m. C.S.T. VISA/MC

Inquiry 756.

### FAST GRAPHICS COPROCESSOR

50,000 vector/second card for PC, XT or AT with CGA. Draws in hardware: zoom, pan, area fill, dithering, arcs etc. Turbo Pascal & MS-Fortran libraries. 14 day trial, 90 day warranty. 840x400 18 color. \$582. 640x200: \$378. Manual only: \$10, refundable.

**E-Heart Engineering**

18103 Sky Park South #D, Irvine, CA 92714  
**(714) 261-1725**

Inquiry 688.

### LOAD CELL INTERFACE

Connects weigh scales to any computer via serial RS232, 423 or 422. several units individually addressable from single computer port. Directly programmable in Basic - Demo program included. High accuracy 40,000 count. Options include NEMA-4, shunt cal. 4 load cell summing. Price \$599.

### SCALE-TRON INC.

P.O. Box 424, Lachine, Quebec, H8S 4C2  
**(514) 634-7032**

Inquiry 753.

### TANDY-EPSON

Our 10th year of DISCOUNTS  
**COMPUTERS & CELLULAR PHONES**  
Freight Prepaid. Save Tax  
Toll Free 800-231-3680

### MARYMAC INDUSTRIES, INC.

22511 Katy Fwy., Katy (Houston), TX 77450  
1-713-392-0747 Telex: 774132

Inquiry 722.

### 640K MotherBoard UPGRADE

640K memory without using an expansion slot! Allows easy insertion of 256k chips on the system board. 100% compatible. 30 day \$3 back guarantee. Compaq Portable & plus: \$29/\$99 with memory. IBM-XT, 3270 & Portable: \$39/\$109. IBM-PC: \$59/\$129. \$4 s/h. Site discount. Dealers welcome.

### ARISTO

16811 El Camino #213-D, Houston, TX 77058  
**713/480-6288 800/3ARISTO**

Inquiry 650.

**EPSON QX-16** — A complete computer system  
512K - 2 Drive - Monitor - Keyboard - PP - SP \$500 of FREE software - Vedocs2 - CPM - MS - DOS

List \$2700 Your Cost **\$895**

### OKIDATA-93

150 cps - Wide Carriage with NLD

List \$900 Your Cost **\$379**

**Electrified Discounters (203) 937-0106**

996 Orange Ave., P.O. Box 151, West Haven, CT 06518

Inquiry 692.

### 68020 COMPUTERS

Up to 14.5 Mbyte RAM, 256K ROM, 30 users, DMA floppy and SASI (SCSI), calendar/clock w/bat backup, timer, real time multi-tasking, multi-user op. sys., basic, assembler, screen editors, spreadsheet. Fits PC type cabinet Mem. Prot. option, more.

From **\$2195.00.**

Other 68000 computer systems from **\$995.00.**

### AAA Chicago Computer Center

120 Chestnut Lane - Wheeling, IL 60090

**(312) 458-0450**

Inquiry 650.

## HARDWARE/BLDG. CONTROL

### POWERLINE MODEM

**CASH REGISTERS, ELECTRONIC SIGNS, PC'S communicate over POWERLINE**  
RS232C, GE/EIA Consumer Electronic Bus Protocol. Hayes Compatible, 64,000 units on network, Data Compression, 1000 baud (HOMENET spec), 40 HOMENET commands, User Programmable Client Layer \$385.

**AISI RESEARCH CORPORATION**  
Discovery Park, University of Victoria 3771A Haro Rd.  
Victoria BC CANADA V8W 2Y2  
**(604) 477-1415**

Inquiry 653.

### SANYO 550/555 USERS

TURBO BOARD-7.2 MHZ . . . . . \$ 95.00

20 MEG EXTERNAL HARD DISK SYSTEM . . . . . \$749.85

VIDEO BOARD . . . . . \$125.00

HARD DISK CONTROLLER (ST-506 COMPATIBLE)\$249.95

IBM BOARD ADAPTOR . . . . . \$ 49.95

768 MEM. CLK. & EXPANSION BD-

(FREE RAMDISK, SPOOLER, & SOFTVIDEO-RUNS

IBM PROGRAMS) . . . . . \$199.95

### TAMPA BAY DIGITAL

1807 Gulf-to-Bay Blvd., Clearwater, FL 33575

**813-443-7049**

Inquiry 766.

### PC WHOLESALE CENTER

#### F.C.C. APPROVED BASIC KIT

\* 640K Mother Board (OK) **\$94.00**

\* 5150 Keyboard Board **\$48.00**

\* 150W Power Supply **\$56.00**

\* Case **\$34.00**

ALL FOR **\$230.00**, CALL FOR OTHER ADD-ON CARD.

### SANFORD INC.

10413 Rockley Rd., Houston, TX 77099

**(713) 879-0068**

Inquiry 762.

## INFORMATION SERVICES

### TURBO S.I.X.

The Turbo Pascal Software Information eXchange offers its members megabytes of Turbo Pascal code for only \$8 per diskette. Also a monthly newsletter. Send \$1.95 for the TURBO S.I.X. catalog. Deductible from the \$19.95 membership fee when you join. MC/VISA.

### TURBO S.I.X.

P.O. Box 8373, Dept B2, Waco, Texas 76710  
3101 Mitchell, Waco, TX **(817) 753-2182**

Inquiry 770.

## HARDWARE ADD-ONS

### APPLE COMPATIBLE PRODUCTS

16e RAM/80 Column Boards, 64K \$39, 256K \$109.  
512K \$139. 1.0MEG \$238, 256K-1.0MEG includes XMe PLUSWORKS Shw. II+ 80 Col Bd \$49. 16e Keypad w/16 Keys \$39. II+/e Cooling Fan w/surge protect \$29.95. Add \$3 Shipping. Write for complete list.

### NEXO DISTRIBUTION

914 East 8th St., Ste. 109, National City, CA 92050

**(619) 474-3328**

Inquiry 733.

## MULTIUSERS

### COMPLETE BUSINESS SYSTEMS

#### UP TO 50% . . . OFF

#### WE OFFER MORE THAN BOXES

Specializing in AT&T Single & Multiuser Systems

AT&T COMPAQ IBM

PRINTERS MONITORS SOFTWARE

PRICE AND AVAILABILITY SUBJECT TO CHANGE

**FCG Information Systems Inc.**

11033 E. ROSECRANS, UNIT E, NORWALK, CA 90650

**213-929-6891 800-523-1789**

Inquiry 688.

### XT/AT COMPATIBLE HARDWARE

ATI-1000 AT 8MHz M/B w/840KB\* **\$620.**

ATI-1000-10 AT 10MHz M/B w 1MB\* **\$40.**

ACS-1000 XT Turbo M/B\* w/512KB/8MHz **\$95.**

clock calendar 2 serial, 1 parallel port

279.

MITSUBISHI CGA MONITOR **\$79.**

MITSUBISHI EGA MONITOR **\$99.**

MAXI SWITCH XT/AT Keyboard **\$9.**

TEAC 360K Floppy Drive **\$2.**

ZUCKER MonoGraphic Card **\$8.**

\*American Made M/B

### PC HOUSE

3706 Realty Rd., Suite 200, Dallas, TX 75244 (214) 241-5814

Inquiry 652.



# THE BUYER'S MART

## PRINTING

### DO YOU NEED QUALITY COMMERCIAL PRINTING?

Call Eli's. Helping people since 1948.  
Ask for Rick or Chuck

1-800-228-2007  
1-402-342-7008

1231 South 14th Street  
Omaha, Nebraska 68108

Inquiry 694.

## PROGRAM GENERATORS

### WINDOW.LIB \$99.

An easy to use complete windowing system for programmers and writing in

- BASIC IBM, M-S, CB86    • C LATTICE, M-S
- COBOL M-S, RMF        • PASCAL M-S, TURBO
- FORTRAN M-S, RMF.

Window editor included. Create callable pop-up menus, help screens. The line selector features auto reverse highlighting and cursor control. No royalties. Ask about our BIOS/DOOS LIB/VISA/MC

**GLESCO ENGINEERING (312) 392-2492**  
3920 Ridge Ave., Arlington Hts., IL 60004

Inquiry 703.

## PUBLIC DOMAIN

### ► SOFTWARE FOR PENNIES ◀

GET BEST AND LATEST PC-DOS, CP/M-80 AND CP/M-86 PUBLIC DOMAIN PROGRAMS FOR BUSINESS, PERSONAL, EDUCATION, SOFTWARE DEVELOPMENT, MODELING, SCIENCE, AND MORE. AT LOW COST OF COPYING 3-1/2, 5-1/4 AND 8" DISK FORMATS ARE SUPPORTED SEND \$5.00 FOR CATALOG

**MULTIPATH, INC.**  
Box 396, Montville, NJ 07045  
(201) 675-5880

Inquiry 731.

### THE BEST OF THE BEST!

Public Domain & User Supported Software for IBM PC or compatible Word Processing, Database, Spreadsheets, Utilities, Games, Accounting, etc! 50 disk package \$205.00, or rent 2 wks. \$75.00. Info & Super Sampler Disk \$6.50. Deluxe Word Processor \$6.50, both \$12.00. MCA/VISA

**BLUE CIRCLE GROUP, INC.**  
Box 23502, Minneapolis, MN 55423  
(612) 823-4111

Inquiry 664

### \$4.50 IBM PC Software

490 disks: \$4.50 ea.    1-2-3 WKS, 6 disks \$36.  
Arcade games, 4 disks \$18.    Directory, 2 disks \$9.  
Utilities, 4 disks \$18.    "G" routines, 6 disks \$27.  
Turbo Pascal routines, 6 disks \$36.  
Unprotect software, 4 disks \$18.  
Catalog \$1.99. Add \$4 S&H MCA/Visa accepted.

### The Computer Room

P.O. Box 1596, Dept. 102, Gordonsville, VA 22942  
703/832-3341 (M-F 10-5)

Inquiry 678

### ALMOST FREE

The best of the Public Domain and User-Supported Software  
The Best Selling: (Disk #87) QMODEM — The Powerful and Fast Communication Program (Disk #20) GAMES — Full of Excellent Color Games programs (Disk #42) INVENT — A Complete Professional Inventory Package (Disk #85) PC-WRITE — The Last Version 2.6 of this Word Processing (Disk #38440) FORTH — The Full Language implementation (2 disks) (Disk #45) DISKCAT — The Best around Disk Cataloging Program Only \$6.99 each disk plus \$3.50 for Shipping for any quantity Order or Write for Free Catalog to

**MICRO-BOARDS (201) 881-7238**  
P.O. Box 424, Elmwood Park, NJ 07407

Inquiry 777

## SOFTWARE/ACCOUNTING

### FINANCE MANAGER II - General Ledger

A small business/personal finance package for IBM PC Menu driven, easy setup, complete reports, budget, graphs, double entry, simple inputs, demo files Tracks income, expenses, assets, liabilities, net worth. Evaluation copy with manual on disk for only \$10. Registered copy with printed manual \$85. Visa/MC/Amex.

### Hooper International

Dept. B, P.O. Box 8009, Vancouver, WA 98668-6009  
(206) 258-8361

Inquiry 707.

### TIME & BILLING \$99 JOB COST OPTION \$50

Try It, You'll Like It With Our 30 Day Money-Back Trial Great for contractors, accountants, architects, engineers, attorneys—anyone who needs to bill for service work and expenses. Very flexible and very easy to learn to use. Prints your statements, many reports. Job cost option includes job estimating, job summary, job detail, and more! For IBM PC and compatibles Order with VISA, MC, COD or send for free comprehensive brochure.

**Accounting Systems (919) 467-3428**  
POB 5085, Cary, NC 27511  
**CALL 1-(800)-824-7888 op. 138**

Inquiry 651.

## SOFTWARE/BUSINESS

### ► FINANCIAL CALCULATOR ◀

Memory resident calculator performs compound interest, NPV, IRR, bonds, depreciation. Prints financial schedules. Allows importing/exporting of data. Includes all HP-12C functions plus more. Introductory price \$49.95 plus \$3 s/h; after 9/1/86, \$69.95.

### K SOFTWARE HOUSE, INC.

Rt. 2, Box 8381 Unionville, TN 37180  
(615) 294-5090

Inquiry 717.

### OFFICE AUTOMATION SOFTWARE

Order Entry, Inventory \$49.95 each Independent or interactive. Fast, accurate Database sizes: 150 to 1000 Monitor up to 15 wks. Other configs avail. Order acknowledgment forms, inventory listings, & reorder level listings printed Min. req: IBM PC or compatible, 1 DSDD 360K drive, 128K RAM memory, DOS 2.10 or later. MCA/VISA, free shipping.

### FutureSoft (216) 753-1338

P.O. Box 23005, Cuyahoga Falls, OH 44223-1100

Inquiry 700.

### dFELLER Inventory

Business inventory programs written in modifiable dBASE source code.

dFELLER Inventory \$150.00  
Requires dBASE II or III, PC-DOS/CPM  
dFELLER Plus \$200.00  
with History and Purchase Orders  
Requires dBASE III or dBASE III Plus

### Feller Associates

550 CR PPA, Route 3, Ishpeming, MI 49849  
(906) 486-6024

Inquiry 696.

### TPRO88 - ROUTE FINDER

A powerful interactive system for finding routes on transportation networks w/up to 512 nodes and 16K links TPRO88 can find the shortest path between two nodes, sequence up to 50 stops, compute minimum spanning trees and times/distances between all points. Req. IBM PC, 192K, graphics adapter. \$99 w/8087 support, user's guide, sample U.S. highway network VISA/MC.

**EASTERN SOFTWARE PRODUCTS, INC.**  
POB 15328, Alexandria, VA 22309  
(703) 548-5468

Inquiry 890.

## SOFTWARE/BUSINESS

### Info-Lion™ Relational DBMS

Outstanding data entry & validation. Powerful query. Password security. Easy to use, online help. Much more! For MS/PC-DOS systems. Only \$189.95 VISA/MC

Remember, go with the lion . . .  
because it's a jungle out there!

### Morgan Software Inc.

414 Valley Ave., Wilmerding, PA 15148  
(412) 824-0458

Inquiry 730.

### PC-File III™ Version 4

Search, sort, browse, global changes, macros, mailing labels, format reports with selection & calculations, sub-totals, totals, averages, encryption. Exchange data with 1-2-3, WORD, WordStar. Over 190,000 users. \$58.95 + \$5 s/h. For IBM PC.

### ButtonWare, Inc.

P.O. Box 5786, Bellevue, WA 98006  
**1-800-J-BUTTON**

Inquiry 668.

### PC-File/R™

All the power of PC-File III plus: Relational link to other databases, integrated letter writing & mail-merge, context sensitive pop-up help windows. New binary search retrieves data hundreds of times faster. \$149.95 + \$5 s/h.

### ButtonWare, Inc.

P.O. Box 5786, Bellevue, WA 98006  
**1-800-J-BUTTON**

Inquiry 670.

### The Andsor Collection™

Unique concept, creates complete, self-contained, window-based data management environment, in one DOS file. Simplifies everything. Combines functions to create your own solutions in any application: calculations, database management, modeling, text processing, charts, data analysis, statistics, reports, labels, forms, presentations, mail-merge, etc. Simple enough for a PCjr, sophisticated enough for a PC AT.

SEE ALSO THE AD BELOW

Inquiry 670.

### The Andsor Collection™

From simple calculations, files, inquiries to complex models, data structures, reports. Superb 400 page hard-cover manual, with many examples. US \$95 + \$5 s/h. 60-day money-back guarantee. Visa/MC/AmEx/Disk/MOCOD. Call or write now to order IBM PC/XT/AT/PCjr, 128K+ one drive or hard disk, monochrome and/or color, DOS 2.0+. Not copy-protected.

### ANSOR RESEARCH INC.

181 University Avenue., Suite 1202,  
Toronto, Ontario, Canada M5H 3M7  
(416) 364-8423

Inquiry 657.

### PC-Write™ Shareware

Fast, powerful word processor/text editor for IBM PC. New Version 2.6 with auto reformat, optional menus, on-screen help, laser printer support, new expanded manual, Mailmerge, split screen, ASCII files, macros. All software, tutorial/guide on diskette, \$10. OK to copy. Register for full manual, support \$75. 90-day money-back guarantee.

**Quicksoft (206) 282-0452 Visa/MC**  
219 First N. #224J, Seattle, WA 98109

Inquiry 748.

# THE BUYER'S MART

## SOFTWARE/BUSINESS

**GREAT SOFTWARE, CHEAP!**  
Absolutely Smashing User Supported Software \$4.95 per disk. PC-Outline, PC-Write, DOSomatic, Commercial Unprotect, File Express, Cheap Assembler, PC-Desk, utilities galore, many more. Money-back guarantee. IBM PC, PC Jr, or compatibles. **FREE CATALOG.**

**PLUS SOFTWARE**  
33495 Del Obispo, Suite 160 M,  
Dana Point, CA 92629

Inquiry 712.

**"THE CLERK" RETAIL POINT OF SALE**  
New software gives your small-medium business the same advantages the "Big Guys" have. Automatic sales slip, invoices, inventory control, discounts, taxes, reports, and much more! Indispensable management tool! Demo disk \$4.95 (refundable). Regular \$179.95 — Sale Price \$99.95.  
1-800-346-3026 ext.958  
**WDR SALES CO.**  
9604 BELMONT, KANSAS CITY, MO. 64134  
Dealer inquiries welcome.

Inquiry 772.

**SAVE LEGAL FEES**  
157 time tested legal forms on disk, complete with menu driven system and editing and printing capability. Free copy of PC-Write word processor included. Forms written by a noted attorney and applicable nation-wide. \$129.95 plus \$7.50 shipping and handling.  
**LegalEase™ HDG Software, Inc.**  
54 Whitney St., Sherborn, MA 01770  
617-851-1881

Inquiry 708.

## SOFTWARE/CHURCH

**Church Package**  
Parishoner Time, Talent and Treasure System program is written in modifiable dBASE source code.  
• Contributions • Disbursements • Ledger  
• Names with mailing labels  
• Personal information database  
Requires dBASE II or III. PC-DOS/CPM-80 \$200.  
**Feller Associates**  
550 CR PPA, Route 3, Ishpeming, MI 49849  
(906) 488-6024

Inquiry 687.

**ROMAR CHURCH SYSTEMS™**  
Membership-61 fields plus alternate address, labels, letters, reports any field(s). Offering-256 funds, optional pledge, statements; post to 255 x/year. Finance-G/L with budget, up to 500 sub-totals & 99 dep'ts. month & YTD reports anytime for any month. Size 2000 people/poppy; 25000/10 meg. Ad too short! Write!  
**Romar Church Systems, Attn: BMB**  
P.O. Box 4211, Elkhart, IN 46514  
(219) 262-2188

Inquiry 781

## SOFTWARE/EDUCATION

**THE DGI WORDSEARCH PUZZLE**  
A great teaching aid to build vocabulary, improve spelling, or for your own enjoyment. Up to forty words can be used. Size can be 20 x 20 or 20 x 40 characters. Each puzzle has a unique solution. If you print the same puzzle twice each solution is different. THE DGI NUMBERSEARCH is also included. For the APPLE II or IBM computers \$36.  
**DECISION GRAPHICS, INC.**  
P.O. Box 2776-B, Littleton, Colorado 80161  
Phone (303) 796-0341

Inquiry 686.

## SOFTWARE/GENERAL

**MicroGANTT®**  
Control your project! You describe the work, MicroGANTT calculates the schedule and budget. Optimize the schedule interactively. Customize the reports. Sub-tasking, fixed and variable costs, multi-project resource allocation, unlimited size and scope. GANTT, PERT, CPM, DOD-7000. Call or write for free catalog.

**Earth Data Corporation**  
P.O. Box 13168, Richmond, VA 23225  
(804) 231-0300

Inquiry 688

**NEW INTEGRATED ENVIRONMENT  
AI FOR THE IBM PC**  
TOP8I IS A FULL VERSION OF OP8S WHICH RUNS UNDER MS-DOS, UNIX OR CPM. A FAST, EFFICIENT EXPERT SYSTEM DEVELOPMENT TOOL.  
PROTOTYPING: \$125 PRODUCTION: \$280  
PROFESSIONAL \$375 SHIPPING, ADD \$5  
**DYNAMIC MASTER SYSTEMS**  
POB 568458, Atlanta, GA 30356  
(404) 565-0771 Telex #282923

Inquiry 687.

**CYBER\_CAT catalog \$24.95**  
Somewhere among your 200 disks is a file you used 2 years ago. Cyber\_Cat will find it in seconds. Cyber\_Cat will label, index & catalog your disks. Including your hard disk and all subdirectories. DOS 2.0 or later, 2 DRV, PC/XT compatible or generic. VISA/MC/CK F.I. Res. add 6% tax. Postpaid in U.S.  
**CYBER\_WARE Corp.**  
4411 Bearidge Rd. Suite 291, Sarasota, FL 33563  
1-800-237-8400 x86 (813) 371-2157  
In FL 1-800-282-2469 x86

Inquiry 682.

**BAN-TASTIC™**  
Easily create, print & store beautiful BANNERS with multiple text styles & sizes on IBM PC. Features: unlimited banner length, sizes from 2 in. to 12 in., normal/reverse chars & more.  
Only \$19.95 + \$5 s/h — MC/VISA  
**PERPETUAL INFORMATION SYSTEMS**  
(702) 827-2424  
5290 Neil Road, Suite 215, Reno, Nevada 89502

Inquiry 736.

**MacMoney™ Intro: \$74.95 + \$3 s/h**  
This easy to use checkbook & financial planner, designed especially for the Macintosh™, is the next step up. It lets you keep track of all your financial transactions. Plus: transfers data to other programs; prints checks, reports, graphs; does loan planning; & more. 512K Mac req.; HFS compatible.  
**Survivor Software Ltd.**  
11222 La Cienega Blvd., Suite 450C  
Inglewood, CA 90304  
(213) 410-9527

Inquiry 768.

## SOFTWARE/GRAPHICS

**MAPIT**  
Make your own MAPS!!  
Simple to produce maps with your data. Includes most country and state outlines. Any printer or HP plotter.  
Only \$65 for MS-DOS or PC-DOS  
US County Outlines available for \$95.  
**QSC** Box 776, East Lansing, MI 48823  
(517) 641-4428

Inquiry 747.

## SOFTWARE/GRAPHICS

**SCIENTIFIC PLOTTING**  
Are traditional graphics packages not meeting your requirements for engineering/scientific plotting with your HP plotter? **GRAFIT 3.4** is the answer—all the features you want, and more. Only \$90 + \$5 s/h. Send for details.

**JAYAR Systems**  
P.O. Box 2685, Station "A"  
Sudbury, Ontario, Canada P3A 5J3  
(705) 522-2230

Inquiry 715.

**GRAPHICS PRINTER SUPPORT**  
AT LAST! Use the PrtSc key to make quality scaled B&W or color reproductions of your display on any dot matrix, inkjet, or laser printer. **GRAFPLUS** supports all versions of PC or MS-DOS with IBM, Tecmar, and Hercules graphics boards. \$59.95.  
**Jewell Technologies, Inc.**  
4302 SW Alaska St., Suite 207, Seattle, WA 98118  
(206) 937-1081

Inquiry 716.

**FORTRAN PROGRAMMER?**  
Now you can call 2-D and 3-D graphics routines within your FORTRAN program.  
**GRAFMATIC:** 75 callable routines for screen output. \$135.  
**PLOTMATIC:** Pen plotter driver. \$195.  
For the IBM PC, XT, AT and compatibles. We support a variety of compilers, graphics boards and plotters.  
**MICROCOMPATIBLES**  
301 Prelude Drive, Dept. B  
Silver Spring, MD 20901  
(301) 593-0663

Inquiry 727.

**3D TURBO GRAPHICS**  
ViewPoint quickly and easily generates perspective or parallel plots from an arbitrary view point on a variety of devices: IBM Mono & Color, Epson, Tektronix, Calcomp and HP. Hatched effect indicates hidden lines. Simple application integration: CAD, architecture, chemistry and engineering. Turbo Pascal source included. Only \$49 US. Call or write for more info.  
**Berkeley Computer Software Ltd.**  
247 Parklawn Circle, S.E.  
Calgary, Alberta, Canada T2J 4M4  
(403) 265-4111

Inquiry 692.

**3D INTERACTIVE GRAPHICS**  
Imagine 2D and 3D graphics in real time at \$24.95. Keyboard support, construct images, create sound! Required IBM PC/XT/AT/Compatibles, DOS 2.X, 3.X, CGA Support 5067/80287. MS or IBM Fortran, Basic, Pascal Demo \$5 apply toward purchase. Please add \$3 S/H. In TX add 6.125% VISA/MC/CHECK/MO  
**Filterex Research, Inc.**  
P.O. Box 820425, Houston, Texas 77282-0425  
(713) 656-5747

Inquiry 698.

**FORTRAN GRAPHICS LIBRARY**  
**MicroGlyph/SciPlot™** provides (MS/IBM Pro/F77L) FORTRAN graphics on any IBM PC/XT/AT. Features lin/fog axes, labels, Hershey fonts, hi res plots on (IBM/Epson/Apple LaserWriter) printers, or graphics on (IBM color\*EGA/Hercules\*mono/Tecmar\*GM) displays. \$69.95 plus \$3.00 shipping.  
**MicroGlyph Systems**  
P.O. Box 188, Lexington, MA 02173

Inquiry 729.

# THE BUYER'S MART

## SOFTWARE/GRAPHICS

**TI PRO + TURBO + GRAPHICS**  
UNLEASH YOUR TI PRO WITH TURBO 2.0 or 3.0 + TIGRAPHICS, TURTLEGRAPHICS, MUSIC, SCREEN & CURSOR CONTROLS & more routines than IBM TURBO. Use BASIC PICS w/o reprog. Convert IBM code to TI PRO. Source & doc included. TIGRAPH: \$88.95, + TURBO \$148.95, + TURBO 8087 \$179.95. SWITCH TO TURBO NOW!!!

**ProWARE, Inc.**  
1023 SE 36th Ave., Portland, OR 97214  
VISA/MC/CHECK 7AM-7PM MON-FRI  
(503) 233-4465

Inquiry 744.

## SOFTWARE/LANGUAGES

**Symbolic Profiler for Turbo Pascal**  
Find out where your Turbo Pascal program is spending all its time. Only \$49 plus S&H: \$3 US/Canada, \$7 Europe.

**KYDOR COMPUTER SYSTEMS**  
1701 Greenville Avenue, Suite 505  
Richardson, Texas 75081  
(214) 659-1888

Inquiry 778.

**FINALLY!**  
**A Subroutine Library for Compiled BASIC**  
Load directives into arrays, WINDOWING, Graphics, pie and bar charts, 150 more routines to add power to Microsoft QuickBASIC or IBM BASIC Compiler 2.0 30 Day Money-Back Guarantee. VISA/MC/Check/MO FINALLY! is only \$99.00 + \$4.00 S&H

**KOMPUTERWERK, INC.**  
851 Parkview Blvd., Pottsville, PA 15215  
(412) 782-0384

Inquiry 778.

**HYPER C COMPILERS/TOOLS**

|                              |        |
|------------------------------|--------|
| Apple II ProDos Professional | 889.95 |
| Macintosh                    | 189.95 |

Macintosh programming tools with complete source code:  
Assembler & Linker 65.00  
Triton Preprocessor 50.00  
Multi-Window Text Editor 50.00  
Macro Preprocessor 50.00

For further information/literature contact:  
**WSM GROUP, INC. (602) 298-7910**  
P.O. Box 32005, TUCSON, AZ 85751

Inquiry 778.

**68020**  
Motorola compatible macro Assembler Package features linker, object librarian, symbol report generator with cross reference. Produces S-records and ROMable code. For CP/M-68K, MS-DOS \$750. Portable Source in C \$3500. AVAILABLE NOW.

**Quelo, Inc.**  
2464 33rd Ave. W. Suite 173, Seattle, WA 98199  
206/285-2528 telex 910-333-8171

Inquiry 748.

**MACINTOSH DEVELOPERS**  
Dramatically decrease development time. Elegantly crafted compiled library routines for easy implementation of Mac interface. Graphics scrolling and printing, text editing, zooming windows and much more!

**PASCAL EXTENDER\* \$89.95**  
**C EXTENDER\* \$129.95**

**INVENTION SOFTWARE CORPORATION**  
P.O. Box 3168, Ann Arbor, MI 48106  
313-996-8108

Inquiry 714.

## SOFTWARE/LANGUAGES

**EXPERT SYSTEM LANGUAGE**  
If you can use a spreadsheet, you can use KNOWOL, the Knowledge Oriented Language, to guide people in solving problems.

KNOWOL + (Complete) ..... \$99.95  
KNOWOL (Introductory) ..... \$39.95

**Intelligent Machine Company**  
1907 Red Oak Circle, New Port Richey, FL 33553  
(813) 844-3262

Inquiry 711.

**SCREEN PROGRAM GENERATOR**  
SPG I creates BASIC program code quickly and easily. Design your screen directly and SPG I will generate the BASIC program code to handle the display and input of data. Controls use of color, editing, graphics, cursor movement and function keys. Generated code easy to modify / merge.

IBM PC & compatibles 128K  
\$75 + \$3.00 S&H (CA + tax)

**Treeboard Software**  
5901 Warner Avenue, Suite 428  
Huntington Beach, CA 92649  
(714) 840-6939

Inquiry 788.

**Minnesota SNOBOL4 Language**  
Powerful string & data handling facilities. Interpreter compatible with mainframe SNOBOL4. 32K strings, 32 bit integers, 8087 for float & large memory model. Sample pgms include ELIZA. For > 128K IBM PC & DOS or equivalent. Definitive "green" book by Griswold et al available.

Guide + 5 1/4" SSDD diskette ..... \$44.95  
Guide + diskette + "green" book ..... \$59.95  
"Green" book only ..... \$28.95

Postpaid in USA. In NY add tax. VISA/MC (914) 271-5855

**BERTIS INTERNATIONAL**  
POB 441, Millwood, NY 10546

Inquiry 663.

**Philon FAST/Compilers**  
Philon FAST/BASIC M, Philon FAST/COBOL, Philon FAST/C, and Philon FAST/FORTRAN are a family of true compilers that provide extremely fast execution of compiled code. Features include state-of-the-art code optimization, support of single and multi-user systems, and powerful runtime libraries. Available for 68000/UNIX systems. Alan 520ST, Apple Macintosh and many others. A BASIC interpreter is also available for the Alan 520ST

**Philon, Inc.**  
641 Ave. of the Americas, New York, NY 10011  
212-907-0303

Inquiry 740.

## SOFTWARE/SCIENTIFIC

**CROSS ASSEMBLERS for VAX VMS and PC/MS DOS**  
**New Low Prices**

Relocatable Macro Cross Assemblers, Linkers, Librarians  
Targeted to almost all Microprocessors

**ENERTEC, INC.**  
BOX 1312, Lansdale, PA 18448  
215-362-0985 MC/VISA

Inquiry 695.

**TURBO PASCAL TOOLS**  
Quinn-Curtis offers a family of Science, Engineering, Data Acquisition, and DOS/BIOS Tools for use with Turbo Pascal. All source code provided.

IPC-TP-008 Science and Engineering Tools \$69.95  
IPC-TP-008 Megabyte Data Acquisition Tools \$94.95  
IPC-TP-017 DOS/BIOS Tools \$69.95

**Quinn-Curtis**  
49 Highland Ave., Needham, MA 02194  
(617) 444-7721

Inquiry 749.

## SOFTWARE/SCIENTIFIC

**POP-UP HP-41 EMULATOR**  
Graphically presents HP-41 keypad and unique view of stack and registers. Binary, Octal, Decimal, Hexadecimal display and input. 12 digit precision; 500 accessible registers. For IBM PC/XT/AT and close compatibles. Standard version \$89.95; 8087 version \$79.95 (\$4 shipping and handling, plus sales tax in Calif.)

**ECLIPSE LOGIC INC.**  
P.O. Box 2003, Huntington Park, CA 90255-1303  
(213) 569-6020

Inquiry 691.

**MATRIX 100**  
Perform multiple regression, solve simultaneous equations, invert matrices, etc. in BASIC or Fortran. Very user friendly numerically very powerful and very easy to use — **ORMS Today 2/85** "Stanford Business Software deserves congratulations" — **PC Mag, 5/14/85** Price \$60, 8087 support \$125, compiler support \$250, Fortran library \$175 (\$4 s&h)

**STANFORD BUSINESS SOFTWARE, INC.**  
2572 Bayshore Parkway, Ste. 304  
Mountain View, CA 94043  
To Order Call (415) 424-8499

Inquiry 780.

**HP-PC HYPER-CALCULATOR**  
Pop-up MS-DOS programmable scientific calculator emulates HP-11C. Hex/oct/bin arithmetic, two-way data transfer, program & data disk storage, HELP, alpha prompts, 100 registers, 1000 program steps. Free 8087 version, utility programs. \$39.95 + \$1 s&h.

**SUNDERLAND SOFTWARE ASSOCIATES**  
P.O. BOX 7000-64  
REDONDO BEACH, CA 90277  
CALL TOLL FREE 800-826-2828 ext. 502

Inquiry 784.

**Affordable Engineering Software**  
CALL OR WRITE FOR FREE CATALOG

Circuit Analysis • Root Locus • Thermal Analysis • Plotter Drivers • Graphics • Signal Processing • Filter Design • Report Proofreader • Transfer Function Analysis.

**BV Engineering**  
2200 Business Way Suite 207, Riverside, CA 92501  
(714) 781-0252 VISA/MC

Inquiry 872.

**ENGINEERING SOFTWARE WRITTEN BY ENGINEERS FOR ENGINEERS**  
Highest power per dollar. Highest power per K of memory. Satisfaction guaranteed.

Electronic Circuit Analysis ..... \$450.  
EC-ACE ..... \$95.

**TATUM LABS**  
33 Main St., Newtown, CT 06470  
(203) 426-2184

Inquiry 767.

**FREE SOFTWARE GUIDE**  
600 Plus programs covering applications in biology, chemistry, geology, geophysics, mathematics, instrument/process monitoring and control, chemical, civil, electrical, mechanical, petroleum engineering. Also graphics, AI, DBMS, languages and utilities.

**ALPHA Applied Research**  
2355 McLean Blvd., Eugene, OR 97405  
(503) 485-8841

Inquiry 656.

# THE BUYER'S MART

## SOFTWARE/SCIENTIFIC

### System Simulations

Micro-C5MP emulates oControl & Servo Systems oRobotics oHigh Order Filters oChemical Processes oStress & Strain Graphical results in minutes, typically requiring 10-20 lines of input. Full IBM S380 C5MP compatibility. LSAP analyzes linear systems producing Bode, Nyquist, and Transient Response plots, and Root-Locus diagrams. Micro-C5MP is \$900, LSAP is \$450 for PC-DOS or MS-DOS systems.

Call (714) 581-7854

**California Scientific Software**  
25642 Hazelnut, El Toro, CA 92630

Inquiry 673.

### ORDINARY/PARTIAL DIFFERENTIAL EQN SOLVER

FOR THE IBM PC & COMPATIBLES

**MICROCOMPATIBLES INC.**

301 Prelude Dr., Silver Spring, MD 20901  
(301) 593-0683

Inquiry 728.

### Choose Your SCI. CALCULATOR

- \* RESICALC: Pop-Up Calculator with User Programmable functions. Intuitive. \$16
- \* COMPLEX: Pop-Up Calculator for Complex Numbers. Special & User Functions. \$25
- \* MATRIX: Linear Prog. Sys of Eqns. Program in Symbolic Expression. Macro Editor. \$60

**SOFTTECH INC.** 1-313-544-8544  
14840 LaBelle, Oak Park, MI 48237

Inquiry 757.

### Digital Filter Tutor \$375 Kalman Filter Tutor \$650

Practical hands-on training courses that run on the IBM PC. Learn how to specify, design, tune, implement, analyze, and test filters. FREE demo disk available.

**Engineering Tutorial Software**  
22338 Lull Street, Canoga Park, CA 91304  
(818) 716-0816

Inquiry 737.

## SOFTWARE/SORT

### OPT-TECH SORT/MERGE

Extremely fast Sort/Merge/Select utility. Run as an MS-DOS command or CALL as a subroutine. Supports most languages and filetypes including Btrieve and dBASE. Unlimited file sizes, multiple keys and much more! \$149.

(702) 588-3737

**Opt-Tech Data Processing**  
P.O. Box 678 - Zephyr Cove, NV 89448

Inquiry 735.

## SOFTWARE/SYSTEMS

### CPM-80 LIVES on your PC

CP/Mulator puts a 4mhz 8 bit CPM emulator in your IBM-PC for \$99. (\$3 s + h).

- A great 8 bit development system
- Saves expensive CPM-80 applications
- Increases PC speed 10% for 8088 programs
- Priced less than most software only products
- Uses no valuable board slots

#### Source Information

P.O. Box 2974, Warminster, PA 18974  
VISA Phone (215) 441-8178 M/C

Inquiry 761.

## SOFTWARE/TOOLS

### POWERFUL FILE MANAGEMENT

1 D T'S FileManager® for people serious about their systems. No kid stuff—only powerful managing tools. File sort, copy, move, delete, search & change attributes. Undo/redo and clear files.

EDLIN enhancer & batch mode clean up and more. Menu driven.

**\$34.95** (about 1/2 Norton's) M/C/VISA  
**INTEGRATED DATA TECHNOLOGY, INC.**  
4776 Bunchberry Lane, Colorado Springs, CO 80917  
ORDERS: 303-488-2583

Inquiry 781.

### METRICS FOR MANAGEMENT

ANALYZE reads your code & produces metrics on VOLUME, COMPLEXITY, PRODUCTIVITY & more! Management, QA/QC & Engineers gain valuable insight to scheduling, problem areas, testing, maintenance & compliance to standards. For IBM PC. Analyze FORTRAN & "C" \$495.00 + S/H. Add Ade for only \$200.00 more! M/C/VISA

#### AUTOMETRIC INC.

891 Elkridge Landing Rd. Suite 350, Luthincum, MD 21090  
(301) 858-4111

Inquiry 680.

### FORTRAN Addenda

Graphics, color text, keyboard control, and much more for PC/XT/AT FORTRAN Programs. Includes editing/pasting, tiling, fill, pull-down windows, and USER I/O EDITING! MDA thru EGA modes. 170 pg. manual & annotated samples. Sold as 2 libraries: each \$85, combined \$165.

#### IMPULSE Engineering

P.O. Box 3540  
San Francisco, CA 94119-3540  
(415)-788-4611

Inquiry 708.

### PC-Type™

Fast, compact, capable & easy! Help panels, hands-on tutorial, macros, multiple-line headings & footings. DOS path support, print spooling, block operations, etc. ASCII files. Install program allows customization. \$59.95 + \$5 s/h. For 128K IBM PC.

#### ButtonWare, Inc.

P.O. Box 5788, Bellevue, WA 98006  
1-800-J-BUTTON

Inquiry 671.

### 50:1 DATA COMPRESSION GUARANTEED

Correct\_Datamizer speeds up your computer system, cuts storage cost & has computer security built-in. Ask about CorrectForth. Specify computer. \$60.75 VISA/MC/AMEX/MO/CHK

#### Correct Software, Inc.

RR1 Box 140, Black Hawk, SD 57718  
605-787-5904

Inquiry 681.

### PRINTER CONTROL TOOLBOX

Library of 63 PROCEDURES with 39 WORKED OUT EXAMPLE PROGRAMS which show the correct performance of all toolbox procedures. All in PASCAL source code, unprotected, no royalties, not restricted to single cpu. PRICE: \$24.80.

#### Blue Hill Software Engineering

7018 Blue Hill Drive, San Jose, CA 95129  
(408) 725-8269

Inquiry 685.

## STATISTICS

### STATISTIX™

\$75 - Satisfaction guaranteed

A comprehensive, powerful, yet easy-to-use statistical analysis system for IBM PC/XT/AT's, Apple II's, and MS DOS machines. Clear 200p manual. Write for information.

#### NH ANALYTICAL SOFTWARE

801 West Iowa Ave., St. Paul, MN 55117  
(612) 488-4438

Inquiry 734.

### STATISTICS CATALOGI

If you need statistics for IBM PC or Apple II, call us and let our technical advisors help you find the statistics programs you need. Write or call now to get a FREE catalog of statistics and quality control software.

#### HUMAN SYSTEMS DYNAMICS

9010 Reseda Blvd., Ste. 222  
Nonhridge, CA 91324  
(800) 451-3030 (818) 993-8536 (CA)

Inquiry 708.

### NUMBER CRUNCHER STAT SYS

Menu-driven. Multiple & stepwise regression, ANOVA, time series, discriminant, cluster, and factor analysis, principal components, scatter plots, histograms, t-tests, contingency tables, non-parametrics. Import export data. Spreadsheet, sort, join, merge. \$79. IBM PC/Macintosh. Quantity discount.

#### NCSS-B

885 East 400 North, Kayville, UT 84037  
801-546-0445

Inquiry 732.

### RATS! Version 2.0

RATS, the best selling Econometric software package, now includes daily and weekly data, a new easier to use 500 page manual, and many advanced features. Use RATS for time-series and cross-section regression, including OLS, ARIMA, VAR, logit, and probit. IBM PC or compatible \$200. M/C/VISA. Call for brochure.

#### VAR Econometrics, Inc.

P.O. Box 19334, Minneapolis, MN 55419-0334  
(612) 822-9680

Inquiry 771.

### The Statistician

Includes: Multiple Regression (Stepwise, ridge, all subsets, backward elimination)

- Time series analysis • descriptive statistics
- transformations • survey research • nonparametrics
- X-Y plots • ANOVA • random samples • data base
- data editor • search & sort • hypothesis tests

For IBM, MS-DOS, XENIX, CPM, TRS-DOS  
**QUANT SYSTEMS** Please call  
TOLL FREE  
Box 828, Charleston, SC 29402 1-800-334-0854  
803-571-2825 (Ext. 814)

Inquiry 745.

## TYPESETTING

### DESKTOP PUBLISHING

Laser Printer composition software to drive Cordata L300 with 75 PS into \$495. With add 14 PS Lndscp fonts \$695. For Canon LBP-8 A2, NCR, or HP LaserJet+ with 41 PS Pnt or Lndscp into \$695. H & J, merge graphics, mix face & pt. size anywhere on any line, mult tab & col justification. Boxes & Rules.

#### Micro Print-X, Inc.

P.O. Box 581, Ballinger, TX 78821  
(815) 365-2343

Inquiry 728.

# THE BUYER'S MART

## UTILITIES

### STILL RIVER SHELL

Visual shell for PC/MS-DOS. Turns your directory into a menu. V1.33. Only \$9 for shareware diskette. \$35 manual & diskette.

**Bob Howard**

PO Box 57, Still River, MA 01487

617-456-3699

Inquiry 686.

## UTILITIES

### DEC RAINBOW USERS !!

B.E.V. SOFTWARE ANNOUNCES DR. DISK - The latest in DEC RAINBOW utilities!

- View or modify any sector on the diskette
- Restore deleted files
- Alter file attributes (HIDDEN SYSTEM, etc.)
- Learn RAINBOW MS-DOS disk organization
- Determine the extent of crashed disks

This tool has long been used by software developers in the field and is finally being offered to the public at a fraction of its commercial cost. Send \$29.95 to:

**Bill Norton - B.E.V. SOFTWARE**  
P.O. Box 139, Schenectady, NY 12301

Inquiry 681.

## UTILITIES

### PAL FOR SIDEKICK!

Personal Appointment Locator automatically shows coming appointments, searches your file, maintains to-do list, examines multiple files. Resident alarm too! Only \$45. Cheap at twice the price!

### PAL SOFTWARE

Ste. 12B 110 Green St., New York, NY 10012

212-925-1843

Inquiry 778.

### UNLOCK YOUR PRINTER'S POWER WITH THE PRESIDENT™

#### UNIVERSAL PRINTER INTERFACE

Lets you use ALL the features built into ANY PRINTER through ANY PROGRAM on IBM PC's or compat. Resident program uses only 3k of memory. Pop-up Help Recommended by Epson, Okidata, MicroPro, etc

**CMB3 Technologies \$99.00**

P.O. Box 3061, Walnut Creek, CA 94598  
(415) 930-0470

Inquiry 674

### CONCURRENT DOS BACKUP

BackPack™ runs like BACKUP/RESTORE and supports DOS and CP/M media as well as users. Backs up and restores up to 1000K/min. on an AT and 360K/min. on an XT. Supports release 4.1. Also available on CP/M-80 and CP/M plus. \$150.

**Bright Light, Inc.**

520 Fellowship Rd. #C301, Mt. Laurel, NJ 08054

(609) 778-0772

Inquiry 667.

### MEDIA MASTER PLUS

READ, WRITE, and FORMAT over 150 CP/M disks and run most CP/M-80 programs on your IBM PC! Two program package includes ZPIEM, a CP/M-80 emulator program that transforms your IBM PC into a 1-2 MHz CP/M 2.2 computer. \$59.95 + \$3.00 S/H (CA 6%)

**INTERSECTING CONCEPTS, INC.**

4573 Heatherglan Ct., Ste. 10

Moorpark, CA 93021

(805) 529-5073

Inquiry 713.

### RAMbak or WARP-TEN - 9.95

RAMbak automates the saving of new or changed RAM disk files to floppy disks and/or hard disk subdirectories. WARP-TEN is a programmable disk cache. PC, XT, AT, compatibles with 256K DOS 2.0+. Introductory price is only 9.95 each. (MN Res. + 6%).

**Software Brewing Company**

P.O. Box 12094, St. Paul, MN 55112

612-636-2727

Inquiry 758.

### BTrees with C Source

These are powerful, portable, dependable file utility libraries. Thousands of programmers worldwide rely on our quality code. All source code included, no royalty fees, works with any K&R compatible C compiler.

• Btree only \$75.00 • ISAM only \$40.00 additional.

**SOFTFOCUS**

1343 Stanbury Dr., Oakville, Ontario, Canada L6L 2J5

(416) 825-0903

Inquiry 759

### COPYWRITE

CopyWrite backs up hundreds of the most popular programs for the IBM PC. CopyWrite is revised monthly to keep up with the latest in copy protection, and comes with a trade-in offer. It needs an IBM AT, XT, or PC, 128K and one disk drive, but can use more memory or another drive. \$50 US. Check/Credit Cards.

**QUAID SOFTWARE LIMITED**

45 Charles St. E. 3rd Fl.

Toronto, Ontario, Canada M4Y 1S2

(416) 961-8243

Inquiry 713.

### SOURCE CODE LIBRARIAN & REVISION CONTROL SYSTEM

TUIB™ keeps ALL versions of your program in ONE compact library file, even with hundreds of revisions.

- 5 times faster than SCCS • LAN compatible
- Free public domain MAKE (with source) by L. Dyer

MS/PC-DOS 2.x & 3.x. \$99.95 + \$3 S&H. VISA/MC

**BURTON SYSTEMS SOFTWARE**

POB 4158, Cary, NC 27511

(919) 469-3068

Inquiry 688.

### PADLOCK/PADLOCK II DISKS

PADLOCK furnishes the user with a method for providing protection against unauthorized duplication from DOS commands \$99. PADLOCK II disks come preformatted with finger-print and serialization. PADLOCK II disks offer superior protection. Ask about our HARD DISK protection with uninstall capability. MC/VISA

**GLENCO ENGINEERING**

3920 Ridge Ave., Arlington Hts., IL 60004

(312) 392-2492

Inquiry 704.

### QUICKCACHE

Intelligent disk I/O mgmt. subsystem for PC/MC-DOS 2.xx & 3.xx. Capable of making programs run up to 14 times faster. All parameters dynamically alterable. LIM memory supported. 40 KB min. required. \$49.95 + \$5 s/h. VISA/MC. 30-day guarantee.

**P. R. GLASSEL and ASSOCIATES, INC.**

30255 Fir Trail, Stacy, MN 55079

612-482-1337

Inquiry 782.

Advertise your computer products  
for as little as \$375  
in THE BUYER'S MART.  
For more information  
call Karen Burgess at  
BYTE 603-924-3754.

# DISK-KING®

Premium Quality Diskettes  
From the Kings of Magnetic Media.  
Incredible Value

Direct from the main source — the leader and the inventor of magnetic media, quality unlabelled diskettes with hub rings, tyvek sleeves, write-protect tabs, user ID labels and a lifetime warranty. New and individually certified 100%, factory sealed in lots of 25. Private labelling available.

|               |                                 |               |
|---------------|---------------------------------|---------------|
| SS-DD         | Quantity Discounts Available    | DS-DD         |
| <b>55¢</b>    | ..... 5.25"/48 TPI .....        | <b>62¢</b>    |
| <b>\$1.29</b> | ..... 3.50"/135TPI .....        | <b>\$1.85</b> |
|               | DS-HD 96 TPI for the "AT" ..... | <b>\$1.60</b> |



from the leader of magnetic media FREE! Flip 'n' File with each box of 3.5" SS or DS diskettes, while supply lasts!

Factory Sealed Box of Ten Qty. 5 BX

|               |                                                            |               |
|---------------|------------------------------------------------------------|---------------|
| SS-DD         | Lifetime Warranty                                          | DS-DD         |
| <b>75¢</b>    | ..... 5.25"/48 TPI .....                                   | <b>97¢</b>    |
| <b>\$1.38</b> | ..... 3.50"/135TPI w/Flip 'n' File .....                   | <b>\$1.97</b> |
|               | DS-HD 96 TPI for the "AT" .....                            | <b>\$2.18</b> |
|               | *5.25" Pre-packaged in 3M's Flip 'n' File/15-\$4/box extra |               |
|               | 8.00" SS-DD w/WP .....                                     | <b>\$1.50</b> |
| <b>\$1.84</b> | 8.00" W/WP .....                                           | <b>2.05</b>   |

Call for our SUPER LOW PRICES on 3M Data-Cartridges, tapes and storage boxes.

(3M Headcleaning Kits ..... **6.95** + 2.00 ship)



...the inventor of magnetic media!

|             |                                 |               |
|-------------|---------------------------------|---------------|
| SS-DD       | Factory Sealed Box of Ten       | DS-DD         |
| <b>72¢</b>  | Lifetime Warranty               | <b>83¢</b>    |
| <b>1.35</b> | ..... 5.25"/48 TPI .....        | <b>1.87</b>   |
|             | ..... 3.50"/135TPI .....        | <b>\$1.95</b> |
|             | DS-HD 96 TPI for the "AT" ..... |               |



SUPER SALE ON  
**Nashua**  
Boxes

|                                       |                |
|---------------------------------------|----------------|
| 5.25" SS-DD Factory Sealed Box of Ten | <b>\$6.10</b>  |
| 5.25" DS-DD Factory Sealed Box of Ten | <b>\$6.50</b>  |
| 5.25" DS-HD Factory Sealed Box of Ten | <b>\$19.50</b> |
| 3.50" DS-DD Factory Sealed Box of Ten | <b>\$18.70</b> |

COLOR Premium Quality U.S.A. made  
DISKETTES AT Affordable Prices!  
▶ SUPER SPECIAL ◀

|                           |                                                                                                                                       |                       |              |
|---------------------------|---------------------------------------------------------------------------------------------------------------------------------------|-----------------------|--------------|
| SS-DD                     | Factory sealed in lots of 25 with:                                                                                                    | DS-DD                 |              |
| <b>60¢</b>                | *Tyvek sleeves, w/p tabs, user ID labels* Exceeds ANSI specs Certified 100%—70% clipping level *Lifetime warranty. Many color options | <b>68¢</b>            |              |
|                           | DS-HD 96 TPI Color diskette for the "AT"                                                                                              | <b>\$1.75</b>         |              |
| <b>RIBBONS STORAGE</b>    |                                                                                                                                       |                       |              |
| Epson MX 70/80            | ..... \$2.99                                                                                                                          | 3M's Storage Boxes    | ..... \$9.99 |
| Epson MX 100              | ..... \$3.99                                                                                                                          | Amaray Media Mate     | ..... \$8.99 |
| Okidata 80/82/83/92/93/11 | ..... \$6.99                                                                                                                          | Disk Minder II-75     | ..... \$6.99 |
| Apple Image Writer        | ..... \$3.99                                                                                                                          | Micro Disk Minders-36 | ..... \$6.99 |

TERMS: No surcharge on VISA or MasterCard. American Express also accepted. COD orders only add \$3.00. Prepaid orders deduct 2% cash discount. POs accepted from corporations rated SA2 or better, government and schools on net 30 basis. FPO, APO, AK, HI, PR & CN add 5%. No sales tax outside Utah! Minimum order \$30.00. **TELEX: 755485**  
SHIPPING: Add \$3.00 for 100 diskettes or first 4 lbs. Answer Back MYSECURE!  
\*WE BEAT ANY PRICE! (APPLIES TO APPLIES)  
Toll-Free Order Line: **1-800-523-9681** Inquiries & Info Line: **1-801-942-2273**

## DISK-COTECH

DISKCO TECHNOLOGIES, INC.  
2021 East 2000 South, Salt Lake City, Utah 84121  
Hours: 7 AM-6 PM (Mtn. Time)

# RAINBOW USERS

Install IDRIVE on your DEC Rainbow and read or write IBM PC or XT format diskettes directly.

- No new commands to learn.
- No special disks or handling.

IDRIVE comes with 360K double-sided floppy disk drive, cables, software, documentation, and 90-day warranty.

Internal IDRIVE \$349  
External (w/case & power supply) \$395

*Suitable Solutions*  
467 Saratoga Ave., Suite 319  
San Jose, CA 95129  
(408) 725-8944

Inquiry 334

## NEW EPROM PROGRAMMER



**\$349**

*The EP-1 is a great value, here's why:*

- IBM PC Software included or RS-232 to any computer
- ASCII Command driven operation; All intelligence in unit
- Reads, Programs, Copies over 150 types from 2718 to 27512
- Optional Intel microcontroller programming head
- Menu-driven Chip Selection; No Personality Modules
- Fast, Slow, Quick-Pulse Programming Algorithms
- Intel (8080 & 8088), Motorola, Tekhex, Straight Hex Files
- Splice Files By Base Address and Odd/Even (16 bit systems)
- Gold Pinout ZIF IC Sockets
- Over-Current Protection
- Full One Year Warranty
- U.V. Erasers from \$34.95
- Generate & Set Checksums
- 8 baud Rates 300 to 38,400
- 5, 12.5, 21, 25V Programming

### BP Microsystems

5325 Glenmont, Suite E, Houston, TX 77081  
(800) 225-2102 (713) 867-1836

Inquiry 51

# SEAMLESS File Transfer

Softerm PC provides a transparent Micro-to Mainframe link using *Virtual disk drive specifiers* accessible from any DOS application program. Memory resident. Transfers files in background using customizable communications scripts. Includes 32 exact terminal emulations.

For IBM PC/XT/AT, DG, NEC, HP, Wang, TI, Gridcase, Tandy, Zenith  
**\$195 - Visa, MC, COD**  
Call 800-225-8590 orders/info.

## SEIFTRONICS

7899 Lexington Dr., Ste 210  
Colorado Springs, CO 80918  
(303) 593-9540 Telex #450236

Inquiry 314

# ROMDISK

EPROM AND RAM DISK AND DRIVE EMULATORS  
For the IBM PC\* and Compatibles

- APPLICATIONS**
- Diskless control and communications systems
  - Dedicated workstations - customized smart terminals
  - Industrial control and manufacturing test systems
- FEATURES**
- Solid state speed, reliability and performance
  - Self contained EPROM programming circuitry (simply copy a Master Disk to ROMDISK)
  - Emulates a 9 sector, 40 track SSD or DSD diskette
  - Compatible EPROM, Dynamic RAM and Static RAM versions
  - Two autoboot modes and a file mode
  - RAMdisk versions are battery backed up
  - I/O mapped - does not occupy system RAM space

|                                      |             |
|--------------------------------------|-------------|
| EPROM version PCA-1 (180K)           | ..... \$495 |
| EPROM version PCA-2 (360K)           | ..... \$595 |
| Dynamic RAM version PC DRAM-1 (180K) | ..... \$495 |
| Dynamic RAM version PC DRAM-2 (360K) | ..... \$595 |
| Static RAM version PC SRAM-1 (180K)  | ..... \$695 |
| Static RAM version PC SRAM-2 (360K)  | ..... \$795 |



**CURTIS, INC. 22 Red Fox Road**  
St. Paul, MN 55110 612/484-5064

\*IBM PC is a registered trademark of IBM Corporation

Inquiry 96

## BASIC TURBO SYSTEM



Includes:

- 1024K, 8 mhz motherboard w/256K installed • Clock & game IO • 150 watt power supply • IBM® AT-lookalike case • MS-DOS & GW basic • IBM® style keyboard • FCC Approval

No. 90111 ..... **\$438.00**

IBM, PC, XT, AT are registered trademarks of International Business Machines

**The Wholesale Outlet • Order Toll Free**  
1 Interstate Avenue 1-800-344-4387 (NON-NYS)  
Albany, N.Y. 12205 All other calls & NYS call (518) 458-7883

MCVISA OR COD CASH  
All orders shipped FOB Albany • Prices subject to change

Inquiry 377



### The GRANDSTAND PRINTER STAND AND TRAY

- Folds & Stacks Automatically
- Fits ALL Popular Micro Printers
- Space Saving Operation
- Routes Cables Neatly



**Grand Union**  
Micro Systems  
P.O. Box 1880  
Fallbrook, CA 92028  
(619) 723-0882

Inquiry 147

errupt chain [e.g., XyWrite, Samna Word III, Leading Edge Word Processor, Hayes Smartcom].

- Don't grab an interrupt vector more than once. Do not set a timer trap to re-grab an interrupt vector that your program initially installed. It must not be critical that your program be the last vector in the chain. You must trust that the chain will not be broken [e.g., SideKick].

- Changing video modes. Use the BIOS whenever possible, but if there is some reason your program directly changes modes, it must also set all the CRT values in the BIOS data area, addresses 0040:0049 through 0040:0066. See the CRT BIOS listing for more details [e.g., Lotus 1-2-3 version 1A, switching from text to graphics].

- Don't jump from a DOS critical-error routine. Instead, set a global error flag that your disk routines check with the error code that the critical-error handler gives you. Then issue an IGNORE response and do an IRET back through DOS so that the DOS stacks are cleaned up [e.g., Lotus 1-2-3 version 1A].

- Setting the high-order attribute bit to be used as background intensity rather than blinking. This is a value sent out port 3D8H (the mode control register). Whenever a program sets this port, the value should also be stored in the BIOS data area at address 0040:0065 (CRT\_\_MODE\_\_SET) [e.g., Framework version 1.1, Superwriter, and SuperCalc].

- Maintain the hardware cursor. If your program does not want to use the hardware cursor but instead uses its own software cursor, the cursor position should still be reflected in the BIOS data area at addresses 0040:0050-0040:005F depending on which video page you have in use [e.g., Thinkfank and Ready!].

- Changing the color palette by toggling the color burst bit. This is a common way of obtaining different colors from a monitor. Whenever a program sends a value through port 3D8H (the mode control register), it should also set the value in the BIOS data area at port; the value should also be stored in the BIOS data area at address 0040:0065 (CRT\_\_MODE\_\_SET).

- Changing the palette on an EGA board. If a program changes the EGA palette directly rather than using the BIOS function, it should copy the values modified to the save area defined by the EGA BIOS, the second double-word off the "save pointer" located at address 0040:00A8. See the EGA BIOS listing for more details [e.g., Microsoft Word].

### CHECKING FOR PRINTER STATUS

pascal/turbo #696, from larryjudy [Lawrence Judy]

Printer, Are You There?

Jim, or Barry, or Joanne, earlier in about message 630 or so I had requested help with determining if the printer was turned on before my program tried to print. My main problem is unfamiliarity with 8086/8 assembly and the complexity of MS-/PC-DOS, but I did jiggle your various answers to come up with the subsequent short function (posted as a message), which worked great on my AT&T 6300. Unfortunately, it did not work on the IBM PC at work. The short program below will work on the IBM, but not on the AT&T without the additional line at the end of the function. I don't know if the last line will work on the IBM. Is this a difference of MS- vs. PC-DOS, or of printers (Toshiba 1340 at home, Panasonic at work)? Could someone tell me if the program will work on their IBM machine?

```
program Intr17n2_pas; var ch : char; Function PrinterIsReady : Boolean; Type
```

```
RegisterSet = record ax,bx,cx,dx,bp,di,se,ds,es,flags:integer;end; Var
```

```
Regs : RegisterSet; Begin
```

```
PrinterIsReady := false;
```

```
FillChar (Regs, sizeof(Regs), 00);
```

```
With Regs Do
```

```
Begin
```

```
ax := $0200; {request status}
```

```
dx := 0; {lpt1 = 0, lpt2 = 1}
```

```
End;
Intr ($17, Regs) If((regs.ax and $4000 = 0)) then
begin
 if regs.ax and $1000 <> 0 then PrinterIsReady:= true
end; if regs.ax and $8000 = 0 then PrinterIsReady := false end;
begin
 repeat
 read(kbd,ch);
 if PrinterIsReady then
 begin
 clrscr;
 writeln('The printer is ready;')
 end
 else
 begin
 clrscr;
 writeln('The printer is not ready;')
 end;
 until ch in ['q','Q'];
 end.
```

pascal/turbo #699, from jrobie [Jonathan Robie]  
a comment to message 696

Larry, scanning your PrinterIsReady function, I notice that structure is something like this:

```
PrinterIsReady := false;
Inquire if printer is ready;
If (regs.ax and $4000) = 0 then { if printer does not acknowledge }
 begin
 if (regs.ax and $1000) <> 0 then PrinterIsReady:=true {selected}
 end;
 If (regs.ax and $8000) = 0 { if printer is busy }
 then PrinterIsReady := false;
```

If the printer does acknowledge, then the PrinterIsReady returns false. Not all printers send an acknowledge signal, so if you test for acknowledge then you can't assume that the acknowledge signal is present.

You also may want to check to see if you are out of paper. You are out of paper if (regs.ax and \$2000) = 1. This test doesn't seem to work with my Zenith Z-150 and a C. Itoh Prowriter printer, though.

pascal/turbo #707, from jimkeo [Jim Keohane]

Larry, maybe what you should do is write a little quick-and-dirty program that issues INTR \$17 repeatedly and writes out the value of rax until keypressed. Display the values bit by bit like:

```
repeat {set reg and issue INTR call} for i:=1 to 16 do
 begin
 if rax and $8000 = 0 then write('0') else write('1');
 rax:=rax shl 1;
 end; writeln; until keypressed;
```

This should show you all the status settings that are set as you turn printer on/off, select/deselect, remove paper, unplug cable, etc.

You can now see if there is one test that will suffice for both the IBM PC and the AT&T 6300. Keep in mind there may be differences with other printers too, so try to keep your test to the minimum.

pascal/turbo #708, from wheelock [Bruce Wheelock]  
a comment to message 707

With a spooler?

I can't see a way to check printer status with a print spooler installed. Anyone else? I thought not. ■

# THE BUYER'S MART

## A Directory of Products and Services

THE BUYER'S MART is a monthly advertising section which enables readers to easily locate suppliers by product category. As a unique feature, each BUYER'S MART ad includes a Reader Service number to assist interested readers in requesting information from participating advertisers.

**RATES:** 1x—\$475 3x—\$450 6x—\$425 12x—\$375  
Prepayment must accompany each insertion. VISA/MC Accepted.

**AD FORMAT:** Each ad will be designed and typeset by BYTE. Advertisers must

furnish typewritten copy. Ads can include headline (23 characters maximum), descriptive text (250 characters maximum), plus company name, address and telephone number. Do not send logos or camera-ready artwork.

**DEADLINE:** Ad copy is due 2 months prior to issue date. For example: October issue closes on August 1. Send your copy and payment to THE BUYER'S MART, BYTE magazine, 70 Main Street, Peterborough, NH 03458. For more information call Karen Burgess at BYTE 603-924-3754.

### ACCESSORIES

#### FREE CATALOG

Outstanding prices on computer accessories for your computer and workstation. Our catalog features a wide selection of quality products to meet all your accessory needs. Call or write today to receive your free catalog.

**LINTEK COMPUTER ACCESSORIES**  
POB 8058, Grand Rapids, MI 49508  
**(616) 241-4040**

Inquiry 720.

### ACCESSORIES

#### SOFTWARE PACKAGING, DISKS

Cloth binders & slips like IBM's. Vinyl binders, boxes, and folders—many sizes. Disk pages, envelopes, & labels. Low qty. imprinting. Bulk & branded disks. Much More! Low prices. Fast service. Call or write for FREE CATALOG.

**Anthropomorphic Systems Limited**  
378-B East St. Charles Road  
Lombard, IL 60148  
**1-800-DEAL-NOW (312) 629-5160**

Inquiry 858

### BAR CODE

#### PRINT BAR CODES ON PC

Print Bar Codes and Large Text Labels on PC with Epson/Olivetti/IBM Printers - Code 39, 12of5, UPC, MSI, DOD-LOGMARS, AIAG. Text up to 1" tall. File input. Menu driven \$49-299. NEW! 8K Ram-Resident program prints bar codes from any user program or even word processor — \$179, (\$239 with large text).

**Worthington Data Solutions**  
130 Crespi Court, Santa Cruz, CA 95060  
**(408) 458-9938**

Inquiry 775.

#### COMPUTER PROTECTION

- UPS • LINE CONDITIONERS • ISOLATORS
- MODEM PROTECTORS
- AC POWER INTERRUPTERS

— HUNDREDS OF HINTS & PRODUCTS —

**FREE CATALOG 1-800-225-4876**  
**ELECTRONIC SPECIALISTS, INC.**  
171 So. Main St., POB 389, Natick, Mass 01760  
**1-800-225-4876**

Inquiry 893.

#### Self-Inking Printer Ribbon

For users of Okidata and other open spool ribbon printers. Controlled Printout Devices are a new kind of printing ribbon that re-ink themselves, and will last 15 times longer than the ribbon you are now using. For further information please call or write.

**CONTROLLED PRINTOUT DEVICES, INC.**  
POB 889, Baldwin Rd., Arden, NC 28704  
**(704) 884-9044**

Inquiry 879.

#### BAR CODE READERS

Program-transparent, Keyboard interface Bar Code Readers for IBM PC, AT and compatibles-\$485. Other wedge readers for IBM 3180, 3178, 3278, 5251, 5291, and RS-232 terminals. Portable Bar Code Readers from \$325. Programmable Hand-Held Portables-\$1200. Free PC print program with reader purchase. 30 day money-back guarantee on all products.

**Worthington Data Solutions**  
130 Crespi Court, Santa Cruz, CA 95060  
**(408) 458-9938**

Inquiry 775.

#### ... SOFTWARE PUBLISHING. ...

GDS offers a wide variety of services that will help get your software to the market. Address your needs with GDS.

- IBM style cloth/vinyl 3-ring binder/strips
- Labels, sleeves, disk pages, bulk diskettes.
- Disk duplication with 100% verification
- Shrink wrapping and product assembly
- Quick turn-around

A well packaged product can make the difference in making a sale. Call us now! VISA/MC

**GLENCO DEVELOPMENT SYSTEMS(312) 382-2492**  
3920 Ridge Ave. Arlington Hts. IL 60004

Inquiry 702.

#### DATA CABLES & PARTS

EIA RS232-C Data Cables - standard, extended distance. Teflon Assemblies. Also Centronics (parallel), Coaxial (RG59U, RG62A/U, Dual Wang, Twin-axis), Ethernet, Ribbon, IBM, DEC Compatible cables, AB switches, connector parts, bulk cable; tools & hardware (wall plates). Send for Catalog.

**Communication Cable Co.**  
POB 600-B, Wayne, PA 19087  
**215-644-1900**

Inquiry 875.

### BUSINESS OPPORTUNITIES

#### VIDEO STORES

We need ambitious dealers in all U.S. states and Canada to market a powerful system to computerize video tape rental stores.

#### WINCHESTER DATA PRODUCTS INC.

3301-Executive Drive., #204, Raleigh, N.C. 27609  
**(919) 872-0995**

Inquiry 774.

#### FREE CATALOG

Thousands of parts and new surplus electronic parts at super low prices. **FAST ORDER PROCESSING AND SHIPPING** (95% of all orders shipped within 48 hours).

CALL OR WRITE FOR A FREE CATALOG. . .

**ALL ELECTRONICS CORPORATION**  
POB 20406, Los Angeles, CA 90006-0406  
**1-800-826-5432**

Inquiry 854.

#### LOWEST PRICES ON DISKETTES

3 1/4" DSDD 36, High Density 165.  
3 1/4" 5SHD 125, DSDD 145.

- Lifetime warranty
- 100% error free
- Finest quality
- Add 3.00 shipping per 100. Minimum 100 diskettes.
- Includes tyvek sleeves
- Reinforced hub ring
- Labels & write protect tabs

Send check or call. CA residents add 6 1/2% sales tax. Same day shipping.  
**Data Bureau Inc.**  
1833 Westwood Blvd., Ste 120, Los Angeles, CA 90024  
**213-479-0345**

Inquiry 883.

#### REAL ESTATE SOFTWARE

**LEADING SOFTWARE DEVELOPMENT COMPANY SEEKS SUCCESSFUL DISTRIBUTORS AND DEALERS TO MARKET SOFTWARE DESIGNED FOR RESIDENTIAL REAL ESTATE BROKERAGE OFFICES. TERRITORIES AVAILABLE THROUGHOUT THE U.S. INTERESTED COMPANIES PLEASE CALL (516) 621-3363.**

Inquiry 750.

#### PRINTER RIBBONS

**Guaranteed First Quality — Colors Available**  
Price each in quantity of 3 6 12

|                           |        |        |        |
|---------------------------|--------|--------|--------|
| C. Itoh Prowriter Nylon   | \$5.25 | \$3.65 | \$3.35 |
| Epson MX/FX/RX 70/80      | 5.25   | 3.65   | 3.35   |
| IBM Proprinter Nylon      | 7.75   | 6.70   | 5.70   |
| Okidata 182/192/193 Nylon | 8.80   | 7.60   | 6.45   |

Prices include delivery in Continental U.S.

**Printer Ribbon Supply**  
POB 920145 • Norcross, GA 30092  
**800-438-7745 In GA. 404-446-1547**

#### PRINTED MANUALS

Cornerstone Printing provides your choice of full software publishing services, including typesetting, printing, binder selection, disk duplication, and packaging. **Save 50% on typesetting.** We can typeset from your ASCII or Multimate w p file.

**Cornerstone Printing**  
95 Little Tree Lane, Hilton, NY 14468  
**716-392-2386 & 716-392-9500 (collect)**

Inquiry 880.

### COMMUNICATIONS

#### VT102/52 TEK4014 VT220

Our terminal emulators turn your PC/AT/XT into a full featured terminal. Features include: local printing, ASCII & KERMIT file transfer, softkeys, DOS key, ANSI COLOR, 4014 graphics support. Guaranteed compatibility. Call today for free info packet.

**General Micro Systems**  
P.O. Box 5330, Hopkins, MN 55343-1553  
**(612) 944-0593**

Inquiry 701.



# ★ 10th ANNIVERSARY SALE ★

## 8MHz TURBO SUN-ST COMPUTER

# \$530

(ASSEMBLED & TESTED)

Dealer & Computer Groups  
Call for Special Price



- 4 LAYER MOTHER BOARD
- 8 MHz CPU (Keyboard Switchable to 4.77 MHz)
- 256K RAM (Expandable to 640K)
- 360 KB DISK DRIVE
- AT STYLE KEYBOARD
- COMPUTER CABINET w/SPEAKER
- 1 YEAR LIMITED WARRANTY
- FCC APPROVED

Call for other configurations

## SUN-ST UPGRADE ITEMS

- RAM UPGRADE TO 640K . . . . . \$60
- 2ND DISK DRIVE (360 KB) . . . . . \$109
- MONO G CARD w/PP (Hercules Compatible). . . . . \$99
- COLOR GRAPHIC CARD . . . . . \$85
- ENHANCED GRAPHIC CARD w/256K. . . . . \$259 (IBM EGA Compatible)
- 12" TTL GREEN MONITOR - \$115 or AMBER - \$135
- COLOR MONITOR (640x240) . . . . . \$365
- MULTI-I/O PLUS CARD (Serial, Parallel, Game Port, Clock, Calendar, Ram Disk, Spool). . . . . \$95
- 8087-2 . . . . . \$159

## SUN-286 (IBM-AT Compatible) **\$1,350** COMPUTER SYSTEM

- 6 MHz & 8 MHz DUAL SPEED MOTHERBOARD
  - 640K RAM ■ 8 EXPANSION SLOTS
  - 1.2 MB FLOPPY DISK DRIVE ■ FDD/HDD CONTROLLER
  - 200W POWER SUPPLY ■ AT STYLE KEYBOARD
- OPTIONS:
- 20 MB (40 ms) . . . \$590 ■ 30 MB HDD (40 ms) . . . \$690
  - MULTI FUNCTION CARD (Serial, Parallel, RAM Expandable to 3 MB, OK) . . . . . \$225
  - I/O CARD (Serial, Parallel Port) . . . . . \$ 69



**SUNTRONICS CO., INC.**  
12603 Crenshaw Blvd., Hawthorne, CA 90250

1-800-421-5775  
(orders only)  
213-644-1140

STORE HOURS  
MON - FRI 9:00am - 6:00pm  
SATURDAY 10:00am - 5:00pm  
Dealer & OEM Inquiries Invited

TERMS: USA, MasterCard (No Surcharge), COB, C.O.D. or Certified Check (VISA or MC Not Required), School & Gov. Customers. K.D. accepted. Shipping & H.C. \$12.00 for 3 lbs. plus \$1.00 per each additional lb. CA residents add 2% Sales Tax. \$12.00 Min. Order. WARRANTY: 30 Days Working Labor, Parts Replacement Only. IBM is a registered trademark of International Business Machines.

# BYTE CONNECTION INC. (714) 778-6496

## BOTTOM LINE PRICE BUSTERS? - "Who you gonna call?"

### PERSONAL COMPUTERS

- IBM + IV, (IBM AT Compatible), with 8 MHz, 640 K, 1.2 MB Floppy, 20 MB HD, Graphics Card, Monitor & Keyboard . . . . . \$2275
- IBM PC XT, with 256K, 360 Floppy, 20 MB HD, K.B., Graphics Card, Monitor . . . . . \$2350
- IBM PC XT, with 640K, IBM 360 Floppy, IBM 20 MB HD, New Keyboard, Graphics Card, Monitor . . . . . \$2559
- IBM PC AT, with 512K, K.B., 20 MB HD . . . . . \$2995
- IBM PC Convertible 80 C 88 Processor, with 512K, Two 720KB Floppies . . . . . \$CALL
- IBM Proprinter . . . . . \$ 475
- IBM Quietwriter . . . . . \$1200
- IBM EGA, with 256K Memory . . . . . \$ 775
- IBM EG Monitor . . . . . \$ 895

- COMPAQ PORTABLE II with 512K, 80286 Processor, Two 360 Floppies . . . . . \$2795
- COMPAQ DESK PRO, with 640K, Two 360 Floppies, Graphics Card & Monitor . . . . . \$1895
- COMPAQ DESK PRO & PORTABLE 286, with 640K, 1.2 Floppy, 20 MB HD, Monitor . . . . . \$3895
- For 86 MB, instead of 20 MB, add . . . . . \$ 995

- AT & T 8300 PC, with 256K, K.B., Two 360 Floppies, AT & T Graphics Card & Monitor . . . . . \$1795
- AT & T 8300 Plus, with 512 K, 1.2 Floppy, K.B., Graphics Card & Monitor . . . . . \$3495

- SPERRY PC-IT, with 640K, 1.2 MB Floppy, 40 MB HD, K.B. . . . . \$3095

### PLOTTERS & DIGITIZERS

- CALCOMP 1043 . . . . . \$7359
- 1044 . . . \$11,195
- GOULD 8320 11 x 17 . . . \$1550
- IO LINE 3700 . . . \$3895
- HI DMP 56 . . . \$4598
- DMP 40 . . . \$ 920
- DMP 51/52 . . . \$4145
- HP 7475 . . . . . \$1659
- HP 7580 . . . . . \$8415
- NICOLET ZETA 824 . . . . . \$8995
- ZETA 836CS . . . . . \$13,295
- GTCO 3648L . . . . . \$3095
- 1117A . . . . . \$1195
- 2438TL . . . . . \$5995
- KURTA 12 x 12 . . . . . \$ 595
- 12 x 17 . . . . . \$ 695
- SUMMAGRAPHS 11 x 11 . . . . . \$ 495
- 18 x 12 . . . . . \$ 750
- HITACHI 36 x 48 . . . \$4195
- TIGER 11 x 11 . . . \$ 675
- 15 x 15 . . . \$1295

### GRAPHIC CONTROLLERS & MONITORS

- HITACHI HM 3719 & BNW 15 . . . . . \$3290
- MICROVITEC 905CNO GRAPHPORT D . . . . . \$2795
- Taxan 640 & Color 400L . . . \$1099
- Persysat BOB 16 & NEC 1401 . . . \$1150
- Galaxy 800 & Mitsubishi 6489 . . . \$2995
- Verticom CD-1 & M-16 . . . \$2395
- BNW Adapter . . . . . \$1950
- Artist-IT . . . . . \$2295
- Conographics 400 & Mitsubishi 3479 LP . . . \$2295
- Mitsubishi 1341 & Sigma 400 . . . . . \$1195

**SPECIAL OF THE MONTH - CAD System, Sperry IT, 640K, 40 MB HD, 80287 M.C., BOB 16, NEC 1401, Auto CAD, Summa Graphics, HI DMP 40 . . . . . \$8985**

**(714) 778-6496**

No charges for testing and configuring equipment. Prices and availability subject to change without notice.

**167 West Cerritos Ave., Anaheim, CA 92805**

### SOFTWARE

- Accounting Package . . . . . \$ 495
- AUTOCAD . . . . . \$1950
- T & W VERSACAD . . . . . \$2395
- CADVANCE . . . . . \$1950
- ARMOR SYSTEM'S Excalibur & Plus Series . . . . . CALL
- COMPUTER ASSOCIATE (IUS) A/R, A/P, G/L . . . . . EACH \$ 350
- UNIVAIR'S Dental Management & Medical Management-8000 . . . . . CALL
- CYMA Medical, Chiropractic, Orthodontic, Dental Package . . . . . \$1825
- Physician Micro Systems Package . . . . . \$1850
- Hotel Information Systems Package . . . . . \$2450
- MICROCRAFT, BALCONE, UNIVAIR . . . . . CALL
- IBM Doctor Officer Manager II . . . . . \$2950

### PRINTERS

- CITOH LQ24 . . . . . \$ 875
- F10-40 . . . . . \$ 875
- F10-55 . . . . . \$ 995
- C-10 . . . . . \$ 475
- CITIZEN MSP 15 . . . . . \$ 415
- MSP 25 . . . . . \$ 525
- CITIZEN PREMIER 35 . . . . . \$ 515
- CORONA LAZER . . . . . \$2350
- DIABLO 835 . . . . . \$1250
- INKJET . . . . . \$ 895
- DIABLO 34LQ . . . . . \$1095
- DIABLO LAZER/COPIER 4045 . . . . . \$4259
- EPSON FX85 . . . . . \$ 379
- EPSON 288 . . . . . \$ 550
- HEWLETT-PACKARD LASER JET . . . . . \$2195
- HP Plus . . . . . \$2995
- HEWLETT-PACKARD 500 Plus . . . . . \$4150
- NEC P580 . . . . . \$ 995
- P780 . . . . . \$ 650
- FUJITSU MAX 24 . . . . . \$1175
- MAX 24 COLOR . . . . . \$1275
- FUJITSU DL 2400 . . . . . \$ 959
- DM 2400 . . . . . \$ 859
- 2200 . . . . . CALL
- TOSHIBA P321 . . . . . \$ 550
- OKIDATA 192 . . . . . \$ 389
- 193 . . . . . \$ 479
- OKIDATA 293 . . . . . \$ 665
- TOSHIBA P351 . . . . . \$1095
- P341 . . . . . \$ 750

### HARD DRIVES & BACK UP SYSTEMS

- SEAGATE 20 MB . . . . . \$ 450
- SEAGATE 1038 . . . . . \$ 895
- SEAGATE 4051 . . . . . \$ 850
- HARD CARD 20 MB . . . . . \$ 650
- MAXTOR/MICROPOLIS 85MB . . . . . \$1550
- MAXTOR 105/140 . . . . . \$1650/\$2195
- TEAC 20 MB Tape B/U . . . . . \$ 595
- ARCHIVE 80 MB Tape B/U . . . . . \$ 850

CALL FOR WHAT IS NOT LISTED. WE GUARANTEE THAT YOUR CALL WILL NOT BE A WASTE. LEASING AVAILABLE.

**P.C. Computer Brokers Inc.**

**The Place To Buy Your Computers, Printers, Software And Accessories**

**Teac**—½ Height Drive 360K **\$89<sup>95</sup>**

**Samsung**—TTL Monitor Green or Amber **\$79<sup>95</sup>**

**Ring King Printer Stands**

10" Wide ..... **\$24<sup>95</sup>**  
15" Wide ..... **\$39<sup>95</sup>**

Call Toll FREE

**1-800-245-4122**



Quick Link High Speed Buffer Sugg. Retail **\$179<sup>95</sup>**

**\$124<sup>95</sup>**

**IBM PC Clone**

**Data Link—One Year Warranty**  
FCC Approved, 640K, 2 Drives, Monographics Card, Mono Monitor, Para. Port, Ser. Port, 8 Expansion Slots, Keyboard, MS DOS. Leading Edge Word Processor & Spread Sheet.

**\$895<sup>95</sup> Complete**

Also Available With 20 Meg

Hard Drive **\$1295<sup>95</sup> Complete**

**Word Perfect 4.1** ..... **\$209<sup>95</sup>**

**Monochrome Graphics Card**  
FCC Approved ..... **\$88<sup>95</sup>**

**Seagate 20 Meg**  
Hard Drive With Controller **\$449<sup>00</sup>**

**P.C. Computer For Repairs**

Send P.C. Your Computer Equipment, Our Authorized Technicians Will Repair And Return It To You.

**For Repairs Call (303)450-6727**

**Modems**

Packard Bell External 300/1200 bd ..... **\$149<sup>95</sup>**

Zoom Internal 300/1200 bd with Software ..... **\$249<sup>95</sup>**

Everex Internal 300/1200 bd ..... **\$149<sup>95</sup>**

Prices Subject to Change Without Notice



Add 2.9% For Use of Visa, M/C & Choice.

These Prices Are Good For Mail Order Dept. Only

**P.C. Computer Brokers Inc.**  
**3879 East 120th Ave.**  
**Thornton, CO 80233**  
**(303)450-6727**

Call Toll FREE **1-800-245-4122**

**NEC PRINTERS**

(1 Year Factory Warranty)

- Pinwriter P5.....\$ 930
- Pinwriter P5XL.....\$1075
- Pinwriter P6.....\$ 450
- Pinwriter P7.....\$ 615
- Elf 350/360.....\$ 380
- 3510/15/30/50.....\$ 715
- 8810/15/30/50.....\$1040

Optional Forms Handling Devices ..... **CALL**

**QUALITY PRINTERS**

8415 Cement City Road  
Brooklyn, Michigan 49230  
Phone: 517-592-3749

Inquiry 289

**Protect Your Private Parts.**

Whether you're a software developer or an end user, whether you work alone on a PC or you're part of a 24-person project team, keeping new software or sensitive data from prying eyes is tedious business.

Short of complicated, wizard-like protection schemes, or James Bond, you haven't had too many realistic alternatives. Until now.

Because Rainbow Technologies has developed simple, easy-to-use systems called Sentinels that say no to prying eyes. No matter how hard they look.

The key to Sentinel is just

that—a smart piece of plastic smaller than a best-selling cassette that plugs into the parallel port of your IBM PC/XT/AT or compatible.

There are two ways to go. The Software Sentinel™, that prevents anyone from using your licensed software program unless you give them a key. And the Data Sentinel™; Rainbow Technologies' newest prying eye-stopper, that automatically protects sensitive personal or project data as you enter it. The Sentinel Security Systems from Rainbow Technologies. The only hard part is the key.



RAINBOW TECHNOLOGIES INC.  
1701 Skypark Circle, Suite E, Irvine, CA 92714  
Phone (714) 264-0228 Telex: 386078

Inquiry 293

**MEMORIES—DRIVES—PRINTERS**

- ★ **64K/128K/256K D-RAMs at LOW PRICES**
- ★ **H-P Vectra 128K Upgrade** ..... **\$39.95**
- ★ **V80-5** ..... **\$14.00 / V80-8** ..... **\$18.00**
- ★ **V30-8** ..... **\$18.00** ★ **8087** ..... **\$118.00**
- ★ **8087-2** ..... **\$155.00 / 8087-3** ..... **\$180.00**
- ★ **Memory Boards and Modules**
- JRAM-2 Parallel or Serial w/OK ..... **\$169.50**
- JRAM-3 JRAM-AT Per. or Ser. w/OK ..... **\$177.50**
- JRAM AT-3 Per. or Ser. w/OK ..... **\$229.50**
- Ser/Per or Ser/Ser Clock module ..... **\$132.00**
- Ser/Per or Ser/Ser module ..... **\$85.00**
- Clock/Calendar module ..... **\$55.00**
- JDISKETTE module ..... **\$135.00**
- JLASER-1 ..... **\$185.00**
- Canon Printer/switch + cables ..... **\$80.00**
- Corona cable ..... **\$85.00**
- IBM Multi-Function Board w/384K ..... **\$115.00**
- ★ **TEAC FD55-BV DS/DD Disk Drive** ..... **\$85.00**  
w/ one year factory warranty
- ★ **BROTHER Printers & Accessories**
- HA150B Dot Matrix Printer ..... **\$395.00**
- HR15XL Daisy Wheel Printer ..... **\$375.00**
- Twinwriter-S Dot Matrix/Daisy ..... **\$685.00**
- Printer Accessories ..... **25% off LIST**

WARRANTY: All E.C.s guaranteed for 180 days. \* D.D.s and DEALER discounts available. \* Prepaid orders - No shipping charges. \* Maryland residents must add sales tax.

**Advanced Technology Products, Corp.**  
P.O. Box 2205 / 11141 Georgia Ave., Silver Spring, MD 20902  
Phone: 301-933-3523

Inquiry 9

**M68000 SINGLE BOARD COMPUTER**

**NEW LOW PRICE**

On board 6-10 MHz CPU, 20K RAM, 32K EPROM, two RS-232, 16-bit port, 5-counter/timers expandable via Memory/FDC Board.

- M68K CPU (bare board) ..... \$ 89.95
- M68K CPU A&T (6MHz) ..... \$495.00
- MD512K Memory/FDC (bare board) ..... \$ 89.95
- MD512K Memory/FDC (128K) ..... \$495.00
- FDC/Hard Disk interface option ..... \$150.00
- M68KE Enclosure w/power supply ..... \$249.00
- M68K Monitor EPROM's ..... \$ 95.00
- M68K Macro Cross Assembler ..... \$195.00
- 4XFORTH OS w/assembler, editor ..... \$295.00
- CP/M 68K OS w/"C" compiler ..... \$395.00

**EMS** Educational Microcomputer Systems P.O. Box 16115 Irvine, CA 92713 (714) 854-8545

Inquiry 117

**IBM-PC Schematic Design**

A professional package enabling you to design, edit, print & plot electronic schematics. Supports "A" through "E" size sheets, over 2000 Unique Library Parts, Part Rotation, Unlimited Hierarchy, Grids, Auto Panning, 5 Zoom Levels, Rubberbanding, Powerful Macros, Hi-Res Color & Monochrome Graphics, Much More! \$495 Includes Everything.

Call To Receive Free Demo Disk.  
**OrCAD Systems Corporation**  
1049 S.W. Baseline St.  
Hillsboro, OR 97123  
**(503) 640-5007**

**8051 PASCAL CROSS COMPILER**

For MS-DOS Computers

SCIENTIFIC ENGINEERING LABORATORIES  
104 Charles Street, Suite 143  
Boston, MA 02114 Tel 617 262 3903

Inquiry 303

# Compu\$ave

Call Toll Free: 1-800-624-8949

A DIVISION OF ADLANKO CORPORATION

## MONITORS

|                                                |                           |
|------------------------------------------------|---------------------------|
| Amdek 310A . . . . . 143                       | Amdek 725 . . . . . 535   |
| NEC Multisynch . . . . . 539                   | PGS HX12E . . . . . 495   |
| Samsung TTL . . . . . 89                       | PGS MAX12 . . . . . 158   |
| Samsung 1251 . . . . . 72                      | Tacan 640 . . . . . 485   |
| Tatung 1360 . . . . . 399                      | Tatung 1370 . . . . . 449 |
| Thom 31311SI . . . . . 388                     | Wyse 620 . . . . . 385    |
| Thom 36382SI . . . . . 375                     | Wyse 700 . . . . . 1125   |
| Zenith 1360 . . . . . 515                      | Zenith 1230 . . . . . 92  |
| Roland/12"/RGB/640x240/.37 . . . . . 289       |                           |
| Sakata/13"/Comp & RGB/640x200 . . . . . 359    |                           |
| Thomson/14"/Color Comp/Apple . . . . . 139     |                           |
| Hitachi/Mitsubishi/Nanao/Sperry . . . . . CALL |                           |

## MODEMS

|                                                 |
|-------------------------------------------------|
| Anchor Volksmodem 12 . . . . . 132              |
| Anchor Lightning 2400/Software . . . . . 299    |
| Hayes Smartmodem 1200 . . . . . 368             |
| Incomm 2400/Upgradeable 4800+ . . . . . 345     |
| Novation 2400 Professional . . . . . 499        |
| Practical 1200 Half-Card/Software . . . . . 139 |
| Prometheus Modem 1200B . . . . . 189            |
| Prometheus 300-C/Apple II/Software . . . . . 76 |
| Racal-Vadic 2400PC/Software . . . . . 369       |
| Zoom 1200PC-XL/RAM/Software . . . . . 229       |
| US Robotics Courier 2400 . . . . . 378          |
| Zoom IIE Internal/Software/Apple . . . . . 92   |
| AST/Codex/Rixon/UDS/Van-Tel . . . . . CALL      |

## COMPUTERS

|                                                 |
|-------------------------------------------------|
| AT&T 6300/640K/1 Drive . . . . . 1499           |
| Cordata PC400-XT/Portable/20M . . . . . 1499    |
| Sharp PC7000 Portable/2 Drives . . . . . 1139   |
| Sperry IT/1M/40M Hard Drive . . . . . 2899      |
| Toshiba T3100-AT/Portable/10M . . . . . 3199    |
| Toshiba T1100+ Portable/2 Drives . . . . . 1499 |
| Wyse 285-AT/640K/1.2M Drive . . . . . 1795      |
| Altos/Olivetti/Video Tech/Zenith . . . . . CALL |

## CTC SYSTEMS XT \$548

640K / 4.77 MHz / 1 Floppy Drive / 135 W Power Supply / XT-Style Keyboard / User Documentation / 6 Months Warranty

## TELEVIDEO TELECAT 286 \$2349

512K / 8 MHz / 1.2M Floppy Drive / LED AT Keyboard / Clock Calendar / Hi-Res Monitor 640 X 400 / Tilt-Swivel Stand Parallel & Serial Ports

## TERMINALS

|                                             |                         |
|---------------------------------------------|-------------------------|
| IBM 3161-11 . . . . . 489                   | Altos III . . . . . 555 |
| Kimtron KT7 . . . . . 435                   | Altos IV . . . . . 355  |
| Qume QVT-101G . . . . . 293                 | Ampex 210 . . . . . 365 |
| Televideo 905 . . . . . 289                 | Wyse 30 . . . . . 289   |
| Televideo 955 . . . . . 445                 | Wyse 50 . . . . . 415   |
| Televideo 9220 . . . . . 459                | Wyse 60 . . . . . 475   |
| Visual 65 . . . . . 399                     | Wyse 85 . . . . . 438   |
| Adds/CIE/Liberty/Link/Zenith . . . . . CALL |                         |

## PRINTERS/PLOTTERS

|                                                 |                            |
|-------------------------------------------------|----------------------------|
| Citizen 120D . . . . . 179                      | Canon A40 . . . . . 235    |
| Citizen MSP10 . . . . . 275                     | Canon Laser . . . . . 1935 |
| Citizen MSP20 . . . . . 319                     | NEC CP7 . . . . . 735      |
| Cordata Laser . . . . . 2175                    | NEC PSXL . . . . . 1125    |
| Epson FX286 . . . . . 539                       | NEC P6 . . . . . 445       |
| Okidata 2410 . . . . . 1795                     | Okidata 293 . . . . . 655  |
| Panasonic 1091 . . . . . 228                    | Okidata 292 . . . . . 511  |
| Panasonic 1092 . . . . . 299                    | Ricoh 52LD . . . . . 795   |
| Panasonic 1592 . . . . . 409                    | Star LV1210 . . . . . 180  |
| Toshiba 351 Col . . . . . 1199                  | Star NX10 . . . . . 245    |
| Toshiba 321 . . . . . 495                       | Tally MT86 . . . . . 425   |
| Data Prod/Data So/Diablo/Fujitsu . . . . . CALL |                            |
| Genicom/Juki/Televideo/TI . . . . . CALL        |                            |
| Buffers/Cables/Sheet Feeders . . . . . CALL     |                            |
| Stands/Switch Boxes/Tractors . . . . . CALL     |                            |
| Houston/Oline/Roland Plotters . . . . . BAVE    |                            |
| Houston/Kurta/Somma Digitizers . . . . . BAVE   |                            |

## DISK DRIVES

|                                               |
|-----------------------------------------------|
| Gamma Drives/Apple Compatible . . . . . 119   |
| IOMEGA Dual 10M Bernoulli W/IF . . . . . 1945 |
| IOMEGA Dual 20M Bernoulli W/IF . . . . . 2495 |
| Mountain 20M Hard Card . . . . . 699          |
| Seagate 20M Hard Drive Kit . . . . . 405      |
| Tallgrass 25M Drive/60M Backup . . . . . 2199 |

## OTHER FLOPPY AND HARD DRIVES

- Alloy • Archive • CDC • Corvus • Irwin
- Maxtor • Maynard • Mitsubishi
- Sanyo • Panasonic • Priam • Shugart
- Tandon • Tulin • Teac • Tecmar • Western Digital

## BOARDS

|                                              |
|----------------------------------------------|
| AST Rampage/PC-XT . . . . . 239              |
| AST Six Pack Premium/512K . . . . . 349      |
| ATI Graphics Solution . . . . . 199          |
| Orange Grappler + (Apple) . . . . . 60       |
| Orchid Tiny Turbo 286 . . . . . 439          |
| Orchid Turbo EGA . . . . . 589               |
| PC 576K RAM Board (OK) . . . . . 59          |
| PC Color Graphics Card . . . . . 79          |
| PC Monochrome Graphics Card . . . . . 89     |
| PC Multifunction Card/OK . . . . . 85        |
| Hercules Monochrome Graphics . . . . . 158   |
| STB EGA Card . . . . . 259                   |
| Paradise EGA/Auto-Switch . . . . . 375       |
| Sigma 400 High Res Card . . . . . 439        |
| Tecmar EGA Master . . . . . 295              |
| Intel/Microtek/Persys/Quadram . . . . . CALL |
| Practical/Tacan/Thesys/Vutek . . . . . CALL  |

ALL TYPES OF BUSINESS, CAD AND RECREATIONAL SOFTWARE VERY LOW PRICES. . . . . CALL

## WE ALSO CARRY

|                                                |
|------------------------------------------------|
| Epson JX-80 Color Ribbons . . . . . 12         |
| Microsoft BUS Mouse W/Paint . . . . . 169      |
| PTI-85 Surge Protector (#1 Rated) . . . . . 52 |
| Cables/Chips/Disks/Graphics Tablets            |
| Joysticks/Keyboards/ Power Supplies            |
| Labels/Mice/Stands/Surge Protectors            |
| LOW PRICES . . . . . CALL                      |

HOURS: MON - FRI 7AM - 6PM/SAT 9AM - 2PM  
IN ARIZONA CALL (602) 437-4855

CompuSave: 4207 S. 37th St., Phoenix, AZ 85040/For Customer Service Call (602) 437-4856/Prices Reflect Cash Discounts And Are Subject To Change Without Notice/Minimum Shipping Charge \$4 Purchase Orders & Major Credit Cards Welcome

## THE UNBEATABLE PRICES!

### 2 SPEEDS TURBO SYSTEM FULLY IBM PC/XT COMPATIBLE 4.77/8MHZ



- 640K on Board RAM
- 2 Floppy Disk Drives
- Disk Controller Card
- 150W Power Supply
- FCC Type Slide Case
- 'AT' Style Keyboard
- 8 IBM I/O Slots
- 8088-2 Micro Processor
- 8087 Co-Processor Socket
- 4.77 MHz/8MHZ Clock Selectable
- Monitor and Display Card Not Included

Fully Assembled and Tested . . . . . **\$595<sup>00</sup>**  
(Other Options and Configurations Available, Please Call.)

### PINECOM AT SYSTEM FULLY IBM AT COMPATIBLE



- 8/6 MHz Clock Selectable
- 80286 CPU
- 1.2 MGB Floppy Drive
- 200 Watts Power Supply
- Hard Disk/Floppy Disk Controller
- 512K RAM Expandable to 1 MGB
- Clock Calendar w/Battery Backup
- 'AT' Style Keyboard

Fully Assembled and Tested . . . . . **\$1490<sup>00</sup>**  
(Hard Disk Available, Please Call.)



## pinecom™

### SPECIAL SALE ITEMS

|                                                                                                              |                           |
|--------------------------------------------------------------------------------------------------------------|---------------------------|
| 20 MGB Hard Disk w/Controller (ST-225) . . . . .                                                             | <b>\$390<sup>00</sup></b> |
| 300/1200 Modem Card Hayes Compatible . . . . .                                                               | <b>\$135<sup>00</sup></b> |
| EGA Card With Printer Port and 256K . . . . .                                                                | <b>\$260<sup>00</sup></b> |
| Tape Back Up Irwin 10 MGB . . . . .                                                                          | <b>\$360<sup>00</sup></b> |
| 3M 10 MGB Tape For Irwin . . . . .                                                                           | <b>\$25<sup>00</sup></b>  |
| Logitech Mouse System With Software . . . . .                                                                | <b>\$85<sup>00</sup></b>  |
| Samsung T.T.L. Monochrome Monitor (Amber) . . . . .                                                          | <b>\$85<sup>00</sup></b>  |
| Mitsubishi RGB Color Monitor (12") . . . . .                                                                 | <b>\$265<sup>00</sup></b> |
| TVM 3 Way RGB Color Monitor (13") . . . . .                                                                  | <b>\$340<sup>00</sup></b> |
| V-20 Ny NEC Turbo Speed Processor . . . . .                                                                  | <b>\$16<sup>00</sup></b>  |
| 8087 Co-Processor Chip . . . . .                                                                             | <b>\$120<sup>00</sup></b> |
| Surge Protected Outlet Strips, Master On/Off Switch,<br>Power on Light, Circuit Breaker, 6 Outlets . . . . . | <b>\$18<sup>00</sup></b>  |
| Monochrome Graphic Card w/Printer Port . . . . .                                                             | <b>\$75<sup>00</sup></b>  |
| Color Graphic Adapter w/2 Composite Ports . . . . .                                                          | <b>\$65<sup>00</sup></b>  |
| Eprom Writer Card With Software Read, Write,<br>Copy Verify Any Eprom 2716-27512 . . . . .                   | <b>\$95<sup>00</sup></b>  |
| Joystick For IBM With 2 Firebuttons . . . . .                                                                | <b>\$16<sup>00</sup></b>  |
| Game I/O Card For 2 Joysticks . . . . .                                                                      | <b>\$26<sup>00</sup></b>  |

Send One Dollar For Our New Catalog

**PINECOM COMPUTER INC.**  
9690 Telstar Ave., Suite 204  
El Monte, CA 91731

Phone: (818) 575-1882  
Telex: 5106017376 PINECOM  
Fax: (818) 575-1897

# DiskMASTER<sup>®</sup>

The Ultimate Diskette Value ...

Discover The Difference ...

2 FOR 1 LIFETIME WARRANTY

- Performance exceeds ANSI specifications by 62.5%
- Each diskette 100% tested and certified error free
- 65% clipping level • Over 10 million passes per track
- Reinforced Hubs • Tyvek<sup>®</sup> (not paper) sleeves

SS-DD • W/P tabs and ID labels OS-DD

**.54** 5 1/4" 48 TPI **.59**

Simply top Brand-Name Quality, made in the U.S.A. to our specifications by a leading manufacturer. Factory polybagged in lots of 25. Quantity discounts available.

## CenTech<sup>®</sup> America's Premium Quality Color Diskettes

- ✓ TIMELESS WARRANTY
- ✓ Performance exceeds A.N.S.I. specifications by 86%
- ✓ Each disk 100% tested and certified
- ✓ 14 COLORS for data organization
- ✓ Pkgs. of 10, Tyvek sleeves, w/p tabs, and ID labels

SS-DD QTY. 10 BOXES OR 100 DISKETTES OS-DD

**.74** 5 1/4" Color, BOXED, 48 TPI **.98**

**1.39** 3.5" Color, BOXED **1.99**

**.64** 5 1/4" Color, BULK, 48 TPI **.88**

**1.30** 3.5" Color, BULK **1.92**

High Density, Color, 1.6mb, IBM AT Compatible **2.05**

Includes Tyvek sleeves, w/p tabs, ID labels  
Call for excellent prices on other CenTech products



America's No. 1 Name-Brand Diskettes

- ✓ LIFETIME WARRANTY
- ✓ High quality and consistently reliable
- ✓ More rigid jackets than ever before

SS-DD QTY. 5 BOXES OS-DD

**.74** 5.25, 48 TPI **.99**

**1.35** 3.5, 135 TPI **1.95**

DS-HD 96 TPI, IBM AT Compatible **2.09**

Call for best 3M prices on head cleaning and data cartridges.

**Nashua<sup>™</sup>** Affordable Quality Incredible Value Best Prices Ever!

- ✓ LIFETIME WARRANTY
- ✓ Factory Fresh in BOXES of 10 with sleeves, w/p tab, ID labels

SS-DD QTY. 10 BOXES OS-DD

**.63** 5.25, 48 TPI, box of 10 **.69**

**1.59** 3.5", 135 TPI **2.19**

High Density, IBM PC-AT Compatible **2.09**

**BULK SPECIAL OF THE MONTH**  
Made in U.S.A.

- ✓ LIFETIME WARRANTY
- ✓ Exceeds ANSI specifications
- ✓ Includes Tyvek sleeves and w/p tab

5 1/4 DS-DD **38¢** MULTIPLES OF 100

### ORDERING INFORMATION

TERMS: Free use of VISA, Mastercard, and American Express. P.O. orders accepted from recognized corporations rated 3A2 or better, government and schools on 2%—net 30. PAYMENT: Add \$3.00 per 100 diskettes or fraction thereof, add \$3.00 for head cleaning kit or dozen ribbons, add \$3.00 for COD orders. PRICE PROMISE: We will better any lower delivered price on the same products and quantities advertised nationally.

Toll Free Order Line: **1-800-233-2477** 1-801-561-0092

**Computer Affairs, Inc.**

199 Cottage Avenue  
Salt Lake City, Utah 84070  
Hours: 9am to 5pm (mtn. time)

# 6800/6809 Micro Modules



OEM 6800/6809 MICROCOMPUTER MODULES for dedicated control and monitoring. Interfaces for sensors, transducers, analog signals, solenoids, relays, lamps, pumps, motors, keyboards, displays, IEEE-488, serial I/O, floppy disks.

**WINTERK** Wintek Corp. 1901 South Street Lafayette, IN 47904 317-742-8428

Inquiry 381

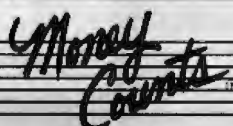

## COMPLETE MONEY MANAGEMENT FOR HOME AND BUSINESS.

- Checking, Savings and Credit Card Mgmt.
- Smart Account Reconciler With Automatic Error Detector
- Budgeting • CPA Designed • Financial Statements • Graphics
- On-Line Help Screens • High Speed Financial Data Base • Inquiry Reports • Pop-Up Calculator • Tutorial
- Not copy protected • Simplifies Tax Preparation • Much More.

Only \$69.95

Visa • MC • C.O.D. Free Brochure 319/373-0197

### PARSONS TECHNOLOGY

6925 Surrey Drive NE Cedar Rapids, IA 52402

Inquiry 264

Beat the limits!

# Vfeature<sup>™</sup> DELUXE

Software for hard disks

- DOS partitions to 1 GIGABYTE
- Spans two drives in one bootable partition
- Supports big drives on AT and XT
- Secures data

## GOLDEN BOW SYSTEMS

\$120

\$3 shipping/handling California orders add 6%



2670 Filth Avenue Suite 201 San Diego, CA 92103 **619/298-9349**

Inquiry 144



! not only a printer buffer !

THIS IS THE MOST SOPHISTICATED PRINTER BUFFER - MULTIPLEXOR - SWITCH

WITH TWO SEPARATE INPUT (SERIAL AND PARALLEL) AND TWO SEPARATE OUTPUTS (SERIAL AND PARALLEL) CAN BE USED LIKE STANDARD BUFFER WITH ANY INPUT TO ANY OUTPUT BUT ALSO YOU CAN CONNECT 1 COMPUTER TO 1 PRINTER OR 1 COMPUTER TO 2 PRINTERS OR 2 COMPUTERS AND 2 PRINTERS AND MORE • 1 COMPUTER TO 2 PRINTERS OR 2 COMPUTERS TO 1 PRINTER

DCB-A-64K \$ 195 DCB-B-256K \$ 255

(\*) Power supply and parallel cable are included

ALSO, WE HAVE THE MOST COMPLETE DATA CONVERTER UNIT CONVERTS RS232 SERIAL TO CENTRONICS PARALLEL OR VICE VERSA, JUST BY MOVING JUMPER BAUD RATE AND PROTOCOL FULLY PROGRAMMABLE FROM 150 TO 19200 BAUDS INCLUDES DTR, RTS, XON/XOFF, PARITY, etc

DCU \$ 80

(\*\*) Power supply and cable NOT included



serial to parallel bi-directional converter



INTECTRA Inc - Dept 232

7029 TERMINAL BLVD

MOUNTAIN VIEW, CA 94038

(415) 967-8818 TX 345545

# 68000

**FHL QT Plus**

- Multi-user/Multi-tasking
- 16/32-Bit 68000 CPU — 10 MHz
- 4 to 8 Users
- 512Kb RAM to 1024Kb RAM
- 2 to 3 8-Bit Parallel I/O Ports
- Hard Drive (20 Mb or 30 Mb)
- 720Kb Floppy Drive
- Software included: OS9/68000; Basic; Word Processing; Spreadsheet; Utilities
- Options: 512Kb RAM Board, 4 Serial Port Board, 4 Port S30 I/O Board, Pascal and C

Dealer Inquiries Invited  
**Frank Hogg Laboratory, Inc.**  
315-474-7856 TELEX 646740

Inquiry 136

## American Semiconductor

256K \$1.99!

### THE BARE XT TURBO SYSTEM

**\$399**

\*Looks, feels, and acts like an IBM, AND it's 20% compatible

|            |       |         |                           |
|------------|-------|---------|---------------------------|
| 8087       | ..... | \$19.00 |                           |
| 80287      | ..... | 175.00  |                           |
| 64K        | ..... | .99     |                           |
| 41256K-150 | ..... | 2.39    | V-20 FLOPPY ..... \$14.00 |
| 41256K-200 | ..... | 1.99    |                           |

XT & AT ADD ON CARDS  
For AT, XT, Compaq, & Corona:

20MB Hard Drive **\$325** 30MB Hi-Speed FLL KIT **\$499**

**TO ORDER TOLL FREE CALL 1-800-237-5758, EXT. 815**

Inside Florida 813-961-9444 Technical Line 1-813-961-5584  
Prices subject to change. Add 3.2% for VISA/MC purchases.  
16520 N. Florida Ave., Lutz, Florida 33549

Inquiry 20

## U.L. Rated • High Reliability • Full Technical Support

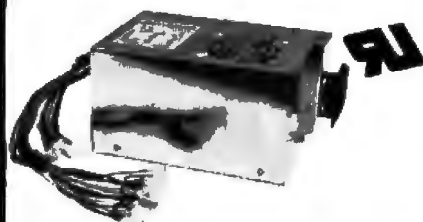

140W (Typ.) 150W(Max.)  
 PCI/XT \$129.00

- U.L. recognized, yellow card available File # E-101115(S)
- Meet FCC class B, European safety spec.
- 115/230V AC convertible
- Low noise DC fan
- OVP, OCP, short circuit protection
- IBM® standard pin out or Faraday type pin out selectable
- 100% 24 hrs. burn-in 100% pre-shipment test.
- One full year warranty

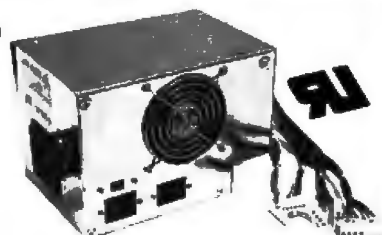

FC 5192 200W (max)  
 PC/AT \$189.00

Your PC represents a substantial investment. It does not make sense to risk costly down time due to bargain power supply, when for a few dollars more you can have the confidence of FORTRON QUALITY.

IBM is a registered trademark of International Business Machines.

## PROFITABLE DISCOUNT PRICES FOR SYSTEM INTEGRATORS & DEALERS - PLEASE CALL

|                                                                                                                                                                                                                                                                                                                             |                                                                                                                                                                                                                                                                                                                                                                                                                                                  |                                                                                                                                                                                                                                                                                                                              |                                                                                                                                                                                                                                                                                                                                                                                              |                                                                                                                                                                                                                                                                                                                                                                    |                                                                                                                                                                                                                                                                                                                         |
|-----------------------------------------------------------------------------------------------------------------------------------------------------------------------------------------------------------------------------------------------------------------------------------------------------------------------------|--------------------------------------------------------------------------------------------------------------------------------------------------------------------------------------------------------------------------------------------------------------------------------------------------------------------------------------------------------------------------------------------------------------------------------------------------|------------------------------------------------------------------------------------------------------------------------------------------------------------------------------------------------------------------------------------------------------------------------------------------------------------------------------|----------------------------------------------------------------------------------------------------------------------------------------------------------------------------------------------------------------------------------------------------------------------------------------------------------------------------------------------------------------------------------------------|--------------------------------------------------------------------------------------------------------------------------------------------------------------------------------------------------------------------------------------------------------------------------------------------------------------------------------------------------------------------|-------------------------------------------------------------------------------------------------------------------------------------------------------------------------------------------------------------------------------------------------------------------------------------------------------------------------|
| <b>FC 620</b><br>Color Graphic/<br>Mono/Printer<br><br><ul style="list-style-type: none"> <li>• TTL / composite level outputs</li> <li>• 320 x 200 (color) 640 x 200 (B&amp;W)</li> <li>• Centronics Printer Port</li> </ul> <b>\$99.00</b> | <b>FC 550 (CT-6040)</b><br>Monochrome / Graphic /<br>Printer<br><br><ul style="list-style-type: none"> <li>• 80 x 25 text mode</li> <li>• 720 x 348 graphic mode</li> <li>• Run Local 1-3-3 auto cad, etc.</li> <li>• IBM® compatible</li> </ul> <b>\$99.00</b>                                                                                                 | <b>FC 730 (CT-6050C)</b><br>384K Multifunctions<br><br><ul style="list-style-type: none"> <li>• Memory expansion to 284K</li> <li>• Clock / calendar</li> <li>• Serial, parallel ports</li> <li>• Game port</li> </ul> <b>(MS) \$119.00</b> | <b>FC 740</b><br>Multi-I/O<br>w/Floppy Controller<br><br><ul style="list-style-type: none"> <li>• 1 EIA-RS232C port (2nd optional)</li> <li>• 1 Centronics port, game port</li> <li>• Clock / calendar</li> <li>• Control 2 floppy drives</li> <li>• FC 770 w/o Floppy Controller</li> </ul> <b>\$99.00</b> | <b>FC 1730</b><br>Multifunction Card<br>for PC AT<br><br><ul style="list-style-type: none"> <li>• 1 EIA-RS232C port (2nd optional)</li> <li>• 128K to 1.5 MB memory</li> <li>• Expandable to 3 MB (optional) by piggy back board</li> <li>• Game port</li> </ul> <b>\$189.00</b> | <b>FC 1930</b><br>RS232C/Printer Port<br>for PC AT<br><br><ul style="list-style-type: none"> <li>• 1 EIA RS232C port (2nd optional)</li> <li>• Centronics parallel port</li> </ul> <b>\$99.00</b>                                    |
| <b>FC 940</b><br>RS232C/Real Time Clock<br><br><ul style="list-style-type: none"> <li>• RS232C port</li> <li>• To 86501 board</li> <li>• Battery back-up</li> </ul> <b>\$59.00</b><br>(clock only) <b>\$49.00</b>                          | <b>Hard Disk Controller</b><br><br>Hard Disk Controller for XT<br><ul style="list-style-type: none"> <li>• DTC 5150 BX \$149.00</li> <li>• WD Wx-2 (Western Digital) \$145.00</li> <li>• Cable \$ 9.90</li> <li>• F.D. 3 H.D. Controller for AT</li> <li>• DTC 5350 \$256.00</li> <li>• Western Digital Wx-2 \$298.00</li> <li>• Cable Set \$ 18.00</li> </ul> | <b>FC 230</b><br>Floppy Disk Controller<br><br><ul style="list-style-type: none"> <li>• Drives up to four 5 1/4" floppy drives</li> <li>• IBM compatible</li> <li>• With cables</li> </ul> <b>\$59.00</b>                                  | <b>XT CPU Board</b><br><br>FC 150 H 77 MHz \$148.00<br>FC 180 H 80 MHz \$189.00<br><ul style="list-style-type: none"> <li>• Expandable to 640K on board memory</li> <li>• Optional 8087 co-processor</li> <li>• Optional IBM® comp. BIOS</li> </ul>                                                        | <b>Modems \$149.00</b><br><br><b>INTERNAL Hayes Compatible</b><br>1200 Baud ..... \$148.00<br>2400 Baud ..... \$425.00                                                                                                                                                          | <b>SPECIAL</b><br><ul style="list-style-type: none"> <li>• FC 830 512K memory exp. card . . . \$69.00</li> <li>• FC 830S 576K memory exp. card . . . . . \$89.00</li> <li>• FC 930 serial/parallel adaptor for XT . . . . . \$49.00</li> <li>• FC 530 monochrome controller w/printer port . . . . . \$79.00</li> </ul> |

**Enhanced Graphic Adaptor**  
 IBM® Compatible **\$239.00**



w/o printer port



w/ printer port

**EGA Monitor \$459.00**

- For PC/XT/AT and compatibles
- 256K on board memory
- Full 16 colors in 640 x 350 on IBM® enhanced color display
- Support 640 x 350 IBM® compatible enhance color and monochrome monitors
- Parallel port - Light pen interface

**FORTRON 200**  
 U.P.S. for PC



- 115V / 230V AC input convertible
- Input current 2.5 amp
- 200W continuous
- 1/2 cycle (typical) transfer time
- Hold-up time from 20 minutes (200W) up to 60 minutes (60W)
- 6 1/2" x 7 7/8" x 13 1/8"

**\$259.00**

**FC 447**  
 PC/AT Keyboard



- IBM AT compatible keyboard
- Eriatec return key
- Light on num. lock key

**\$109.00**

**FC 427 (5150 Type) \$79.00**



**FC 437 (5151 Type)**



- For PC XT
- Larger return key
- Light on num. lock keys

**\$99.00**

## CABINETS & EXPANSION CHASSIS

|                                                                                                                                                                                                                                                                                                             |                                                                                                                                                                                                                                                                                            |                                                                                                                                                                                                                                                                                                                                |                                                                                                                                                                                                                                                                                                                                                                                                             |                                                                                                                                                                                                                                                                                                                                                                               |                                                                                                                                                                                                                                                                                                                                                                                                      |
|-------------------------------------------------------------------------------------------------------------------------------------------------------------------------------------------------------------------------------------------------------------------------------------------------------------|--------------------------------------------------------------------------------------------------------------------------------------------------------------------------------------------------------------------------------------------------------------------------------------------|--------------------------------------------------------------------------------------------------------------------------------------------------------------------------------------------------------------------------------------------------------------------------------------------------------------------------------|-------------------------------------------------------------------------------------------------------------------------------------------------------------------------------------------------------------------------------------------------------------------------------------------------------------------------------------------------------------------------------------------------------------|-------------------------------------------------------------------------------------------------------------------------------------------------------------------------------------------------------------------------------------------------------------------------------------------------------------------------------------------------------------------------------|------------------------------------------------------------------------------------------------------------------------------------------------------------------------------------------------------------------------------------------------------------------------------------------------------------------------------------------------------------------------------------------------------|
| <b>FC 630 A-2</b><br>XT CHASSIS<br><br><ul style="list-style-type: none"> <li>• For PC XT compatible auto switch</li> <li>• To use FC 136-40 power supply</li> <li>• Complete mounting hardware</li> </ul> <b>\$79.00</b> | <b>FC 620</b><br>AT CHASSIS<br><br><ul style="list-style-type: none"> <li>• For PC AT compatible</li> <li>• LED lamps, key, key lock, speaker and mounting hardware included</li> </ul> <b>\$139.00</b> | <b>FC 610</b><br>Drives Chassis<br><br><ul style="list-style-type: none"> <li>• 10" x 8" x 6"</li> <li>• Capable of holding 2 half-height drives</li> <li>• Comes w/ power supply, fan &amp; LED power indicator</li> </ul> <b>\$149.00</b> | <b>FC 640/8 Slots</b><br>PC Expansion Chassis<br><b>\$388.00</b><br><br><ul style="list-style-type: none"> <li>• W/ 5 slot bus board</li> <li>• 100W power supply, fan</li> <li>• Capable of holding 3 half-height drives</li> <li>• Dim. 18 1/2" x 18" x 6 1/4"</li> <li>• System interface adaptor included</li> </ul> | <b>FC 650/8 Slots</b><br>PC Expansion Chassis<br><b>\$398.00</b><br><br><ul style="list-style-type: none"> <li>• PC XT identical slot</li> <li>• W/ 8 slot bus board</li> <li>• 140W power supply</li> <li>• 4 half-height drives</li> <li>• System interface adaptor included</li> </ul> | <b>FC 660/12 Slots</b><br>PC Expansion Chassis<br><b>\$438.00</b><br><br><ul style="list-style-type: none"> <li>• Dim. 18 1/2" x 18 1/2" x 6 1/4"</li> <li>• W/ 12 slot bus board, power supply, fan</li> <li>• Capable of holding 2 half-height drives</li> <li>• System interface adaptor included</li> </ul> |
|-------------------------------------------------------------------------------------------------------------------------------------------------------------------------------------------------------------------------------------------------------------------------------------------------------------|--------------------------------------------------------------------------------------------------------------------------------------------------------------------------------------------------------------------------------------------------------------------------------------------|--------------------------------------------------------------------------------------------------------------------------------------------------------------------------------------------------------------------------------------------------------------------------------------------------------------------------------|-------------------------------------------------------------------------------------------------------------------------------------------------------------------------------------------------------------------------------------------------------------------------------------------------------------------------------------------------------------------------------------------------------------|-------------------------------------------------------------------------------------------------------------------------------------------------------------------------------------------------------------------------------------------------------------------------------------------------------------------------------------------------------------------------------|------------------------------------------------------------------------------------------------------------------------------------------------------------------------------------------------------------------------------------------------------------------------------------------------------------------------------------------------------------------------------------------------------|

**MONITORS \$89.00**

- **Monochrome**  
 Tatung MM 1223 A/G \$109.00  
 Samsung \$89.00
- **Color Hi-Res (640 x 200)**  
 Tatung CM-1280 \$389.00
- **Enhanced Graphic (640 x 350)**  
 Tatung CM-1280 \$469.00  
 Protostar HC-12E \$539.00  
 Mitsubishi EGA \$629.00  
 Quanta PX-22 \$469.00

**DISK DRIVES**

- Floppy  
 Teac 550V \$108.00  
 1.2 MB 560V \$148.00
- Hard (w/ controller & cable)  
 10 MB \$375.00  
 20 MB ST-025 \$399.00  
 • 20 MB ST-025 (40 MB) drive only \$375.00  
 \$669.00  
 • 31 MB CM-0640 (40 MB) drive only. \$408.00

**Tape Back-Up**  
 (w/ controller, cable & tape)



**INTERNAL**  
 Sygen 20 MB ..... \$575.00  
 Sygen 50 MB ..... \$745.00

**EXTERNAL**  
 Sygen 20 MB ..... \$749.00  
 Sygen 50 MB ..... \$955.00

**Printers \$89.00**



Aomec DP-130 \$109.00

- 120 C.P.S.
- 20 columns
- 8 x 5 dot matrix font
- Parallel standard interface
- TRX-20 \$ 89.00
- 80 C.P.S.
- 80 columns
- Parallel standard interface
- Thermal printer

**RAM CHIPS**

- 84K RAM \$11.00 / 9 pc.
- 256K \$33.00 / 9 pc.
- 512K \$44.00 / 9 pc.

(for PC AT)

**Terms:**

- Min shipping & handling \$6.00
- CA res. add 5% tax
- Restocking charge 15%
- No r/n goods w/o a RMA no.
- Prices subject to change w/o notice

**MSO**  
**MICRO**  
**SUPPLY**  
 ORGANIZATION INC.

# the giveaway.

MSO, the leader in cost effective computer systems, is offering the Sanyo MBC 1200 at a **giveaway price!**

The **MBC 1200 Accounting Software** -G/L, A/R, A/P, Inventory and Payroll modules retail for \$398 per module. Now from MSO you pay only **\$99 per module** or all five for **\$299!** Second disk drive with fan-option available. **COMPAT** disk utility available.

**SPECIFICATIONS:**

- Two Z-80A (main and subsidiary) CPUs with no-wait mode for fast execution, substantial memory capacity (RAM 64KB, ROM 4KB).
- High-resolution full graphic function with 640 x 400 dot matrix display.
- Choice of 33 or 40 line text mode.
- CP/M operating system complete with interpreter, editor and all utilities.
- Easy-to-use Sanyo graphic BASIC.
- One (MBC 1200) or two (MBC 1250) internal double-sided, double-density, double-track, 5 1/4" slim-type 640KB formatted mini floppy disk drives.
- Special design featuring detachable ergonomic keyboard with coiled cable.
- Interfaces for Centronics printer and one RS-232C port provided.

20 meg internal hard drive sub-system for Sanyo MBC 1100, 1160 & 1200

**\$599** (with purchase)

Printer specials with purchase

**805/393-2247**

All systems carry full 90 day warranty.

**CASH PRICE ONLY**

Check in advance. Add 3% for VISA/MC. Shipping & handling charges will be added to each order.

For our catalog with complete details and prices, send \$2 to:

Micro Supply Organization, Inc.  
 4909 Stockdale Hwy. #180  
 Bakersfield, CA 93309



15% Restocking on Returned Orders

**SANYO**  
**MBC 1200**

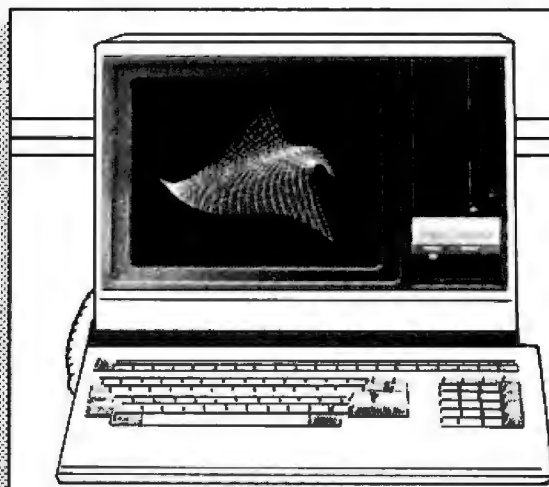

**FREE SOFTWARE**

- Wordstar • Spellstar
- Calcstar • Mailmerge
- Infostar • Basic

**\$399**

**P.C. MEMORY HOT LINE**  
LEADER IN WHOLESALE PRICING  
(MAJOR AMERICAN/JAPANESE)  
DRAM CHIPS

|                       |        |
|-----------------------|--------|
| ✓/4164                | \$0.99 |
| ✓/41256               | \$2.30 |
| ✓/IBM PC-AT CMPTBL.   | \$999  |
| ✓ XT CMPTBL.          | \$555  |
| ✓/20MB HD/HH + CNTRLR | \$389  |

**SEAGATE HARD DRIVES:**

|                       |       |                    |       |
|-----------------------|-------|--------------------|-------|
| ST4051-251 50MB FH/HH | \$899 | PC F D HH          | \$ 75 |
| 51225 20MB HH         | \$299 | PC-AT F D HH       | \$149 |
| WSTRN DKG CNTRLR WX2  | \$ 99 | MODEM 1200 XTARL   | \$129 |
| 50MB HD/HH + CNTRLR   | \$849 | DSK HEAD CLNG KIT  | \$ 4  |
| TEAC 558V F D         | \$ 99 | PRINTER - MONITORS | CALL  |
| PC-AT CMPTBLE M BOARD | \$575 | CONTROL BOARDS     | CALL  |

|                   |          |                |        |
|-------------------|----------|----------------|--------|
| <b>PROCESSORS</b> |          | <b>EPROMS:</b> |        |
| 8087-2 8MHz       | \$180.00 | 27C256 250ns   | \$8.00 |
| 8087-3 8MHz       | \$120.00 | 37256 250ns    | \$6.00 |
| 80287-3 8MHz      | \$130.00 | 27128 250ns    | \$3.25 |
| 80287-8 8MHz      | CALL     | 2764 250ns     | \$3.00 |

Many 8000 series in stock

Also we carry 7500, 74S, 74LS, 74ALS, 74HC, 74HCT, ECL, in stock. Also diskettes, floppies, drives, monitors, add-ons for PC, XT, AT, peripherals, PC, XT, AT compatibles.

PLEASE CALL FOR VOLUME DISCOUNT  
Technical and Volume Discount Call (818) 376-1440  
ORDER TOLL FREE-800, Cash or Cashier's Check Only  
1-800-423-6824/California residents 1-800-352-5689  
(Min. order \$150)

**RS-232**

**Communications Board**

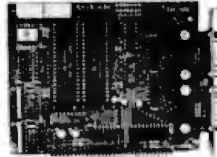

- For IBM-PC/XT/AT & comp.
- Dual RS-232C interface
- Optional software supports COM1, COM2, COM3, COM4
- Jumper selectable interrupts

**Fast Delivery**  
**QUA TECH, INC.**

478 E. Exchange St. Akron OH 44304  
(216) 434-3154 TLX: 5101012726

**NEW DEALER SPECIAL**

|                               |                |
|-------------------------------|----------------|
| <b>XT-COMPUTER</b>            | <b>97Y</b>     |
|                               | <b>2</b>       |
| 640K MOTHER BOARD W/OK        | 89             |
| 256K RAM                      | 27             |
| 135 WATT POWER SUPPLY         | 53             |
| FLOPPY DISK CONTROLLER        | 27             |
| FLIP TOP BOX                  | 38             |
| XT/AT KEYBOARD                | 50             |
| MONO/GRAPHICS/PRN (HERC)      | 54             |
| TTL MONITOR W/SWIVEL          | 96             |
| (1) 360K FLOPPY               | 92             |
| <b>PARTS</b>                  | <b>\$535</b>   |
| <b>ASSEMBLY &amp; TEST</b>    | <b>84</b>      |
|                               | <b>\$689</b>   |
| <br>                          |                |
| 20 MEG HARD DISK W/CONTROLLER | 425            |
| <br>                          |                |
| <b>AT COMPUTER</b>            | <b>97Y</b>     |
|                               | <b>2</b>       |
| 80286 MOTHER BOARD            | 595            |
| W 512K RAM                    |                |
| 200 W POWER SUPPLY            | 96             |
| AT BOX W/KEY LOCK             | 79             |
| SERIAL & PARALLEL CARD        | 65             |
| AD KEYBOARD                   | 59             |
| 1.2 M FLOPPY                  | 129            |
| FDD & HDD CONTROLLER CARD     | 225            |
| <b>PARTS</b>                  | <b>\$1,250</b> |
| <b>ASSEMBLY &amp; TEST</b>    | <b>150</b>     |
|                               | <b>\$1,400</b> |
| <br>                          |                |
| 30 MEG 40 MSEC HARD DRIVE     | 615            |
| EGA CARD                      | 295            |
| EGA MONITOR                   | 449            |

|                            |              |
|----------------------------|--------------|
| <b>XT PORTABLE</b>         | <b>\$995</b> |
| 640K MOTHER BOARD          |              |
| 640K RAM                   |              |
| MULTI I/O CARD             |              |
| CLOCK, CALENDAR,           |              |
| SERIAL,                    |              |
| PARALLEL                   |              |
| TWO 360K                   |              |
| FLOPPY DRIVES              |              |
| MONO/GRAPHICS/PRN (HERC)   |              |
| DETACHED KEYBOARD          |              |
| 135 W POWER SUPPLY         |              |
| PORTABLE CASE              |              |
| 9" MONITOR, GREEN or AMBER |              |



**ADD ON BOARDS - PARTIAL LIST**

|                                               |     |
|-----------------------------------------------|-----|
| XT-640K TURBO 4.77/8 MHZ W/OK                 | 99  |
| LOCAL AREA NET CARD W/SOFTWARE                | 249 |
| 384K MULTI-FUNCTION (AST & COMP) OK           | 69  |
| MODEM CARD 300/1200 (HAYES COMP)              | 149 |
| DISK I/O 2FD CTRL, PRN, SER, CLOCK, CAL, GAME | 70  |
| AB SWITCH BOX W/64K BUFFER (1:2 or 2:1)       | 94  |
| AB SWITCH BOX (1:2 or 2:1)                    | 29  |
| COLOR/GRAPHICS/PRINTER CARD RGB               | 58  |

**ACS IMPORTERS**  
5311 DERRY AVE. UNIT A  
AGOURA HILLS, CA 91301  
HOURS 9 AM - 6 PM PST  
(818) 889-1092  
TELEX: 299353 POST UR

Inquiry 101

**INI-10/AT**  
**PC-AT EXPANSION CHASSIS**

- Full 16-bit PC-AT bus
- 10 slots
- 250W power supply
- Two fans
- Direct extension of PC-AT bus
- No software changes needed
- Inexpensive, simple, attractive

Dealer Inquiries Invited.  
List Price \$1,400.00

**INI Computer Products**  
8915 Hightech Drive  
Midvale, UT 84047  
(801)561-1100  
Contact Mark Jenkins

Inquiry 170

**MODULAR DATA ACQUISITION**

- For IBM & Compatibles
- Flexible and Inexpensive
- Money Back Guarantee
- Free Technical Support

**Fast Delivery**  
**QUA TECH, INC.**  
478 E. Exchange St. Akron OH 44304  
(216) 434-3154 TLX: 5101012726

Inquiry 285

Inquiry 284

**LOW COST UNIVERSAL PROGRAMMER KITS**

- \* NO PERSONALITY MODULES REQUIRED
- \* ON LINE HELP AND MENU SELECTION
- \* ON BOARD 110/220V POWER SUPPLY
- \* FAST PROGRAMMING MODE AT 6V VCC
- \* BUILT IN MONITOR FOR I/O DEBUG
- \* CAD PCB, SILKSCREEN & SCHEMATIC
- \* SOFTWARE DRIVERS FOR MOST PCs
- \* SUPPORTS ALL 5V EPROMS, EEPROMS AND INTEL MICROCOMPUTERS

KITS FROM \$125 ASSEMBLED \$295  
DRIVERS \$35 SHIPPING \$4  
VISA & MASTER CARD ACCEPTED

**B&C MICROSYSTEMS**  
6322 MOJAVE DR. SAN JOSE CA 95120  
PHONE (408)997-7685 TELEX 4995363

**UNIVERSAL EPROM PROGRAMMER**

- \* NO PERSONALITY MODULES REQUIRED
- \* ON LINE HELP AND MENU SELECTION
- \* ON BOARD 110/220V POWER SUPPLY
- \* FAST PROGRAMMING MODE AT 6V VCC
- \* BUILT IN EPROM ERASER W/TIMER
- \* GANG PORT FOR FUTURE EXPANSION
- \* SOFTWARE DRIVERS FOR MOST PCs
- \* SUPPORTS ALL 5V EPROMS, EEPROMS AND INTEL MICROCOMPUTERS

1409C-33 \$545 1409C-34 \$695  
DRIVERS \$35 SHIPPING \$6  
VISA & MASTER CARD ACCEPTED

**B&C MICROSYSTEMS**  
6322 MOJAVE DR. SAN JOSE CA 95120  
PHONE (408)997-7685 TELEX 4995363

# A SOFTWARE DEVELOPER'S DREAM

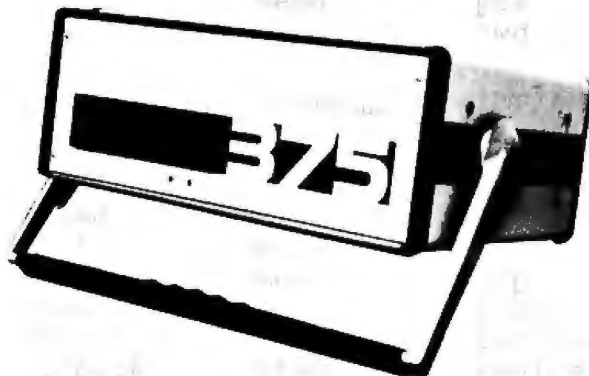

## THE BEAUTY AND THE BSD

# \$4,995\*

### We've Finally Tamed the Beast!

#### Full 4.2BSD UNIX™

Each 375 comes standard with a complete 4.2BSD UNIX system. We don't skimp on software. And we can even give you EMACS, INGRES, TEX and SPICE for those special applications.

#### Loaded with Languages

Turn on your 375 and start developing your own applications. It's that easy. C, FORTRAN, PASCAL, BASIC, APL, Assembler, LISP and PROLOG: they all come standard on every 375.

#### A Portable Computer for the Serious User

At last, a powerful, portable (22lbs) scientific computer for all your serious work. The 375 combines the advantages of a VAX™ with the size, versatility, and price of a micro. All the software tools are there. It's even small enough to leave on your desktop or take wherever you need it. And it's available direct to you right now!

### Specifications:\*

#### Standard 375 Features:

**Processor:** Series 39000™, 10 MHz, virtual memory. FPU  
**Main Memory:** 2 MB RAM, no wait states.  
**Disk Memory:** 50 MB Winchester. 1 MB 5¼-inch floppy.  
**Serial Ports:** Four RS-232, integral FIFO, up to 38.4 KBAUD  
**Printer Port:** Configurable Centronics parallel.  
**Size:** 14 x 12 x 6 inches, 22 lbs.

#### Options:

**Ethernet:** 10 Mbit, TCP/IP.  
**Main Memory:** 8 MB RAM, no wait states.  
**Disk Memory:** up to 280 MB.  
**Expansion Interface:** SCSI, with optional cartridge streaming tape.  
**Spreadsheet:** Q-CALC™.  
**LEASE FOR \$147/ month.**

### CALL US TODAY

# SYMMETRIC

COMPUTER SYSTEMS

1620 Oakland Road, Suite D200  
San Jose, CA 95131-408/279-0700

\* Prepaid Sales tax and Shipping Costs not included

UNIX is a registered trademark of AT&T Bell Labs. Q-CALC is a trademark of Quality Software Products. VAX is a trademark of Digital Equipment Series 39000 is a trademark of National Semiconductor Corp

\*\* Specifications subject to change without notice



## DYNAMIC RAMS

|        |       |                   |
|--------|-------|-------------------|
| 41256  | 100ns | \$4.85            |
| 41256  | 120ns | \$2.95            |
| ✓41256 | 150ns | <del>\$2.70</del> |
| 4164   | 120ns | \$1.40            |
| ✓4164  | 150ns | <del>\$1.10</del> |
| 4464   | 150ns | \$3.95            |

| PROCESSORS  |                | E. PROMS         |              |
|-------------|----------------|------------------|--------------|
| 8087-2      | 8MHz \$159.00  | 27C256           | 250ns \$8.50 |
| 8087-3      | 10MHz \$115.00 | 27256            | 250ns \$3.28 |
| 80287-3     | 8MHz \$179.00  | 27150            | 250ns \$3.99 |
| 80287-8     | 8MHz \$ CALL   | 27C84            | 200ns \$4.90 |
| V-20        | 8MHz \$ 12.75  | 2794             | 250ns \$3.28 |
| V-30        | 8MHz \$ 14.00  | 2732A            | 250ns \$3.75 |
| STATIC RAMS |                | 8000's           |              |
| 6264LP-15   | 150ns \$2.95   | (Parts in stock) |              |

## I.C. EXPRESS

15358 Valley Blvd., City of Industry, CA 91746  
Phone 818-369-2688 (Mon-Fri 8-5)

**ORDER TOLL FREE**  
**(800) 892-8888 • (800) 882-8181**

CALL FOR CURRENT PRICES & VOLUME DISCOUNTS  
Price shown for Cash + MasterCard VISA add 3% more  
Prices are subject to change. Minimum order \$10.00  
California residents must add 6.5% sales tax.  
Shipping & handling UPS Ground \$5.00 UPS Air \$7.00 (under 1 lb)  
ALL MERCHANDISE IS 100% GUARANTEED.

Inquiry 168

## CROSS-16 META ASSEMBLER

- Table driven 8/16 bit cross-assembler
- Tables & Example Source Files are included for ALL of the following processor families:
 

|       |      |       |      |
|-------|------|-------|------|
| 1802  | 3870 | 64180 | 6502 |
| 6801  | 6805 | 6809  | 6811 |
| 68000 | 8048 | 8051  | 8085 |
| 8086  | 8096 | Z8    | Z80  |
- Manual contains full instructions for creating new tables for other (future) processors.
- Produces 8/16 bit Intel and Motorola hexcode.
- 5" DSDD for PC/MS-DOS 2.0 or greater

**\$99.95 US      \$139.95 CDN**

Worldwide shipping (AIRMAIL) & handling included. Credit Card orders (\$139.95 CDN) please specify Card number, name on card and expiry date.

**Universal Cross-Assemblers**  
P.O. Box 384, Bedford, N.S.  
Canada B4A 2X3

Inquiry 361

## PROF JONES

1840 W. STATE ST.  
BOISE, IDAHO 83702  
ORDER LINE (208) 342-6939

### PROFESSIONAL HANDICAPPING SYSTEMS

**PROFESSIONAL SERIES™** (Thoroughbred/Greyhound/Roller) — The all new Professional Series™ represents the most advanced handicapping software available.

**Analysis Module™** — Complete but analysis highlights the basic Professional Series™ module. Full 50 tracks/analysis. \$249.95

**Factor Value/Multiple Regression Module™** — Factor Value Weighting highlights the advanced module. \$149.95

**Data Base Manager Module™** — Automatic storage of last 11 races highlights this module. (\$99.95 with Factor Value Module) \$199.95

**GOLD EDITION™** (Thoroughbred/Greyhound/Roller) — The classic Gold Edition™ from Prof Jones offers flexibility, results and ease of use.

**Gold Edition™** \$159.95

**Enhanced Gold Edition™** \$199.95

**Limited Gold Edition™** \$299.95

**Ultra Edition™** \$399.95

**Professor Pick Football™** — \$99.95 with software power savings \$149.95  
Professional Series™ \$199.95

**Expanded Lottery/Lotto Analysis™** — Lottery 3-4 games \$79.95 Lotto max of 50 plays \$99.95. Expanded Lottery/Lotto \$129.95

Handicapper & Mutuel Board and VHS Taping Tapes now available.

Terms: Free shipping on software. Add \$5.00 COD / \$6.00 UPS plus \$9.00. Cash/Personal/2nd money order only. 3% added personal checks. \*Cash only add 2% VISA, MC, AMEX. Prices subject to change.

## FREE CATALOG

Inquiry 278

## ANSI-CONSOLE™

The Integrated Console Utility™  
All the little things IBM forgot!  
for IBM—PC, XT, AT & clones.

- 1.2 to 3.0 times faster DOS & BIOS screen writing
- more escape sequences than ANSI.SYS
- usable in any language
- scroll recall facility
- compatibility w/PC & AT software
- full EGA support
- 255 character typeahead buffer
- increase key repeat rate
- no scroll blink for some adaptors
- VT 100/52 emulation
- auto dual screen disable
- keyboard induced breakpoints
- window support
- support for 50 line display
- many many more little features

400p Manual (w/ship case) & disk \$75, or just Shareware disk \$25. As described in *PC World* February 86, pg. 282 and in *Lotus* June 85, pg. 8.

**HERSEY MICRO CONSULTING, INC.**  
Box 8276J, Ann Arbor, MI 48107  
(313) 994-3259 x525 VISA/MC

Inquiry 160

## “CPYAT2PC”

### IS LIKE HAVING A FREE 360K FLOPPY DRIVE

Allows copying of IBM AT file for use on IBM PC's & compatibles with no modification of existing hardware or software. A 360K floppy drive is not required. CPYAT2PC may reside on your IBM PC/AT hard disk and copies 1 file or entire subdirectories in 1 step. Also runs on other AT compatibles such as COMPAQ 286, ZENITH Z-200, and KAYPRO 286i. Dealer inquiries welcome. **ONLY \$79 + shipping.**

**MICROBRIDGE COMPUTERS**  
Sky Way Building, Suite 125  
655 Sky Way, San Carlos, CA 94070  
(415) 593-8777 • (415) 595-2150

CHECK, COD WELCOME  
(Prepayment Required)

Inquiry 235

## IEEE 488 Interfaces

for instruments, plotters, printers, digitizers, PCs, Macintosh, etc.

Call or send for your **FREE** Technical Guide

**iOtech (216) 439-4091**

23400 Aurora Road  
Cleveland, Ohio 44146  
Telex via WUI 6502820864

Inquiry 424

## ORDER TOLL FREE 24 HOURS EVERY DAY 800-662-2686

### HARDWARE

#### COMPUTERS

IBM COMPATIBLES 640K Ram, Keyboard, 1 yr. war. w/1 Floppy... 599 Plus 20MB Hard Disk... 999

PANASONIC Business & Executive Partners... CALL

#### ATARI ST COMPUTERS... CALL

#### MODEMS, BOARDS, DRIVES

|                              |                                  |
|------------------------------|----------------------------------|
| Evercom 1200 Internal... 175 | Flashpak Turbo Board... 319      |
| Hoyes Modems... CALL         | SuPaK Plus 384K... 209           |
| Haba Modem 1200... 119       | SuPaK Premium 512K... 359        |
| Practical Modem 1200... 135  | Intel Above Board PC... 225      |
| AST-3G Model I EGA... 339    | Above Board PS... 289            |
| Bob 16... 469                | Above Board AT... 355            |
| Genoa Spectra... 318         | FalTree J-Ram 2... 135           |
| Genoa Spectrum... 249        | J-Ram 3/3AT... 179/239           |
| Hercules Graphics +... 189   | J-Loser 1... 189                 |
| Mono Graphics Card... 89     | Teconar Captain 384K... 199      |
| Sigma Turbo EGA... 689       | Practical 1200 Multiboard... 269 |
| STB EGA Plus... 309          | 20MB Hard Disk Kit... 419        |
| Teconar EGA Master... 285    | 30MB Hard Disk Kit... 509        |
| Video 7 Vega... 399          | Filecard 20MB... 609             |
| AST Advantage... 339         | Hardcard 20MB... 679             |
| AST Rampage... 239           | Onboard 30MB... 869              |
| AST Rampage AT... 439        | Imago 210H... 1949               |

#### PRINTERS, PLOTTERS & MONITORS

|                               |                            |
|-------------------------------|----------------------------|
| EPSON-All Models... CALL      | Amdk 600/722... 429/519    |
| Citizen 1200... 199           | NEC 1280 TTL Mono... 129   |
| Citizen Premiere 35... 509    | NEC 1401 Multi-Sync... 549 |
| Panasonic 1091... 249         | Samsung TTL... 93          |
| 1092/1592... 319/439          | Sony Kv1311 RGB/TV... 469  |
| Panasonic P3131... 239        | Taxan 620... 399           |
| Roland DXY-101 Plotter... 509 | Taxan 630/640... 449/519   |
| Houston Inst DMP-29... 1799   | Thompson 36432 RGB... 309  |

#### SOFTWARE

##### ACCOUNTING — DATABASE

|                             |                        |
|-----------------------------|------------------------|
| BFI Accting/Mod... from 308 | diBase III Plus... 409 |
| BFI Enterprise/Mod... 429   | Multishell 2.0... 85   |
| Peacemree/Module... 269     | Paradox... 449         |
| DAC EZ Accounting... 42     | Reflex... 83           |
| Open Systems V3/Mod... 449  | Revelation... 529      |
| Paragon... 589              | PFS File... 80         |
| SBT All Modules... CALL     | Q & A... 238           |

##### WORD PROCESSING — SPREADSHEETS

|                            |                        |
|----------------------------|------------------------|
| VoltsWriter 3... 149       | Lotus/Symphony... CALL |
| Microsoft Word 3... 259    | Framework II... 419    |
| Word Perfect 4.1... 209    | Supercalc 4... 269     |
| Leading Edge W.P... 85     | Ability... 61          |
| PFS Write & Proof... 82    | Multiplan 2.0... 119   |
| Multimate... 219           | Mosaic Twin... 57      |
| Multimate Advantage... 309 |                        |
| Turbo Lightning... 59      |                        |

##### UTILITIES

|                               |
|-------------------------------|
| Macro Assembler... 90         |
| Quick Basic... 80             |
| Charmaster... 215             |
| Click Art Pats. Pub... 109    |
| Energraphics 2.0... 289       |
| Freelance... 209              |
| Graphwriter Combo... 319      |
| Harvard Pres. Graphics... 229 |
| Generic Cod... 75             |
| In'A'Vision... 255            |
| Microsoft Chart 2... 179      |
| ProDesign II... 169           |
| Dr. Halo II w/Mouse... 109    |
| Fontix... 91                  |
| Statgraphics... 449           |

Call Toll Free 24 hrs Every Day  
**800-662-2686** orders only  
for Ca. Orders, Tech Support, Price Quotes, Info  
415-668-9350 9-5 pacific time, m-f  
Call or Write for Free Catalog

**PAYMENT:** (No Fee For Credit Cards) Visa, MasterCard, Cashier's Checks, Personal Checks with 2 week hold. Qualified P.O.'s. California residents add sales tax.

**SHIPPING:** UPS ground-2% per order, \$5 min. FREE for SW orders over \$1000. UPS Blue-3% per order, \$7 min. FREE for SW orders over \$1500. Printers, Monitors, Disk Drives, Computers — Call for charges.

All Products New with full warranties.  
Price & availability subject to change without notice.



THE BEST PRICES      THE BEST SERVICE

584 CASTRO ST., SUITE 487 SAN FRANCISCO, CA 94114  
a division of MCS, Inc. Computer & Software specialists since 1981

# DON'T MAKE A \$300 MISTAKE!

WHEN YOU CAN  
BUY IBM COMPATIBLE  
SOFTWARE FOR  
ONLY \$6 A DISK  
OVER 500 DISKS FULL  
OF PUBLIC DOMAIN AND  
USER SUPPORTED PROGRAMS

# LONE STAR SOFTWARE

## Recently a Customer Wrote . . .

"... I'm SICK! Friday afternoon I bought a \$300.00 data base manager from my local computer dealer. When I got home I found out my neighbor bought the same kind of program from you last week for six dollars. What's worse, I like your program better! Please send me your disk directory and the following disks . . ."

What can we say? Isn't it really about time you discovered that spending big bucks for all of those "glamorous-name" software products doesn't necessarily guarantee you anything but a thin pocketbook and a fancy copy protection scheme?

No . . . Computerland won't tell you about us or our great software. But why make a \$300.00 mistake? Many of our \$6.00 packages will actually do everything better and faster than the great "Starword-dplus-4.5.8", and you can keep the difference.

Here is just a sample of our library by category.

### WORD PROCESSORS

**PC-Write 2.6 (#78)** A full featured word processor that is faster than Wordstar.  
**DICTIONARY (#378)** Dictionary type spelling checker.  
**IV-ED (#415)** Word processor - editor.  
**LETTERWRITER (#415)** controls letter processing.  
**PC TYPE (#455)** Jim Button's contribution to a full fledged word processor.

### SCREEN EDITORS

**FOIL EDIT (#347)** Full screen editor. Top to bottom and left to right.

### TEXT PROCESSING TOOLS

**FOGFIND (#378)** reverse writing complexity using the "Fog Index".  
**WORDSTAR AIDS (#379)** collection of the most useful utilities for the Wordstar user.  
**PC OUTLINE (#414)** Create and collapse and outline. Great for plans, essays, etc.

### DATABASE PROGRAMS

**PC FILE III (#5)** most popular database program from Jim Button.  
**U-MIND (#133)** Fast hashing makes this a handy database. (Intelligent database)  
**NEWBASE (#233)** Menu driven database for the beginner.  
**PC-DBMS (#383)** A relational database management system that provides on-line help and screen editing functions.  
**ELSI EXPERT SYSTEM (#398)** Artificial intelligence shell to build a custom knowledge-base.

**PDS\*BASE (#396)** Complete hierarchical data base system master/detail or mother/daughter type.  
**CREATOR (#339)** creates, report, and sort makes this a super database management system.

### DATABASES

**BOBCAT (#247)** Small business database. Excellent!  
**MPIND (#311)** Database of over 2000 movies that can be searched in any category, or you can add your own.

### SPREADSHEETS

**PC-CALC (#199)** Fabulous 123 work-a-like from the author of PC-File.  
**PC-PAD (#406)** Spreadsheet and address book program written in basic.

### SPREADSHEET TEMPLATES

**LOTUS 1-2-3 TEMPLATES AND MACROS (#140, 141, 165, 257, 289, 301-304, 406, 414)** Why spend hours of writing your macros when these are ready made? Modify them yourself.  
**SYMPHONY WORKSHEETS (#305, 306)**

### FINANCIAL PROGRAMS

**PC-CHECK MANAGER (#275)** Keeps multiple checkbooks in balance.  
**TAX FILE DBS (#295)** Tax record keeping system that saves you money on April 15.  
**SAGE TRADER (#242)** Analyzes commodity trades. Don't "short" this one!  
**PORTSWORTH PACKAGE (#101)** Evaluates your ever changing stock portfolios.  
**FINANCE (#164, 227)** Determine present and compound values, interest rates, etc.  
**HOME FINANCE (#406)** Lotus 1-2-3 Macros for real life applications.  
**PC-GENERAL LEDGER 1.2 (#237)** An exceptional accounting system. Used by some CPAs.  
**TIME AND MONEY (#251)** Financial record keeping and analyst system.  
**LOAN AMORTIZATION (#399)** For output to screen or printer. Lots of on-line help.  
**BANK CHECKBOOK (#271)** Keep track of checkbook and personal finances.  
**ACCU-TAX 1985 (#479)** You can't buy a better "commercial" program.  
**MR. BILL (#469, 470)** Prepare invoices, client report, audit trail, etc.  
**ANALYTIC CALC (#430-432)** 3 disk set. Complete spreadsheet, database, graphics, word processor - fassett!

### COMMUNICATIONS

**QMODEM (#310)** The best and fastest com-

munications programs you can buy at any price, bar none!  
**PC-TALK (#16)** The classic "Freeware" communication program.  
**PC-VT (#286)** VT-100 Emulation.  
**SYSCOMM (#338)** Menu driven system allowing unattended file transfer.  
**RBBS 12.2 (#212)** Become a SYSOP and start a bulletin board.  
**FIDO NET (#333)** Bulletin Board System. Perhaps the easiest to run.

### MATH AND STATISTICS

**EPISTAT 3.1 (#88)** Statistical analysis of small to medium-sized data samples.

### LANGUAGES

**CHASM 2.13 (#10)** Cheap assembler with tutorial.  
**XLISP 1.4 (#148)** Lisp language interpreter.  
**MVP-FORTH (#31, 32)** Two disk set of Mountain Valley Press Forth.  
**3 FORTHS (#352)** To modify or expand your own forth language. MVPFORTH, FORTH-H and SEATTLE Computer's Forth.  
**PROLOG & UNIFORTH (#417)** Complete with editor and documentation.  
**SNOCREST BASIC (#409, 410)** two disk set. Real basic interpreter with manual. Can be used with a multi-user system.  
**ESIE (#398)** Build and generate an expert system in a flash.  
**PASCAL COMPILER (#424)** Written in Turbo Pascal.  
**P-BASIC (#381)** BASICA work-a-like for clones, etc.

### UTILITIES

**DISKCAT 4.0 (#108)** Catalog all your disk files in a hurry.  
**GINACIO (#68)** 54 polished routines written in basic for any beginner or expert. We love it!  
**ULTRA-UTILITIES 4.0 (#133, 245)** Recover lost files, modify sectors, etc. Like Nortons. SYSTEMU (#250) Build a menu driven menu system. Excellent for hard disks.  
**LOAD-US (#284)** Allows Lotus and Symphony to be used on a hard disk.  
**PC-DESKMATES (#405)** Better than Sidekick and all of the rest of the memory resident desktop utilities.  
**ALIGN 1.6 (#217)** Disk alignment tool.  
**TOP UTILITIES (#273)** All of the most requested utilities on one disk.  
**NUMZAP (#284)** Removes line numbers from BASIC programs.  
**HARD DISK UTILITIES (#478)** A collection of the best in the library.  
**UNPROTECT (#414)** Various routines to disconnect protection schemes.

**PATCHES (#376)** make back up copies of some of the most popular commercial programs with this collection.

### PRINTER UTILITIES

**SP 3.4 (#186, 275)** Printer buffer that partitions your data so you can use your computer and print at the same time.  
**SIDEWAYS (#265, 411)** Prints text sideways on an Epson printer.  
**BETPRTR (#78)** Sets up Epson printer from a menu.  
**SLIDE (#244)** produce medium resolution slides and overhead transparencies.  
**PRINTER UTILITIES (#411)** Sorgasboard of utilities and tools.  
**EPSON PRINTER UTILITIES (#326)** Spool, set up routines all designed for Epson codes.  
**BANNER (#386)** make long banners with large letters. Includes MS-FORTRAN source codes.

### EDUCATION

**EQUATOR (#249)** A teaching tool for math, science and finance.  
**PC-TUTORIAL (#403)** A first course in computer usage covering various aspects of MS-DOS. Good!  
**PC-PROFESSOR (#105)** Learn Basic the easy way. One of the best tutorials on BASIC.  
**PC-DOS HELP (#254)** type "help" for the DOS command you forgot.  
**FLASH CARDS (#367-370)** 4-disk set. Vocabulary builder, spelling teacher.  
**TOUCH-TYPE (#320)** Advanced type tutor.

### GAMES

**TOP GAMES (#274)** The most requested arcade type games.  
**ARCADE GAMES (#293)** Another goodie bag of top Arcade games.  
**TRIVIA GAMES (#327-329)** Lots of files and documentation for hours of fun. Will not work on PC JR.  
**PC JR GAMES (#354)** Games that will work only on PC JR. Combat, dungeons and dragons, Global Thermonuclear War.  
**MISC. GAMES (#390)** Good selection of educational, adventure, and arcade games.  
**BIG FOUR GAMES (#272)** Texas most popular. STARGATE, ZAXXON, AIRTRAX, and DND

### MUSIC

**PC-MUSICIAN (#127)** Compose music on your PC, save and play again.  
**PIANO MAN (#279)** Play your PC keyboard like a piano.

### APPLICATIONS

**GENEALOGY ON DISPLAY 3.0 (#90)**  
**GENEALOGY - FT 1.25 (#240)** from Pine Cone software.  
**LABELMAKER (#146)** Our favorite label file and maker. Menu driven.  
**PC-FLY "Fiteplan" 2.1 (#261)** Pilots prepare and file your flight plans.  
**RECIPE B3 (#261)** Recipe index for use with PC File III (#5)  
**FAMILY HISTORY (#361)** Family history, ancestor and descendant charts. Sample programs.  
**FORM LETTERS (#388)** LOTS of samples of the most commonly used business letters. Modify!  
**HAN RADIO (#436, 437)** Electronic goodies, design antennas, great circle, etc.

### GRAPHICS

**PC-KEY DRAW (#344-345)** A small CAD system. Lots of demonstration files.  
**PC-PICTURE GRAPHICS (#136)** Drawing package allows you to zoom, color, and store pictures.  
**PC-GRAPH (#418)** Allows user to create graphics from PC-File report files.  
**ORIGAMI (#408)** Japanese art of paper folding. Graphics required.  
**DRAFTSMAN (#400)** Easy to use presentation quality. Mouse or keys.

## ORDER FORM

### LONE STAR SOFTWARE, INC.

2100 Hwy. 360, Suite 1204  
Grand Prairie, Texas 75050  
214/647-1010

SHIP TO: \_\_\_\_\_

TOTAL # \_\_\_\_\_ x \$6 = \_\_\_\_\_

DISK DIRECTORY (Explanation of all files & programs) x \$6 = \_\_\_\_\_

OTHER \_\_\_\_\_ = \_\_\_\_\_

SUBTOTAL \_\_\_\_\_

TEXAS RESIDENTS ADD 6% TAX \_\_\_\_\_

SHIPPING & HANDLING \_\_\_\_\_

(1 @ \$1.00 end) \$5 for each additional disk)

TOTAL \_\_\_\_\_

MASTERCARD  VISA

CARD NO. \_\_\_\_\_

EXPIRATION DATE \_\_\_\_\_

SIGNATURE \_\_\_\_\_

PLEASE ENCLOSE CHECK WITH ORDER

### CIRCLE DISK NUMBER DESIRED:

|     |     |     |     |     |     |     |     |     |     |     |     |     |     |     |     |     |     |     |     |
|-----|-----|-----|-----|-----|-----|-----|-----|-----|-----|-----|-----|-----|-----|-----|-----|-----|-----|-----|-----|
| 1   | 2   | 3   | 4   | 5   | 6   | 7   | 8   | 9   | 10  | 11  | 12  | 13  | 14  | 15  | 16  | 17  | 18  | 19  | 20  |
| 21  | 22  | 23  | 24  | 25  | 26  | 27  | 28  | 29  | 30  | 31  | 32  | 33  | 34  | 35  | 36  | 37  | 38  | 39  | 40  |
| 41  | 42  | 43  | 44  | 45  | 46  | 47  | 48  | 49  | 50  | 51  | 52  | 53  | 54  | 55  | 56  | 57  | 58  | 59  | 60  |
| 61  | 62  | 63  | 64  | 65  | 66  | 67  | 68  | 69  | 70  | 71  | 72  | 73  | 74  | 75  | 76  | 77  | 78  | 79  | 80  |
| 81  | 82  | 83  | 84  | 85  | 86  | 87  | 88  | 89  | 90  | 91  | 92  | 93  | 94  | 95  | 96  | 97  | 98  | 99  | 100 |
| 101 | 102 | 103 | 104 | 105 | 106 | 107 | 108 | 109 | 110 | 111 | 112 | 113 | 114 | 115 | 116 | 117 | 118 | 119 | 120 |
| 121 | 122 | 123 | 124 | 125 | 126 | 127 | 128 | 129 | 130 | 131 | 132 | 133 | 134 | 135 | 136 | 137 | 138 | 139 | 140 |
| 141 | 142 | 143 | 144 | 145 | 146 | 147 | 148 | 149 | 150 | 151 | 152 | 153 | 154 | 155 | 156 | 157 | 158 | 159 | 160 |
| 161 | 162 | 163 | 164 | 165 | 166 | 167 | 168 | 169 | 170 | 171 | 172 | 173 | 174 | 175 | 176 | 177 | 178 | 179 | 180 |
| 181 | 182 | 183 | 184 | 185 | 186 | 187 | 188 | 189 | 190 | 191 | 192 | 193 | 194 | 195 | 196 | 197 | 198 | 199 | 200 |
| 201 | 202 | 203 | 204 | 205 | 206 | 207 | 208 | 209 | 210 | 211 | 212 | 213 | 214 | 215 | 216 | 217 | 218 | 219 | 220 |
| 221 | 222 | 223 | 224 | 225 | 226 | 227 | 228 | 229 | 230 | 231 | 232 | 233 | 234 | 235 | 236 | 237 | 238 | 239 | 240 |
| 241 | 242 | 243 | 244 | 245 | 246 | 247 | 248 | 249 | 250 | 251 | 252 | 253 | 254 | 255 | 256 | 257 | 258 | 259 | 260 |
| 261 | 262 | 263 | 264 | 265 | 266 | 267 | 268 | 269 | 270 | 271 | 272 | 273 | 274 | 275 | 276 | 277 | 278 | 279 | 280 |
| 281 | 282 | 283 | 284 | 285 | 286 | 287 | 288 | 289 | 290 | 291 | 292 | 293 | 294 | 295 | 296 | 297 | 298 | 299 | 300 |
| 301 | 302 | 303 | 304 | 305 | 306 | 307 | 308 | 309 | 310 | 311 | 312 | 313 | 314 | 315 | 316 | 317 | 318 | 319 | 320 |
| 321 | 322 | 323 | 324 | 325 | 326 | 327 | 328 | 329 | 330 | 331 | 332 | 333 | 334 | 335 | 336 | 337 | 338 | 339 | 340 |
| 341 | 342 | 343 | 344 | 345 | 346 | 347 | 348 | 349 | 350 | 351 | 352 | 353 | 354 | 355 | 356 | 357 | 358 | 359 | 360 |
| 361 | 362 | 363 | 364 | 365 | 366 | 367 | 368 | 369 | 370 | 371 | 372 | 373 | 374 | 375 | 376 | 377 | 378 | 379 | 380 |
| 381 | 382 | 383 | 384 | 385 | 386 | 387 | 388 | 389 | 390 | 391 | 392 | 393 | 394 | 395 | 396 | 397 | 398 | 399 | 400 |
| 401 | 402 | 403 | 404 | 405 | 406 | 407 | 408 | 409 | 410 | 411 | 412 | 413 | 414 | 415 | 416 | 417 | 418 | 419 | 420 |
| 421 | 422 | 423 | 424 | 425 | 426 | 427 | 428 | 429 | 430 | 431 | 432 | 433 | 434 | 435 | 436 | 437 | 438 | 439 | 440 |
| 441 | 442 | 443 | 444 | 445 | 446 | 447 | 448 | 449 | 450 | 451 | 452 | 453 | 454 | 455 | 456 | 457 | 458 | 459 | 460 |
| 461 | 462 | 463 | 464 | 465 | 466 | 467 | 468 | 469 | 470 | 471 | 472 | 473 | 474 | 475 | 476 | 477 | 478 | 479 | 480 |
| 481 | 482 | 483 | 484 | 485 | 486 | 487 | 488 | 489 | 490 | 491 | 492 | 493 | 494 | 495 | 496 | 497 | 498 | 499 | 500 |

© 1986 Lone Star Software, Inc

An end to diskette lies!

# Super Star™ Diskettes are of equal or *higher* quality than 3M, Maxell, TDK and many other "famous" brand names. They simply cost about half as much!

Super Star™ diskettes are manufactured to equal or exceed the same specifications as 3M, Maxell, TDK and many other "famous" brand name products.

They are designed for 60% or higher clipping levels, not the 40% used in IBM and ANSI standards. Each is guaranteed for ten million read/write passes. Every Super Star™ diskette is 100% verified and carries a LIFETIME WARRANTY!

**Yet Super Star™ diskettes cost only about half as much...**

How can we deliver Super Star™ diskettes of such high quality at such a low price?

Simple...we don't make fools out of our customers.

We bargain hard with the same people who turn out many of the "famous name" brands. Their manufacturing capacity far exceeds their capability to sell everything they make. So, as large scale purchasers, we are able to obtain significantly lower prices than others for **high-quality** diskettes.

For example, we pay one of the big name manufacturers 98¢ for their "famous name" diskette in a pretty box. In an unequalled display of favoritism, that same manufacturer sells the same diskette in the same fancy box to a major corporation for 42¢ each. Finally, a software duplicator can buy the same diskette *without* the box for 37¢!

**A 265% price difference: for what?**

In the example above, that's a difference of 265% in price for the very same diskette!

So you see, paying for a "famous name" on a diskette doesn't guaranty you that you're getting any more for the money.

You may be paying for some big corporation's fleet of aircraft and their executive retreats in Minnesota and Canada, but you are not paying for any more quality.

You're simply getting rooked out of money you could have in your own pocket.

**There are four kinds of diskettes:**

**And Super Star™ is right up there with the best.**

As you leaf through the pages of this magazine, you will see diskettes advertised at prices as low as 33¢. Every one, of course, claims to be the "best".

It's simply not true.

Here are the only kinds of diskettes you can buy:

**High-Clip Product:** this is what you get when you buy Super Star™, 3M™, Maxell™, TDK™ or any number of other famous and not so famous name diskettes. They have clipping rates of 60% or more, are certified for ten million read/write passes or more and are simply the best diskettes available. You can expect perhaps 1 out of 100,000 to fail...and that will usually be the result of dirty or misaligned drives.

**ANSI Spec Product:** These are "okay" diskettes. They have a clipping level of 40%. Usually they are the fall-out from a manufacturer's "high-clip" product line. You can expect about 1 out of 20 to fail in normal use.

(But that failure rate has more to do with the disk drive rather than the diskette.) The price difference between an ANSI-spec disk and a High-Clip product is only a few cents. But the failure rate of ANSI product is 50,000 times higher!

**Duplicator Product:** This is a catch-all category. Some of it may be High-Clip Product, some ANSI spec, some cosmetically blemished, some garbage. Usually anyone who buys product in this class justifiably anticipates that 20 out of every 100 diskettes will not format properly.

**Floor Sweepings:** This is just plain "garbage". For example, the 5.25" SSSD diskettes that you see advertised for 39¢ are exactly that: garbage. No decent manufacturer has sold any 5.25" SSSD diskettes in several years. SSSD is the absolute bottom of the line in terms of quality. Most of the discount diskettes you see advertised are "floor sweepings"...bought up by brokers and passed on to the unsuspecting public by unscrupulous merchants who are simply out to make a fast buck.

**When every bit counts, you can count on Super Star™!**

Well, I wish we had more space, but we don't.

So, here's the message in a nutshell:

1. Super Star™ diskettes are high-clip product, 100% certified, tested to 60% or higher clip levels and not less than ten million read/write passes.

2. Super Star™ diskettes carry a LIFETIME WARRANTY.

3. Super Star™ diskettes equal or exceed the published specifications of such "famous" brand names as 3M, Maxell, TDK, etc.

4. Super Star™ diskettes give you this quality *at about half the price of the big names!*

**Save your money: buy Super Star™ diskettes!**  
That's the message:  
**Super Star™ diskettes mean the highest quality at about half the price!**

**SUPER STAR SPECIAL!**  
*Your choice of storage for \$ 4.95!*

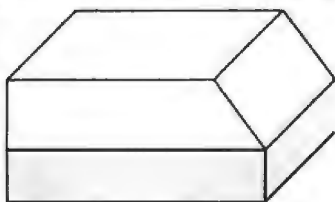

Buy 50 Super Star™ diskettes of either size and you can get a nice plastic storage case for only \$ 4.95 (shipping included!).

These are durable plastic cases with dividers.

The 5.25" unit holds 50 diskettes and the 3.50" unit holds 40 diskettes.  
5.25" Storage Unit (P/N3100) \$ 4.95ea.  
3.50" Storage Unit (P/N3102) \$ 4.95ea.

## Super Star™ 5.25"

|                  |            |
|------------------|------------|
| SSDD (P/N3800)   | .38ea.     |
| DSDD (P/N3801)   | .38ea.     |
| SSDD96 (P/N3802) | .68ea.     |
| DSDD96 (P/N3803) | .71ea.     |
| DSDDHD (P/N3804) | \$ 1.36ea. |

ORDER IN MULTIPLES OF 50 ONLY!

All Super Star 5.25" Diskettes are poly-bagged in lots of 25 with Tyvec sleeves, write-protect tabs and user ID labels.

**QUANTITY DISCOUNTS:** 350-500 diskettes, deduct 3%. 550-700 diskettes, deduct 6%. 750-1,000 diskettes, deduct 9%. 1,050+ diskettes, deduct 12%.

## Super Star™ 3.50"

|                |            |
|----------------|------------|
| SSDD (P/N3805) | \$ 1.39ea. |
| DSDD (P/N3806) | \$ 1.45ea. |

ORDER IN MULTIPLES OF 50 ONLY!

Super Star 3.50" diskettes are packaged in boxes of 50 with user ID labels.

**QUANTITY DISCOUNTS:** 350-500 diskettes, deduct 1.5%. 550-700 diskettes, deduct 3%. 750-1,000 diskettes, deduct 4.5%. 1,050+ diskettes, deduct 6%.

## TAKE A CLOSE LOOK AT OUR DISCOUNTS!

Take a real close look at our discounts. They're some of the best around.

**HOURS:**

**8AM-6PM Central Time  
Monday - Friday**

## HOW TO ORDER:

**ORDERS ONLY:**

**1-800-621-6827**

(In Illinois: 1-312-256-7140)

**INQUIRIES:**

**1-312-256-7140**

FOR FASTEST SERVICE, USE NO-COST MCI MAIL. Our address is DISKORDER. It's a FREE MCI MAIL letter. No charge to you. (Situation permitting, we'll ship these orders in 24 hours or less.)

**SHIPPING:** 5.25" & 3.50" DISKETTES-Add \$ 3.00 per each 100 or fewer diskettes. **OTHER ITEMS:** Add shipping charges as shown in addition to other shipping charges. **PAYMENT:** VISA, MASTERCARD and Prepaid orders accepted. **COD ORDERS:** Add \$ 5.00 special handling charge. **APO, FPO, AK, HI & PR ORDERS:** Include shipping charges as shown and additional 5% of total order amount to cover PAL and insurance. We ship only to United States addresses, except as shown above. **TAXES:** Illinois residents add 7% sales tax.

**MINIMUM ORDER: \$ 35.00**

# DISK WORLD!, Inc.

629 Green Bay Road  
Wilmette, Illinois 60091



# We pledge allegiance to low prices and superior technical service.

## DISK DRIVES FLOPPY

### Tasc

FD06 8-1/2 (half height 5 1/4" 360K DS/DD Floppy) \$399  
FD06 F70-1/2 (half height 5 1/4" 1.2 MB black or gray faceplate) \$145

### Toshiba

ND 040 (half height 5 1/4" 360K black face plate) \$109  
ND 040EG (half height 5 1/4" 360K gray face plate) \$111  
ND 000EG (half height 5 1/4" 1.2 MB gray face plate) \$149

### Control Data

Half height 5 1/4" 360K black face plate floppy \$85

## HARD DISK DRIVES

### Seagate

ST225 20MB half height 65MLS with controller card \$429  
ST225 20MB half height 65MLS no controller card \$345  
NEW ST238 30MB half height 65MLS with controller card \$529  
ST4026 20MB full height 30MLS no controller \$545  
ST4038 30MB full height 30MLS no controller \$645  
ST4051 40MB full height 30MLS no controller \$745  
Western Digital controller card \$125

### Control Data

9415-06 65MB full height 30MLS no controller \$1495  
Disk Manager Software for formatting past DOS (33MB) \$100

## TAPE BACKUPS

### Irwin Magnetics

10MB INTERNAL TAPE DRIVE half height unit uses floppy controller \$499  
20MB INTERNAL TAPE DRIVE for 286 COMPAQ and AT \$599

### Everex

20MB INTERNAL TAPE DRIVE half height with controller \$573  
60MB INTERNAL TAPE DRIVE half height with controller \$724

### Alloy

6000B EXTERNAL TAPE DRIVE software, cables and controller \$741

### Tape Cartridges/Scotch 3M

DC-900A cartridge tape (up to 60MB capacity) \$26  
DC-1000 cartridge tape for Irwin tape drive \$19

## MEMORY MULTIFUNCTION BOARDS

### AST

SIXPACK PREMIUM 512 to 2MB Advantage w/128K (expandable to 3MB, S2.G for AT) \$356  
RAMPAGE PC 256 to 2MB (EMS board w/desknew windowing software) \$234  
RAMPAGE AT 512 to 2MB (EMS board 8MHz) \$445

## PCA (XT COMPATIBLE)

640K, 4.77MHz, 2 floppies, monochrome graphics, P, TTL monitor, FCC app..... \$775

## ANI TURBO XT COMPATIBLE

640K, one floppy, 20MB, P, S,S,G,C, 4.77 or 8MHz switchable, FCC app..... \$995

## MULTITECH AT COMPATIBLE,

w/512K, keyboard, up to 5 half-height internal drives, 10 or 6 MHz Switchable, slots, 192 W supply, MS-DOS 3.1 FCC Approved. 1.2MB floppy, one year warranty... \$1550

Alloy network compatible

## IBM PC

w/256K, one floppy, 4.77MHz..... \$1150

## IBM AT

w/512K, 1.2MB floppy 6MKZ, 20MB..... \$3295

w/640K, 1.2MB floppy 8MHZ, 30 MB..... \$4290

## COMPAQ DESK PRO 286

Model 2 with 30MB hard drive, 6 or 8 MHz switchable, 512K, 1.2 MB floppy, color/mono card, parallel/serial port..... \$3,650

TVM color monitor, Amb/Gr/640X200..... \$299

## MONOCHROME MONITORS

SAMSUNG TTL AMBER or GREEN \$99  
AMDEK 318A TTL AMBER \$151  
PRINCETON MAX 12 TTL/800 PIXELS \$102

## COLOR MONITORS

Mitsubishi  
COLOR MONITOR 600/200 \$261  
Princeton Graphics  
HX-12 31mm dot pitch 640/240 \$44;  
HX-12 E 28mm dot pitch 640/350 EGA \$53;  
SR-12 31mm dot pitch 640/400 super high res reqs SIGMA 400 H \$53;  
SIGMA 400 H \$48

## Taxan

640 720/400, 31 dot pitch \$58  
555 16 color card red/graphics \$14

## N E C

MULTISYNC 15 75kHz to 35kHz horizontal scan \$56

## VIDEO DISPLAY BOARDS

### Hercules

GRAPHICS CARD monochrome w/parallel \$19;  
COLOR CARD color w/parallel \$15;  
GRAPHIC CARD plus text graphics \$19;  
Clones  
EVEREX color/mono 132 column \$23;  
GRAPHICS CARD monochrome w/parallel \$9;  
COLOR CARD color w/parallel \$81  
STB EGA \$304

## BACK-UP POWER AND SURGE PROTECTION

### Data Shield

500 W Backup Power Supply \$61;  
800 W Backup Power Supply \$69;  
1500 W Backup Power Supply \$1427

### Clone

150 W POWER SUPPLY \$95  
135 W POWER SUPPLY \$81

### Curtis

DIAMOND (SURGE PROTECTOR 6 OUTLET wall) \$35  
EMERALD (SURGE PROTECTOR 6 OUTLET card) \$45  
RUBY (SURGE/FILTER/6 card) \$54

### Kinsington

MASTERPIECE - PLUS \$97  
MASTERPIECE - PLUS \$131

### CHIPS

208K SET \$29  
128K SET \$40  
64K SET \$10  
8087 \$125  
8087-2 \$158  
80287 \$109  
80287-B \$327

### Talltree

JRAM 2 w/OK (Parallel 2MB capacity) \$142  
JRAM 3 w/OK (for PC EMS board up to 2MB capacity) \$184  
JRAM AT w/OK (Parallel 2MB capacity) \$190  
JRAM 3 AT w/OK (EMS board up to 2MB capacity) \$239

### Clone

6 FNCK compatible w/S, P, C, G, w/OK (up to 384K) w/software \$99

## MULTIFUNCTION I/O BOARDS

DIAG I/O operates 2 floppies, and G, S, P, C \$95  
AT I/O, Parallel, Serial \$95

## MODEMS

### Hayes

SMARTMODEM 1200B INTERNAL (1200/300 baud w/SmartcomII) \$384  
SMARTMODEM 1200 External (1200/300 baud) \$479  
SMARTMODEM 2400 External (2400) \$638

### Everex

EVERCOM Modem (1200/300 baud w/software) \$158

### US Robotics

COURIER 800B baud Internal or External \$461

## NETWORKS MULTI-USER

### Alloy

PC-BLANK/16 16 BIT SLAVE BOARD 8086-2, (8MHz Processor, 2 serial ports, 1 MB Ram) \$895

12 Slot Expansion Chassis \$1135  
225 Watt power supply \$38  
28' RS-232 Slave Cable \$38  
ATXK ALLOY TERMINAL NETWORK EXECUTIVE SOFTWARE \$295  
LINK RS-323 ASCII Terminal IBM Keyboard \$625

## PRINTERS/DOT MATRIX

### Citizen (Epson & IBM Compatible)

MSP-18 160/40 cps dot matrix narrow carriage \$367  
MSP-15 160/40 cps dot matrix-wide carriage \$414  
MSP-28 200/50 cps dot matrix-narrow carriage \$347  
MPS-25 200/50 cps dot matrix-wide carriage \$526

### Epson

FX-85 160 cps, narrow carriage NLO \$434  
FX-200 200 cps wide carriage NLO \$624  
LQ 1800 24 Pin 180 cps NLO 60 wide carriage \$838  
LQ 800 24 Pin 180 cps, NLO 60 narrow carriage \$638

### IBM

Proprinter \$445  
Proprinter XL Wide Carriage \$661  
Okidata  
ML182 120 cps narrow carriage \$228  
ML 182 160 cps NLO narrow carriage \$327  
ML 183 180 cps NLO wide carriage \$329  
ML 282 200 cps 100 NLO narrow carriage color \$614  
ML 283 Dual 9 pin, 200 NLO wide carriage color \$883  
2410/PI/1188 350 cps 175/85/wide \$1859

### Toshiba

P-251 24 pin 288 cps wide carriage \$1025  
P-341 24 pin 216 cps wide carriage 180 NLO \$727  
P-321 24 pin 216 cps narrow carriage \$442  
P-351 C Color printer \$1178

### Panasonic

KXP1001 120 cps, NLO 29 cps \$270  
KXP1002 180 cps, NLO 33 cps \$348  
KX1502 wide carriage, 180 CPS, NLO 38 cps \$488

### N E C

P-5XL24 pin, 290 cps, 100 NLO color \$1071  
P-6, P-7, 24 pin \$477/667

## LASER PRINTERS

### Hewlett-Packard

LASER JET PROFESSIONAL 8 pages per minute \$2357  
LASER JET PLUS DP graphics/SIP interface \$3853

## PRINTERS/LETTER QUALITY

### Brother

HR-15 17 cps \$368  
HR-25 23 cps \$615  
TWINWRITER DOT MATRIX 140 cps, LO 36 cps \$1063  
N1509 180 cps/45 cps NLO \$420

### N E C

ELF (18 cps) \$488  
NEC 3580 (33 cps) \$799

### Panasonic

KXP-3131 (17 cps) \$296  
KX-P3151 Wide (22 cps) \$448

TERMS: WE ACCEPT G.O.D. CASHIER CHECK, VISA, MASTER CARD, AMERICAN EXPRESS (3% EXTRA) WIRE TRANSFERS, APPROVED P.O.'S. ALL EQUIPMENT CARRIES NEW FACTORY WARRANTY. PRICES ARE SUBJECT TO CHANGE. ANY RETURN ITEM MUST BE ACCOMPANIED BY A RETURN AUTHORIZATION NUMBER AND DESCRIPTION. IBM, COMPAQ, SEAGATE IS A REGISTERED TRADEMARK OF THEIR RESPECTIVE COMPANIES.



HOURS:  
MONDAY — FRIDAY  
8:30 — 5:30  
SATURDAY  
10:00 — 2:00

1-714-557-3903  
CUSTOMER SERVICE

1-800-654-5365  
SALES HOTLINE

1-714-557-3904  
TECHNICAL SUPPORT

# TIMELINE INC.

CALL US FOR ALL YOUR NEEDS!

We have 10 Million I.C.'s in stock!

Continental U.S.A

Inside California

L.A. & Technical Info

**OEM  
INQUIRIES  
WELCOME**

(800) 872-8878

(800) 223-9977

(213) 217-8912

Minimum I.C. Order: \$200.00

## Multitech MIC-500/504 CP/M SYSTEM

JUST ADD A TERMINAL!

**\$199.00**

INCLUDES: 2 48 or 96 tpi drives Your choice  
Z80A Microprocessor  
Ports: Centronics parallel, Two serial

Comes with all software & manuals:  
Magic Worksheet, Word Right, Analyst, QSORT,  
NAD IName and Address System

100 Systems available

## ASTECH 65 WATT SWITCHING POWER SUPPLY

PERFECT FOR POWERING:

- HARD DISK DRIVES
- FLOPPY DISK DRIVES
- MINICOMPUTERS
- CRTs

Dual input voltage 115/230 VAC - Overvoltage protection -  
Short circuit protection - Dual isolated +12V - Built-in EMI  
filter - Very compact size - UL/CSA/ULDE approved - 100%  
thermal cycle & burn-in - High efficiency - Vacuum impreg-  
nated transformers - Convection cooling - Open PCB "L"  
bracket or boxed construction. Condition No.2

OUTPUTS: +5V DC @ 4.0A +5V DC @ 5.0A (with two +12V outputs in parallel)  
+12V DC @ 1.5A +12V DC (with two +12V outputs in parallel)  
Condition No.1 +12V DC @ 2.1A @3.5A (5.0A surge)  
-12V DC @ 0.25A -12V DC @ 0.25A

**\$39.95**

Dimensions:  
8.0" - Length  
4.4" - Width  
2.4" - Height

MODEL NO.  
AC9335-01

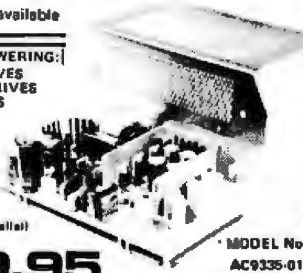

## MOTOROLA 7" DIAGONAL SCREEN HIGH RESOLUTION GREEN SCREEN MONITOR

**\$29.95**

MODEL MD1700

22 MHZ  
TYPICAL  
BANDWIDTH  
4 for  
\$89.00



- Flat Facetype
- 500 lines at Center 650 lines at corners
- Operates from 12VDC at 1 Amp.
- Vertical input is 47 to 63 Hz.
- Horizontal input: 15.7 KHz (18.7 KHz optional)
- Video input signal: Positive white, input termination 470 ohms ± 5%, 2.5V to 5.0V P.P Weight: 8lbs.

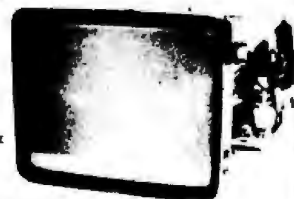

For split video (TTL Inputs) operation. Not composite video.

Model  
HH-612

## MICROSCIENCE HARD DISK DRIVE

SPECIAL LOW PRICE: **\$189.00**

\$289.00 With controller card & cables

15 Mb System - \$329.00

30 Mb Removeable System - \$429.00 Includes:  
(2) 1/2 Height Drives & Controller card (with cables)

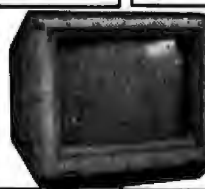

## 13" COMPOSITE COLOR

RCA JACKS FOR: VIDEO IN/OUT and AUDIO IN/OUT

**\$109.00**

For VCR-Atari-Apple-Commodore



## 286 SPEED PAK FOR IBM PC & XT CLASSIC TECHNOLOGY CORPORATION

UP TO 7 TIMES PC SPEED

Increases speed of PC/XT to make it 33% faster than an AT  
20-30% faster than boards that use cache  
Compatible with IBM Enhanced Graphics Adapter and the  
Cetus/Intel above board  
Can run programs designed for the AT's and also PC/XT's  
No software patches needed  
Includes extra mode  
made in U.S.A.

**\$770.00**

## TEC MODEL 1550

DOT MATRIX/NEAR  
LETTER QUALITY  
SERIAL IMPACT  
PRINTER

Features: 15" Carriage-120 CPS-Parallel  
Interface-Low power consumption-High  
quality Print-Bit image graphics-Graphics  
symbols-Prints in six different languages-  
High reliability-And finally...Low Cost!

These very high quality printers  
were made for Phillips Information  
Systems. Original price was \$795.00

Liquidation Blow-out!

**\$279.00**

Only 125 Available

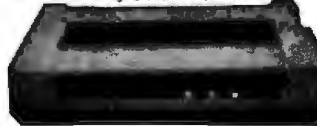

## IBM PC/XT REMOTE KEYBOARD

This high quality  
keyboard was made  
by Cherry wireless  
original cost was  
\$279.00

**BLOWOUT  
PRICE!**

**\$49.95**

COMPLETELY IBM COMPATIBLE  
Control your computer from across the room  
with this infrared keyboard or hook directly like a regular keyboard.



## Switchable Power Supply

110/220V 141 Watt +5V @ 2.0A  
Dim. 10x8x3-3/8 +12V @ 3.3A  
+5V @ 0.1A  
+12V @ 0.2A  
+12V @ 2.0A  
Weight: 7lbs.

**\$49.95**

## Tandon 848-2 IBM COMPATIBLE DOUBLE SIDED/DOUBLE DENSITY

1/2 HEIGHT - 8" DRIVE  
1.8 mbps Unformatted  
1.2 Formatted  
Wt: 7lbs.

**\$199.95**

Tandon TM55-4 Disk Drive  
1/2 HL - 80Track - DS/DD \$69.00

## HIGH CAPACITY AMLYN 1880A DRIVE

5 1/4" DS/High Density  
2.2 mbys Unformatted  
2.2 Formatted  
Takes 8" controller to  
operate

**\$139.00**

Wt: 4lbs.

Standard Data - Local Area  
NETWORK BOARD  
With Software **\$150.00**



## EPSON GX-10 MOTHERBOARD WITH VIDEO CARD & YOUR CHOICE OF ASCII KEYBOARD (ENCLOSED) OR HASCII (BARE)

PROGRAMMABLE SYNTHETIC  
SPEECH GENERATION BOARD  
PLUG COMPATIBLE WITH APPLE II  
MICROCOMPUTERS. Can be easily con-  
trolled by BASIC. Uses TMS5220 for:  
Low-data-rate LPC encoding. +5V & -5V  
supplies only - TTL Compatible  
INCLUDES: Software and Speaker

**\$169.95**

ONLY 250 SYSTEMS AVAILABLE!  
Will work with any IBM compatible disk drive • CPU  
FD780AC (1.2 MB compatible 4 MHz) • Memory-RAM  
256K on board Video RAM 128K on CRT board C-MOS  
RAM 2K EPROM 2/4/8K for IPL) Clock C-MOS real-time  
clock interface Serial and Parallel DMA 7 channels  
interrupt levels 15 Counter/timer 6 channels Card slots  
5 Compatible with any TTL monitor Weight 10 lbs with  
enclosed keyboard 8 lbs with bare keyboard

## KEPCO/TKD SWITCHING POWER SUPPLY

**\$39.95**

ONLY 250 AVAILABLE!  
Model EP 1007-3 100W • +5V  
@ 8A • +5V @ 1.5A • +12V @  
2.0A • -12V @ 2.0A • Input Volt-  
age 100 to 130V ac or 200 to 260V ac • 47 440 Hz Single  
phase • Brownout Voltage 90V ac • 180V ac • Fused Input!  
Output protected against short circuit Dim 9 1/2" x 4 1/2" x 7 1/4"  
Weight 3 lbs. Spec included

and sold AS IS Weight 14 lbs

## SIEMENS 8" DISK DRIVE

**\$44.95**

ON STOCK  
**\$69.95**

FD0100-8 Shugart 801R equivalent  
Single Sided Single/Dense Density  
Full Height Drive 48 tpi Documents  
format included. Specify 110 or 220  
Volt Model • These drives are new

and sold AS IS Weight 14 lbs

## NASHUA DISKETTES 5 1/4" SOFT SECTOR

15/100 with rub rings please write  
protect tabs and labels

**\$8.00 BOX OF 10**

.70c 5 BOXES OF 10  
.82c 10 BOXES OF 10

Nashua Diskettes were  
judged to have the highest  
density and recorded  
an amplitude of any disk-  
ettes tested. According  
to "Comparing Floppy  
Diskettes" Byte 9/84.

SERIAL PRINTER  
/MODEM CABLE  
(Male to Female)

**\$7.95 1/2  
OFF!**

FOR USE IN SERIAL  
APPLICATIONS  
Both as Serial Printer  
and Modem.

## RICOH PRINTER RP 1200N

Centronics  
Interface  
-Daisy Wheel

**\$400.00**

4164-15

89c

100 pc. min. qty.

19" Length  
Full height daisy roll  
Tinned copper braze  
34 AWG wire  
Molded DB 25 pin male &  
female connector  
All metal mount pins are  
shaded  
Pins 1 & 8 20 Wires  
Color Edge

## DISK DRIVE CABINET **\$12.95**

Full Height Disk Drive Case for  
Apple • Fits 2 half height drives. Can  
be modified for other uses. Dim.  
9 1/2" x 6 7/8" x 3 1/2" H. Weight 3 lbs

## "Soy in the Sky" Fairchild CCD122 1,728 ELEMENT \*

Linear Image Sensor **\$29.95**

\*The Designed for page scanning applications  
including facsimile, Optical Character  
Recognition and other imaging applications  
which require high resolution and high  
contrast

## QUME Sprint 9/35 KSR

TERMINAL/  
PRINTER

-35 CPS  
-Serial Interface  
-8 lbs.

**\$299.00**



1490 W. ARTESIA BLVD., GARDENA, CA. 90247  
Continental U.S.A Inside California L.A. Area & Technical Info  
(800) 872-8878 (800) 223-9977 (213) 217-8912



Inquiry 349

Minimum Order: \$25.00. Shipping & handling charges  
via UPS Ground: \$.50c/lb. UPS Air: \$1.00/lb. Minimum  
Charge: \$4.00. We accept cashiers checks, MC or VISA.  
No personal check COD's. Items reflect 5% cash or check  
discount. California residents add 6 1/2% sales tax. We are  
not responsible for typographical errors. All merchandise  
subject to prior sale. Phone orders welcome.  
Foreign Orders require special handling

**P.C. Computer Brokers Inc.**

**The Place To Buy Your Epson Printers**



**FX-85**  
list \$499<sup>00</sup> **\$369<sup>00</sup>**

**Brand New Epson EX-800 Printer**  
300 CPS, Push Traction: Suggested Retail \$749<sup>00</sup>

**Call For Price**

| Epson Printers                   | List                          | SALE                       |
|----------------------------------|-------------------------------|----------------------------|
| Spectrum LX-80                   | ....\$ 299 <sup>00</sup> .... | <b>\$ 219<sup>00</sup></b> |
| HS-80 Ink Jet Printer            | ....\$ 449 <sup>00</sup> .... | <b>\$ 339<sup>00</sup></b> |
| Comrex High Speed CR-420 Printer | ....\$2195 <sup>00</sup> .... | <b>*1295<sup>00</sup></b>  |
| HI-80 Four Pen Plotter           | ....\$ 599 <sup>00</sup> .... | <b>CALL</b>                |

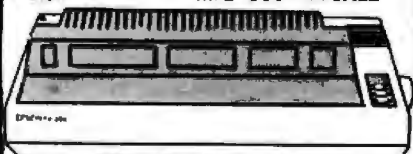

**EPSON** **FX-286**  
**1** List \$749<sup>00</sup> **\$519<sup>00</sup>**

| Epson Printers          | List                           | SALE                      |
|-------------------------|--------------------------------|---------------------------|
| Homewriter Printer      | .....\$249 <sup>00</sup> ....  | <b>* 199<sup>00</sup></b> |
| AP-80 Printer           | .....\$379 <sup>00</sup> ....  | <b>CALL</b>               |
| LX-90 Printer           | .....\$329 <sup>00</sup> ....  | <b>* 229<sup>00</sup></b> |
| SQ-2000 Ink Jet Printer | .....\$2295 <sup>00</sup> .... | <b>*1579<sup>00</sup></b> |



**LQ-800**  
**\$529<sup>00</sup>** list \$799<sup>00</sup>

Call P.C. Computer Today For Low Prices on Many Other Computer Products—Call 1-800-245-4122

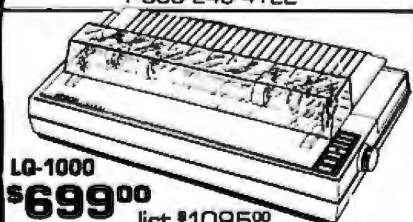

**LQ-1000**  
**\$699<sup>00</sup>** list \$1085<sup>00</sup>

Prices Subject to Change Without Notice



Add 2.9% For Use of Visa, M/C & Choice.

These Prices Are Good For Mail Order Dept. Only

**P.C. Computer Brokers Inc.**  
**3879 East 120th Ave.**  
**Thornton, CO 80233**  
**(303)450-6727**

Call Toll FREE **1-800-245-4122**

**DATA SECURITY \$595 (list)**

Now there's communication for your computer and security for your peace of mind. CERMETEK manufactures 1200 and 2400bps Hayes™ compatible security modems with a long list of features.

For information call (408) 752-5055

**Cermetek**

1308 Borregas Ave.  
Sunnyvale, CA 94008-3565

Hayes is a trademark of Hayes Microcomputer Products, Inc.

Inquiry 62

**TURBOLINK +** Now Add TURBO Protog to your Pascal Code!

**"TURBO Pascal hackers will like this program."**  
Jerry Pournelle  
Byte Magazine

- Add 512K of TURBO Pascal\* to your code
- Call up to 8 memory resident TURBO Pascal modules from programs written in:
  - BASIC, BASICA, Compiled BASIC
  - MS Pascal, C, MS FORTRAN
  - Standard, 8087 and BCD TURBO Pascal
  - TURBO Protog
- Add TURBO Pascal's 8087, BCD and graphic capabilities to other languages
- Automatically generate TURBO Pascal compatible inline machine code
- Use all TURBO Pascal variants in a single program
- Add AI capability to your Pascal programs
- For IBM PC and compatible

**\$6995** Foreign orders add \$10.00

S&H included  
VISA/MC: 1-800-835-2246 x123  
KANSAS CALL: 1-800-382-2421 x123  
Inquiries and Technical Information (303) 971-0729

**PATHFINDER SOFTWARE, INC.**  
P.O. Box 43, Littleton, CO 80160  
\*TURBO Pascal and TURBO Protog are trademarks of Borland International.

Inquiry 425

**100% ERROR FREE DISKETTES**

MFR. LIFETIME WARRANTY

With Hub Rings, Write Protect Tabs, Tyvec Envelopes, User ID Labels - In Factory/Sealed Poly Packs

**(YOU GET EVERYTHING BUT THE BOX) PRICES ARE PER DISK**

| 5 1/4" |      |           | 3 1/2" |      |
|--------|------|-----------|--------|------|
| SSDD   | DSDD | DSHD96TPI | SS     | DS   |
| .47    | .52  | 1.69      | 1.39   | 1.60 |

**SUPER DISCOUNTS ON ORDERS OF 500 OR MORE**

**IN STOCK ITEMS SHIPPED IN 24 HOURS**

Minimum order: \$25.00. Shipping and Handling: \$4.00 per 100 diskettes. Continental U.S.A. APO/PFO, add \$8.00 per 100 diskettes. Foreign order, please call. Reduced shipping charge for larger quantities. C.O.D. add \$4.00. Cash/certified check. MI residents add 4% sales tax. Prices subject to change without notice. HOURS: 8:30 AM - 6:00 PM Eastern Time

**Precision Data Products**  
P.O. Box 8367, Grand Rapids, MI 49518  
(616) 452-3457 • Michigan 1-800-632-2468  
Outside Michigan 1-800-258-0028

Inquiry 273

**COLOR**

**VT220 \$150**

\*plus your PC, XT, AT, or compatible

**ZSTEMpc™ VT220 Smart Terminal Emulator**

- Double high/double wide characters
- Full line graphics. Smooth Scrolling
- 2-way file transfers incl. XMODEM & KERMIT
- Full keyboard software/MACROS. DOS access
- Data rates to 38.4 KB High throughput
- CGA, Hercules, MDA, & EGA support
- 8-bit mode, downloadable fonts, user defined keys, full national/multinational modes
- ISO and attribute mapped color

ZSTEMpc-VT220 \$150 4010/4014 option \$99.  
ZSTEMpc-VT100 \$99 - Choice of the U.S. AF  
30 day money back guarantee. MC/VISA

**KEA SYSTEMS LTD.**  
#412 - 2150 W. Broadway  
Vancouver, B.C. CANADA V6K 4L9  
Support (604) 732-7411  
TELEX 04-352848 VCR

**Order Toll Free (800) 663-8702**

**Zstem by KGA SYSTEMS**

Inquiry 390

**a message to our subscribers**

From time to time we make the BYTE subscriber list available to other companies who wish to send our subscribers material about their products. We take great care to screen these companies, choosing only those who are reputable, and whose products, services, or information we feel would be of interest to you. Direct mail is an efficient medium for presenting the latest personal computer goods and services to our subscribers.

Many BYTE subscribers appreciate this controlled use of our mailing list, and look forward to finding information of interest to them in the mail. Used are our subscribers' names and addresses only (no other information we may have is ever given).

While we believe the distribution of this information is of benefit to our subscribers, we firmly respect the wishes of any subscriber who does not want to receive such promotional literature. Should you wish to restrict the use of your name, simply send your request to the following address:

**BYTE Magazine**  
Attn: Circulation Department  
One Phoenix Mill Lane  
Peterborough NH 03458

**Enhance Your Turbo Pascal™ Programming with TURBO-JET**

- Ultra Fast Screen Read and Display
- Advanced String and Numeric Formatting
- Advanced File and Keyboard Handling
- Subdirectory Utilities
- Over 100 Files Included!

Pascal Source Code included with all Routines  
Routines Crafted in Assembly Language  
No Royalties for Program Use  
Give Programs a Professional Look  
Don't Pay More For Less!  
Dealer Inquiries Invited

**TURBO-JET, Only \$39.95**  
Add \$3.00 for Postage & Handling  
NY Residents add sales tax  
**TOC Business Solutions, Inc.**  
P.O. Box 129  
Old Westbury, N.Y. 11568  
MC/VISA (516) 795-2800

Inquiry 423

# 21 MEGABYTE HARD DISK ON A PLUG-IN CARD

## \$449<sup>00</sup> MEGACARD!



© 1986, LOGIC ARRAY

**MEGACARD!** 21 megabyte hard disk drive on a plug-in board that instantly converts any PC or compatible to an XT.

And **MEGACARD!** enables PC and XT users with a hard drive to run two drives on a single slot. **You get an extra expansion slot!**

**MEGACARD!** combines the NEC "zero defect" program with state-of-the-art technology. This "drive-on-a-card" installs in seconds. **Just plug in and power up!**

**MEGACARD!** delivers:

- NEC technology
- "Zero defect" reliability
- Fast, easy plug-in installation
- Two year parts and labor guarantee.

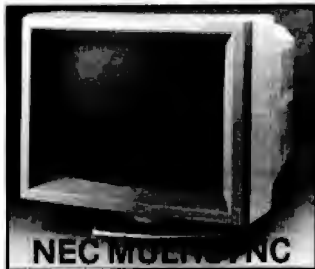

### NEC MONITORS

- JC1401P3A MULTISYNC  
CALL FOR PRICE
- JC1216DFA RGB 269.00
- JB1280DA TTL GREEN 105.00
- JB1285DA TTL AMBER 105.00

**From the legal beagles.**  
Prices and availability subject to change without notice.  
Prior authorization required on all returns.  
All returns subject to restocking charge.  
All normal manufacturers' warranties apply.  
NEC, MultiSync, EGA Paint are registered trademarks of their respective companies.

### CHIPS

- 64K DRAMS, SET OF 9 . . . . . 9.00
- 256K DRAMS, SET OF 9 . . . . . 27.00
- 128K PIGGYBACK, SET OF 18 . . . . . 72.00
- C8087 . . . . . 125.00
- C8087-2 . . . . . 179.00
- C80287-3 . . . . . 225.00
- V20 8MH . . . . . 10.95

### EGA

- ATI MEGA GRAPH PLUS . . . . . 295.00
- MYLEX EGA BOARD . . . . . 249.00
- RIX EGA PAINT SOFTWARE . . . . . 52.00



### PORTABLE COMPUTERS

NEC PC8201A . . . . . 360.00  
(See listing of 8201A programs)

#### PC8201A ADD-ON PRODUCTS

- PC8206A 32K RAM CARTRIDGE 360.00
- PC8221A THERMAL PRINTER 125.00
- PC8231A FLOPPY DISK DRIVE 560.00
- PC8241A CRT ADAPTER 149.00
- PC8281A PORTABLE CASSETTE RECORDER 85.00
- PC8201A-06 8K RAM CHIP 52.00
- PC8201A-90 NI-CAD BATTERY 16.00
- PC8271A-01 AC ADAPTER 16.00

### CASSETTE PROGRAMS FOR 8201A

- PERSONAL PLAN . . . . . 36.00
- GENERAL STATISTICS . . . . . 36.00
- BUSINESS GRAPHICS . . . . . 36.00
- FINANCIAL ANALYSIS . . . . . 36.00
- TAX PLANNING . . . . . 36.00
- APPLICATION KIT . . . . . 85.00
- REAL ESTATE ANALYSIS . . . . . 36.00
- PERSONAL FILER . . . . . 36.00
- TIME ACCOUNTING . . . . . 36.00

### MODEMS

- INTERNAL 1200 BAUD 230.00
- EXTERNAL 1200 BAUD 230.00
- SECURITY 1200 BAUD 310.00
- INTERNAL 2400 BAUD 375.00
- EXTERNAL 2400 BAUD 395.00

### NEC DISK DRIVE KITS

All drives include controller and cables.

- 5 1/4" 20MB D5126 . . . 389.00
- 5 1/4" 40MB D5146 . . . 649.00  
(40MB includes Disk Manager)
- 3 1/2" 20MB D3126 . . . 389.00



NEC DRIVE KITS

#### IT'S EASY TO ORDER

- **We ship immediately** when you pay by Visa, Master Card, Cashier's Check or Money Order. Allow 3 weeks for personal or company check.
- No Surcharge on Visa or Master Card.
- Minimum \$5 shipping and handling up to 3 lbs. in Continental U.S. only. On other orders, call for information.
- All orders insured.
- No Sales tax on orders outside California (California residents add 6% sales tax.)

When you want the best peripherals money can buy with expert technical support you'll just have to settle for paying less. **That's logic.** From Logic Array.

LOGIC ARRAY  
P.O. Box 3799  
Costa Mesa, CA 92628-3779

CALL NOW AND WE CAN SHIP TODAY!

# 800-22-LOGIC

# 800-843-0426 (in Calif.)

HOURS: Mon.-Fri. 7a.m.-5p.m. PDT

Inquiry 200 for End-Users. Inquiry 201 for DEALERS ONLY

FOR EXPERT TECHNICAL SUPPORT  
CALL 714/650-6700

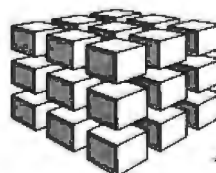

# Logic Array

# DATAFLEX™

- Multi-user Database!
  - Powerful!
  - Multiple Operating System Compatibility!
  - Attractive Dealer Pricing!
  - Full Dealer Support!
- Dataflex is a trademark of Data Access  
Dealer Inquiries Invited

## COGITATE

24000 Telegraph Road  
Southfield, Michigan 48034 USA  
(313) 352-2345

Inquiry 69

# PC Compatible CASH DRAWERS



## M-S CASH DRAWER

10711 Flower St., Stanton, CA 90680

(800) 544-1749

In California call:

(714) 821-1133

Inquiry 212

# SPEED IBM-PC/XT TO 700%

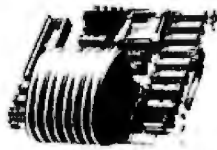

- Uses 80286 Processor
- Installs in Minutes
- Fits Short Slot
- Optional 80287 Processor

**\$399**

Computer-Age, Inc.  
55 Fishfry Street  
Hartford, CT 06120  
203-724-5100



AM-EX

Inquiry 78

# ICs PROMPT DELIVERY!!!

SAME DAY SHIPPING (USUALLY)  
QUANTITY ONE PRICES SHOWN BY JULY 21, 1988

OUTSIDE OKLAHOMA NO SALES TAX

| DYNAMIC RAM |         |        |         |
|-------------|---------|--------|---------|
| 1M          | 1000Kx1 | 100 ns | \$70.00 |
| 256K        | 64Kx4   | 150 ns | 4.00    |
| 256K        | 256Kx1  | 100 ns | 5.50    |
| 256K        | 256Kx1  | 120 ns | 3.34    |
| 256K        | 256Kx1  | 150 ns | 2.74    |
| 128K        | 128Kx1  | 150 ns | 4.25    |
| 64K         | 64Kx1   | 150 ns | 1.29    |
| EPROM       |         |        |         |
| 27512       | 64Kx8   | 250 ns | \$23.00 |
| 27C256      | 32Kx8   | 250 ns | 6.65    |
| 27256       | 32Kx8   | 250 ns | 5.20    |
| 27128       | 16Kx8   | 250 ns | 3.65    |
| 27C64       | 8Kx8    | 200 ns | 4.55    |
| 2764        | 8Kx8    | 250 ns | 3.40    |
| STATIC RAM  |         |        |         |
| 43256L-12   | 32Kx8   | 120 ns | \$35.00 |
| 6264LP-15   | 8Kx8    | 150 ns | 2.94    |

OPEN 6 DAYS WE CAN SHIP VIA FED-EX ON SAT

SUNDAYS & HOLIDAYS: SHIPMENT OR DELIVERY, VIA U.S. EXPRESS MAIL

SAT DELIVERY INCLUDED ON FED-EX ORDERS  
RECEIVED BY 7:30 AM '88 \$4.95  
FR: P.O.# 313-2 No

MasterCard VISA or UPS CASH COD  
**Factory New, Prime Parts**   
MICROPROCESSOR UNLIMITED, INC.  
24,000 S. Peoria Ave. (918) 267-4961  
BEAUGO, OK, 74421

Please call for current prices because prices are subject to change. Shipping & insurance with cash discount prices shown. Orders received by 4 PM CST can usually be delivered to you the next morning, via Federal Express Standard Air = \$6.00, or Priority One = \$12.00

# 68020

FHL 20x30

- Multi-user/Multi-Tasking
  - 32-Bit MC68020 — 12.5 MHz
  - 6 to 30 Users
  - 2.5 MByte to 14.5 MByte
  - 32-Bit Expansion Bus
  - Built-in SCSI/SASI w/DMA
  - DIP Switches select Baud Rate
  - Hard Drive (20MB to 150MB)
  - 720Kb Floppy Drive
  - Real Time Clock w/Battery Backup
  - Software included: OS9/68000; Basic; Word Processing; Spreadsheet; Utilities
  - Options: MC68881 Coprocessor 2MB/4 Serial Port Board Memory Protection Graphics Board Pascal and C
- Dealer Inquiries Invited

Frank Hogg Laboratory, Inc.  
315-474-7856 TELEX 646740

Inquiry 137

# ROBOTICS — SCIENTIFIC BUS For IBM PC/XT/AT/compatibles, Apple II...



- Host Adapter: Modular approach to data acquisition and control. A 40 conductor ribbon cable bus is generated by a host adapter card. Up to 8 low cost modules can be located anywhere on a cable up to 100 ft long. They feature: DMA, interrupts, 16 data bits, Open & non-proprietary Host adapter card, utility software & manual \$189.
- Fast A/D Module: 650K sample/sec, 8 bit, four differential channels programmable gain & offset, 12288 Counts package with Scope program, host adapter, Fast A/D Module & cable \$690 FTT available.
- 12 Bit A/D Module: four channels, 10K sample/sec, int. amp. \$236
- Rev/Relay Module: 16 standard relay each, 24 bit I/O, interrupts
- Clock Module: Real time & period, battery, interrupts, software
- Four Axis Stepper Motor Driver Module: 15V @ 1.5A/phase motor. Full step, half step, brake, free wheel. Software & motor included \$99
- Smart Dual Axis Motor Control Module: For DC, brushless & stepper motor drivers & encoders. Processors (from IOP) allow changes & monitoring on the fly. Optically isolated. Call for low cost.
- Unique to LAB 40 is its ability to efficiently interface directly to chips, such as co-processors & converters, with the lowest hardware & software overhead. Call for more info or order our Proprietary.
- LAB 40 Proprietary: 10 hardware and software projects with IBM PC \$25

Computer Continuum  
75 Southgate Ave., Suite B • Daly City, CA 94015  
(415) 755-1976

Inquiry 238

Serial Parallel



Convert What You Have To What You Want!

- RS232 Serial
- 8 Baud Rates
- Latched Outputs
- Centronics Parallel
- Handshake Signals
- Compact 3 1/2 x 4 1/2

No longer will your peripheral choices be limited by the type of port you have available! Our new High Performance 700 Series Converters provide the missing link. Based on the latest in CMOS technology, these units feature full baud rate selection to 18.2K, with handshake signals to maximize transfer efficiency. Detailed documentation allows simplified installation. Order the Model 770 (Ser/Par) or Model 775 (Par/Ser) Today!

Buffer Products Coming Soon!

only \$89.95

224-C Johnson Dr.  
Post Office Box 3777  
Van Nuys, California 91408

CALL (805) 658-7466 or 658-7467  
For FAST Delivery

Inquiry 348

# MYSTIC PASCAL Fastest Compiler on Earth NOW ONLY \$16!!!

- 640K code, data and stack
  - incremental compiler runs in background while you are editing
  - produces linkable OBJ files
  - color graphics with pan & zoom
  - 8087 & software math
  - true multi-tasking for up to 100 Pascal procedures
  - full screen editor
  - complete Help windows
  - We are open 8-5 Mtn. time, Mon-Sat
- disk with condensed manual to print out \$16—printed manual \$16—both \$32—for IBM PC 320K Visa/MC/COD—add \$2 shipping, COD \$5, overseas \$10
- Mystic Canyon Software  
P.O.B. 1010  
Pecos, NM 87552 505/757-6344

Inquiry 245

# PC/XT USERS!

- COGTREE Utilities by Cogitate ..... \$129.95
- LYNX by Norton-Lamber ..... \$199.95
- DATAFLEX by Data Access...Varies
- RMICOBOL by Ryan McFarland .....Varies
- Universe by Omnitrend.... \$ 98.50
- Blue MacI by Cogitate..... \$599.00
- CadPower+ by Trilex..... \$995.00
- Softext Teaching Aids..... \$ 95.00
- PrintSet by Cogitate..... \$ 79.95
- COGTAPE by Cogitate..... CALL!!
- Anti-Static Products.....Varies
- Uninterruptible Power Backups.....Varies
- TeleVideo Software.....CALL!!

**COGITATE**

"A Higher Form of Software"  
24000 Telegraph Road  
Southfield, MI 48034  
(313) 352-2345/Telex 3865581

VISA/MASTERCARD ACCEPTED  
Dealer Inquiries Welcomed

Inquiry 70



### COMPUTER SYSTEMS

#### IBM-PC COMPATIBLES

WE CARRY A WIDE RANGE OF DESKTOP, LAPTOP & PORTABLES DESIGNED TO RUN THE SOFTWARE THAT FUELS TODAY'S BUSINESS.

SHARP PC-7000 8088 LAPTOP .....\$1299  
ZENITH 148, 158, 171, 200AT.....UP TO 50% OFF



ACS ET-286 1Mb, 3S&2P, CLK, 8 SLOTS, 6/10/12.5MHz, 20Mb & 1.2Mb DISKS, MSDOS 3.2.....Complete \$2595  
ACS-1000 SYSTEM 84.77MHz, 2 FLPY DRVS, 1Mb RAM, 20Mb H.D. DRV., COLOR/MONO CTRL., MSDOS 3.2, SASI, 2 S/P PORTS, CLOCK/CAL-BATT .....\$1650



PC-400 512K, 2 FLPYS, 14" 840x400, 512K.....\$1149  
20Mb HARD DISK SYSTEM WITH 2 FLPYS ...\$1499  
ATD-8-Q 8MHz 80286, 640K, S, P, 1.2 FLPY .....\$2039  
ATP-8-Q PORTABLE .....\$2189

#### EPSON

EQUITY II 8MHz V30, 640K, S, P, CLK, FLPY, MS-DOS & GWBASIC - RUNS 2.0 NORTON UTILITIES! .....CALL



#### KEYBOARD IS EXTRA:

PC-STYLE...\$139 PROFESSIONAL AT-STYLE...\$179  
MODEL 200 HT8088-2, 256K, S,P,CLK, 720x350 MONO DISPLAY, MSDOS, GWBASIC .....\$1635  
MODEL 400 HT FLPY AND 20Mb .....\$2119  
PC / IT 8MHz 80286, 1.2 FLPY, 512K, 8 SLOTS .....\$2149  
PC / IT ENHANCED WITH 1Mb & 40Mb H.D. DRV. ....\$2959



1088-50 1Mb RAM, 50Mb HARD DISK, 50Mb TAPE DRIVE, XENIX.....\$11399  
1088-80 AS ABOVE W/ 80Mb HD TAPE.....\$12999  
686-25 6USER, 25Mb H.D., XENIX.....\$4099  
686-50 AS ABOVE WITH 50Mb H.D. ....\$6199

### NETWORKING

CALL FOR DEALER PRICING, INTEGRATION, AND/OR CONSULTATION.

COMPUPRO NET 100.....\$369



PC-SLAVE / 16 1Mb, 8MHz, V20 .....\$595  
RTNX MSDOS 2.1 ..\$109 ATNX MSDOS 3.1 ..\$189



LAN-PC ARCNET FOR PC'S .....\$349  
WS-285 8MHz 80286, 5 SLOTS, ARCNET IV, 640K, SCSI, AT TYPE ENCLOSURE & P/S .....\$1398

### NOVELL

ADVANCED NETWORK STARTER KITS SOFTWARE, DEYCARD, 2 NICs, CABLES INCLUDED .....From \$1795



USER NET SOFTWARE / 88 & KEY-CARD .....\$895

### PC/XT/AT BOARDS

STB RIO GRANDE 128K-1.5Mb, P & S .....\$193  
STB CHAUFFER RUNS RGB IN MONO .....\$189  
STB ATTA-BYTE 0-384K FOR AT & T .....\$159  
TECMAR WAVE 64-256K \$150 BOSUN S,P,CLK \$150  
TECMAR MAESTRO 0-2.5Mb,S,P&TREAS.CHEST.\$295  
TECMAR CAPTAIN O.K.S,P,CLK & TREAS. CHEST...\$155  
TECMAR EXPANSION CHASSIS II SLOTS, ETC. ....\$639



6 PACK PLUS .....\$155  
6 PACK PREMIUM .....\$325  
RAMPAGE AT .....\$429  
ADVANTAGE .....\$325  
3Q-EGA .....\$275



INTEL ABOVE BOARD PCMB 1010 64 TO 512K, ALLOWS LOTUS, SYMPHONY, OTHERS TO RUN ABOVE 640K.....\$255  
INTEL ABOVE BOARD-AT 128 TO 4Mb .....\$399  
MACROTECH MSR-AT 0-3Mb RAM FOR IBM-AT @ 6, 8, 10, & 12MHz. NO WAIT STATES .....\$185 - \$625

### CAD

CORDATA FASTDRAFT 480x640, 256K, 16 CLR .....\$949  
HANZON LP-3000+ LASER HPGL PLOT. COM.,CALL  
ACS GRAPHAX 20 / 20 2Xx2K GRAPHICS RESOLUTION 2.5Mb BD., UP TO 32 COLORS, AUTOCAD .....CALL



DMP 41/42 .....\$2499  
DMP 51/52 .....\$3799  
DMP 56 .....\$4549  
DMP 29 .....\$1749 DMP 40 .....\$899  
TRUE GRID DIGITIZERS

TG1005 .....\$289  
TG1011 .....\$539  
TG1017 .....\$655

### POWER SYSTEMS & ACCES.



ALL CABLES SOLD AT DEEP DISCOUNT.....CALL  
S4 4 CIRCUIT SURGE SUPPRESSOR .....\$26  
S10 6 CIRCUIT SURGE SUPPRESSOR .....\$29  
P15 5 CIRCUIT MONITOR BASE W/ MODEM PROT.....\$98  
U1000 POWER SAVER 1000W U.P.S. (TOPAZ) .....\$729



SB-1000 WATT WITH BATTERY 30-60 MIN. ....\$659  
BC-1000 WATT/WSELF CONTAINED BATT.15-30Min@800

SAFE (SAFT) SPS1000 WATT SINE WAVE .....\$989  
SOLA 750 WATT W/ 4500 WATT HI-INRUSH .....\$1495

### MONITORS & TERMINALS

NEC MULTISYNC .....\$515  
TECMAR RGB HI-RES ZVM-1360 .....\$488  
ZENITH ZVM-1240 (IBM) FLAT SCREEN .....\$149  
PRINCETON GRAPHICS ALL MODELS .....CALL



CM-1360 640x200 RGB, 13", G/A SWITCH .....\$359  
CM-1380 EGA 640x350 RES .....\$479  
1422A DUAL FREQ., TILT/SWIVEL, 14", G/A .....\$139



125 EMULATES WY-50 ETC., HIRES 14" GREENAMBER, 6 SCROLL RATES, IBM SELEC., K.B., 1 YR WARR. ....\$385  
PC-TERM EMUL WY-50, TVI 925, IBM-AT KB, FOR MULTI-USER PC-SLAVE BOARDS .....\$419

WYSE 60 .....\$475  
LIBERTY FREEDOM ONE .....\$395

### PRINTERS & BUFFERS



M-1109 100-25 CPS P & S, TRACTOR .....\$203  
HR-35 36CPS DAISEY, WIDE CARR. ....\$729  
HR-20 20 CPS .....\$349

CITIZEN MSP-10 .....\$250 MPS-15 .....\$349  
CITIZEN MSP-20 .....\$315 MPS-25 .....\$485  
CORDATA LP-300 LASER W/WORDSTAR 2000.....\$2175  
HANZON LP-3000+ LASER CAN EXECUTE HEWLETT-PACKARD GL PLOTTER COMMANDS.....CALL  
STAR MICRONICS SR-15 .....\$595  
TOSHIBA P321 PARA. & SERIAL .....\$449  
TOSHIBA P341 .....\$769  
TOSHIBA P351 PARA. & SERIAL .....\$909  
OKIDATA 292 COLOR PRINTER .....\$459  
OKIDATA 293 COLOR W/ TRAC., 132 COL .....\$599



XERON D25 DIABLO .....\$484 635 DIABLO.....\$1048  
DIABLO D80-IF .....\$2049 DIABLO 34LQ .....\$989  
4045 LASER WITH COPIER & 512K RAM .....\$4795



PERSONAL SPEECH SYSTEM .....\$295

### SCIENTIFIC / INDUST. BDS.



A/D 64-100 .....\$315 A/D 84-PC .....\$395  
D/A 64-100 .....\$236 D/A 64-PC .....\$468  
1018-PC 98 TTL INPUT LINES .....\$448

### SCIENTIFIC SOLUTIONS (TECMAR)

IEEE-488 .....\$239 LAB MASTER .....\$659

### S-100 BOARDS

ONE STOP SHOPPING FOR ALL OF YOUR INTEGRATION AND POST SALE SUPPORT NEEDS. WE HANDLE CCS, COMPUPRO, DUAL, I.C.M., ILLUMIN. TECH., LOMAS, TELETEK, MULLEN, P&T, INDUST. COMP. DESIGNS, TARBELL, ETC. THIS MONTH'S SPECIALS ARE:

CONCURRENT DOS 4.1D .....\$495 CDS 4.1E .....\$750  
SPUZ 8MHz Z80, 256K, 4 USERS .....\$269  
INTERFACER-3 & SERIAL PORTS .....\$439  
SYSTEM SUPPORT 1 WITH CLK, BATT, SERIAL.....\$289  
DISK 1A 5" & 8" FLOPPY CONTROLLER.....\$439  
DISK 3 5" HARD DISK CONTROLLER.....\$509  
RAM 22 256K STATIC RAM.....\$446



DUAL: AM-12 D/A CONVERTER.....\$546  
DUAL: AOM-12 A/D CONVERTER.....\$509



THUNDER + 8MHz 80186, 512K, 2S, P, FLPY CTRL, CDS 4.1 - LITERALLY A SYSTEM ON A BOARD.....\$895  
LIGHTNING 286 8MHz W/ ON-BD DIAGNOSTICS.....\$819  
COLOR MAGIC PC VIDEO FOR S-100 BUS.....\$445



AM-286 10MHz 80286&80MHz Z80H.....\$695  
ST-11 1Mb STATIC RAM.....\$649  
MSR-11 1Mb DYNAMIC RAM.....\$799

### HARD DISK & TAPE DRIVES

PC-INSIDER, PC-OUTSIDER & AT-INSIDER HARD DISKS FOR IBM AND COMPATIBLES SET-UP TO BOOT FROM HARD DISK WITH ALL NECESSARY HARDWARE AND PC-STYLE CABINET FOR EXTERNAL DRIVES.

### 20Mb PC-INSIDER.....\$379

30Mb PC-INSIDER (SEAGATE ST-238).....\$535  
72Mb PC-IN/OUTSIDER 30mSEC. ....\$1788  
COMPUPRO 40Mb INT. SUBSYS. W/ DISK 3.....\$1585  
COMPUPRO 80Mb INT. SUBSYS. W/ DISK 3.....\$2049  
ALLOY FT-60 60Mb @ 1.8Mb/Min. For PC Compat.....\$785  
IRWIN 10Mb TAPE/PC or CPPO - Requires CDS.....\$389  
TECMAR QIC 60-AT INT 60Mb TAPE .....\$1079  
TECMAR MACDRIVE 10Mb .....\$1099  
TECMAR MACDRIVE 10Mb & 5Mb REMOVABLE.....\$1850  
WANGTEK PC-36 60Mb INT. TAPE, FAST & EASY.....\$785

### BARE WINCHESTER DRIVES

TEAC SD520 26Mb HH 5 1/4" .....\$299  
SEAGATE ST-4051 51Mb, 40mSEC, FH 5 1/4".....\$795  
QUANTUM Q540 43Mb, 45mSEC, FH 5 1/4".....\$995  
MICROPOLIS MC-1325 85Mb, 30mSEC, FH 5 1/4".....\$1395  
MAXTOR XT-1140 140Mb, 30mSEC, FH 5 1/4".....\$3289  
MAXTOR XT-2190 190Mb, 30mSEC, FH 5 1/4".....\$3895  
AMCODYNE ARAPAHOE 7110 25Mb FIXED & 25Mb REMOVABLE CDC LARK PLUG COMPATIBLE.....\$3495

### FLOPPY DISK DRIVES

MITSUBISHI 2894 8".....\$475 2896 1/2 HT, 8".....\$435  
MITSUBISHI MF501 48TPI.....\$95 MF504 96TPI.....\$149  
TEAC FD555V 48TPI .....\$89

### SOFTWARE

WE SELL ALL WELL KNOWN BRANDS. ORDER CORRECTLY! SOFTWARE IS NOT RETURNABLE!

NEWSTAR NEWWORD 2 WITH MERGE, SPELL CHEK, NEWSTAR NEWWORD 3 FOR PC'S, SPELL CHECKER, INDEXING, CONTENT TABLES, MACROS, SHORTHAND KEYBOARD, MULTI-TASKING .....\$269  
BD SOFTWARE C COMPILER 8" SSDD 8 BIT .....\$95  
MICROSOFT --- ASHTON-TATE ..... 35%  
MICROPRO --- MULTIMATE --- P.F.S. .... 41%  
BORLAND INT'L TURBO PASCAL, ETC. .... 41%  
MOST OTHER PC PROGRAMS ..... 41%

### MODEMS



PROMODEM 1200.....\$259  
PROMODEM 1200G .....\$179 2400G .....\$339  
PROMODEM 300C - APPLE IIC PEGGY BACK .....\$79



MT224EH MNP ERROR CORREC. ....\$529  
MT224ER RACK MOUNT W/ EDC .....\$485

CTS HAYES COMPAT. 212AHC \$149 224ADH \$295  
HAYES - ALL MODEMS .....CALL

All merchandise new. Advertised prices are cash prepaid only. PO's from qualified firms & AM. Express - add \$4.00. Visa - add 3% Wires. COD's (\$5 min. fee) with Cashiers Check/MO & APO's accepted. Shipping: minimum \$4 first 5 lbs. Tax. AZ RES ONLY add 6.1% sales tax. All returns subject to 20% restocking fee or 10% if for future purchases. All prices & availability subject to change without notice.

**NO SHIPPING CHARGES**  
**ORDER TOLL-FREE 800-824-3432**  
In California Call (918) 341-8823

| <b>DRIVES</b>           |        |
|-------------------------|--------|
| 1/2 Ht. IBM™ Compatible | 89.99  |
| Tandon 100-2            | 99.99  |
| Tandon 100-4 (96 tpi)   | 129.99 |

**SYSTEMS**  
**PC/XT Compatible 499.99**

- 640K on Motherboard
- Flip Top Case
- 1-1/2 HT Floppy
- 135 Watt Power Supply
- Mono Card w/Printer Port
- 5150 Type Keyboard

We carry a complete line of electronic components. Call or write for our free catalog!

**NICORN ELECTRONICS**  
 10010 Canoga Ave. Unit B • Chatsworth CA 91311

Minimum order \$100. No shipping charges on prepaid orders. C.O.D. not accepted. UPS Blue Star \$1.00. Call weekdays 8:00-5:00. Fax: 818/341-8823. Shipping head for clearance. VISA, MC.

**NEW!**



**SafeSkin™**  
**KEYBOARD PROTECTOR**

Remains in place during keyboard use. Prevents damage from liquid spills, dust, ashes, etc. Fits like a second skin, excellent feel. Available for: IBM-PC, AT, Apple (all), Compaq, Model 100, NEC 8201, C64, Zenith 150, DEC, Kaypro, KB5151, AT&T 6300, WYSE 50 and many others. Send \$29.95, check, M.O., Visa & MC include exp. date. Specify computer type. Dealer inquiries invited. Free brochure avail.

Merritt Computer Products, Inc.  
 2925 LBJ Fwy. #180 / Dallas, Texas 75234  
 (214) 339-0753

**TURBO MASTER**

Turbo Master is an integrated development system for Turbo Pascal programmers consisting of six floppy disks and a manual. The components of this system include the following: Turbo Screen Master, Turbo ISAM Master, Turbo Menu Master, Turbo Toolkit Master, and Resident ISAM Master. The Turbo Screen Master features Intelligent Cursor which allows you to draw boxes and borders by simply moving the cursor to the desired position, and Extended Variable Names which allows the use of arrays and structures in your variable names. The Turbo ISAM Master generates ready to run Turbo programs using Borland's Turbo Pascal Database Toolbox. It automatically interfaces to Turbo Screen Master. The Turbo Menu Master features a menu data base and an interactive menu builder allowing for the automatic entry and reorder of selections and users choice of procedure, chain, execute or comment code generation for each selection. The Turbo Toolkit Master includes procedures for full control over all screen attributes, advanced string functions, automatic control of multiple help screens, saving and retrieving screens to RAM buffers, Caps/Num/Scroll/Lock control procedures, and report procedures. The Resident ISAM Module uses less code space, provides a key buffer data area outside your program's data space. All of these programs are available as a package for:

Money Back Guarantee **\$99.95 plus 7.50 S&H**  
 Hawaiian Village Computer Software  
 1109 Pennsylvania Ave., St. Cloud, FL 32709  
 Info: (305) 892-5686 (800) 521-9503

Inquiry 359

Inquiry 225

Inquiry 151



**Sure it's insured?**

SAFWARE® Insurance provides full replacement of hardware, media and purchased software. As little as \$39/yr. covers:

- Fire • Theft • Power Surges
- Earthquake • Water Damage • Auto Accident

For information or immediate coverage call:  
**1-800-848-3469**

*In Ohio call 1-614-262-0559*



SAFWARE, The Insurance Agency, Inc.

**Heritage Systems Corp.**

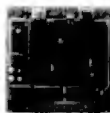

**HSC-9100**  
 80 By 24 Or 25 Line  
 Alpha-numeric  
 Video Terminal Card

ANSI X3.64/Other Terminal Emulations  
 50 To 38.4K Baud Serial Port  
 RS-232 Or TTL/CMOS Versions  
 IBM PC Compatible Keyboard Input  
 EEPROM Based On Screened  
 Configuration  
 Composite or Separate Video  
 100 By 100mm Card 5V Only @ 200mA  
**\$139 TTL/CMOS      \$149 RS-232**

**PO Box 10588,**  
**Greensboro, NC 27404-0588**  
**(919) 274-4818**

Inquiry 300

Inquiry 153

Inquiry 169

ANNOUNCING .... a high performance MC68000 based 32 bit APL interpreter exclusively for the IBM PC/XT/AT and compatibles .... single or multi-user .... total integration with DOS hardware and software environment.

**MultiAPL**

- 10-12-15 MHZ 68000 coprocessors
- Up to 6MB RAM per PC
- No object size limitation
- Full printer support
- Multi-user file system
- Local Area Network facilities
- 32081 floating point processor
- Other systems available for: Macintosh, Amiga, Atari ST, etc.

Single-user \$995 • Multi-user \$1495  
 Coprocessor boards start at \$1950

**SPENCER ORGANIZATION, INC.**  
 PO BOX 248 / Westwood, NJ 07675 / (201) 666-6011  
 VISA / Mastercard / American Express accepted

**ONE COMPUTER & TWO PRINTERS?**

Stop Plugging & Unplugging! use your choice of TWO printers from ONE parallel cable with the simple flick of a switch.



**\$65.95**  
 Plus \$3.25 Shipping

**30 Day Money Back Guarantee**  
 Model #2100

One Parallel Plug In ... Two Parallel Plugs Out!  
 Connect any Standard Centronics Parallel Cable directly to the switch. Two 3/8" cables (included) attach to each printer.

Simply Call **1-800-TD-ASK-US1** 8am-5pm PST  
**800-862-7587**  
**(CA 415/567-4067)**

To Order Write or call Tipz Direct, Inc. Visa/MC or Money Orders please. Shipping within 48 hrs. via UPS.

Offering a FULL LINE of Switches, Cables, & Accessories

P.O. Box 690,  
 San Francisco, CA 94101-0690

**Tipz**  
 BYT-210

Inquiry 326

Inquiry 350

Inquiry 295

**LEARN C**  
 THROUGH OUR NEW  
**VIDEO TRAINING COURSE**

**A PROGRAMMER'S INTRODUCTION TO C**—This three-hour video tape with text that takes a programmer from an introductory level thru to arrays and pointers. (Introductory Price \$400.)

Also available: our courses on **COMPUTER LITERACY, BASIC TELECOMMUNICATIONS and LOCAL AREA NETWORKS.**

Call us today for a 15 DAY FREE TRIAL (or request our complete course catalog).

**408-374-1235**

the **INFORMATION FACTORY**

206 Charter Oaks Circle  
 Los Gatos, CA 95030



Inquiry 300

Inquiry 153

Inquiry 169

**ROSE DATA SWITCHES**



SHARE computers, printers, any parallel or serial device  
**ELIMINATE** cable swapping  
**INEXPENSIVE** way to network  
**COMPATIBLE** with all computers

Businesses, Schools, Homes  
**WE ALSO OFFER:**  
 Data Buffers, Line Drivers, Modems, Protocol Converters, Parallel - Serial Converters, Cables, Computers, Printers, Disk Drives, and more

**AUTOMATIC - CARETAKER** is ideal for a business or school to share a printer or modem among many computers. Operation is fully automatic with no software required. Parallel or Serial 4 channels - \$295 8 channels - \$395

**MANUAL - HARD SWITCH** is operated with the flip of a switch. 2:2 and 2:4 models allow simultaneous communication.

Serial 1:2 - \$58 1:4 - \$ 99 2:2 - \$109 2:4 - \$169  
 Parallel 1:2 - \$79 1:4 - \$139 2:2 - \$119 2:4 - \$199  
 LED and spike protection on serial models add \$20

**CODE ACTIVATED - PORTER** connects one computer to multiple peripherals. A software code selects the peripheral. Parallel or Serial 4 channels - \$295 8 channels - \$395  
 Buffer option \$4K - \$100 256K - \$250

**REMOTE - TELEPATH** connects multiple computers to multiple peripherals. A selector at each computer or terminal chooses up to 4 peripherals and displays busy status. 4:4 - \$495 4:8 - \$795 selector - \$39.

Give a Rose to your computer  
**ROSE ELECTRONICS (713) 933-7673**  
 P.O. BOX 748711 MC & VISA Accepted  
 HOUSTON, TX 77274 Dealer inquiries invited  
**CALL US FOR ALL YOUR INTERFACE NEEDS**

# ATTAK-286™

**HIGH SPEED 12 MHZ OPERATION** Software Selectable for **6,8,10, and 12 MHZ!**

- FULL IBM PC-AT\* COMPATIBILITY!
- FOUR MEGA-BYTE RAM CAPACITY ON MOTHERBOARD! USING 1 MEGA-BIT DRAMS.

**QUANTITY DISCOUNTS AVAILABLE FOR QUALIFIED DEALER, OEM, UNIVERSITY AND CORPORATE ACCOUNTS.**

**NEW!**

## HIGH SPEED INDUSTRIAL GRADE COMPUTER FOR:

- Scientific
- Engineering
- Industrial
- Medical
- University/Education
- Artificial Intelligence
- Etc., Etc., Etc.

Eight Compatible I/O Interface Connectors  
(Same as PC-AT)

Keyboard Interface  
(Same as PC-AT)

On Board Battery

CMOS Clock Calendar

Standard Power Connector  
(Same as PC-AT)

80287 Math Processor  
(Same as PC-AT)

Extended ROM Capability  
(Operates on all compatible BIOS ROMS)

Runs Intel 80286 at 6,8,10&12 MHZ!  
(Software selectable)

Extended Memory Capacity!  
Full Four Mega-Byte Capacity on Motherboard!  
(Uses 256k or NEW 1 Mega-Bit Drams)

Peripheral Support Circuits  
(Same as PC-AT)

**ORDER NOW!!**

**ONLY!**

**\$199<sup>95</sup>**  
**EVALUATION BOARD KIT**

- ATTAK-286™ FULLY ASSEMBLED (LESS ICS) ..... \$499.95
- AT CASE 100% COMPATIBLE..... \$129.95
- AT POWER SUPPLY 192W..... \$129.95
- ATTAK-286™ TECHNICAL REFERENCE MANUAL .... \$ 29.95
- TURBO-SCOPE™ A/D BOARD ..... \$ 99.95

Board Size: Standard IBM-AT\*  
Dimensions: 12 inch x 13.8 inch  
with 6 mounting holes to fit all AT compatible cases.

**100% SATISFACTION GUARANTEED.  
10 DAY MONEY BACK GUARANTEE IF NOT COMPLETELY SATISFIED!**



ATTAK-286™ evaluation board kit highest quality multi-layer PC board with full assembly instructions and parts lists!

**AiT** ADVANCED INTELLIGENCE TECHNOLOGY CORPORATION

4100 Spring Valley Road  
Suite 400  
Dallas, Texas 75244  
(214) 490-0344

TERMS: We accept cash, checks, money orders and credit cards. Prices and availability subject to change without notice. Shipping and handling charges via UPS ground 50¢/lb UPS air \$1.00/lb. Minimum charge \$3.00.

\*IBM and IBM PC-AT are trademarks of International Business Machines

© 1986 AiT CORP.

Get the whole story on graphics terminal emulation.



To find out more about software that lets your PC emulate TEKTRONIX™ 4105/6/7/9 and DEC VT100™ terminals, call or write:

**GRAFPOINT**

4340 Stevens Creek Blvd., Suite 280, San Jose, CA 95129 (408) 249-7951

Inquiry 146

An RS-232 Break-Out-Box at a Fraction of the Cost.

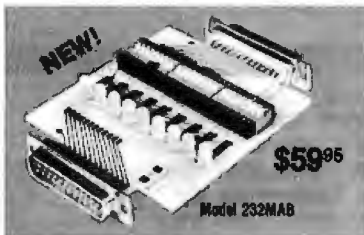

RS-232 Multi-Adapter Board: 9 LED's for signal monitoring. 24 switches to open any line (except line 1). 20 jumper wires allow re-wiring to any configuration. 1 male and 1 female connector. Order direct! Only \$59.95. All cash orders postpaid. (IL res. add 6% sales tax). We Accept MC, Visa. Free illustrated catalog of RS-232 interface and testing equipment. Phone: 815-434-0846. Make checks payable to:

**B&B electronics**  
MANUFACTURING COMPANY  
1500B BOYCE, OTTAWA, IL 61350

Inquiry 34

**FREE!**  
THE MOST COMPLETE REFERENCE GUIDE ON DIABLO PRINTERS.



- Complete exploded diagrams of Diablo printers and key components — 150 pgs.!
- The most complete parts inventory outside of Diablo — including many hard to find parts.
- Detailed listing of new and re-manufactured printers.
- Plus new laser printing systems

CALL TOLL FREE  
1/800/225-8116 1/800/235-6116 415/887-6116  
(Inside California) (Outside California) (Local)  
OR WRITE TO:

**THE PRINTER WORKS** 1061 ALPINE WAY, HAYWARD, CA 94545

Inquiry 277

**SERIAL ASCII VOLTMETER**

- SAV10 RS232 SERIAL ASCII VOLTMETER \$169
- SAV11 RS422 SERIAL ASCII VOLTMETER \$239
- MA15 RS232/RS485-RS422 INTERFACE \$149

- 4 analog voltage inputs of 0-2.55V, measured simultaneously at 8 bit resolution.
- Stand alone operation.
- Selectable data rate.
- Low power consumption.
- Rugged, compact package

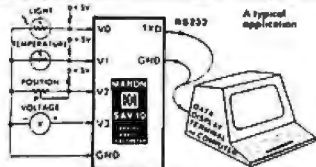

MARON PRODUCTION INC.  
DISCOVERY PARK, 105-3700 GILMORE WAY  
BURNABY, B.C., CANADA V5G 4M1  
Phone (604) 435-6211

Inquiry 220

**RS-422**  
Communications Board

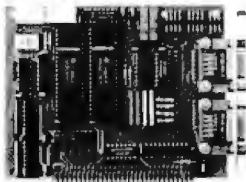

- For IBM-PC/AT/XT and compatibles
- Dual RS-422/RS-485 interface
- Differential drivers to 4000 ft.

**Fast Delivery**  
**QUA TECH, INC.**

478 E. Exchange St. Akron OH 44304  
(216) 434-3154 TLX: 5101012726

Inquiry 286

PC DIADAC "•" TAKE CONTROL WITH YOUR IBM PC / CLONE  
16 CHANNEL 12 BIT ANALOG INPUT  
UP TO 4 CHANNEL ANALOG OUTPUT \$375.00  
DIGITAL I/O



DIADACS 1 "•" TAKE CONTROL WITH YOUR COMMODORE 64  
16 CHANNEL 12 BIT A/D CONVERTER  
D/A CONVERTER 12 BIT DIGITAL OUTPUT 10 LINE  
DIGITAL INPUT 12 LINE REAL TIME CLOCK

Control complete with user's manual and software driver ..... \$279  
DATA ACQUISITION SOFTWARE for C64 150  
DEALERS/REPRESENTATIVES PLEASE CALL  
**MICROTECH** P.O. Box 102 • LANGHORNE, PA 19047  
(215) 751-0284

Inquiry 58

**Printer (Data) switch \$39.00**  
Dealers & OEM Welcome



- Metal case, beige color
- Push button or rotary switch
- 2 layer PC board, fully shielded
- Dimension: 1" x 4 1/2" x 9 1/4"
- All pin switched
- 1 year warranty

|               |                 |                             |      |
|---------------|-----------------|-----------------------------|------|
| Switch box    | DB25/Centronics | RS232 Miniature             |      |
| 3 way switch  | \$28.95         | Gender changer M/M, F/F     | \$7  |
| 2 way cross   | \$26.95         | Null modem                  | \$10 |
| 4 way switch  | \$28.95         | Jumper box, surge-protector | \$10 |
| Break-out box | \$29            | Mini remote link-patch box  | \$15 |

**Cable (Lifetime warranty) \$10 up**  
• UL approved, molded, double shielded, beige color  
• D type connector with thumb screw (screwless)

|                                                                     |          |              |
|---------------------------------------------------------------------|----------|--------------|
| Printer Cable (For IBM)                                             | 6' 7/10' | \$108/128/14 |
| Generic Cable (male to male)                                        | 6' 7/10' | \$146/14     |
| RS232 Cable (male to male)                                          | 6' 7/10' | \$126/14     |
| RS232 Cable (male to female)                                        | 3' 7/10' | \$108/128/14 |
| (25 line non-shielded ones can be used as modem or extension cable) |          | \$79/9       |
| XT Floppy Cable/Shift Disk Cable                                    |          | \$79/9       |

30 Day Money Back Guarantee  
Term: C.O.D. \$1.90  
Plus shipping & handling  
California residents add sales tax

**JACO Enterprises**  
1478 Poppy Way  
Cupertino, CA 95014  
(408) 996-0875

Inquiry 176

**IF YOU USE A COMPUTER YOU CAN USE**

UNIT CONVERSIONS™  
NOW ONLY \$49.95

IBM PC/XT/AT and Apple IIe/IIc/II+ Compatible  
Virtually ALL the conversions you will ever need!

**UNIVERSAL UNCHANGING PRECISE**

Feet to metres, kilowatts to horsepower, light years to angstroms and 3,561 MORE!

TO ORDER: see your local software dealer or call toll free 24 hours a day 1-800-356-5324 (ext 1328) WI or outside USA: 608-257-6648 VISA, MasterCard, or C.O.D. Welcome  
ALL ORDERS SHIPPED WITHIN 48 HRS. OF RECEIPT SHIPPING PAID BY ICI FOR USA ORDERS

Outside USA: add \$10.00 shipping and handling, pay in U.S. dollars (No C.O.D.)

**ICI** INTERNATIONAL COMPUTING, INC.  
1501 Monroe, Madison, WI 53711 USA  
The Quiet Star in Software

Inquiry 174

**GET FREE SOFTWARE FROM THE PUBLIC DOMAIN**

The widest selection from the best distributor! Business utilities and more for most any computer for only the copy charge!

|                              | Library | Rent | Buy |
|------------------------------|---------|------|-----|
| BEST OF NMPC 320 Diskettes   | 250     | 500  |     |
| IBMPC-BLUE 228 Diskettes     | 225     | 450  |     |
| AUTHORS SHOWCASE 35 Disks    | 35      | 105  |     |
| CAPLOT PC-516 45 Disks       | 50      | 105  |     |
| SIG/MS-UB 270 Diskettes      | 175     | 330  |     |
| KAYPRO US 74 Diskettes       | 80      | 215  |     |
| AMIGA 25 Disks               | 25      | 100  |     |
| ATARI-ST 25 Disks            | 25      | 100  |     |
| COMMODORE C-64 100 Diskettes | 105     | 150  |     |

Public Domain User Group Catalog Desk \$5 pp Send your check & specify computer format. Rental is for 7 days after receipt, 3 days grace to return Use credit card, no disk deposit. Shipping, handling & insurance \$9.50 per library (619) 841-0925 Orders & Technical (9 to 5) (619) 727-1015 24 Hr. J Min. Info Recording Have your credit card ready!

**National Public Domain Software**  
1533 Avohill Dr. Vista, CA 92084  
1-800-621-5640 wait for tone dial 782542



BBB



AMEX

Inquiry 249



# COMPUTERBANC

## DRIVES

20 MB Seagate drive .....\$439  
 30 MB drive for AT .....\$655  
 360 K Floppy for AT .....\$110  
 Teac 55B .....\$109  
 20MB Hard Card .....CALL

## IBM COMPATIBLE HARDWARE

Multifunction card 384K, S. P. CLK .....\$139  
 AT Multifunction card OK-3MB .....\$169  
 MONOCROME graphics card .....\$99  
 Color Graphics card .....\$89  
 ComBo CARD ser, par, clock .....\$69  
 EXPANSION CHASIS 7 slots .....\$569

## TAPE DRIVES

10 MB Irwin .....\$379  
 20 MB Irwin .....\$429  
 Everex Stream 20 .....\$569  
 Everex Stream 60 .....\$899  
 Peachtree .....CALL

## SYSTEMS

**COMPAQ 286, 20MB**  
 Portable, 512K, DOS  
**\$3999**

**COMPAQ Deskpro 20MB**  
 Seagate, 640K, Monitor, DDS  
**\$2349**

**SPERRY IT 44MB .....CALL**  
**LEADING EDGE .....CALL**

**IBM AT COMPATIBLE**  
 8MHZ, 512K, 20meg  
 Monitor, graphics, ser, par  
**\$2189**

**IBM XT COMPATIBLE**  
 256K, 20 meg, Monitor  
 graphics, ser, par  
**\$1099**

**IBM AT 30MB .....\$3769**  
 6MHZ, 512K, Seagate 40MS

**IBM XT 20MB .....\$2399**  
 Seagate, 256K, DOS, Monitor

**LASER 128(IIC Compatible) ....CALL**  
**LOCAL AREA NETWORK .....CALL**

## IBM SOFTWARE

LOTUS 123 .....CALL  
 Symphony .....CALL  
 ENABLE .....359.00  
 V P Planner .....59.00  
 ASHTON TATE Framework .....CALL  
 dBASE II .....279.00  
 dBASE III Plus .....CALL  
 POWERBASE .....CALL  
 CLIPPER dBASE III Compiler .....355.00  
 LATTICE C COMPILER .....249.00  
 MULTIMATE .....225.00  
 MULTIMATE ADVANTAGE .....269.00  
 SORCIM SUPERCALC III .....199.00  
 MICROSOFT Multiplan Word .....119.00  
 Windows .....65.00  
 Project .....239.00  
 FOX & GELLER Quickcode .....149.00  
 BORLAND TURBO PASCAL .....42.00  
 REFLEX .....59.00  
 LIGHTENING .....59.00  
 SUPERKEY .....41.00  
 SIDKICK (unprotected) .....50.00  
 ASCII PRO Comm Software .....55.00  
 CROSSTALK XVI .....99.00  
 MIRROR Comm Software .....49.00  
 PEACHTREE Back to Basics .....139.00  
 BPI GENERAL ACCOUNTING .....299.00  
 OPEN SYSTEMS .....CALL  
 REALWORLD .....CALL  
 ONE-WRITE PLUS .....149.00  
 ACCOUNTING PARTNER .....199.00  
 MONOGRAM DOLLARS & SENSE .....99.00  
 TOBIAS MANAGING YOUR MONEY .....99.00  
 SATELLITE WORD PERFECT .....225.00  
 MICROPRO WordStar PRO .....249.00  
 WordStar 2000 PLUS .....285.00

SAMNA WORD III .....279.00  
 RBASE 5000 .....359.00  
 PRINTMASTER .....35.00  
 BREAKTHROUGH TIMELINE .....255.00  
 DECISION RESOURCES CHRTMASTER .....219.00  
 ENERGRAPHICS w/pictor ept .....207.00  
 FUNK SIDEWAYS .....36.00  
 LIFETREE VOLKSWRITER DELUXE .....149.00  
 HARVARD TTL PROJECT MNGR .....285.00  
 THINKTANK .....110.00

## IBM HARDWARE

AST 6 Pack Plus w/384k .....215.00  
 6 Pack Premium .....CALL  
 RAMPAGE .....CALL  
 STB Companion PC 0 2 MB LIMS .....189.00  
 Chauffeur monographics .....229.00  
 EGA + Plus Color Board .....279.00  
 JRAM 3 .....185.00  
 JRAM AT3 .....235.00  
 HERCULES Mono Graphics Color Card .....199.00  
 ORCHID Tiny Turbo .....CALL  
 Turbo 286E W/1 Meg Turbo EGA .....775.00  
 QUADRAM EGA + .....CALL  
 QuadPerf for AT ser & par .....379.00  
 PARADISE Modular Graphics Card .....125.00  
 130 WAT Power Supply .....79.00  
 TALLGRASS W/Tape .....CALL  
 MOUNTAIN .....CALL  
 ALLOY .....CALL  
 Graphics Edge Card .....239.00  
 MOUSE SYSTEMS Mouse .....119.00  
 MICROSOFT Mouse w/sftwr .....117.00  
 KOALA KAT .....137.00

## MODEMS

ANCHOR Express 300/1200 .....199.00  
 Velkmodem 1200 (5 yr wrnty) .....118.00  
 EXPRESS I 300/1200 .....149.00  
 Lightning 2400 Baud .....CALL  
 HAYES 1200 .....309.00  
 2400B .....349.00  
 PROMETHEUS 1200 .....CALL  
 Promodem 1200B .....259.00  
 Promodem 1200A .....205.00  
 Promodem 300 IIC .....189.00  
 Promodem 2400 .....79.00  
 379.00

## MONITORS

AMDEK 300A .....139.00  
 310A Hi-Res Amber .....149.00  
 Color 600 .....369.00  
 Color 722 RGB 720 X 350 .....CALL  
 PRINCETON GRAPHICS HX-12 .....399.00  
 HX-12E RGB 720X350 .....489.00  
 SR-12 .....CALL  
 MAX-12 .....149.00  
 TAXAM: ALL MODELS .....CALL  
 PANASONIC .....CALL  
 DT-H103 10" High Res RGB .....359.00  
 IBM COMPATIBLE Monochrome .....99.00  
 Color RGB Monitor (640X200) .....279.00

## PRINTERS

PANASONIC (2 yr warranty) .....199.00  
 KX-P1080 .....229.99  
 KX-P1091 .....229.99  
 KX-P1092 .....305.00  
 KX-P1592 .....425.00  
 KX-P1595 240 CPS .....CALL  
 KX-P3131 17cps Daisey .....249.00  
 KX-P3151 22 cps Daisey .....385.00

Citizen MSP-10 .....275.00  
 MSP-15 .....389.00  
 MSP-25 .....CALL  
 STAR MICRONICS .....CALL  
 EPSON LX-80 .....CaM  
 FX-286 .....for  
 LQ-800 .....Best  
 LQ-1000 .....Prices  
 BROTHER-1509 .....389.00  
 OKIDATA - All Models .....Call  
 TOSHIBA All Models .....CALL  
 CANNON Laser Printer .....1,899.00  
 HEWLETT PACKARD LASER .....2,199.00  
 HOUSTON INSTRUMENTS Plotters .....CALL  
 Digitizers .....CALL

## APPLE PRODUCTS

APPLE Compatible Drive IIC .....99.00  
 IIC compatible drive .....CALL  
 MAC Compatible 3 1/2 drive .....CALL  
 MICROSOFT Softcard II .....299.00  
 ASCII XPRESS (Communications) .....65.00  
 APPLEWORKS .....215.00  
 SPELLWORKS .....49.00  
 PRINT SHOP .....35.00  
 Mach III Joystick .....35.00  
 SYSTEM SAVER Fan .....69.00  
 VIDEO 7 IIC Enhancer .....CALL  
 VIDEO Ultraterm .....159.00  
 APRICORN (Lifetime Warranty)  
 Super Serial Imager .....75.00  
 Graphics Interface .....65.00  
 80 Column/64K .....75.00  
 EXTEND IT 64K .....55.00  
 KOALA SpeedKey .....99.00

Call for catalog. Thousands of products available. Volume discounts.



# COMPUTERBANC

16783 Beach Blvd., Huntington Beach, CA 92647



For Customer Service Call 714-847-BANC



Orders Only

## 800/332-BANC

OUTSIDE CALIFORNIA

## 714/841-6160

Cash prices indicated. All products are in factory sealed packages. We guarantee all items for 30 days. Within this period, defective merchandise returns must be accompanied by RMA number. All other returns will be subject to a 10% restocking fee. For prepaid orders, there will be a 3% shipping charge; 5% for UPS Blue Label; \$5.00 minimum; all orders outside U.S.A. at 15% shipping. California residents add 6% sales tax. Prices subject to change without notice.

© Copyright 1985 COMPUTERBANC, All Rights Reserved.

## Scan-tastic! BARCODE READER

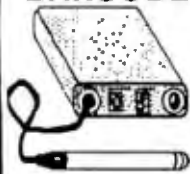

# \$477

Includes \$99  
label printing  
program FREE!

Works with DBASE II/III  
LOTUS 123 & others right  
out of the box!! Reads UPC  
3 of 9, 2 of 5 into PC, XT &  
compatibles - no slots.

216-273-5039  
DEVSOFT INC.  
21010 Center Ridge  
Cleveland, Oh 44116

Inquiry 106

# \$99

## HARD DISK CONTROLLER

### New Shugart Model 1610 5 1/4" Hard Disk Controllers

#### EMULATES

- XEBEC S1410 (1610-3) Full
- DTC 510 (1610-1) 90 day
- SCSI (1610-4) Guarantee

#### WORKS WITH

- Micromint COM 180, SB180
- Wavemat Bullet
- AMPRO All Boards
- Macintosh
- Apple IIe
- ACS 1000
- ISI 5160

Manual  
and  
Schematic  
Only \$8

#### COMPUTER SURPLUS STORE

226 Phelan Avenue  
San Jose, CA 95112  
408-280-1740

Inquiry 83

## COMFORT—

Productivity you can feel!

"The ADJUSTable ...

...adjusts to  
fit YOU!"



INTRO  
SPECIAL!  
\$149 +  
(reg. \$229)

- Clears off your desk
- Unrestricted Legroom
- Adjustable Height, Depth, Tilt
- Fits PC/AT/Portable/Macs
- Exceptional mobility w/optional Casters, \$20
- Also: Adjustable Chairs, Printer Stands, CRT Swing Arms

Reward yourself now! Order by Oct. 31 and  
receive FREE SET OF CASTERS (reg. \$20 value)

ACP

(713) 783-3881

6776 Southwest Freeway • Suite 150 • Houston, Texas • 77074

Inquiry 426

## 9-TRACK MAG. TAPE SUBSYSTEM FOR THE IBM PC/XT/AT



For information interchange, backup and archival storage,  
IBEX offers a 9-track, IBM format-compatible "W" magnetic  
tape subsystem for the IBM PC, XT/AT:

- 42 M-Bytes on a single reel
- IBM format 1900 cpl.
- Software for PC-DOS, MS-DOS.

Write, phone or FAX  
for information

IBEX

IBEX COMPUTER CORP.  
20741 Marlene St.  
Chatsworth, CA 91311  
(818) 708-8100  
FAX: 818-493-3071

Inquiry 165

## IBM PC/VT220

- EM220 • VT220, VT102 emulation  
\$149 • File Transfer  
• 132 Column modes  
• Color Support  
• Hot Key

## TEK 4010/4014

- EM4010 • Tektronix 4010 emulation  
\$249 • VT220, VT102 emulation  
• Picture files  
• High resolution hardcopy  
• Supports IBM, IBM Enhanced,  
Hercules, Tecmar and AT&T.



Diversified Computer  
Systems, Inc.

3775 Iris Ave., Suite 1B  
Boulder, CO 80301  
(303) 447-9251  
Telex 9103800693 DCSINC

Trademarks: VT100 — Digital Equipment; IBM PC, XT — IBM Corp.

Inquiry 113

## RAMS

|                    |        |      |
|--------------------|--------|------|
| 256K (256K x 1)    | 150 ns | 2.75 |
| 256K (256K x 1)    | 120 ns | 3.25 |
| 256K (64K x 4)     | 150 ns | 4.25 |
| 128K (128K x 1)    | 150 ns | 4.40 |
| 64K (64K x 1)      | 150 ns | 1.20 |
| 64K (64K x 1)      | 120 ns | 1.35 |
| 6264LP-15 (8K x 8) | 150 ns | 3.15 |

## EPROMS

|                 |        |      |
|-----------------|--------|------|
| 2732A (4K x 8)  | 150 ns | 4.05 |
| 2764 (8K x 8)   | 250 ns | 3.35 |
| 2764 (8K x 8)   | 200 ns | 3.75 |
| 27C64 (8K x 8)  | 200 ns | 5.05 |
| 27128 (16K x 8) | 250 ns | 3.65 |
| 27256 (32K x 8) | 250 ns | 5.25 |
| 27256 (32K x 8) | 200 ns | 5.65 |

## PROCESSORS

|         |      |        |
|---------|------|--------|
| C8087-2 | 8mHz | 150.00 |
| C8087   | 5mHz | 125.00 |
| V-20    | 8mHz | 14.00  |
| V-30    | 8mHz | 16.00  |

## MicroTech

(206) 364-2209, 8 - 6 Mon.-Sat.  
P.O. Box 27083, Seattle, WA 98125

Prices shown for cash. Prices subject to change. Call for current  
prices & volume discounts. Shipping & Handling: UPS ground  
\$2.00, air \$5.00 (under 1 lb.) Master Card/Visa add 3%. Wash  
residents add 7.9% sales tax. Satisfaction guaranteed.

Inquiry 239

## BULK DISKETTES MAXELL

# 5 1/4 DS/DD 59¢

Price based on quantity of 250  
Includes sleeves, labels and tabs

Quantities Limited Call Today!

## 800-222-0490

(In N.J. 201-462-7628)

Full service duplication facility  
24 Hour Shipment

# MEGAsoft

P.O. Box 710

Freehold, N.J. 07728

## Data Shade Lenses



Non-prescription Data-shade  
lenses reduce glare, sharpen  
contrast & screen out ultra-  
violet radiation. Choose color  
for maximum contrast with  
specific CRT screen colors.  
Magenta for green screens,  
blue for amber or gray for BW  
screens. In mens or ladies  
styles. \$15.25 plus 75¢ post-  
age and handling.

PRECISION OPTICAL  
Dept. 121-X, Rochelle, IL 61068

Inquiry 274

## CHANGING SYSTEMS? What Happens to Your Data? Does JUST Media Conversion Solve Incompatibilities?

WHAT IF ...

everything is changing, including your software,  
hardware, operating systems and media? What  
happens to your spreadsheet data and formulas,  
database structures and/or word processing  
documents and codes?

What do you do, and what is the cost?

**We Make Incompatible Data Compatible!**

The source can be mainframes, minis, micros,  
dedicated word processors or typesetters.  
ADAPSO member.

CompuData Translators, Inc. 213-462-6222  
6565 Sunset Bl., #301 Hollywood, CA 90028

Inquiry 73

Inquiry 223



# BYTE

# LIMITED EDITION Classics

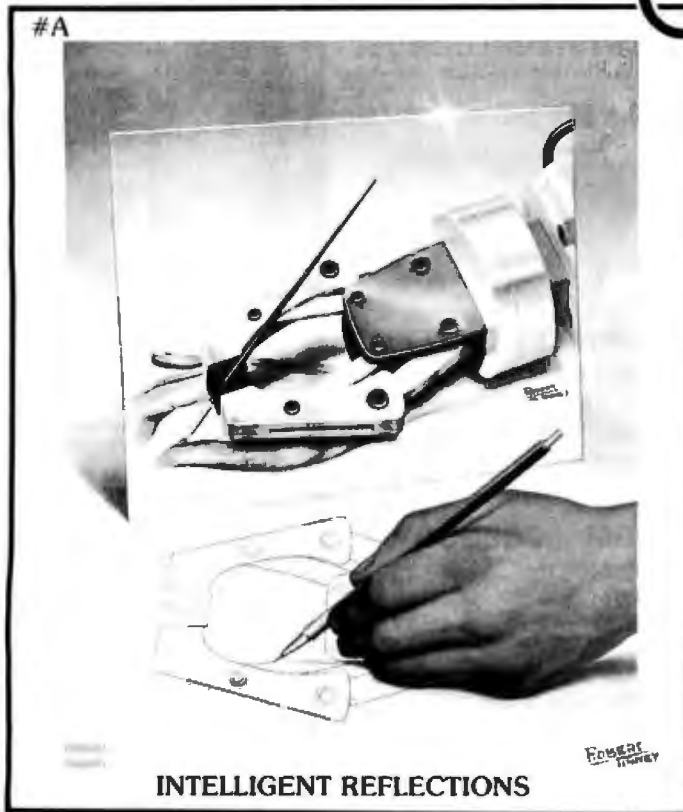

INTELLIGENT REFLECTIONS

Beautiful 16" X 20"  
Limited Edition Prints,  
each signed and numbered  
by the Artist.

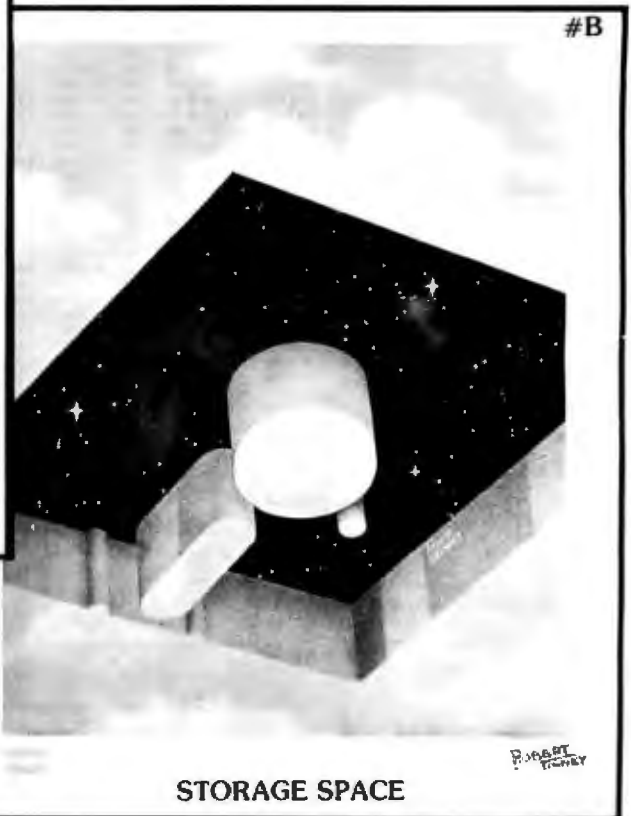

STORAGE SPACE

### Fascinating...And Unique!

The two 1985 Byte covers shown above are now available as 16" X 20" limited edition prints. Each edition is strictly limited to 1000 prints, which are individually inspected, signed and numbered by the artist, Robert Tinney. These excellent reproductions are made from the original paintings (not from transparencies or photos) to ensure accurate color fidelity.

Byte Limited Edition Classics are printed on select 100% cotton fiber stock. This is a museum grade acid free paper, highly resistant to yellowing and cracking; you will be assured of a print which will retain its color and beauty for generations. Accompanying each print is a handsome Certificate of Authenticity, which is also personally signed and numbered by the artist, and which certifies the quality and limited number of the edition.

### Price and Shipping

The price of each Byte Limited Edition Classic is \$55; if two or more prints are ordered, the price of each is only \$45.

Byte Limited Edition Classics are shipped flat, and are guaranteed to arrive undamaged or be immediately replaced. In fact, if for any reason you are not satisfied with your order, you may return it within 30 days for a no questions asked refund. Your prints will be shipped UPS Blue Label (two day delivery), and will usually be shipped within one week of receipt of order.

### Ordering

To order your Byte Limited Edition Classic(s), just clip out and mail the coupon below. If you prefer, you may call in a MasterCard or Visa order to Robert Tinney Graphics, 1-(504)272-7266.

|                                                                                                         |       |       |          |                                                                                                                                                                   |  |                                                                                                               |  |
|---------------------------------------------------------------------------------------------------------|-------|-------|----------|-------------------------------------------------------------------------------------------------------------------------------------------------------------------|--|---------------------------------------------------------------------------------------------------------------|--|
| Send me the following print for \$55 (\$45 each for two or more).                                       |       |       |          | <input type="checkbox"/> I have enclosed check or money order to Robert Tinney Graphics<br><input type="checkbox"/> Please just send me your free color brochure. |  | Mail this coupon to:<br><b>Robert Tinney Graphics</b><br>1864 N. Pamela Drive<br>Baton Rouge, Louisiana 70815 |  |
| Qty.                                                                                                    | #     | Title | Amount   |                                                                                                                                                                   |  |                                                                                                               |  |
| _____                                                                                                   | _____ | _____ | \$ _____ |                                                                                                                                                                   |  |                                                                                                               |  |
| _____                                                                                                   | _____ | _____ | \$ _____ |                                                                                                                                                                   |  |                                                                                                               |  |
| postage & handling \$4 (\$10 overseas)                                                                  |       |       | \$ _____ |                                                                                                                                                                   |  |                                                                                                               |  |
| <b>Total \$</b>                                                                                         |       |       | _____    |                                                                                                                                                                   |  |                                                                                                               |  |
| <b>Bill my</b> <input type="checkbox"/> Visa or <input type="checkbox"/> Mastercharge: Exp. Date: _____ |       |       |          | <b>Ship To:</b><br>Name: _____<br>Address: _____<br>City: _____<br>State: _____ Zip: _____                                                                        |  |                                                                                                               |  |
| Card No. _____                                                                                          |       |       |          | Visa or MasterCard orders<br><b>CALL 1-504-272-7266</b>                                                                                                           |  |                                                                                                               |  |





# UNFAIR ADVANTAGE

Advanced 286 \$1495<sup>00</sup>  
Advanced PC/XT \$699<sup>00</sup>



20 Mb Upgrade **\$449** 20 Mb Mega card **\$479**  
Package (1 Yr War) Plug-in 1 Yr War)

**SEAGATE FOR AT**  
(Linear Voice Coil Activator)  
20 Mb for AT ..... **\$499.00**  
30Mb for AT ..... **\$599.00**  
40Mb for AT ..... **\$799.00**  
(Inc. Cable & Mounting Rails)

**Advanced PC/XT**

- FCC/UL Approved
- IBM PC/XT™ Compatible
- (1) 360K Floppy
- 256K Expandable to 640K
- Serial, Parallel, LCD
- RGB Color Graphics
- Composite Video
- Mouse & Keyboard
- 10Mb Hard Disk (Add \$200.00)

**HARDWARE**

Advanced Cards  
Largest Selection!

|                                       |         |
|---------------------------------------|---------|
| A210 Color/Printer/Graphics           | \$98.00 |
| A220 Color/Graphics/Video/Mouse       | 95.00   |
| A230 Mono/Color/Graphics/132 Col.     | 140.00  |
| A231 Color/Mono (Runs 2 Monitors)     | 140.00  |
| A240 Mono/Printer Graphics            | 79.00   |
| A250 Mono/Printer/Graphics/132 Col.   | 110.00  |
| A260 Mono/Printer                     | 75.00   |
| A271 EGA/256K RAM - Short Card        | 239.00  |
| A320 384 Multi-function Card - OK     | 99.00   |
| A330 Multi-function - Short Card      | 99.00   |
| A340 Multi-function/Floppy            | 119.00  |
| A350 640K RAM Card - OK               | 59.00   |
| A410 Floppy Card - 2 Drives           | 39.00   |
| A420 Floppy Card - 4 Drives           | 49.00   |
| A510 Parallel/Serial, Optional Serial | 89.00   |
| A520 Parallel Card                    | 35.00   |
| A530 Serial Card                      | 49.00   |
| A610 AT 2Mb Multi-function - OK       | 139.00  |
| A612 AT 2.5Mb RAM Card                | 139.00  |
| A620 AT 3Mb RAM Card                  | 159.00  |
| A630 AT Parallel/Serial, Optional Ser | 59.00   |
| A640 AT Floppy/Hard Controller        | 249.00  |
| A650 AT I/O Card - Ser/Par/Clk        | 85.00   |
| A650 AT Motherboard - OK              | 529.00  |
| A655 XT Motherboard - OK              | 119.00  |
| A660 XT Turbo Motherboard - OK        | 139.00  |

**AST - (1 to 2 Year Warranty)**

AST525-11 ..... **\$575.00**  
AST525-12 ..... **575.00**  
RAMpage Expandable to 2Mb ..... Call  
RAMpage AT Expandable to 2Mb ..... Call  
(Both boards support EMS & EEMS)  
Advantage 128K ..... **385.00**

**AST SPECIALS**  
REDUCED TO MOVE LIMITED SUPPLY

SixPak Plus w/64K ..... Only **\$166.00**  
Including Sidekick 1.5 & DESKView

SixPak Plus 384K ..... Only **219.00**  
Combo Plus - OK ..... Only **86.00**  
Combo Plus - 64K ..... Only **79.00**  
(Makes superior I/O Device)

Reach Modem 1200 Baud ..... **199.00**  
AST Colorgraphics Card ..... **99.00**  
(Original Factory Box)

**HAYES - (2 Year Warranty)**  
Smartmodem 1200 ..... **\$385.00**

**HARDWARE**

|                             |        |
|-----------------------------|--------|
| Smartmodem 1200B            | 349.00 |
| Smartmodem 2400 (Int)       | 575.00 |
| Smartmodem 2400B            | 535.00 |
| Hayes Comp. 1200 (Ext)      | 169.95 |
| Hayes Comp. 1200 (Int) w/SW | 149.95 |
| Hayes Comp. 2400 (Ext)      | 349.00 |

**HERCULES**  
Hercules Color Card ..... **\$166.00**  
Hercules Plus Graphics ..... **NEW 239.00**

**INTEL - (5 Year Warranty)**  
Above Board PC, AT, PS ..... **New Price**  
FREE OFFER Windows thru 12-31  
8087 or 80287 thru 9-30

**KEYTRONICS**  
5150 Keyboard ..... **\$169.95**  
5151 Deluxe Keyboard ..... **169.95**  
5153 w/Touchpad ..... **285.00**  
PC Jr Numeric Keypad ..... **29.95**

**MICROSOFT**  
Microsoft Mouse ..... **\$139.99**  
Microsoft Bus Version ..... **155.00**

**MOUSE SYSTEMS - (3 Year War.)**  
PC Mouse w/Paint Plus ..... **\$139.00**  
PC Mouse w/Ready & Paint ..... **149.00**  
ACP Mouse w/Keyboard ..... **SALE 149.00**

**PROMETHEUS - (1 Yr Warranty)**  
ProModem 1200 w/Mite (Int) ..... **\$299.00**  
ProModem 1200B ..... **259.00**  
Alphanumeric/Options Processor ..... **79.00**

**TECMAR CLOSEOUTS**

|                   |       |              |
|-------------------|-------|--------------|
| SpeechMaster      | \$395 | ACP \$195.00 |
| 1st Mate w/64K    | 399   | 169.00       |
| Voice Recognition | 995   | 159.00       |
| 3rd Mate          | 445   | 195.00       |
| Powerlink 3270    | 1099  | 399.00       |
| Phonagate 2400    | 695   | 295.00       |

Call for Complete List

**PRINTERS**

**BROTHER**  
M1108 Dot Matrix ..... **\$249.00**  
M1509 Dot Matrix ..... **399.00**

**DIABLO/XEROX**  
620 Serial LDP ..... was 1495 now **\$299.00**  
620 API LDP ..... **349.00**  
620 D36 (36cps) ..... **399.00**  
Tractor ..... was 395 now **\$25.00**  
F-21 Sheet Feeder ..... was 896 now **199.00**  
630 Sheet Feeder ..... **219.00**  
Cable for 620 (to IBM) ..... **29.00**  
Diablo P-11 or S-11 100cps ..... **129.95**  
Diablo P-31 or S-31 Wide ..... **199.95**

**EPSON - (1 Year Warranty)**  
FX85 180cps NLD ..... **\$375.00**  
FX286 160cps Wide ..... **549.00**

**TOSHIBA**  
P321 "3 in 1" LD Printer ..... sale **\$515.00**  
P351 24 Pin w/Serial & Parallel ..... **1065.00**  
New Toshiba Color Printer ..... Call

**B PEN PLOTTER - Limited Special**  
Roland's DRY-80 Flatbed X-Y Plotter.  
Formerly sold for \$995.00. While Supply  
lasts your price only **\$399.00**  
Inc. Parallel/Serial Interface. IBM Compatible.

**MONITORS**

|                          |         |
|--------------------------|---------|
| Samsung TTL IBM Green    | \$89.00 |
| Samsung TTL IBM Amber    | 99.00   |
| ACP 12" Software TTL IBM | 139.00  |
| Mitsubishi RGB Color     | 259.00  |
| TECA EGA Monitor         | 419.00  |

**PRINCETON GRAPHICS**  
HX-12 RGB (640x240) ..... **\$445.00**  
MAX-12E Amber TTL ..... **175.00**  
SR-12 ..... **575.00**  
HX-12E (690x350) ..... **545.00**

**Advanced 286**

- FCC/UL Approved
- IBM AT™ Compatible
- 6/8 MHz SW Switchable
- 640K, 200 Watts
- 1.2 Mb Floppy Controller
- Hard/Floppy Controller
- Phoenix BIOS
- MS-DOS 3.2 (Add \$85.00)
- GW Basic (Add \$95.00)
- 30Mb 35mS HD (Add \$700)

**EGA SPECIALS!**  
EGA UPGRADE KIT

Includes:  
NEC Multisync  
ACPIEGA Card **\$71900**

|                                |          |
|--------------------------------|----------|
| NEC Multisync                  | \$499.00 |
| ACP RGB Color                  | 369.00   |
| RIX EGA Paint                  | 59.99    |
| Paradise Autoswitch            | 359.00   |
| Genoa EGA                      | 299.00   |
| Orchid Turbo EGA               | 585.00   |
| Quad EGA Plus                  | 365.00   |
| Advanced EGA, 256K, Short Card | 365.00   |
| EGA Mouse                      | 119.00   |

**PGA SPECIALS**  
IBM Professional, Limited Quality  
IBM PGA Card, Regular \$2995. Sale **995.00**  
IBM PGA Monitor, Reg \$995. Sale **695.00**

**HARD DISK CARDS**  
20Mb MEGA Card ..... **\$479.00**  
20Mb Mountain Card ..... **599.00**  
Call for 30Mb Card

**BEST BACK-UP**  
Use same back-up device we use at ACP.  
AlphaMicro VCR Back-up Card ..... **\$399.00**  
AlphaMicro VCR ..... **699.00**  
NOTE: Works on any VCR.

**DISK DRIVES**

|                                       |          |
|---------------------------------------|----------|
| Toshiba FDD4403 3 1/2" w/5 1/4" Bezel | \$129.00 |
| Toshiba HD040 PC, XT 360K             | 105.00   |
| Toshiba HD04E-G AT, 360K              | 115.00   |
| Toshiba ND08DE-G 1.2Mb                | 149.00   |
| TEAC FD-558                           | 105.00   |

**DISKETTES (Box of 10)**

|                               |         |
|-------------------------------|---------|
| DS/DD for PC/XT (40tp)        | \$6.00  |
| • ACP Generic                 | 16.00   |
| • Verbatim DataLife           | 16.00   |
| • Maxell MD-2                 | 19.00   |
| • Fuji                        | 16.00   |
| DS/HD-Density for AT (96tp)   | \$32.00 |
| • Verbatim                    | 35.00   |
| • Maxell                      | 26.00   |
| • Fuji                        | 26.00   |
| SS/DD for Apple II etc.       | \$6.00  |
| • ACP Floppy (Use both sides) | 14.00   |
| • Verbatim                    | 17.00   |
| • Maxell MD-1                 | 14.00   |
| • Fuji                        | 14.00   |
| Macintosh/IBM Conv. 3 1/2"    | \$52.00 |
| • Maxell MF-2DD               | 52.00   |
| Fuji MF-2DD (135tp)           | \$14.00 |
| Flip-Sort (75 Disks)          | 9.00    |
| ACP 5 1/4" Disk Holder        | 12.00   |
| ACP 3 1/2" Disk Holder        | 9.00    |
| Head Cleaner 5 1/4" or 8"     | 29.00   |
| Perfect Computercare Kit      | 29.00   |

**IRWIN TAPE BACK-UP**  
for AT **\$399.00**

**PC UPGRADE SPECIAL**

**\$1495** SET OF (9) 64K RAMS  
**\$3695** SET OF (9) 256K RAMS  
**\$13995** 8087 COPROCESSOR  
**\$16995** 8087-2 COPROCESSOR  
**\$22500** 80287 - 6-8 Mhz  
**\$26900** 80287-8 - 10 Mhz

**1200 Baud Hayes™ Comp. Modem**  
Short Card with Software.  
List \$299 ..... ACP **\$14995**  
1200 XT/AT (Ext.) ..... **\$16995**

**10Mb HARD DISK**  
**\$189.00**

**SYSGEN 20/20**

- 20Mb Hard Disk
- 20Mb Tape Back-up
- New/Factory Box
- PC/XT/AT Comp.
- External Complete Reg. Retail \$3300

ACP Only **\$888**

**Grid Compass MS-DOS Lap**  
**Computer Demo Sale Call for**  
Details. 100's in  
Stock as Low as **\$849<sup>00</sup>**

**SEAGATE ST225**  
20Mb Hard Disk **\$349.95**

**MS-DOS LAPTOP**  
**Sharp PC5000**  
Formerly sold for \$1995.  
2800 in stock new in  
box w/factory warranty!  
Vol. discounts available!

**ACP SUPER LOW PRICE \$395<sup>00</sup>**

|                     |         |               |        |
|---------------------|---------|---------------|--------|
| 128K Bubble         | \$79.00 | Supercorn     | 59.00  |
| Printer             | 150.00  | Superwriter   | 89.00  |
| Wordstar            | 129.00  | Color Plotter | 149.00 |
| Modem 300 Baud      |         |               | 99.00  |
| PFS File/Report     |         |               | 129.00 |
| Soft Carry Case     |         |               | 19.00  |
| Soft Key Plotter SW |         |               | 35.00  |

**SEAGATE ST4038-30Mb**  
Hi-Speed, 40 mS, AT  
Compatible Drive **\$599.00**

## ★ Advanced Computer Products Inc.

**TOLL FREE 800-854-8230**  
CA Residents 714-558-8813

**OUR POLICY**  
•No Surcharge for VISA or Mastercard. Inquiry 8  
•Volume purchasing agreements available.  
•Orders subject to availability. •Supply limited on certain items.  
•Pricing subject to change without notice.  
•ACP Retail Store pricing may vary. Not responsible for typos.

Mail Order: P.O. Box 17329 Irvine, CA 92713  
Retail: 1310 B E. Edinger, Santa Ana, CA 92705

**CORPORATE BUYERS - CALL**  
GILLES, LOUANE, MANDI, MIKE or DAVE



# Worldwide • Since 1974

• QUALITY COMPONENTS • COMPETITIVE PRICING  
• PROMPT DELIVERY

Mail Order Electronics - Worldwide  
**Jameco**  
ELECTRONICS

## COMMODORE COMPATIBLE ACCESSORIES

**Now Compatible With C-128!**  
RS232 Adapter for VIC-20, C-64 and C-128

The JE232CM allows connection of standard serial RS232 printers, modems, etc. to your VIC-20, C-64 (excluding the SX-64 Portable), and C-128. A 4-pole switch allows the inversion of the 4 control lines. Complete installation and operation instructions included.

• Plugs into User Port • Provides Standard RS232 signal levels  
• Uses 6 signals (Transmit, Receive, Clear to Send, Request to Send, Data Terminal Ready, Data Set Ready)

**JE232CM** . . . . . \$39.95

**Voice Synthesizer VIC-20 & C-64**  
Plug-In - Talking in Minutes!  
**JE520CM** . . . . . \$99.95

**300 Baud Auto Modem**  
**Mitey-Mo** (For C-64) . . . . . \$54.95

**Parallel Printer Interface**  
2K Buffer, Expandable to 10K!  
**MW350** (For VIC-20, C-64 & C-128) . . . . . \$54.95

## TRS-80 COMPATIBLE ACCESSORIES

**E-X-P-A-N-D TRS-80 MEMORY**  
All kits come complete with documentation

**TRS-80 MODEL I, III**

**TRS-18K3 200ns (Model III)** . . . . . \$5.95  
**TRS-18K4 250ns (Model I)** . . . . . \$5.49

**TRS-80 COLOR AND COLOR II**

**TRS-64K-2** . . . . . \$11.95  
New models only

**TRS-CoCo** - incl. 2-50464's (41464's) . . . \$12.49

**TRS-80 MODEL 4, 4P**

**TRS-64K-2** . . . . . \$11.95  
Expands Model 4 from 16K-64K or Model 4P from 64K-128K

**TRS-64K-2PAL** . . . . . \$29.95  
Expands Model 4 from 64K to 128K

**TRS-80 Model 100 - NEC - Olivetti**

**M100BK** . . . . . \$24.95 ea. or 3 for \$59.95  
TRS-80 Model 100 Expansion

**NEC08K** . . . . . \$24.95 ea. or 3 for \$59.95  
NEC Model PC-8201A Expansion

**OM100K** . . . . . \$24.95 ea. or 3 for \$59.95  
Olivetti Model M10 Expansion

**TANDY 200**

**M200R** . . . . . \$74.95 ea. or 2 for \$129.95  
Tandy Model 200 Expansion

## UV-EPROM ERASER

Erases all EPROMs. Erases up to 8 chips within 21 minutes (1 chip in 15 minutes). Maintains constant exposure distance of 1". Special conductive beam liner eliminates static build-up. Built-in safety lock to prevent UV exposure. Compact - 9.00" L x 3.70" W x 2.60" H. Complete with holding tray for 8 chips.

**DE-4 UV-EPROM Eraser** . . . . . \$74.95

**UVS-11EL Replacement Bulb** . . . . . \$17.95

## DATA BOOKS

30003 National Linear Data Book (82) . . . . . \$14.95  
30009 Internal Data Book (85) . . . . . \$ 9.95  
30013 Zilog Data Book (85) . . . . . \$14.95  
30032 National Linear Supplement (84) . . . . . \$ 6.95  
210830 Intel Memory Handbook (86) . . . . . \$17.95  
230843 Intel Microsystem Hndbk. Set (86) . . . . . \$24.95

## MUFFIN/SPRITE-STYLE FANS

**MUF80 (8043-15-3482)** . . . . . \$9.95  
Howard Industries (4 68" sq., 60 cfm)  
**SU2C7** . . . . . \$9.95  
EG4G Rotron (3 125" square, 20 cfm)

## NEW PRODUCTS!

### DISK DRIVE SALE!

**MP152S** Double-sided 48TPI. . . IBM PC/XT Compatible! . . . \$89.95  
**TM100-4** Double-sided 96TPI. . . QUAD Drive! . . . . . \$59.95

### ZUCKERBOARD

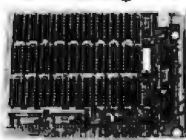

**Expansion Memory Half-Card for IBM-PC, XT, Portable, Tandy 1200 and Compatible Computers**

Expand your computer to its full capacity of 640K. It will accept either 64K memory chips (4164) or 256K memory chips (41256)

**EM-100** Expansion Memory Half Card with 64K RAM . . . \$59.95

**EM-D** RAM Disk and Printer Spooler Software. . . . \$39.95

### ZUCKERBOARD

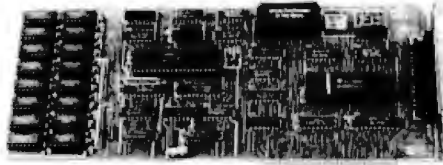

**Multifunction Board with Clock Calendar for the Tandy 1000**  
The Zuckerboard Multifunction Board allows you to expand the memory on your Tandy 1000 to as much as 640K. The Multifunction Board comes complete with an RS232 port for your serial expansion needs, a clock/calendar and RAM Disk Printer Spooler. The Zuckerboard Multifunction Board is made in the U.S.A. and comes with a standard 2 year warranty.

**MTAN-256K** Includes 256K RAM and Manual. . . . . \$199.95

**MTAN-512K** Includes 512K RAM and Manual. . . . . \$239.95

### Expansion Memory Half-Card and Clock/Calendar for the Tandy 1000 - DMA Controller Chip on board!

**TAN-EM256K** Includes 256K RAM and Manual. . . . . \$ 99.95

**TAN-EM512K** Includes 512K RAM and Manual. . . . . \$139.95

### Options for TAN-EM256K/512K

**TAN-C** Includes Plug-in Clock Option Chip (only). . . . . \$39.95

**TAN-D** Includes RAM Disk Spooler Software (only). . . . . \$39.95

**3.5" Micro Floppy Disk Drive for Tandy 100 & 200, NEC8201A, IBM PC, XT, AT and Compatible Computers**

Now your IBM PC or compatible can read and write the same disks as your portable!

**FD-103** Includes 3.5" Disk Drive, Cable, AC Adapter, Blank Diskette and Documentation. . . . \$179.95

**Software for the FD-103 Disk Drive (Software needed for operation)**

**T81** Tandy 100 TSDOS Disk Operating System Software. . . . . \$49.95

**T82** Tandy 200 TSDOS Disk Operating System Software. . . . . \$49.95

**T8N** NEC PC8201A Disk Operating System Software. . . . . \$49.95

**LAPDOS** IBM PC, XT, AT and Compatible LAPDOS Disk Operating System Software. . . . . \$79.95

**13" Color Composite Monitor for VIC-20 and C-64**  
Also compatible with other computers with composite output (i.e. Apple II, II+, IIe)  
Ideal for color graphics and games  
• Resolution: 260H x 300V • Recommended Display Character Number: 960 Characters (40 Characters x 24 Rows on 5x7 Dot Matrix)  
• CRT: 13" diagonal • Size: 14 6/8" W x 13 5/8" x 15 5/8" • Weight: 25.3 lbs.  
**CMON** . . . . . \$129.95 each or 2/\$219.95

**RCA-3-DIN** (Universal Computer to Monitor Cables for Atari, Commodore & TI) . . . \$3.49

## IBM COMPATIBLE ACCESSORIES

### 83-KEY KEYBOARD



• Identical layout as original IBM PC Keyboard • Highly desirable case with palm rest • Complete with cable and data  
• JUST PLUG IN!

**KB83** . . . . . **SALE** . . . . . \$29.95

### Build an IBM PC/XT Compatible!

**IBM-64K(2)** 64K RAM Chips (16) . . . . . \$ 24.98

**KB-83** 83-Key Keyboard. . . . . \$ 29.95

**IBM-FCC** Floppy Controller Card. . . . . \$ 49.95

**IBM-Case** Case. . . . . \$ 49.95

**IBM-MCC** Monochrome Card. . . . . \$ 79.95

**IBM-PS** Power Supply. . . . . \$ 79.95

**FD55B** Disk Drive. . . . . \$119.95

**IBM-MON** Monochrome Monitor. . . . . \$ 99.95

**IBM-MB** Motherboard. . . . . \$139.95

Regular List \$674.58

**IBM Special** (Incl 9 items above) . . . \$599.95

### Additional Add-Ons Available!

**IBM-KB** 83-Key Keyboard. . . . . \$ 69.95

**IBM-ENH** Enhanced Keyboard. . . . . \$ 99.95

**IBM-ICB** Integrated Color Board . . . . . \$ 99.95

**IBM-EGA** Enh. Graphics 256K RAM . . . \$299.95

**IBM-20MBK** 20MB Hard Disk Drive. . . . \$499.95

IBM is a registered trademark of IBM Computers



The **UBUFFER** Universal Printer Buffer is a hi-speed data buffer that accepts data at a high rate, and then outputs this data to your printer. You save valuable computer time. The **UBUFFER** can be connected to practically any computer or printer. There are four possible combinations: 1) Serial to Serial, 2) Serial to Parallel, 3) Parallel to Parallel, 4) Parallel to Serial. Manual included. Size 9-1/32" L x 4" W x 1 1/2" H.

**UBUFFER-64K** . . . \$199.95

**UBUFFER-256K** . . \$229.95



**FD55B** 5 1/4" DS II-Height. . . . . \$119.95

**SA455** 5 1/4" DS II-Height. . . . . \$119.95

**TM100-2** Tandon 5 1/4" DS Full-Height. . . . \$109.95

**JMR 5 1/4" DISK DRIVE ENCLOSURES**  
Complete with power supply switch, power cord, fuseholder and connectors.

**DDE-1FH** Houses 1 Full-Height 5 1/4" Floppy Drive. . . . \$69.95

**DDE-2HH** Houses 2 Half-Height 5 1/4" Floppy Drives - Vertical . . . \$79.95

**HDDE-1FH** Houses 1 Hard Disk Drive . . . . . \$199.95

\$20 Minimum Order - U.S. Funds Only  
Shipping: Add 5% plus \$1.50 Insurance

California Residents: Add 6% or 6 1/2% Sales Tax

Spec. Sheets - 30¢ each  
Prices Subject to Change

Send stamped, self-addressed envelope to receive a Quarterly Sales Flyer - FREE!  
9/86



Send \$1.00 Postage for a FREE 1986 JAMECO CATALOG

©1986 Jameco Electronics

1355 SHOREWAY ROAD, BELMONT, CA 94002 • PHONE ORDERS WELCOME 415-592-8097 Telex: 176043

# California Digital

17700 Figueroa Street • Carson, California 90248

## IBM Compatible Computer



**\$495**

**Eclipse**  
DATA PRODUCTS

- 256K Expandable to 640K on Motherboard
- Double Sided Double Density Disk Drive
- IBM Type Keyboard (with LED indicators)
- Floppy Controller Card
- Eight Expansion Slots
- 135 Watt Power Supply

The Eclipse 16 is an outstanding value in IBM Compatible Computers. After careful research and evaluation we found it to be the most reliable unit.

Our computer includes some of the newest features available, such as the 4.7MHz, multi-layer motherboard with 256K of RAM upgradable on board to 640K. A generous eight expansion slots and 135 Watt power supply give you ample room and power for add-on boards. The enclosure has an easy-access flip top lid making upgrades a breeze. And our floppy controller supports up to four drives, so as many as three additional drives can be used. Finally, each computer is configured and fully tested before sending it to you.

**Satisfaction Guaranteed!** We're really excited about this new unit, and so sure you will be too... that you may return the Eclipse 16 for a full credit towards an IBM PC if you are not completely satisfied.

### OPTIONS

|                                    |       |                                            |     |
|------------------------------------|-------|--------------------------------------------|-----|
| 20MB Hard Drive w/Controller.....  | \$495 | RGB Color Monitor.....                     | 199 |
| Additional Drive-Installed.....    | 99    | TTL Monochrome Monitor.....                | 139 |
| Irwin 10 Meg. Tape Back up.....    | 489   | Microsoft Mouse.....                       | 139 |
| Upgrade from 256K to 640K RAM..... | 79    | Upgrade from Floppy Controller to Disk I/O |     |
| 8087 Math Co Processor.....        | 119   | 2 drive controller, clock/cal., software   |     |
| Color Graphics Card.....           | 79    | parallel, serial, and game ports.....      | 79  |
| Monochrome Graphics Card.....      | 99    | 1200 Baud Internal Modem w/Software        | 179 |

## 21 Megabyte Gold Card

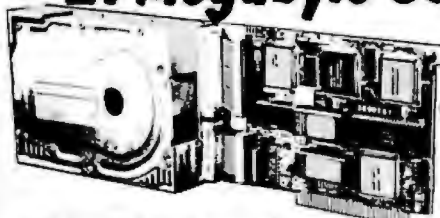

**\$419**

The fastest, lowest powered, longest warranted, most durable, highest capacity, most reliable, lowest priced HARD-DISK-ON-A CARD available in the world today.

- 65ms Access Time - Fastest Available
- Automatic Head Unloading - Protects Heads and Media
- 2K Sector Buffer - Increases System Throughput
- High Reliability: 28,000 hr. MTBF - No one else even close
- 15.5 Watt Power Consumption - Lowest Available
- 2 Year Warranty - Longest Available

WERE \$695... GET 'EM WHILE THEY LAST FOR JUST \$575/419

## NOW YOUR COMPUTER CAN READ!

Omni-Reader... the first optical character reader designed and priced for the small computer

**\$179**

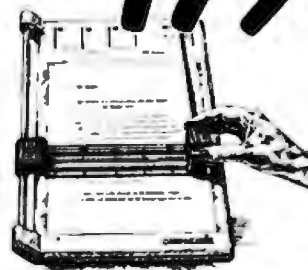

### COPY:

- Manuscripts
- Contracts
- Articles
- Forms
- Invoices

### APPLICATIONS:

- Mailing Lists
- Editing
- Data Base Management
- Transferring information between incompatible systems

Uses a standard RS-232 serial port hookup to interface easily with your computer.

## 1200 BAUD MODEMS



AVATEX 1200

**\$99**

This 300/1200 baud modem matches the design specs of the Bell 212A, feature by feature, bringing you reliability, impeccable transmission and easy operation. Hayes Compatible, except for "S" register. Communication software included.

The AVATEX 1200, at \$99, is a steal!

### SMARTTEAM 1200



**\$159**

The Team 212A offers all the features of the Hayes Smart Modem 1200 for a fraction of the price. Now is your opportunity to purchase a 1200 baud modem at the price of a 300 baud modem.

### SIGNALMAN 300 BAUD MARK VI



**\$49**

The Anchor Automation Mark VI is a 300 baud direct connect modem that plugs into any slot of your IBM/PC. This modem supports auto answer and auto dial capabilities. Other features include telephone number storage, send / receive text files, single key-stroke dialing along with many other functions provided on disk. The Mark VI was originally priced at over \$300.

### ECLIPSE 2400 BAUD MODEM



**\$299**

- Hayes & Bell 212A/103 Compatible
- CCITT V.22, V.22 bis

The ECLIPSE 2400 modem is a microprocessor-based full or half-duplex modem incorporating the latest in high speed data communications capabilities. It also accommodates computers and terminals equipped with an RS-232 port allowing communication with other computers or timesharing systems either locally or remotely. Compatibility, Versatility and Performance are yours in a configuration designed to provide years of reliable operation.

## MODEMS

|                                                |            |        |
|------------------------------------------------|------------|--------|
| Eclipse 1200, 100% Hayes, with status lamps    | EDP-1200   | 149 00 |
| Eclipse 1200B internal with software           | EDP-1200B  | 139 00 |
| Eclipse 2400 External, Hayes Compatible        | EDP-2400   | 299 00 |
| Avatech 1200 baud external, Hayes              | AVA-1200   | 99 00  |
| Hayes Smartmodem 2400 baud modem               | HYS-2400   | 599 00 |
| Fujitsu 2400/1200 baud auto everything         | FUJ-1935D  | 459 00 |
| Team 1200 Hayes Compatible, 300/1200 baud      | TEM-1200   | 159 00 |
| Smarteam 1200B IBM 1200 baud card              | TEM-1200B  | 159 00 |
| UltraLink 1200 data and voice on same line     | UTL-1200A  | 99 00  |
| CTS 212AH 1200 baud, auto dial                 | CTS-212AH  | 179 00 |
| Prometheus 1200 super features                 | PRM-P1200  | 289 00 |
| Prometheus 1200B internal PC                   | PRM-P1200B | 279 00 |
| Signalman Mark VI, 300 baud internal PC        | SGL-MKE    | 49 00  |
| Hayes Smart Modem 1200 baud, auto dial         | HYS-12AD   | 359 00 |
| Hayes 1200B for use with the IBM/PC, 1200 baud | HYS-1200B  | 299 00 |
| Hayes Smartmodem, 300 baud only, auto dial     | HYS-103AD  | 199 00 |
| Hayes Chronograph, time & date                 | HYS-CHR232 | 199 00 |

## Seagate

20 MEGABYTE WINCHESTER HARD DISK DRIVE

**\$299**

Quantity Two



### Five Inch Winchester Disk Drives

each two+

|                             |      |      |
|-----------------------------|------|------|
| SEAGATE 225 20 Meg. 1/4 HI. | 329  | 299  |
| SEAGATE 4026 26 M. 35mS.    | 769  | 720  |
| SEAGATE 4051 51 M. 35mS.    | 995  | 958  |
| FUJITSU 2242 55 M. 35mS.    | 1599 | 1520 |
| FUJITSU 2243 88 M. 35mS.    | 2095 | 2019 |
| RODIME RO-202E 27 Meg.      | 659  | 629  |
| RODIME RO-203E 40 Meg.      | 995  | 959  |
| RODIME RO-204E 53 Meg.      | 995  | 959  |
| CONTRLD DATA 94155-86 M.    | 1829 | 1779 |
| MAXTOR XT1140 148 Meg.      | 2995 | 2929 |
| HONEYWELL 85M. 27 mS.       | 1795 | 1695 |
| TOSHIBA MK56 70 M. 30mS.    | 1789 | 1729 |
| TANDON 582 10 Meg.          | 419  | 379  |

- Winchester Controllers for IBM/PC
- XEBEC 1220 with floppy controller
- NATIONAL COMPUTER 5004
- DTC 5150BX
- DMTI 5510 half card
- ADAPTEC 2010A software install
- WESTERN DIGITAL WD/1002
- SCSI/SASI Winchester Controllers
- XEBEC 1410A 5 1/4" foot print
- DMTI 20L
- Winchester Accessories
- Installation Kit with manual
- Winchester enclosure and supply
- Dual 20/34 cable set
- Switching power supply

TOLL FREE ORDER LINE  
**(800) 421-5041**

TECHNICAL & CALIFORNIA  
**(213) 217-0500**

# California Digital

17700 Figueroa Street • Carson, California 90248

## Advanced 286 AT Compatible

# \$1495

Phoenix BIOS • 200 Watt Power Supply  
MS-DOS 3.2 • GW Basic • 5/8 Mhz. Selectable

The Advanced AT is everything you ever wanted in an IBM/AT compatible. Complete with 640 k/byte of memory, (expandable to 1 Meg.) 1.2 M/Byte floppy drive, hard disk controller that will support upto 140 Megabytes of Winchester storage and on board real time clock.

The Advanced AT/286 compatible will run every program written for the IBM/AT as well as the PC/XT. High resolution (640 / 240) RGB color monitor \$299 additional. 360K drive and 40 Meg. Winchester available. Fully FCC commercial and consumer approved.



## SONY 53W Floppy Disk Drive

3 1/2" New IBM portable compatible

# \$139



## 5 1/4" DISK DRIVE SALE \$89

Quantity Two

Your Choice 48 or 96 TPI drive.  
QUME MODEL 142 • 48 TPI  
MITSUBISHI 4853 • 96 TPI



### MASS STORAGE ALTERNATIVE

TAKE IT WITH YOU!

## Bernoulli Box

was \$3540 now only

# \$1595

The Bernoulli Box by Compaq, features 10 and 20 megabyte removable cartridges, and delivers reliability, expandability, transportability, security and speed in the versatile subsystem. It lets you transfer megabytes of information safely and swiftly for primary or backup storage. Or combine several software programs onto a single cartridge for easy switching from one to another.

Reliable... the Box has incredible resistance to shock and vibration completely eliminating the possibility of head crash.  
Expandable... grow at your own pace by adding inexpensive cartridges. When security is essential, lock up your system... just lock up the cartridges.  
The Bernoulli Box delivers performance that often exceeds the best of hard disk speed and the convenience of floppy disks. At these prices don't be caught wishing you had one after a loss of irreplaceable data.

|                     | List   | Our Price   |
|---------------------|--------|-------------|
| 10+10 Meg.          | A2210H | \$3450 1595 |
| 20+20 Meg.          | A2220H | 4540 2095   |
| Bootable Controller |        | 255 159     |
| 10 Meg. Cartridge   |        | 79 49       |
| 20 Meg. Cartridge   |        | 99 65       |

## F/10 Daisy Wheel Printer \$429



The TEC F-10 Daisy Wheel printer is the perfect answer to a reasonably priced 40 character word processing printer. While this printer is identical to C. Tech's F-10/40 Starwriter printer, it bears the name of a well known computer manufacturer.

This 40 character per second printer auto installs with Wordstar and Perfect Writer. Features extensive built-in word processing functions that allow easy adaptability and reduced software complexity. Industry standard Centronics interface provides instant compatibility with all computers equipped with a parallel printer port. The TEC F-10 accepts paper up to 15 inches in width.

These printers were originally priced to sell at over \$1400. Through a special arrangement California Digital has purchased these units from the computer manufacturer and is offering these printers at a fraction of their original cost. Options available include sheetfeeder, tractor feed, buffered memory and an assortment of printer cables for a variety of computers.

## PLOTTER \$179

The Compaq Colorwriter is the ideal solution to make short work of transferring financial and numeric data into a graphic presentation. Many ready to run programs such as Lotus 1-2-3, Visi-on and Ropic business graphics already support this printer.  
The Compaq Colorwriter programmable paper sizes up to 8 1/2" by 120 inches. A inch per second dot grid and 600 dpi resolution. Easy to implement Centronics interface allows the Compaq Colorwriter to work with the price/performance of most personal computers.  
The Colorwriter is manufactured for Compaq by the Elex Computer Corporation. The printer is marketed by Hewlett-Packard and also sold under Elex's own Super D Label. This is your opportunity to purchase a printer which was originally priced at \$799 for only \$219. Also available is a support package which includes demonstration software, interface cable, a multi-color pen assignment and a variety of paper and transparency material.

## Quick-Link 300 \$59

The Quick-Link 300 gives you an instant link to any dial up data base. Such as Dow Jones, Western Union or the Source. The Quick-Link has four user programmable log-on keys, allowing the operator, with only one key stroke, to dial the data base, log-in and give the password. All this information is permanently stored in non-volatile RAM.  
Features include video output to television or monitor, auto dial, auto-log, full sized keyboard, 300 baud modem and 1200 baud auxiliary printer port. All this is available for only \$59.

|                                  | One | Two | Ten |
|----------------------------------|-----|-----|-----|
| TEAC FD55BV half height          | 109 | 99  | 89  |
| TEAC FD55FV 96 TPI, half ht.     | 119 | 109 | 105 |
| TEAC FD55GF for IBM AT           | 169 | 159 | 155 |
| PANASONIC 455 Half Height        | 109 | 99  | 89  |
| PANASONIC 465 1/2 Ht. 96TPI      | 119 | 109 | 105 |
| TANDON 100-2 full height         | 129 | 125 | 119 |
| MITSUBISHI new 501 half ht.      | 129 | 119 | 109 |
| MITSUBISHI 4853 96/TPI 1/2 Ht.   | 99  | 89  | 89  |
| MITSUBISHI 4854 8" elec.         | 295 | 285 | 275 |
| QUME 142 half height             | 99  | 89  | 89  |
| Switching power supply           |     |     | 49  |
| Installation Kit with manual     |     |     | 10  |
| Dual enclosure for 5 1/4" drives |     |     | 59  |
| 34 pin edge connectors           |     |     | 5   |
| Scotch head cleaning kit         |     |     | 19  |
| Flip & File Storage tubs         |     |     | 15  |

## QUME \$119

Eight Inch Single Sided Drives  
QUME 841 single side 129 119 call  
SHUGART 801R 359 359 354  
SIEMENS FDD 100-8 119 115 109

Eight Inch Double Sided Drives  
QUME 842 "QUME TRACK 8" 189 179 call  
SHUGART SAB51R 495 485 475  
OLIVETTI double sided 189 179 159  
REMEX RFD-4000 179 169 159  
MITSUBISHI M2896-63 1/2 Ht. 459 449 409  
Dual 8" enclosure with power and fan 259  
Switching power supply 89  
Installation kit with manual 10

## PRINTERS

### MATRIX PRINTERS

|                                                          |             |         |
|----------------------------------------------------------|-------------|---------|
| NEC P77 132 cpi. parallel interface                      | NEC-780     | 659 00  |
| Star Gemini M-15 300 cpi. 136 cpi. 24 wire head          | STR-M15     | 389 00  |
| Star Gemini M-10 120 cpi./30 cpi. NLD tractor            | STR-M10     | 299 00  |
| Canyon MSP110T 160 cpi./sec.                             | CT44SP10    | 259 00  |
| Panasonic KX1091 120 cpi. draft, 29 pin, O.D. & friction | PAN-KX1091  | 259 00  |
| Toshiba 351P/S 240 char/sec. 24 wire head                | TOS-351PS   | 1099 00 |
| Toshiba 341P/S part 1 180 cpi. 24 wire head              | TOS-341P/S2 | 759 00  |
| Olivetti 1529 180 cpi./sec. 17 1/2 paper                 | OLV-1529    | 229 00  |
| Olivetti 152A parallel interface, 160 cpi./sec           | OLV-152A    | 379 00  |
| Olivetti 84P parallel 15 paper                           | OLV-84P     | 895 00  |
| Epson LX-80 110/120 cpi./sec                             | EPSON-LX80  | 269 00  |
| Epson LD800 near letter quality                          | EPSON-LD800 | 629 00  |
| Epson FX85 180 cpi. draft 39 cpi. NLD 240 dot/inch       | EPSON-FX85  | 389 00  |
| Epson FX280 132 cpi. 200 cpi./sec. NLD graphics          | EPSON-FX280 | 569 00  |
| Dataproducts D-600-3, band printer 600 LPM               | DPB-600     | 999 00  |
| Printronix P300 high speed printer 300 lines per minute  | PRN-P300    | 2995 00 |
| Printronix P600 ultra high speed 600 lines per minute    | P6K-600     | 5795 00 |

### WORD PROCESSING PRINTERS

|                                                                 |            |         |
|-----------------------------------------------------------------|------------|---------|
| Starwriter F10 (600) parallel 40 cpi./sec.                      | PRD-F10P   | 499 00  |
| Starwriter F10 (600) serial 55 cpi./sec. 50 pin D-sub interface | PRD-F10S   | 559 00  |
| NEC SA-10 55 cpi./sec. serial interface                         | NEC-SA10   | 1179 00 |
| NEC CB39 55 cpi./sec. parallel interface                        | NEC-CB39   | 1179 00 |
| NEC C350 popular printer designed for the IBM/PC                | NEC-C350   | 819 00  |
| Sierra Rised EXR600 25 cpi. 10x12x15 pin serial/par             | SND-EXR600 | 319 00  |
| Sierra Rised EXR600 same as 600 but 40 cpi./sec.                | SND-EXR600 | 729 00  |
| Dynalot 120 proportional spacing, horiz & vert font 20 cpi.     | DLB-200    | 289 00  |
| Jun 6150 18 cpi./sec                                            | JUN-6100   | 359 00  |
| Jun 6150 40 cpi./sec                                            | JUN-6300   | 689 00  |



Shipping: First five pounds \$3.00, each additional pound \$.50.  
Foreign orders: 10% shipping, excess will be refunded.  
California residents add 6 1/2% sales tax. • COD's discouraged.  
Open accounts extended to state supported educational institutions and companies with a strong "Dun & Bradstreet" rating.

# 1200 BAUD MODEM

These truly Hayes compatible, intelligent 1200 baud modems have features found on the expensive name brand modems. Choose either the internal Jade 1200 baud Smart-Card, including

software for your IBM PC compatible; or our best selling Jade 1200 baud external modem for any computer with a serial RS-232C port. We guarantee you will be satisfied.

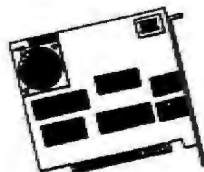

## \$149

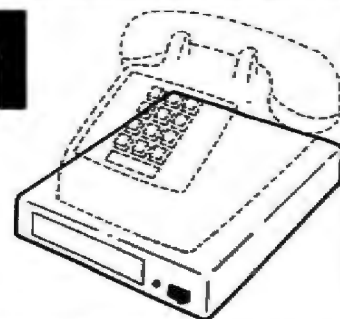

INTERNAL OR EXTERNAL

## JADE XPC or XPC-AT

- 640K of RAM
- 4.77 MHz 8088
- 7 MHz turbo mode
- 135 watt power supply
- 360K disk drive
- Floppy disk controller
- 5151-style keyboard
- 8 expansion slots
- PC-style case
- One year warranty

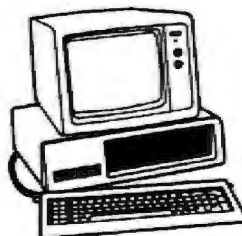

**\$788**

- 1 MB of RAM
- 6 MHz 80286
- 8 MHz turbo mode
- 200 watt power supply
- 1.2 MB disk drive
- Floppy/hard disk controller
- AT-style keyboard
- 8 expansion slots
- AT-style case
- One year warranty

**\$1488**

## HIGH RESOLUTION COLOR MONITOR

Manufactured by Hitachi

- IBM PC color graphics compatible
- High resolution 640 x 240
- Excellent dot pitch .38 mm
- 16 true colors, 2000 characters
- Accepts standard RGB input signals
- Non-glare picture tube
- New designer sculpted case

**\$289**

List Price \$699  
Free PC RGB cable included

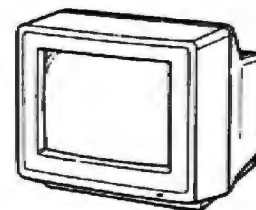

**OPTION #1**  
Two disk drives  
Mono graphics card  
Parallel printer port  
Amdek 310A monitor

XPC **\$1188** XPC-AT **\$1988**

**OPTION #2**  
20 MB hard disk  
Mono graphics card  
Parallel printer port  
PGS MAX-12E monitor

XPC **\$1588** XPC-AT **\$2388**

**OPTION #3**  
20 MB hard disk  
Color graphics card  
Parallel printer port  
Hitachi hi-res color monitor

XPC **\$1788** XPC-AT **\$2588**

## MANNESMANN TALLY PIXY 3 3-PEN PLOTTER

**\$198** List Price \$799  
You save \$600!  
Limited Quantity

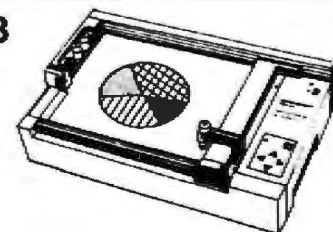

We are probably making a mistake selling this high speed plotter for only \$198. They are easily worth at least \$500 more. Compare the features to plotters costing \$2000 or more.

- High speed 8 IPS plotting
- 3-pen auto select plotter
- 8 Colors available
- Parallel or serial interface
- Full graphics + built-in fonts
- 8 1/2 x 11 paper or transparencies

| OPTIONS                             | LIST  | JADE   |
|-------------------------------------|-------|--------|
| 8 extra water base pens             | \$30  | \$1695 |
| 4 extra oil base pens               | \$30  | \$1695 |
| 100 sheets 8 1/2 x 11 paper         | \$9   | \$495  |
| 50 sheets 8 1/2 x 11 transparencies | \$9   | \$495  |
| Plotter software for IBM-PC         | \$195 | \$595  |

## 21 MB HARD DISK ON A CARD

**\$498**

MEGACARD! 21 HIGH SPEED, LOW POWER

- Easy installation - pre-formatted
- Automatic carriage lock
- Dual disk controller
- NEC "zero defect" reliability
- High speed data transfer
- High shock rating
- Low power - 13 watts
- Two year factory warranty



## HARD DISK SYSTEM

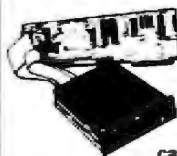

FOR YOUR IBM PC

**\$399<sup>95</sup>**

Complete with controller card, data cable, and mounting hardware, totally PC/XT compatible.

|                         |        |                      |
|-------------------------|--------|----------------------|
| 10 MB Internal KR       | \$990  | \$399. <sup>95</sup> |
| 20 MB Internal 1/2 High | \$1550 | \$445. <sup>95</sup> |
| 10 MB Hard Disk Card    | \$699  | \$399. <sup>95</sup> |
| 20 MB Hard Disk Card    | \$699  | \$498. <sup>95</sup> |

## POWER/SURGE PROTECTION

6 Button, Under-Monitor, Swivel Power/Surge Control Center

**\$799<sup>5</sup>**

List Price \$129



6 Socket, UL Listed, U.S. Made Power/Surge Strip

**\$189<sup>5</sup>**

List Price \$49

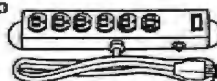

## Why pay \$1149 for a C. Itoh STARWRITER F-10

when our 40 cps letter quality daisywheel from the same manufacturer is only as low as

**\$399<sup>95</sup>** Each for 5 or more

Each—\$499 | 2 to 5—\$429

\*StarWriter is a Trademark of C. Itoh Digital Products, Inc.

Limited Quantity

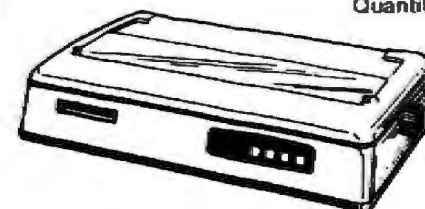

|                               |       |                      |
|-------------------------------|-------|----------------------|
|                               | LIST  | JADE                 |
| Bi-directional deluxe tractor | \$249 | \$149. <sup>95</sup> |
| Automatic cut sheet feeder    | \$449 | \$199. <sup>95</sup> |

## QUME DISK DRIVE

IBM PC, XT or compatible

**\$69<sup>95</sup>**



|                      |       |                      |
|----------------------|-------|----------------------|
| TANDON 100-2, DS, DD | \$299 | \$119. <sup>95</sup> |
| TEAC 55B, DS, DD     | \$249 | \$119. <sup>95</sup> |

## FREE Software W/MOUSE

|                              |       |                      |
|------------------------------|-------|----------------------|
|                              | LIST  | JADE                 |
| Microsoft Mouse w/Paintbrush | \$199 | \$139. <sup>95</sup> |
| PC Mouse w/Dr Halo II        | \$195 | \$139. <sup>95</sup> |

## High Speed APU Chips

|        |                      |          |                      |
|--------|----------------------|----------|----------------------|
| 8087-3 | \$149. <sup>95</sup> | 80287    | \$249. <sup>95</sup> |
| 8087-2 | \$199. <sup>95</sup> | NEC V-20 | \$24. <sup>95</sup>  |

## AST Boards On Sale!

|                        |       |                      |
|------------------------|-------|----------------------|
|                        | LIST  | JADE                 |
| AST Six Pak Plus 64K   | \$385 | \$199. <sup>95</sup> |
| AST Six Pak Plus 384K  | \$945 | \$249. <sup>95</sup> |
| AST Rampage 256K       | \$495 | \$299. <sup>95</sup> |
| AST Rampage AT 512K    | \$695 | \$399. <sup>95</sup> |
| AST Advantage-AT 128K  | \$595 | \$399. <sup>95</sup> |
| AST SixPakPremium 512K | \$695 | \$399. <sup>95</sup> |

## ISO-BAR

These industrial quality ISO-BAR's contain surge suppression circuitry and built-in noise filters plus a 15 amp circuit breaker.

|                               |       |                      |
|-------------------------------|-------|----------------------|
|                               | LIST  | JADE                 |
| 6 Socket, 1 Filter ISO-BAR    | \$69  | \$44. <sup>95</sup>  |
| 4 Socket, 2 Filter ISO-BAR    | \$69  | \$59. <sup>95</sup>  |
| 8 Socket, 4 Filter ISO-BAR    | \$99  | \$69. <sup>95</sup>  |
| 200 Watt Standby Power Supply | \$359 | \$269. <sup>95</sup> |
| 425 Watt Standby Power Supply | \$539 | \$449. <sup>95</sup> |

## MICROFAZER Buffers

Expandable to 64K (Parallel model to 512K)

|                               |       |                      |
|-------------------------------|-------|----------------------|
| 8K Parallel in/Parallel out   | \$169 | \$139. <sup>95</sup> |
| 64K Parallel in/Parallel out  | \$225 | \$164. <sup>95</sup> |
| 128K Parallel in/Parallel out | \$445 | \$269. <sup>95</sup> |
| 512K Parallel in/Parallel out | \$679 | \$499. <sup>95</sup> |

Your choice: serial in/serial out; parallel in/serial out; serial in/parallel out.

|    |       |                      |     |       |                      |
|----|-------|----------------------|-----|-------|----------------------|
| 8K | \$199 | \$169. <sup>95</sup> | 64K | \$260 | \$199. <sup>95</sup> |
|----|-------|----------------------|-----|-------|----------------------|

## TALLTREE

|         |                      |                |                      |
|---------|----------------------|----------------|----------------------|
| JRAM-AT |                      | JRAM 3-AT      |                      |
| 0K      | \$169. <sup>95</sup> | 0K             | \$259. <sup>95</sup> |
| 2 MB    | \$599. <sup>95</sup> | 2 MB           | \$699. <sup>95</sup> |
| JRAM-3  |                      | Add-on Modules |                      |
| 0K      | \$199. <sup>95</sup> | S/P/C          | \$159. <sup>95</sup> |
| 2 MB    | \$629. <sup>95</sup> | S/S/C          | \$159. <sup>95</sup> |

## Printers

|               |         |
|---------------|---------|
| EPSON FX-85   | OKIDATA |
| EPSON FX-286  | TOSHIBA |
| EPSON LQ-800  | CITIZEN |
| EPSON LQ-1000 | C. ITOH |
| EPSON LX-80   | DIABLO  |

PRICED TOO LOW TO PUBLISH!  
Call us for our best price.

## New HAYES 2400B Internal

|                             |       |                      |
|-----------------------------|-------|----------------------|
|                             | LIST  | JADE                 |
| New 2400B Card w/Smartcom   | \$799 | \$579. <sup>95</sup> |
| HAYES Smartmodem 2400       | \$699 | \$629. <sup>95</sup> |
| HAYES Smartmodem 1200       | \$699 | \$389. <sup>95</sup> |
| HAYES 1200B w/o Smartcom II | \$539 | \$339. <sup>95</sup> |
| HAYES 1200B for IBM PC      | \$599 | \$359. <sup>95</sup> |

## Multifunction Card

Up to 384K, parallel printer port, RS-232 serial port, game port, clock/calendar, RAM disk/printer buffer software package.

|                      |       |                      |
|----------------------|-------|----------------------|
|                      | LIST  | JADE                 |
| 0K JADE 7 Pak Plus   | \$299 | \$119. <sup>95</sup> |
| 384K JADE 7 Pak Plus | \$649 | \$199. <sup>95</sup> |

## 135/150 Watt Power Supply

|                       |       |                     |
|-----------------------|-------|---------------------|
| 135 Watt Power Supply | \$199 | \$89. <sup>95</sup> |
| 150 Watt Power Supply | \$249 | \$99. <sup>95</sup> |

## Apple Accessories

|                               |       |                      |
|-------------------------------|-------|----------------------|
| IIc 1/2 High Disk Drive       | \$279 | \$119. <sup>95</sup> |
| IIe 1/2 High Disk Drive       | \$239 | \$119. <sup>95</sup> |
| IIe, II+ Disk Drive           | \$249 | \$139. <sup>95</sup> |
| IIe 64K, 80 Column Card       | \$159 | \$79. <sup>95</sup>  |
| II+ 80 column card            | \$239 | \$119. <sup>95</sup> |
| Grappler Printer Card         | \$175 | \$89. <sup>95</sup>  |
| II+ 16K RAM Card              | \$99  | \$39. <sup>95</sup>  |
| II+, IIe Printer Card & Cable | \$109 | \$49. <sup>95</sup>  |
| II+, IIe Cooling Fan          | \$99  | \$59. <sup>95</sup>  |

## INTEL Above Board

|                        |                       |
|------------------------|-----------------------|
| 64K PC expands to 2MB  | \$299. <sup>95</sup>  |
| 2MB PC Above Board     | \$599. <sup>95</sup>  |
| 128K AT expands to 4MB | \$449. <sup>95</sup>  |
| 4 MB AT Above Board    | \$1299. <sup>95</sup> |

## IBM Video Boards

|                                 |       |                      |
|---------------------------------|-------|----------------------|
| New Hercules Graphics Card Plus | \$299 | \$248. <sup>95</sup> |
| Hercules Color Graphics         | \$245 | \$189. <sup>95</sup> |
| JADE Color Graphics             | \$199 | \$99. <sup>95</sup>  |
| Hercules Monochrome Graphics    | \$499 | \$249. <sup>95</sup> |
| JADE Monochrome Graphics        | \$299 | \$119. <sup>95</sup> |
| JADE EGA+ Card                  | \$495 | \$299. <sup>95</sup> |

# JADE COMPUTER

4901 W. Rosecrans Ave. Box 5046  
Hawthorne, CA 90251-5046

We accept cash, checks, credit cards or purchase orders from qualified firms and institutions. Minimum prepaid order \$15.00. California residents add 6 1/2% tax. Prices & availability subject to change without notice. Shipping & handling charges via UPS Ground 50¢/lb. UPS Air \$1.00/lb. Minimum charge \$3.00.



PLACE  
ORDERS  
TOLL  
FREE!

Continental U.S.A.  
(800)421-5500  
Inside California  
(800)262-1710  
Los Angeles Area  
(213)973-7707

**NEW! IC-EZ NEW!**  
**IC DIP REMOVAL TOOL**

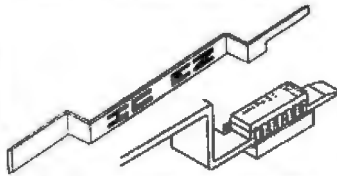

**SAVES TIME & MONEY**

Safely Removes Costly IC DIP'S  
Quickly and Easily from Sockets.  
Dense Boards - No Problem. Doesn't  
Bend Pins, Destroy IC's or Sockets.  
Qty. 1-100 100-250 250-500  
Price Ea. 7.50 6.50 5.50

**OMNITRON INC.**

P.O. Box 388, Saline, MI 48176  
Michigan Residents add Sales Tax

Inquiry 257

EVASAN (415) 991-1051  
P.O. Box 2163 Daly City, CA 94012

V - 20 8 mhz 9.50

Math Co-Processors  
8087 - 2 8 mhz 142.00  
80287 - 3 8 mhz 162.00

| DYNAMIC RAMS |       | EPROMS |                   |
|--------------|-------|--------|-------------------|
| 1 MEG        | 100ns | 60.00  | 27512 250ns 17.00 |
| 41256        | 100ns | 4.65   | 27C256 200ns 7.00 |
| 41256        | 120ns | 2.98   | 27C256 250ns 6.50 |
| 41256        | 150ns | 2.65   | 27256 250ns 5.20  |
| 4164         | 120ns | 1.18   | 27118 250ns 3.60  |
| 4164         | 150ns | 1.00   | 2764 200ns 3.75   |
| 4464         | 120ns | 4.25   | 2764 250ns 3.20   |
| 4464         | 150ns | 3.95   | 2732A 200ns 3.90  |
| 4128         | 150ns | 4.00   | 2732A 250ns 3.50  |

**STATIC RAMS**

|        |       |       |
|--------|-------|-------|
| 43256L | 120ns | 28.00 |
| 6264L  | 150ns | 2.80  |
| 5564L  | 150ns | 4.75  |
| 5565L  | 150ns | 3.25  |
| 6116   | 150ns | 1.45  |

**TERMS AND CONDITIONS**

- 1) PRICES SUBJECT TO CHANGE. PLEASE CALL FOR CURRENT & VOLUME PRICING.
- 2) MINIMUM ORDER - \$10.00
- 3) SHIPPING & HANDLING: UPS GROUND - \$3.00 (One Pound) UPS AIR - \$4.50 California Residents add 6.5% sales tax.
- 4) 3% SURCHARGE ON CREDIT CARD CHARGES.

ALL MERCHANDISE 100% GUARANTEED- prompt DELIVERY  
CALL FOR PRICE LIST

Inquiry 72

**FREE CATALOG**



Outstanding prices on computer accessories for your computer and workstation. Our catalog features a wide selection of quality products to meet all your accessory needs. Call or write today to receive your free catalog.

**LINTEK COMPUTER ACCESSORIES**  
POB 8056, Grand Rapids, MI 49518  
(816) 241-4040

Inquiry 199

**SAVE MONEY EPROM PROGRAMMER**



APROTEK 1000 ONLY

**\$265.00**

COMPLETE WITH PERSONALITY MODULE

117 AC POWER- RS-232 CONNECT  
- 8 BAUD RATES - HANDSHAKE TO HOST  
ALLOWS READ, WRITE, VERIFY & COPY

Comes complete with IBM-PC, Apple, or CPM (Specify Computer) Driver Program on Disc.

Programs the following 5 Volt 24 or 28 pin devices: 2716 series through 27512, 25xx series, 68764 plus others. Please Specify Personality Module desired with order. Additional Personality Modules only \$15.00 ea. Full 1 year warranty.

TO ORDER CALL 1 800-962-5800 OR WRITE  
APROTEK

1011 A AVENIDA ALASO Auld  
CAMARILLO CA 91301 \$4.00 Shipping USA  
Info (805) 987-2454 VISA or MC Add 3%  
We Accept Govt. School & Large Corp. P.O.s

Inquiry 25



- XT/840K 2DR. MONITOR ..... \$849
- XT/840K 1DR. 10MEG HD ..... \$1099
- XT/840K 1DR. 20MEG HD ..... \$1299
- AT/840K 1DR. 20MEG HD ..... \$2299
- COMPACT XT/840 2DR. .... \$1099
- TURBO BOARD-ADD ..... \$25
- CITIZEN 1200 PRINTER ..... \$199
- W/ MULTI I/O CK/CL GAME-ADD ..... \$75
- W/COLOR MONITOR & CARD-ADD ..... \$250
- W/5151-5251 KEYBOARD-ADD ..... \$29

ALL UNITS INCLUDE MONITORS, PRINTER PORTS, GRAPHICS CARDS & KEYBOARDS  
**MICRO-TECH COMPUTER CO.**  
408-A MERCEDES ST.  
FORT WORTH, TEXAS 76126  
MasterCard/VISA... Add 4%  
Information & Texas Calls ..... Orders Outside of Texas  
(817) 249-1951 ..... 800-828-1748

Inquiry 141

**MAGNAVOX PROFESSIONAL MONITORS**

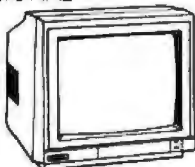

**Monochrome Monitor**

• TTL input • high resolution (1000 lines) = 25 lines x 80 column • 12" non-glare screen • built-in tilt stand

No. 98710 - green display ..... \$87.00

No. 98720 - amber display ..... \$97.00

**Color Monitor**

• Accepts RGB, TTL, RGB analog, & composite video inputs • 25 lines x 80 column • 840 dots x 240 lines resolution • 13" etched screen

No. 97800 ..... \$298.00

**The Wholesale Outlet • Order Toll Free**  
1 Interstate Avenue 1800-344-4387 (NON-NYS)  
Albany, N.Y. 12205 All other calls & NYS call  
(518) 458-7883

MC/VISA OR COD CASH  
All orders shipped FOB Albany • Prices subject to change

Inquiry 378

**Single Board Solutions**  
Introduces  
**SBS-52 Controller**

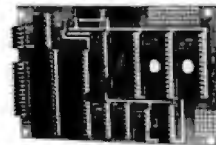

- 8052 Basic VI.1
  - 32 Kx8 Ram
  - 2 Real Time Clocks
  - 32 I/O Lines
  - Programs Eproms
  - Small 3.00x5.00 Size
- 1-10 \$179.00

Single Board Solutions  
P.O. Box 3788  
Salem, Oregon 97302  
Phone (503) 581-6570

Inquiry 311

**SOFTWARE SENTINEL™**



Because its original objective was to protect software from unauthorized use it's called the SOFTWARE SENTINEL. But maybe we'll change the name to REVENUe GENERATOR since we've discovered its true value to our customers. But whatever we call it everyone ends up with numerous benefits from this hardware key with unrivaled tactics.

- SOFTWARE DEVELOPER BENEFITS**
- Promotes unauthorized use of software
  - No need for copy protection
  - Algorithm techniques (near a hard response)
  - Virtually undetectable
  - Higher level language interfaces included
  - 100 times faster (1ms) than hard response devices
  - Minimal implementation effort
  - Runs under DOS and runs on IBM PC, AT & compatibles

- SOFTWARE USER BENEFITS**
- Unlimited backup copies
  - No floppy required with hard disk
  - Portable
  - Nonproprietary
  - Nonportable



EVALUATION KIT AVAILABLE

17971 SKYPARK CIRCL 5011 E. IRVINE, CA 92714 (714)261-0228

Inquiry 294



714/898-0840

Telex: 887841 XORDATA HTBH Fax: 714/897-3363

15392 Assembly Lane, Unit A • Huntington Beach, CA 92649

## Our 1986 Catalog is HOT off the press!

### Dealers! Check our Profitable Discount Pricing!

Look what's Inside!

## 5 Complete Systems



**XAT TURBO**

The XAT is our most versatile and powerful system. Using Intel's 80286 processor, the system runs at 6 and 8 MHz with a true 16 bit data bus. Comes standard with a 3 meg Add-On board, 2 parallel & one serial port monitor, keyboard, DOS 3.1 two 1/2 height DS DD 1.2 meg floppies.



**XPC TURBO**

This standard system is as compatible with IBM as it can be. Featuring a 4 layer mother board, 8 slot expansion up to 640K memory on the motherboard, and the 6.67 MHz TURBO mode. Also included: DOS 3.1 keyboard, 135 watt power supply, TTL 720 x 348 resolution video card, green or amber monitor, serial & parallel ports, Real Time Clock and software.



**XTC TURBO**

The perfect choice for the system integrator who needs the IBM compatibility, but not in the standard PC cabinet. This model features height and removable sides, up to 4 1/2 height peripherals out front, front mount AC switch and rear mount 135 watt power supply. Also features an optional Hard or File Server unit in multi-user configurations.



**XT Jr.**

The XT Jr. is only junior in size! With up to 640K memory on the motherboard and four expansion slots, this stand-alone system is also great for workstations in a networking environment. It can be upgraded to the TURBO two speed motherboard and you can also add up to 2 serial & 2 parallel ports or any IBM compatible expansion card. A perfect word processing data entry system.



**XPC Compact**

This is truly the affordable portable and we'll build it to your specifications. Need a 20 meg hard disk and 20 meg tape with 640K memory in your portable? No problem! The XPC Compact comes standard with a 9" amber TTL monitor, 135 watt P.S., 256K memory, two 360K drives, Real Time Clock, Calendar w/ battery, Back up, serial and parallel ports, and our TURBO Motherboard.

Amsterdam ■ 020-45-26-50

## 24 Add-On Cards

Germany ■



**2 MB Expansion Board**

This board satisfies the new approach suggested by INTEL and Lotus 1-2-3. Also may be used on our XT-80C TURBO board for memory based on DR.



**Hard Disk Controller**

This Western Digital controller handles 1 or 2 drives. 5 to 140 megabytes with minimum software configuration. Features DOS 2.1 & 3.1 compatibility and ST-506 Interface.



**384K Multi-Function**

A Multi-Function board featuring Parallel Port, Serial Port, Game Port, Real Time Clock, Calendar with Battery Back-up, Expand to 384K, all Cables, PrintSpooler and RAM Disk Software and Manuals.



**4 Meg Token Ring**

Connect your workstation to an existing 4 Megabyte IBM token ring system or build up your own IEEE 802.5 standard system. The lowest possible cost for 100% industry standard compatibility.



**AT H.D. & Floppy**

This new Western Digital controller handles up to 4 drives. VLSI technology will give you a data transfer rate 50% faster than the existing controller board in the AT. Runs both 386K and 1.2 meg floppy disk drives.



**Mono & Color Graphics**

Supports two levels of graphics and text in composite monochrome or RGB color. Low resolution 320 x 200 pixel, high resolution 640 x 200 pixel.



**7 PAK Multi-Function**

Features: Floppy Controller, Parallel Port, Serial Port, optional 2nd Serial, Game Port, Real Time Clock, Calendar with Battery Back up, RAMdisk, PrintSpooler, all cables & manuals.

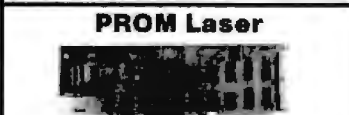

**PROM Laser**

Hi-speed algorithms will burn 2716, 2732, 2732A, 2764 (in 52 sec), 27128, 27258 EPROMS under software control right in your PC. Zero Force insertion Sockets, Software, and Manual.

England ■

## 35 Components

Bombay ■ 357172



**Motherboards**  
XAT TURBO XT-SBC

- RTC Calendar
- 6 & 8 MHz clock
- 8 slot expansion
- Intel 80286
- 4 77 & 8 MHz clock
- Serial & Parallel
- 4 layer PCB design
- RTC Calendar

**XPC TURBO XPC-XT**

- 4 77 & 6.67 MHz
- 4 layer PCB design
- 8 slot expansion
- Intel 80286
- 4 77 & 8 MHz clock
- up to 640K memory
- 8 slot expansion
- Standard 8086 CPU
- RLR7 socket ball



**Power Supplies**  
XT 135 watt XT 150 watt

- 135w switching
- Whisper Fan
- Side AC switch
- +5V/15A - 5V/5A
- +12V/4.2A - 12V/5A
- +12V/5A - 12V/5A
- +12V/7A - 12V/5A
- Whisper fan
- H output 150 watt
- 4 DC connectors
- +5V/15A - 5V/5A
- +12V/5A - 12V/5A

**AT 200 watt XTC 135**

- 200 Watt power
- External AC switch
- 4 DC power conn.
- +5V/20A - 5V/5A
- +12V/7A - 12V/5A
- Rear Mount
- Rear On Off switch
- extra AC outlets
- +5V/15A - 5V/5A
- +12V/4A - 12V/5A

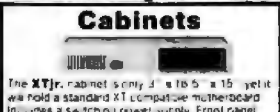

**Cabinets**

The XT Jr. cabinet is only 4" x 16 5/8" x 15" yet it will hold a standard XT compatible motherboard including 8 switching power supply. Front panel cutout for a half height floppy or hard disk.

Our XPC-XT cabinet has an 8 slot back panel with additional cut outs for two RS-232C ports. Features mounting for up to four half height peripherals.

The right choice for an external add on cabinet! Add on a floppy tape back up or up to 33 meg of hard disk - half height. Switching power supply included.



**Keyboards**

**AT**

This Keyboard is standard equipment with all of our XAT systems, but the layout is so well liked, we're offering it here.

**XT**

Our volume purchases of these IBM style units allows us to lower the price once again.

**5051**

Now a fully selective unit at an affordable price. Features a 10 key numeric pad & a separate cursor pad.



**Drives**

Archive  
Irwin  
Maxtor  
Memtek  
Miniscribe  
Panasonic  
Seagate  
TEAC  
Tulin



**3 Sub-Systems**

This full height cabinet will hold a Tape Back-up with full or 1/2 height Hard Disk inside for two Hard Disks!

A perfect cabinet for Tape or Hard Disk, a nice addition to your PC.

Choose from single 1/2 height dual 1/2 height or 7/8" with full height base. All Sub-systems include controllers, cables, software, and manuals.

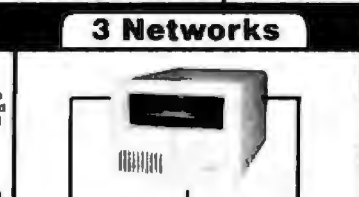

**3 Networks**

One way to stay ahead of the competition is by using a Multi-User or Network system configuration from Micro Products International. Choose from RS-232C, **KOR-NET**, **3DLC** or Token Ring. Data transfer rates up to 4 megabytes/second can be obtained.



**Cassette Training**

What is the Cassette Training concept? Using Interactive Audio Training to combine the advantage of classroom and self-teaching methods. The Method: One audio track delivers a lecture explaining the program, while the second track emulates the keyboard, actually running the student's computer. At frequent intervals the new pattern's automatic cue to allow the student keyboard input, which is monitored for accuracy by the **MITS COED**.



**Int/Ext Modems**

- FCC approved for direct
- Runs the popular Hayes communications software
- Phone Cable & Power Supply
- Finally a price breakthrough with a Hayes compatible external 300-1200 baud modem in a cabinet or software.
- Runs the popular Hayes communications software
- O-Modem software included
- Also runs XCOM software
- All cables included
- We included every feature you would want in a modem card & FCC registered for direct conversion to your modem phone jack with the CD included.

## 72 Digital I/O



### PXB-721

#### Parallel Expansion Board

- For IBM-PC & Compatibles
- 72 Digital I/O Lines
- Simple Programming
- Uses One Expansion Slot
- Fast Delivery

**\$195**

**QUA TECH, INC.**

478 E. Exchange St. Akron OH 44304  
(216) 434-3154 TLX: 5101012726

## WAVEFORM SYNTHESIZER

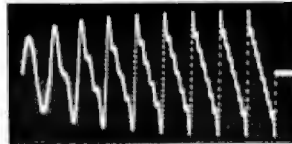
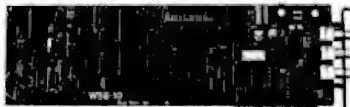

- For IBM-PC/XT/AT and compatibles
- Generates user-definable signal
- Up to 2000 points per envelope

**\$795.00**

**QUA TECH, INC.**

478 E. Exchange St. Akron OH 44304  
(216) 434-3154 TLX: 5101012726

## TERMINAL EMULATION

Softerm PC emulates over 30 popular terminals including the:

- DEC VT102, VT220
- Data General D200, D410
- IBM 3101-20 (block mode)
- Hewlett-Packard 2622A
- Honeywell VIP7801, VIP7803

Guaranteed Compatibility

Call for free product brief!

\$195 MC-VISA-COD

For the IBM PC/XT/AT, DG, NEC, Wang, TI, Gridcase, Tandy, Zenith

**SOFTRONICS**

7899 Lexington Dr., Ste 210  
Colorado Springs, CO 80918  
1-800-225-8590/(303) 593-9540

Inquiry 287

Inquiry 288

Inquiry 315

Advertise your computer products through **BYTE BITS** (2" x 3" ads)

For more information call Dan Harper at 603-924-6830

BYTE  
70 Main St.  
Peterborough, NH 03458

Why waste time?

**ACCELERATE with VCACHE™**

### HARD DISK ACCELERATOR

- Caching eliminates repetitive disk accesses
- Use up to 15 Mb of extended/expanded or 500 Kb of standard memory

### DISKETTE ACCELERATOR

### SCREEN ACCELERATOR

**FAST — FRIENDLY — SAFE**

### VCACHE

### GOLDEN BOW SYSTEMS

**\$65**

Add \$3 for shipping/handling  
California residents add 6% sales tax



2870 Fifth Avenue Suite 201  
San Diego, CA 92103  
619/298-9349

Inquiry 145

## COMPUTER PAPER

As low as **\$4.99** per pack of 500.

We have the **highest quality** and the **lowest prices** on computer paper.

## AND DISKETTES

As low as **39¢**

## BROTHER HR 15... '310.

Call for prices on M1509 Twinwriter and HR25. Tractors, sheer feeders and all other various components are available. \*Certified Brother dealer \*Dealer prices available



**1-212-244-2960**  
450 7th Ave. N.Y. N.Y. 10123

Inquiry 102



## PORTABLE ADDITIONS

**PORTABLE DISK DRIVE \$229**  
3 1/2", batt. oper., TS-DOS, 100K storage

**24K RAM CHIP for Tandy 200 \$75**

**8K RAM CHIP for Model-100 \$25**  
and NEC 8201. . . 3 for \$79, 6 for \$149

**SIDESTAR for NEC Starlet \$199**

128K Ram Disk Cartridge

**SIDECAR for NEC PC-8201A \$259**

4 banks of 32K in one cartridge

**CALL TOLL FREE 1-800-732-5012**

Call: 805-987-4788

Canada: 604-858-8858, Australia: 02-419-8889

**PURPLE COMPUTING**

VISA/MC & AMER. EXP.

420 Constitution Ave., Camarillo, CA 93010

Inquiry 283

### GAT-286

### COMPLETE SYSTEM—\$2195<sup>00</sup>

Includes one megabyte memory on board, 6 or 8 MHz, zero wait state, Phoenix BIOS; Disk drive controller with 2 floppy disk drives (1.2 M.B. and 360 K) and one 20 M.B. hard disk; monochrome monitor with adapter, serial/parallel ports; 200 W. power supply, keyboard, case. IBM PC/AT compatible. Certified to comply with FCC class B standards.

### PC/XT/AT COMPATIBLE PARTS

|                                                                               |          |
|-------------------------------------------------------------------------------|----------|
| Seagate 30 M.B., High Speed Hard Disk                                         | \$645.00 |
| 20 M.B. Hard Disk Kit for PC/XT                                               | \$395.00 |
| 30 M.B. Hard Disk Kit for PC/XT                                               | \$485.00 |
| 136 W. Power Supply                                                           | \$ 65.00 |
| IO Card for XT or AT                                                          | \$ 75.00 |
| LOGIMOUSE                                                                     | \$85.00  |
| 8087-3 Co-Processor                                                           | \$120.00 |
| 80287-3 Co-Processor                                                          | \$215.00 |
| XT Compatible System w/640 K, all ports & clock, 2 drives, monochrome monitor | \$825.00 |

### LUCKY COMPUTERS

(214) 680-8110

1701 Greenville, Suite 602, Richardson, TX 75081

IBM PC/XT/AT are Registered Trademarks of International Business Machines Corp.

Inquiry 210

## BUY UNITED STATES SAVINGS BONDS



# THE LATEST IN PC ENHANCEMENT PRODUCTS

## ENHANCED GRAPHICS ADAPTOR

100% IBM COMPATIBLE—PASSES IBM EGA DIAGNOSTICS

- \* COMPATIBLE WITH IBM EGA, COLOR GRAPHICS ADAPTOR AND MONOCHROME ADAPTOR
- \* DISPLAYS 16 COLORS OUT OF 64 COLORS
- \* COMES WITH 256K OF VIDEO RAM
- \* DUAL SCANNING FREQUENCIES WORKS WITH STANDARD OR EGA TYPE RGB MONITORS
- \* LIGHT PEN INTERFACE

NOW ONLY  
**\$259.95**

## EGA MONITOR

FULL ONE YEAR WARRANTY

- \* EGA AND CGA COMPATIBLE
- \* SCANNING FREQUENCIES:  
15.75 KHz / 21.85 KHz
- \* 14" BLACK MATRIX,  
NON-GLARE SCREEN
- \* RESOLUTION:  
640 x 200 / 640 x 350
- \* .31 DOT, 25MHz
- \* 16 COLORS OUT OF 64
- \* TEXT SWITCH-GREEN/AMBER

**\$499.95**



## 20 MB HARD DISK SYSTEM

INCLUDES HARD DISK CONTROLLER, CABLES AND INSTRUCTIONS. ALL DRIVES ARE PRE-TESTED AND COME WITH A 1 YEAR WARRANTY.

**\$389.95**

## AT MULTIFUNCTION CARD \$199.95

ADDS UP TO 3 MEGABYTES OF USER EXPANDABLE MEMORY

- \* SHIPPED WITH ZERO K RAM, USER EXPANDABLE TO 1.5 MEGABYTES RAM ON BOARD, UP TO 3 MEGABYTES WITH OPTIONAL PIGGYBACK CARD
- \* USES 64K OR 256K DYNAMIC RAMS
- \* PARALLEL PORT & GAME PORT
- \* SERIAL PORT
- \* OPTIONAL SECOND SERIAL PORT

**PIGGYBACK MEMORY CARD (NO MEMORY INSTALLED) \$49.95**

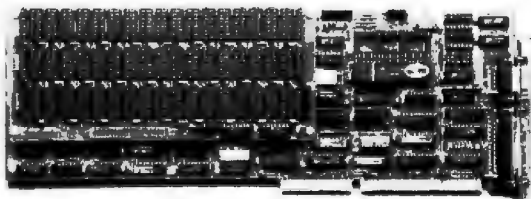

## EXPANDED MEMORY CARD \$199.95

UP TO 2 MEGABYTES OF LOTUS/INTEL COMPATIBLE MEMORY

- \* CONFORMS TO LOTUS/INTEL EXPANDED MEMORY SPECIFICATIONS (EMS)
- \* SHIPPED WITH ZERO K RAM, USER EXPANDABLE TO 2 MEGABYTES
- \* USES 64K OR 256K DYNAMIC RAMS
- \* USE AS EXPANDED (EMS) OR CONVENTIONAL MEMORY, RAMDISK OR SPOOLER
- \* SOFTWARE INCLUDES EMS DEVICE DRIVERS, PRINT SPOOLER AND RAMDISK

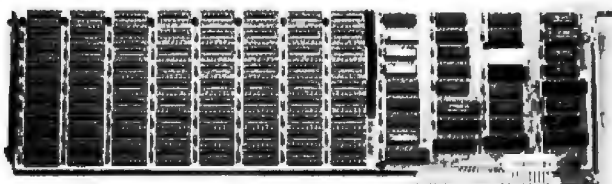

## EPROM PROGRAMMER \$129.95

FOR IBM PC/XT/AT AND COMPATIBLES

- \* PROGRAMS 27xxx SERIES EPROMS UP TO 27512
- \* MENU DRIVEN SOFTWARE PROVIDED ON DISKETTE
- \* AUTOMATICALLY SETS PROGRAMMING VOLTAGE
- \* LOADS AND SAVES EPROM BUFFER TO DISK
- \* READ, WRITE, COPY, VERIFY OR CHECK BLANK
- \* DEBUG STYLE EDITOR FOR EASY MODIFICATION OF PROGRAM
- \* SPLITS OR COMBINES EPROMS OF DIFFERING SIZES
- \* INTERNAL CARD WITH EXTERNAL CABLE FOR A ZIF SOCKET

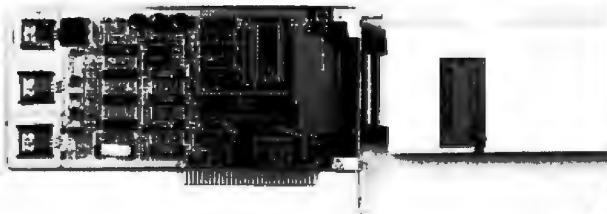

**JDR Microdevices**

Inquiry 182

1224 S. Bascom Avenue, San Jose, CA 95128

Toll Free 800-538-5000 • (408) 995-5430 • FAX (408) 275-8415 • Telex 171-110

© COPYRIGHT 1986 JDR MICRODEVICES

THE JDR MICRODEVICES LOGO IS A REGISTERED TRADEMARK OF JDR MICRODEVICES. JDR INSTRUMENTS AND JDR MICRODEVICES ARE TRADEMARKS OF JDR MICRODEVICES. IBM IS A TRADEMARK OF INTERNATIONAL BUSINESS MACHINES.

# 20MB HARD DISK SYSTEM ONLY \$38995!

## STATIC RAMS

|             |        |                   |      |
|-------------|--------|-------------------|------|
| 2101        | 256x4  | (450ns)           | 1.95 |
| 5101        | 256x4  | (450ns)(CMOS)     | 3.65 |
| 2102L-4     | 1024x1 | (450ns)(LP)       | .99  |
| 2112        | 256x4  | (450ns)           | 2.99 |
| 2114        | 1024x4 | (450ns)           | .99  |
| 2114L-4     | 1024x4 | (450ns)(LP)       | 1.09 |
| 2114L-75    | 1024x4 | (200ns)(LP)       | 1.49 |
| 2114L-15    | 1024x4 | (150ns)(LP)       | 1.95 |
| TMS4044-4   | 4096x1 | (150ns)           | 1.95 |
| TMM2016-160 | 2048x8 | (150ns)           | 1.49 |
| TMM2016-100 | 2048x8 | (100ns)           | 1.95 |
| HMB116-4    | 2048x8 | (200ns)(CMOS)     | 1.69 |
| HMB116-3    | 2048x8 | (150ns)(CMOS)     | 1.95 |
| HMB116P-4   | 2048x8 | (200ns)(CMOS)(LP) | 1.95 |
| HMB116P-3   | 2048x8 | (150ns)(CMOS)(LP) | 2.05 |
| HMB116LP-2  | 2048x8 | (120ns)(CMOS)(LP) | 2.95 |
| HMB264P-15  | 8192x8 | (150ns)(CMOS)     | 3.69 |
| HMB264LP-15 | 8192x8 | (150ns)(CMOS)(LP) | 3.95 |
| HMB264LP-12 | 8192x8 | (120ns)(CMOS)(LP) | 4.49 |

LP=Low power

## DYNAMIC RAMS

|              |          |                      |      |
|--------------|----------|----------------------|------|
| 4116-250     | 16384x1  | (250ns)              | .49  |
| 4116-200     | 16384x1  | (200ns)              | .89  |
| 4116-150     | 16384x1  | (150ns)              | .99  |
| 4116-120     | 16384x1  | (120ns)              | 1.49 |
| MK4332       | 32768x1  | (200ns)              | 8.95 |
| 4164-200     | 65536x1  | (200ns)(5v)          | 1.19 |
| 4164-150     | 65536x1  | (150ns)(5v)          | 1.29 |
| 4164-120     | 65536x1  | (120ns)(5v)          | 1.95 |
| MCM6665      | 8192x8   | (150ns)(CMOS)        | 1.95 |
| TMS4164      | 65536x1  | (150ns)(5v)          | 1.95 |
| 4164-REFRESH | 65536x1  | (150ns)(5v)(REFRESH) | 2.95 |
| TMS4416      | 16384x4  | (150ns)(5v)          | 4.95 |
| 41128-150    | 131072x1 | (150ns)(5v)          | 5.95 |
| TMS4464-15   | 65536x4  | (150ns)(5v)          | 6.95 |
| 41258-200    | 262144x1 | (200ns)(5v)          | 2.95 |
| 41258-150    | 262144x1 | (150ns)(5v)          | 2.95 |

5v=Single 5 Volt Supply

REFRESH=Pin 1 Refresh

## ★★★★ HIGH-TECH ★★★★★

### NEC V20 UPD70108 \$1195

REPLACES 8088 TO SPEED UP IBM PC 10-40%

- \* HIGH-SPEED ADDRESS CALCULATION IN HARDWARE
- \* PIN COMPATIBLE WITH 8088
- \* SUPERSET OF 8088 INSTRUCTION SET
- \* LOW POWER CMOS

8MHz V20 UPD70108-8 \$13.95

8MHz V30 UPD70116-8 \$19.95

## ★★★★ SPOTLIGHT ★★★★★

# ORDER TOLL FREE 800-538-5000



## EPROMS

|          |         |                      |       |
|----------|---------|----------------------|-------|
| 2708     | 1024x8  | (450ns)              | 4.95  |
| 2716     | 2048x8  | (450ns)(5V)          | 3.49  |
| 2716-1   | 2048x8  | (350ns)              | 3.95  |
| TMS2632  | 4096x8  | (450ns)(5V)          | 5.95  |
| 2732     | 4096x8  | (450ns)(5V)          | 3.95  |
| 2732A    | 4096x8  | (250ns)(5V)(21V PGM) | 3.95  |
| 2732A-2  | 4096x8  | (200ns)(5V)(21V PGM) | 4.25  |
| 27C64    | 8192x8  | (250ns)(5V)(CMOS)    | 5.95  |
| 2764     | 8192x8  | (450ns)(5V)          | 3.49  |
| 2764-250 | 8192x8  | (250ns)(5V)          | 3.95  |
| 2764-200 | 8192x8  | (200ns)(5V)          | 4.25  |
| MCM66766 | 8192x8  | (350ns)(5V)(24 PIN)  | 17.95 |
| 27128    | 16384x8 | (250ns)(5V)          | 4.25  |
| 27C256   | 32768x8 | (250ns)(5V)(CMOS)    | 10.95 |
| 27256    | 32768x8 | (250ns)(5V)          | 7.49  |

5V=Single 5 Volt Supply

21V PGM=Program at 21 Volts

## SPECTRONICS CORPORATION EPROM ERASERS



| Model  | Timer | Capacity Chip | Intensity (uW/cm <sup>2</sup> ) | Unit Price |
|--------|-------|---------------|---------------------------------|------------|
| PE-14  | NO    | 9             | 8,000                           | \$83.00    |
| PE-14T | YES   | 9             | 8,000                           | \$119.00   |
| PE-24T | YES   | 12            | 9,600                           | \$175.00   |

## 8000

|        |        |
|--------|--------|
| 8035   | 1.49   |
| 8039   | 1.95   |
| 8080   | 2.95   |
| 8085   | 2.49   |
| 8087-2 | 169.95 |
| 8087   | 129.00 |
| 8088   | 6.95   |
| 8088-2 | 9.95   |
| 8155   | 2.49   |
| 8155-2 | 3.95   |
| 8748   | 7.95   |
| 8755   | 14.95  |
| 80286  | 129.95 |
| 80287  | 159.95 |

## 8200

|        |       |
|--------|-------|
| 8203   | 24.95 |
| 8205   | 3.29  |
| 8212   | 1.49  |
| 8216   | 1.49  |
| 8224   | 2.25  |
| 8237   | 4.95  |
| 8237-5 | 6.49  |
| 8250   | 6.95  |
| 8251   | 1.89  |
| 8251A  | 1.89  |
| 8253   | 1.89  |
| 8253-5 | 1.95  |
| 8255   | 1.89  |
| 8255-5 | 1.89  |
| 8259   | 1.95  |
| 8259-5 | 2.25  |
| 8272   | 4.95  |
| 8279   | 2.49  |
| 8279-5 | 2.95  |
| 8282   | 2.95  |
| 8284   | 3.95  |
| 8286   | 3.95  |
| 8288   | 4.95  |

## Z-80

|           |      |
|-----------|------|
| Z80-CPU   | 1.79 |
| Z80-CTC   | 1.89 |
| Z80-DART  | 5.95 |
| Z80-DMA   | 5.95 |
| Z80-FIO   | 1.89 |
| Z80-SIO/0 | 5.95 |
| Z80-SIO/1 | 5.95 |
| Z80-SIO/2 | 5.95 |

## 8.0 MHz

|             |       |
|-------------|-------|
| Z80B-CPU    | 3.75  |
| Z80B-CTC    | 4.25  |
| Z80B-FIO    | 4.25  |
| Z80B-DART   | 14.95 |
| Z80B-SIO/0  | 12.95 |
| Z80B-SIO/2  | 12.95 |
| Z8671 ZILOG | 19.95 |

## 6500

|              |       |
|--------------|-------|
| 6502         | 2.69  |
| 65C02 (CMOS) | 12.95 |
| 6507         | 9.95  |
| 6520         | 1.95  |
| 6522         | 4.95  |
| 6526         | 26.95 |
| 6532         | 6.95  |
| 6546         | 6.95  |
| 6551         | 5.95  |
| 6561         | 19.95 |
| 6581         | 34.95 |

## 2.0 MHz

|       |       |
|-------|-------|
| 6502A | 2.95  |
| 6520A | 2.95  |
| 6522A | 5.95  |
| 6532A | 11.95 |
| 6546A | 7.95  |
| 6551A | 6.95  |

## 3.0 MHz

|       |      |
|-------|------|
| 6502B | 6.95 |
|-------|------|

## 6800

|       |       |
|-------|-------|
| 6800  | 1.95  |
| 6802  | 4.95  |
| 6803  | 9.95  |
| 6809  | 5.95  |
| 6809E | 5.95  |
| 6810  | 1.95  |
| 6820  | 2.95  |
| 6821  | 1.95  |
| 6840  | 6.95  |
| 6843  | 19.95 |
| 6844  | 12.95 |
| 6845  | 4.95  |
| 6846  | 9.95  |
| 6847  | 11.95 |
| 6850  | 1.95  |
| 6853  | 22.95 |

## 2.0 MHz

|        |      |
|--------|------|
| 68000  | 4.95 |
| 68002  | 5.95 |
| 68009E | 6.95 |
| 68009  | 6.95 |
| 68021  | 3.95 |
| 68048  | 6.95 |
| 68050  | 2.95 |
| 68054  | 7.95 |

## CLOCK CIRCUITS

|            |       |
|------------|-------|
| MM5369     | 1.95  |
| MM5369-EST | 1.95  |
| MM58167    | 12.95 |
| MM58174    | 11.95 |
| MSM5832    | 2.95  |

## CRT CONTROLLERS

|           |       |
|-----------|-------|
| 6845      | 4.95  |
| 6846      | 8.95  |
| 6847      | 11.95 |
| HD46505SP | 6.95  |
| MC1372    | 2.95  |
| 8275      | 26.95 |
| 7220      | 19.95 |
| 4.032     | 1.95  |
| 5.0       | 1.95  |
| 5.0688    | 1.95  |
| 6.0       | 1.95  |
| 6.144     | 1.95  |
| 6.5536    | 1.95  |
| 8.0       | 1.95  |
| 10.0      | 1.95  |
| 10.738636 | 1.95  |
| 12.0      | 1.95  |
| 14.31818  | 1.95  |
| 15.0      | 1.95  |
| 16.0      | 1.95  |
| 17.330    | 1.95  |
| 17.430    | 1.95  |
| 18.0      | 1.95  |
| 18.432    | 1.95  |
| 2.0       | 1.95  |
| 22.1184   | 1.95  |
| 24.0      | 1.95  |
| 32.0      | 1.95  |

## DISK CONTROLLERS

|        |       |
|--------|-------|
| 1771   | 4.95  |
| 1791   | 8.95  |
| 1793   | 9.95  |
| 1795   | 12.95 |
| 1797   | 12.95 |
| 1799   | 19.95 |
| 2793   | 19.95 |
| 2797   | 29.95 |
| 6843   | 19.95 |
| 8272   | 4.95  |
| UPD765 | 4.95  |
| MB8876 | 12.95 |
| 1691   | 6.95  |
| 2143   | 6.95  |

## BIT RATE GENERATORS

|         |      |
|---------|------|
| MC14411 | 9.95 |
| BR1941  | 4.95 |
| 4703    | 9.95 |
| COM8116 | 8.95 |
| MMS307  | 4.95 |

## UARTS

|          |      |
|----------|------|
| AY5-1013 | 3.95 |
| AY3-1015 | 4.95 |
| TR1602   | 3.95 |
| 2651     | 4.95 |
| IM6402   | 6.95 |
| IM6403   | 9.95 |
| INS9250  | 6.95 |

## SOUND CHIPS

|          |       |
|----------|-------|
| 76477    | 5.95  |
| 78489    | 8.95  |
| SS1-263  | 39.95 |
| AY3-8910 | 12.95 |
| AY3-8912 | 12.95 |
| SP1900   | 39.00 |

## CRYSTALS

|            |      |
|------------|------|
| 32.768 KHz | .95  |
| 1.0 MHz    | 2.95 |
| 1.8432     | 2.95 |
| 2.0        | 1.95 |
| 2.097152   | 1.95 |
| 2.4576     | 1.95 |
| 3.2768     | 1.95 |
| 3.579548   | 1.95 |
| 4.0        | 1.95 |
| 4.032      | 1.95 |
| 5.0        | 1.95 |
| 5.0688     | 1.95 |
| 6.0        | 1.95 |
| 6.144      | 1.95 |
| 6.5536     | 1.95 |
| 8.0        | 1.95 |
| 10.0       | 1.95 |
| 10.738636  | 1.95 |
| 12.0       | 1.95 |
| 14.31818   | 1.95 |
| 15.0       | 1.95 |
| 16.0       | 1.95 |
| 17.330     | 1.95 |
| 17.430     | 1.95 |
| 18.0       | 1.95 |
| 18.432     | 1.95 |
| 2.0        | 1.95 |
| 22.1184    | 1.95 |
| 24.0       | 1.95 |
| 32.0       | 1.95 |

## CRYSTAL OSCILLATORS

|        |      |
|--------|------|
| 1.0MHz | 5.95 |
| 1.8432 | 5.95 |
| 2.0    | 5.95 |
| 2.4576 | 5.95 |
| 2.5    | 4.95 |
| 4.0    | 4.95 |
| 5.0688 | 4.95 |
| 6.0    | 4.95 |
| 6.144  | 4.95 |
| 8.0    | 4.95 |
| 10.0   | 4.95 |
| 12.0   | 4.95 |
| 12.480 | 4.95 |
| 15.0   | 4.95 |
| 16.0   | 4.95 |
| 18.432 | 4.95 |
| 20.0   | 4.95 |
| 24.0   | 4.95 |

## MISC.

|              |       |
|--------------|-------|
| TMS99531     | 9.95  |
| TMS99532     | 19.95 |
| ULN2003      | .79   |
| 3242         | 7.95  |
| 3341         | 4.95  |
| MC3470       | 1.95  |
| MC3480       | 8.95  |
| MC3487       | 2.95  |
| 11C90        | 19.95 |
| 2513-001 UP  | 6.95  |
| AY5-2376     | 11.95 |
| AY5-3600 PHC | 11.95 |

## 74LS00

|         |      |
|---------|------|
| 74LS00  | .16  |
| 74LS01  | .18  |
| 74LS02  | .17  |
| 74LS03  | .18  |
| 74LS04  | .16  |
| 74LS05  | .18  |
| 74LS08  | .18  |
| 74LS09  | .18  |
| 74LS10  | .16  |
| 74LS11  | .22  |
| 74LS12  | .22  |
| 74LS13  | .26  |
| 74LS14  | .39  |
| 74LS15  | .26  |
| 74LS20  | .17  |
| 74LS21  | .22  |
| 74LS22  | .22  |
| 74LS23  | .23  |
| 74LS28  | .26  |
| 74LS30  | .17  |
| 74LS32  | .18  |
| 74LS33  | .28  |
| 74LS37  | .26  |
| 74LS36  | .26  |
| 74LS42  | .39  |
| 74LS47  | .75  |
| 74LS48  | .85  |
| 74LS51  | .17  |
| 74LS73  | .29  |
| 74LS74  | .29  |
| 74LS75  | .29  |
| 74LS76  | .29  |
| 74LS83  | .49  |
| 74LS85  | .49  |
| 74LS86  | .22  |
| 74LS90  | .39  |
| 74LS92  | .49  |
| 74LS93  | .39  |
| 74LS95  | .49  |
| 74LS107 | .34  |
| 74LS109 | .39  |
| 74LS112 | .28  |
| 74LS122 | .45  |
| 74LS123 | .49  |
| 74LS124 | .75  |
| 74LS125 | .39  |
| 74LS126 | .39  |
| 74LS132 | .39  |
| 74LS133 | .49  |
| 74LS136 | .39  |
| 74LS138 | .39  |
| 74LS139 | .39  |
| 74LS146 | .99  |
| 74LS147 | .99  |
| 74LS148 | .99  |
| 74LS151 | .39  |
| 74LS153 | .39  |
| 74LS154 | 1.49 |
| 74LS155 | .99  |
| 3341    | .49  |
| 74LS156 | .35  |
| 74LS158 | .29  |
| 74LS160 | .29  |
| 74LS161 | .39  |
| 74LS162 | .49  |
| 74LS163 | .39  |
| 74LS164 | .49  |

## 74LS165

|         |     |
|---------|-----|
| 74LS165 | .65 |
| 74LS1   |     |

# 20MB HARD DISK SYSTEM ONLY \$38995!

## CMOS

|       |      |        |       |
|-------|------|--------|-------|
| 4001  | .19  | 14419  | 4.95  |
| 4011  | .19  | 14433  | 14.95 |
| 4012  | .25  | 4903   | .49   |
| 4013  | .35  | 4511   | .69   |
| 4015  | .29  | 4516   | .79   |
| 4016  | .29  | 4518   | .85   |
| 4017  | .49  | 4522   | .79   |
| 4018  | .69  | 4526   | .79   |
| 4020  | .59  | 4527   | 1.95  |
| 4021  | .69  | 4528   | .79   |
| 4024  | .49  | 4529   | 2.95  |
| 4025  | .25  | 4532   | 1.95  |
| 4027  | .39  | 4538   | .95   |
| 4028  | .65  | 4541   | 1.29  |
| 4035  | .69  | 4553   | 5.79  |
| 4040  | .69  | 4583   | .75   |
| 4041  | .75  | 4702   | 12.95 |
| 4042  | .59  | 74C00  | .29   |
| 4043  | .85  | 74C14  | .59   |
| 4044  | .69  | 74C74  | .59   |
| 4045  | 1.95 | 74C83  | 1.95  |
| 4046  | .69  | 74C85  | 1.49  |
| 4047  | .69  | 74C85  | .99   |
| 4049  | .29  | 74C150 | 5.75  |
| 4050  | .29  | 74C151 | 2.25  |
| 4051  | .69  | 74C161 | .99   |
| 4052  | .69  | 74C163 | .99   |
| 4053  | .69  | 74C164 | 1.39  |
| 4056  | 2.19 | 74C182 | 1.49  |
| 4060  | .69  | 74C193 | 1.49  |
| 4066  | .29  | 74C221 | 2.49  |
| 4069  | .19  | 74C240 | 1.89  |
| 4075  | .59  | 74C244 | 1.89  |
| 4077  | .29  | 74C374 | 1.99  |
| 4081  | .22  | 74C905 | 10.95 |
| 4085  | .79  | 74C911 | 8.95  |
| 4086  | .89  | 74C917 | 12.95 |
| 4093  | .49  | 74C922 | 4.49  |
| 4094  | 2.49 | 74C923 | 4.95  |
| 14411 | 8.95 | 74C926 | 7.95  |
| 14412 | 6.25 | 80C37  | .95   |

## 7400/9000

|       |      |       |      |
|-------|------|-------|------|
| 7400  | .19  | 74147 | 2.49 |
| 7402  | .19  | 74148 | 1.20 |
| 7404  | .19  | 74150 | 1.35 |
| 7406  | .29  | 74151 | .55  |
| 7407  | .29  | 74153 | .55  |
| 7408  | .24  | 74154 | 1.49 |
| 7410  | .19  | 74155 | .75  |
| 7411  | .25  | 74157 | .55  |
| 7414  | .49  | 74158 | 1.85 |
| 7416  | .25  | 74161 | .69  |
| 7417  | .25  | 74163 | .89  |
| 7420  | .19  | 74164 | .85  |
| 7423  | .29  | 74165 | .85  |
| 7430  | .19  | 74166 | 1.00 |
| 7432  | .29  | 74175 | .89  |
| 7438  | .29  | 74177 | .75  |
| 7442  | .49  | 74178 | 1.15 |
| 7445  | .69  | 74181 | 2.25 |
| 7447  | .89  | 74182 | .75  |
| 7470  | .35  | 74184 | 2.00 |
| 7473  | .34  | 74191 | 1.15 |
| 7474  | .33  | 74192 | 1.15 |
| 7475  | .45  | 74194 | .85  |
| 7476  | .35  | 74196 | .75  |
| 7483  | .50  | 74197 | .75  |
| 7485  | .59  | 74199 | 1.35 |
| 7486  | .35  | 74221 | 1.35 |
| 7489  | 2.15 | 74246 | 1.35 |
| 7490  | .39  | 74247 | 1.25 |
| 7492  | .50  | 74248 | 1.85 |
| 7493  | .35  | 74249 | 1.95 |
| 7495  | .55  | 74251 | .75  |
| 7497  | 2.75 | 74255 | 1.35 |
| 74100 | 2.29 | 74273 | 1.95 |
| 74121 | .29  | 74278 | 3.11 |
| 74123 | .49  | 74367 | .65  |
| 74125 | .45  | 74388 | .65  |
| 74141 | .65  | 8368  | 3.95 |
| 74143 | 5.95 | 9602  | 1.50 |
| 74144 | 2.95 | 9637  | 2.95 |
| 74145 | .60  | 96502 | 1.95 |

## 74S00

|        |      |        |      |
|--------|------|--------|------|
| 74S00  | .29  | 74S163 | 1.29 |
| 74S02  | .29  | 74S168 | 3.95 |
| 74S03  | .29  | 74S174 | .79  |
| 74S04  | .29  | 74S176 | .79  |
| 74S05  | .29  | 74S188 | 1.95 |
| 74S06  | .35  | 74S189 | 1.95 |
| 74S10  | .29  | 74S195 | 2.49 |
| 74S15  | .49  | 74S196 | 2.49 |
| 74S30  | .29  | 74S197 | 2.95 |
| 74S32  | .35  | 74S226 | 3.95 |
| 74S37  | .69  | 74S240 | 1.49 |
| 74S38  | .69  | 74S241 | 1.49 |
| 74S74  | .49  | 74S244 | 1.49 |
| 74S85  | .95  | 74S257 | .79  |
| 74S86  | .35  | 74S253 | .79  |
| 74S112 | .50  | 74S256 | .95  |
| 74S124 | 2.75 | 74S260 | 1.95 |
| 74S138 | .79  | 74S267 | 1.69 |
| 74S140 | .55  | 74S268 | 1.69 |
| 74S151 | .79  | 74S299 | 2.95 |
| 74S153 | .79  | 74S373 | 1.69 |
| 74S157 | .79  | 74S374 | 1.69 |
| 74S158 | .95  | 74S471 | 4.95 |
| 74S161 | 1.29 | 74S571 | 2.95 |

## VOLTAGE REGULATORS

| TO-220 CASE        |             |       |      |
|--------------------|-------------|-------|------|
| 7805T              | .49         | 7905T | .59  |
| 7808T              | .49         | 7908T | .59  |
| 7812T              | .49         | 7912T | .59  |
| 7815T              | .49         | 7915T | .59  |
| TO-3 CASE          |             |       |      |
| 7805K              | 1.59        | 7905K | 1.69 |
| 7812K              | 1.39        | 7912K | 1.49 |
| TO-93 CASE         |             |       |      |
| 78L05              | .49         | 79L06 | .69  |
| 78L12              | .49         | 79L12 | 1.49 |
| OTHER VOLTAGE REGS |             |       |      |
| LM323K             | 5V 3A TO-3  | 4.79  |      |
| LM328K             | ADJ 5A TO-3 | 3.95  |      |
| 78H05K             | 5V 5A TO-3  | 7.95  |      |
| 78H12K             | 12V 5A TO-3 | 6.95  |      |
| 78P05K             | 5V 10A TO-3 | 14.95 |      |

## LINEAR

|                             |      |         |      |
|-----------------------------|------|---------|------|
| TL066                       | .99  | LM733   | .98  |
| TL071                       | .69  | LM741   | .29  |
| TL072                       | 1.09 | LM747   | .69  |
| TL074                       | 1.95 | LM748   | .59  |
| TL081                       | .59  | MC1320  | 1.69 |
| TL082                       | .99  | MC1350  | 1.19 |
| TL084                       | 1.49 | MC1372  | 6.95 |
| LM301                       | .34  | LM1414  | 1.59 |
| LM305K                      | 1.75 | LM1468  | .49  |
| LM311                       | .69  | LM1488  | .49  |
| LM311H                      | .89  | LM1489  | .49  |
| LM317K                      | 3.49 | LM1498  | .85  |
| LM317T                      | .95  | LM1812  | 2.25 |
| LM318                       | 1.49 | LM1859  | 1.95 |
| LM319                       | 1.25 | ULN2003 | .79  |
| LM330                       | 2.95 | 79C00   | 3.95 |
| LM332                       | 1.95 | XR2211  | 2.95 |
| LM323K                      | 4.79 | XR2240  | 1.95 |
| LM324                       | .49  | MPQ2907 | 1.95 |
| LM331                       | 3.95 | LM2917  | 1.95 |
| LM334                       | 1.19 | CA3048  | .89  |
| LM335                       | 1.79 | CA3081  | .99  |
| LM336                       | 1.75 | CA3082  | .99  |
| LM337K                      | 3.95 | CA3085  | .80  |
| LM338K                      | 6.95 | CA3089  | 1.95 |
| LM339                       | .59  | CA3130E | .99  |
| LM340                       | 7.99 | CA3146  | 1.29 |
| LM350T                      | 4.60 | CA3160  | 1.19 |
| LF353                       | .59  | MC3470  | 1.95 |
| LF356                       | .99  | MC3480  | 8.95 |
| LF357                       | .99  | MC3487  | 2.95 |
| LM358                       | .59  | LM3590  | 1.49 |
| LM380                       | .89  | LM3909  | .98  |
| LM393                       | 1.95 | LM3911  | 2.25 |
| LM386                       | .69  | LM3924  | 2.39 |
| LM393                       | .45  | MC4004  | 3.99 |
| LM394H                      | 5.95 | MC4044  | 3.99 |
| TL494                       | 4.20 | RC4136  | 1.26 |
| TL497                       | 3.25 | RC4558  | .69  |
| NE555                       | .25  | LM3360  | 1.49 |
| NE556                       | .49  | 75107   | 1.49 |
| NE558                       | 1.29 | 75110   | 1.95 |
| NE564                       | 1.95 | 75150   | 1.95 |
| LM565                       | .95  | 75154   | 1.95 |
| LM566                       | 1.49 | 75188   | 1.26 |
| LM567                       | .79  | 75189   | 1.25 |
| NE570                       | 2.95 | 75451   | .39  |
| NE590                       | 2.50 | 75452   | .39  |
| NE592                       | .98  | 75453   | .39  |
| LM710                       | .75  | 75477   | 1.29 |
| LM723                       | .49  | 75492   | .79  |
| H-TO-5 CAN, K-TO-3, T-TO-20 |      |         |      |

## DATA ACO INTERFACE

|          |       |        |      |
|----------|-------|--------|------|
| ADC0800  | 15.55 | 8T26   | 1.29 |
| ADC0804  | 3.49  | 8T28   | 1.29 |
| ADC0809  | 4.49  | 8T35   | .85  |
| ADC0816  | 14.95 | 8T36   | .85  |
| ADC0817  | 9.95  | 8T37   | .59  |
| ADC0831  | 8.95  | 8T38   | .89  |
| DAC0800  | 4.49  | DM8131 | 2.95 |
| DAC0806  | 1.95  | DP8304 | 2.29 |
| DAC0808  | 2.95  | DS8323 | 2.25 |
| DAC1020  | 8.25  | DS8535 | 1.99 |
| DAC1022  | 5.95  | DS8538 | .99  |
| MC1408L8 | 2.95  | DS8537 | 1.65 |

## IC SOCKETS

| 8 PIN ST                             | .11  | 100- |
|--------------------------------------|------|------|
| 14 PIN ST                            | .11  | .09  |
| 16 PIN ST                            | .12  | .10  |
| 18 PIN ST                            | .15  | .13  |
| 20 PIN ST                            | .18  | .15  |
| 22 PIN ST                            | .15  | .12  |
| 24 PIN ST                            | .20  | .15  |
| 28 PIN ST                            | .22  | .16  |
| 40 PIN ST                            | .30  | .22  |
| 64 PIN ST                            | 1.95 | 1.49 |
| ST-SOLDER TAIL                       |      |      |
| 8 PIN WW                             | .59  | .69  |
| 14 PIN WW                            | .69  | .62  |
| 16 PIN WW                            | .69  | .68  |
| 18 PIN WW                            | .95  | .90  |
| 20 PIN WW                            | 1.09 | .98  |
| 22 PIN WW                            | 1.39 | 1.28 |
| 24 PIN WW                            | 1.49 | 1.35 |
| 28 PIN WW                            | 1.69 | 1.49 |
| 40 PIN WW                            | 1.99 | 1.80 |
| WW-WIREWRAP                          |      |      |
| 16 PIN ZIF                           | 4.95 | CALL |
| 24 PIN ZIF                           | 5.95 | CALL |
| 28 PIN ZIF                           | 6.95 | CALL |
| 40 PIN ZIF                           | 9.95 | CALL |
| ZIF-TEXT TOOL (ZERO INSERTION FORCE) |      |      |

## EDGECARD CONNECTORS

|            |        |      |      |
|------------|--------|------|------|
| 100 PIN ST | S-100  | .125 | 3.95 |
| 100 PIN WW | S-100  | .125 | 4.35 |
| 62 PIN ST  | IBM PC | 1.00 | 1.95 |
| 50 PIN ST  | APPLE  | 1.00 | 2.95 |
| 44 PIN ST  | STD    | .156 | 1.95 |
| 44 PIN WW  | STD    | .156 | 4.95 |

## 36 PIN CENTRONICS

| MALE      |                   |      |
|-----------|-------------------|------|
| IDCEN36   | RIBBON CABLE      | 6.95 |
| CEN36     | SOLDER CUP        | 4.95 |
| FEMALE    |                   |      |
| IDCEN36/F | RIBBON CABLE      | 7.95 |
| CEN36/C   | RT ANGLE PC MOUNT | 4.95 |

## INTERSIL

|          |       |
|----------|-------|
| ICL7106  | 9.95  |
| ICL7107  | 12.95 |
| ICL7660  | 2.95  |
| ICL8038  | 4.95  |
| ICM7207A | 5.95  |
| ICM7208  | 15.95 |

## DIP CONNECTORS

| DESCRIPTION                           | ORDER BY  | CONTACTS |      |      |      |      |      |      |      |      |
|---------------------------------------|-----------|----------|------|------|------|------|------|------|------|------|
|                                       |           | 8        | 14   | 16   | 18   | 20   | 22   | 24   | 28   | 40   |
| HIGH RELIABILITY TOOLED ST IC SOCKETS | AUGATxxST | .62      | .79  | .89  | 1.09 | 1.29 | 1.39 | 1.49 | 1.69 | 2.49 |
| HIGH RELIABILITY TOOLED WW IC SOCKETS | AUGATxxWW | 1.30     | 1.80 | 2.10 | 2.40 | 2.50 | 2.90 | 3.15 | 3.70 | 5.40 |
| COMPONENT CARRIES (DIP HEADERS)       | ICCKxx    | .49      | .59  | .69  | .99  | .99  | .99  | 1.09 | 1.49 |      |
| RIBBON CABLE DIP PLUGS (IDC)          | IDPxx     | ---      | .95  | .95  | ---  | ---  | ---  | 1.75 | ---  | 2.95 |

FOR ORDERING INSTRUCTIONS SEE D-SUBMINIATURE BELOW

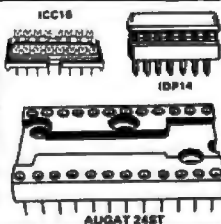

## DIODES/OPTO/TRANSISTORS

|         |         |         |      |
|---------|---------|---------|------|
| 1N751   | .25     | 4N26    | .69  |
| 1N759   | .25     | 4N27    | .69  |
| 1N4148  | 25/1,00 | 4N28    | .69  |
| 1N4004  | 10/1,00 | 4N33    | .89  |
| 1N5402  | .25     | 4N37    | 1.19 |
| K8P04   | .55     | MCT-2   | .59  |
| K8L04   | .95     | MCT-5   | 1.29 |
| MDS90-2 | .35     | TIL-111 | ---  |
| N2222   | .25     | 2N3906  | .10  |
| PN2222  | .10     | 2N4401  | .25  |
| 2N2905  | .50     | 2N4402  | .25  |
| 2N2907  | .25     | 2N4403  | .25  |
| 2N3055  | .79     | 2N6045  | 1.75 |
| 2N3904  | .10     | TIP31   | .49  |

## D-SUBMINIATURE

| DESCRIPTION           | ORDER BY | CONTACTS |      |      |      |      |      |      |
|-----------------------|----------|----------|------|------|------|------|------|------|
|                       |          | 9        | 15   | 19   | 25   | 37   | 50   |      |
| SOLDER CUP            | MALE     | DBxxP    | .82  | .90  | 1.25 | 1.25 | 1.80 | 3.48 |
|                       | FEMALE   | DBxxS    | .95  | 1.15 | 1.50 | 1.50 | 2.35 | 4.32 |
| RIGHT ANGLE PC SOLDER | MALE     | DBxxPR   | 1.20 | 1.49 | ---  | 1.95 | 2.65 | ---  |
|                       | FEMALE   | DBxxSR   | 1.25 | 1.55 | ---  | 2.00 | 2.79 | ---  |
| WIRE WRAP             | MALE     | DBxxPWW  | 1.69 | 2.57 | ---  | 3.89 | 5.60 | ---  |
|                       | FEMALE   | DBxxSww  | 2.76 | 4.26 | ---  | 6.84 | 9.95 | ---  |
| IDC RIBBON CABLE      | MALE     | IDBxxP   | 2.70 | 2.95 | ---  | 3.98 | 5.70 | ---  |
|                       | FEMALE   | IDBxxS   | 2.92 | 3.20 | ---  | 4.33 | 6.76 | ---  |
| HOODS                 | METAL    | MHOODxx  | 1.25 | 1.25 | 1.30 | 1.30 | ---  | ---  |
|                       | GREY     | HOODxx   | .65  | .65  | ---  | .65  | .75  | .95  |

ORDERING INSTRUCTIONS: INSERT THE NUMBER OF CONTACTS IN THE POSITION MARKED 'xx' OF THE 'ORDER BY' PART NUMBER LISTED

EXAMPLE: A 15 PIN RIGHT ANGLE MALE PC SOLDER WOULD BE DB15PR

**MOUNTING HARDWARE \$1.00**

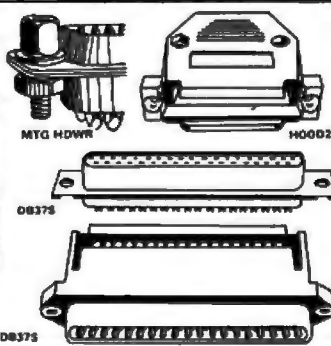

## IDC CONNECTORS

| DESCRIPTION               | ORDER BY | CONTACTS |      |      |      |      |      |
|---------------------------|----------|----------|------|------|------|------|------|
|                           |          | 10       | 20   | 26   | 34   | 40   | 50   |
| SOLDER HEADER             | IDHxxS   | .82      | 1.29 | 1.68 | 2.20 | 2.58 | 3.24 |
| RIGHT ANGLE SOLDER HEADER | IDHxxSR  | .85</    |      |      |      |      |      |

# 20MB HARD DISK SYSTEM ONLY \$38995!

## BARGAIN HUNTERS CORNER ATTENTION PC USERS! 10 MB HARD DISK SYSTEM \$349

- \* SHOCK MOUNTED FOR 80 Gs—IDEAL FOR PORTABLE
- \* MMI MODEL MM21 1/2" HEIGHT, 75ms ACCESS
- \* INCLUDES CONTROLLER, CABLES & INSTRUCTIONS FOR IBM

## WIRELESS KEYBOARD \$129

- \* MADE BY CHERRY FOR IBM PC & PCjr
- \* OPERATES UP TO 40 FEET FROM COMPUTER
- \* INFRARED RECEIVER FOR PC XT INCLUDED

HURRY—QUANTITIES ARE LIMITED!  
SPECIALS END 9/30/86

## PAGE WIRE WRAP WIRE PRECUT ASSORTMENT IN ASSORTED COLORS \$27.50

100cs: 5.5", 6.0", 6.5", 7.0"  
250cs: 2.5", 4.5", 5.0"  
500cs: 3.0", 3.5", 4.0"

### SPOOLS

100 feet \$4.30 250 feet \$7.25  
500 feet \$13.25 1000 feet \$21.95

Please specify color:  
Blue, Black, Yellow or Red

## EMI FILTER \$4.95

- MANUFACTURED BY CORCOM
- LOW COST
- FITS LC-HP BELOW
- 6 AMP 120/240 VOLT



### 6 FOOT LINE CORDS

LC-2 2 CONDUCTOR .39  
LC-3 3 CONDUCTOR .99  
LC-HP 3 CONDUCTOR W/STD FEMALE SOCKET 1.49

### MUFFIN FANS

3.18" SQ ROTRON 14.95  
3.63" SQ ETRI 14.95  
3.18" SQ MASUSHITA 16.95

## WIRE WRAP PROTOTYPE CARDS FR-4 EPOXY GLASS LAMINATE WITH GOLD-PLATED EDGE-CARD FINGERS



IBM-PR2

### IBM

BOTH CARDS HAVE SILK SCREENED LEGENDS AND INCLUDES MOUNTING BRACKET

IBM-PR1 WITH +5V AND GROUND PLANE . . . . \$27.95  
IBM-PR2 AS ABOVE WITH DECODING LAYOUT \$29.95

### S-100

P100-1 BARE - NO FOIL PADS . . . . . \$15.15  
P100-2 HORIZONTAL BUS . . . . . \$21.80  
P100-3 VERTICAL BUS . . . . . \$21.80  
P100-4 SINGLE FOIL PADS PER HOLE . . . . . \$22.75

### APPLE

P500-1 BARE - NO FOIL PADS . . . . . \$15.15  
P500-3 HORIZONTAL BUS . . . . . \$22.75  
P500-4 SINGLE FOIL PADS PER HOLE . . . . . \$21.80  
7060-45 FOR APPLE IIa AUX SLOT . . . . . \$30.00

## SOCKET-WRAP I.D.™

• SLIPS OVER WIRE WRAP PINS  
• IDENTIFIES PIN NUMBERS ON WRAP SIDE OF BOARD  
• CAN WRITE ON PLASTIC, SUCH AS IC #

| PINS | PART#     | PCK. OF | PRICE |
|------|-----------|---------|-------|
| 8    | IDWRAP 08 | 10      | 1.95  |
| 14   | IDWRAP 14 | 10      | 1.95  |
| 16   | IDWRAP 16 | 10      | 1.95  |
| 18   | IDWRAP 18 | 5       | 1.95  |
| 20   | IDWRAP 20 | 5       | 1.95  |
| 22   | IDWRAP 22 | 5       | 1.95  |
| 24   | IDWRAP 24 | 5       | 1.95  |
| 28   | IDWRAP 28 | 5       | 1.95  |
| 40   | IDWRAP 40 | 5       | 1.95  |

PLEASE ORDER BY NUMBER OF PACKAGES (PCK. OF)



## FRAME STYLE TRANSFORMERS

|             |       |       |
|-------------|-------|-------|
| 12.5V AC CT | 2 AMP | 5.95  |
| 12.6V AC CT | 4 AMP | 7.95  |
| 12.6V AC CT | 6 AMP | 10.95 |
| 25.2V AC CT | 2 AMP | 7.95  |

## 25 PIN D-SUB GENDER CHANGERS

\$7.95



## SWITCHING POWER SUPPLIES

### PS-IBM \$89.95

- FOR IBM PC-XT COMPATIBLE
- 135 WATTS
- +5V @ 15A, +12V @ 4.2A
- -5V @ .5A, -12V @ .5A
- ONE YEAR WARRANTY



### PS-IBM-150 \$79.95

- FOR IBM PC-XT COMPATIBLE
- 150 WATTS
- +12V @ 5.2A, +5V @ 16A
- -12V @ .5A, -5V @ .5A
- ONE YEAR WARRANTY



### PS-130 \$99.95

- 130 WATTS
- SWITCH ON REAR
- FOR USE IN OTHER IBM TYPE MACHINES
- 90 DAY WARRANTY



### PS-A \$49.95

- USE TO POWER APPLE TYPE SYSTEMS, 79.5 WATTS
- +5V @ 7A, +12V @ 3A
- -5V @ .5A, -12V @ .5A
- APPLE POWER CONNECTOR



### PS-SPL200 \$48.95

- +5V @ 25A, +12V @ 3.1A
- -5V @ 1A, -12V @ 1A
- UL APPROVED
- ALUMINUM ENCLOSURE



## BOOKS BY STEVE CIARCIA

|                             |         |
|-----------------------------|---------|
| BUILD YOUR OWN Z80 COMPUTER | \$19.95 |
| CIRCUIT CELLAR VOL 1        | \$17.95 |
| CIRCUIT CELLAR VOL 2        | \$18.95 |
| CIRCUIT CELLAR VOL 3        | \$18.95 |
| CIRCUIT CELLAR VOL 4        | \$18.95 |
| CIRCUIT CELLAR VOL 5        | \$19.95 |

## MICROCOMPUTER HARDWARE HANDBOOK FROM ELCOMP \$14.95

OVER 800 PAGES OF DATA SHEETS ON THE MOST COMMONLY USED ICs. INCLUDES TTL, CMOS, 74LS00, MEMORY, CPU, MPU SUPPORT. AND MUCH MORE!

## CAPACITORS

### TANTALUM

|       |          |       |         |
|-------|----------|-------|---------|
| 1.0µf | 15V .35  | .47µf | 35V .45 |
| 6.8   | 15V .70  | 1.0   | 35V .45 |
| 10    | 15V .80  | 2.2   | 35V .65 |
| 22    | 15V 1.35 | 4.7   | 35V .85 |
| .22   | 35V .40  | 10    | 35V .90 |

### DISC

|      |         |       |         |
|------|---------|-------|---------|
| 10µf | 50V .05 | 680   | 50V .05 |
| 22   | 50V .05 | .0022 | 50V .05 |
| 27   | 50V .05 | .0022 | 50V .05 |
| 33   | 50V .05 | .005  | 50V .05 |
| 47   | 50V .05 | .01   | 50V .07 |
| 68   | 50V .05 | .02   | 50V .07 |
| 100  | 50V .05 | .05   | 50V .07 |
| 220  | 50V .05 | .1    | 12V .10 |
| 560  | 50V .05 | .1    | 50V .12 |

### MONOLITHIC

|        |         |       |         |
|--------|---------|-------|---------|
| .01µf  | 60V .14 | .1µf  | 50V .15 |
| .047µf | 60V .15 | .47µf | 50V .25 |

### ELECTROLYTIC

| RADIAL |          | AXIAL |          |
|--------|----------|-------|----------|
| 1µf    | 25V .14  | 1µf   | 50V .14  |
| 2.2    | 35V .15  | 10    | 50V .18  |
| 4.7    | 50V .15  | 22    | 16V .14  |
| 10     | 50V .16  | 47    | 50V .20  |
| 47     | 35V .18  | 100   | 35V .25  |
| 100    | 16V .18  | 220   | 25V .30  |
| 220    | 35V .20  | 470   | 50V .50  |
| 470    | 25V .30  | 1000  | 16V .40  |
| 2200   | 15V .70  | 2200  | 16V .70  |
| 4700   | 25V 1.45 | 4700  | 16V 1.25 |

## DATARASE EPROM ERASER \$34.95

- ERASES 2 IN 10 MINUTES
- COMPACT-NO DRAWER
- THIN METAL SHUTTER PREVENTS UV LIGHT FROM ESCAPING



## 1/4 WATT RESISTORS

5% CARBON FILM ALL STANDARD VALUES FROM 1 OHM TO 10 MEG. OHM

|                   |      |                     |      |
|-------------------|------|---------------------|------|
| 10 PCS same value | .05  | 100 PCS same value  | .02  |
| 50 PCS same value | .025 | 1000 PCS same value | .015 |

## RESISTOR NETWORKS

|     |        |             |      |
|-----|--------|-------------|------|
| SIP | 10 PIN | 9 RESISTOR  | .69  |
| SIP | 8 PIN  | 7 RESISTOR  | .59  |
| DIP | 16 PIN | 8 RESISTOR  | 1.09 |
| DIP | 16 PIN | 15 RESISTOR | 1.09 |
| DIP | 14 PIN | 7 RESISTOR  | .99  |
| DIP | 14 PIN | 13 RESISTOR | .99  |

## SPECIALS ON BYPASS CAPACITORS

|                     |             |
|---------------------|-------------|
| .01 µf CERAMIC DISC | 100/\$5.00  |
| .01 µf MONOLITHIC   | 100/\$10.00 |
| .1 µf CERAMIC DISC  | 100/\$6.50  |
| .1 µf MONOLITHIC    | 100/\$12.50 |

## WISH SOLDERLESS BREADBOARDS

| PART NUMBER | DIMENSIONS   | DISTRIBUTION STRIPS(S) | TIE POINTS | TERMINAL STRIPS(S) | TIE POINTS | BINDING POSTS | PRICE |
|-------------|--------------|------------------------|------------|--------------------|------------|---------------|-------|
| WBU-D       | .38 x 6.50"  | 1                      | 100        | ---                | ---        | ---           | 2.95  |
| WBU-T       | 1.38 x 6.50" | ---                    | ---        | 1                  | 630        | ---           | 6.95  |
| WBU-204-3   | 3.94 x 8.45" | 1                      | 100        | 2                  | 1260       | 2             | 17.95 |
| WBU-204     | 6.13 x 8.45" | 4                      | 400        | 2                  | 1260       | 3             | 24.95 |
| WBU-206     | 6.88 x 9.06" | 5                      | 500        | 3                  | 1890       | 4             | 29.95 |
| WBU-208     | 8.26 x 9.45" | 7                      | 700        | 4                  | 2520       | 4             | 39.95 |



## LITHIUM BATTERY

AS USED IN CLOCK CIRCUITS

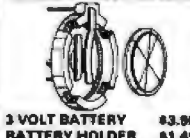

3 VOLT BATTERY \$3.95  
BATTERY HOLDER \$1.49

## NEW EDITION!

### 1986 IC MASTER

THE INDUSTRY STANDARD

## \$129.95

VISIT OUR RETAIL STORE LOCATED AT 1256 SOUTH BASCOM AVENUE IN SAN JOSE

# JDR Microdevices

1224 S. Bascom Avenue, San Jose, CA 95128  
Toll Free 800-538-5000 • (408) 995-5430  
Inquiry 184 FAX (408) 275-8415 • Telex 171-110

HOURS: M-W-F, 9-6 TU-TH, 9-9 SAT, 9-5

PLEASE USE YOUR CUSTOMER NUMBER WHEN ORDERING

TERMS: Minimum order \$10.00 For shipping and handling include \$2.50 for UPS Ground and \$3.50 for UPS Air. Orders over 1 lb. and foreign orders may require additional shipping charges. please contact our sales department for the amount. CA residents must include applicable sales tax. All merchandise is warranted for 90 days unless otherwise stated. Prices are subject to change without notice. We are not responsible for typographical errors. We reserve the right to limit quantities and to substitute manufacturer. All merchandise subject to prior sale.

# 20MB HARD DISK SYSTEM ONLY \$389.95!

## DISK DRIVES FOR APPLE COMPUTERS

**AP-150**  
**\$99.95**



- 1/2 HT, DIRECT DRIVE
- 100% APPLE COMPATIBLE
- SIX MONTH WARRANTY

**BAL-500**  
**\$129.95**



- TEAC MECHANISM-DIRECT DRIVE
- 100% APPLE COMPATIBLE
- FULL ONE YEAR WARRANTY

**AP-135**  
**\$129.95**



- FULL HT SHUGART MECHANISM
- DIRECT REPLACEMENT FOR APPLE DISK II
- SIX MONTH WARRANTY

**DOUBLE SIDED!**

**MAC535**  
**\$249.95**

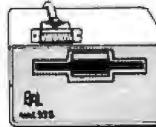

- 3.5" ADD-ON DISK DRIVE
- 100% MACINTOSH COMPATIBLE
- DOUBLE SIDED 800K BYTE STORAGE
- HIGH RELIABILITY DRIVE HAS AUTO-EJECT MECHANISM
- FULL ONE YEAR WARRANTY

**AD-3C**  
**\$139.95**

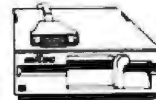

- 100% APPLE IIc COMPATIBLE
- READY TO PLUG IN, W/SHIELDED CABLE & MOLDED 19 PIN CONNECTOR
- FAST, RELIABLE SLMUNE DIRECT DRIVE
- SIX MONTH WARRANTY

### DISK DRIVE ACCESSORIES

- FDD CONTROLLER CARD \$49.95
- IIc ADAPTOR CABLE \$19.95
- ADAPTS STANDARD APPLE DRIVES FOR USE WITH APPLE IIc

**KB-1000** **\$79.95**

- CASE WITH KEYBOARD FOR APPLE TYPE MOTHERBOARD
- USER DEFINED FUNCTION KEYS
- NUMERIC KEYPAD WITH CURSOR CONTROL
- CAPS LOCK
- AUTO-REPEAT



**KEYBOARD-AP** **\$49.95**

- REPLACEMENT FOR APPLE II KEYBOARD
- CAPS LOCK KEY, AUTO-REPEAT
- ONE KEY ENTRY OF BASIC OR CP/M COMMANDS



### EXTENDER CARDS

- IBM-PC \$45.00
- IBM-AT \$68.00
- APPLE II \$45.00
- APPLE IIc \$45.00
- MULTIBUS \$86.00

## APPLE COMPATIBLE INTERFACE CARDS

**EPROM PROGRAMMER \$59.95**

**MODEL RP525**



- DUPLICATE OR BURN ANY STANDARD 27xx SERIES EPROM
- EASY TO USE MENU-DRIVEN SOFTWARE IS INCLUDED
- MENU SELECTION FOR 2716, 2732, 2732A, 2764 AND 27128
- HIGH SPEED WRITE ALGORITHM
- LED INDICATORS FOR ACTIVITY
- NO EXTERNAL POWER SUPPLY NEEDED
- ONE YEAR WARRANTY

**16K RAMCARD \$30.95**



- FULL TWO YEAR WARRANTY
- EXPAND YOUR 48K APPLE TO 64K
- USE IN PLACE OF APPLE LANGUAGE CARD
- BARE PC CARD W/INSTRUCTIONS \$8.95

**IC TEST CARD \$89.95**



- QUICKLY TESTS MANY COMMON ICs
- DISPLAYS PASS OR FAIL
- ONE YEAR WARRANTY
- TESTS: 4000 SERIES CMOS, 74HC SERIES CMOS, 7400, 74LS, 74L, 74H & 74S

**300B MODEM \$49.95**

FOR APPLE OR IBM

INCLUDES ASCII PRO-EZ SOFTWARE



• FCC APPROVED

- BELL SYSTEMS 103 COMPATIBLE
- INCLUDES AC ADAPTOR
- AUTO-DIAL
- DIRECT CONNECT

CABLE FOR APPLE IIc \$14.95

**JOYSTICK CR-401 \$7.95**

FOR ATARI 400, 800, 2600, VIC 20/64 AND APPLE IIc

### DISKFILE

HOLDS 70 5 1/4" DISKETTES



**\$8.95**

### POWER STRIP

• UL APPROVED  
• 15A CIRCUIT BREAKER  
**\$12.95**



## 3-WAY SWITCH BOXES

- SERIAL OR PARALLEL
- CONNECTS 3 PRINTERS TO ONE COMPUTER OR VICE VERSA
- ALL LINES SWITCHES
- HIGH QUALITY ROTARY SWITCH MOUNTED ON PCB
- GOLD CONTACTS
- STURDY METAL ENCLOSURE



**SWITCH-3P CENTRONICS PARALLEL \$89.95**

**SWITCH-3S RS232 SERIAL \$89.95**

## PRINTER BUFFERS

- FREES COMPUTER FOR OTHER TASKS WHILE PRINTING LONG DOCUMENTS
- STAND-ALONE DESIGN; WORKS WITH ANY COMPUTER OR PRINTER
- ALL MODELS FEATURE PRINT PAUSE MEMORY CHECK, GRAPHICS CAPABILITY

**SP120P PARALLEL \$139.95**

- 64K UPGRADABLE TO 256K
- LED INDICATOR SHOWS VOLUME OF DATA IN BUFFER

**SP120S RS232 SERIAL \$159.95**

- 64K UPGRADABLE TO 256K
- 6 SELECTABLE BAUD RATES, FROM 600B-19,200B

**SP110P PARALLEL \$249.95**

- 64K UPGRADABLE TO 512K
- SPOOLS OUTPUT OF UP TO 3 COMPUTERS
- LED BARGRAPH DISPLAYS AMOUNT OF DATA IN BUFFER
- RESET FUNCTION CLEARS DATA IN BUFFER
- REPEAT FUNCTION CAN PRODUCE MULTIPLE COPIES OF A DOCUMENT



SP120



SP110

## NASHUA DISKETTES DEALS

5 1/4" SOFT SECTOR DS/DD WITH HUB RINGS

**\$9.90** **69¢ ea** **59¢ ea**

BOX OF 10 BULK QTY 50 BULK QTY 250

NASHUA DISKETTES WERE JUDGED TO HAVE THE HIGHEST POLISH AND RECORDED AMPLITUDE OF ANY DISKETTES TESTED ACCORDING TO "COMPARING FLOPPY DISKS", BYTE 9/84

### DISKETTES

NASHUA 5 1/4"

- N-MD2D DS/DD SOFT \$9.90
- N-MD2F DS/QUAD SOFT \$34.95
- N-MD2H DS/HD FOR AT \$49.95

NASHUA 8"

- N-FD1 SS/DD SOFT \$27.95
- N-FD2D DS/DD SOFT \$34.95

NASHUA 3.5"

- N-3.55S 3.5" SS/DD FOR MAC \$32.95

VERBATIM 5 1/4"

- V-MD1D SS/DD SOFT \$23.95
- V-MD2D DS/DD SOFT \$23.95
- V-MD110D SS/DD 10 SECTOR HARD \$23.95

## Sakata 120 CPS DOT MATRIX PRINTER



**MODEL SP-1200 \$169.95**

- EPSON/IBM COMPATIBLE
- 9-WIRE PRINTHEAD
- 120 CPS-BIDIRECTIONAL, 80 COL.
- FRICTION AND TRACTOR FEED
- PROPORTIONAL SPACING
- CENTRONICS PARALLEL INTERFACE
- 8 CHARACTER SETS AND GRAPHICS

6 FOOT IBM PRINTER CABLE \$9.95

REPLACEMENT RIBBON CARTRIDGE \$11.95

## 5 1/4" FLOPPY DISK DRIVES

- TEAC FD-55B 1/2 HT DS/DD FOR IBM \$109.95
- TEAC FD-55F 1/2 HT DS/QUAD FOR IBM \$124.95
- TEAC FD-55G 1/2 HT DS/HD FOR IBM AT \$154.95
- TANDON TM100-2 DS/DD FOR IBM \$119.00
- TANDON TM60-2 1/2 HT DS/DD FOR IBM \$79.95
- MPI-852 DS/DD FOR IBM \$79.95
- QUINE QY-142 1/2 HT DS/DD FOR IBM \$79.95

## 8" FLOPPY DISK DRIVES

- FD 100-B SS/DD (SA/801 EQUIV) \$119.00
- FD 200-B DS/DD (SA/851R EQUIV) \$159.00

## DISK DRIVE ACCESSORIES

- TEAC SPECIFICATION MANUAL \$5.00
- TEAC MAINTENANCE MANUAL \$25.00
- 1/2 HT MOUNTING HARDWARE \$2.95
- MOUNTING RAILS FOR IBM AT \$4.95
- "Y" POWER CABLE FOR 5 1/4" FDD \$2.95
- 5 1/4" FDD POWER CONNECTORS \$1.19



TEAC FD-55

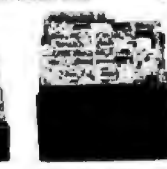

TANDON TM100-2

## DISK DRIVE ENCLOSURES

**CAB-APPLE \$24.95**

APPLE TYPE CABINET W/OUT POWER SUPPLY

**CAB-1FH5 \$89.95**

FULL HT 5 1/4" BEIGE CABINET W/POWER SUPPLY

**CAB-25V5 \$49.95**

DUAL SLMUNE 5 1/4" CABINET W/POWER SUPPLY

**CAB-25V8 \$209.95**

DUAL SLMUNE 8" VERTICAL CABINET W/POWER SUPPLY

**CAB-2FH8 \$219.95**

DUAL FULL HT 8" CABINET W/POWER SUPPLY



CAB-25V5



CAB-1FH5

## TEST EQUIPMENT FROM JDR INSTRUMENTS

**DIGITAL MULTIMETER PEN DPM-1000**  
AUTO RANGING, POLARITY AND DECIMAL!

**\$54.95**

- LARGE 3.5 DIGIT DISPLAY
- DATA HOLD SWITCH FREEZES READING
- FAST, AUDIBLE CONTINUITY TEST
- LOW BATTERY INDICATOR
- OVERLOAD PROTECTION



**20MHZ DUAL TRACE OSCILLOSCOPE MODEL 2000 \$389.00**

**35MHZ DUAL TRACE OSCILLOSCOPE MODEL 3500 \$549.00**

FOR MORE INFORMATION ON THE OSCILLOSCOPES, CALL US FOR FREE PRODUCT BRIEFS.

# 20 MEGA BYTE HARD DISK SYSTEM ONLY \$389.95!

## SEAGATE ST-225 20 MB HARD DISK SYSTEM

INCLUDES HARD DISK CONTROLLER, CABLES AND INSTRUCTIONS. ALL DRIVES ARE PRE-TESTED AND COME WITH A ONE YEAR WARRANTY.

# \$389.95

## XT COMPATIBLE MOTHERBOARD

# \$129.95

- 4.77 MHz 8088 CPU, OPTIONAL 8087 CO-PROCESSOR
- 8 EXPANSION SLOTS
- 64K RAM INSTALLED, EXPANDABLE TO 640K ON-BOARD MEMORY
- ALL ICs SOCKETED-HIGHEST QUALITY PC BOARD
- ACCEPTS 2764 OR 27128 ROMS

PRO-BIOS \$19.95

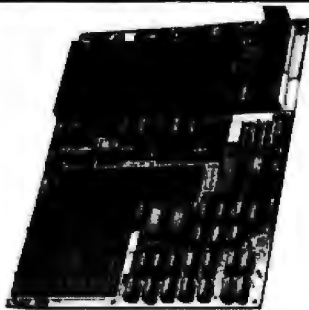

## IBM COMPATIBLE INTERFACE CARDS

ALL WITH A ONE YEAR WARRANTY

### MULTI I/O FLOPPY CARD \$89.95

PERFECT FOR THE 640K MOTHERBOARD



- 2 DRIVE FLOPPY DISK CONTROLLER
- 1 RS232 SERIAL PORT: OPTIONAL 2nd SERIAL PORT
- PARALLEL PRINTER PORT
- GAME PORT
- CLOCK/CALENDAR
- SOFTWARE: CLOCK UTILITIES, RAMDISK, SPOOLER
- OPTIONAL SERIAL PORT \$15.95

### MULTIFUNCTION CARD \$84.95

ALL THE FEATURES OF AST'S 8 PACK PLUS AT HALF THE PRICE



- CLOCK/CALENDAR
- 0-384K RAM
- SERIAL PORT
- PARALLEL PORT
- GAME PORT
- SOFTWARE INCLUDED
- PRINTER CABLE \$2.95
- 64K RAM UPGRADE \$371.01

### COLOR GRAPHICS ADAPTOR \$89.95

FULLY COMPATIBLE WITH IBM COLOR CARD



- 4 VIDEO INTERFACES: RGB, COMPOSITE COLOR, HI-RES COMPOSITE MONOCHROME, CONNECTOR FOR RF MODULATOR
- COLOR GRAPHICS MODE: 320 x 200
- MONO GRAPHICS MODE: 640 x 200
- LIGHT PEN INTERFACE

### MONOCHROME GRAPHICS CARD \$89.95

FULLY COMPATIBLE WITH IBM MONOCHROME ADAPTOR & HERCULES GRAPHICS



- LOTUS COMPATIBLE
- TEXT MODE: 80 x 25
- GRAPHICS MODE: 720 x 348
- PARALLEL PRINTER INTERFACE
- OPTIONAL SERIAL PORT \$19.95

### MONOCHROME ADAPTOR \$49.95

ANOTHER FANTASTIC VALUE FROM JDR!

- IBM COMPATIBLE TTL OUTPUT
- 720 x 350 PIXEL DISPLAY

PLEASE NOTE: THIS CARD WILL NOT RUN LOTUS GRAPHICS AND DOES NOT INCLUDE A PARALLEL PORT

### FLOPPY DISK DRIVE ADAPTOR \$34.95



- INTERFACES UP TO 4 STANDARD FDDs TO IBM PC OR COMPATIBLES
- INCLUDES CABLE FOR TWO INTERNAL DRIVES
- STANDARD DB37 FOR EXTERNAL DRIVES
- RUNS QUAD DENSITY DRIVES WHEN USED WITH JFORMAT

## 1200 BAUD MODEMS

HAYES COMPATIBLE, AUTO-DIAL, AUTO-ANSWER, AUTO RE-DIAL ON BUSY, POWER-UP SELF TEST, FULL ONE YEAR WARRANTY

| MODEL 1200B*           | MODEL 1200H*            | SMARTTEAM               |
|------------------------|-------------------------|-------------------------|
| • INTERNAL DESIGN      | • INTERNAL DESIGN       | • EXTERNAL DESIGN       |
| • 10 INCH CARD         | • HALF LENGTH (5") CARD | • WITH POWER SUPPLY     |
| • SERIAL PORT INCLUDED | • INCLUDES SPEAKER      | • LED STATUS INDICATORS |
| <b>\$189.95</b>        | <b>\$149.95</b>         | <b>\$169.95</b>         |

\*FOR IBM, INCLUDES PC TALK III COMMUNICATIONS SOFTWARE

## CRT MONITORS FOR ALL APPLICATIONS



**LUXOR HI-RES RGB MONITOR**  
MODEL 190-9528

- DIGITAL RGB IBM COMPATIBLE
- 14" SCREEN
- 16 TRUE COLORS
- 25 MHz BANDWIDTH
- RESOLUTION > 640 x 262
- 31mm DOT PITCH
- CABLE FOR IBM PC INCLUDED

**\$299.95**



**SAKATA COMPOSITE COLOR**  
MODEL SG-100

- TOP RATED FOR APPLE
- 13" COMPOSITE VIDEO
- RESOLUTION: 280H x 300V
- INTERNAL AUDIO AMP
- ONE YEAR WARRANTY

**\$169.95**



**CENTER SYSTEMS MONOCHROME**  
MODEL KCM-1211

- IBM COMPATIBLE TTL INPUT
- 12" NON-GLARE SCREEN
- P29 GREEN PHOSPHORUS
- VERY HIGH RESOLUTION
- 25 MHz BANDWIDTH
- 1100 LINES (CENTER)

AMBER VERSION \$109.95

**\$99.95**

## BUILD YOUR OWN 256K XT COMPATIBLE SYSTEM

|                        |          |
|------------------------|----------|
| XT MOTHERBOARD         | \$129.95 |
| PRO-BIOS               | \$19.95  |
| 256K RAM               | \$28.55  |
| 130 WATT POWER SUPPLY  | \$89.95  |
| FLIP-TOP CASE          | \$39.95  |
| DKM-2000 KEYBOARD      | \$59.95  |
| 1/2 HEIGHT QUME DRIVE  | \$78.95  |
| FLOPPY DISK CONTROLLER | \$34.95  |
| MONOCHROME ADAPTOR     | \$49.95  |
| MONOCHROME MONITOR     | \$99.95  |

TOTAL: **\$811.10**

## MONITOR STAND



TILTS AND SWIVELS

**ONLY \$12.95**

## IBM PRINTER CABLE



• DB25 TO CENTRONICS  
• SHIELDED CABLE **\$9.95**

## IBM STYLE COMPUTER CASE

AN ATTRACTIVE STEEL CASE WITH A HINGED LID FITS THE POPULAR PC/XT COMPATIBLE MOTHERBOARDS

- SWITCH CUT-OUT ON SIDE FOR PC/XT STYLE POWER SUPPLY
- CUT-OUT FOR 8 EXPANSION SLOTS
- ALL HARDWARE INCLUDED

**\$39.95**

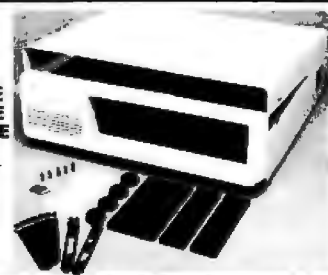

## IBM COMPATIBLE KEYBOARDS

DKM-2000 \$59.95

IBM-5151 \$79.95



- "5150" STYLE KEYBOARD
- FULLY IBM COMPATIBLE
- LED STATUS INDICATORS FOR CAPS & NUMBER LOCK
- 83 KEY - SAME LAYOUT AS IBM PC/XT KEYBOARD



- REPLACEMENT FOR KEYTRONICS KB-5151™
- SEPARATE CURSOR & NUMERIC KEYPAD
- CAPS LOCK & NUMBER LOCK INDICATORS
- IMPROVED KEYBOARD LAYOUT

## POWER SUPPLY

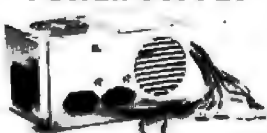

**NOW ONLY \$69.95**

- FOR IBM PC-XT COMPATIBLE
- 135 WATTS
- +5V @ 15A, +12V @ 4.2A
- -5V @ .5A, -12V @ .5A

150 WATT MODEL **\$79.95**

## DISK DRIVES TANDON TM50-2

# \$79.95

- 1/2 HT DS/DD
- IBM COMPATIBLE
- EXTREMELY QUIET!

|                   |         |          |
|-------------------|---------|----------|
| TEAC FD-55D       | DS/DD   | \$109.95 |
| TEAC FD-55F       | DS/QUAD | \$124.95 |
| TEAC FD-55B       | DS/HD   | \$154.95 |
| QUME QT-142       | DS/DD   | \$79.95  |
| MOUNTING HARDWARE |         | \$2.95   |
| AT/RAILS          |         | \$4.95   |

**JDR Microdevices**

1224 S. Bascom Avenue, San Jose, CA 95128

Toll Free 800-538-5000 • (408) 995-5430 • FAX (408) 275-8415 • Telex 171-110



# B·O·M·B

## BYTE'S ONGOING MONITOR BOX

| ARTICLE# | PAGE | ARTICLE                                                                                   | AUTHOR(S)                | ARTICLE# | PAGE | ARTICLE                                                    | AUTHOR(S)      |
|----------|------|-------------------------------------------------------------------------------------------|--------------------------|----------|------|------------------------------------------------------------|----------------|
| 1        | 9    | Microbytes .....                                                                          | staff                    | 15       | 241  | Amiga Animation .....                                      | Dilton, Dilton |
| 2        | 31   | What's New .....                                                                          | staff                    | 16       | 249  | Amiga vs. Macintosh .....                                  | Webber         |
| 3        | 50   | Ask BYTE/Circuit Cellar Feedback ..                                                       | Ciarcia                  | 17       | 263  | The Franklin ACE 2200 .....                                | Woodhull       |
| 4        | 65   | Book Reviews .....                                                                        | Williams, Crabb          | 18       | 269  | The Leading Edge Model D PC .....                          | Miastkowski    |
| 5        | 84   | Product Preview: LabVIEW:<br>Laboratory Virtual Instrument<br>Engineering Workbench ..... | Vose<br>Williams         | 19       | 275  | The Xerox 6060 .....                                       | Rash           |
| 6        | 97   | Ciarcia's Circuit Cellar: Build a<br>Hardware Data Encryptor .....                        | Ciarcia                  | 20       | 283  | The C. Itoh TriPrinter .....                               | Swearingin     |
| 7        | 114  | Programming Project: Calculating<br>CRCs by Bits and Bytes .....                          | Morse                    | 21       | 287  | The Turner Hall Card .....                                 | Angel          |
| 8        | 127  | Programming Insight:<br>Breaking Out .....                                                | Batutis                  | 22       | 293  | Turbo Prolog .....                                         | Shammas        |
| 9        | 137  | Keyed File Access in BASIC .....                                                          | Perry                    | 23       | 299  | Software Carousel .....                                    | Haas           |
| 10       | 145  | Real Time Under Real Pascal .....                                                         | Feldman                  | 24       | 303  | Paradox I.I .....                                          | DeMaria        |
| 11       | 163  | 68000 Tricks and Traps .....                                                              | Morton                   | 25       | 311  | WordPerfect 4.1 .....                                      | Birmele        |
| 12       | 179  | UNIX and the MC68000 .....                                                                | Rood, Cline,<br>Brewster | 26       | 321  | Computing at Chaos Manor:<br>A Busy Day .....              | Pournelle      |
| 13       | 205  | A Comparison of MC68000<br>Family Processors .....                                        | Johnson                  | 27       | 335  | According to Webster:<br>Two Fine Products .....           | Webster        |
| 14       | 223  | Atari ST Software Development ..                                                          | Rothman                  | 28       | 351  | BYTE Japan: Perspectives on<br>Hardware and Software ..... | Raike          |
|          |      |                                                                                           |                          | 29       | 359  | BYTE U.K.:<br>Turbocharging Mandelbrot .....               | Pountain       |
|          |      |                                                                                           |                          | 30       | 367  | Applications Only:<br>Sing Ye MacPraises .....             | Shapiro        |
|          |      |                                                                                           |                          | 31       | 380  | Best of BIX .....                                          | BIXen          |

## BOMB Results

### MUSIC IN THE AIR

Winner of \$100 for placing first in June's BOMB is Robert A. Moog for his "Digital Music Synthesis," an overview of the general attributes of musical sound and how to produce it. In second place, and the winner

of \$50 is Eric Jensen for his review of the Atari 520ST. The \$50 award for quality also goes to Robert A. Moog for "Digital Music Synthesis." Congratulations.

# N·E·X·T M·O·N·T·H I·N B·Y·T·E

### A MAJOR NEW PRODUCT:

Our in-depth technical description—much more than just a "first look"—will help you decide if this new product is something truly important or just another yawn masquerading as a smile.

### THEME:

Public domain software includes a version of the Prolog language, a database that can run backward in time, a tutorial on icons, a software emulation of the Z80 microprocessor, and a special interview with Richard Stallman—proponent of the public domain and founder of the Free Solution Foundation.

### HARDWARE REVIEWS:

An objective appraisal of the Amiga; the powerful, downsize Compaq II transportable; the UNIX-based, multiuser Tandy 6000; three 24-pin printers; and four magnetic-tape backup units.

### SOFTWARE REVIEWS:

Microsoft Word 3.0; Digital Research's Concurrent PC DOS; Soft Warehouse's muLISP-86; ITC's Modula-2; and a comparison of The Norton Utilities, Super Utility, and PC Tools.

### CIRCUIT CELLAR:

A build-it-yourself intelligent EPROM programmer.

### SPECIAL MC68000 SERIES:

"Sound and the Amiga"

### PROGRAMMING INSIGHTS:

"Another Approach to Data Compression" and "A Useful Property of 2"

**PLUS** lively columns by Pournelle, Webster, Shapiro, Pountain, and Raike; more from the Best of BIX; book reviews, What's New, Microbytes, and more.

# A COMPUTER PROGRAM DELIVERED VIA SATELLITE!

**The Computer Chronicles**, a half-hour weekly television series brings you news and information from Silicon Valley and around the world.

Correspondent Stewart Cheifet and Gary Kildall, creator of CP/M cover today's headlines and the stories behind them.

Find out what is, what was and what will be, with the only computer program you're ever going to need. **The Computer Chronicles**, every week on a public television station near you.

(Check local listings for time and channel.)



Produced by NCSM, San Mateo, CA and WITF, Harrisburg, PA with funding from McGraw-Hill's **BYTE** magazine.

## BYTE ADVERTISING SALES STAFF:

**Dennis J. Riley, Advertising Sales Manager, One Phoenix Mill Lane, Peterborough, NH 03458, tel. (603) 924-9281**

### NEW ENGLAND

ME, NH, VT, MA, RI,  
EASTERN CANADA  
Paul McPherson Jr. (617) 262-1160  
McGraw-Hill Publications  
575 Boylston Street  
Boston, MA 02116

### ATLANTIC

NY, NYC, CT, NJ (NORTH)  
Leah G. Rabinowitz (212) 512-2096  
McGraw-Hill Publications  
1221 Avenue of the Americas—  
39th Floor  
New York, NY 10020

Dick McGurk (203) 968-7111

McGraw-Hill Publications  
Building A—3rd Floor  
777 Long Ridge Road  
Stamford, CT 06902

### EAST

PA (EAST), NJ (SOUTH),  
MD, VA, W.VA, DE, D.C.  
Daniel Ferro (215) 496-3833  
McGraw-Hill Publications  
Three Parkway  
Philadelphia, PA 19102

### SOUTHEAST

NC, SC, GA, FL, AL, TN  
Maggie M. Dorvee (404) 252-0626  
McGraw-Hill Publications  
4170 Ashford-Dunwoody Road—  
Suite 420  
Atlanta, GA 30319

### MIDWEST

IL, MO, KS, IA, ND, SD, MN, WI, NB, IN  
Bob Denmead (312) 751-3740  
McGraw-Hill Publications  
Blair Building  
645 North Michigan Ave.  
Chicago, IL 60611

### GREAT LAKES, OHIO REGION

MI, OH, PA (ALLEGHENY), KY,  
ONTARIO, CANADA  
Renee Navarro (313) 352-9760  
McGraw-Hill Publications  
4000 Town Center—Suite 770  
Southfield, MI 48075

### SOUTHWEST, ROCKY MOUNTAIN

UT, CO, WY, OK, TX, AR, MS, LA  
Kevin Harold (214) 458-2400  
McGraw-Hill Publications  
Prestonwood Tower—Suite 907  
5151 Beltline  
Dallas, TX 75240

### SOUTH PACIFIC

SOUTHERN CA, AZ, NM, LAS VEGAS  
Jack Anderson (714) 557-6292  
McGraw-Hill Publications  
3001 Red Hill Ave.  
Building #1—Suite 222  
Costa Mesa, CA 92626

Karen Niles (213) 480-5243, 487-1160  
McGraw-Hill Publications  
3333 Wilshire Boulevard #407  
Los Angeles, CA 90010

### NORTH PACIFIC

HI, WA, OR, ID, MT, NORTHERN CA,  
NV (except LAS VEGAS), W. CANADA  
Mike Kisseberth (415) 362-4600  
McGraw-Hill Publications  
425 Battery Street  
San Francisco, CA 94111

Bill McAfee (415) 349-4100  
McGraw-Hill Publications  
951 Mariner's Island Blvd.—3rd Floor  
San Mateo, CA 94404

### WEST COAST SURPLUS

AND RETAIL ACCOUNTS  
Tom Harvey (805) 964-8577  
3463 State Street—Suite 256  
Santa Barbara, CA 93105

### The Buyer's Mart

Karen Burgess (603) 924-3754  
BYTE Publications  
70 Main Street  
Peterborough, NH 03458

### BYTE BITS (2x3)

Dan Harper (603) 924-6830  
BYTE Publications  
70 Main Street  
Peterborough, NH 03458

### Post Card Mailings

National  
Bradley Browne (603) 924-6166  
BYTE Publications  
70 Main Street  
Peterborough, NH 03458

## International Advertising Sales Staff:

Mr. Hans Csokor  
Publimedia  
Reisnerstrasse 61  
A-1037 Vienna, Austria  
222 75 76 84

Mrs. Gurti Gepner  
McGraw-Hill Publishing Co.  
PO Box 2156  
Bat Yam, 59121 Israel  
3 866 561 321 39

Mr. Fritz Krusebecker  
McGraw-Hill Publishing Co.  
Liebigstrasse 19  
D-6000 Frankfurt/Main 1  
West Germany  
69 72 01 81

Mrs. Maria Sarmiento  
Pedro Teixeira 8, Off. 320  
Iberia Mart I  
Madrid 4, Spain  
1 45 52 891

Mr. Andrew Karnig  
Andrew Karnig & Associates  
Finnbodavagen  
S-131 31 Nacka, Sweden  
8-44 0005

Mr. Alain Faure  
McGraw-Hill Publishing Co.  
128 Faubourg Saint Honore  
75008 Paris  
France  
(1) 47-20-33-42

Mr. Arthur Scheffer  
McGraw-Hill Publishing Co.  
34 Dover St.  
London W1X 3RA  
England 01 493 1451

Manuela Capuano  
McGraw-Hill Publishing Co.  
Via Flavio Baracchini 1  
20123 Milan, Italy  
02 86 90 617

Seavex Ltd  
400 Orchard Road, #10-01  
Singapore 0923  
Republic of Singapore  
Tel: 734-9790  
Telex: RS35539 SEAVEX

Seavex Ltd.  
503 Wilson House  
19-27 Wyndham St.  
Central, Hong Kong  
Tel: 5-260149  
Telex: 60904 SEVEX HK

Hiro Morita  
McGraw-Hill Publishing Co.  
Overseas Corp.  
Room 1528  
Kasumigaseki Bldg.  
3-2-5 Kasumigaseki,  
Chiyoda-Ku  
Tokyo 100, Japan  
3 581 9811

Mr. Ernest McCrary  
Empresa Internacional de  
Comunicacoes Ltda.  
Rua da Consolacao, 222  
Conjuntio 103  
01302 Sao Paulo, S.P., Brasil  
Tel: (11) 259-3811  
Telex: (100) 32122 EMBN

# R.E.A.D.E.R S.E.R.V.I.C.E

| Inquiry No.                  | Page No. | Inquiry No.                   | Page No. | Inquiry No.                   | Page No. | Inquiry No.                   | Page No.       |
|------------------------------|----------|-------------------------------|----------|-------------------------------|----------|-------------------------------|----------------|
| 396 AW ABLE                  | 279      | 75 COMPUSAVE                  | 423      | 152 HAYES MICROCOMP PROD      | 227      | * MCGRAW-HILL INFO SER        | 386, 387       |
| 2 ABSOFT                     | 52       | 76 COMPUSERVE                 | 260      | * HERCULES COMPUTER TECH      | 173      | * MCGRAW-HILL NRI             | 353            |
| 3 ACS IMPORTERS              | 427      | 78 COMPUTER-AGE INC           | 436      | 154 HERCULES COMPUTER TECH    | 174, 175 | 223 MEGASOFT                  | 442            |
| 407 ACTION SOFTWARE          | 396      | 79 COMPUTER BOOK CLUB THE     | 385      | 155 HERCULES COMPUTER TECH    | 174, 175 | 224 MEGATEL COMPUTER TECH     | 346            |
| 415 ADDISON-WESLEY ED.MEDIA  | 355      | * COMPUTER CHRONICLES         | 462      | 156 HERCULES COMPUTER TECH    | 176, 177 | * MERCEDES-BENZ OF NA         | 235            |
| 426 ADJUSTABLE COMP PROD     | 442      | * COMPUTER CONTINUUM          | 436      | 157 HERCULES COMPUTER TECH    | 176, 177 | 225 MERRITT COMP PRODUCTS     | 438            |
| 4 ADTEK TELECOMM CORP        | 388      | 81 COMPUTER FRIENDS           | 152      | 158 HERCULES COMPUTER TECH    | 178      | 226 METACOMCO                 | 143            |
| 5 ADV DIGITAL CORP           | 30       | 82 COMPUTER MAIL ORDER        | 348, 349 | 159 HERCULES COMPUTER TECH    | 178      | 227 MICRO DATA BASE SYS       | 313            |
| 6 ADV DIGITAL CORP           | 30       | 83 COMPUTER SURPLUS STORE     | 442      | 153 HERITAGE SYSTEMS CORP     | 438      | 228 MICRO DESIGN INT'L        | 391            |
| 7 ADV INTELLIGENCE TECHN     | 439      | 84 COMPUTER WAREHOUSE         | 288      | 160 HERSEY MICRO CONSULTING   | 429      | 229 MICRO INTERFACES CORP     | 181            |
| 8 ADVANCED COMP PROD         | 445      | 85 COMPUTER WAREHOUSE         | 288      | 161 HEWLETT/PACKARD           | 314      | 230 MICRO INTERFACES CORP     | 181            |
| 9 ADVANCED TECHNOLOGY PROD   | 422      | 86 COMPUTERBANC               | 441      | 162 HOOLEON CORP              | 346      | 231 MICRO MART INC            | 72, 73         |
| 10 AFTON COMPUTER            | 70       | 87 COMPUTERS INTERNATIONAL    | 232      | 163 HOOLEON CORP              | 346      | 232 MICRO PRODUCTS INT'L      | 453            |
| 11 AFTON COMPUTER            | 70       | 88 COMPUTRADE                 | 394      | 164 HOUSTON INSTR/BAUSHELLOMB | 21       | 233 MICRO SUPPLY ORGANIZATION | 426            |
| 409 ALPS AMERICA             | 56, 57   | 89 COMSPEC COMMUNICATIONS     | 383      | 165 IBEX COMP CORP            | 42       | 234 MICRO-SYSTEMS SOFTWARE    | 383            |
| 410 ALPS AMERICA             | 56, 57   | 90 CONCORD TECHNOLOGY LTD     | 347      | 166 IBM CORP                  | 48 A-D   | 141 MICROTECH COMPUTERS       | 452            |
| 14 ALPS AMERICA              | 392, 393 | 94 CORDATA                    | 189      | * IBM/SMALL SYSTEMS DIV       | 199      | 235 MICROBRIDGE COMPUTERS     | 429            |
| 15 ALPS AMERICA              | 392, 393 | 95 CUESTA SYSTEMS             | 256      | 168 IC EXPRESS                | 429      | 236 MICROGRAFX                | 64             |
| * AMERICAN DESIGN COMPONENTS | 211      | 96 CURTIS INC                 | 420      | 169 INFORMATION FACTORY       | 438      | 191 MICROILLUSIONS            | 381            |
| 17 AMERICAN COMPE PERIPH     | 191      | 428 CUSTOM SOFTWARE SOLUTIONS | 394      | 170 INI COMPUTER PROD         | 427      | * MICROMINT INC               | 337            |
| 18 AMERICAN COMPG PERIPH     | 191      | 102 DATANAMICS                | 454      | 171 INNOVATIVE SOFTWARE       | 316, 317 | 237 MICROPORT SYSTEMS INC     | 331            |
| 20 AMERICAN SEMICONDUCTOR    | 424      | 103 DECISIONWARE INC          | 330      | * INTECTRA INC                | 424      | 238 MICROPROCESSORS UNLTD     | 436            |
| 21 AMERICAN SMALL BUSN. COMP | 141      | 104 DECISIONWARE INC          | 330      | 172 INTEGRAND RESEARCH CORP   | 140      | * MICROSOFT CORP              | 51             |
| 22 AMPRO COMPUTERS INC       | 336      | 105 DESIGN SOFTWARE           | 354      | 173 INTEL CORPORATION         | 238, 239 | * MICROSOFT CORP              | 155            |
| 23 APPARAT INC               | 396      | 106 DEVSOFT INC               | 442      | 174 INTERNATIONAL COMPUTING   | 440      | * MICROSOFT CORP              | 156, 157       |
| 24 APPLIED VISIONS           | 382      | 35 DIGIT INC                  | 278      | 424 IO TECH                   | 429      | * MICROSOFT CORP              | 158, 159       |
| 25 APROTEK                   | 452      | 107 DIGITAL INC               | 231      | 175 IRWIN MAGNETICS           | 12, 13   | * MICROSOFT CORP              | 298            |
| 26 ARITY CORPORATION         | 356      | 108 DISKOTECH                 | 420      | 176 IACO ENTERPRISES          | 440      | 239 MICROTECH                 | 442            |
| * AST RESEARCH INC           | 19       | 109 DISKETTE CONNECTION       | 405      | 177 IADE COMP PROD            | 450, 451 | 240 MICROWARE SYSTEMS CORP    | 79             |
| 27 ATARI                     | 325      | 405 DISKMASTER                | 424      | 178 IAMECO ELECTRONICS        | 446, 447 | 241 MICROWAY                  | 23             |
| 28 ATARI                     | 327      | 110 DISKS PILLS INC           | 342      | 179 IC INFORMATION SYSTEMS    | 23       | 242 MICROWAY                  | 334            |
| 29 ATARI                     | 329      | 111 DISK WORLD! INC           | 431      | 180 IC INFORMATION SYSTEMS    | 23       | 19 MITAC INC                  | 262            |
| 30 ATRON CORP                | 26       | 112 DISPLAY TELECOMMCTNS      | 54       | 181 IDR INSTRUMENTS           | 305      | 12 MIX SOFTWARE               | 309            |
| 31 AUTOCOMPUTER CO LTD       | 369      | 113 DIVERSIFIED COMPUTER SYS  | 442      | 182 IDR MICRODEVICES          | 455      | * MOTOROLA SEMICON DV         | 134, 135       |
| 32 AVOCET SYSTEMS INC        | 195      | 114 DOKAY COMP PROD INC       | 443      | 183 IDR MICRODEVICES          | 456, 457 | 243 MOUNTAIN VIEW PRESS       | 243            |
| 34 B&B ELECTRONICS           | 440      | 115 DRESSLEHAUS COMP PROD     | 267      | 184 IDR MICRODEVICES          | 458, 459 | 244 MULTITECH ELECTRONICS INC | 91             |
| * B&C MICROSYSTEMS           | 427      | 116 ECOSOFT                   | 350      | 185 IDR MICRODEVICES          | 460      | 245 MYSTIC CANYON SOFTWARE    | 436            |
| * B&C MICROSYSTEMS           | 427      | 117 EDUCATIONAL MICROCOMP SYS | 422      | 187 KADAK PRODUCTS LTD        | 347      | 417 NANAQ USA CORP            | 328            |
| 36 BARRINGTON SYSTEMS        | 27       | 118 ELEXOR INC                | 366      | 390 KEA SYSTEMS LTD           | 434      | 418 NANAQ USA CORP            | 328            |
| 38 BAY EXPRESS COMPANY THE   | 429      | 119 ELLIS COMPUTING INC       | 69       | 188 KEITHLEY DAC              | 93       | 247 NANTUCKET                 | 37             |
| 39 BAY TECHNICAL ASSOC       | 255      | 120 ENERTRONICS RESEARCH      | 153      | 189 KIMTRON CORP              | 248      | 248 NANTUCKET                 | 37             |
| * BEST WESTERN INT'L         | 378      | 121 ENHANCEMENT TECH          | 216      | 190 KIMTRON CORP              | 248      | 249 NAT'L PUBLIC DOMAIN SFTW  | 440            |
| 41 BIT SOFTWARE              | 214      | 123 EVEREX SYSTEMS            | 94, 95   | 192 LABORATORY MICROSYS       | 78       | 250 NATIONAL INSTRUMENTS      | 58             |
| 42 BITTNER ELECTRONICS       | 366      | 124 EVEREX SYSTEMS            | 94, 95   | 416 LABORATORY TECHNOLOGY     | 18       | 251 NEC HOME ELECTR USA       | 201            |
| 450 BIX                      | 357      | 72 EYSAN                      | 452      | 193 LACHMAN ASSOCIATES INC    | 17       | 252 NEC INFORMATION SYS       | CIH            |
| 44 BLAISE COMPUTING INC      | 151      | 420 FACT AB                   | 377      | 194 LAHEY COMPUTER SYSTEMS    | 397      | 253 NEC INFORMATION SYS       | 220, 221       |
| 45 BLAISE COMPUTING INC      | 151      | * FASTCOMM DATA CORP          | 89       | 195 LASER ACTIVE '86          | 344      | 421 NEW GENERATION SYS        | 242            |
| 49 BORLAND INT'L             | CI1, 1   | 125 FLAGSTAFF ENGINEERING     | 320      | 196 LATTICE INC               | 24       | 254 NICOLET INSTRUMENTS       | 267            |
| 50 BORLAND INT'L             | CI1, 1   | 126 FLAGSTAFF ENGINEERING     | 320      | 197 LEADING EDGE PROD         | 55       | 255 OHIO KACHE SYS CORP       | 282            |
| 51 BP MICROSYSTEMS           | 420      | 128 FORESIGHT RESOURCES CORP  | 274      | 199 LINTEK COMP ACCESSORIES   | 452      | 256 OKIDATA                   | 47             |
| 52 BROWN BAG SOFTWARE        | 361      | 394 FORMAT SOFTWARE           | 289      | 200 LOGIC ARRAY               | 435      | 257 OMNITRON INC              | 452            |
| 53 BROWN BAG SOFTWARE        | 363      | 395 FORMAT SOFTWARE           | 289      | 201 LOGIC ARRAY               | 435      | * ORCAD SYS CORP              | 422            |
| 54 BUSINESS TOOLS INC        | 77       | 130 FORTRON CORPORATION       | 66       | 202 LOGICAL DEVICES           | 372      | 258 ORCHID TECHNOLOGY         | 233            |
| * BUYER'S MART SECTION       | 412-419  | 131 FORTRON CORPORATION       | 66       | 203 LOGICAL DEVICES           | 372      | 259 ORION INSTRUMENTS         | 136            |
| * BYTE BACK ISSUES           | 397      | 132 FORTRON CORPORATION       | 425      | 204 LOGICAL DEVICES           | 373      | 260 OSBORNE/MCGRAW-HILL       | 187            |
| * BYTE BITS MESSAGE          | 454      | 133 FORTRON CORPORATION       | 425      | 205 LOGICAL DEVICES           | 373      | 402 PC COMPUTER BROKERS INC   | 422            |
| * BYTE BOOK CLUB             | 400, 401 | 135 FOX SOFTWARE INC          | 20       | 400 LOGICSOFT                 | 144, A-F | 261 PC COMPUTER BROKERS INC   | 434            |
| * BYTE SUB MESSAGE           | 405      | 136 FRANK HOGG LABORATORY     | 424      | * LOGITECH INC                | 165      | 262 PC HORIZONS INC           | 366            |
| * BYTE SUB MESSAGE           | 434      | 137 FRANK HOGG LABORATORY     | 436      | 207 LOGITECH INC              | 167      | 101 PC MEMORY                 | 427            |
| * BYTE SUB SERVICE           | 240      | 138 FUJITSU AMERICA           | 193      | 208 LOGITECH INC              | 169      | 408 PANASONIC INDUSTRIAL      | 67             |
| * BYTE SUB SERVICE           | 399      | 139 GENERAL MICRO SYSTEMS     | 388      | 209 LONE STAR SOFTWARE INC    | 430      | 419 PANASONIC INDUSTRIAL      | 273            |
| 55 BYTE CONNECTION THE       | 421      | 140 GENERAL TECHNOLOGIES INC  | 33       | 210 LUCKY COMPUTERS           | 454      | 263 PARLOR SOFTWARE CO        | 402            |
| 57 BYTEK CORPORATION         | 170      | 411 GENICOM                   | 389      | 211 LYCO COMPUTER             | 213      | 264 PARSONS TECH              | 424            |
| * C WARE/DESMET C            | 340      | 142 GENOA SYSTEMS CORP        | 301      | 212 M-S CORPORATION           | 436      | 425 PATHFINDER SOFTWARE INC   | 434            |
| 58 CG R.S. MICROTECH INC     | 440      | 143 GMX INC                   | 190      | 213 M.W.RUTH COMPANY          | 382      | 265 PC AMERICAN MARKETING INC | 432            |
| * CALIFORNIA DIGITAL         | 448, 449 | 144 GOLDEN BOW SYSTEMS        | 424      | 214 MACMILLAN SOFTWARE        | 129      | 266 PC NETWORK                | 80, 80 A-B, 81 |
| 59 CAPITAL EQUIPMENT CORP    | 219      | 145 GOLDEN BOW SYSTEMS        | 454      | 216 MANX SOFTWARE SYS         | 133      | 267 PC SIG                    | 186            |
| 60 CASIO COMP CO LTD         | 185      | 146 GRAFPOINT                 | 440      | 217 MANX SOFTWARE SYS         | 343      | 412 PC STAR                   | 395            |
| 61 CAUZIN SYSTEMS            | 374, 375 | 147 GRAND UNION MICROSYSTEMS  | 420      | 218 MARK WILLIAMS CO          | 59       | 413 PC STAR                   | 395            |
| 62 CERMETEK MICROELECTRONICS | 434      | 148 GRIDCOMM                  | 218      | 219 MARK WILLIAMS CO          | 61       | 268 PC'S LIMITED              | 202, 203       |
| 63 CHALCEDONY SOFTWARE       | 74       | 149 GTEK INC                  | 358      | 220 MARON PRODUCTION INC      | 440      | 269 PECAN SOFTWARE SYS INC    | 16             |
| 64 CHALCEDONY SOFTWARE       | 74       | 150 GTEK INC                  | 358      | * MATHSOFT INC                | 117      | 270 PERSOFT INC               | 8              |
| 65 CITIZEN AMERICA           | 112, 113 | * HARMONY COMPUTERS           | 341      | * MAXELL DATA PRODUCTS        | 7        | 271 PERSONAL TEX INC          | 338            |
| 66 CLEO SOFTWARE             | 268      | 151 HAWAIIAN VILLAGE COMPSFT  | 438      | * MCGRAW-HILL CEC             | 225      | 272 PINECOM COMPUTER INC      | 423            |
| 67 CMA MICRO COMP DIV        | 142      |                               |          |                               |          | * POLYTEL COMP PROD CORP      | 132            |
| 97 CMH SOFTWARE              | 388      |                               |          |                               |          | 273 PRECISION DATA PRODUCTS   | 434            |
| 68 COEFFICIENT SYS CORP      | 22       |                               |          |                               |          | 274 PRECISION OPTICAL         | 442            |
| 69 COGITATE                  | 436      |                               |          |                               |          | 275 PRINCETON GRAPHIC SYS     | 39             |
| 70 COGITATE                  | 436      |                               |          |                               |          | 276 PRINCETON GRAPHIC SYS     | 296, 297       |
| 398 COMMODORE BUSN. MACHINES | 162      |                               |          |                               |          | 277 PRINTER WORKS THE         | 440            |
| * COMPAG COMPUTER CORP       | 280, 281 |                               |          |                               |          | 278 PROFESSOR JONES INC       | 429            |
| 71 COMPETITIVE EDGE          | 381      |                               |          |                               |          | 279 PROGRAMMER'S SHOP         | 323            |
| 73 COMPUTATA TRANSLATORS INC | 442      |                               |          |                               |          | 281 PROSOFT                   | 43             |
| 74 COMPUPRO                  | 247      |                               |          |                               |          | 283 PURPLE COMPUTING          | 454            |

TO GET FURTHER information on the products advertised in BYTE, either pick up your touch-tone telephone and use TIPS (if you are a subscriber), or fill out the reader service card. Either way full instructions are provided following this reader service index which is provided as an additional service by the publisher, who assumes no liability for errors or omissions. \*Correspond directly with company.



# TODAY IS THE BLACKEST DAY IN DOT MATRIX PRINTER HISTORY.

It would pay you to mark it on your calendar.

Because today is the day we introduce our new Pinwriter™ P5XL dot matrix printer. The only dot matrix printer available capable of producing the rich, black printing you associate with a letter-quality printer. Because it's the only one designed to use a multi-strike film ribbon — the same ribbon used in typewriters and letter-quality printers.

Black letter-quality printing is only the beginning. The Pinwriter P5XL printer can also use an optional ribbon to

## A LITTLE BLACK MAGIC.

Actual line printed with the Pinwriter P5XL printer.

print in seven other colors. And it has the finest graphics resolution of any impact printer you can buy. Plus it's very fast and exceptionally quiet.

It's only natural that

the first dot matrix printer with true letter-quality printing should be an NEC. After all we make Spinwriter® letter-quality printers, the most popular line today, as well as the Pinwriter P5 dot matrix printer, the most advanced 24-pin printer.

The Pinwriter P5XL printer is part of the most extensive line of 24-pin printers available. You'll find a model designed to fit every need and budget. See them at your dealer or call 1-800-343-4418 (in MA 617-264-8635). Or write: NEC Information Systems, Dept. 1610, 1414 Massachusetts Ave., Boxborough, MA 01719.



**NEC PRINTERS. THEY ONLY STOP  
WHEN YOU WANT THEM TO.**

# NEC

NEC Information Systems, Inc.

Inquiry 252

# Next to your computer,



## nothing beats a Tandy® printer.

### High-quality printers—for less!

Complete your system with the right printer for your home or office. Tandy offers the fine print quality, graphics and high performance you need—at a price you can afford. Whatever your printing requirements, we've got what you need for your business or home computer.

### Versatility and compatibility for your business

The DMP 430 (26-1277, \$699) gives you fantastic reproduction at a great price. The DMP 430 is a 132-column dot-matrix printer with an 18-wire print head that delivers superior correspondence characters in a single pass. You can choose from micro, italic and double-high fonts, as well as bit-image graphics. And in the draft mode, the DMP 430 delivers a fast 180 characters per second. IBM® PC compatible.

### Low-cost, triple-mode personal printer

The DMP 130 (26-1280, \$349.95) lets you choose from word processing, data processing and dot-addressable graphics. The DMP 130 prints in four character styles: standard or italic, cursive, in draft or correspondence modes, at up to 100 characters per second. Features a bidirectional logic-seeking print head for maximum efficiency, plus a built-in tractor to prevent paper from slipping. IBM® PC compatible.

### Tandy . . . Clearly Superior™

For the best value and selection in top-quality printers, shop your local Radio Shack Computer Center. We fully back what we sell with unbeatable support and service. Come in today and see our complete selection of printers, computers, upgrades and accessories.

**Radio Shack®**  
**The Technology Store™**  
A DIVISION OF TANDY CORPORATION

Prices apply at Radio Shack Computer Centers and at participating stores and dealers. The DMP 430 may require special order. IBM/Registered TM International Business Machine Corp.

Inquiry 292