

BYTE

THE SMALL SYSTEMS JOURNAL®

Desktop Publishing



MAY 1987 VOL.12, NO.5

\$3.50 IN UNITED STATES
\$4.50 IN CANADA / £1.75 IN U.K.
A MCGRAW-HILL PUBLICATION
0360-6280

**PUBLISHING
REVOLUTIONIZED!**

*Personal Computers
Replace Traditional
Methods*

CITY GAZETTE
**PUBLISHING
REVOLUTIONIZED!**
*Personal Computers
Replace Traditional
Methods*



Eureka: The Solver™

Anyone and everyone who routinely works with equations needs Eureka: The Solver

It solves the most complex equations in seconds. Whether you're a scientist, engineer, financial analyst, student, teacher, or some other professional, you need Eureka: The Solver!

Any problem that can be expressed as a linear or non-linear equation can be solved with Eureka. Algebra, Trigonometry and Calculus problems are a snap.

Eureka: The Solver also handles maximization and minimization problems, does plot functions, generates reports, and saves you an incredible amount of time.

$X + \exp(X) = 10$ solved instantly instead of eventually!

Imagine you have to "solve for X," where $X + \exp(X) = 10$, and you don't have Eureka: The Solver. What you do have is a problem, because it's going to take a lot of time guessing at "X." Maybe your guesses get closer and closer to the right answer, but it's also getting closer and closer to midnight and you're doing it the hard way.

With Eureka: The Solver, there's no guessing, no dancing in the dark—you get the right answer, right now. (PS: $X = 2.0705799$, and Eureka solved that one in .4 of a second!)

How to use Eureka: The Solver

It's easy.

1. Enter your equation into the full-screen editor
2. Select the "Solve" command
3. Look at the answer
4. You're done

You can then tell Eureka to

- Evaluate your solution
- Plot a graph
- Generate a report, then send the output to your printer, disk file or screen
- Or all of the above

Eureka: The Solver includes

- ☑ A full-screen editor
- ☑ Pull-down menus
- ☑ Context-sensitive Help
- ☑ On-screen calculator
- ☑ Automatic 8087 math co-processor chip support
- ☑ Powerful financial functions
- ☑ Built-in and user-defined math and financial functions
- ☑ Ability to generate reports complete with plots and lists
- ☑ Polynomial finder
- ☑ Inequality solutions

*Introductory price—good through July 1, 1987

Some of Eureka's key features

You can key in:

- ☑ A formula or formulas
- ☑ A series of equations—and solve for all variables
- ☑ Constraints (like X has to be $<$ or $=$ 2)
- ☑ A function to plot
- ☑ Unit conversions
- ☑ Maximization and minimization problems
- ☑ Interest Rate/Present Value calculations
- ☑ Variables we call "What happens?," like "What happens if I change this variable to 21 and that variable to 27?"

All this power for only \$99.95!

Equation-solving used to be a mainframe problem, but we've solved that problem.

Eureka: The Solver is all you need—and it's yours for only \$99.95!

That kind of savings you can calculate with your fingers!

System requirements

IBM PC, AT, XT, Portable, 3270 or true compatibles.
PC-DOS (MS-DOS) 2.0 and later. 384K.



4585 SCOTTS VALLEY DRIVE
SCOTTS VALLEY, CA 95066
(408) 438-8400 TELEX: 172373
GF15

For the dealer nearest you or to order by phone call

(800)255-8008

in CA (800) 742-1133 in Canada (800) 237-1136

BI-1103A

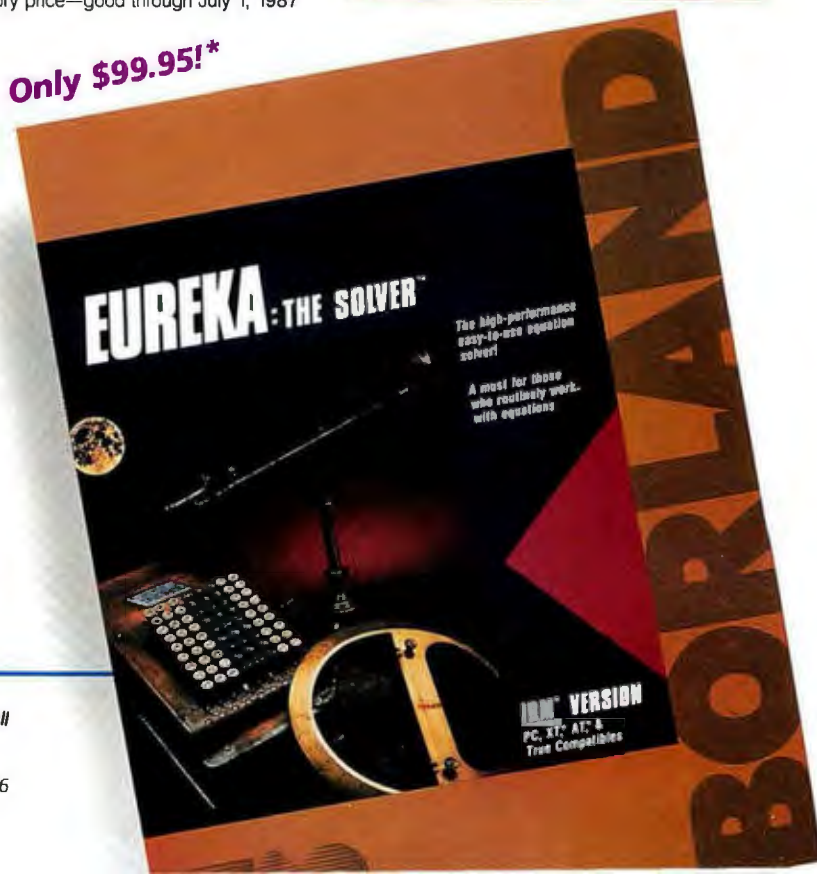



Turbo Basic[®]

NOW SHIPPING!

Introducing Turbo Basic, the high-speed BASIC you'd expect from Borland!

It's the BASIC compiler you've been waiting for. And it's so fast that you'll never have to wait again.

Turbo Basic is a complete development environment; it includes a lightning-fast compiler, an interactive editor, and a trace debugging system.

Because Turbo Basic is compatible with BASICA, chances are that you already know how to use Turbo Basic.

With Turbo Basic your only speed is "Full Speed Ahead"!

You probably already know us for both Turbo Pascal[®] and Turbo Prolog.[™] Well, we've done it again!

We created Turbo Basic, because BASIC doesn't have to be slow.

In fact, building fast compilers is a Borland specialty; both our Turbo Pascal and our Turbo Prolog outperform all their rivals by factors, and with Turbo Basic, we're proud to introduce the first high-speed BASIC compiler for the IBM[®]PC. If BASIC taught you how to walk, Turbo Basic will teach you how to run!

The Critics' Choice

“ Borland has succeeded in stretching the language without weighing us down with unnecessary details . . . Turbo Basic is the answer to my wish for a simple yet blindingly fast recreational utility language . . . The one language you can't forget how to use, Turbo Basic is a computer language for the missus, the masters, the masses, and me.

Steve Gibson, InfoWorld

Borland's Turbo Basic has advantages over the Microsoft product, including support of the high-speed 8087 math chip.

John C. Dvorak ¶¶

Turbo Basic ends the basic confusion

There's now one standard: Turbo Basic.

It's fast, BASICA-compatible, and because Turbo Basic is a Borland product, the price is right, and the quality is there, and the power is at your fingertips. You see, Turbo Basic's part of the fast-growing Borland family of programming languages—we call it the "Turbo Family." Hundreds of thousands of users are already using Borland's languages, so you can't go wrong. So join a whole new generation of smart IBM PC users—get your copy of Turbo Basic today. You get an easy-to-read 300+ page manual, two disks, and a free MicroCalc spreadsheet—and an instant start in the fast new world of Turbo Basic. All of this for only \$99.95—Order your copy of Turbo Basic today!

Free spreadsheet included, complete with source code!

Yes, we've included MicroCalc, our sample spreadsheet, complete with source code, so that you can get started right away with a "real program." You can compile and run it "as is," or modify it.

A technical look at Turbo Basic

- ☑ Full recursion supported
- ☑ Standard IEEE floating-point format
- ☑ Floating-point support, with full 8087 (math co-processor) integration. Software emulation if no 8087 present
- ☑ Program size limited only by available memory (no 64K limitation)
- ☑ EGA and CGA support
- ☑ Access to local, static, and global variables
- ☑ Full integration of the compiler, editor, and executable program, with separate windows for editing, messages, tracing, and execution
- ☑ Compile, run-time, and I/O errors place you in the source code where error occurred
- ☑ New long integer (32-bit) data type
- ☑ Full 80-bit precision
- ☑ Pull-down menus
- ☑ Full window management

System requirements

IBM PC, XT, AT and true compatibles, PC-DOS (MS-DOS) 2.0 or later. One floppy drive, 256K.

Only \$99.95!

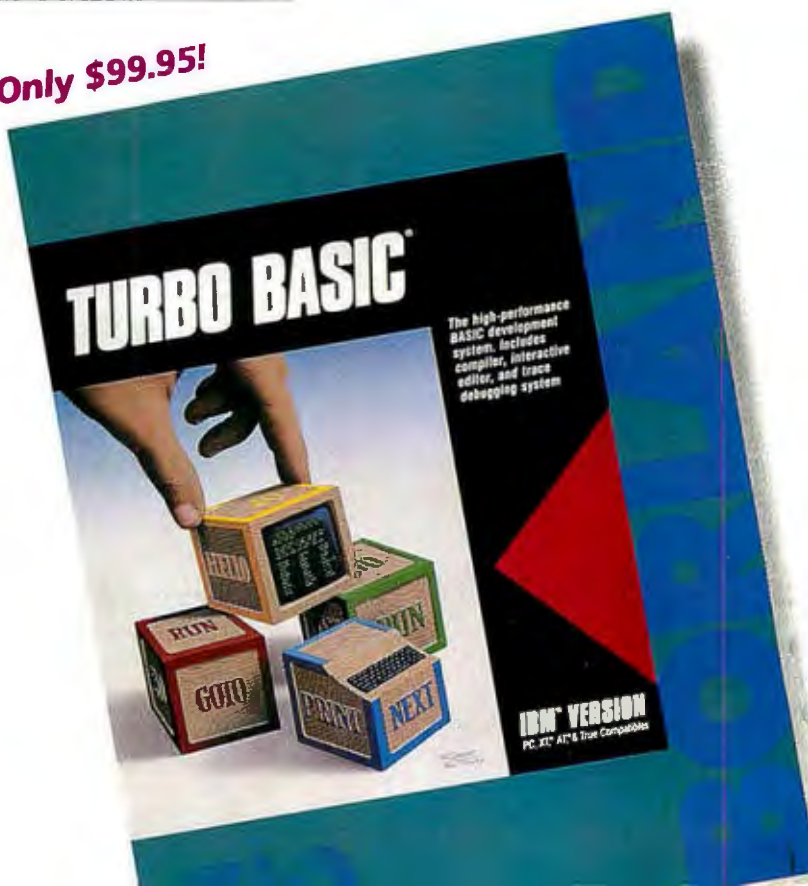

Turbo Prolog™

“ If you're at all interested in artificial intelligence, databases, expert systems, or new ways of thinking about programming, by all means plunk down your \$100 and buy a copy of Turbo Prolog. **Bruce Webster, BYTE 9/86** ”

Only
\$99.95!



Turbo Prolog, the natural language of Artificial Intelligence, is the most popular AI package in the world with more than 100,000 users. It's the 5th-generation computer programming language that brings supercomputer power to your IBM PC and compatibles. You can join the AI revolution with Turbo Prolog for only \$99.95. Step-by-step tutorials, demo programs and source code included.

New! Turbo Prolog Toolbox

Our new Turbo Prolog Toolbox™ enhances Turbo Prolog—with more than 80 tools and over 8,000 lines of source code that can easily be incorporated into your programs. It includes about 40 example programs that show you how to use and incorporate your new tools.



New Turbo Prolog Toolbox features include:

- Business graphic generation
- Complete communications package
- File transfers from Reflex, dBASE III, 1-2-3, Symphony
- A unique parser generator
- Sophisticated user-interface design tools

It's the complete developer's toolbox and a major addition to Turbo Prolog. You get a wide variety of menus—pull-down, pop-up, line, tree and box—so you can choose the one that suits your application best. You'll quickly and easily learn how to produce graphics; set up communications with remote devices; read information from Reflex,® dBASE III,® Lotus 1-2-3® and Symphony® files; generate parsers and design user interfaces. All of this for only \$99.95.

Only
\$99.95!



System requirements

Turbo Prolog: IBM PC, XT, AT or true compatibles. PC-DOS (MS-DOS) 2.0 or later. 384K. Turbo Prolog Toolbox requires Turbo Prolog 1.10 or higher. Dual-floppy disk drive or hard disk. 512K.



Turbo Pascal®

The power and high performance of Turbo Pascal is already in the hands of more than half-a-million people. The technically superior Turbo Pascal is the *de facto* worldwide standard and the clear leader.

The Turbo Pascal family includes:

- Turbo Pascal® 3.0
- Turbo Tutor® 2.0
- Turbo Database Toolbox®
- Turbo Editor Toolbox®
- Turbo Graphix Toolbox®
- Turbo GameWorks®
- Turbo Pascal Numerical Methods Toolbox™



Turbo Pascal, the worldwide standard in high-speed compilers, and family.

“ The language deal of the century. **Jeff Duntemann, PC Magazine** ”

New! Turbo Pascal Numerical Methods Toolbox



Only
\$99.95!



As well as a free demo FFT program, you also get Least Squares Fit in 5 different forms:

1. Power
2. Exponential
3. Logarithm
4. 5-term Fourier
5. 5-term Polynomial

They're all ready to compile and run.

All this for only \$99.95!

What our new Numerical Methods Toolbox will do for you now:

- Find solutions to equations
- Interpolations
- Calculus: numerical derivatives and integrals
- Differential equations
- Matrix operations: inversions, determinants and eigenvalues
- Least squares approximations
- Fourier transforms

System requirements

IBM PC, XT, AT or true compatibles. PC-DOS (MS-DOS) 2.0 or later. Turbo Pascal 2.0 or later. Graphics module requires graphics monitor with IBM CGA, IBM EGA, or Hercules compatible adapter card, and requires Turbo Graphix Toolbox. 8087 or 80287 numeric co-processor not required, but recommended for optimal performance. 256K.

Turbo Pascal 3.0.

Includes 8087 & BCD features for 16-bit MS-DOS and CP/M-86 systems. CP/M-80 version minimum memory: 48K; 8087 and BCD features not available. 128K.



Turbo C[®]

Turbo C: The fastest, most efficient and easy-to-use C compiler at any price

Compilation speed is more than 7000 lines a minute, which makes anything less than Turbo C an exercise in slow motion. Expect what only Borland delivers: Quality, Speed, Power and Price.

Turbo C: The C compiler for amateurs and professionals

If you're just beginning and you've "kinda wanted to learn C," now's your chance to do it the easy way. Like Turbo Pascal, Turbo C's got everything to get you going.

If you're already programming in C, switching to Turbo C will considerably increase your productivity and help make your programs both smaller and faster. Actually, writing in Turbo C is a highly productive and effective method—and we speak from experience. Eureka: The Solver and our new generation of software have been developed using Turbo C.

Turbo C: a complete interactive development environment

Free MicroCalc spreadsheet with source code

Like Turbo Pascal and Turbo Prolog, Turbo C comes

with an interactive editor that will show you syntax errors right in your source code. Developing, debugging, and running a Turbo C program is a snap.

Turbo C: The C compiler everybody's been waiting for. Everybody but the competition

Borland's "Quality, Speed, Power and Price" commitment isn't idle corporate chatter. The \$99.95 price tag on Turbo C isn't a "typo," it's real. So if you'd like to learn C in a hurry, pick up the phone. If you're already using C, switch to Turbo C and see the difference for yourself.

System requirements

IBM PC, XT, AT and true compatibles. PC-DOS (MS-DOS) 2.0 or later. One floppy drive. 320K.

Technical Specifications

- Compiler:** One-pass compiler generating linkable object modules and inline assembler. Included is Borland's high performance "Turbo Linker." The object module is compatible with the PC-DOS linker. Supports tiny, small, compact, medium, large, and huge memory model libraries. Can mix models with near and far pointers. Includes floating point emulator (utilizes 8087/80287 if installed).
- Interactive Editor:** The system includes a powerful, interactive full-screen text editor. If the compiler detects an error, the editor automatically positions the cursor appropriately in the source code.
- Development Environment:** A powerful "Make" is included so that managing Turbo C program development is highly efficient. Also includes pull-down menus and windows.
- Links with relocatable object modules** created using Borland's Turbo Prolog into a single program.
- ANSI C compatible.**
- Start-up routine source code included.**
- Both command line and integrated environment versions included.**

*Introductory price—good through July 1, 1987

Sieve benchmark (25 iterations)

Execution time	5.77	1.51	13.79
Object code size	274	197	301

Comparison for Sieve benchmark using Turbo C version 1.0 and the Turbo Linker version 1.0; Microsoft C version 4.0 and the MS overlay linker version 3.51; Lattice C version 3.1 and the MS object linker version 3.05.

... \$99.95!*



Inquiry 43 for End-Users.
Inquiry 44 for DEALERS ONLY.



Features/83

Contents

FEATURES

- Product Preview:**
The Tandon PAC 286..... 85
*by Jonathan Erickson, G. Michael Vose,
and Charles Weston*
An advance look at Tandon's AT-class computer and its
unique disk subsystem and memory management unit.



PAC 286

- Ciarcia's Circuit Cellar:**
Build a Gray-Scale Video Digitizer..... 95
by Steve Ciarcia
ImageWise is a complete digital video system.
- Programming Project:**
Pull-Down Menus in C..... 108
by James L. Pinson
Add a user-friendly menu system
to almost any IBM PC application.
- Build BERT,**
the Basic Educational Robot Trainer, Part 2 113
by Karl Brown
A guide to troubleshooting and programming your robot.

- An Adventure Authoring System** 125
by David Betz
A tour of AdvSys, a tool for writing text adventure games.
- Interactive Fiction as Literature** 135
by Mary Ann Buckles
Adventure games have a literary heritage.

THEME: Desktop Publishing

- Introduction** 147
- The Desktop-Publishing Phenomenon** 149
by John W. Seybold
Personal printing has come a long way in a short time.
- Make My Page!**..... 159
by Thom Holmes
Choosing the best desktop-publishing program
for your needs.
- Designing a Raster-Image Processor** 171
by Jon Barrett and Kirk Reistroffer
The road from screen display to hard copy is circuitous.
- Programming in PostScript**..... 185
by Denis G. Pelli
Techniques and applications in vision research, plus
a survey of PostScript hardware and software.

REVIEWS

- Reviewer's Notebook** 207
by Cathryn Baskin
- High-Speed Internal Modems**..... 209
by Stephen Satchell
An evaluation of 10 units for IBM PC compatibles.
- Compaq's New Carryon**..... 221
by John Unger
This machine combines performance with portability.
- The Commodore 64C** 229
by Alastair J. W. Mayer
An attractive restyling of the Commodore 64.
- SCSI Hard Disk Drives for the Macintosh** 237
by Chris Crawford and Eva White
A look at 10 external 20-megabyte units.



Themes/147

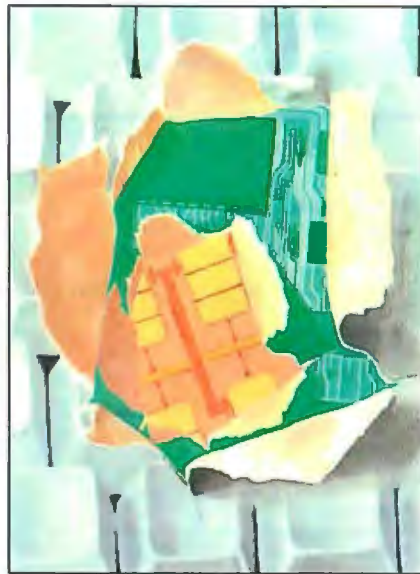

Reviews/205



Kernel/259

BASIC Compilers for the Macintosh 241
by Scott L. Norman
 True BASIC 1.0, ZBASIC 3.01, and PCMacBasic 1.65.

Q&A 2.0 249
by Phillip Robinson
 This file manager has a natural-language interface and a word processor.

Lyrix 251
by George R. Allen
 A word processor that runs on many different computers.

Review Feedback 254
 Readers respond to previous reviews.

KERNEL

Computing at Chaos Manor:
Bye-Bye Big Kat 261
by Jerry Pournelle
 Big Kat leaves Chaos Manor, and Zelda moves in.

According to Webster:
Publish and/or Perish 279
by Bruce Webster
 A visit to the MacWorld Exposition and a look at desktop publishing.

Applications Only: Mostly Mac 293
by Ezra Shapiro
 Ezra looks at Macintosh programs and receives feedback from Acta's author.

Mathematical Recreations:
Around and Around 307
by Robert T. Kurosaka
 Exploring the family of curves known as cycloids using computer graphics.

LISTINGS

From BIX 256

From BYTEnet (617) 861-9764

On Disk see card after 324

In Print see card after 324

DEPARTMENTS

Editorial: All or Nothing in Local Mass Storage 6

Microbytes 9

Letters 16

What's New 29

Events and Clubs 49

Ask BYTE 52

Circuit Cellar Feedback 58

Book Reviews 67

Chaos Manor Mail 317

BOMB and Coming Up in BYTE 390

Editorial Index by company 391

Reader Service 393

BEST OF BIX

Amiga 325

Atari 328

IBM PC and Compatibles 334

Macintosh 340



BYTE (ISSN 0360-5280) is published monthly with additional issues in June and October by McGraw-Hill Inc. Founder: James H. McGraw (1860-1948). Executive, editorial, circulation, and advertising offices: One Phoenix Mill Lane, Peterborough, NH 03458, phone (603) 924-9281. Office hours: Monday through Thursday 8:30 AM--4:30 PM, Friday 8:30 AM--1:00 PM, Eastern Time. Address subscriptions to BYTE Subscriptions, P.O. Box 590, Martinsville, NJ 08836. Postmaster: send address changes, USPS Form 3579, undeliverable copies, and fulfillment questions to BYTE Subscriptions, P.O. Box 596, Martinsville, NJ 08836. Second-class postage paid at Peterborough, NH 03458 and additional mailing offices. Postage paid at Winnipeg, Manitoba. Registration number 9321. Subscriptions are \$22 for one year \$40 for two years, and \$58 for three years in the U.S. and its possessions. In Canada and Mexico, \$25 for one year, \$45 for two years, \$65 for three years. \$69 for one year air delivery to Europe. 31,000 yen for one year air delivery to Japan, 15,600 yen for one year surface delivery to Japan, \$37 surface delivery elsewhere. Air delivery to selected areas at additional rates upon request. Single copy price is \$3.50 in the U.S. and its possessions, \$4.25 in Canada and Mexico, \$4.50 in Europe, and \$5 elsewhere. Foreign subscriptions and sales should be remitted in U.S. funds drawn on a U.S. bank. Please allow six to eight weeks for delivery of first issue. Printed in the United States of America.

Address editorial correspondence to: Editor, BYTE, One Phoenix Mill Lane, Peterborough, NH 03458. Unacceptable manuscripts will be returned if accompanied by sufficient postage. Note responsible for lost manuscripts or photos. Opinions expressed by the authors are not necessarily those of BYTE.

Copyright © 1987 by McGraw-Hill Inc. All rights reserved. Trademark registered in the United States Patent and Trademark Office. Where necessary, permission is granted by the copyright owner for libraries and others registered with the Copyright Clearance Center (CCC) to photocopy any article herein for the flat fee of \$1.50 per copy of the article or any part thereof. Correspondence and payment should be sent directly to the CCC, 29 Congress St., Salem, MA 01970. Specify ISSN 0360-5280/83, \$1.50. Copying done for other than personal or internal reference use without the permission of McGraw-Hill Inc. is prohibited. Requests for special permission or bulk orders should be addressed to the publisher. BYTE is available in microform from University Microfilms International, 300 North Zeeb Rd., Dept. PR, Ann Arbor, MI 48106 or 18 Bedford Row, Dept. PR, London WC1R 4EJ, England.

Subscription questions or problems should be addressed to: BYTE Subscriber Service, P.O. Box 328, Hancock, NH 03449

EXECUTIVE EDITOR, BYTE
Frederic S. Langa**ASSISTANT MANAGING EDITOR**

Glenn Hartwig

CONSULTING EDITORSSteve Ciarcia
Jerry Pournelle
Ezra Shapiro
Bruce Webster**SENIOR TECHNICAL EDITORS**Cathryn Baskin, Reviews
G. Michael Vose, Themes
Gregg Williams, Features**TECHNICAL EDITORS**Dennis Allen
Richard Grehan
Ken Sheldon
George A. Stewart
Jane Morrill Tazelaar
Tom Thompson
Charles D. Weston
Eva White
Stanley Wszola**ASSOCIATE TECHNICAL EDITORS**Curtis Franklin Jr.
Margaret Cook Gurney, Book Reviews**COPY EDITORS**Lauren Stickler, Copy Administrator
Jeff Edmonds
Nancy Hayes
Cathy Kingery
Margaret A. Richard
Warren Williamson
Judy Winkler**ASSISTANTS**Peggy Dunham, Office Manager
Martha Hicks
L. Ryan McCombs
June N. Sheldon**NEWS AND TECHNOLOGY**Gene Smarte, Bureau Chief, Costa Mesa
Jonathan Erickson, Senior Technical Editor,
San Francisco
Rich Malloy, Senior Technical Editor, New York
Cindy Kiddoo, Editorial Assistant, San Francisco**ASSOCIATE NEWS EDITORS**Nicholas Baran, Microbytes
Dennis Barker, Microbytes
Anne Fischer Lent, What's New
Stan Miastkowski, What's New, Best of BIX**CONTRIBUTING EDITORS**Jonathan Amsterdam, programming projects
Mark Dahmke, video, operating systems
Mark Haas, at large
Rik Jadrnicek, CAD, graphics, spreadsheets
Robert T. Kurosaka, mathematical recreations
Alastair J. W. Mayer, software
Alan R. Miller, languages and engineering
Dick Pountain, U.K.
Roger Powell, computers and music
Phillip Robinson, semiconductors
Jon Shiell, high-performance systems**ART**Nancy Rice, Art Director
Joseph A. Gallagher, Assistant Art Director
Jan Muller, Art Assistant
Alan Easton, Drafting**PRODUCTION**David R. Anderson, Production Director
Denise Chartrand
Michael J. Lonsky
Virginia Reardon**TYPOGRAPHY**Sherry McCarthy, Chief Typographer
Selinda Chiquoine
Donna Sweeney**EXECUTIVE EDITOR, BIX**
George Bond**SENIOR EDITOR**

David Betz

ASSOCIATE EDITORSTony Lockwood
Donna Osgood, San Francisco
MICROBYTES DAILY
Dennis Barker, Coordinator, Peterborough
Gene Smarte, Bureau Chief, Costa Mesa
Nicholas Baran, San Francisco
Rick Cook, Phoenix

Jonathan Erickson, San Francisco

Martha Hicks, Peterborough

Anne Fischer Lent, Peterborough

Larry Loeb, Wallingford, CT

Rich Malloy, New York

Brock N. Meeks, La Mesa, CA

Jeff Merron, Peterborough

Stan Miastkowski, Peterborough

Lynne Nadeau, Peterborough

Wayne Rash, Washington, DC

William Webb, Peterborough

GROUP MODERATORSDavid Allen, Applications
Frank Boosman, Artificial Intelligence
Leroy Casterline, Other
Marc Greenfield, Programming Languages
Jim Howard, Graphics

Gary Kendall, Operating Systems

Steve Krenek, Computers

Brock N. Meeks, Telecommunications

Barry Nance, New Technology

Donald Osgood, Computers

Sue Rosenberg, Other

Jon Swanson, Chips

BUSINESS AND MARKETING

Doug Webster, Director (603-924-9027)

Patricia Bausum, Secretary

Denise A. Greene, Customer Service

Brian Warnock, Customer Service

Tammy Burgess, Customer Credit and Billing

TECHNOLOGY

Clayton Lisle, Director, Business Systems Technology, MHIS

Bill Garrison, Business Systems Analyst

Jack Reilly, Business Systems Analyst

ADVERTISING SALESDennis J. Riley, Director of Sales and Marketing
Sandra Foster, Administrative Assistant
ADVERTISING/PRODUCTION (603-924-6448)Lisa Wozmak, Supervisor
Lyda Clark, Senior Account Coordinator
Marion Carlson
Virginia Carpenter
Karen Cilley
Brian Higgins
Wai Chiu Li, Quality Control Manager
Julie Muphree, Advertising/Production
Coordinator**MARKETING COMMUNICATIONS**Horace T. Howland, Director (603-924-3424)
Vicki Reynolds, Promotion Manager
Lisa Jo Steiner, Marketing Assistant
Stephanie Warnesky, Marketing Art Director
Sharon Price, Associate Art Director
Julie Perron, Market Research Analyst
Cynthia Damato Sands, Reader Service
Coordinator**TELEMARKETING**L. Bradley Browne, Director
Susan Boyd, Administrative Assistant**PLANNING AND RESEARCH**Michele Perron, Director
Faith Kluntz, Copyrights Coordinator**FINANCIAL SERVICES**Philip L. Penny, Director of Finance and Services
Kenneth A. King, Business Manager
Christine Lee, Assistant
Linda Short, D/P Manager
Marilyn Haigh
Diane Henry
Vern Rockwell
Lisa Teates
JoAnn Walter**PUBLISHER'S ASSISTANT**

Beverly Jackson

CIRCULATION (800-423-8912)Dan McLaughlin, Director
James Bingham, Single-Copy Sales Manager
Vicki Weston, Assistant Manager
Claudette Carswell, Distribution Coordinator
Karen Desroches, Direct Accounts
Louise Menegus, Back Issues**PERSONNEL**Cheryl Hurd, Office Manager
Patricia Burke, Personnel Coordinator**BUILDING SERVICES/TRAFFIC**Anthony Bennett, Building Services Manager
Mark Monkton, Assistant
Agnes E. Perry, Traffic Assistant**RECEPTIONIST**

Donna Healy

 Officers of McGraw-Hill Information Systems Company: President: Richard B. Miller. Executive Vice Presidents: Frederick P. Jannott, Construction Information Group; Russell C. White, Computers and Communications Information Group; J. Thomas Ryan, Marketing and International. Senior Vice Presidents-Publishers: Laurence Altman, Electronics; Harry L. Brown, BYTE; David J. McGrath, Engineering News-Record. Group Vice Presidents: Frank A. Shinal, Dodge; Peter B. McCuen, Communications Information. Vice Presidents: Robert D. Daleo, Controller; Fred O. Jensen, Planning and Development; Michael J. Koeller, Human Resources; Talat M. Sadiq, Systems Planning and Technology.

Officers of McGraw-Hill, Inc.: Harold W. McGraw, Jr., Chairman; Joseph L. Dionne, President and Chief Executive Officer; Robert N. Landes, Executive Vice President and Secretary; Walter D. Serwatka, Executive Vice President and Chief Financial Officer; Shel F. Asen, Senior Vice President, Manufacturing; Robert J. Bahash, Senior Vice President, Finance and Manufacturing; Ralph R. Schulz, Senior Vice President, Editorial; George R. Elsinger, Vice President, Circulation; Ralph J. Webb, Vice President and Treasurer.

BYTE, BIX, and The Small Systems Journal are registered trademarks of McGraw-Hill Inc.

EDITORIAL AND BUSINESS OFFICE:

One Phoenix Mill Lane, Peterborough, New Hampshire 03458, (603) 924-9281.

West Coast Offices: 425 Battery St., San Francisco, CA 94111, (415) 954-9718; 3001 Red Hill Ave., Building #1, Suite 222, Costa Mesa, CA 92626, (714) 557-6292. **New York Editorial Office:** 1221 Avenue of the Americas, New York, NY 10020, (212) 512-3175.**BYTEnet:** (617) 861-9764 (set modem at 8-1-N or 7-1-E; 300 or 1200 baud).

smARTWORK[®] Keeps Getting Smarter

Smarter Artwork

Three years ago, Wintek engineers created smARTWORK to reduce the time and tedium of laying out their own printed-circuit boards. Thousands of engineers have since discovered the ease of use and sophistication that makes smARTWORK the most popular PCB CAD software available. And thanks to them, smARTWORK keeps getting better.



smARTWORK transforms your IBM PC into a PCB CAD system

Interactive routing, continual design-rule checking, pad shaving, and production-quality 2X artwork have always been a part of smARTWORK. And now that many customer suggestions have become a part of the software, smARTWORK is an even better value. *That's why we offer it with a thirty-day money-back no-nonsense guarantee.*



Using an Epson or IBM dot-matrix printer, you can create 2X artwork and 1X or 2X checkplots in a fraction of the time hand-taping requires

New smARTWORK Features

- Silkscreen layer for component placement and identification
- Text capabilities for all three layers
- Selectable trace widths and pad shapes and sizes
- User-definable library
- Ground planes created with a single command
- Solder-mask and padmaster plots generated automatically
- Quick printer 2X checkplots
- Additional drivers for printers and plotters
- Optional drill-tape and Gerber photoplotter utilities
 - AutoCAD[®].DXF file output
 - Completely updated manual
 - 800 number for free technical assistance

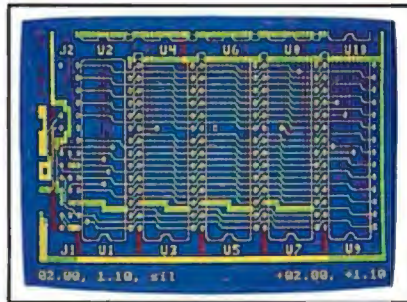

2" by 4" section of a 10" by 16" double-sided board with silkscreen layer



Camera-ready 2X artwork from an HI or HP pen plotter

The Smart Buy. Guaranteed.

Still priced at \$895, smARTWORK is proven, convenient, and fast. Our money-back guarantee lets you try smARTWORK for 30 days at absolutely no risk. Call toll free (800) 742-6809 today and put smARTWORK to work for you tomorrow. That's smart work.

System Requirements

- IBM PC, PC XT, or PC AT with 384K RAM, and DOS V2.0 or later
- IBM Color/Graphics Adapter with RGB color or B&W monitor
- IBM Graphics Printer or Epson FX/MX/RX-series printer, and/or
- Houston Instrument DMP-40, 41, 42, 51, 52, or Hewlett-Packard 7470, 7475, 7550, 7580, 7585, 7586 pen plotter
- Optional Microsoft Mouse

Wintek Corporation
1801 South St.
Lafayette, IN 47904
Telephone: (800) 742-6809
In Indiana: (317) 742-8428
Telex: 70-9079 WINTEK CORP UD



AL00011

Current Versions	
HWIRE	V1.0r2
smARTWORK	V4.2r7

EDITORIAL

All or Nothing in Local Mass Storage

Computer architecture adapts quickly to different business and social needs. Two industry pioneers, Bob Metcalfe of 3Com and Chuck Peddle of Tandon, have introduced new and contrasting products that illustrate well the adaptability of computer architecture. Metcalfe's new product is an elegant diskless workstation—a personal computer with no mass storage of its own. Peddle and his longtime associate Bob Taylor developed Tandon's new Personal Data Pac—a 30-megabyte removable hard disk drive that you can easily remove from your personal computer, carry anywhere, mail, and even drop. Note that the storage medium itself is not removable—the platter remains sealed inside the drive.

Peddle and Taylor have collaborated on important projects for several years. Peddle developed the 6502 microprocessor, the KIM-1, and the Commodore PET. Immediately before moving to Tandon, Peddle and Taylor developed the Victor 9000, an outstanding computer whose success was muted by Victor's financial difficulties.

The Personal Data Pac takes local data storage to new heights because each Pac can carry your entire computing environment in one small, convenient package. The 30-megabyte capacity of each Pac not only lets you carry large amounts of data anywhere but also take along all your software, including terminate-and-stay-resident applications like Ready! and SideKick. This makes any computer equipped with Personal Data Pacs a congenial work environment for those who bring along their own Pacs. Coworkers can easily exchange all the data relating to major projects.

The Pacs are shock-resistant to 300 Gs, so the data is secure in a traveler's briefcase and even in an overnight express package. Furthermore, a system like Tandon's new IBM PC AT compatible, the PAC 286, which has two slots for Personal Data Pacs, provides the fastest and most convenient backup now available—30 megabytes in two and a half minutes.

Tandon has designed some interesting security features into the Personal Data Pac. A password utility provides optional password protection for each Pac. Each Pac has its own coded, permanent serial



Personal Data Pacs from Tandon.



The 3Station diskless workstation.

number. Furthermore, the design of the Personal Data Pac provides support for encryption of all the data on the disk.

In an article beginning on page 85, BYTE editors Jon Erickson, Mike Vose, and Chuck Weston give further depth and detail about the new Tandon PAC 286 and the Personal Data Pac.

Diskless Workstations

The obvious reason for buying a diskless workstation instead of a normal personal computer is to enable a company or government agency to keep data secure. If there is no local removable mass storage for employees to carry with them, they will have a hard time walking out with sensitive financial or military data.

Many companies are selling diskless workstations. 3Com has just introduced a particularly nice one, pictured here. Called the 3Station, the system is a high-performance AT compatible with a memory cache for network communications and battery-backed RAM to configure the system to the needs of the individual user.

The 3Station is the brainchild of Bob Metcalfe, chairman of 3Com and principal developer of Ethernet. Because there

is no local mass storage, the power supply for the 3Station is small, the footprint is tiny, and there is no need for a cooling fan. The 3Station has the convenience of built-in networking hardware, and the reduced number of components gives it an attractive price. (More on the 3Station will appear in the June issue.)

For many computer users, the cost and security advantages of the diskless workstation can't make up for the absence of local, personal data storage. Bob Metcalfe stresses that any user on the network may prefer to use a PC and have local data storage—there's nothing about the 3Station or other diskless workstations to prevent other network users from having individual disk drives. Metcalfe argues that diskless workstations are ideal for some situations, not mandatory for all.

Nevertheless, diskless workstations do have some disadvantages. Without local data storage and the ability to insert a floppy to try new software, individual users will experiment less and develop fewer new solutions to office problems.

Another Voice

During a discussion of diskless workstations at Esther Dyson's 1987 Personal Computer Forum in Phoenix, a voice from the financial community suggested a different approach to data security on networks. Barry Margolius, assistant vice president, corporate staff, Financial Information Systems, Merrill Lynch Pierce Fenner & Smith Inc., pointed out that giving each workstation its own built-in, nonremovable hard disk would prevent people from making off with disks of data and also provide flexibility for each user. This sounds like a good solution to us for both user and company or government agency.

—Phil Lemmons
Editor in Chief

Important Error Correction

Our April review of 50 dot-matrix printers contained an important error. Table 1 greatly overstated the sound in decibels of all the printers in graphics mode. Complete corrected data appears in Review Feedback in this issue. Our apologies for the error.

Maxell Corp. of America, 60 Oxford Drive, Moonachie, NJ 07074



maxell[®]
FLOPPY DISKS
THE GOLD STANDARD

smarterm[®]

The Next Evolutionary Step in Communications Software

In the world of communications, the result of natural selection isn't always "terminal".

You can access your mini computer using standard terminals. But the smarter alternative is an IBM* compatible PC and SmarTerm terminal emulation software—an advanced species of communications software.

Persoft began where most terminal emulation software companies strive to end—with exact, feature-for-feature emulation. Then Persoft took SmarTerm software to the next stage of evolution: superiority.

SmarTerm 240, the latest in the SmarTerm series, not only provides the ReGIS* and Tektronix* graphics capabilities of a DEC* VT240* terminal, but adds capabilities that are only possible through the power of a PC.

Features like error-free data transfer (using Kermit or XMODEM protocols) and programmable softkeys. And now with the new add-on network kit, you can communicate through several popular networks.

SmarTerm 240 is just one example of the most advanced line-up of DEC, Data General* and Tektronix terminal emulation software in the industry.

Make the "natural selection." Ask your local dealer about SmarTerm terminal emulation software. Or contact:

Persoft, Inc.
465 Science Drive
Madison, WI U.S.A. 53711
(608) 273-6000
Telex 759491



VISIT BOOTH 3244
WEST HALL
COMDEX/ATLANTA

DEC Emulation - Inquiry # 245
DG Emulation - Inquiry # 246

persoft[®]

**SmarTerm Terminal Emulation Software
... The Natural Selection**

MICROBYTES

Staff-written highlights of developments in technology and the microcomputer industry.

U.S. Losing Ground in Development of Pure Semiconductors, NASA Exec Says

The United States is rapidly losing ground in the development of "pure semiconductors," semiconductors that can be made only in outer space, NASA administrator James C. Fletcher says. Fletcher was interviewed by *Microbytes Daily* after the dedication of the NAS (Numerical Aerodynamic Simulator) supercomputer in Moffett Field, CA. "Most of the interest in microgravity semiconductor research," he said, "is on the part of Japan and Germany. The Department of Defense and NASA want to do things, but U.S. manufacturers just aren't that interested as of yet."

Fletcher said that the development of pure semiconductors offers the greatest commercial opportunity of all possible microgravity projects (projects that must be completed in zero-gravity environments, such as that of a space station). He said that pure semiconductors, which will be made from gallium arsenide (GaAs), are necessary for the development of cheaper, faster, and more powerful computers. Fletcher pointed out that the most extensive research in GaAs development is taking place in Japan. "We really have got to start worrying about this a little

bit," he said. "Nearly all of our silicon is purchased from Japan now . . . and the greatest interest in gallium arsenide is in Japan." Fletcher then commented that, in the U.S., "the Department of Defense has a very large terrestrial program in producing gallium arsenide, and they have an interest in producing pure gallium arsenide in space."

Key to the development of pure GaAs semiconductors is the building of the first U.S. space station, which would accommodate various microgravity research projects in addition to pure semiconductor development. Scientists can do things in a zero-gravity environment, Fletcher explained, that simply aren't possible on Earth, such as actually mixing gas and water. With semiconductors, "you want pure gallium arsenide to start with and you add the appropriate [impure] materials to make a semiconductor," he explained. In response to questions about the questionable status of the U.S. space station project, Fletcher said that "not building the space station would be the beginning of the end for the manned U.S. space program," and with it, the hope for pure semiconductors.

Walking Two-Legged Robot Controlled by Personal Computer

At the Spring National Design Engineering Show in Chicago recently, a professor from Clemson University (Clemson, SC) demonstrated what is probably the world's first walking two-legged robot. The most impressive feature of the new robot is the fact that it is controlled not by a minicomputer or an expensive parallel-processing system, but by a personal computer.

The robot, which is about two feet tall, is named CURBi, short for Clemson University Robot Biped. It was designed by Yuan Zheng, an assistant professor at Clemson.

CURBi is controlled by an NCR PC6, an IBM PC XT-compatible desk-

top computer running at 8 MHz. According to Zheng, the robot uses a 900-line program and four databases that take up 512K bytes of memory for each step. Like humans, the robot takes a step, momentarily loses its center of gravity, and then readjusts itself by planting its foot for the next step.

Zheng suggests that bipedal devices may someday replace wheelchairs, allowing physically impaired persons easier access to stairs and uneven outdoor terrain. In addition, a bipedal robot would have an advantage over multilegged robots when climbing ladders or moving around in small confined spaces.

continued

Nanobytes

Maynard Electronics (Casselberry, FL) says it's working with several disk drive makers to develop its ERLI (enhanced run length limited) as a standard. ERLI is intended to double the capacity and speed of a hard disk drive. Maynard reports it has sent beta ERLI controller boards to **Seagate, Fuji, Maxtor, MiniScribe, Newbury Data,** and others. After testing, Maynard and some of the drive makers will cooperate on specs that they hope will become an industry standard. . . . About that **new DOS** from **Microsoft** (Redmond, WA), chairman Bill Gates says it will run on existing 80286-based machines, will run most existing applications, and will "provide developers a new view of the world." New DOS won't run on 8086/8088 machines or on floppy-based systems, or on systems with less than 1 megabyte of RAM. The new OS is about as big as 500K bytes. "Microsoft will evolve the current-generation operating system and develop the new generation of systems software," Gates told the Personal Computer Forum. . . . **Expertware** (Santa Clara, CA) has its software-development products now running on Sun Microsystems' Sun-3 line of workstations. The company says its Configuration Management Toolkit and Documentation Support Toolkit take full advantage of the Sun's UNIX operating system and distributed computing capabilities. . . . **Kodak** (Rochester, NY) tells *Microbytes* that progress is being made in its quest for a 3½-inch erasable optical disk. The disk, which will hold 50 megabytes, will employ an optical-magnetic technique that uses a laser's optical energy to thermally alter the disk me-

continued

dium. On the bigger side of things, Kodak recently unwrapped a system that uses 14-inch optical disks to store as much as 1020 gigabytes; each disk packs 3.4 gigabytes. . . .

ExperTelligence (Santa Barbara, CA) is offering a version of its ExperCommon Lisp for educational use. ExperCommon Lisp/ED is sold to schools and students for \$195; it has more than 500 primitives, the company says, as well as N-dimensional arrays and an on-line symbolic debugger. It runs on a Mac Plus. . . .

Tandy (Fort Worth, TX) brought out OS-9 Level Two for the Color Computer 3. The multiuser, multitasking operating system uses windows and includes BASIC09 and utilities. Suggested retail price is \$79.95. . . . Know someone who has made an "outstanding contribution to the theory and practical application of information science"? The folks who award the annual **J.-D. Warnier Prize** for Excellence in Information Science want to hear about him or her. The committee will accept nominations until June 1. Write to Gerald Weinberg, chairman, Warnier Prize Selection Committee, 1725 Gage Blvd., Topeka, KS 66604. Past winners include Alan Kay and Enid Mumford. . . .

Connections is a newsletter about networking Macintoshes, aimed at Mac users who want to swap data with other microcomputers, minicomputers, and mainframes. The bi-monthly publication costs \$60 (\$70 overseas). Connect with the staff at P.O. Box 5894, Fullerton, CA 92635, (714) 738-1492. . . .

Telesis Distributing (Reno, NV) is selling a video-recording system, designed by Calco Digital Equipment, that can store 1230 black-and-white television-quality images on a Syquest 10-megabyte disk cartridge and offers random-access capability (maximum seek time is said to be one-fifth of a second). An analog-style recording technique makes the high storage density possible, the company says. The Video Image File connects to a

continued

Erasable Optical Storage Expected by Year's End

Look for erasable optical storage to make its presence felt before the end of this year, said speakers at the Systems Design and Integration Conference in Santa Clara, CA, recently. Several conference participants agreed that erasable optical storage media and drives will begin appearing in mass quantities during the second half of 1987.

According to Fred Geyer, general manager of Magneto-optical Drives and Media for Verbatim Corp. (Sunnyvale, CA), a number of Japanese manufacturers will introduce 5¼-inch erasable optical media that provide as much as 200 megabytes for less than \$1 per megabyte of storage. Typical media will have 14,000 tracks per inch, and drives will provide a minimum access time of 40 ms. Although less

than \$1 per megabyte for storage media is not cheap when compared to current magnetic storage costs, manufacturers view it as a critical price point. Geyer went on to say that Verbatim will have similar evaluation units available in 1987 but will not begin production until early 1988.

In other developments related to optical storage, Phil Devin, a senior analyst for Dataquest, told conference attendees that he predicts "IBM will announce a WORM product within the next 90 days," but he would not elaborate on his comment. Later in the day, however, Kenneth Majithia, a design engineer for IBM's optical storage division, told Microbytes Daily that such an announcement was "news to me."

Scanners Hit Technical Limits; Need More Processing Power

Optical scanners, increasingly being used in desktop publishing and other applications, have just about reached their technical limits, said speakers at the Microsoft CD-ROM Conference in Seattle. According to Jim Fruchterman of Palantir Corp. (Santa Clara, CA), a manufacturer of midrange scanners, both text-only optical-character recognition scanners (OCR) and graphics/text document-processing scanners (DPS) have mastered simple character recognition, the first layer of a three-part problem. Some scanners have even mastered the second layer, character attribute identification (point size, font, etc.). However, the third and most technologically difficult layer, said Fruchterman, is for the machine to determine what the character means, a job that requires more processing power than current scanners have.

Bill Zoellick, director of the Alexandria Institute, a nonprofit CD-ROM center, went on to say that the ability to determine what the character means is

tied into the concept of pattern recognition where the whole page is scanned. "This activity is right for technologies like parallel processing," he said, "where one processor is looking at the pattern on the page, others are looking at the characters, and still others at the graphics." Art Crotzer, of TMS Inc. (Stillwater, OK), a data conversion company that specializes in CD-ROM applications, added that the next generation of scanners will incorporate expert systems and artificial intelligence to make pattern recognition and textual analysis possible. Such technologies, Fruchterman said, will enable scanners to tell the difference between a 0 (zero) and the letter O or between the letter l and the number 1.

Gary Hendrix, of Symantec (Cupertino, CA), makers of the Q&A natural-language database, added that the technology to "read text and understand it as opposed to just scanning text is a long way away . . . perhaps a decade away."

XLISP Program Plays Risk

Because of its complexity, the Parker Brothers board game Risk offers a good model for AI planning systems. Scott Welser, an engineer at KnowledgeWare (Ann Arbor, MI), is designing a plan-generation program to play Risk.

The game is based on a model of world conquest. Players take turns trying to conquer countries and attempting

to occupy whole continents. The outcome of each assault is decided by rolling dice.

Wesler's program, called Alex, was written in XLISP. (XLISP, by the way, is a low-cost implementation of LISP written by BIX's own programmer-in-residence, David Betz.) In its

continued

We invented the modem that makes fewer demands on your PC.

The Ven-Tel Half Card™ modem. All the power and speed of our regular modems, but with some major advantages for people who demand versatility from their PC.

Regular modems plug into one of your computer's full-size slots. Just like expansion boards—color boards, graphics cards and memory expanders.

The Ven-Tel Half Card modem is different. It plugs into a short slot, freeing up a long slot so your PC can handle an additional function. And while other modems have about 300 components, ours has 70. So it not only demands less space from your computer—it also demands less power and generates less heat. Your PC

stays cool and stress-free.

Competitively priced, the Half Card modem is available in both 1200 baud and 2400 baud speeds. And it's backed by Ven-Tel's free *five-year* warranty. No other major manufacturer even comes close.

If you make a lot of demands on your PC... demand the less-demanding modem: The Ven-Tel PC Modem Half Card.



Ven-Tel
Modems

Our free 24-page booklet, "How To Select The Correct Modem," contains specific information about our full line of modems. To request your copy, call 800-538-5121. In California, call 408-727-5721.

microcomputer via the RS-232C port. . . . **TeleRobotics International** (Knoxville, TN) reportedly will start marketing this month a software package that writes programs. Course Builder, which runs on a Macintosh, lets you construct a program using flowcharts and symbols. The software then converts the input into C code. . . . **Herbert Schoor**, director of AI technology at **IBM**, told the IEEE AI Applications Conference (in Orlando, FL) that around 90 expert systems are in use at Big Blue. The systems tend to be procedural advisors helping workers perform diagnostics and usually involve fewer than 500 rules. One such program checks disk storage systems at the firm's San Diego factory.

current form, Alex runs on an IBM PC.

Because of the large number of possible moves in Risk, and the random nature introduced by the dice, a common search tree of all possible moves and countermoves would be practically impossible to build. As an alternative, Alex uses a planning system. In this system, the goal of winning the game is divided into a series of tasks, which are subdivided in turn into a series of

subtasks. At each turn in the game, an Alex's Task Noticer filters out those tasks that are not possible to accomplish and ranks the desirability of those that are. Alex then executes the most desirable of the possible task plans.

Although the program cannot yet play a full game, it can plan and execute the beginning moves. Wesler said it will be relatively easy to add a number of tasks for finishing the game.

Motorola's RISC Chip to Include Hundreds of Instructions

What does Motorola's semiconductor group (Austin, TX) do for an encore after its 68000 series? The 78000 series of RISC processors.

RISC processors have fewer instructions for a programmer to use; however, the ones that are there are fast. While a true RISC machine might have only 50 very fast instructions to operate on, the 78000 is expected to have in

the range of 150 to 200. Additional chips to "glue" the processor to other computer elements might also be forthcoming.

Sources tell Microbytes that the first Motorola 78000 chips will be available in limited sampling quantity by the third quarter of this year. Pricing is not firm, but it is expected to be in the low three-digit range.

Notes from the Personal Computer Forum: Warnock Compares Chips; Kahn Decries 'Look and Feel'; Kapor Sees Long Wait for 386 Applications, but Gates Doesn't

John Warnock, founder of Adobe Systems (Palo Alto, CA), was asked at the Personal Computer Forum, held in Phoenix, to compare the 80386 and the 68000 family of processors. "With the 68000," Warnock said, "the large linear address space is already there. The transition to the 68020 is very simple. There is also lots of developer support from Apple." He contrasted this with the 80386 and the Microsoft Windows environment. "There is a cost extracted by Windows in terms of memory. Our application is large. The 80386 with Windows is attractive, but the time frame is the problem."

Philippe Kahn, president of Borland International (Scotts Valley, CA), said at the Forum that neither UNIX nor the new DOS from Microsoft has a competitive advantage. "Both are multitasking," he said. "Both are memory-consuming. Both require high-powered chips. There's not a lot of advantage on either side, and we're seeing more and more

interest in UNIX."

Kahn also said he deplors the current state of discussions of "look and feel" litigation in the software industry. "It's not nice to steal from other people," Kahn said. "On the other hand, it's terrible if F1 stands for something different in every single program. If there was anything to 'look and feel,' Las Vegas would have sued Atlantic City and would own it."

The man who helped bring Lotus 1-2-3 to market, Mitch Kapor, forecast a long wait for application software that takes advantage of the 80386. "The development cycle for applications for the 80386 is going to be longer than expected," Kapor said. "The 80386 needs the support of a graphics environment, development tools, and so on. We're looking at 1990 before customers derive significant value from 80386 applications."

But Bill Gates, chairman of Microsoft (Redmond, WA), disagreed. "It won't be the 1990s before you see milestone applications for the 386,"

Gates said. "To see what's coming, you can look up to software on high-end workstations. We'll see some pretty amazing stuff on 386s before the 1990s. Basic features of the chip have been well understood for a long time."

In a panel discussion on new directions of applications, Robert Carr, chief scientist at Ashton-Tate (Torrance, CA), said, "We're coming into an era in which stand-alone products cannot deliver the benefits users want." Carr also noted, "It's a fragmented world now with new DOS, old DOS, UNIX, and the Macintosh operating system."

Paul Allen, cofounder of Microsoft and now heading Asymetrix (Bellevue, WA), said, "Applications programs need the ability to represent users' thought processes in both procedures and data structures."

Asymetrix is developing an application using a proprietary LISP-like language that runs on top of Microsoft Windows (see Microbytes in the January issue, page 12).

TECHNOLOGY NEWS WANTED. *The news staff at BYTE is always interested in hearing about new technological and scientific developments that might have an impact on microcomputers and the people who use them. We also want to keep track of innovative uses of that technology. If you know of advances or projects that involve research relevant to microcomputing and want to share that information, please contact us. Call the Microbytes staff at (603) 924-9281, send mail on BIX to Microbytes, or write to us at One Phoenix Mill Lane, Peterborough, NH 03458.*

GOODBYE, IBM...



THANKS FOR THE MEMORIES

Have you ever noticed how time seems to change everything? Fashions change. Technology changes. Even the microcomputers we use change. Maybe that's why so many of our customers are saying goodbye to IBM in favor of a "good buy" from Wells American.

As time goes by, more and more computer users are realizing what an extraordinary value our A★Star II® truly is. It's the *only* AT class microcomputer that can run at 6, 8, 10 and 12 MHz! It's also the *only* PC/AT compatible that's "network ready." Better yet, each A★Star II now comes with your choice of keyboards - the original AT version or the enhanced "RT" style. Best of all, A★Star II prices start at only \$995!

But what about quality and support? Don't worry! We've been making microcomputers *longer* than IBM! And it shows. Our A★Star® computers have been top

rated by leading industry trade journals. Even so, we've heard that some "big blue" old-timers still worry about trading their IBM "security" blanket for better priced, higher performance equipment. (Remember how difficult it was to give up *your* baby blanket?) That's why we've arranged

for RCA, one of the world's largest technical service organizations with 18,000 employees, to provide low cost, nationwide maintenance for our A★Star II. And if that's not enough, every unit includes free schematics and a no risk money-back guarantee.

THE A★STAR II IS MADE IN THE USA.



Still need a blanket? We've got you covered! Try out one of our A★Star II's and we'll send you one. It's baby blue, monogrammed and...it's absolutely free! We'll also include a \$395 option, at no charge, with your first A★Star II purchase. This offer *is* limited, so call or write us today. Just because you'll be saying goodbye to IBM doesn't mean you'll have to say goodbye to quality, support *or* security. Besides, at least you'll still have your memories...and your money!

 **Wells American.**

Corporate Headquarters: 3243 Sunset Boulevard • West Columbia, South Carolina 29169 • 803/796-7800 • TWX 510-601-2645

IBM, Personal Computer AT and AT are trademarks of International Business Machines.

"Rampage" With 2 Megabytes Of Memory Is The Perfect Addition To Our Installed Base Of PC/XTs.

For years we've equipped all of our PCs with AST products, like SixPakPlus.* But, Debbie ...here in accounting...needed more than 640K for her Lotus* 1-2-3* expanded memory spreadsheet. She suggested an



AST Rampage board with two megabytes of expanded memory.

We bought her the Rampage and the results were incredible. Now, Debbie is able to fully use her expanded memory applications.

Debbie has been promoted. And now all of our older PCs and XT's have Rampage boards!"

"AST's Premium Series In Flexibility"

"With SixPakPremium/EGA We Have a Versatile, Multifunction/Memory/Graphics Solution In A Single Slot.

Meet Tony, our Financial Officer. He uses expanded memory for large spreadsheets, a parallel port for his printer, a serial port for a mouse and EGA capabilities for eye dazzling color graphics.

His XT is equipped with SixPakPremium/EGA. It delivers all the features of SixPakPremium with complete graphics capabilities—on a single board. And it's compatible with popular monochrome, color and enhanced color displays.

Tony has talked about his graphics capabilities so much



"For New PC/XTs, SixPakPremium™ Gives Us The Right Combination Of Multifunction Features and Expanded Memory In A Single Slot.

Today is Jim's first day. His new PC XT is equipped with AST's SixPakPremium. It gives him all the features of a SixPakPlus and Rampage—combined into a single slot.

Even though Jim only needs



one megabyte of memory now, as he develops his skills and projects, he'll be able to add a second megabyte of memory to the

SixPakPremium board. There's also a serial port, parallel port and battery-backed clock/calendar.

Jim represents a new generation in the company. So does SixPakPremium. They're the future!"

ies Boards Give Us Tailoring Our PCs."

that now other departments are requesting SixPakPremium/EGA... Engineering, Sales, even Advertising.

We trust Tony to know finances. And he's found us a bargain in SixPakPremium/EGA."

"How We Increased Our Productivity With

The AST Premium Series!

To take full advantage of expanded memory, AST includes an operating environment software package with every Premium Series board. With it Jim, Debbie and Tony can load applications into memory once in the morning. Then they're able to move instantly between the applications and even execute multiple tasks at the same time.

For example, they can sort a dBASE III® file, calculate a Lotus 1-2-3 spreadsheet and edit a WordStar® document all at the same time... on the same PC!"



"Now Get A Special Offer On Lotus Metro!

Buy an AST Premium Series Board before June 30th and get a special offer on your purchase of Metro. Metro is a memory-resident, desktop-management program with 12 accessories and a macro generator. It's designed to help you save time by providing greater access to the power of your PC!"

To Learn More Call (714) 863-1480. Or send the coupon to AST at the address below.

AST markets products worldwide—in Europe call: 441 568 4350; in the Far East call: 852 0499 9113; in Canada call 416 826 7514. AST the AST logo, Rampage and SixPakPlus registered trademarks and Premium Series and SixPakPremium trademarks of AST Research, Inc. Lotus and 1-2-3 registered and Metro trademarks of Lotus Development Corp. dBASE III registered trademark of Ashton-Tate. WordStar registered trademark of MicroPro International. Copyright © 1986 AST Research, Inc. All rights reserved.

YES! Send me more information today on AST's Premium Series.

Name _____

Title _____

Company _____

Address _____

City/State/Zip _____

Telephone () _____

Send to: AST Research, Inc., 2121 Alton Avenue, Irvine, California 92714-4922, Attn: M. C. 5/87



AST RESEARCH INC.

LETTERS

Subsampling Revealed

In the February BYTE, you published the article "Another Approach to Data Compression," by Robert J. Sciamanda. The technique he suggests is interesting and useful to someone who knows what he or she is doing, as the author obviously must. Any procedure that helps someone understand the effects of aliasing in the data is certainly to be applauded.

However, I offer a caveat about Sciamanda's method. It is not "data compression," as the title implies, but merely subsampling.

Before any subsampling, one should plot the spectrum, or at least the Fourier transform, to see where the power lies. If there is very little power at high frequencies, then this data can be subsampled. A much better technique, however, is to filter the series to suppress the high frequencies entirely, and then subsample. The reason for this is that if there is a concentration of energy at any of the higher frequencies (that will not be sampled adequately by the lower sampling rate), this higher frequency power obviously will be aliased to some lower frequency. For example, Sciamanda uses an example of an accuracy of 0.5 percent in the "reconstructed" data. Because he knows what he is doing, this is a safe bet on only 50 samples. However, if someone decided to do it carefully, and with a longer data set produced 1000 Fourier frequencies, only 0.1 percent of the energy would be in each frequency band; therefore, *all* the power in five adjacent frequency bands could be lost or gained at the 0.5 percent accuracy criterion.

Wilton Sturges
Florida State University
Tallahassee, FL

I Have

In reference to "Anybody Here Seen Loglan?" by John Hodges (Letters, February BYTE):

James Cooke Brown is alive and well, working at the Loglan Institute Inc.

The Loglan Institute Inc.
1701 N.E. 75th St.
Gainesville, FL 32601
(904) 371-9574

John Hodges obviously appreciates the potentials of the unambiguous parsing

nature of Loglan in computer programming.

The Institute has several Loglan computer tutors for learning the basic primitives and affixes. Other computer tutorial programs are being developed. The older publications are now out of print, but new materials are being prepared.

The Institute continues to operate on a shoestring. However, a small group of individuals continues voluntary contributions to the Loglan research. Contributions from Institute members and Jim Brown cover the necessary overhead. I am sure new members would be welcomed.

Glen B. Haydon
La Honda, CA

Random Questions

In the article "Testing Intrinsic Random-Number Generators" (January BYTE), the authors assert that the IBM PC has only a single cycle of random numbers, of length 65,536. This is patently false. To prove this point, generate a random number in BASIC, then compare all subsequent numbers generated without reseeding the generator, and count the number of values generated before a duplication is found. In two lines of code and five minutes, I was able to generate well over 100,000 numbers without a duplication. In less than 15 minutes, more than 250,000 were generated without a duplication.

The authors also state that Applesoft Integer BASIC can generate only a single cycle of 32,767 random numbers. However, they fail to mention that Applesoft Integer BASIC can only represent 32,767 positive integers! Is it possible that the authors testing programs for the PC rounded the floating-point random numbers generated to integers? This is never stated, but the inference is clear from their reference to the "flaws" of the Integer BASIC generator.

These inaccuracies call the integrity of the entire article into question. Amazingly, these conclusions were published before in "Interfaces." Were they not questioned previously?

Either my colleagues and I or the authors are amazingly naive concerning the details of various versions of BASIC. If the authors are defining random numbers as positive integers, they could still

have generated more than 65,536 simply by multiplying the generated numbers by 1 million instead of rounding them.

I hope that either I completely misunderstood the article or some important information was inadvertently omitted. If not, publishing such an article is an insult to the normally high technical standards of your publication. I look forward to a reply concerning this matter.

Dean Shutt
Anchorage, AK

The authors' response:

My coauthors and I are pleased to respond to the questions that have been raised. The "inaccuracies" to which Mr. Shutt refers turn out not to be inaccuracies at all. We respond, point by point, as follows:

1. The IBM PC XT, when testing BASIC and BASICA, has a single cycle of 65,536 numbers prior to repetition of a sequence. The program listing shown below has been used to verify this finding.

```
10 DIM X(10),Y(10)
20 CLS
100 RANDOMIZE 111
200 FOR I = 1 TO 10
210 X(I) = RND
220 NEXT I
230 XX = X(1)
250 COUNT = 9
260 FOR I = 1 TO 25000
270 YY = RND
271 COUNT = COUNT + 1
272 LOCATE 10,10
273 PRINT USING "#####";COUNT
280 NEXT I
300 FOR I = 1 TO 1000
310 FOR J = 1 TO 1000
320 COUNT = COUNT + 1
325 IF INT(COUNT/100) < >
COUNT/100 GOTO 400
```

continued

LETTERS POLICY: To be considered for publication, a letter must be typed double-spaced on one side of the paper and must include your name and address. Comments and ideas should be expressed as clearly and concisely as possible. Listings and tables may be printed along with a letter if they are short and legible.

Because BYTE receives hundreds of letters each month, not all of them can be published. Letters can not be returned to authors. Generally, it takes four months from the time BYTE receives a letter until it is published.

YOU ARE ABOUT TO BE SEDUCED BY POWER AND MONEY.

Admit it. You're intrigued with the idea of C programming. You may be working in BASIC, Pascal or Assembler now. But you're drawn to the power, portability and flexibility of C. And if money is what motivates you, imagine having it all for just \$75 with Mark Williams Let's C.*

EVERYTHING YOU COULD ASK FOR IN A C COMPILER.

Let's C is no mere training tool. It's a complete, high quality C compiler. With the speed and code density to run your programs fast and lean. It won't get you sidetracked on some quirky aberration of C; Let's C supports the complete Kernighan & Ritchie C language—to the letter. And it comes from the family of Mark Williams C compilers, the name chosen by DEC, Intel, Wang and thousands of professional programmers.

POWERFUL UTILITIES ARE A REAL BONUS

Let's C doesn't stop with being a high performance C compiler. It includes utilities you'd expect to pay extra for—like a linker and assembler plus the MicroEMACS full screen editor with source code included. Having the source code not only allows you to customize the editor, it offers a close up, fully commented view of C programming at its best.

REVIEWERS ARE SOLD ON LET'S C, TOO.

"Let's C is an inexpensive, high-quality programming package...with all the tools you will need to

NEW VERSION 4.0 FEATURES

- ★ Now compiles twice as fast
- ★ Integrated edit-compile cycle; editor automatically points to errors
- ★ Includes both small and large memory model
- For the IBM-PC and Compatibles
- Fast compact code plus register variables
- Full Kernighan & Ritchie C and extensions
- Full UNIX compatibility and complete libraries
- Many powerful utilities including linker, assembler, archiver, cc one-step compiling, egrep, pr, tail, wc
- MicroEMACS full screen editor with source
- Supported by dozens of third party libraries
- Not copy protected

**60 DAY MONEY BACK GUARANTEE
NOW AVAILABLE IN CANADA**

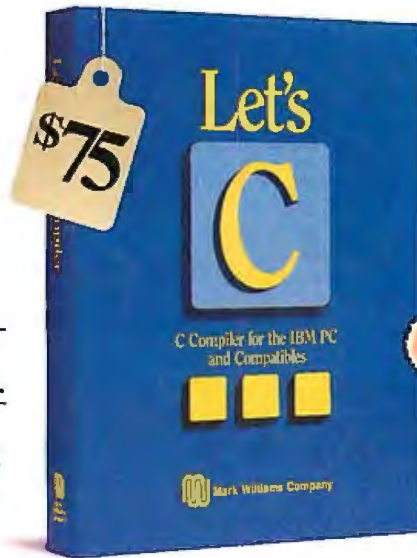

create applications."

—William G. Wong, *BYTE*, August 1986.

"Let's C is a thoroughly professional C environment loaded with tools and programming utilities...another fine Mark Williams product."

—Christopher Skelly, *COMPUTER LANGUAGE*, February 1986

"The performance and documentation of the \$75 Let's C compiler rival those of C compilers for the PC currently being sold for \$500... highly recommended..."

—Marty Franz, *PC TECH JOURNAL*, August 1986

ADD THE *csd* DEBUGGER AND CUT DEVELOPMENT TIME IN HALF.

Invest another \$75 and you've got Mark Williams revolutionary source level debugger. *csd* lets you bypass clunky assembler and actually debug in C. That's a big help when you're learning C and indispensable when you're programming. *csd* combines the interactive advantages of an interpreter with the speed of a compiler, slicing development time in half. This is how Byte Magazine summed it up: "*csd* is close to the ideal debugging environment." William G. Wong, *BYTE*, August 1986



ARE YOU STILL RESISTING?

If there's any doubt that now's the time to get your hands on the power of C, consider Mark Williams 60-day money back guarantee. You can't lose. But with Let's C and *csd*, imagine what you could gain.

Ask for Let's C and *csd* at your software dealer's, in the software department of your favorite bookstore, through the Express Program at over 5500 Radio Shack stores or order now by calling 1-800-MWC-1700.*

*In Illinois call 312-472-6659



**Mark
Williams
Company**

1430 West Wrightwood, Chicago, Illinois 60614

© 1986, Mark Williams Company
Let's C is a registered trademark of the Mark Williams Company
UNIX is a trademark of Bell Labs.

Inquiry 188

MARK WILLIAMS LET'S C. ONLY \$75.

Attention all FX80, FX100, JX, RX, & MX owners:

You already own half of a great printer

Dealer inquiries welcome.

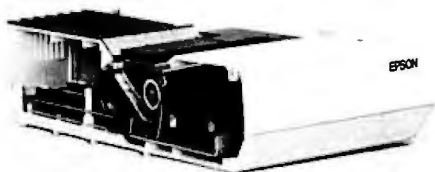

Now Only \$79.95

Now for \$79.95 you can own the rest. You see, today's new dot matrix printers offer a lot more features.

But now, a Dots-Perfect upgrade kit will make your printer work like the new models in minutes—at a fraction of their cost!

For example, with a Dots-Perfect the "dotty" look is gone! In its place is NLQ (Near Letter Quality), a feature that produces printed characters almost as sharp as a daisy wheel or laser printer.

NLQ: Like Having Two Printers

NLQ is not just "double striking." It's a completely redesigned letter form that reshapes each character. Characters are actually formed by four times the normal dot resolution.

And since NLQ can be switched on or off from the touch of a button, you can switch modes whenever you wish.

Installs In Minutes

You can install a Dots-Perfect in minutes with an ordinary screwdriver by following our easy-to-understand illustrated instructions.

All you need do is unplug the existing chips and replace them with a Dots-Perfect—that's all there is to it!

Doesn't Get In Your Way

Dots-Perfect is easy to operate because it actually becomes part of your printer.

It requires no software itself, so it

can be used with every software package.

And you control it from the printer's existing control panel buttons.

You can choose from over 160 printing modes like condensed, double-wide, italic, high-speed draft, or even combinations. All switched on and off at the touch of a button.

Samples shown actual size

NLQ abcdefghijklm
 Condensed Fine Print
 Emphasized
Double-Wide
Italics Underline
 Or Hundreds of Combinations!

Dots-Perfect even has a unique panel button controlled buffer clear command.

I.B.M. Graphics

FX, JX and MX versions of Dots-Perfect will even permit switching from the standard Epson® character set to the IBM®Graphics Printer set, allowing you to print IBM screens exactly as they appear on your computer. All three versions have all Graflex Plus™ features, even the MX version.

And, every Dots-Perfect is backed with a full year's warranty.

So, call now toll-free and use your Visa, MasterCard, or American Express card.

Don't replace your printer, upgrade it!

1-800-368-7737

(Anywhere in the United States or Canada)

g Sample of letter with Dots-Perfect

Dots-Perfect™

Dresselhaus

Sample of letter without Dots-Perfect



8560 Vineyard Ave., Ste. 405, Rancho Cucamonga, CA 91730

(714) 945-5600

An upgrade kit for EPSON FX, JX, RX, & MX printers

IBM is a registered trademark of International Business Machines Corp. Graflex Plus is a trademark of Epson America, Inc. Epson is a registered trademark of Epson America, Inc.

LETTERS

```

330 LOCATE 10,10
340 PRINT USING "#####";COUNT
400 YY = RND
410 IF YY < > XX GOTO 500
415 Y(1) = YY
420 FOR K = 2 TO 10
430 Y(K) = RND
440 NEXT K
450 GOTO 600
500 NEXT J
510 NEXT I
600 LOCATE 12
610 FOR I = 1 TO 10
620 PRINT USING "###.#####
###.#####";X(I),Y(I)
630 NEXT I

```

We have not, of course, seen the "two lines of code" Mr. Shutt refers to in his letter, but we firmly stand by our statement. Furthermore, although we find no evidence for "leading tails" of numbers prior to entering the cycle when using BASIC or BASICA, failure to test for leading tails of random numbers accounts for the erroneous claim that the random-number generator in Applesoft BASIC has long cycles. Thus the first paragraph of the letter is without basis in fact.

2. In paragraph 2, Mr. Shutt seems to claim that since Applesoft Integer BASIC can represent 32,767 positive integers, the random-number generator is therefore exonerated. This comment misses the point, which is that 32,767 is not a sufficiently long cycle for serious simulation work. The explanation for the length of the cycle is completely irrelevant.

3. Paragraph 2 also questions whether we may have rounded off floating-point numbers to integers when testing random-number generators. We did not round off to integers, since to do so would clearly be foolish.

4. In the fourth paragraph, Mr. Shutt asserts that "they could still have generated more than 65,536 simply by multiplying the generated numbers by 1 million instead of rounding them." Any mathematical transformation of two equal quantities yields two equal quantities. The problem of cycles of random numbers cannot be avoided by any transformation, since a transformation of equal streams of numbers leaves you with numbers that are changed in magnitude, but still equal.

Doan T. Modianos
Robert C. Scott
Larry W. Cornwell

Inside and Out

I read with interest the article "Calculating the Area of an Irregular Shape," by Rene Stolk and George Ettershank (February BYTE). A similar article, "The Universal Area Calculator" by Frank Ty-

continued

A disk each month delivered to you...

packed with programs for your Apple, IBM PC, C64/128 or Macintosh.

\$20 Super Discount

DISCOVER UPTIME. You deserve the best from your computer. Have the best and save the most with UPTIME.

We make it easy and inexpensive — a disk each month. You deserve value. At UPTIME we believe in value. That's why each month 30,000 people like you enjoy a disk packed full of programs and information.

Make life easier & get more from your computer. Organize your life and be more productive with **home management** and **finance** programs. Have fun learning with our **educational** programs and fun relaxing with **games** and **adventures**. You will find **business, graphics, utilities & more!**

At least eight great programs on every disk. What's the opposite of "downtime"? It's UPTIME, of course. Just imagine ... a disk each and every month, delivered right to your door and packed with programs for your micro.

Subscribe now, with our introductory offer! Satisfaction guaranteed, or your money back. Make the very next disk yours! Fill in the coupon and return it to us, or simply call. We'll start your UPTIME subscription immediately.

Call
1-800-437-0033
Today!



QUALITY PROGRAMS
LESS THAN
\$1.00 each

Inquiry 360

NOW
FOR ALL
MICRO
COMPUTERS

A Typical Disk Includes:

- Label Magic ■ Living Art ■ File Doctor ■ Calendar
- One Foundation ■ Financial Package ■ Decision Maker ■ Tips and Hints ■ News and Views ■ Product Reviews

I'LL BYTE!!! I'm a computer enthusiast who wants more. Please start my subscription to UPTIME immediately.

\$20 SUPER DISCOUNT SAVE \$109.00 → 12 Disk Issues \$99 \$69

Name _____ Address _____ City _____

Type of Computer _____

Bill my: Visa MC Exp. Date _____

Signature _____ Account No. _____

3 Disk Issues \$36 (Add \$2 per issue in foreign countries, except Canada and APO)

1 Trial Issue \$14.95

State _____ Zip _____

Send to:
UPTIME • PO Box 299
Newport, RI 02840
(401) 849-4925

C Programmers!

db_VISTA™: high-speed DBMS written exclusively for C NOW offers SQL-based query

High-Speed data retrieval and access... just two benefits of using Raima's network model DBMS, db_VISTA. Combine these design benefits with those of C—speed, portability, efficiency, and you begin to understand db_VISTA's real measure... performance.

**Says, Dave Schmitt,
President of Lattice, Inc.**

"If you are looking for a sophisticated C programmer's database, db_VISTA is it. It lets you easily build complex databases with many interconnected record types. Raima's customer support and documentation is excellent. Source code availability and a royalty-free run-time is a big plus."

db_QUERY™: new simplicity retains performance!

db_QUERY, our new C-linkable, SQL-based, ad-hoc query and report writing facility... provides a simple, relational view of db_VISTA's complex network database. No longer will you give up performance for simplicity... combine db_QUERY with db_VISTA... you have both!

- **Written in C**
- **Royalty-Free**
- **Source Code Available**
- **Multi-user and LAN capability**
- **Fast B-tree indexing method**
- **Transaction processing**
- **Faster without Data Redundancy**
- **Complete Documentation**
- **Operating systems:** MS-DOS, PC-DOS, UNIX, XENIX, SCO XENIX, UNOS, ULTRIX, VMS
- **C compilers:** Lattice, Microsoft, IBM, DeSmet, Aztec, Computer Innovations, XENIX and UNIX

30-day Money-Back Guarantee

Royalty Free Price Schedule

	db_VISTA	db_QUERY
Single-user	\$ 195	\$ 195
Single-user w/Source	\$ 495	\$ 495
Multi-user	\$ 495	\$ 495
Multi-user w/Source	\$ 990	\$ 990
NEW:		
VAX Multi-user	\$ 990	\$ 990
VAX Multi-user w/Source	\$1980	\$1980



Call Toll-Free Today!

1 (800) db-RAIMA

(that's 1-800-327-2462)

—OR Call 1-206-828-4636



3055-112 N.E., Bellevue, WA 98004 USA
(206) 828-4636 Telex: 6503018237 MCI UW

BY57

LETTERS

mon, appeared in the September 1986 issue of *Computer Shopper*. Both articles noted that the sign of the area would be positive if the perimeter were traced in one direction, and negative if the perimeter were traced in the opposite direction. But both articles failed to mention an important extension of the area-finding idea which relies on the sign difference.

Typically, the technique yields a positive area if the vertices are taken in a counterclockwise direction, and a negative area if the vertices are taken in a clockwise direction. Thus it is possible to find the area between two closed curves by traversing the outer curve in a counterclockwise direction, making a "cut" to go from the outer curve to the inner curve, traversing the inner curve in a clockwise direction, and returning along the cut to the outer curve. The user only needs to be sure that the cut from the outer curve to the inner curve is retraced when returning to the outer curve.

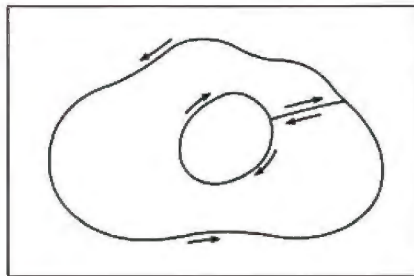

Of course, this is just a computerized mechanization of the old surveyor's area-finding tool, the planimeter. The technique is a limiting case of the method for finding the area of a triangle, which appears in many analytic geometry texts.

Palmer O. Hanson, Jr.
Largo, FL

Easy as π

BYTE readers may be interested in a little-known pair of formulas that can be used to calculate π , the ratio of the circumference of any circle to its diameter. These simple, fast-converging formulas were not mentioned in the interesting article "Computing Pi," by David J. Crawford (May 1985 BYTE), nor have I seen them elsewhere in computing or mathematical literature. Yet they are so simple and effective that they must have been discovered and published by others.

To illustrate, it is hard to imagine a shorter Microsoft BASIC program than the following one-liner, to compute π and print out intermediate results:

```
10 P=2: FOR K=1 TO 12:
S=SQR(S+2): P=2*P/S:
PRINT P: NEXT
```

```
RUN
2.828427 3.061468 3.121445
3.136548 3.140331 3.141277
3.141514 3.141573 3.141588
3.141591 3.141592 3.141593
```

The two formulas, used with suitable starting values, are given as follows:

$$\text{Let } s_k = \sqrt{s_{k-1} + 2}$$

and

$$p_k = 2p_{k-1}/s_k,$$

starting with $k=1$, $s_0=0$, and $p_0=2$.

It can be shown that the limit of p_k is π and that this sequence increases monotonically (i.e., each p_k is equal to or larger than its predecessor).

The formulas are derived from summing the chords of central angles of a unit circle starting first with a 180-degree angle, then with two 90-degree angles, then four 45-degree angles, and so on. It is intuitively evident that each succeeding sum of these chords approaches more closely the arc length of the semicircle, and hence π , as an upper bound.

Further, it can be shown that a q_k can be defined in terms of the pair of values s_k and p_k , to be the sum of outside tangents parallel to the chords, and will always be larger than, but decrease monotonically to, π . q_k can be calculated jointly with p_k on each iteration to serve as a decreasing upper bound, matching p_k as an increasing lower bound, and pinning the value, π , between them. q_k is calculated as follows:

$$q_k = 2p_k/s_k$$

Of still further importance, a suitable "average" of p_k and q_k , denoted r_k , also forms a monotonically decreasing sequence converging to π , but twice as fast. r_k is two-thirds p_k and one-third q_k , and given as:

$$r_k = (2p_k + q_k)/3$$

A two-line BASIC program that exhibits p_k , q_k , and r_k , starts with a 60-degree angle instead of 180, and reduces the required iterations from 12 to only 4 by computing and relying on r_k , is given as follows:

```
10 PRINT " K P(K) " SPC(8)
"Q(K) " SPC(10) "R(K)":
S=SQR(3): P=3
20 FOR K=1 TO 4: S=SQR(S+2):
P=2*P/S: Q=2*P/S:
R=(2*P+Q)/3: PRINT K;P,Q,R:
NEXT
```

continued

**SATELLITE
MODULE \$99
NOW \$99**

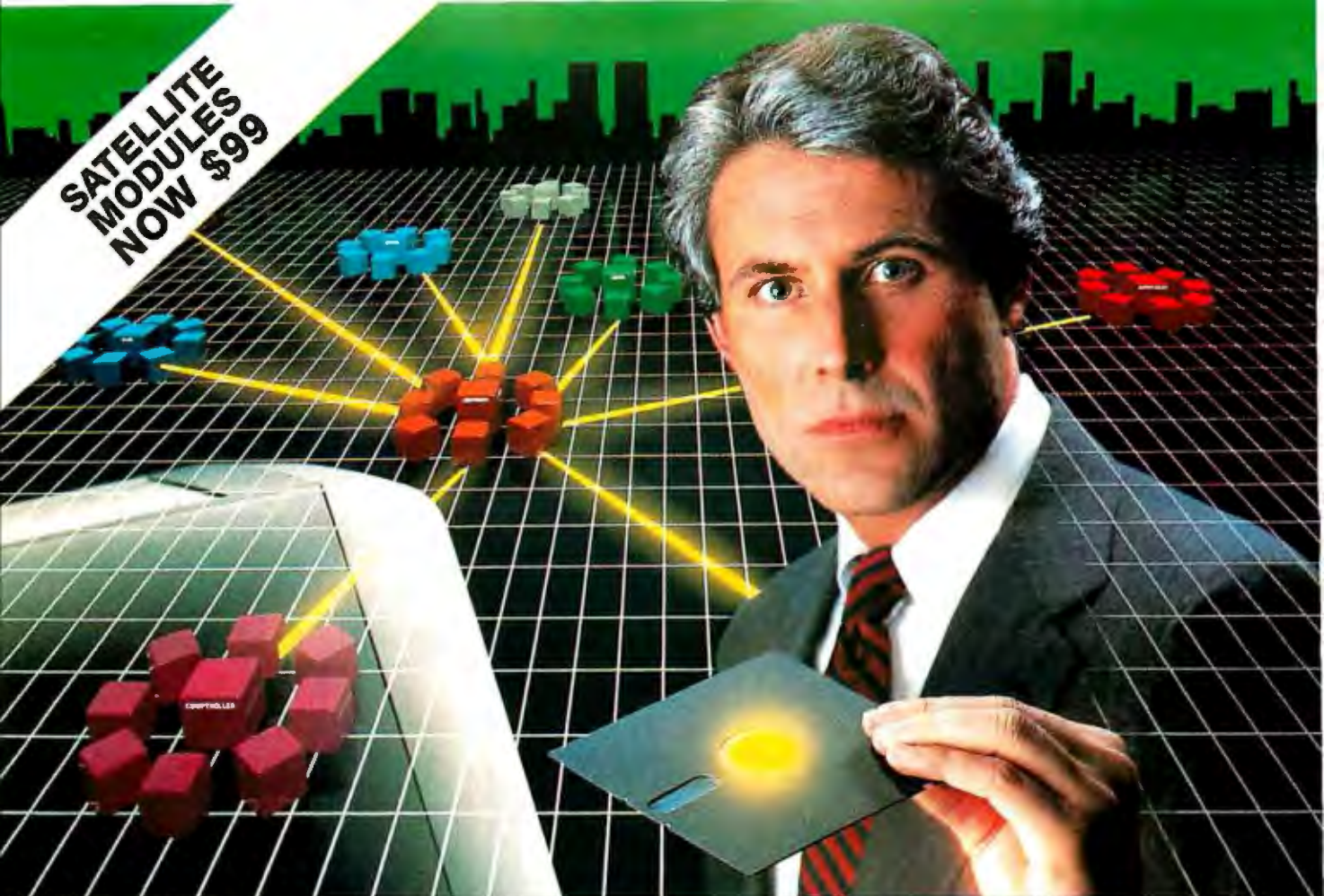

The Most Powerful LAN Fits on a Disk.

Network Power. You knew that someday there would be a powerful LAN that didn't need old-technology network boards. It would be fast, easy to install, and run 99% of PC-DOS software. It would be expandable, provide remote access, password-protection, and enable you to use inexpensive terminals as workstations in a PC-DOS environment.

Dream no more, because the power is here.

Its name is LANLink™

A Software-Driven LAN Powerful Enough To Use RS-232 Ports for Network Communications. In development for over three years, LANLink™ represents the next generation of local area networks. All of the logic which has traditionally resided on network boards is on LANLink's Satellite and Server Diskettes.

No additional hardware is required. Inexpensive serial ports replace "Kilobuck" Network Interface Boards making installation costs one-third that of a board-driven network.

How To Configure a Smart Network...With Dumb Terminals, But Without Dedicated Servers. Boasting a wide variety of configurations, LANLink™ is most often set up as a "Star" having up to eight satellites connected to a central, nondedicated server. Larger networks can have multiple servers, supporting a total of 73 or more network users.

R-LAN™ (Remote-LAN) gives users the ability to interact with a LANLink™ network in real time via modem. Plus, if MultiLink Advanced™ is run on a Satellite, inexpensive dumb terminals can be used to access network disks, files, and programs.

THE SOFTWARE LINK, INC./CANADA 250 Cochrane Drive, Suite 12
Toronto (Markham), Ontario L3R6B7 CALL: 404/477-5480

MultiLink™ is a registered trademark of The Software Link, Inc.
LANLink™ MultiLink Advanced™ & R-LAN™ are trademarks of The Software Link, Inc.
IBM, PC, & PC-DOS are trademarks of IBM Corp. WordStar 2000,
dBASE III, and Lotus 1-2-3 are trademarks of MicroPro, Ashton-
Tate, and Lotus Development Corp., respectively.

99% of PC-DOS Applications Run in a Totally-Transparent Network Environment. If you know DOS, you already know how to use LANLink™ COPY transfers files among users, and a 2-drive PC Satellite boots 1-2-3 from the Server's hard disk with the entry c:\lotus. Each satellite's access can be limited to specific disks, printers, and sub-directories. A wide variety of software including Lotus 1-2-3, dBASE III, and WordStar 2000 is fully compatible. LANLink™ has a collision-free data transfer rate which exceeds 115,000 BPS.

Power Up Your PCs Today. For complete details and the authorized dealer nearest you, call The Software Link TODAY. The LANLink™ Starter Kit is \$495 and includes modules for both a Server and a Satellite. For a limited time, 50 feet of shielded RS-232 cable will be included free of charge. Additional Satellite Modules are only \$99, each.

LANLink™ is immediately available and comes with a money-back guarantee. VISA, MC, AMEX accepted.

See us at Booth #4626
COMDEX/Spring '87
Georgia World Congress Center

LANLink™



THE SOFTWARE LINK, INC.

Developers of LANLink™ and MultiLink™ Advanced

8601 Dunwoody Place, Suite 632, Atlanta, GA 30338 Telex 4996147 SWLINK

CALL: 404/998-0700

Dealer Inquiries Invited

Inquiry 366 for End-Users.
Inquiry 367 for DEALERS ONLY.

```

RUN
K   P(K)   Q(K)   R(K)
1   3.105829 3.215391 3.142349
2   3.132629 3.15966  3.141639
3   3.13935  3.146086 3.141595
4   3.141032 3.142714 3.141592

```

Another "two-liner" can be used to compute π to 16 digits of accuracy in Microsoft BASIC. (Exchange NEXT and PRINT in 20 to see intermediate results.)

```

10 DEFDBL P-S: DEF
   FNP(S,P)=(P+S/P)/2: DEF

```

```

FNS(S)=FNP(S,FNP(S,SQR(S)))
20 S=FNS(3): P=2: FOR K=1 TO
   12: S=FNS(S+2): P=2*P/S:
   NEXT: PRINT P+P/S

```

```

RUN
3.141592653589793

```

The definition of the function FNS(S) in terms of FNP(S,P) is in lieu of a built-in double-precision square root function in Microsoft BASIC. Line 20 is actually the entire program with FNS() used to calculate the square root. Incidentally, 100

evaluations of π to 16 digits takes 54 seconds on my Panasonic Sr. Partner in Microsoft BASIC, but only 6 seconds in QuickBASIC.

This method provides a practical means of computing π to extended accuracy, using a logically satisfying mathematical derivation based directly on the definition of π . The derivation requires only a knowledge of algebra, use of the Pythagorean Theorem from geometry, and accepting intuitively that the sum of an ever-larger number of smaller chords (and outside tangents) approaches the arc of the intercepted semicircle as a limit.

The formulas are truly elegant in their simplicity and illustrate the considerable power of recursive computation. Their obvious value as a pedagogical tool makes it surprising that they are not well known and used in classrooms.

John T. Godfrey
Punta Gorda, FL

dBASE Users:

DON'T CHANGE A THING! FoxBASE+ does it all.

Ask The Reviewers . . .

"FoxBASE+ Maintains Stunning Speed, Adds dBASE III PLUS Compatibility. . .
FoxBASE+ zooms to the head of the dBASE-compatible class."
—Glenn Hart, PC Magazine, December 9, 1986.

"FoxBASE+ is the fastest and easiest-to-use dBASE product on the market!"
—George Goley, Data Based Advisor, November, 1986.

"FoxBASE+ BLOWS dBASE III PLUS AWAY!! . . . ran every dBASE program I
had with NO changes whatsoever!"
—James Gates, Atlanta Data Base Users Society Newsletter,
November, 1986.

WHAT FoxBASE+ CAN DO FOR YOU

- YOU DON'T CHANGE YOUR PROGRAMS. FoxBASE+ runs your dBASE III PLUS applications more than 6 times faster *without changing one line.*
- Forget about conversion woes. You don't have to do a thing to your databases or other dBASE files to use FoxBASE+.
- You don't have to bend over backward to use FoxBase+ . It's used in *exactly* the same, familiar, user-friendly way you use dBASE III PLUS. As a dBASE user you already know how to use FoxBASE+.
- FoxBASE+ lets you keep using the best parts of dBASE III PLUS. It's a fully interactive compiler so you can still use great features like EDIT, BROWSE, etc.

- FoxBASE+ doesn't make you spend hours compiling and linking your programs like some "speed-up" products.
- FoxBASE+ runs your compiled programs twice as fast as Clipper and 3 times faster than Quicksilver.
- Best of all, Single-user MS-DOS FoxBASE+ costs just \$395 and Multi-user FoxBASE+ \$595 with a money-back guarantee. *Royalty-free runtime also available.*

If you like dBASE III PLUS, YOU'LL LOVE FoxBASE+ !!

So call (419) 874-0162 now for the details.
After all . . .

Nothing Runs Like a Fox.

FOXBASE 

FoxBASE+ is a trademark of Fox Software. dBASE III PLUS is a trademark of Ashton-Tate. Clipper is a trademark of Nantucket. Quicksilver is a trademark of WordTech Systems Inc. MS is a registered trademark of Microsoft Corporation.

Fox Software
27493 Holiday Lane, Perrysburg, OH 43551
(419) 874-0162 Telex 6503040827

Please Pass the Filename

When programming an application in BASIC, whether it be interpreted or compiled, you often need to pass a filename or a parameter from the DOS level, or from a batch file, into the BASIC program. Although such a feature is clearly a necessity, it is not covered in the standard PC-BASIC, GW-BASIC, or compiled BASIC. It may, however, be constructed using the environmental feature of DOS and, although this is a one-way street (that is, it works only from DOS to BASIC), it clearly takes care of the parameter-passing problem. Now, let's get on to business:

The following batch file accepts a filename as a parameter, types the file (just for fun), and then calls a compiled BASIC program, which could just as well be an interpreted version of the same. The BASIC program, in turn, prints the filename on the screen just to show that it got the name passed on right.

CALLING SEQUENCE

```
batch myfile.ext
```

BATCH FILE

```
type %1
path %1
parms (Could be "BASIC PARMS")
```

COMPILED BASIC PROGRAM

```
10 "SAVE"PARMS",A
20 PRINT "Pass BATCH parameters to BASIC"
30 P$="PATH":FILNAM$=
   ENVIRON$(P$)
```

continued



FINALLY, A DAISYWHEEL PRINTER THAT'S RIGHT ON THE MONEY.

The Citizen™ Premier™ 35 gives you all the features of a high-end daisywheel printer, without the high-end price. For hundreds of dollars less, you get all the speed and features you'd expect from other quality 35 cps daisywheel printers, plus something no one else can give you. The same precision and engineering that go into our timepieces.

If your software is compatible with a Diablo® 630, the NEC 3550, or the Qume® Sprint® 11+, it's already set up to drive a Premier 35 without a bit of problem.

The Premier 35's LCD display spells out operations and errors in plain English. Its unique paper loading system makes work easy. And its built-in, variable-width tractor is a feature you'd normally have to pay extra for. More than enough reasons to make your buying decision split-second.

For more precise information, call 1-800-556-1234 Ext. 34. Or, in California, 1-800-441-2345 Ext. 34.

The Premier 35. A value that will lead you to only one conclusion. It's about time.

©1986 Citizen America Corporation. Citizen, the Citizen logo, and Premier 35 are trademarks of Citizen Watch Co., Ltd. Diablo is a registered trademark of Xerox Corporation. Qume and Sprint 11+ are registered trademarks of Qume Corporation, a subsidiary of ITT.

 **CITIZEN™**
Printers that run like clockwork.

Inquiry 59

```
40 IF FILNAM$ < > " " THEN 60
50 INPUT "No filename passed.
Please enter filename manually",
FILNAM$
60 PRINT FILNAM$
70 'Here comes the program !!
80 END
```

The first BASIC line is my convention of remembering the name of the program whenever I want to resave a new version.

One significant problem is the possibility of getting an "Out of environment space" error message. I have not yet found a way to increase the available environment space from my BATCH program. I hope someone can, without resorting to too much assembly code.

Thorleif Bundgaard
Maarslet, Denmark

Information Wanted

I am an occupational therapist at a Rehabilitation Center in Burlington, Vermont. I would be interested in any information regarding computers and the handicapped.

Julie Sonack, OTR
Doquesbriand Unit, OT Dept.
1 So. Prospect St.
Burlington, VT 05401

I'm interested in finding out more about how computers can enhance or improve the quality of life for mentally retarded and developmentally disabled individuals. I'd welcome any information on computers and handicapped individuals.

Helen Emmons
Eastern Oregon Training Center
Mental Health Division
2525 Westgate
Pendleton, OR 97801

FIXES

MSC/pal

In the February What's New section, on page 46, we stated that the program MSC/pal was copy-protected. However, according to the MacNeal-Schwendler Corp., it is not.

UMI and the RTX Robot Arm

We have a new price and a U.S. address for the RTX robot arm mentioned by Dick Pountain in his BYTE U.K. column in the March issue. The price is £6800, or \$12,000 U.S., with a 30 percent discount for educational users. In the U.S., contact UMI Inc., 3135 South

State St., Ann Arbor, MI 48104; phone (313) 995-5115.

Correction

On page 90 of "The Apple Macintosh II" article in the April issue, the sentence beginning "A read or write . . . begins with a START* . . ." should read: "A read or write . . . begins with a START* cycle, followed by multiple bus cycles to transfer data . . ." NuBus presents the address with the START* cycle, not during the data transfer.

Wayward Diodes

If you want to get the IRCOMM receiver diagrammed in figure 5 on page 106 of our February issue to work, find all three instances of diode 1N4148, and reverse the way each is oriented in the schematic.

2-Bit Correction

In the article "Low-Cost Image Processing" in the March issue, our description of the EGA board for the IBM PC was flawed. The maximum resolution of the EGA is 640 columns by 350 rows of 4-bit pixels, not 6-bit pixels as we reported. Although the EGA does have a palette of 64 possible colors, only 16 colors are available on screen at any given time. ■

BYTEK HIGH PERFORMANCE EPROM, PROM and PLD PROGRAMMERS

UNIVERSAL (E)PROM PROGRAMMERS

Open and Modular Architecture allows the BYTEK System 125 to communicate with most computers and Program a World of Programmable Devices at affordable prices.

THREE PROGRAMMERS IN ONE:

- GANG EPROM Programmer: Support for MOS/CMOS/HMOS EPROM/EEPROMs
- SET EPROM Programmer: 16-Bit, 32-Bit and optional 64-Bit Words
- UNIVERSAL Programmer: (Optional) Bipolar PROMs, Logic Array Devices, 40 pin Micro Computer Devices, 3 Voltage Devices, 8 and 16 Bit Emulation, and GANG adapter with additional 8 ZIF sockets.

Model: S125-GL
Shown with
optional PROMCel
\$1,495



STANDARD FEATURES Include:

- 64K BYTE RAM Buffer, (expandable to 1M BYTE)
- 3-Way Device Type Selection: Manually, Electronic ID or from Menu
- Stand Alone Operation (includes DATA EDITing)
- 25 Key Integrated Keyboard, 32 Character Alpha/Numeric LCD Display
- RS232 PC Interface for Terminal Mode, (Optional 2nd RS232 Port)
- Formats: 15 Popular RS232 Formats
- Baud Rates: 50-19,200
- Parallel Printer Port, Centronic Compatible
- Computer Remote Control Data I/O* Compatible

• UV Erasers from \$47 Made in the USA

Distributor Inquiries Welcome

DATA I/O is a trademark of Data I/O Inc.



The WRITER™ supports virtually all MOS and CMOS EPROMs and EEPROM up to 512k. The WRITER has complete STAND ALONE programming capabilities including data EDITing, or PC Remote Control with the standard RS232 interface.

\$495.00

STANDARD FEATURES of the WRITER include:

- Programs all popular 2716-27512 EPROMs & 2816 EEPROM
- 32K BYTES RAM (512K Bits)
- Large 6 Digit LED Display
- Single 28 pin ZIF socket
- Fast Intelligent Algorithms
- RS232 PC Interface
- 12 Popular RS232 Formats
- Baud Rates: 110-9600
- 14 Functional Keys, including: LOAD, PROGRAM, EDIT, DISPLAY, ERASED CHECK, FILL & VERIFY

Remote Control (E)EPROM Programmer Available: WRITER-RX-\$345.00

BYTEK MultiProgramming Equipment offer User Friendly Operation, High Quality, and are backed by Dedicated Customer Service, Unlimited Product Support, and a Full One Year WARRANTY.

BYTEK—the #1 CHOICE in (E)PROM MultiProgramming Equipment

& UV Erasing Products. Call or Write for full Product Catalogue.

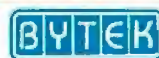

CORPORATION
Instrument Systems Division
1021 S. Rogers Circle
Boca Raton, FL 33431

ORDER TODAY:
800-523-1565

In FL: (305) 994-3520
Telex: 4998369 BYTEK
FAX: (305) 994-3615

Visit our new California Sales Office:
2847 A Whipple Road, Union City, CA 94587
(415) 487-4694

THE AMERICAN FORCE

All across America the word about a new force is spreading. A force that has put American design, technology and manufacturing back on top. Be a part of it!

System 1800 Models

WAIT STATE	MODEL NUMBER
1	System 1800-0 (8MHz)
1	System 1800-A (10MHz)
0	System 1800-B (10MHz)

System 1800 Features:

- 6/8/10 MHz Selectable with 10MHz 80286 CPU Chip
- Fully compatible IBM AT™ AMI BIOS with built in SET-UP UTILITY. • 47 drive type table. • 48 hour burn-in. • 512K RAM standard expandable to 1MB. • 200 pages of documentation.
- Clock/Calendar with battery backup.
- Hard disk/Floppy Controller.
- UL/CSA approved 195 watt power supply. • Made in U.S.A., • 1 Year Warranty

Over 20,000 units installed

Total Compatibility

American Quality Manufacturing

U.S. Design and Engineering



CLUB AT INC.
800-451-8889

QIC RESEARCH INC.
800-843-0806

ELTECH
(408) 943-1764

TECHPOWER
(714) 979-1330

SCSI
1-800-237-7274

S.F. MICRO
800-237-5631

SERVEX
(416) 827-7807

PRIDE
(604) 273-0707

TECHPOWER II
(818) 882-6300

SPEAR TECHNOLOGY INC.
(312) 480-7300

KELLECO
1-312-887-0330

UNITED SOLUTIONS

System



An OEM Product of Everex Systems Inc.
Inquiry 107 for End-Users.
Inquiry 108 for DEALERS ONLY.

Discover The

Quality, Features,

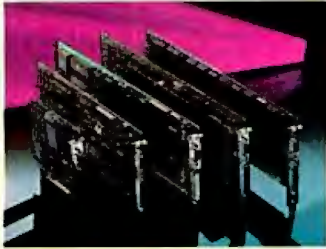

GRAPHICS

EPGA - Professional Graphics Adapter

- Compatible with the IBM® PGC
- Fits into a single slot
- Displays 640x480 graphics in 256 colors
- Emulates CGA, Hercules® and MGA modes

Micro Enhancer

- Compatible with the IBM EGA
- Supports 640x350 graphics in 16/64 colors
- Half card fits in a short slot
- Emulates Hercules and CGA modes

Everex Edge

- Displays 320x200 graphics in 16 colors
- Runs HGA 720x348 monochrome graphics
- Runs Lotus 1-2-3® and Symphony® in 132 columns
- Parallel port and light pen connectors



STREAMING TAPE

Excel Stream 20

Excel Stream-60

Excel Stream 60-8

- 60MB cartridge Backup
- 20MB cassette Backup
- Automatic Scheduler
- File Restore from Image backup
- Backup across networks
- 5MB/min speed
- Multiple datasets and tapes
- Image and File records on the same tape
- Context sensitive help
- Nestable and movable windows
- Extensive diagnostics
- Easy installation program



COMMUNICATIONS

Evercom 24 Modem

- International operations at 2400 hps
- Compatible with Hayes® AT command
- Bell 212A/103 and CCITT V.22/V.22bis compatible
- Adaptive equalization
- Automatic answer and voice/data switching
- Phone off-hook detect
- Runs in slot 8 of IBM XT®
- Runs with multi-line phones

Evercom 12 Modem

- 300/1200 hps speed on a short card
- Hayes and Bell 212A compatible
- Supports tone and pulse dialing
- Automatic answer and voice/data switching
- Bitcom software included



EPGA



Excel Stream-20

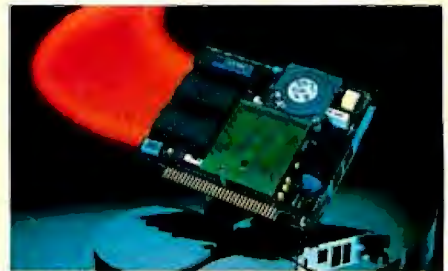

Evercom 24

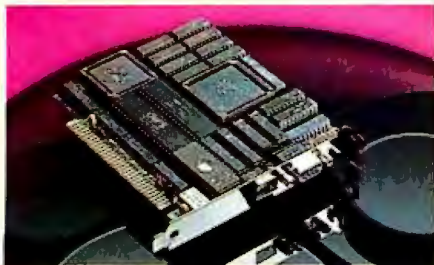

Micro Enhancer



Excel Stream-60



Evercom 12

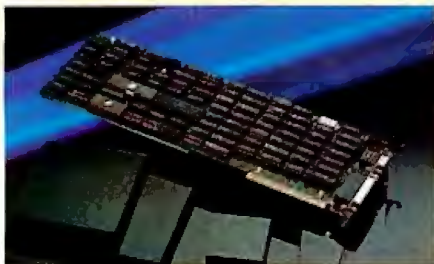

Everex Edge



Excel Stream 60-8

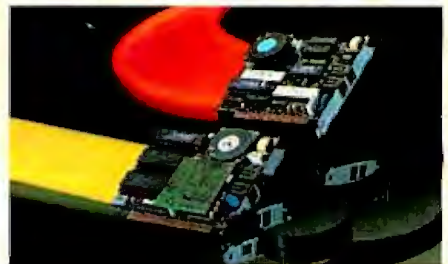

Evercom

Everex Difference

Price and Performance.

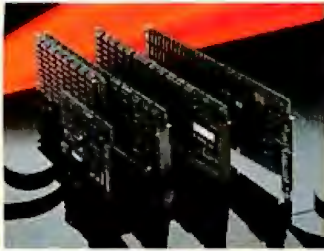

MULTIFUNCTION

Excelerator

- 80286 8MHz processor replaces 8088 on PC/XT*
- 33% faster than standard IBM AT®
- Add up to 640K of cache RAM memory
- Socket for 80287 math coprocessor

Magic I/O

- I/O plus clock/calendar
- For XT/AT and compatibles
- Serial ports COM1-COM-4
- Parallel ports LPT1-LPT3
- Software included

Magic Card 16

- Up to 2MB of extended memory for AT
- Flexible memory addressing
- Configurable parallel and serial ports



HARD DISK DRIVES

Everdrive 20MB External

- Half-height, 20MB formatted capacity
- ST-506/ST-412 interface
- 65 msec average access time
- Dedicated head shipping zone

Everdrive 40MB Internal

- Half-height, 40MB formatted capacity
- 40 msec average access time
- ST 412 interface
- 20,000-hour MTBF

Everdrive 72/80MB External

- 72/80MB formatted capacity
- 30 msec average access time
- 20,000-hour MTBF
- 25-5 Watts power consumption

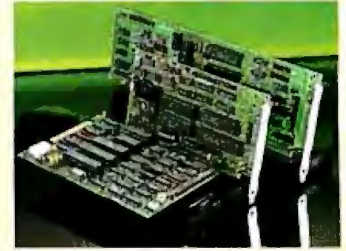

OEM PRODUCTS

EV-826 Tape Formatter

- Onboard 8K RAM for data buffer
- Standard QIC-36 drive interface
- QIC-02 interface for host adapter

EV-332 Hard Disk/Floppy Controller

- Reduced height
- ST506/412 interface supports 2 hard drives
- 2:1 interleave factor
- 32 bit ECC
- Supports 2 floppy drives

EV-1800 AT Mother Board

- 10MHz zero wait state 80286 CPU
- 512K RAM, expandable to 1MB
- Six 16-bit and two 8-bit slots
- I/O ports and clock calendar



Excelerator



Everdrive 20MB External



EV-826



Magic I/O



Everdrive 40MB Internal

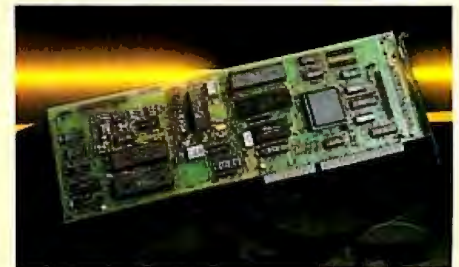

EV-332

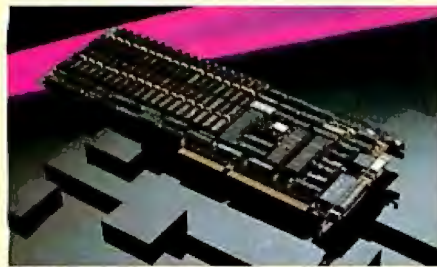

Magic Card 16



Everdrive 72/80MB External

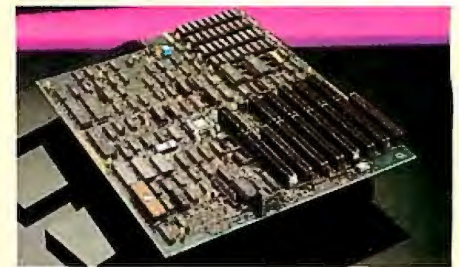

EV-1800

EXPAND YOUR PC TO NEW HORIZONS



**NOVELL
NETWORK®**

PC-Slave II The Ultimate Two-User Card

Advanced Digital now offers you two additional users for the price of one!

With our PC-Slave II®, you can quickly turn your personal computer into a host computer for a complete 3-user system. The PC-Slave II lets two additional users share one PC and all the expensive hardware and peripherals that you've already paid for. Plus you share access and communication between users and PC's.

Each slave has two CPU's, two 512K bytes of memory, keyboard and monitor interface, making it possible for each user to work on the same program or two entirely different programs...as if they were two independent PC's.

PC users often ask us how to network their many PC's. The solutions are many but expensive and slow. Advanced Digital's answer — the PC-Slave II allows you to add additional workstations at a more reasonable cost...and with much faster performance than any local area network or software package.

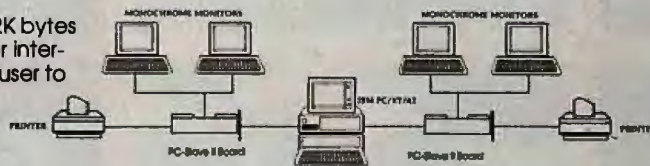

All you need to complete your 3-user system is the PC-Slave II, IBM's PC-NET software, and two low-cost monochrome monitors and keyboards. No new operating system, no new commands and no complications of a LAN.

Each PC-Slave II gives your PC the full capabilities of two PC's and can support DOS 3.1 providing each user 100%

compatibility with PC programs.

Advanced Digital offers many other PC products including the ADC-TAPE-60, PC-EXBUS, PC-Slave and more!

For more information, call 1-800-251-1801 (outside California).

Advanced Digital Corporation
5432 Production Drive
Huntington Beach, CA 92649
(714) 891-4004, (800) 251-1801
Telex 183210 ADVANCED HTBH

Advanced Digital U.K. Ltd.
21 Newman Street
London W1-United Kingdom
(01) 323-1120
Telex 266730 ADCUK

**Inquiry 8 for End-Users.
Inquiry 9 for DEALERS ONLY.**

ADC
ADVANCED DIGITAL CORPORATION

WHAT'S NEW

Typesetting and Layout on the Mac

TEXtures, a typesetting program for the Macintosh from Addison-Wesley is based on T_EX, the typesetting language developed for computerized typesetting and controlled page layout.

T_EXtures' macro programming language lets you typeset complex tables, precision-ruled forms, and multi-column layouts. It provides hyphenation, justification, pagination, kerning, and ligature insertion, and lets you number, footnote, and cross-reference pages, sections, and paragraphs.

With the program's WYSIWYG (what-you-see-is-what-you-get) editing capability, you can preview typeset pages, including graphics, magnified up to 300 dots per inch. You can also display typeset pages in a window or display the editing and viewing windows on-screen at the same time. Word processing windows let you input and edit text.

T_EXtures operates on the Macintosh 512K, the 512K Enhanced, the 1-megabyte XL, and the Plus. The program supports two 800K- or 400K-byte floppy disk drives, although a hard disk drive is recommended. T_EXtures uses standard Macintosh printer software for laser printers, according to Addison-Wesley. It also works with typesetters and the Apple Imagewriter. **Price:** \$495.

Contact: Addison-Wesley Publishing Co., Jacob Way, Reading, MA 01867, (617) 944-3700.

Inquiry 576.



Desktop typesetting with T_EXtures on a Mac.

Tandy Emulates Apple II

If you own an IBM PC-compatible Tandy 1000 or Tandy 1000 SX, you can run most of the software available for the Apple II family of computers by using Tandy's Trackstar 128 emulation board.

The Trackstar 128 includes a 65C02 processor, 128K bytes of RAM, and dual game-controller connectors (compatible with both the 16-pin Apple IIe and the 9-pin Apple IIc).

The board provides both 80- and 40-column displays on either RGB or composite-video monitors and supports Apple ProDOS and Apple DOS 3.2. Printer and serial ports, as well as music and sound support, are provided through the Tandy 1000.

Although most Apple software will run on the 1000's internal drives, the Trackstar can also connect an external Apple-compatible disk drive. This is particularly useful for running heavily copy-protected programs.

Tandy says the results of an independent study showed that 99 percent of the more

than 400 pieces of Apple software ran on the Trackstar.

The board must be installed by an authorized Tandy service center.

Price: \$399.95 plus installation.

Contact: Tandy Corp., 1800 One Tandy Center, Fort Worth, TX 76102, (817) 390-3011.

Inquiry 577.

The Scoop from Target

Scoop, a desktop publishing program from Target Software, offers a WYSIWYG text editor with page-layout and composition capabilities, enabling you to display and edit files up to 100 pages long.

Scoop lets you fill or wrap text around irregularly shaped graphics, automatically or manually hyphenate, slant margins, and use fractional font sizes. The spelling checker MacLightning 3.0 is included.

Scoop requires a Macintosh 512K or Plus and supports PostScript-compatible output devices.

Price: \$495.

Contact: Target Software Inc., 14206 Southwest 136th St., Miami, FL 33186, (800) 622-5483; in FL, (305) 252-0892.

Inquiry 578.

Low-Cost Networking

Avatar Technologies' Alliance ZSL local area network, combines hardware and software to connect up to 20 IBM PCs, compatibles, and devices via each connected system's serial port. Avatar calls it a "zero-slot" network, because you don't need adapter cards. You can also connect any computers that have RS-232C serial ports.

The network is configured as a star, with each device connecting to the Alliance ZSL network processor. Each workstation and device is connected by standard telephone wire to the network processor.

The program is memory-resident and supports file-transfer rates of up to 115k bits per second. Print spooling is offered, so you can print in the background. A bulletin-board system enables you to send messages between workstations on the network. You can also share peripherals and transfer files between workstations. A 3270 interface is supported letting you connect to IBM mainframes.

Alliance ZSL is available in 8-node, 14-node, and 20-node versions. **Price:** \$1195 for 8-node; \$1595 for 14-node; and \$1995 for 20-node version.

Contact: Avatar Technologies, 99 South St., Hopkinton, MA 01748, (617) 435-6872.

Inquiry 579.

continued

A Lighter and More Inexpensive GRiD

The GRiDLite Model 1030 from GRiD is an IBM PC-compatible laptop running at 4.77 MHz and a supertwist yellow LCD that displays 80 characters by 25 lines.

Weighing 8½ pounds, the GRiDCase measures 11 by 13 inches and includes a single 3½-inch floppy disk drive and 128K bytes of RAM (expandable to 640K). You can also install up to 1 megabyte of EMS RAM.

GRiDLite is powered either through the AC power line or through an internal rechargeable battery. The unit's rear panel includes an RS-232C serial port, parallel printer port, an RGB video-out connector, and a connector for an external floppy disk drive.

You can install up to eight application ROMs (up to a megabyte total memory). GRiD sells InteGRiD, a multi-tasking applications environment, as well as analytical and communications software—all in ROM. You can also integrate custom applications.

GRiDLite options include a 640K-byte memory upgrade, half-megabyte and 1-megabyte EMS RAM expansions, an external 3½-inch floppy disk drive, and an internal 300/1200-bps direct-connect modem.

Price: \$1750; 640K RAM expansion, \$600; half-megabyte EMS RAM expansion, \$295; 1-megabyte EMS RAM expansion, \$395; internal modem, \$495; external 3½-inch floppy disk drive, \$295.

Contact: GRiD Systems Corp., 2535 Garcia Ave., Mountain View, CA 94039-7535, (800) 222-4743, (415) 961-4800.

Inquiry 580.



The PC-compatible GRiDLite laptop.

PageMaker for the IBM PC and the Macintosh II and SE

With the new IBM PC and Macintosh II and SE versions of PageMaker, Aldus's desktop publishing program, you can design, edit, and print using word-processing and graphics programs from a variety of manufacturers.

The Macintosh version lets you work with PC PageMaker files on your Mac, and built-in and installable word-processing import filters let you use IBM PC-based word-processing documents in your PageMaker publications. You can also save text files created on the Macintosh PageMaker as Word 3.0 word-processing files. PageMaker 2.0 for the Mac requires a Macintosh Plus, II, or SE with a hard disk.

PageMaker for the PC runs under Microsoft Windows and can import preformatted text files from Microsoft Word, WordPerfect, MultiMate, WordStar 3.3, XyWrite III, and Microsoft Windows Write. PageMaker for the PC runs on IBM PC ATs or compatibles with at least

640K bytes of RAM, a 20-megabyte hard disk, a graphics card, and a mouse.

Price: Macintosh version, \$495; IBM PC version, \$695. **Contact:** Aldus Corp., 411 First Ave. S, Suite 200, Seattle, WA 98104, (206) 622-5500. **Inquiry 581.**

New Mouse Systems Mice

Mouse Systems has enhanced the serial-port and the bus models of its PC Mouse and has also lowered the prices on both. The mice's performance is enhanced by new application-specific integrated circuits (ASIC). On the serial-port model, the new circuitry means the mouse no longer needs an external power supply.

The mice are being shipped with an expanded library of 24 Designer Pop-Up menus for popular PC business applications, including Lotus 1-2-3, PFS:Professional Write, WordStar 2000, dBASE III, and WordPerfect 4.2. Instructions are included for developing custom pop-up menus, and the

mice are shipped with software that make them compatible with the Microsoft mouse applications.

Price: PC Mouse, \$159; PC Mouse Bus Plus, \$179. **Contact:** Mouse Systems Corp., 2600 San Tomas Expressway, Santa Clara, CA 95051, (408) 988-0211. **Inquiry 582.**

IBM Upgrades RT

IBM's three new models of its RT Personal Computer have four times the memory, two to three times the processing speed, and an eight-fold increase in floating-point performance. The RT's Advanced Interactive Executive (AIX) operating system has also been upgraded. All use IBM's 1-megabit memory chips, and incorporate a memory-management unit that lets you access up to a trillion characters of virtual memory.

The RT 6151 Model 115 is a desktop unit, and the RT 6150 Models 125 and B25 are floor-standing units. All feature an advanced processor card with a 32-bit reduced instruction set computer (RISC) processor with a memory management chip, a built-in floating-point unit, and 4 megabytes of fast CMOS memory. There's also an extended ESDI magnetic media adapter that will accommodate up to three internal fixed disks.

Owners of the original RT models can upgrade to new desktop and floor-standing models by purchasing an upgrade kit.

Price: 6151 Model 115, \$10,600; 6150 Model 125, \$16,100; 6150 Model B25, \$17,670 (all single-unit quantities). Upgrade kit for existing RTs, \$2495; 4-megabyte fast-memory expansion, \$3800; 8-megabyte fast-memory expansion, \$5000. **Contact:** IBM Corp., Information Systems Group, 900 King St., Rye Brook, NY 10573, (914) 765-1900. **Inquiry 583.**

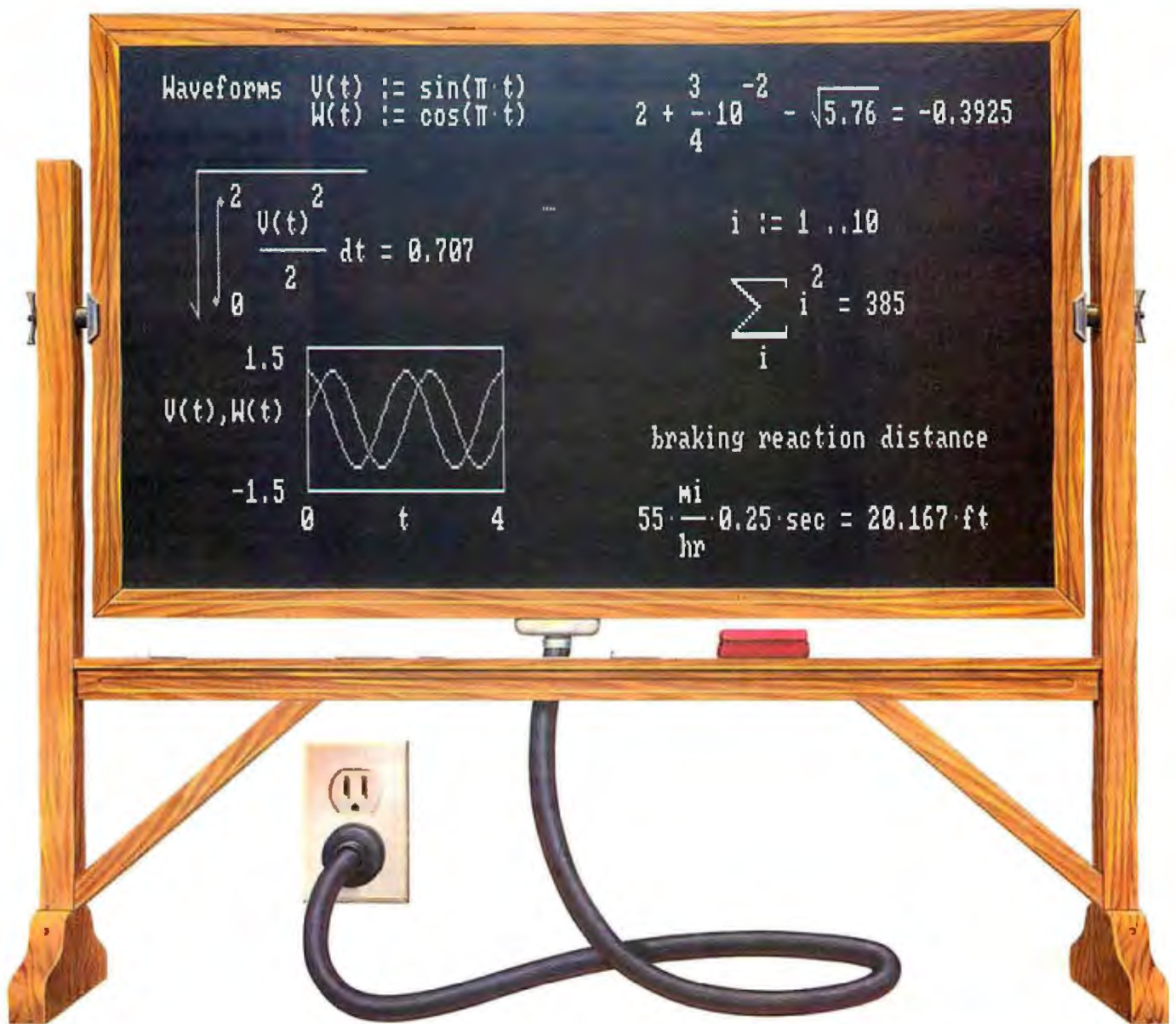

Engineering calculation raised to a new power.

The only software program to combine the flexibility of a blackboard, the simplicity of a calculator, and the power of a personal computer.

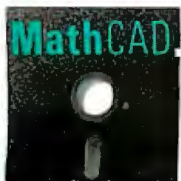

Now you can write calculations on your PC in standard math notation—mixing text, formulas and graphics with the same free-form ease you have on a blackboard or scratchpad.

No new languages to learn. Simply type equations anywhere on the screen and MathCAD automatically calculates and displays

your results as numbers or graphs—exactly as you want to see them. Change anything, and MathCAD instantly recalculates the results. Add text at any point to support your work. Then print and save your entire calculation as an integrated document.

Powerful built-in functions. MathCAD handles both real and complex numbers and does automatic unit conversion and dimensional analysis. It has a full range of built-in functions including integration, differentiation, fft's and cubic splines. Or you can define your own. No wonder thousands of engineers use MathCAD every day, for everything from robotics

to signal processing and thermodynamics to fluid mechanics.

Call us today. We're convinced that MathCAD belongs on every engineer's desk. At \$249, with our no-risk, 30-day money-back guarantee, you really can't afford not to try it. To place your order or to request further information, call us now at:

1-800-MathCAD
(in Massachusetts: 617-577-1017)

MathCAD. Once you've tried it, you'll wonder what you ever did without it. Order today.

Requires IBM PC® or compatible, 512KB RAM, graphics card. IBM PC is a registered trademark of International Business Machines Corporation. MathCAD™ MathSoft, Inc.

MathCAD

MathSoft, Inc., 1 Kendall Sq., Cambridge, MA 02139

Drawing on the Apple IIGS

With TopDraw, a mouse-based object-oriented drawing program from StyleWare, you can create drawings that are several pages in length and width on the Apple IIGS with 512K bytes of RAM. You can move, group, separate, reshape, resize, or fill shapes and objects with patterns and colors. You can also flip objects, rotate them in 90-degree increments, and protect them from unintentional editing.

TopDraw features the ability to edit colors and lets you draw with as many as 16 colors at a time, from a palette of 4096 colors. The program gives you a choice of fonts, type styles, and sizes for incorporating text into your drawings.

TopDraw supports the LaserWriter and the Image-writer II.

Price: \$99.95.

Contact: StyleWare Inc., 5250 Gullfion, Suite 2E, Houston, TX 77081, (713) 668-4046.

Inquiry 584.

Hard Disk Expansion for Toshiba T1100+

ThinWin and ThinPack are two expansion systems for the Toshiba T1100+ portable laptop computer. The ThinWin is an internal hard disk that replaces drive B. It's available in 10- and 20-megabyte versions and adds 8 ounces to the computer's weight. The ThinWin must be installed by an authorized dealer.

The ThinPack 1100 is an external expansion chassis that adds 1½ inches to the thickness of the computer. Also available with both 10- and 20-megabyte hard disks, it adds two IBM PC-compatible

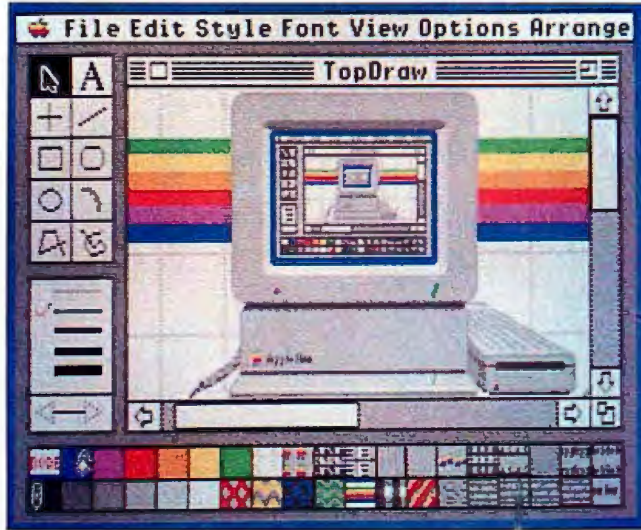

TopDraw lets you choose from a palette of 4096 colors.

slots that take half-size cards, as well as an internal rechargeable battery system with a proprietary low-power mode.

The ThinPack weighs 4½ pounds. Axonix says they'll be offering several half-length cards for it, including LAN, terminal emulators, expansion memory, ROM, data acquisition, EGA, data encryption, and a high-speed radio frequency wireless modem.

Price: from \$995 to \$1395.

Contact: Axonix Corp., 417 Wakara Way, Salt Lake City, UT 84108, (801) 582-9271.

Inquiry 585.

Two RLL Hard Disk Controllers

The Perstor 200 series of hard disk controllers includes two new models: the PS180 and the PS200. Both controllers use the Advanced run length limited 2,7 encoding method. The PS180 transfers data at 9 megabits a second, provides 31 sectors per track, and increases hard disk capacity by at least 90 percent over a standard controller. The PS200 transfers data at 10 megabits a second, provides 34 sectors per track, and increases hard disk capacity by 100 percent.

The controllers work

with any Winchester hard disk drive that's compatible with the IEEE ST506/412 interface. The PS180 works with MFM- and RLL-approved drives with either plated or oxide media. The PS200 works best with plated-media RLL-approved drives. Both use a standard IBM BIOS and are compatible with MS-DOS, PC-DOS, UNIX, XENIX, and CP/M. Both are also capable of supporting drives with up to 15 heads and 2048 cylinders. They come with an advanced error-checking-and-correction capability using a 56-bit fire code to allow twice the bit dropout factor of normal controllers. Both controllers have a 25-megabyte data-recovery circuit and sector-buffering RAM.

The 200 series can be used as primary, coresident, or multiple controllers, and can be set for BIOS or non-BIOS use, as well as for either direct memory access or programmed input/output.

Price: PS180, \$495; PS200, \$595.

Contact: Systems and Software Inc., 7825 East Redfield Rd., Scottsdale, AZ 85260, (602) 948-7313.

Inquiry 586.

Battery Pack for Toshiba Portable

AdaptaPAK, a rechargeable battery pack from Product R&D will run the Toshiba T3100 portable laptop computer for over an hour. It consists of an adapter, battery, charger, and a zippered carrying case with a shoulder strap. The adapter's output power cord plugs directly into the Toshiba's AC receptacle, and the adapter's input cord plugs into the portable battery or into a 12-volt vehicle lighter.

The rechargeable battery of the AdaptaPAK weighs 7 pounds. The battery adapter is also available as a stand-alone product called the Adapt80. Its primary application is for people who want to use the Toshiba in a vehicle, or those who want to use a different source of 12-V power.

Price: AdaptaPAK, \$399; Adapt80, \$299.

Contact: Product R&D Corp., 1194 Pacific St., Suite 201, San Luis Obispo, CA 93401, (805) 546-9713.

Inquiry 587.

Protect Your Modems

The Diamond Chip is a low-cost, high-voltage phone-line surge protector from Curtis Manufacturing. It has a swivel mount that rotates 360 degrees for easy positioning and installation.

The unit protects modems, and all equipment that is directly connected to the telephone lines, from power surges, which the company says is extremely common.

The Diamond Chip also protects data during transmission through unprotected telephone lines by helping to prevent loss or damage from surges or spikes. The unit plugs directly into any standard AC wall outlet. It uses the ground only and does not draw any power. A 6-foot telephone-line patch cord is included.

continued

BOB STANTON HAD A GREAT IDEA. AN HOUR LATER HE WAS TESTING IT.

Appointments. Everybody takes them — dentists, auto-body shops, dance instructors. And lots of computer applications need appointment screens.

Bob thought that a calendar made a terrific graphic metaphor for taking appointments. Simply use the arrow keys to pick an open date, then press the Enter key, and up pops an appointment window.

Lucky for Bob, he's a CLARION programmer, one of a fast growing cadre of super-productive application developers.

With CLARION's Screener utility, he painted a white calendar on a black background. Then he drew a white-on-blue track around the page and between the days. He typed in the days of the week — and *voila!* — a calendar!

CLARION knows that a PC monitor is refreshed from memory, so it treats a screen layout like a group of variables. Just move data to a screen variable, and it shows up on the monitor.

Bob set up dimensioned screen variables for the days of the month and a screen pointer for selecting a date, and he was done. Then Screener generated the code.

Then Bob drew the appointments window, built an appointment file, filled in the connecting code and tested it — ONE HOUR AFTER HE STARTED!

Testing was a breeze. Screener doesn't just write code, it compiles your source, displays a screen, gets the changes, then replaces the old code in your program.

So here are Bob's appointment screens. You can see the source listing to the right. We marked all the code Screener wrote for him.

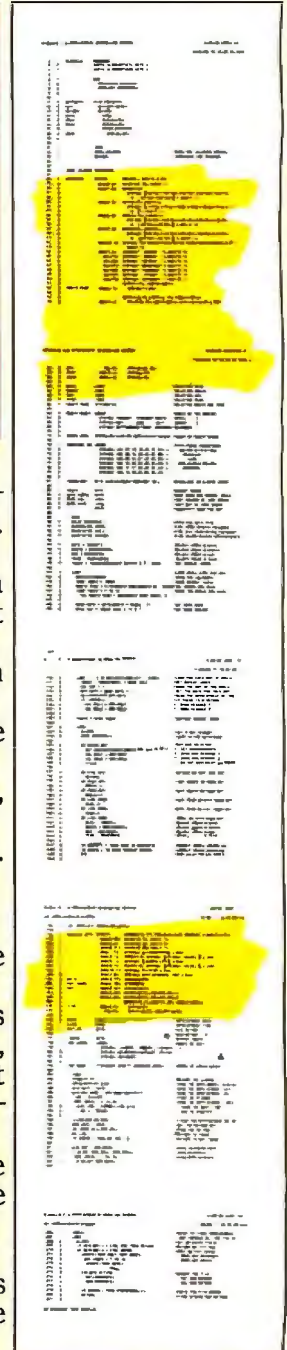
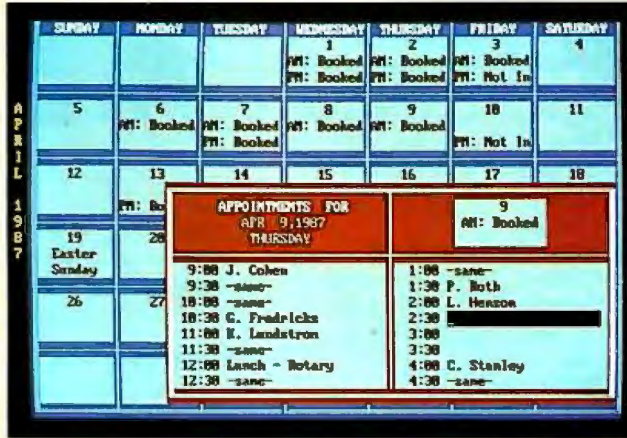

WHY CLARION?

Why are application developers everywhere changing to CLARION?

Because CLARION gives you all the tools you need: a coupled compiler and editor; screen, report, and help generators; an import/export utility; a sort/backup/restore utility; a formatted file dump; a DOS shell — and much more.

Because with CLARION's comprehensive data management routines, records can be locked and files shared on Novell®, 3COM®,

IBM® PC Net & Token Ring, Multi Link®, and most other networks.

Because CLARION is *not* hardware locked or copy protected. Run-time systems are *free* and soon you will be able to translate CLARION into native machine code (.EXEs).

And best yet, the price of CLARION v1.1 is just \$395 plus shipping and handling.

You'll need an IBM PC or true compatible with 320KB of memory and a hard disk drive. CLARION v1.1 also comes with a 30-day money back guarantee.

So call now and order CLARION v1.1. or ask for our detailed 16-page color brochure and reprints of major reviews.



800/354-5444

150 EAST SAMPLE ROAD

POMPANO BEACH, FLORIDA 33064

305/785-4555

Price: \$19.95.

Contact: Curtis Manufacturing Company Inc., 305 Union St., Peterborough, NH 03458, (603) 924-3823. **Inquiry 588.**

Turbocharged Amiga Tower

For Amiga users who want the ultimate in performance, Computer System Associates' Turbo-Amiga Tower attaches to the side of an Amiga A1000 and upgrades it to include all the features of the Amiga 2000, including IBM compatibility. The unit sports a 68020 processor running at 14 MHz, a 68881 math coprocessor, up to 12 megabytes of 32-bit memory, and up to 75 megabytes of hard disk storage.

The Tower comes with a 200-watt power supply, seven 100-pin Zorro-bus Amiga slots, four IBM PC AT-compatible slots, and one 86-pin auxiliary CPU slot. A special Commodore 8088 bridge card provides IBM compatibility with an 8088 coprocessor running simultaneously with the Tower's 68020 processor.

For data storage, the Tower has optional removable hard disk cartridges available in sizes of 20 to 75 mega-

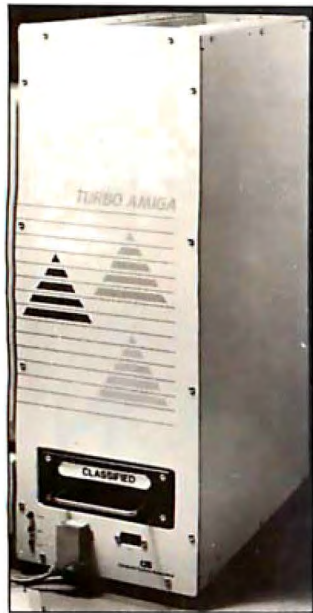

68020 power for the Amiga.

bytes. These Winchester Secure Data Cartridges (SDC) are primarily designed for environments where high security is required. The Winchester disk drive or an optional fixed internal hard disk drive is connected to the system by an SCSI card. The SCSI connector is also available for external control of any SCSI product.

Price: Starting at \$5475.

Contact: Computer System Associates Inc., 7564 Trade St., San Diego, CA 92121, (619) 566-3911.

Inquiry 589.

PC-File+ Features Report Writer and Other New Capabilities

ButtonWare's PC-File+, now written in C, is 5 times faster than previous versions and searches up to 10 times faster than PC-File II. The enhanced program is menu-driven, offers a teach mode, has over 175 help screens, and features a macro capability.

A new report writer features a report command language and the ability to paint reports on-screen. Enhanced searching capabilities let you retrieve data from multiple databases, sort fields, and perform global searches and updates on all or part of a field.

PC-File+ requires an IBM PC or compatible with at least 384K bytes of RAM, MS-DOS or PC-DOS 2.0 or higher, and two floppy disk drives or one floppy and one hard disk drive.

Price: \$69.95.

Contact: ButtonWare Inc., P.O. Box 5786, Bellevue, WA 98006, (206) 454-0479.

Inquiry 590.

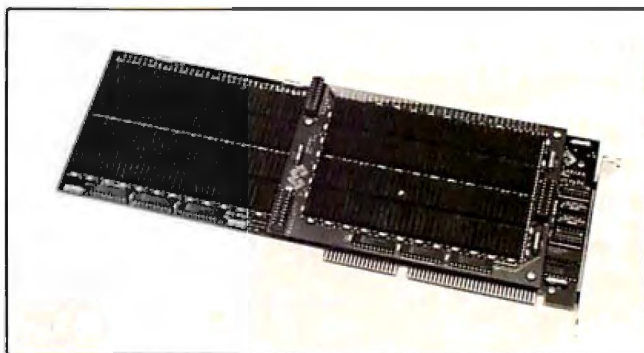

JustRAM packs up to 8 megabytes.

8 Megabytes in a Single AT Slot

Monolithic System's JustRAM board is designed for IBM PC AT and compatible owners who want to cram all the memory they can into a single expansion slot.

JustRAM comes in 4- and 8-megabyte configurations. It's compatible with the Lotus/Intel/Microsoft Expanded Memory Specification (LIM/EMS) and can be used as conventional, expanded, or extended memory. If you use a non-DOS operating system such as XENIX, you can access a full 16 megabytes of conventional memory using a pair of JustRAM boards.

The board will operate at up to 12 MHz with wait states, and up to 8 MHz with no wait states. It has on-board DIP switches that let you set the I/O address and gives you the option of backfilling conventional memory to 512K or 640K bytes.

JustRAM uses soldered 256K-bit ZIP RAM chips and is filled to 8 megabytes using a mezzanine board that installs on top of the existing board. MSC says they use a proprietary noise-reduction technique that allows them to tightly pack the board. **Price:** \$1495 with 4 megabytes; 4-megabyte add-on mezzanine board, \$1195; 8-megabyte combination board, \$2690.

Contact: Monolithic Systems Corp., 84 Inverness Cir-

cle E, Englewood, CO 80112, (303) 790-7400. **Inquiry 591.**

Leading Edge's AT-Compatible

The Model D2 is an IBM PC AT-compatible system from Leading Edge Hardware Products. Built around an 80286 processor, the D2's standard configuration includes 640K bytes of RAM (expandable to 1 megabyte on the motherboard), a single 5¼-inch 1.2-megabyte floppy disk drive, a monochrome monitor with an enhanced graphics adapter, and a 101-key AT-style keyboard.

The D2 system unit's footprint is one-third smaller than the AT and measures 16 by 15½ by 6 inches. Six expansion slots are included, and the D2 is switchable between clock speeds of 6 MHz, 8 MHz with no wait states, or 10 MHz with one wait state. The system is also available with an internal 30-megabyte hard disk drive. **Price:** \$1936; with 30-megabyte hard disk drive, \$2914.

Contact: Leading Edge Hardware Products Inc., 225 Turnpike St., Canton, MA 02021, (617) 828-8150. **Inquiry 592.**

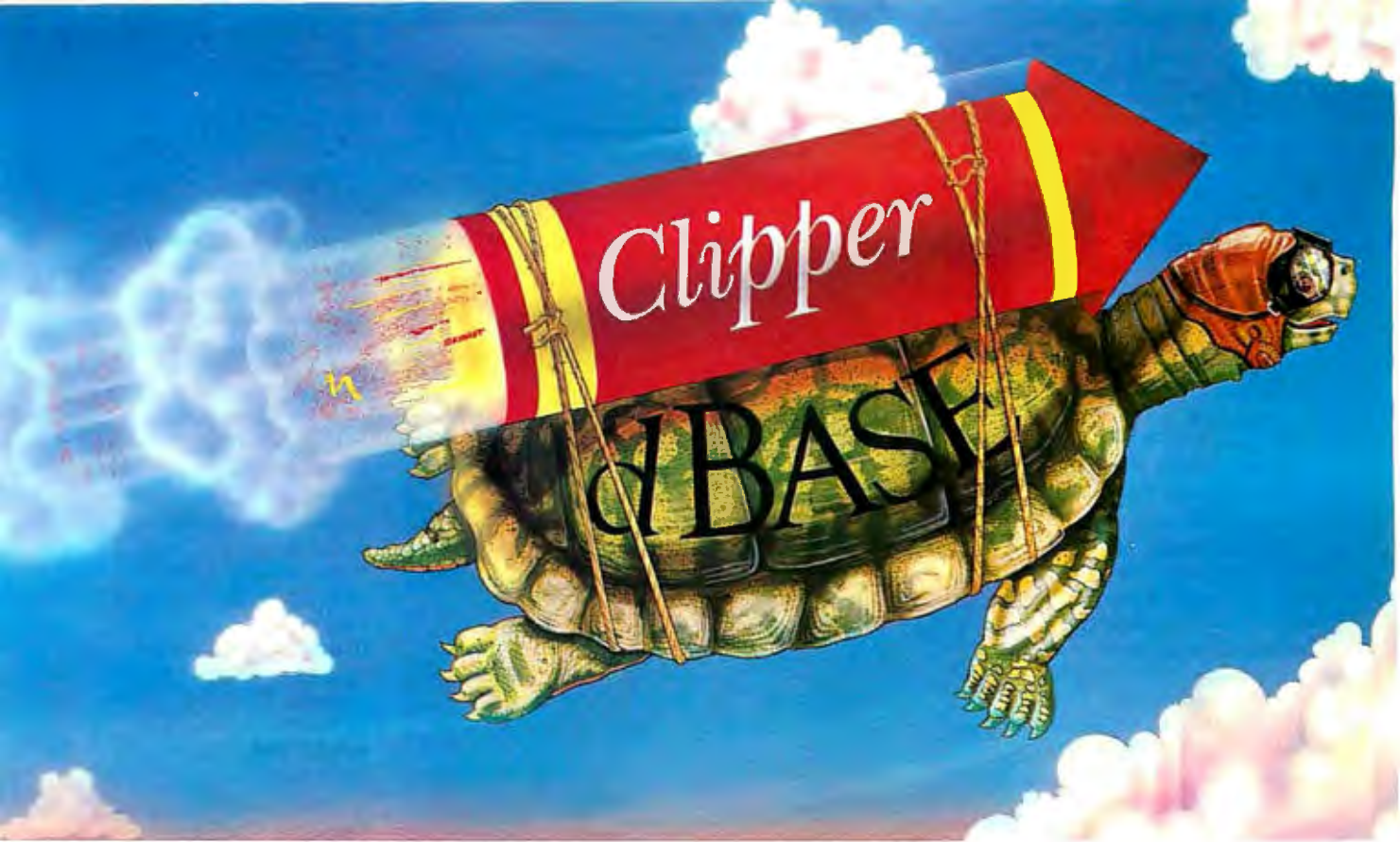

Real programmers don't use dBASE. Or do they?

We're finding that some very swift programmers are using it to write some very fast applications, and are completing their projects much more quickly.

But they cheat.

They use our Clipper™ compiler to combine dBASE™ with C and assembler.

With dBASE used like pseudo-code, they can then quickly create prototypes that actually run.

Then, with dBASE doing the high-level database functions, they use our Clipper compiler to link in C or assembly language modules from their own bag of tricks.

And they're finding that they're linking in less than they expected because Clipper compiled code runs so fast and because of Clipper's built-in enhancements.

Clipper includes easy networking that provides file and record locking the way it should be done.

Fast screens that can be treated as memory variables and eliminate the need for direct screen writes and all that tortuous heap management code.

Box commands that make windowing a breeze. And more.

So if you'd like to use your time more productively, check us out: Nantucket Corporation, 12555 W. Jefferson Boulevard, Los Angeles, CA 90066.

Or if you're on deadline, call (213) 390-7923 today.

Clipper could get you out of the soup.



 Nantucket®

© Nantucket Corporation 1987. Clipper is a trademark of Nantucket Corporation; dBASE isn't. In Europe: Nantucket Corporation (Europe) 2 Bluecoats Avenue, Fore Street, Hertford, Herts SG14 1PB Telephone 0992 554621.

Inquiry 213 for End-Users. Inquiry 214 for DEALERS ONLY.

MAY 1987 • B Y T E 35

SYSTEMS

Three New APCs

NEC's three new Advanced Personal Computer models are based on the 80286 processor and are fully IBM PC AT-compatible.

The PowerMate 1 is the lowest-priced of the three, with a smaller footprint than comparable AT clones. Its standard features include 8-MHz processor speed and 640K bytes of RAM (expandable to 8.6 megabytes). The base unit includes six full-length expansion slots (five 16-bit and one 8-bit), an RS-232C serial port, a parallel printer port, and a clock/calendar. Also included are two 5¼-inch floppy disk drives and a single 3½-inch disk drive.

The PowerMate 2 operates at either 8 or 10 MHz. It also comes with 640K bytes of RAM but is expandable to 10.5 megabytes. In addition to the parallel port, it has two RS-232C serial ports.

The BusinessMate is a high-performance multiuser system to which you can attach up to eight terminals. Its 80286 processor is software-switchable between 8 and 10 MHz and is configured with 640K bytes of RAM, expandable to 10.6 megabytes. It has a single 1.2-megabyte floppy disk drive and a standard 40-megabyte hard disk drive. The BusinessMate can support up to nine users operating under XENIX.

Video boards and monitors are optional with all three models.

Price: PowerMate 1, \$1995; PowerMate 2, \$2595; BusinessMate, \$6000.

Contact: NEC Information Systems Inc., 1414 Massachusetts Ave., Boxborough, MA 01719, (617) 264-8000.

Inquiry 593.



NEC's newest AT clone.

Commodore Upgrades 128

The 128D is Commodore's enhanced version of the C-128 with several new features. It has a detachable keyboard, a built-in 350K-byte 1571-compatible 5¼-inch floppy disk drive, and three operating modes.

The unit, which is smaller than the C-128, has 128K bytes of RAM (expandable to 640K). The C-128 operating mode takes full advantage of the unit's memory and 80-column display; the C-64 mode fully emulates a Commodore 64. The 128D also has a built-in Z80A processor for running CP/M programs.

The full-size detachable keyboard includes a 14-key numeric keypad, eight function keys, six cursor keys, and a separate Help key. The 128D also comes complete with a serial communications port, a cartridge port, and two joystick ports.

Price: \$550.

Contact: Commodore

Business Machines Inc., 1200 Wilson Dr., West Chester, PA 19380, (215) 431-9100.
Inquiry 594.

Compaq Upgrades Deskpro 286

Compaq's upgraded Deskpro 286 desktop AT-clone now runs at 12 MHz, increased from its prior 8-MHz top speed. The Deskpro is also equipped with faster (100-nanosecond) RAM and available hard disk storage of up to 80 megabytes.

The processor speed of the enhanced Deskpro 286 is keyboard-switchable to 8 MHz for applications that require a slower speed. Meanwhile, to ensure compatibility with AT-type expansion boards, the expansion bus of the Deskpro 286 always runs at 8 MHz.

The Deskpro has seven

available expansion slots. The enhanced Deskpro 286 is available in three standard configurations. The Model 1 has a single 1.2-megabyte floppy disk drive and 256K bytes of RAM; the Model 20 adds a 20-megabyte hard disk, and 640K bytes of RAM; the Model 40 has a 40-megabyte hard disk drive. Many options are also available.

Price: Model 1, \$2999; Model 20, \$3999; Model 40, \$4999.

Contact: Compaq Computer Corp., 20555 FM149, Houston, TX 77070, (713) 370-0670.

Inquiry 595

Two 386 Machines

The Noble 386 from PC Discount is an 80386-based personal computer that comes with the same standard features as the Compaq 386, including a 40-megabyte hard disk drive, 1.2-megabyte floppy disk drive, and 1 megabyte of RAM.

Price: \$3999.

Contact: PC Discount, 2000 Travis, Suite 630, Houston, TX 77002, (713) 864-0295.

Inquiry 596.

American Micro Technology's AMT-386 runs at either 6 MHz or 16 MHz and has a 64K-byte cache memory that allows operation with no wait states. The base unit has eight expansion slots and 1 megabyte of memory (expandable to 4 megabytes on the motherboard). It comes with a single 1.2-megabyte floppy disk drive. A hard disk is optional.

Price: \$2995.

Contact: American Micro Technology, 14751-B Franklin Ave., Tustin, CA 92680, (714) 731-6800.

Inquiry 597.

continued

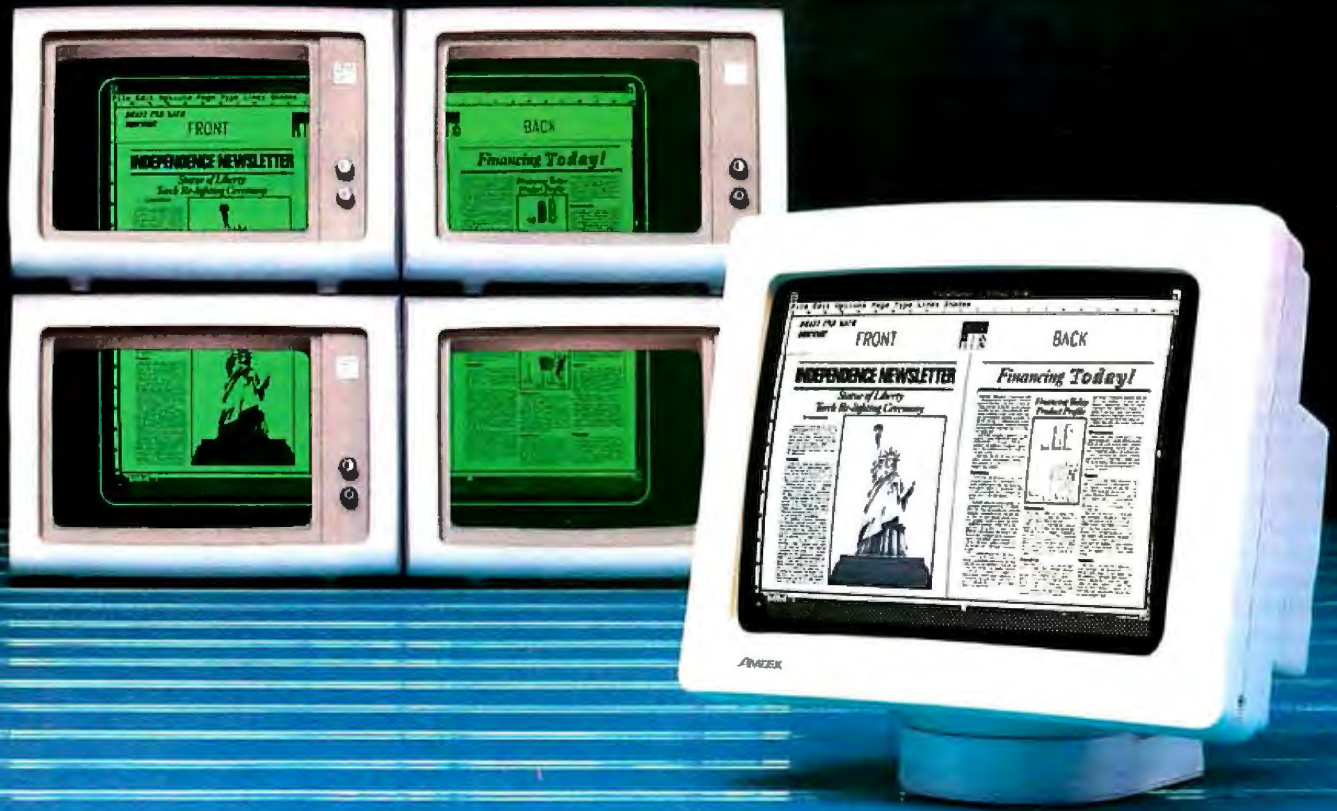

It takes four of theirs to display the same text and graphics as one Amdek 1280.

Now, you can create more comprehensive and detailed documents using the most popular Desktop Publishing packages. Because Amdek's 1280 graphics subsystem puts 1280 X 800 pixels on a big 15" white phosphor CRT.

There are a total of 11 modes. What's more, the

1280 provides complete monochrome and color graphics compatibility.

Price? The Amdek 1280 monitor and video board cost only \$999. So, if you work with desktop publishing, CAD or Lotus, Amdek's 1280 graphics subsystem is clearly your best buy.

The Amdek 1280 provides 1280(H) X 800(V) resolution with these software packages:

GENERAL PC SOFTWARE

Lotus 1-2-3
Symphony

DESKTOP PUBLISHING

AdvanTex
Venture Publishing
PageMaker/PC
Frontpage
DeskSet
Pagemaster
Rim Systems
Compound Document Processor
Display Ad Make-up System

COMPUTER-AIDED DESIGN

AutoCAD
Cadvance
Drafix 1
In-A-Vision
Generic CADD
VersaCAD ADVANCED
Workview
Procad PC
P-CAD System

GRAPHICS SYSTEM TOOLS

MS-Windows
GEM
MetaWindows
HALO
KEE PC

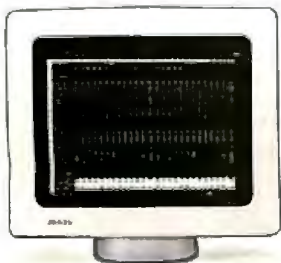

AMDEK

Clearly the finest in monitors.

2201 Lively Blvd., Elk Grove Village, IL 60007
Phone: (312) 364-1180 TLX: 280-803



PERIPHERALS

Networking High-Speed Printer

Output Technology's TriMatrix 850 PrintNet is a dot-matrix printer with built-in networking capabilities. Up to five users can connect directly to the PrintNet through serial ports. Besides being a printing station for multiple users, the unit also acts as a network communications controller and memory storage unit. Any device capable of serial communications (computers, printers, modems, etc.) can be connected to the 850 PrintNet and can exchange data in RS-232C or RS-422 formats at speeds of up to 19.2k bps. The PrintNet 850 handles forms up to 136 columns wide and forms with up to six parts. The company claims the printer throughput is 240 lines per minute, with a burst speed of up to 850 characters per second. It has 256K bytes of internal memory, and a 1.5-megabyte option is available.

Price: \$2995.

Contact: Output Technology Corp., East 9922 Montgomery, Suite 6, Spokane, WA 99206, (509) 926-3855. **Inquiry 598.**

Bizcomp 2400-bps Echo-Canceling Modems

The IntelliModem 2400 is available in both external and internal configurations, is fully Hayes-compatible, and uses the company's proprietary Adaptive Echo Cancellation (AEC) for augmenting traditional adaptive equalization. AEC creates a lookalike copy of the near-end echo signal it expects back from the telephone line, then inverts it. When the synthetic negative echo adds to the genuine positive echo, they



A printer with networking capabilities.

cancel each other out. The purpose of the AEC is to cut down transmission errors caused by poor line conditions.

The IntelliModem 2400 also supports 1200 or 110 to 300 bps and includes audio call-progress monitoring with adjustable volume controls and RJ-11 connectors for connecting telephone sets.

The external model features a multicolor signal quality bar graph display and easy access to option switches. The internal model is a half-card for short slots in PCs and compatibles.

Price: \$599.

Contact: Bizcomp Corp., 532 Mercury Dr., Sunnyvale, CA 94086, (408) 733-7800. **Inquiry 599.**

Disk Drive for Tandy Portables

The Tandy Portable Disk Drive 2 is a new version of a 3½-inch floppy disk drive that works with the Tandy 102 and Tandy 200 portable computers. Measuring 2½ by 5¼ by 6⅞ inches, the unit weighs less than 2 pounds and operates off AC power with an included adapter, or off four AA alkaline batteries. Tandy says the batteries will operate the drive continuously for 1½ hours.

The Drive 2 stores 200K bytes of data on a single-sided 3½-inch disk and has both disk-access and low-battery indicators. It transfers data through the computer's serial port at 19.2k bps.

Price: \$199.95.

Contact: Tandy Corp., 1800 One Tandy Center, Fort Worth, TX 76102, (817) 390-3011.

Inquiry 600.

HP's Desktop Scanner

Hewlett-Packard's HP ScanJet scanner is a flatbed desktop scanner that enables you to electronically scan documents for use in desktop-publishing applications. The flatbed scanning surface is 8½ by 11 inches, but by adding the optional automatic feeder, you can scan both larger pages and multiple-page documents.

After selecting a resolution from 38 to 300 dots per inch, you can scan a document for on-screen preview or input a full-page image and store the data on a hard disk. The scanner is also capable of image enlargement and re-

duction; you can reduce image size to as little as 13 percent or enlarge it up to 1578 percent.

The HP ScanJet scanner can distinguish among 16 different levels of gray. It supports three image-data types: binary, dithered, and 4-bit gray scale.

MS-DOS and MS Windows versions of HP Scanning Gallery are included with the HP ScanJet scanner. They let you store scanned data in several different file formats.

The HP unit features a Centronics parallel interface card. The card will work with the HP Vectra PC, IBM PC XT, AT, and compatibles.

Price: \$1495.

Contact: Hewlett-Packard Co., 1820 Embarcadero Rd., Palo Alto, CA 94303, (800) 367-4772.

Inquiry 601.

Nine-ounce Portable Modem

The Pocket Modem from Migent runs at 1200 bps, weighs only 9 ounces, and measures 1.3 by 2.5 by 5 inches; small enough to fit in a shirt pocket. It operates either off a standard 9-V battery or with a 110-V AC adapter and uses surface-mount technology.

The unit has dual telephone jacks, busy and dial-tone monitoring, and can sense remote rings and tones. It also has a 28-character nonvolatile memory for storing telephone numbers and access codes.

Included with the Pocket Modem are a communications software package, a 7-foot telephone-line cord, an 18-inch serial cable, and a 9-V battery.

Price: \$259.99.

Contact: Migent Inc., P.O. Box 6062, Incline Village, NV 89450, (702) 832-3700.

Inquiry 602.

continued

New! In•a•Vision is Compatible with AutoCAD

FREE AutoCAD Translator
Limited Offer

Complex Drawing Made Easy

We created In•a•Vision just for you. The engineer who needs more productive drafting support. The designer who needs versatility for alternate ideas or quick revisions. The architect who needs to manage a variety of working drawings. And the businessman who needs first-class presentation materials as well as detailed flow charts and organization charts.

Point. Click. Draw.

Now all you do to create complex technical drawings, systems designs, blueprints, diagrams, illustrations, and proposals is point, click and draw. With In•a•Vision's mouse support, windowing, icons,

and pull-down menus, you produce drawings more quickly, accurately and efficiently than ever before. In•a•Vision's advanced technology includes many features not found on comparable systems costing thousands more. For example, you can pan around in a user-definable drawing space up to 68" x 68" and zoom in on specific areas for

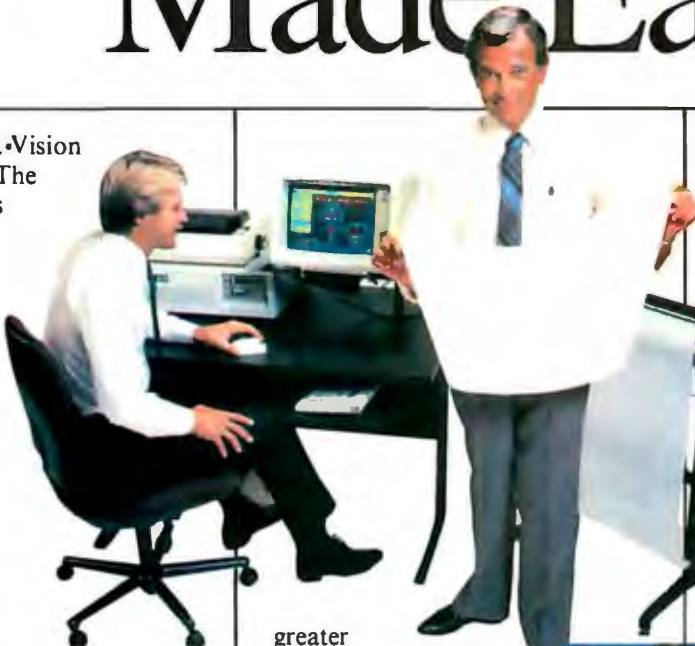

greater detail. Scale, rotate and dimension symbols, fill an area with your choices of pre-defined colors and patterns, as well as draw lines with multiple styles and widths. Other features include overlays, predefined and user-definable page sizes, rulers, grids, and templates to speed popular applications.

Multi-tasking in a PC-based CAD system.

In•a•Vision uses multi-tasking to enable you to continue drawing while printing hard copies or edit multiple drawings simultaneously.

FREE AutoCAD Translator from MICROGRAFX!

When you purchase In•a•Vision we'll give you a free copy of our new AutoCAD™ translator. The Micrografx AutoCAD TRANSLATOR (retail value \$100) bi-directionally transforms all drawing attributes including colors, line styles, overlays, fonts, views and object hierarchy. (Send

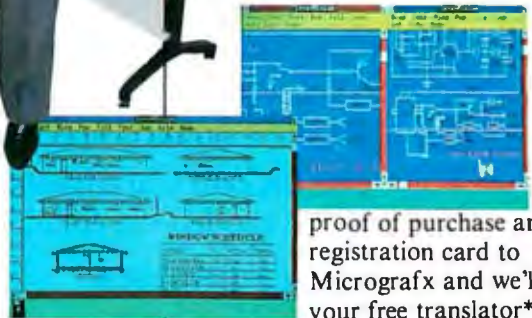

proof of purchase and your registration card to Micrografx and we'll return your free translator*.)

We're confident you'll agree — In•a•Vision will make your complex drawing tasks simple and make you more productive. Satisfaction guaranteed.

TO ORDER CALL: 800-272-3729

Demo disk** or brochure available to qualified customers. In Texas or for customer support, call (214) 234-1769.

MICROGRAFX, Inc., 1820 North Greenville Avenue, Richardson, Texas 75081.

Inquiry 199

(Most popular graphics cards, plotters, and printers supported.)

Microsoft Windows-compatible. Call for specific operating environment requirements.

*Offer good only on purchases after January 1, 1987

**Demo requires MS Windows. Full demonstration system for users without Windows available for \$49.00.

MICROGRAFX™
The Picture of Success.

AutoCAD is a trademark of Autodesk INC.

In•a•Vision, Micrografx AutoCAD TRANSLATOR, and MICROGRAFX are trademarks of MICROGRAFX, Inc.

Microsoft is a trademark of Microsoft, Inc.

Introducing the Hercules InColor Card.

*It runs more software at a higher resolution
than any other color graphics card.*

The Hercules® InColor™ Card offers everything you'd expect from a high resolution color graphics card from Hercules — and more.

Compatibility: The InColor Card is compatible with the thousands of programs that run on our monochrome cards.

Color: The InColor Card gives color capability to Hercules-compatible software like 1-2-3® and AutoCAD®.

Resolution: The InColor Card's resolution of 720x348 is the highest of any widely supported standard.

RamFont: The InColor Card has our unique RamFont mode — in color.

Better graphics.

Hercules is known for bringing high

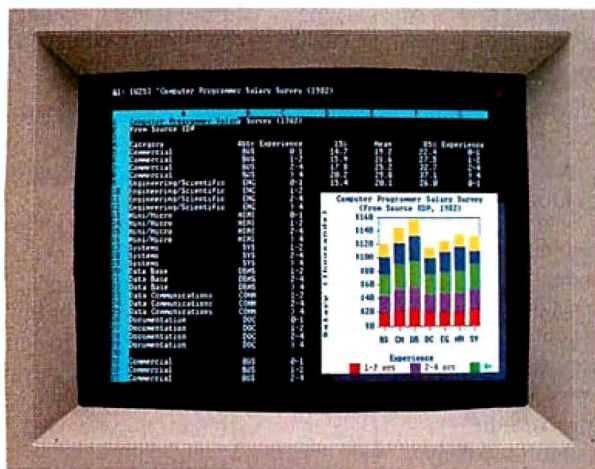

The InColor Card's RamFont mode gives Lotus 1-2-3 a pop-up graphics window and lets you view nearly twice as much spreadsheet data—all in full color.

resolution monochrome text and graphics to programs like 1-2-3® and AutoCAD®.

Now the InColor Card gives you the same high resolution 720x348 graphics in up to 16 colors using an IBM® Enhanced Color Display, multi-sync monitor, or equivalent.

That's the highest resolution of any widely supported graphics standard.

And no other color graphics card allows you to move back and forth between color and monochrome systems *without changing drivers*.

Runs more software.

All Hercules-compatible text, graphics and RamFont software runs on the InColor Card in black and white, or at least two colors.

And many popular programs like 1-2-3, Symphony®, AutoCAD and Microsoft® Windows that use graphics or RamFont, run in full color:

More powerful RamFont.

RamFont is a new mode developed by Hercules that gives your software the ability to display multiple fonts at lightning fast speeds.

RamFont transforms advanced word processors like Microsoft Word from slow to text-mode fast.

Technical word processors like Lotus Manuscript™ use RamFont

to display onscreen the text you want to print.

Even 1-2-3 uses RamFont to almost double the size of the spreadsheet picture.

And now, with the InColor Card, you get an enhanced RamFont with 3,072 programmable characters in up to 16 colors.

All the way up to 12,288 characters in four colors.

With the InColor Card's RamFont, no program should run out of speed, color or fonts ever again.

What the InColor Card could mean to your company.

The InColor Card allows you to run a program in color, and then move to a Hercules Graphics Card Plus and run the same program in monochrome.

Without changing drivers.

Compatibility between the InColor Card and our monochrome card allows you to network around one standard Hercules. At last your PCs will have compatible graphics, in color or monochrome.

Remember, only the InColor Card has color-to-monochrome compatibility, high resolution text and graphics, and the power of color RamFont.

To find out more about the new Hercules InColor Card, call 1-800-532-0600 Ext. 502. (In Canada, call 1-800-323-0601 Ext. 502.)



AutoCAD gets the same high resolution 720x348 graphics as our famous monochrome cards—only now in full color on an IBM Enhanced Color Display.

Features of the Hercules InColor Card

- Hi-res text with 9x14 character size in up to 16 colors with attributes
- 720x348 Hercules graphics in 16 colors selected from 64 color palette
- Special RamFont mode displays 3,072 programmable characters in 16 colors with attributes, up to 12,288 characters in 4 colors
- Runs Hercules-compatible graphics software in b&w or any two background colors
- Designed for use with the IBM Enhanced Color Display, multisync monitors, or equivalents
- Software diskette includes font editor, sample fonts, and Hercules utilities
- Parallel printer port
- Two year warranty



The New Hercules InColor Card.

Hercules Computer Technology, 2550 Ninth St., Berkeley, CA 94710 Ph: 415 540-6000 Telex: 754063 Fax: 415 540-6621 Trademarks/Owner: Hercules, InColor, RamFont/Hercules; Lotus, 1-2-3, Symphony, Manuscript/Lotus; Microsoft/Microsoft; AutoCAD/AutoDesk; IBM/IBM

NEC's Ultrahigh-Resolution Graphics Board

The MultiSync Color Graphics Board from NEC Home Electronics U.S.A. is an ultrahigh-resolution 16-color display card with a resolution of 640 by 480 pixels, functionally equivalent to the IBM Professional Graphics Adapter.

The board requires an NEC MultiSync monitor (or equivalent). Compatibility for running software in CGA (color graphics adapter), EGA (enhanced graphics adapter), MDA (monochrome display adapter), and Hercules modes is made possible through the board's high-speed hardware, which also supports all true EGA functions. It includes extended text modes, which let you display text of 80 characters by 60 lines, or spreadsheets with up to 132 columns by 44 lines.

Screen drivers are provided to let users of Lotus 1-2-3, Dr. Halo, and AutoCAD take full advantage of the 640 by 480 resolution mode with Microsoft Windows.

Other features include a parallel printer port, print spooler software, and hardware zoom and viewport to let you zoom in on an image at up to eight times magnification for detailed viewing or pixel editing. The MultiSync Color Graphics Board uses an ET2000 chip set with a micro-engine that assumes certain CPU functions such as bit-mapped graphics memory read/write. NEC claims this results in a speed improvement of up to 300 percent. **Price:** \$649.

Contact: NEC Home Electronics (U.S.A.) Inc., 1255 Michael Dr., Wood Dale, IL 60191, (312) 860-9500. **Inquiry 603.**

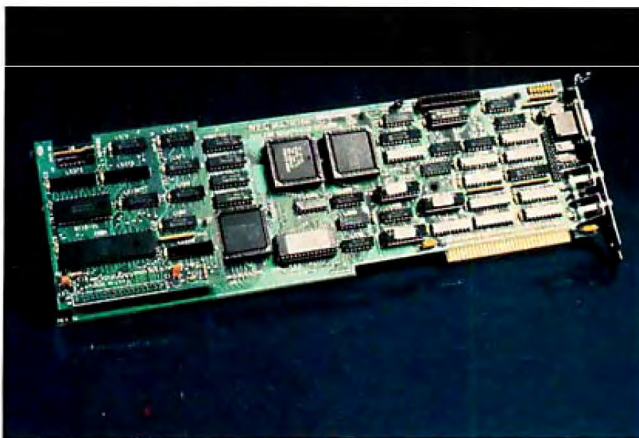

MultiSync board for the MultiSync monitor.

Atari Upgradable RAM Board

The ST Solderless RAM board is a RAM upgrade for the Atari 520ST computer. It features solderless plug-in installation and comes with enough RAM to upgrade a 520ST to 1 megabyte.

After installation, upgrading the board to 2.5 or 4 megabytes is simply a matter of plugging in 1-megabit RAM chips into the empty sockets.

Price: \$199.95.

Contact: E. Arthur Brown Co., 3404 Pawnee Dr., Alexandria, MN 56308, (612) 762-8847.

Inquiry 604.

Hercules Color Graphics Card

The InColor Card is a color version of the Hercules Graphics Card Plus. It's compatible with all standard text programs, with programs that support the Hercules monochrome graphics standard, and with programs that make use of the Hercules RamFont display mode.

The new card is capable of displaying 16 colors out of a palette of 64 in 720-by-348-pixel resolution. The board can also display any application in white on black or in any other two colors that you select. The InColor Card re-

quires a MultiSync color monitor and meets the specifications of the IBM Enhanced Color Display.

The board includes the Hercules printer port on a chip, which can be disabled to prevent conflicts with other cards in the system. Also included are FontMan, a font editor for creating new character fonts for use in the RamFont mode, and a graphics-mode screen dump for use with Epson and IBM graphics printers. **Price:** \$499.

Contact: Hercules Computer Technology, 2550 Ninth St., Berkeley, CA 94710, (415) 540-6000.

Inquiry 605.

PC Accelerator: Kit or Assembled

NRG Electronics' PC Accelerator (PCA) speeds up your IBM PC or clone by increasing the system's clock speed by 30 percent or more. The 8284A chip is replaced by a plug-in PC board containing two crystals. The processor speed is increased from 4.77 to 6 MHz while other system clocks are left undisturbed.

Depending upon the system in which it's being in-

stalled, the PCA circuit board can be installed horizontally, vertically, or remotely using a ribbon cable. A remote-control box is included that mounts on the keyboard and has a normal/fast speed-selection switch, an LED indicator, and a hardware reset selector switch that lets you reset it when the system locks up without turning the power off.

You can use the PCA with any computer that has an 8248A clock chip running at 4.77 MHz (14.318-MHz crystal). It cannot be used with turbo boards or other speed-enhanced systems where the clock frequency is greater than 4.77 MHz. The PCA is available either as a kit or a fully assembled unit. **Price:** Kit, \$29.95; assembled and tested, \$49.95. **Contact:** NRG Electronics, P.O. Box 24138, Fort Lauderdale, FL 33307, (305) 971-3823.

Inquiry 606.

Amber CRT for the Mac

The Amber Mac is an amber replacement CRT for the Apple Macintosh. With Italian-designed 30-millisecond long-persistence phosphors, the Amber Mac is compatible with European VDT standards and is an exact electrical and mechanical replacement for all Macintosh computers with the exception of the Macintosh II.

Detailed, illustrated installation instructions are included, and the company claims installation and adjustment takes 15 minutes. The patented "Orange Drop" tube also has special additives that reduce phosphor etching. **Price:** \$99.

Contact: Systems Research, 1111 West El Camino, Suite 109, Sunnyvale, CA 94087, (408) 730-5217.

Inquiry 607.

continued

VARROOMMM

ONLY ORCHID GIVES YOU SO MANY WAYS TO TURBOCHARGE PC ENGINES.

With Orchid's family of turbos, you can get the performance you bought a computer for in the first place. Lightning spreadsheet *recalculations*. CAD screens that *regenerate* in a flash. And large data bases that sort without putting you to sleep.

ORCHID'S TURBO FAMILY

	TinyTurbo 286	PCturbo 286e/2	Jet 386
Host Computer	PC,XT	PC,XT,AT	AT
Reference Speed	3 x XT	8 x XT	3 x AT
Accelerator Type	Replaces 8088	Co-processor	Replaces 80286
CPU	8 MHz 80286	12 MHz 80286	16 MHz 80386
RAM	8 K Cache	1 or 2 MB EMS	64 K Cache

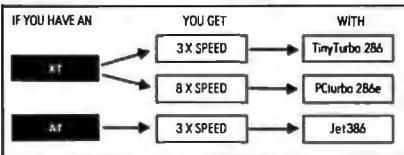

GET THE EDITOR'S CHOICE: TinyTurbo 286™

The TinyTurbo 286™ supercharges your XT to run *three times faster*. Yet it's so small it takes up only half a slot in your computer. Just two reasons why *PC Magazine* named it the Editor's Choice.

TinyTurbo 286 gives you a high level of compatibility. So you can run software like Lotus and Windows—with EGA graphics, EMS memory, or networking cards—at AT speed. You can even go back to your PC's regular 8088 chip, which remains in the system, giving you 100% hardware compatibility.

ADD AWESOME PERFORMANCE: PCturbo 286e™

For power users, the front runner today in accelerators is clearly the PCturbo 286e™. It revs up to *8 times faster* than an XT, or up to *2.5 times* AT speed—giving you the world's fastest screen I/O. Plus the PCturbo 286e comes factory equipped with 1 Megabyte of fast RAM, expandable to 2.

The PCturbo 286e is also a powerful tool for developers and systems integrators. With features like an optional 10-MHz 80287 math chip, and coprocessing software for concurrent foreground/background tasks, the PCturbo 286e lets you build minicomputer-like performance into standard PCs.

MOVE YOUR AT UP TO 386 HORSEPOWER NOW: Jet 386™

Take a look today at the price/performance leader in desktop computing: the Jet 386™. Depending on the application, it's up to *three times faster* than an AT. And *twice as fast* as some high-performance minicomputers. Yet you don't have to buy an expensive 386-based computer to get this kind of horsepower.

More importantly, the Jet 386 uses next generation technology, the 80386 microprocessor. So you can run all of the current software for the AT now, and 386 software too. Add a Jet 386 to your AT today, and you can extend the life of your investment—for a fraction of the cost.

Jet 386: 3 Times AT Speed

PCturbo 286e: 8 Times XT Speed

FROM THE COMPANY THAT STARTED IT ALL.

Orchid introduced the first turbo for PCs, and has since become the number one supplier of PC accelerators. For details on our full line of accelerators, graphics, networks and multi-function cards, call (415) 683-0300 today. Or contact your local dealer.

TinyTurbo 286, PCturbo 286e and Jet 386 are trademarks of Orchid Technology. All other product names are trademarks of their manufacturers.
ORCHID TECHNOLOGY
45365 NORTHPORT LOOP WEST
FREMONT, CA 94538
(415) 683-0300; Tlx 709289.



TinyTurbo 286: 3 Times XT Speed



Soft PC Provides MS-DOS Simulation on Non-Intel Processors

Soft PC from Insignia Solutions lets you run MS-DOS programs on other systems. Its CPU module reproduces the 8088's instruction operations, the effective hybrid addresses, and the condition codes.

The I/O devices module provides the interface between Soft PC and the host environment. To interact with IBM PC peripherals, the program intercepts the commands to the peripheral controllers, simulates the commands, and substitutes equivalent operations to the peripherals of the host environment.

Soft PC includes an alternate BIOS that doesn't depend on IBM code and is written in C.

Insignia Solutions reports that Soft PC is capable of running virtually all PC-DOS and MS-DOS applications, but those that incorporate timing dependencies peculiar to a real IBM PC (for example, real-time process control) can create problems. The company also reports that the speed of operations is related to the performance of the host machine, and the minimum speed provided is equal to that of an IBM PC XT.

The program runs on XTs and compatibles with an 8088 microprocessor, 1 megabyte of RAM, and a 20-megabyte hard disk drive. It also requires two RS-232C ports mapped to serial ports on the host machine. Insignia claims that because the software involves no hardware, it can run on machines with no expansion slots.

For output, you can use an IBM-compatible serial printer attached to serial ports on the host, and you can direct output to the host printer or file. The program also supports the IBM



Soft PC from Insignia Solutions.

Color Graphics Adapter.

Price: \$500 to \$750.

Contact: Insignia Solutions Inc., 1255 Post St., Suite 625, San Francisco, CA 94109, (415) 771-7001.

Inquiry 608.

Datalight C Compiler

Optimum-C is a global-optimizing C compiler from Datalight that analyzes a function and generates executable code based on the total view of the function. It uses the technique of data-flow analysis to gather information about the function.

An optimizer phase, which is slower than the development and debug phases, is optional. During the development and debug phases, the optimizer is not used. However, it is used when you compile a production version of the program.

The compiler supports the UNIX System V C language, along with several proposed ANSI extensions, according to Datalight. Other features of Optimum-C include 8087 and floating-point support, strong type checking, ROMable code generation, a Make program, MS-DOS object files format, and compatibility with Lattice C. It includes a library that contains over 185

UNIX-compatible and MS-DOS functions, along with the source code for the library and start-up routines.

Optimum-C runs on IBM PCs with 192K bytes of free memory, a hard disk drive, and MS-DOS or PC-DOS 2.0 or higher.

Price: \$139.

Contact: Datalight, P.O. Box 82441, Kenmore, WA 98028, (206) 367-1803.

Inquiry 609.

Graph-in-the-Box Application Development

New England Software's Application Development Kit for Graph-in-the-Box, a RAM-resident graph program, can be integrated into your application programs. It allows you to add 11 chart types, 10 fill patterns, 10 line types, 16 colors, explodable pie sections, 500 observations, and 15 variables.

Price: \$187.60.

Contact: New England Software, Greenwich Office Park 3, Greenwich, CT 06831, (203) 625-0062.

Inquiry 610.

Tree-Structured Scheduling Tool

Trees-pls is a programming language that Avyx calls a resource-management tool. It was originally developed for NASA to utilize as a scheduling tool, and Avyx has adapted it to the IBM PC.

The program is a toolkit that lets you create applications for scheduling time-restricted projects. One of the program's features is its ability to manipulate tree structures, letting you use it in artificial intelligence applications. You can also use Trees-pls for scheduling, allocating resources, controlling projects, and managing information. Interfaces to graphics, C, and FORTRAN are supported.

Trees-pls runs on IBM PC, XT, AT, and compatibles with at least 512K bytes of RAM with PC-DOS or MS-DOS 2.0 or higher.

Price: \$995.

Contact: Avyx Inc., 265 Honeywell Center, 304 Inverness Way S, Englewood, CO 80112-5819, (303) 790-0514.

Inquiry 611.

FORTRAN, C, and Pascal Compilers for the Macintosh II

UniSoft's FORTRAN 77, C, and Pascal compilers for Macintosh IIs that run Apple's A/UX operating system generate code that is 30 percent smaller and two to four times faster than other compilers.

Green Hills Software designed the compilers and UniSoft ported them to A/UX, the implementation of the UNIX System V operating system developed by Apple Computer and UniSoft.

Price: \$700.

Contact: UniSoft Corp., 739 Allston Way, Berkeley, CA 94710, (415) 644-1230.

Inquiry 612.

continued

WHY LOGITECH MODULA-2 IS MORE POWERFUL THAN PASCAL OR C.



APPRENTICE PACKAGE

\$99

- Separate Compilation w/inter-module typechecking
- Native Code Generation
- Large Memory Model Support
- Most Powerful Runtime Debugger
- Comprehensive Module Library
- Maintainability
- Translator from Turbo and ANSI Pascal

WIZARDS' PACKAGE

\$199

Call for information about our VAX/VMS version, Site License, University Discounts, Dealer & Distributor pricing.

To place an order call toll-free:

800-231-7717

In California:

800-552-8885

NEW!

APPRENTICE PACKAGE \$99

Everything you need to begin producing reliable maintainable Modula-2 code. Includes the Compiler with 8087 support, integrated Editor, Linker, and BCD Module. We're also including FREE our Turbo Pascal to Modula-2 Translator!

NEW!

WIZARDS' PACKAGE \$199

This package contains our Plus Compiler—for professional programmers or for those who just want the best. The Plus Compiler with Integrated Editor requires 512K and takes advantage of the larger memory to increase compilation speed by 50%. Our Turbo Pascal to Modula-2 Translator is also included at no extra charge.

NEW!

MAGIC TOOLKIT \$99

We've put our most powerful development tools into one amazing Toolkit for use with either the Apprentice or Wizards' packages. Highlighted by our Runtime Debugger, the finest debugging tool available anywhere, the Toolkit also includes our Post Mortem Debugger, Disassembler, Cross Reference utility and Version which keeps track of different versions of one program. Our MAKE Utility figures out module dependencies and automatically selects those affected by code changes to minimize recompilation and relinking. We also provide source code of our major library modules for you to customize—or just play with.

WINDOW PACKAGE \$49

Now you can build true windowing into your Modula-2 code. Features virtual screens, color support, overlapping windows and a variety of borders.

ROM PACKAGE AND CROSS RUN TIME DEBUGGER \$299

For those who want to produce rommable code. You can even debug code running in ROM from your PC.

Turbo Pascal is a registered trademark of Borland International.

WIN A FREE TRIP TO Switzerland



HOMELAND OF MODULA-2

Return your Modula-2 Registration Card or a reasonable facsimile*, postmarked between March 1, 1987 and May 31, 1987 to be included in a once-only drawing!

Grand Prize: One week excursion for 2 in Zurich, Switzerland including a guided tour of ETH, the University where Modula-2 was created by Niklaus Wirth. European customers may substitute a trip to Silicon Valley, California.

Second and Third Prizes: LOGITECH C7 Mouse or LOGITECH Bus Mouse with Paint & Draw software—a \$219 value, absolutely free!

*Write to Logitech, Inc. for a registration card facsimile.

YES! I want the spellbinding power of LOGITECH Modula-2!

- | | |
|---|-------|
| <input type="checkbox"/> Apprentice Package | \$99 |
| <input type="checkbox"/> Wizards' Package | \$199 |
| <input type="checkbox"/> Magic Toolkit | \$99 |
| <input type="checkbox"/> Window Package | \$49 |
| <input type="checkbox"/> ROM Pkg/Cross RTD | \$299 |

Add \$6.50 for shipping and handling. Calif. residents add applicable sales tax. Prices valid in U.S. only.

Total Enclosed \$ _____

VISA MasterCard Check Enclosed

Card Number _____ Expiration Date _____

Signature _____

Name _____

Address _____

City _____ State _____

Zip _____ Phone _____



LOGITECH

LOGITECH, Inc.
805 Veterans Blvd. Redwood City, CA 94063
Tel: 415-365-9852

In Europe:
LOGITECH SA, Switzerland
Tel: 41-21-879656 • Telex 458 217 Tech Ch

In Italy:
Tel: 39-2-215-5622

Two CAD Updates

CADKEY 3.0, from Micro Control Systems, offers a three-dimensional programming language, CADKEY Advanced Design Language, which includes three-dimensional data primitives, CADKEY command access, unlimited program size, and macro table management.

Enhanced two-dimensional drafting capabilities include the addition of ordinate dimensioning, European and English drafting standards, and fractional dimensioning.

Another addition to version 3.0 is an on-line calculator that supports trigonometric and algebraic functions. Other improvements include a unified database that lets you describe a 3-D wire-frame model, shade the model, and transmit interactively synthesized solid primitives to an engineering analysis and animation utility. You can also output vector or rasterized images to desktop-publishing programs.

CADKEY runs on the IBM PC and compatibles with 640K bytes of RAM and MS-DOS 2.0 or higher. It also requires one hard disk drive and one floppy disk drive. **Price:** \$3195.

Contact: CADKEY Division, Micro Control Systems Inc., 27 Hartford Turnpike, Vernon, CT 06066, (203) 647-0220.

Inquiry 613.

Generic CADD version 3.0 is 20 percent faster than version 2.0, according to Generic Software, and it offers more control over views and line types. You can choose from 10 standard line types and call out any line width. "Named views" is a new feature that lets you name a portion of a drawing displayed on the screen and later recall or plot it.

You can use Generic CADD 3.0 as a base module



CADKEY 3.0 with three-dimensional programming language.

for a system of computer-aided design tools, including DotPlot 3.0, which lets you use over 100 dot-matrix and laser printers. AutoConvert 3.0 uses the Drawing Exchange Format, so you can exchange drawings with AutoCAD and other software using the DXF format. AutoDimensioning 3.0 adds dimensions, legends, extension lines, leaders, and arrows. Drafting Enhancements-1 3.0 adds solid fill and cross-hatching with standard or user-defined patterns. And the Generic IGES module lets you exchange drawings with mainframe and minicomputer CAD programs that support the International Graphics Exchange Standards.

Generic CADD 3.0 runs on IBM PCs and compatibles with at least 384K bytes of RAM, MS-DOS or PC-DOS 2.0 or higher, and two floppy disk drives or one floppy and one hard disk drive. A Hercules graphics card, CGA, or EGA is also required. Generic recommends an 8087 or 80287 math coprocessor, 640K bytes of RAM, two serial ports, and a mouse or digitizer tablet.

Price: \$99.95.

Contact: Generic Software Inc., 8763 148th Ave. NE, Redmond, WA 98052, (206) 885-5307.

Inquiry 614.

Chemical Document Processing

ChemText is a chemical document processor that lets you accent chemical structures, create reaction schemes, flowcharts, process diagrams, and create other drawings that include boxes, lines, arcs, circles, and arrows. The program is part of the Chemist's Personal Software Series from Molecular Design.

ChemText's drawing editors let you produce molecules, reactions, forms, and equations. A set of science and math symbols is included that let you build complex multilevel equations in ChemText documents. You also have the ability to insert images from other sources into ChemText documents.

Fonts include Greek, large and undersize Roman, Fraktur, European Roman, Cyrillic, and script.

It runs on IBM PC, XT, AT, and compatibles with at

least 640K bytes of RAM with MS-DOS or PC-DOS 2.0 or higher. You need a Hercules graphics card, a CGA, or EGA to run the program. With the Enhanced Graphics Adapter you'll need at least 128K bytes of graphics memory. It also requires a 10-megabyte hard disk drive and a 360K-byte floppy disk drive.

Price: \$1500.

Contact: Molecular Design Limited, 2132 Farallon Dr., San Leandro, CA 94577, (415) 895-1313.

Inquiry 615.

Engineering Design

VersaCAD/Mechanical is an add-on to VersaCAD or VersaCAD Design that helps you to improve productivity in mechanical-part design and automated manufacturing. The program offers you design features on a tablet overlay. Geometric tolerancing, enhanced dimensioning, and mechanical construction features are included.

Dimensioning features include ANSI Y.14.5M-1982 standard dimensioning symbols. Dimensioning capabilities include limit dimensioning, which provides upper- and lower-limit dimensions, and tolerance and radial dimensioning. VersaCAD/Mechanical supports full- and small-cross-hair center lines for circles and arcs, as well as interactive leader lines for text. It also supports construction tools such as chamfers, fillets, tangents, and line stretch.

Price: \$495.

Contact: Versacad Corp., 7372 Prince Dr., Huntington Beach, CA 92647, (714) 847-9960.

Inquiry 616.

continued

We put our money where our Mouse is.

LOGITECH C7 MOUSE \$99

PC MAGAZINE
"EDITORS CHOICE"

"...To sum up my feelings about this mouse and menu generating system: this is the one I want."
Phil Wiswell
PC Magazine, Jan 27, 1987

At LOGITECH we've spent years perfecting our high-quality mouse hardware and software. And every LOGITECH Mouse reflects the engineering we've devoted to it.

MAXIMUM COMPATIBILITY

The programmable LOGITECH Mouse works with virtually ALL hardware and application software.

BEST MOUSE TECHNOLOGY

The opto-mechanical LOGITECH Mouse offers the best of all worlds. Mechanical tracking (a ball) and optical decoding (precise, reliable optical encoders). Every major computer manufacturer, including Apple, IBM and DEC, has chosen opto-mechanical mouse technology. LOGITECH offers the only opto-mechanical mouse on the retail market.

BEST MOUSE FOR GRAPHICS & CAD

High (200 dot per inch) resolution, precise tracking, and a 3-button design are essential for graphics and CAD.

BEST MOUSE FOR DESKTOP PUBLISHING

Ergonomic styling is a must for all mouse-intensive desktop publishing applications. High resolution is essential for high-resolution screens.

BEST MOUSE FOR SPREADSHEETS & WORD PROCESSING

The smooth-tracking LOGITECH mouse is a productivity tool for all types of data entry and editing. We've even created a special mouse interface for 1-2-3 which makes 1-2-3 users up to 30% more productive!

BEST MOUSE SOFTWARE

"Logitech's Plus Package adds an excellent menu builder (with useful examples), a fast windowing text editor, and an outstanding Lotus 1-2-3 interface."
Ezra Shapiro
Byte, Dec. '86, pg. 324

Our Plus Software also includes our Microsoft-compatible drivers, and CLICK which sets the mouse automatically for any application.

Inquiry 183.



BEST DEALS

We offer either our C7 or Bus mouse, with Plus software, packaged with some of the most exciting applications on the market, at very exciting prices.

LOGIPAINT Special Offer! \$149

The LOGITECH Mouse with PC Paintbrush is the most advanced paint set available for the PC. It offers 11 type fonts, a pallet of 16 colors, and the ability to import and embellish files from other applications.

LOGICADD \$189

The LOGITECH Mouse packaged with Generic CADD and Dot Plot turns your PC into a complete CADD workstation. Generic CADD offers the features and performance of high priced CADD at an unbelievably low price. DotPlot is the add on utility that enables you to produce crisp, high resolution drawings from your dot matrix printer.

LOGIPAINT-&-DRAW \$219

The LOGITECH Mouse packaged with LOGIPAINT and LOGICADD. Together they are the complete graphics toolkit for combining freehand and technical drawings.

NEW

LOGITECH BUS MOUSE \$149 with LogiPaint

100% Microsoft Bus Mouse Compatible!
It has all the features of the LOGITECH C7 MOUSE, plus it leaves the serial port on your computer free for other peripherals. It comes standard with our top-of-the-line Plus Software and LogiPaint.



Lotus and 1-2-3 are trademarks of Lotus Development Corp. Generic CADD is a trademark of Generic Software, Inc. PC Paintbrush is a registered trademark of ZSoft Corp.

YES! I want the opto-mechanical LOGITECH Mouse!

- LOGITECH C7 Mouse w/Drivers \$99
- LOGITECH C7 Mouse w/Plus Software \$119
- LOGITECH BUS Mouse w/Plus Software and LogiPaint \$149
- Additional Software (with C7 and Plus or Bus Mouse and Plus.)
- LOGIPAINT \$149
- LOGICADD \$189
- LOGIPAINT-&-DRAW \$219

Add \$6.50 for shipping and handling. Calif. residents add applicable sales tax. Prices valid in U.S. only.

Total Enclosed \$ _____

30-Day Money-Back Guarantee/3-Year Warranty

To place a credit card order call our special toll-free number:

800-231-7717

Call toll-free in California:

800-552-8885

VISA MasterCard Check Enclosed

Card Number _____ Expiration Date _____

Signature _____

Name _____

Address _____

City _____ State _____

Zip _____ Phone _____

DEALER INQUIRIES WELCOME



LOGITECH, Inc.
805 Veterans Blvd. Redwood City, CA 94063
Tel: 415-365-9852

In Europe:
LOGITECH SA, Switzerland
Tel: 41-21-879656 • Telex 458 217 Tech Ch

In Italy:
Tel: 41-21-879656

Using the Macintosh II and SE to Create Presentations

PowerPoint from Forethought lets you create and manage presentations with the use of overhead transparencies, flipcharts, speaker's notes, and handouts. Some of the features include word-processing capabilities, diagram drawing tools for illustrations, and on-screen slide sorters. It also includes a disk of predesigned formats and slide layouts. PowerPoint gives you the ability to import graphics and text from Macintosh programs, and you can use slides created with PowerPoint in desktop-publishing documents.

The program is compatible with the Macintosh II and SE and runs on other Macs that have at least 512K bytes of RAM and one 800K-byte or two 400K-byte disk drives. **Price:** \$395.

Contact: Forethought Inc., 250 Sobrante Way, Sunnyvale, CA 94086, (408) 737-7070. **Inquiry 617.**

VCN Concorde 2.0

Visual Communications Network's version 2.0 of their graphics program, Concorde, lets you create slide shows on-screen incorporating graphics, pictures, text, music, animation, and special effects. New to version 2.0 is the ability to create and edit your own fonts.

You can also use Concorde to create charts and diagrams, interface with Lotus 1-2-3 or other spreadsheets, and run word-processing and graphics packages through Concorde's screen-capture function. The menu-driven program can exit to DOS at any time, execute another program, and then return to Concorde.

Input devices you can use



Create and edit fonts with version 2.0 of Concorde.

include the keyboard, mouse, digitizer, and scanners. Concorde 2.0 supports output devices in bit-mapped and vector-based formats. The bit-map mode enables you to print or plot images of varying complexity. The vector mode offers faster speeds, and you can obtain higher resolutions using pen devices, according to VCN.

Output devices supported include film recorders, ink-jet printers, color plotters, and 24-pin color printers.

The U.S. version of Concorde 2.0 is not copy-protected. It runs on IBM PC, XT, AT, and compatibles with at least 384K bytes of RAM in medium resolution and 640K bytes in high resolution. It supports CGA and EGA, along with Hercules monochrome graphics. **Price:** \$695.

Contact: Visual Communi-

cations Network Inc., 238 Main St., Cambridge, MA 02142, (617) 497-4000. **Inquiry 618**

Graphs and Charts with Microrim's R:BASE

Using Microrim's R:BASE System V, 5000, or 4000 database-management systems with R:BASE Graphics, you can create graphics and charts. You can also graph using data from other programs by implementing the FileGateway import/export utility in R:BASE database managers.

R:BASE Graphics reads R:BASE databases directly, letting you reduce the data into a graphable subset.

You can run the program as a stand-alone or in local area network environments on IBM PCs, XTs, and ATs. For

single-user operation, you'll need at least 512K bytes of RAM and MS-DOS or PC-DOS 2.0 or higher. For LANs you'll need at least 640K bytes, MS-DOS or PC-DOS 3.1 or higher, and a dedicated file server.

The program supports IBM CGA and EGA, the Hercules Graphics Card Plus, the monochrome graphics card, and others compatible with Graphics Software System device drivers. You can output to a variety of plotters and printers.

Other features of the program include a split-screen display that lets you display graphics in up to 32 separate windows on-screen or in your output. It has seven text fonts, and you can use up to 4 of the 14 colors at a time in EGA- or CGA-display mode. **Price:** \$295.

Contact: Microrim, P.O. Box 97022, Redmond, WA 98073-9722, (206) 885-2000. **Inquiry 619.**

StatView II

StatView II is a Macintosh II and SE version of the statistics program StatView 512+ from BrainPower. Enhancements to the program include a color capability and the ability to support multiple screen sizes. You can also customize your graphs by scaling them to any size and choosing text color, font, style, and point size for text placement within the graphs. According to the company, the program takes advantage of the Mac II's 68881 coprocessor in its calculations and provides the ability to address up to 2 gigabytes of RAM. **Price:** \$450.

Contact: BrainPower Inc., 24009 Ventura Blvd., Suite 250, Calabasas, CA 91302, (818) 884-6911. **Inquiry 620.**

WHERE DO NEW PRODUCT ITEMS COME FROM?

The new products listed in this section of BYTE are chosen from the thousands of press releases, letters, and telephone calls we receive each month from manufacturers, distributors, designers, and readers. The basic criteria for selection for publication are: (a) does a product match our readers' interests? and (b) is it new or is it simply a reintroduction of an old item? Because of the volume of submissions we must sort through every month, the items we publish are based on vendors' statements and are not individually verified. If you want your product to be considered for publication (at no charge), send full information about it, including its price and an address and telephone number where a reader can get further information, to New Products Editor, BYTE, One Phoenix Mill Lane, Peterborough, NH 03458.

TEKTRONIX NEW ADVANCED PC GRAPHICS STANDS ALONE.

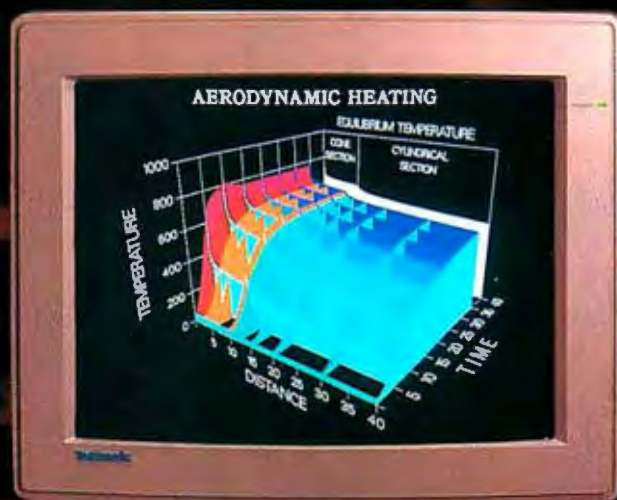

BECAUSE IT WORKS TOGETHER.

Introducing Tek Advanced PC Graphics: a fully integrated system of high-performance graphics, easy system connectivity, and unparalleled application



software for your PC. Tek Advanced PC Graphics starts with a flexible multiple-rate color graphics monitor that provides 640x480 Tektronix-style graphics as well as EGA and

CGA software compatibility.

Driving your monitor to a whole new level of graphics speed is Tek's PC4100 graphics coprocessor board. It features Texas Instruments' powerful TMS 34010 32-bit



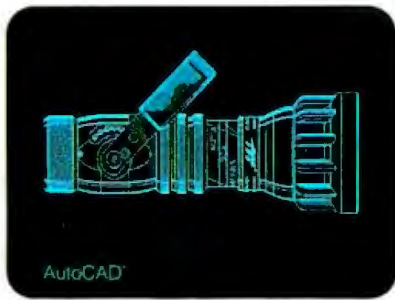

Graphics System Processor for ultra-fast throughput of your design applications. Add to that Tek's PC-05 or PC-07 terminal emulation software, and you're ready for stand-alone computing or access to a world of mainframe graphics.

To bring those applications to life, you can connect a Tek color ink-jet printer. And start producing high-resolution, vibrant hardcopy output on either paper or transparencies.

Couple all that with Tektronix worldwide support and service, and your PC can gain the

same productive advantages that host-based systems in scientific and engineering environments have had for close to two decades.

Tek's PC4100 graphics coprocessor board delivers serious graphics on a stand-alone basis. Built around the Texas Instruments Graphics System

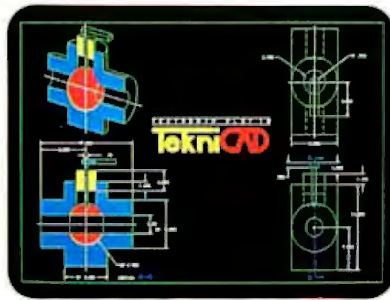

Processor(GSP),™ the graphics coprocessor board achieves a combination of sophisticated graphics and fast throughput your PC just couldn't deliver before. The GSP assumes the complete graphics processing workload, freeing your PC processor for other requirements.



refresh rate. So you can use advanced packages like AutoCAD™, Zenographic's Mirage™ and VersaCAD™.

Then, to move from GSP graphics to emulation of the IBM® Enhanced Graphics Adapter(EGA) mode, you simply soft-switch. And you're

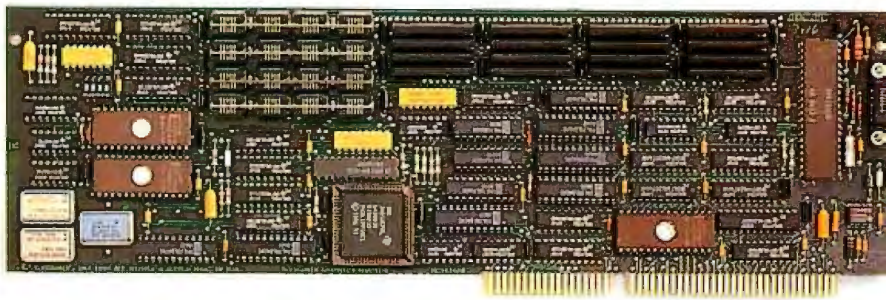

New companion monitor brings together fine detail and maximum flexibility. You'll view your applications on Tek's new multiple-rate monitor. In true Tek tradition, it provides ideally balanced, 640x480 addressability and a 60 Hz non-interlaced

ready to run the popular PC packages you probably already use in CGA/EGA mode—standards like Lotus® 1-2-3®, Microsoft® WORD® and Microsoft® Windows®, to name just a few.

Last, but not least, Tek's PC4100 links you to a world of mainframe graphics. All you do is load Tek PC-05/PC-07.

Tek PC-05/PC-07 terminal emulation software gives you mainframe accessibility with the local processing power of your PC. Because Tek PC-05 and PC-07 terminal emulation software runs under MS-DOS® 2.0 and higher, you can run your mainframe-based

AND SETS YOU APART.

applications software on your PC as if it were a Tek 4105 or 4107 terminal.

Which means you can quickly access the power of Tek graphics—including 4107 segments, true zoom and pan, rubberbanding, definition of up to 64 viewports and more.

You can use these highly productive features with a wide range of well-known designer software packages such as ISSCO's DISSPLA[®] and TELL-A-GRAF,[®] MCS's ANVIL-5000,[™] SAS Institute Inc.'s SAS/GRAPH, Precision Visuals' DI-3000,[®] Swanson Analysis Systems' ANSYS[®] and McNeal-Schwendler's NASTRAN.

In addition, you can utilize software development tool sets like Tektronix PLOT 10[®] GKS, IGL, TCS and STI software as well as numerous driver support packages created for the 4105 and 4107.

Completing the picture: perfect color output with Tek's reliable ink-jet printers.

At the push of a button, the Tek 4696 lets you produce exacting color reproductions of



your on-screen display on either paper or transparencies.

Because of its 120 dots per inch addressability in both horizontal and vertical directions, you can achieve resolution of up to 1280 points x 960 points per "A" size image.

All the key tools for software development, right from the outset. The new Tektronix Graphics Interface[™] (TGI) for the PC provides the basics of Tek graphics functionality to application programs

running under MS-DOS. What's more, in-circuit emulator, C-compiler, assembler and linker are all available from Texas Instruments to help software developers write applications packages for the PC4100 graphics coprocessor board.

To enable sufficient workspace for custom interfaces or specific application programs, the PC4100 graphics coprocessor board comes standard with a full megabyte of program memory.

Put yourself on the sure path of Tek graphics evolution.

Whether you choose Tek PC stand-alone graphics, Tek's high-resolution monitor, Tek terminal emulation or all three, you can be assured Tek will keep you current with the best and most productive graphics. Because like all our products, Tek Advanced PC Graphics features a smooth built-in pathway to higher-level graphics.

For more information about how Tek lets you stand alone and work together, contact your local Tek representative about Tek Advanced PC Graphics. Or call, 1-800-225-5434. In Oregon, 1-235-7202.

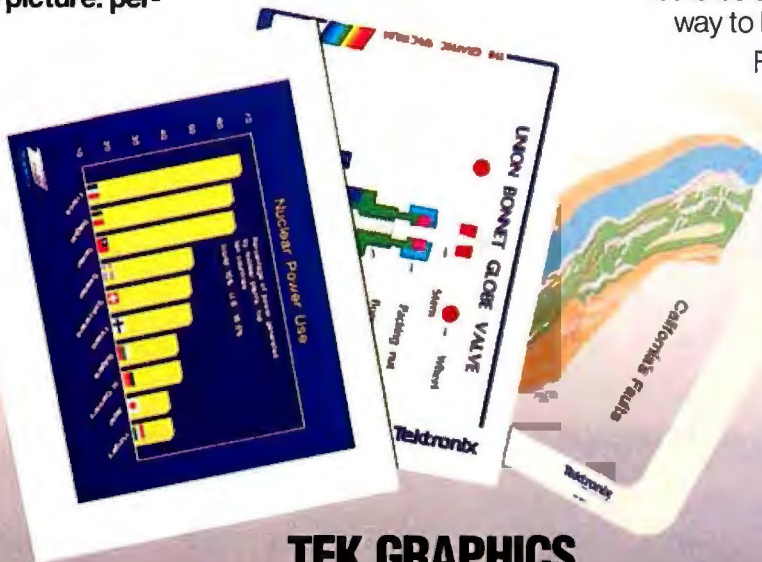

TEK GRAPHICS PROCESSING SYSTEMS

Tektronix[®]
COMMITTED TO EXCELLENCE

EVENTS AND CLUBS

May 1987

EVENTS

Lighting & Optics for Machine Vision, Boston, MA. Joanne Rogers, Program Administrator, Special Programs Division of the Society of Manufacturing Engineers, One SME Dr., P.O. Box 930, Dearborn, MI 48121, (313) 271-1500, extension 399. *May 5-6*

National Online Meeting, New York, NY. Thomas H. Hogan, National Online Meeting Organizer, Learned Information Inc., 143 Old Marlton Pike, Medford, NJ 08055, (609) 654-6266. *May 5-7*

Hands-on Expert Systems Design & Development, Ottawa, Ontario, Canada. Marilyn Martin, Integrated Computer Systems, 5800 Hannum Ave., P.O. Box 3614, Culver City, CA 90231-3614, (800) 421-8166; in Canada, (800) 267-7014. *May 5-8*

Intelligent Infrastructure Technology, New York, NY. Jerry Robinson, Editor, *F-M Automation Newsletter*, 9501 West Devon Ave., Suite 203, Rosemont, IL 60019-4804, (312) 823-0555. *May 6*

Midwest Electronics Expo, St. Paul, MN. MG Expositions Group, 1050 Commonwealth Ave., Boston, MA 02215, (800) 223-7126; in Massachusetts, (617) 232-3976. *May 6-7*

The Great Lakes LOGO Conference, Cleveland, OH. Alice Fredman, ECCO, 1123 S.O.M. Center Rd., Cleveland, OH 44124, (216) 461-0800. *May 7-8*

Third International Conference on Artificial Intelligence and Education, Pittsburgh, PA. Jane Parlett, Room 811 LRDC, University of Pittsburgh, Pittsburgh, PA 15260, (412) 624-7478. *May 8-10*

APL87, the International APL Conference, Dallas, TX. APL87 Registrar, 440 Northlake Shopping Center, Suite 210, Dallas, TX 75238, (214) 539-9281. *May 10-14*

Simulation Techniques for Personal Computers, Washington, DC. Continuing Engineering Education Program, The George Washington University, Washington, DC 20052, (800) 932-2337. *May 11-15*

Hardware and Software Evaluations in Expert Systems Building, Atlanta, GA. Deidre Mercer, Department of Continuing Education, Georgia Institute of Technology, Atlanta, GA 30332-0385, (404) 894-2547. *May 12*

Hands-on Programming in C, Los Angeles, CA. Marilyn Martin, Integrated Computer Systems, 5800 Hannum Ave., P.O. Box 3614, Culver City, CA 90231-3614, (800) 421-8166; in Canada, (800) 267-7014. *May 12-15*

Atari Trek '87, Seattle, WA. Atari Trek '87, 2442 North West Market St., P.O. Box 97, Seattle, WA 98107, (206) 232-3009. *May 16-17*

1987 International Industrial Engineering Conference and Pro-Tech 87, Washington, DC. IIE Registrar, 25 Technology Park/Atlanta, Norcross, GA 30092, (404) 449-0460. *May 17-20*

Introduction to Artificial Intelligence and Expert Systems, El Segundo, CA. UCLA Extension, 10995 Le Conte Ave., Los Angeles, CA 90024. *May 18-22*

LISP and LISP Environments: Hands-on AI Workshop, Washington, DC. Marilyn Martin, Integrated Computer Systems (see address above). *May 19-22*

IBM PC Microcomputer Interfacing, Scientific Instrument Automation, and Control, Blacksburg, VA. Adult Registrar, Donald Brown Center for Continuing Education, Virginia Tech, Blacksburg, VA 24061-0102, (703) 961-5182. *May 28-30*

Second Symposium on Computer Conferencing: Allied Technologies & New Applications, Guelph, Ontario, Canada. University of Guelph, School of Continuing Education, Guelph, Ontario, Canada N1G 2W1, (519) 824-4120. *May 31-June 3*

If you send notice of your organization's public activities at least four months in advance, we will publish them as space permits. Please send them to BYTE (Events and Clubs), One Phoenix Mill Lane, Peterborough, NH 03458.

CLUBS

MED Journal, the journal of the Medical Electronic Desktop; c/o JAM Software Pty, Ltd., 27A Nowranie St., Summer Hill, Australia NSW 2130.

The Communications Connection News, The Information Exchange, 3825-I South George Mason Dr., Falls Church, VA 22041.

PolyLetter, the newsletter for PolyMorphic systems owners and users; 191 White Oaks Rd., Williamstown, MA 01267, (413) 458-8421.

INTEREX, International Association of Hewlett-Packard Computer Users; Robert Grenoble, 680 Almanor Ave., Sunnyvale, CA 94086-3513, (408) 738-4848.

Prolog Users Group (PUG), Jack Ellis, 2252 Main St., Suite 15, San Diego, CA 92011, (619) 423-0538.

Amiga Atlanta, Andre Frech, 2001 Old Concord Rd. M-9, Smyrna, GA 30080, (404) 435-4386; BBS: (404) 953-6228.

Mensa MacNews, Mensa MacSIG, P.O. Box 11626, St. Paul, MN 55111-0626.

A SNOBOL's Chance, c/o Catspaw Inc., P.O. Box 1123, Salida, CO 81201, (303) 539-3884; BBS: (303) 539-4830.

Computers in Education, Macaulay Rd., RD2, P.O. Box 119, Katonah, NY 10536.

Macintosh Users Group, c/o Kinell, Pilgatan 15, 90245 Umeaa, Sweden.

Rattlesnake Atari Computer Enthusiasts (RACE), Skip Leininger, 2110 Strand, Missoula, MT 59801.

National Capital Macintosh Club (NCMC), Paul Lardner, P.O. Box 5685, Station "F," Ottawa, Ontario, Canada K2C 3M1, (613) 236-6262.

Computer Users of Texas, c/o Patrick Grimaldo, 516 52nd St., Lubbock, TX 79404, (806) 762-3131.

ARK: Amiga Users Group, c/o Howard Couch, 512 Stonewall Dr., Suite 120E, Jacksonville, AR 72076. ■



ABC Company Newsletter

August

Technical Report on Desktop Publishing

Desktop Publishing Terms

At the heart of the personal computer publishing movement is a set of skills almost unknown to anyone outside the typesetting trade. A unique lexicon of terms describes the methods used to arrange letters on a page in an eye-pleasing manner. The typographer's language contains terms dating back to Gutenberg's time.

Crispness and clarity are the measures of good typography. These two elements are a function of image resolution, point size and typeface. The eye is very sensitive to the spacing of letters and the placement of words on the page.

Measurements

Pica and point are two important words. They are the fundamental units of typographic measurement. A pica equals .66666, or about one-sixth, inch. The pica is in turn divided into 12 points. Using these

typesetting terms will ease your communication with the professional graphic arts industry.

A standard measure for open space is the em, named for the width of the M, which is usually the widest letter in a typeface's character set. The size of an em is always equal to the current point size. When you're setting a line in 12 point type, an em is 12 points wide.

Desktop Publishing Systems Sold Worldwide

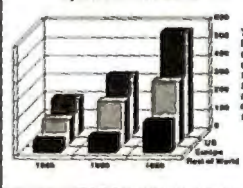

Related to the em is the en, which is equal to half the width of an em or the width of the letter N. This thin space, a user-definable unit, usually half an em. Typographers adjust the space between letters to improve readability. The process, called kerning, is determined by the shapes of the adjacent letters. In electronic publishing, typographic attributes are imposed by embedding codes within unformatted text. A hyphenation and justification program then interprets the codes and makes the line-ending decisions.

Because the letter blocks were originally made out of lead alloy, the vertical space between lines of type



Figure 1.1 The art of typography is now combined with the power of the PC.

IN THIS ISSUE

Editorials 15	Graphics97
Columns 32	Dealer Info98
Strategies 78	News183
Cover Story .. 83	Reviews125
Printers 92	Industries129
Computers ... 95	Careers146

Now, desktop publishing software of such genius, you don't have to be a 'Leonardo' to use it.

Until now, if you were in the IBM PC world and wanted to join the desktop publishing revolution, the software was hard to use, expensive, and often rewarded you with documents that were technically correct, yet visually disappointing.

Enter Xerox genius for creating perfect documents and a new generation of desktop publishing software—Xerox Ventura Publisher. It combines the best of current page-oriented systems with the best of document-oriented systems to make desktop publishing easy as well as productive.

The special genius of Xerox Ventura Publisher is "stylesheets"—20 built-in formats that arrange text and graphics automatically. Choose a stylesheet (or create your own), combine your text and graphics, and Xerox Ventura Publisher goes to work at the amazing rate of 20,000 characters per second, formatting as many as 64 100-page chapters. Most other programs format a page at a time, just like the cut-and-paste process you're escaping.

It's easy. You manipulate text and graphics with a mouse. What you see is what you get when you print. (Buy a new Xerox full-page display, and you won't have to scroll to see your entire page layout.) Make a change on page 1 and before you can say "Leonardo da Vinci," the entire document reformats. Tables of contents, indexing and numbering of pages, sections, tables, captions and figures are automatic.

Unlike most other programs, Xerox Ventura Publisher runs on a standard IBM PC XT/AT or compatible—AT power is not required. Text can be created on, and converted from, most major word processing programs. Graphics can be imported from many graphics and paint programs—even scanned images are easily incorporated. It supports dot matrix, color ink jet and laser printers as well as PostScript printers and typesetters.

What price genius? The money you'll save by producing your very first 16-page booklet instead of sending it out will probably cover the cost of your very own Xerox Ventura Publisher software.

Xerox brings out the genius in you.

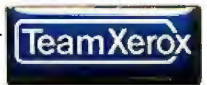

Xerox Corporation, P.O. Box 24, Rochester, NY 14692. 143B

Begin your career as a desktop publishing "Leonardo" by stopping in at any computer store featuring Xerox desktop publishing software, by calling your local Team Xerox sales office or 1-800-TEAM-XRX, ext. 143B.

NAME _____

COMPANY _____ TITLE _____

ADDRESS _____ CITY _____

STATE _____ ZIP _____ PHONE _____ 192-3-87

XEROX® is a trademark of XEROX CORPORATION.
VENTURA PUBLISHER® is a trademark of VENTURA SOFTWARE, INC.
IBM® and PC XT/AT are trademarks of INTERNATIONAL BUSINESS MACHINES CORPORATION.
POSTSCRIPT® is a trademark of ADOBE SYSTEMS.

ASK BYTE

Conducted by Steve Ciarcia

Home Study

Dear Steve:

Most of the articles in BYTE are beyond my technical ability. I have tried other magazines, but their articles are considerably beneath my competence.

Could you please indicate a recommended reading list or, better yet, a good home study program in electronics and computers?

Alfred W. Thompson
Shrewsbury, MA

I have always had respect for the Heathkit series of home study courses, in both electronics in general and computers. You might even have one of their stores near you, so a check in the phone book might be rewarding. If not, they would be happy to send you a catalog. They advertise heavily in hobbyist electronics magazines like Radio-Electronics, with postage-paid reply cards for convenience.

Because there are so many books on so many aspects of computers and electronics, I find it hard to recommend any specific text, especially since I am not completely sure of your level of understanding. What I can recommend heartily is The Reader's Guide to Microcomputer Books, by Michael Nicita and Ronald Petrusna, published by Golden-Lee, 1000 Dean St., Brooklyn, NY. This 400+-page book is a review of hundreds of books—covering mostly software books, but some hardware books as well. A half- to full-page review plus a numerical rating within categories make it easy to find books that will meet your needs.

Hands-on experience is always helpful. Many community colleges offer beginning computer and/or electronics courses in the evenings. Books are great, but human beings usually answer questions a lot better.—Steve

Mystery Machine

Dear Steve:

I am in great need of information on two subjects.

First, could you direct me to any information on Vector Graphics computers? I have been picking up bits and pieces at the swap meets with the goal of putting together a working computer.

Second, I have a mystery computer that

I hope you can help identify. Following is a list of its features:

- It is manufactured by Bi-M Instrument, Houston, Texas.
- The unit is approximately 12 by 24 by 6 inches, enclosed in an aluminum chassis with provisions for a vertical wall mounting. It is labeled Model 1600 A.
- The unit is composed of two circuit boards. The top board is labeled "CPU computer"; the bottom board is labeled "Video Computer Z-80B."
- There is no enclosed power supply. The required 5, 12, and 24 volts come in through an amphenol connector. The 24 V is for a muffin fan.
- Along the right side of the computer are ports labeled: channels 1-5 RS 232 DB 25 ports, serial keyboard DB 9 port, channel 1-2 HDLC DB 15 ports, parallel I/O DB 25 port, light pen DB 9 port, coax connector for RGB video, and peripheral expansion 60-pin ribbon connector.

The two PC boards are connected by a ribbon cable. I do not know what HDLC stands for. The upper CPU computer board is marked as assy. 8-14-0024C. Overall, the unit is high-quality; my guess is that it's from a commercial arcade video game.

Wade Bjerke
San Juan Capistrano, CA

Vector Graphics was one of the larger S-100 manufacturers in the late 1970s, but the company is no longer in business. You can get much of the information you need from one of the many S-100 hardware books and a CP/M book. The best approach, however, is to find someone using a Vector Graphics system in your area.

Your Bi-M computer is not from a video game. HDLC is the acronym for IBM's High Level Data Link Control protocol, a protocol for mainframe-to-intelligent peripheral communications using a byte-synchronous signaling technique. The light pen and RGB connectors indicate that it is to be connected to an RGB monitor, probably of fairly high resolution. I would try to power this unit up, and see what signals are present at the video connectors. If you don't have an RGB monitor, sync is likely to be present on the

green output, and this is likely to be an RS-170 analog video signal rather than the more common TTL of today.

I'm sorry that I don't have any more information. By powering up the system and also dumping the contents of the ROMs on the CPU board, you could learn a lot about this unit.—Steve

Desperately Seeking Chip Set

Dear Steve:

Some years ago, I saw some Intel information on a processor chip set they called the iAPX432. The processor was a high-level object-oriented chip. I have been unable to locate any information on this chip set. Where can I write to find out more about the iAPX432? Are you aware of any computers assembled using this processor? My interest was sparked by the processor's resemblance to IBM's System/38 processor.

Mike Calabro
Schenectady, NY

The iAPX432 chip set is still alive. The original version of this chip set was not a good performer, but the revised version stands up remarkably well against a 12-MHz 68000. The language it was designed for is ADA. The remarkable thing about the architecture of object-oriented computers is that you can hook several of them together to boost performance without any reprogramming.

continued

IN ASK BYTE, Steve Ciarcia answers questions on any area of microcomputing. The most representative questions received each month will be answered and published. Do you have a nagging problem? Send your inquiry to

Ask BYTE
c/o Steve Ciarcia
P.O. Box 582
Glastonbury, CT 06033

Due to the high volume of inquiries, we cannot guarantee a personal reply, but Steve and the Ask BYTE staff answer as many as time permits. All letters and photographs become the property of Steve Ciarcia and cannot be returned.

The Ask BYTE staff includes manager Harv Weiner and researchers Eric Albert, Bill Curlew, Ken Davidson, Jeannette Dojan, Jon Elson, Roger James, Frank Kuechmann, Dave Lundberg, Tim McDonough, Edward Nisley, Dick Sawyer, Andy Siska, Robert Stek, and Mark Voorhees.

News about the Microsoft Language Family

Writing Faster Macro Assembler Programs

Fast execution speed is probably the biggest advantage a program can have—and the Microsoft® Macro Assembler is the language of choice for writing the fastest programs. Our software engineers would like to give you a hint that can make your fast Macro Assembler programs even faster!

If you need to take the absolute value of a number held in the AX register, try this method:

```
cwd      ; replicate the high bit into DX
xor ax, dx ; 1's complement if negative, no change if positive
sub ax, dx ; AX is 2's complement if it was negative
```

The standard absolute value method works on any register but is much slower:

```
or bx, bx ; see if number is negative
jge notneg ; if it is negative
neg bx ; make it positive
notneg: ; jump to here if positive
```

This fast method achieves part of its speed by avoiding the use of a jump instruction to keep the 8086's pre-fetch queue full. The 8086 always tries to fetch the next instruction from memory while it is processing the current instruction in order to save time while a program is running. A jump instruction, however, moves the location of the next instruction to fetch, making the instruction that the 8086 just fetched into its pre-fetch queue invalid. This forces the 8086 to spend time fetching the correct instruction from memory after the jump. Whenever possible, avoiding jumps will increase the execution speed of your Microsoft Macro Assembler programs.

New Microsoft COBOL Version Includes Symbolic Debugger, Cross-reference Generator, and Other Utilities

Microsoft COBOL Compiler Version 2.2 now includes COBOL Tools which was formerly sold as a separate package at a suggested retail price of \$350. This powerful set of productivity aids minimizes coding time and reduces the cost of program development and maintenance. Both the MS-DOS® and XENIX® 286 versions of the compiler packages have been updated. Microsoft COBOL now includes ViewCob, the most intuitive, interactive symbolic debugger for COBOL on the market; CobRef, an advanced cross-reference generator; Menu Handler, an innovative utility to enhance your Microsoft COBOL applications with a menu-oriented user interface; and CbMouse (only in the MS-DOS version), an object module to interface the Microsoft Mouse to your applications.

ViewCob has an easy-to-learn, menu-driven interface similar to that of Microsoft Multiplan®. It supports multiple windows for viewing source code, program execution history, breakpoints, and memory locations while your program is executing. Powerful execution control, breakpoints, and tracing provide the programmer with a tool for analyzing all aspects of a Microsoft COBOL program. Modify any data-item at any breakpoint to test different conditions in your program without cumbersome data input or recompilation. Trap runtime errors. In some cases (e.g., non-numeric data), you can correct the situation and continue execution. On-line help messages are available for descriptions of command functions and general operational procedures.

CobRef allows the COBOL programmer to cross-reference source code listings to data-items, files and procedure calls in a program. In addition to name and type, listings include details on where an item is defined and referenced.

Menu Handler provides a program skeleton for creating applications with a menu-oriented user interface that is similar to the interface for the popular Microsoft Multiplan. Entries in the command area are mapped to the procedure calls in your Microsoft COBOL application.

CbMouse object module is linked to the program runtime. It translates the COMP-O data-items defined by the programmer into the format that the mouse system calls are expecting. It converts the pixel values needed by the Microsoft Mouse to row/column values used by COBOL without the application needing to go through the conversions.

For more information on the products and features discussed in the Newsletter,
write to: Microsoft Languages Newsletter
16011 NE 36th Way, Box 97017, Redmond, WA 98073-9717.
Or phone:
(800) 426-9400. In Washington State and Alaska,
call (206) 882-8088. In Canada, call (416) 673-7638.

Latest DOS Versions:

Microsoft C Compiler	4.00
Microsoft COBOL	2.20
Microsoft FORTRAN	4.00
Microsoft Macro Assembler	4.00
Microsoft Pascal	3.32
Microsoft QuickBASIC	2.01

MicroCom Systems
OUTSTANDING SOFTWARE
For IBM PC's and Compatibles

\$350 PER DISK SMALL QUANTITIES
\$300 PER DISK FOR TEN OR MORE

\$1 OFF 5 DISKS OR MORE WITH THIS COUPON

- BUSINESS 1**—EZ-Forms business form generation, completion and printing program.
- CAD 1**—Altamira, a 4 color object oriented drawing program. Color required.
- COMM 4a,b,c,d,e**—(5 disks) Latest RBBS Bulletin Board System 14.1D.
- DATABASE 1a,b**—(2 disks) File Express menu driven general purpose database mgr.
- EDUCATION 1**—Interactive DOS tutorial for new PC users. Makes learning DOS painless.
- GAMES 1**—3-D PacMan, Kong, SpaceWar, JanitJoe, and more. Color required.
- GAMES 2**—Oubert, Pango, Centipede, Monopoly, Zoarre, and more. Color required.
- GAMES 3**—Blackjack (you set rules), Arm Chair QB, and Empire (War Game).
- GAMES 4**—Castle, StarTrek, and the original Colossal Caves Adventure.
- GAMES 5**—The Hack adventure game from the universities. Like Rogue, only more complex.
- GAMES 6**—Pinball, Othello, Dragons, Sopwith (fly one), and more. Color required.
- INFO 1a,b**—(2 disks) Cooking recipes database with keyword/ingredient retrieval.
- LANGUAGE 5**—Turbo Pascal interactive debugger, pop-up help, formatters, et cetera.
- LANGUAGE 7**—Complete Pascal interpreter/compiler. Great for learning Pascal!
- ORGANIZER 1**—DeskMate, a Sidekick clone, and the Judy calendar program.
- PINUP 2**—Provocative high res digitized graphics pinups. Graphics required.
- PRINTER 1**—Font and sideways utilities, spoolers, banner makers, and more.
- UTILITIES 1**—A collection of invaluable general purpose DOS utilities. A must!
- UTILITIES 2**—More invaluable DOS utilities. Too many to list here!
- UTILITIES 3**—A comprehensive set of debugging and diagnostic utilities.

NEW RELEASES/UPDATES

- CAD 2a,b**—(2 disks) An advanced 2D/3D drafting prog. 640k and color required.
- COMM 1a,b**—(2 disks) Version 2.4 of the ever-popular Qmodem comm. program.
- COMM 2a,b**—(2 disks) Procomm 2.42, an excellent modem program with terminal emulation.
- EDUCATION 2**—Learn the Presidents, States (and capitals) and more. Color required.
- EDUCATION 5**—Learn Origami, the Japanese art of paper folding. Color required.
- FINANCES 3a,b**—(2 disks) Express Calc 3.12, a powerful spreadsheet program.
- GAMES 8**—Striker helicopter attack, and Risk, world domination. Color required.
- GAMES 9**—EGARisk, the game of world domination in very high resolution. EGA required.
- GAMES 10**—Solitaire, Teed-Off golfing, and Sailing in the Bermuda triangle. Color required.
- GAMES 12**—MyChess (9 levels), Backgammon, and Wheel of Fortune. Color not required.
- GRAPHICS-1**—Record and play back screen images! Excellent for demo, etc. Color required.
- INFO 2a,b**—(2 disks) Zip-Phone, national areacode/ prefix to zip-code cross reference.
- LANGUAGE 3a,b**—(2 disks) The A86 2.18 macro assembler and debugger.
- SHELL 4**—Automenu menu facility, and HDM II 4.04 hard disk menus.
- UTILITIES 5**—Utilities for formatting, parking, and optimizing hard disk drives.
- UTILITIES 6**—Advanced utilities including Dpath, Esc, Hotdos, Resident program utilities.
- UTILITIES 7**—More Advanced utilities including MasterKey (undeletes files from hard disks).
- WORD 1a,b**—(2 disks) PC Write 2.7, a powerful word processing system, w/spell checker.

Catalog available, add \$2. 3.5" format add \$1/disk.

Cost of Items _____
CA Res 7% Tax _____
Ship/Handling _____ Domestic \$1./Foreign \$5.
Total Enclosed _____

MicroCom Systems
(415) 325-6500

P.O. Box 51657, Palo Alto, CA 94303

The chips in the set are called the 43201 (CPU), 43202 (MMU), and the 43203 bus interface.

I do not know of any commercial computer system using the iAPX432, and I am not aware of any operating systems for it, either.

You can call Intel at (914) 297-6161 in Wappingers Falls, New York, for additional information.—Steve

Expanding a Clone

Dear Steve:

I recently purchased a cabinet, eight-slot backplane, and power supply to make an expansion box for my IBM clone. When I hooked the clone's bus directly to the backplane with a ribbon cable, however, my computer would not even display the monitor prompt.

Do you have any suggestions on how to hook the new backplane and power supply to the clone's bus?

Ed Cabler
Port Ludlow, WA

The IBM Hardware Technical Reference Manual shows one way to connect an expansion unit. The description is in Chapter 1 under "Expansion Unit." They use a driver card in the main unit expansion bus, a receiver card in the expansion box, and a shielded cable that carries all bus signals except OSC (the clock). The expansion box has its own power supply and clock oscillator, and a wait state is inserted to allow for lack of synchronism between the main and expansion unit clocks.

Logic diagrams, which are almost complete schematics, are also included in the Technical Reference Manual's Appendix D.

This is not the only way to interface the units. If you use a very short cable, are very careful about noise, and use proper termination, you might be able to carry all the signals.

A card with a set of buffers on each end may also work, but your experience shows why IBM suggests a driver/receiver card combination.—Steve

Atari and IBM Interface

Dear Steve:

As a user, I am tempted by all sorts of hardware currently on the market. One of the things that I've been considering is a new toy, something like an Atari ST or an Amiga, capable of nice graphics and at a reasonable price. On the other hand, IBM and its clones, with their marvelous outpouring of software packages, are threatening to seduce me away from my thousands of dollars worth of CP/M equipment.

I imagine I can take the plunge, buy

two more machines, and retire my favorite S-100 equipment to a closet to make room. But the biggest problem with two or more machines is where to put the keyboards and monitors.

Would it be possible to build an interface board to stick into an IBM to translate input from the foreign keyboard of an Atari ST (or Amiga) to run IBM programs, and then translate output to use the Atari's monochrome and/or color display?

If such a board allowed the Atari to use the IBM's RAM memory and floppy and hard disk storage, interchange Atari and IBM data at will, and run most IBM software when operated as a terminal program, I would scurry out and buy one today. It would solve the problems of desk space, expanded memory for the Atari (or Amiga) graphics, lack of top-notch graphics for the IBM, and laser-printer graphics output. And besides, with a terminal program I could keep at least one S-100 on the same desktop, like an old friend to commune with about the folly of the younger generation.

C. M. Kotlan
O'Brien, OR

It is fairly easy to use a computer as a terminal to run an IBM PC. PC-DOS has features to allow this, and there is one software system that I know of that allows remote running of one IBM from another. As far as I know, however, this software does not have a version that will link IBMs with non-MS-DOS computers.

The simplest method would be to use an IBM, Amiga, or Atari as a "dumb" terminal to run your S-100 system. I'm guessing that you do little or no graphics on the system, so a straight-ASCII serial (RS-232C) interface is adequate.

The basic communication between computers is fairly easy as long as all data is ASCII, and the PC can be set up to accept commands from and redirect text output to the serial port.

Generally, however, the type of interface you are seeking is either very difficult or impossible to construct. It might be possible to write software to run on an IBM PC so that output would be sent to an Amiga or an Atari ST to be displayed in graphics form, but there is no practical way to make commercial software for the IBM PC send graphics output to either computer.

Direct use of a remote computer's memory as expansion memory is also generally not possible. Programs are written to access memory directly in a random fashion, with data being taken sequentially only in short segments. Using a remote computer as storage for

continued

HOT GRAPHICS PACKAGE FOR C PROGRAMS.* \$39.95

Everything you need to write dramatic graphics effects into your Eco-C88 C programs. Some of the features include:

- Support for EGA, CGA, and Z100
- Over 100 graphics and support functions, many of which are PLOT-10 compatible.
- Many low level support routines reside outside your small model code-data area
- Can write dots thru the BIOS (for compatibility) or to memory (for speed)
- Graphics function help from CED editor available
- World, pixel or turtle color graphics modes
- 47 standard fill patterns, 17 line dashing patterns, Hershey fonts, plus user defineable fill, dash and fonts
- Supports view areas, rotateable fonts, clipping, arbitrary fill areas, extensive error checking, examples, and user's manual.

A must for the graphics enthusiast and a bargain at only

\$39.95

*Requires Eco-C88 C Compiler.

NEW POP-UP WINDOWS FOR YOUR C PROGRAMS.

This windowing library allows you to add pop up windows in your C programs quickly and easily. Use them for help windows, selection menus, error messages, special effects—anywhere you need an attention getter. Just some of the features include:

- CGA, EGA, and monochrome support
- Slow mode option for "flicker" displays
- Control any program that goes through the BIOS

- Use up to 255 windows
- No special window commands; use print f ()
- Resize and move windows
- Custom window titles and borders
- Can be used with ANSI device driver
- Most of window's code-data lies outside small model limits
- Use any of the IBM text or block characters
- User's manual and examples

The Windowing Library requires an IBM PC compatible BIOS and the Eco-C88 C compiler.

ONLY \$29.95

HANDY LIBRARIAN MAKES LIFE EASIER.

Now you can combine your modules, functions, and subroutines into your own library for easy link commands. Fully compatible with ANY standard OBJ format files (not just Ecosoft's products). With the Ecosoft librarian, you can:

- Add, delete, and extract from a library
 - Get table of contents or index of a library
 - Combine libraries, control library page size, use switches for combinations, process complex library requests, use wildcards, and do library directives from command files.
 - Complete with user's manual
- A valuable addition for any programmer.

ONLY \$29.95

Orders only:
1-800-952-0472
Technical Information:
(317) 255-6476

**NOT COPY
PROTECTED.**

THE FIRST PROFESSIONAL C COMPILER FOR UNDER \$60.

A C compiler with many ANSI enhancements at an unbelievably low price. The Eco-C88 C compiler has:

- Prototyping (the new type-checking enhancement)
 - Enum and void data types
 - Structure passing and assignment
 - All operators and data types
 - A standard library with more than 200 functions (many of which are System V compatible for greater code portability)
 - CC and mini-make that all but automates the compile process
 - 8087 support (we sense the 8087 at runtime — no dual libraries)
 - ASM or OBJ output for use with MSDOS linker
 - Tiered error messages — enable-disable lint-like error checking
 - Fast compiles and executing code
 - Expanded user's manual
 - CED full-screen program editor
- Everything you need at the unbelievable price of \$59.95.

Eco-C88 C compiler requires an IBM PC, XT, or AT (or compatible) with 256K of memory, 2 disk drives and MSDOS 2.1 or later.

Inquiry 101

Ecosoft Inc.
6413 N. College Ave.
Indianapolis, IN 46220



ITEM	PRICE	QTY	TOTAL
Flexi-Graph Graphics	\$39.95		
Window Library	\$29.95		
Eco-Lib Librarian	\$29.95		
Eco-C88 C Compiler CED	\$59.95		
SHIPPING			
TOTAL (IND. RES. ADD 5% TAX)			

PAYMENT: VISA MC AE CHECK

CARD # _____ EXPIR DATE _____

NAME _____

ADDRESS _____

CITY _____ STATE _____

ZIP _____ PHONE _____

ECOSOFT

WHY PAY MORE?



YOUR MONEYSWORTH GUARANTEE

- ★ Credit cards not charged until after your order has been shipped
- ★ Orders shipped same day on all stocked products (on orders placed by 2pm EST)
- ★ All products guaranteed to be the latest versions available
- ★ Only factory sealed and fully warranted products stocked
- ★ Never a surcharge for American Express, Visa or Mastercard

• No sales tax on orders shipped outside NY State • Please add 3% for insurance, shipping and handling (\$3.00 minimum) (Some products may have a surcharge due to weight and size restrictions) • Defective merchandise can be returned for repair or exchange (please call for R.A. no.) • Due to variety of products, we cannot guarantee compatibility

GRAPHICS/CAD-CAM

Autocad 2.52	\$2,129
Drafix	185
Freelance Plus	315
Harvard Presentation	209
Microsoft Chart	169
Prodesign II	169

LANGUAGES

Microsoft C	\$255
Microsoft Cobol	399
Microsoft Fortran	259
Microsoft	
Macro Assembler	89
Microsoft Quick Basic	69
Turbo Pascal	55

PROJECT MANAGEMENT

Harvard Total II	CALL
Super Project Plus	\$275
Time Line	209

FINANCIAL/ACCOUNTING

BPI	\$159
Computer Associates	321
Dollars 'N' Sense	94
Great Plains	386
Managing Your Money	105

UTILITIES

Carbon Copy	\$113
Crosstalk XVI	87
Fast Back	85
Fixed Disk Organizer	45
Microsoft Windows	57
Norton Commander	29
Norton Utilities	45
PC DOS 3.2	69
Sidekick	45
Sideways	35
Smart Com II	79
Superkey	37

SPREADSHEET / INTEGRATED

Framework 2	\$389
HAL	97
Lotus	305
Lotus Report Writer	97
Microsoft Multiplan	110
Smart Integrated	419
Supercalc IV	269
Symphony	439

DATABASE MGMT

Clipper	\$329
dBase III Plus	389
dBase III Plus Lan Pak	553
Foxbase +	229
Genifer	195
PFS: Professional File	129
Q & A	221
R:Base System V	329
Reflex	81

WORD PROCESSING

Display Write IV	\$305
Microsoft Word 3	255
Multimate	222
Multimate Advantage	285
PFS Professional Write	105
Word Perfect	195
Wordstar 2000 Plus	264
Wordstar Pro Pak	219
XY Write III	199

LAPTOPS

NEC Multispeed	\$1,549
Toshiba T1100 Plus	1,729
Zenith Z181	1,749

Now available: luxurious leather carrying case for laptops only \$149

SURGE PROTECTORS

KENSINGTON MICROWAVE Masterpiece Plus	\$109
--	-------

BACK UP POWER SUPPLIES

DATASHIELD	
200 WT (PC)	\$235
300 WT (XT)	335
500 WT (AT)	525
800 WT (AT)	545

MODEMS

HAYES	
Smartmodem 1200	\$375
Smartmodem 1200B	345
Smartmodem 2400	555
Smartmodem 2400B	497

GRAPHICS

HERCULES	
Graphic Card Plus	\$175
Color Card	141

PARADISE	
Auto Switch EGA	339
Modular Graphics 3	169
QUADRAM	
EGA Plus	299
SIGMA	
Color 400H	439
TSENG	
Eva 480	375
VIDEO 7	
VEGA	315
VEGA Deluxe	375

MULTI-FUNCTION BOARDS

AST	
Six Pack + 384K	\$195
Six Pack Premium	259
Advantage 128K	325
Rampage AT W/512K	419
Rampage W/256	257
MONEYSWORTH (AST Comp.)	
Money Memory 1/2 Card (384K)	119
Money Memory 1/2 Card (576K)	145
Money-Board AT Multifunction (128K)	199
Money-Board Multifunction (384K)	155
Money I/O Mini-Half Card	105

MONITORS

AMDEK	
12" 310A	\$135
12" 300A	119
Color 600	369
Color 722	461
NEC	
Multi-Sync	575
PRINCETON	
Amber Max-12	159
RGB HX-12	409
RGB HX-12E	525

PRINTERS

CANON	
Laser LBP8A1	\$1,829
EPSON	
FX286	529

FX85	365
LQ1000	709
HEWLETT-PACKARD	
Laser Jet Plus	2,889
NEC	
P-6	439
P-7	629
OKIDATA	
182 Plug & Play	245
192 Plus	345
193 Plus	515
2410	1,741
TOSHIBA	
351 P/S	969
321 P/S	459

KEYBOARDS

KEYTRONIC	
5151 Deluxe Keyboard	\$159

MOUSE INPUT DEVICES

MICROSOFT	
Mouse (Serial)	\$119
Mouse (Buss.)	109

MOUSE SYSTEMS

PC Mouse	99
----------	----

HARD DISKS

PLUS	
Hard Card 20 Mb	\$675

BACK UP STORAGE DEVICES

EVEREX	
Excel 60 Mb Int	\$719
Excel 60 Mb Ext	845
IOMEGA	
Bernoulli (10 + 10)	1,815
Bernoulli (20 + 20)	2,349
Bernoulli 10 MG Cartridge Tri-Pak	135
Bernoulli 20 MG Cartridge Tri-Pak	185
SYSGEN	
Image Tape Backup 20 Mb Ext	699
Image Tape Backup 20 Mb Int	539

All prices and policies subject to change without notice.

"The True Measure of Value"

MONEYSWORTH

COMPUTER PRODUCTS, INC., 500 Bi-County Boulevard, Farmingdale, New York 11735

FOR ORDERS ONLY **1-800-237-9161** Customer Service & NY State (516) 249-8489

ONE DOLLAR

0505

Boost cursor speed. Stop cursor run-on.

With all the recent hoopla over performance, it's ironic that two of the PC's ergonomic deficiencies have been overlooked — its slow cursor, and the tendency of the cursor to remain in motion (run-on) after a cursor key has been released. Finally, the solution — Cruise Control™ from Revolution Software.

Cruise Control is a new productivity tool for serious PC users. It boosts cursor speed, typically by 3-5X. It eliminates annoying cursor run-on. And it adds hands-free cursor navigation to any application.

If you use 1-2-3, Symphony, dBASE, Reflex, or Paradox, you need Cruise Control's Anti-Skid Braking. Here's what the leader of one Lotus users group said about Cruise Control:

"Once I used it, I wanted it! Excellent idea. Very practical. One of the best programs ever sent to us for review!"

If you use Word Perfect, MS-Word, Q&A, DisplayWrite, MultiMate, WordStar 2000, Framework, PC-Write, or SideKick, you need Cruise Control's Screen Runner, the high-performance, adjustable-speed cursor.

Cruise Control's namesake feature takes the drudgery out of paging through data base records, long documents, and large spreadsheets. It lets you repeat any key, hands-free — at the speed of your choice.

And there's more. A Chronometer "types" the time or date into your application at the current cursor position. The keyboard-controlled Screen Dimmer protects your privacy. The programmable Auto-Dimmer extends the life of your display screen.

Compatible with thousands of today's popular programs, including Lightning, SuperKey, and Ready!. Uses only 3K RAM. For DOS 2.0 or later. Not copy-protected. No risk, 60-day money-back guarantee.

Cruise Control™ Only \$39.95

Call now to order by credit card (VISA/MC/AX):

201-366-4445

Or, mail \$39.95 plus \$3.50 shipping and handling to:

Revolution Software, Inc.

715 Route 10 East • Randolph, NJ 07869

Dept. 200

large programs would be like having most of the program on disk, and paging sections in and out as needed would be slow.—Steve

CIRCUIT CELLAR FEEDBACK

Expanding a Kaypro

Dear Steve:

Since coming across your Circuit Cellar articles on the SB180, I am very intrigued by the possibilities offered by the HD64180 chip. I have a Kaypro 1, which I use primarily for word processing with WordStar. I am very pleased with the Kaypro, but I would like to enhance it, particularly by speeding it up and adding a RAM disk. The HD64180 seems like just the answer, and your design of the SB180 in combination with the Z-System seems to be what I am looking for.

Southern Pacific offers an HD64180 board for the Kaypros, but it uses CP/M Plus rather than the Z-System, and your account of the capabilities of the Z-System have sold me on it. I wonder if the Z-System can be used with a board other than the SB180?

My only regret about the SB180 is that it doesn't use the full 512K RAM that the chip is capable of addressing, but I can see that it would take a larger board to accommodate the added memory chips.

Wendell J. Fay
San Diego, CA

I am not familiar with the Southern Pacific HD64180 board for the Kaypro, but I do know that Echelon, Inc., the company that wrote ZCPR3 and the rest of the Z-System software, does have versions available for many computers other than the SB180. Their address and phone number are:

Echelon Inc.
885 N. San Antonio Rd.
Los Altos, CA 94022
(415) 948-3820

A newer, more powerful version of the SB180 is now available. Called the SB180FX, it supports a larger RAM disk (up to 4 megabytes with a new memory expansion card) and has a SCSI hard disk interface on the main circuit board.
—Steve

Graphics and MIDI

Dear Steve:

Do you know of a graphics chip I can use to produce a 256- by 256-pixel black-and-white display? Each horizontal line would require 32 bytes, so that 256 rows would amount to 8K bytes of RAM.

Also, I am interested in MIDI; what register and crystal values would let the Z8671 microcontroller's serial I/O port run at MIDI's 31.25K bps? Any input you can offer would be appreciated.

Matthew Taylor
Austin, TX

My GT180 graphics board, which appears in the November 1986 issue of BYTE, describes the application of the Hitachi HD63484 Advanced CRT Controller chip. This system would give you a high-quality, high-resolution color display. Other graphics chips that are suitable include the Motorola 6845 and 6847.

There is no single-chip graphics system, although the NEC 7220 will put a full graphics system together with a minimum of parts. A shift register, the RAMs, a RAM timing generator, and a video sync mixer are all that it requires.

For the Z8671, use an 8-MHz crystal. Set the prescaler for the T0 timer to 1, then set the counter to divide by 4, and the UART section divides by 16 to give 31.25K bps. The chip divides the clock frequency by 4.

I think you might have some trouble running a synthesizer with this chip in interpreted BASIC, however. If you are just going to use it to upload and download waveforms and control one voice it should work, but it would probably be too slow to handle several voices and a keyboard.
—Steve

Striking Out Alone

Dear Steve:

I have recently been considering starting a custom programming business. As a result, I would like to obtain some information that could help educate me on all of the trials and tribulations that would be in store for me, as well as give me hints on streamlining such an operation.

Roy Anderson
Long Beach, CA

The first principle of consulting (that's what you're getting into, even though you may think of it as custom programming) is that free advice is worth every penny you pay for it.

I have to make a few assumptions:

- You are starting out as a one-man operation.
- You are pretty competent at writing code.
- You have a moderate amount of get-up-and-go.

Getting started is easy: You need a telephone answering machine, a supply of

continued

Why Does The Genius® Display Work So Well?



The Genius® Full-page Display:
66 lines in very high resolution - 100 dots/inch

Because
All These Work
So Well With
The Genius.®

THE GENIUS Display System enables you to work with more programs in a full page format than any other monitor.

Desktop publishing, word processing and spread sheets are just a few of the applications that work better with THE GENIUS.

THE GENIUS Display System is a 15" high resolution monitor and adapter card.

With over 4,000 in use, THE GENIUS is available today to add a new dimension to office productivity.

Micro Display Systems, Inc.

1310 Vermillion St., P.O. Box 455, Hastings, MN 55033
Telex: 4310015 Fax: (612) 437-7325 Phone: (612) 437-2233
Toll Free: 800-328-9524

The Genius® Full-Page Display

HARMONY COMPUTERS

2357 CONEY ISLAND AVE., (BET. AVES. T & U) BKLYN, NY 11223

800-VIDEO84 or 800-441-1144 or 718-627-1000



Commodore 1571-\$211.95
STAR NX-10-\$199.95

PANASONIC 1080-\$184.95
IBM PC XT-\$969.00

"PRINTER SPECIALS"

Brother HF1 20	324	Epson FX 286E	519	Okidata 292 w INTFC	499	Star NO 10	319
Brother 1509	345	Epson EX800	419	Okidata 293 w INTFC	646	Star NO 15	399
Cannex 420 IBM	699	Epson EX 1000	579	Olympia 109	149	Star NB 2410	449
Citizen 1200	169	Epson LQ2500	1049	Panasonic KXP 1080 i	185	Star NB 2415	664
Citizen MSP 10	269	IBM Proprinter	379	Panasonic KXP 1091 i	239	SR 15, SR 10 Sheetfeed	49
Citizen MSP 15	369	IBM Proprinter XL	519	Panasonic KXP 1092 i	312	Star Power Type	179
Citizen MSP 20	319	NEC 3550	719	Panasonic KXP 3131	238	Star NB 15	799
Citizen MSP 25	459	NEC 8850	1039	Panasonic KXP 3151	369	Silver Reed Exp 420	199
Citizen Premier 35	439	NEC P6	427	Panasonic KXP 1592	384	Silver Reed Exp 800	629
Epson LX86	199	NEC P7	599	Panasonic KXP 1595	469	Toshiba 341	589
LX 86 Cutsheet	24	Okidata 182	228	Siekosha SP 1000	189	Toshiba 351 Model 2	889
Epson LQ800	459	Okidata 192 Plus	319	Star NX-10	200	Toshiba 351C	999
Epson LO 1000	649	Okidata 193 Plus	489	Star NP 10	159	Toshiba 321	429
Epson FX 86E	357			Star NX15	319		

IBM	SEAGATE	ATARI	MONITORS
AT Unenhanced	Hard Drives	130 XE	Amdek 300 Amber
AT Enhanced IBM 30 Meg	20 Meg No Controller	65 XE	310 Amber
IBM PC XT (1) Dr	10 Meg w controller	Atari 801 Printer	410 Amber
IBM PC XT 286w EMHZ 640K	20 Meg w controller	Atari 804 Printer	Color 600
12 MB, 20 MB Hard Drive	30 Meg w controller	1050 Drive	Color 722
Fountain PCXT Turbo	30 Meg AT #4038	Atari Writer +	Princeton HX12
256K 1 Drive	40 Meg AT #4051	Atari 1027	Princeton HX12E
BM Monitor	Tandon 20 Meg	Atari Modem 301	Princeton Max 12E
IBM Disc Drive	Hard Card	520 ST Color System	SR12
AST Six Pack 384K		520 ST B & W System	Scan Doubler
AST Advantage 128K	AT&T 8300		NEC Multisync
AST Six Pack Premium 256 K	640K 1-360K Drive	MODEMS	Taxan TTL Amber
Hercules Color Card	640K 1-360K 1-20MB	Hayes 1200	COMPAQ
Hercules Monographic Plus	Seagate Hard Drive	Hayes 1200B No Smartcom	Portable 256K 2-360K
SIGMA EGA (NANDW)	ATT Monitor	Hayes 1200B w Smartcom 2	Compaq Drives
NEC EGA 081	ATT Dos 3.1	Hayes 300	Portable 256K 1-360K
Quad EGA+	TOSHIBA PORTABLES	Hayes 2400	1-20MB Hard Seagate
Quad Prosync	Toshiba 3100+	Hayes 2400B w Smartcom	COMODORE
Video 7 EGA+	Toshiba 1100+	Hayes 2400B No Smartcom	Commodore 128
Video 7 Deluxe		Micromodem 2E	1571 Drive
STB EGA+	SOFTWARE	Promethias 1200 External	1670 Modem
Paradise Auto Switch	Lotus 123 Ver. 2	Promethias 1200 Internal	Commodore 64C
Multifunction Card	D Base 3 +	Everex Modem Internal 1200B	1541C Disk Drive X
Everex EGA Enhancer	Framework	Everex 2400 Internal	1802
Everex Edge	Symphony 1.2	Hayes Smartcom 2	1902 Monitor
Everex Graphics Pacer	Microsoft Word 3.1	APPLE	MSP 1000 Printer
Intel 8087-2	Microsoft Windows	2E Enhanced w 128K	Star SG10C
Intel 8087-2	Word Perfect 4.2	Apple Drive w controller	Siekosha 180 VC
Intel 80287-6	Q & A	Drive IIE, IIC	Siekosha 180 VC
Intel 80287-8	PFS Professional Write	Mac 512K	Amiga 256K Dos. Mouse
	Norton Utilities	Mac Plus	Amiga 1080 Color Monitor
	Microsoft Mouse	Imagewriter 2	Amiga 256K Upgrade
	Hayes Smartcom II		

Items reflect 4% cash check discount. For your protection we check for stolen credit cards. M.C. Visa welcome. Shipping & Handling charge extra. All Sales Final. Price and availability subject to change without notice. We cannot guarantee compatibility.

CIARCIA FEEDBACK

business cards, and some letterhead. That's about it.

The hard part is that you're going to have to get out and sell yourself, and sell yourself, and sell yourself. You've probably got one or two leads that will result in immediate business, but you must hustle to ensure a steady supply of work.

Make sure that you've got enough money saved up to last for six months without any income at all. You should have some income, but you'll be surprised (everyone is) at how long it takes to land jobs. It's better to have too much money saved up than slightly too little. If you're thinking of getting new credit cards or lines of credit, do it while you've got a "steady job" because banks have little enthusiasm for loaning money to a new business.

As for streamlining your operation, I think the best advice is not to make things too complicated in the first place. You can probably keep your finances in a simple single-entry register and business checkbook; you won't need a fancy accounting system right away. Because the whole tax situation has changed, all of the old wisdom about incorporating is wrong, so beware of free advice about your business structure (even from me!). —Steve

Multiprocessing PC

Dear Steve,

I am trying to decide whether to use an IBM PC XT in a multiprocessing mode using a program like Microsoft Windows, or an IBM PC AT using a multiuser operating system such as XENIX. What is your suggestion?

Harvey Horn
Flushing, NY

The main problem with XENIX is that it's pretty much a turkey on an XT and only mediocre on an AT. Also, it really doesn't function as a real-time operating system. Finally, everything you think you know about PC software will change; you'll have to get software that runs under XENIX rather than PC-DOS . . . and such software isn't cheap, either.

Microsoft Windows gives the illusion of concurrent operation, but in reality it's not quite as nice as they would have you believe. For example, applications with an active window are time-sliced, but applications represented by an icon are not (with the exception of the clock application, which is a special case). The Windows Development Kit (\$500) gives you the programming tools to write code to run with Windows, but from what I've heard, the I/O interrupt handling isn't pretty.

Set up your software on an XT and buy
continued

Printer Sharing

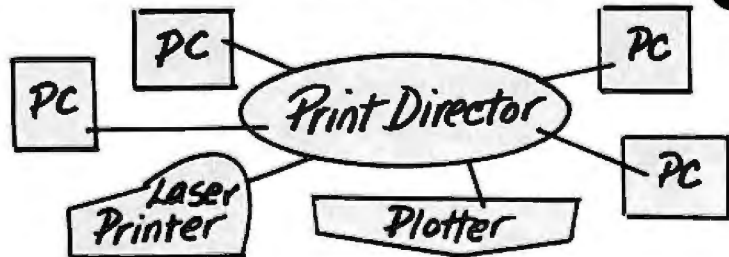

Share the benefits and costs of laser and other high performance printers using PrintDirector. PrintDirector offers:

- an ideal solution for workclusters with two to twenty PCs that want to share printers
- direct multiple user access to a variety of printers, parallel or serial, mixed BAUD rates and escape codes
- printing without waiting—concurrent I/O and automatic print buffering (60KB to one Megabyte) and selection for increased user productivity

Digital Products Inc., 108 Water Street, Watertown, MA 02172
617-924-1680 Outside Massachusetts, Call 1-800-243-9333

PrintDirector

WHAT'S THE SECRET DEBUGGING WEAPON USED BY EVERYBODY FROM BORLAND TO ORACLE? FREE 44-PAGE ANSWER FROM ATRON.

"WE COULDN'T HAVE DONE IT WITHOUT ATRON'S HARDWARE-ASSISTED SOFTWARE BUGBUSTERS."

Philippe Kahn
Atron Pres.

Larry Ellison
Oracle Pres.

This is the city saved by the Atron bugbusters. Your city. Full of wizards, with hundreds of millions of dollars invested in wringing every ounce of intelligence and performance out of your PC. It used to be plagued with the toughest software bugs known to mankind.

PLAGUES OF BIBLICAL PROPORTIONS

The first and most difficult plague was impossible to trap with software debuggers. These were carnivorous bugs which randomly overwrote programs, data, even the debugger. Nastiest were the ones that slipped in once every few hours, or changed their behavior after each new compile. Forty days and forty nights of recompiling, *trying something else*, caused many a would-be resident of the city to run screaming into the wilderness, never to be heard from again.

Second came the plague of not knowing where the program was, or where it had recently been. This compounded the first plague: How could anyone know *what* caused the random memory overwrites? Add to this random interrupts and timing dependencies, and you begin to understand *The Fear* that gripped the city.

Then came the last plague, which brought the wizards to their knees before they even started debugging. Their towering programs consumed so much memory, there wasn't enough room for their symbol table, let alone debugging software. Even if they could get past the first two plagues, this one killed their firstborn software.

ENTER THE HARDWARE-ASSISTED SOFTWARE BUGBUSTERS

The Atron solution came as a revelation: Monitor every memory reference and every instruction executed, by adding a hardware board to the AT or PC with an umbilical probe to the processor.

The result? Wham! The PC PROBE™ and the AT PROBE™ saved civilization as we know it. The first plague was cured with PROBE'S hardware-assisted breakpoint traps on reading, writing, executing, inputting and outputting. These could be done on single or ranges of addresses, and could include particular data values. All in real time. For a mere software debugger to attempt this, a 1-minute program would take 5 hours to execute.

The second plague, not knowing from whence you came, was cured with PROBE'S real-time trace memory. The history of program execution is saved on-board, in real time. Once a hardware trap has occurred,

Atron

THE BUGBUSTERS

20665 Fourth Street • Saratoga, CA 95070 • 408/741-5900

PROBE displays the program execution in detail, including symbols and source code for C, Pascal, or assembly language programs. Which shows how out-of-range pointers got that way.

The third plague, not enough room for the debugging symbol table to be co-resident in memory with a large program, was cured with 1-megabyte of on-board, hidden, write-protected memory. System memory was then free for the program, keeping the symbol table and debugger safe from destruction.

When the job of bugbusting was done, the wizards used their PROBES as performance analyzers. So they could have both reliability *and* performance. So they could send only the best software into the field.

IF YOU AREN'T AN ATRON CUSTOMER, ODDS ARE YOU WON'T BE MAKING THE TOP-TEN LIST.

On any given week, at least nine of the top ten best-selling software packages on the Soft-Sel Hotlist come from Atron customers.

Ever heard of Borland? "Without Atron," says its president Philippe Kahn, "there wouldn't be a Side-Kick™, Turbo Lightning™ would be light-years away, and Turbo Prolog™ wouldn't be shipping today."

Ever use a spreadsheet? From Enable™ to Paradox™, their bugs were busted by Atron products.

Into DBMS's? Everyone from Ashton-Tate to Oracle owns at least one Atron bugbuster.

If you use a product from one of the companies in *The City*, you owe life as you know it to Atron. Our guess is that 99% of all PCs, XT's and AT's have at least one product debugged with Atron bugbusters.

FREE 44-PAGE BUGBUSTING BIBLE COULD MAKE YOU A PROPHET, AND YOUR COMPANY A PROFIT.

We've written a complete tutorial on state-of-the-art bugbusting. And it's yours, free for the asking. Full of examples and illustrations, it will show you how the wizards work their magic.

If you're tired of suffering the wrath of program bugs, call Atron today. You could be busting bugs, and sales records, tomorrow.



THE BUGBUSTERS

20665 Fourth Street • Saratoga, CA 95070 • 408/741-5900

OUR PLUG-IN CARDS GIVE YOU PLUG-IN CONTROL.

Your IBM PC/XT/AT or compatible can control any IEEE-488 instrument.

You can:

- Plug-in to BASIC, C, FORTRAN, or Pascal.
- Use HP-IB plotters, printers, and instruments.
- Spend less time programming.
- Call (617) 273-1818 and put us to the test.

Complete hardware and software solutions for just \$395.



Capital Equipment Corp.
99 South Bedford Street
Burlington, MA. 01803



another one with the money you'll save by not getting involved with debugging a multitasking system.—Steve

Lis'ner 1000 for the PC

Dear Steve:

As an undergraduate honors student at Iowa State University I will be developing both the software and hardware for a speech recognition and speech synthesis system for the IBM PC. As the start of the project approaches, I need to solve two pressing problems: first, gaining access to an IBM PC to which I'll be allowed to interface my project, and second, choosing speech recognition and speech synthesis ICs for the project.

This letter is mainly concerned with solving the second problem. I am referring to your Lis'ner 1000 project in the November 1984 Circuit Cellar. Specifically, I need information on the status of the Lis'ner 1000 version for the IBM PC. Would it be possible to obtain just the schematics for this project? I would truly appreciate any information and documentation concerning other available speech recognition and speech synthesis ICs.

Gabriel M. Cuka
Ames, IA

I would think that at a university the size and quality of Iowa State, there would be many personal computers on campus. You should be able to get access to one of those computers to finish your project. Two approaches that might get results are a classified ad in the campus newspaper and notices placed on bulletin boards in strategic locations. Your academic department also may be able to assist you.

There is no schematic available for an IBM SP-1000 interface comparable to the Lis'ner 1000 circuit published in the November 1984 Circuit Cellar. There is an IBM interface using the SP-1000 chip made by AutoPilot. The AutoPilot 1000 is a simple board that features a powerful software interface system. Further information can be obtained from:

AutoPilot Inc.
P.O. Box 3006
516 Walt Whitman Rd.
Huntington Station, NY 11746
(516) 351-4862

There are several manufacturers of voice synthesis and recognition ICs, including Texas Instruments and National Semiconductor. Details on these and other chips can be found in their data books and their supplemental literature. Your best source for this type of information is probably the engineering library at your university.—Steve ■

NIC-PAL II PLD Logic Programmer

Driven from your PC/XT/AT or compatible, the Nicolet PLD logic programmer handles virtually all types of PLD's. Software driven from your parallel port, just select the type of device, and download your JEDEC file. Offers 128 test vectors and full screen editing. Includes all necessary software. \$1,295.00



To Order:
Send check, money order, or Visa/Mastercharge to NICE,
5225 Verona Rd.
P.O. Box 4288
Madison, WI 53711-0288

For technical information & order processing: 800-NICOLET (642-6538) or 415-490-8870 in California. Order processing only: 608-273-5008.



Inquire about our emulator products. NICE is a trademark of Nicolet.

THE NO FRILLS PLOTTER

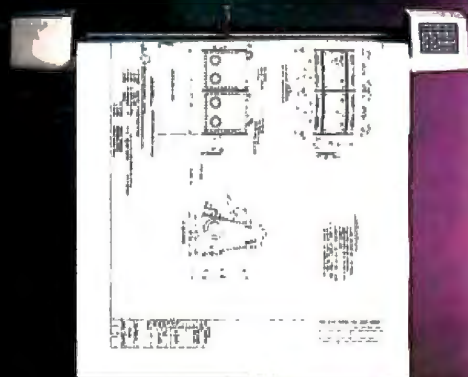

Enter the world of professional CAD applications with Houston Instrument's low cost DMP-41/42 series plotters. These single-pen plotters give you the features you need—C and D size plots, extensive software compatibility, and proven reliability—for a very affordable no frills price of \$3295.*

The DMP-41/42 series' large C and D size formats are ideal for a wide range of CAD applications, from architectural elevations to assembly drawings. And a .005 inch resolution ensures crisp drawings on a variety of media—paper, matte film, or vellum.

Inquiry 147

With the DMP-41/42 series, you can choose from an impressive selection of off-the-shelf graphics software packages such as VersaCAD, AutoCAD, and CADKEY. Or, by using Houston Instrument's popular DM/PL™ language, you can create your own custom software and be assured of upward compatibility with Houston Instrument's entire line of plotters.

The DMP-41/42 series. The plotters that offer superb reliability, comprehensive graphics capabilities, and a no frills price. The proven performers for low-cost CAD.

For more information, call

1-800-531-5205 (512-835-0900 if in Texas), or write Houston Instrument,™ 8500 Cameron Road, Austin, Texas 78753. In Europe, contact Houston Instrument, Belgium NV., Rochesterlaan 6, 8240 Gistel, Belgium. Tel.: 32-(0)59-277445. Tlx.: 846-81399.

houston
instrument **AMETEK**
DIVISION

*U.S. suggested retail price. Pricing subject to change.
DM/PL and Houston Instrument are trademarks
of AMETEK, Inc.

HOW TO B

MARKET SHARE BY COLOR

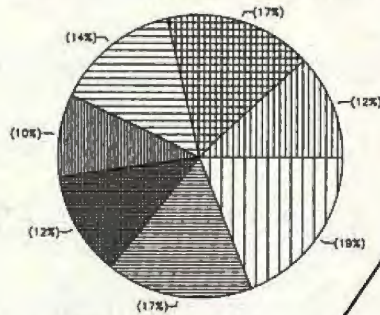

As the chart above shows, black was the year's biggest selling color, commanding a 19% share of the market. Red and yellow also performed brilliantly, with a 17% share each. The biggest surprise of all was green, at 14%, its share was double that of the previous year. As expected, blue and violet faded somewhat, while orange continued to lose appeal.

9-pin printhead prints black and white only.

Top speed 200 cps for drafts, 40 cps for letter quality text.

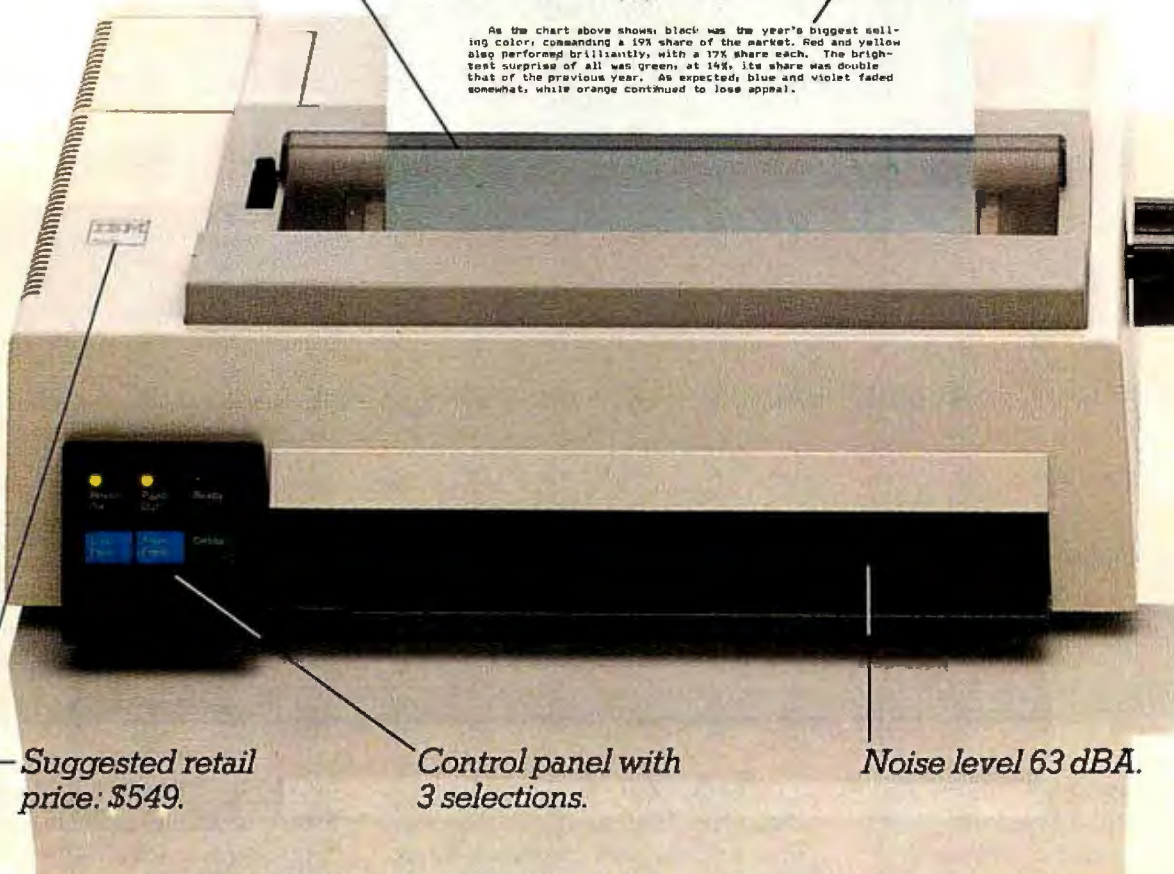

Suggested retail price: \$549.

Control panel with 3 selections.

Noise level 63 dBA.

A "Pro" doesn't stand a chance next to the new ALPS ALQ200™ -

Because the ALQ200 has more of what it takes to get more done.

Take speed, for instance. With its 18- or 24-pin printhead, the ALQ200 prints excellent letter quality text twice as fast.

And the same is true for high

resolution graphics. Where, as you can see, we also have a distinct color advantage.

The ALQ200 even has what it takes to make people faster. Like automatic paper loading. A full-function, push-button control panel. And compatibility with all the leading PCs and software.

EAT A PRO.

Snap-in/out, interchangeable 18- and 24-pin printheads print 7 colors, including black.

MARKET SHARE BY COLOR

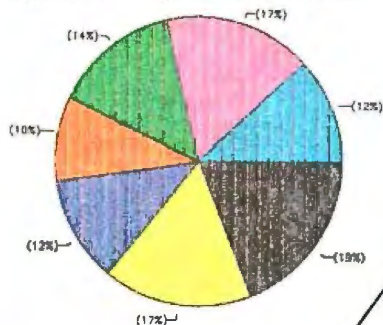

Top speed 240 cps for drafts, 100 cps for letter quality text.

As the chart above shows, black was the year's biggest selling color, commanding a 19% share of the market. Red and yellow also performed brilliantly, with a 17% share each. The brightest surprise of all was green, at 14%, its share was double that of the previous year. As expected, blue and violet fared somewhat, while orange continued to lose appeal.

ALPS ALQ200

Suggested retail price: \$595 for 18-pin, \$695 for 24-pin.

Push-button panel controls all printing functions without DIP switches or software commands.

Noise level 55 dBA.

You'll also find the ALQ200 especially compatible with busy offices. After all, it's about as solidly built as a printer can be. So it's quieter. And nearly impossible to overwork.

But what really beats all is that the ALQ200 costs about the same as the so-called "Pro."

For a free demonstration or more

information, call us at (800) 828-ALPS. In California, (800) 257-7872.

And see a real pro at work.

ALPS
AMERICA

IT'S TIME YOU SAW THE ALPS.

The Diconix 150. Take it or leave it.

The world's most portable printer performs as well on your desktop as it does when you're on the road. The small footprint reduces desktop clutter, while it enlarges a small budget.

PC
MAGAZINE
The Best
of 1986

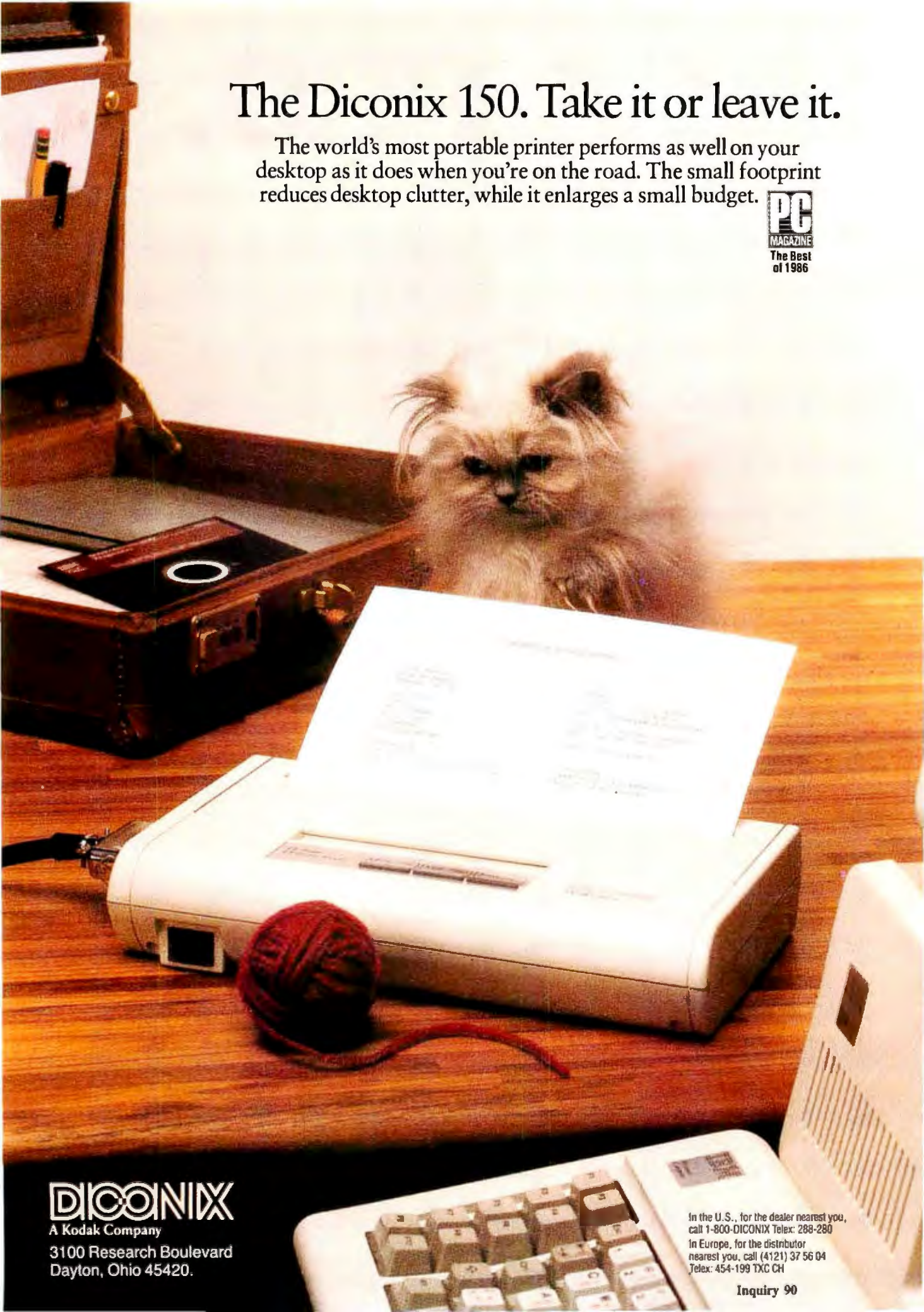

DICONIX

A Kodak Company

3100 Research Boulevard
Dayton, Ohio 45420.

In the U.S., for the dealer nearest you,
call 1-800-DICONIX Telex: 288-280
In Europe, for the distributor
nearest you, call (4121) 37 56 04
Telex: 454-199 TXC CH

Inquiry 90

BOOK REVIEWS

THE BEAUTY OF FRACTALS: Images of Complex Dynamical Systems
Heinz-Otto Peitgen
and Péter H. Richter
Springer-Verlag
New York: 1986
ISBN 0-387-15851-0
199 pages, \$35

Reviewed by
Eric A. Bobinsky

Anyone with an interest in fractals, computer graphics, mathematics, physics, art, or philosophy will find *The Beauty of Fractals: Images of Complex Dynamical Systems* a synthesis of the meaning of fractal geometry in each of these distinctive domains.

Written by Heinz-Otto Peitgen, a mathematician, and Peter Richter, a physicist, both professors at the University of Bremen, the book is the outgrowth of a 1984 exhibition of fractal art and its underlying mathematics. The authors had previously produced a brochure to accompany an exhibition called "Harmonie in Chaos und Kosmos," which served as a catalog of the fractal art and as an intelligent layman's explanation of its scientific foundation. From that first show sprang an international exhibition called "Frontiers of Chaos," which *The Beauty of Fractals* was written to accompany.

Three Potential Audiences

This book is, in a way, a three-in-one volume. First, it is a "philosophical physics" treatise, since the authors don't hesitate to relate fractal geometry to the nature of the universe, and they offer an exciting glimpse into new areas of science opened up by the development of fractal mathematics.

Throughout the opening chapters, the book stresses the importance of nonlinear processes in natural systems and, perhaps more important, that the long-term state of a given system (the stability of the solar system at some future date, for example) can't necessarily be determined by the initial values of its parameters. To quote from the book: "It is true that our space-ships can trust Newton's laws of motion and modern computers to guide them to their goals, but the fact remains that the route becomes unpredictable over *very long periods of time.*"

Second, this is a very well illustrated mathematics textbook. Although it is not, as the authors state, mathematically rigor-



KERMIT: A FILE TRANSFER PROTOCOL
Frank da Cruz
Digital Press
Bedford, MA: 1987
ISBN 0-932376-88-6
379 pages, \$25

MAC INSIGHTS
Lon Poole
Microsoft Press
Redmond, WA: 1986
ISBN 0-914845-73-X
276 pages, \$18.95

THE POWER USER'S MANUAL
Randal L. Kottwitz
MacUser Publications Inc.
New York: 1987
ISBN 0-9617462-0-3
168 pages, \$17.95

BALANCE OF POWER: INTERNATIONAL POLITICS AS THE ULTIMATE GLOBAL GAME
Chris Crawford
Microsoft Press
Redmond, WA: 1986
ISBN 0-914845-97-7
306 pages, \$10.95

ous, it is nonetheless rich in equations and mathematical notation. But those readers who are either uncomfortable with or uninterested in the mathematical sections can simply skip them without missing the flavor and the impact of the text and its accompanying illustrations (see the example above).

Third, this is a book for computer programmers, particularly those "renaissance coders" whose interests tend to range over the frontiers of both science and technology.

Acknowledging the Computer's Role

The authors acknowledge the assistance of two university computing departments and several programmers in the production of the graphics for the book, and they have returned the favor to the programming community at large by providing a sound mathematical and algorithmic treatment of fractal geometry. The last few pages of the book, titled "Do It Yourself," contain several fundamental algorithms, along with commentary, that can be programmed easily on a small computer.

Early on, the authors bring up the fact that this book—and, in fact, the entire field of fractal geometry—owes its current state of development to the computer. "Where scientists of earlier generations had to simplify their equations drastically or give up

continued

When 200,000 users like BitCom, it must be good.

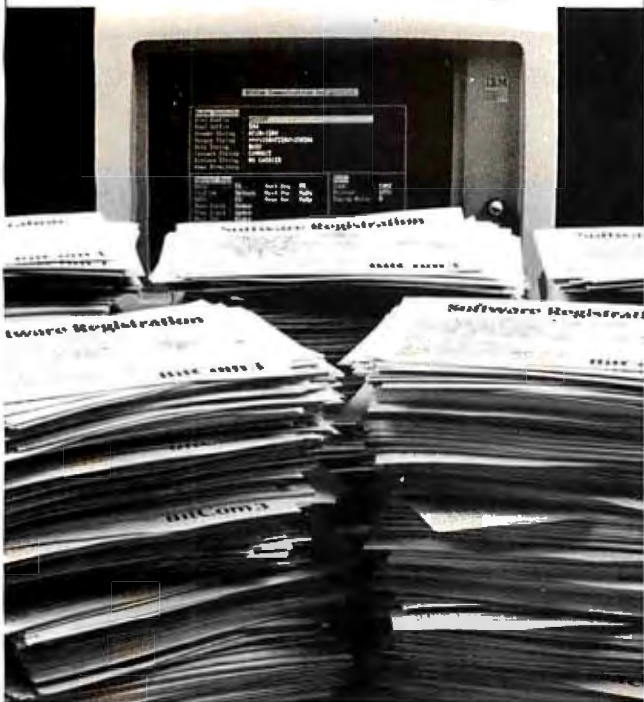

Whether you need to dial to on-line services or main-frame communications, don't buy communications software until you've checked out BitCom 3.02. It's the program that thousands of users prefer because it gives you so many features for such a low price:

- Powerful script language with more than 80 functions.
- Supports 132 column by 44 row and 132 column by 25 row (with graphics card).
- Transfers multiple files using YMODEM batch, and supports the popular XMODEM CRC method.
- Auto speed change to match that of remote computer.
- Supports COM1 through COM4.
- Programmable terminal emulation including VT100, IBM 3101 and most ASCII terminals.
- 110 to 9600 baud range.
- Now also available on 3½ inch diskettes.

"AMONG INEXPENSIVE COMMUNICATIONS PROGRAMS, (BITCOM IS) A CHAMP. . . IT MIGHT EVEN KNOCK SOME OF THE BIG BOYS OUT OF THE RING!"
—PC WORLD

Only \$69.⁰⁰ Not Copy Protected.
To Upgrade from Previous Versions
Send Original Diskette Plus \$35.⁰⁰ to Address Below

**Order Today, Call
(408) 263-2197**

**BIT Software, Inc.
755 Ames Ave., Milpitas, CA 95035**

BitCom 3

©BIT Software, Inc. 1987 BitCom is a Trademark of Bit Software, Inc.

BOOK REVIEWS

completely, we are able to see their full content on the display monitor. In graphical representation, natural processes can be comprehended in their full complexity by intuition. New ideas and associations are stimulated, and the creative potential of all those who think in pictures is awakened."

Contributions to the Book

At \$35, *The Beauty of Fractals* is not inexpensive. For that price, however, readers get a true potpourri of scholarly information on fractals that they can dig into as deeply as they wish. Each of 10 special sections has a self-contained treatise on some esoteric aspect of fractal geometry or its applications. The book's price is largely due to the 40 stunning color pages bound into the hardcover volume, amounting to about 80 plates.

Two of the sections will be of definite interest to programmers, namely, "Julia Sets and Their Computergraphical Generation" and "The Mandelbrot Set." The other sections deal mainly with mathematical issues such as "Verhulst Dynamics" and "Newton's Method for Real Equations" or physical issues like "Magnetism and Complex Boundaries." Even if the technical issues may be beyond the average reader in these sections, the illustrations of the fractals are fascinating.

Four of the chapters are contributed: one by Benoit B. Mandelbrot himself, one by French mathematician Adrien Douady, another by German physicist Gert Eilenberger, and a fourth by the German journalist Herbert W. Franke. These four chapters are nontechnical and are probably the most enjoyable parts of the book, particularly Mandelbrot's "Fractals and the Rebirth of Iteration Theory," a reminiscence of Mandelbrot's discovery of the set that now bears his name (see "Plotting the Mandelbrot Set" by Peter B. Schroeder in the December 1986 BYTE).

The Beauty of Fractals deserves high praise for uniting a new science—fractals—with a new art—computer graphics—and merging them with a humane and challenging view of our physical and intellectual universe.

Eric A. Bobinsky is a mathematician at the NASA Lewis Research Center. He can be reached at MS 54-8, NASA Lewis Research Center, 21000 Brookpark Rd., Cleveland, OH 44135.

KERMIT: A FILE TRANSFER PROTOCOL

Reviewed by Joel West

As many will recall, Kermit the Frog is a greenish children's puppet that found crossover success several years ago as a movie star. And, as author Frank da Cruz recounts in this book, a Muppets wall calendar inspired the name of a data protocol under development at Columbia University in 1980. Da Cruz and his colleagues had to pretend otherwise until, at the suggestion of a BYTE editor, they requested and received permission from Jim Henson to use the trademarked name of Kermit (the Frog) for Kermit (the file-transfer protocol).

Kermit: A File Transfer Protocol is the first and definitive text on the latter Kermit, previously described by codesigners da Cruz and Bill Catchings for BYTE readers in a two-part series (see "Kermit: A File-Transfer Protocol for Universities," BYTE, June and July 1984). It supplements earlier manuals distributed by Columbia University with a variety of Kermit programs, both as manuals shipped in printed form with Kermit tapes and in electronic form through various research networks.

The Importance of Being Kermit

Most of the writing about data protocols has focused on local and wide area networks, such as the ISO reference model.

continued

Overnight delivery is only half our legend.



Fred Motinari, President

The other half is quality. At Data Translation, we ride herd over the quality of everything we make. All Image Processing, Array Processing, and Data Acquisition boards

and software for the IBM PC are pre-tested and pre-burned in. We deliver products that meet *our* tough quality control standards, making our return rate the lowest in the industry.

So phone us by mid-day for overnight delivery.

After all, why should you wait weeks to start important projects when Data Translation can have you sitting tall in the saddle tomorrow?

CALL (617) 481-3700.



To learn more, see us in Gold Book 1987, or call to receive our first-ever 1987 3-Book Set, including 1987 Catalog, Product Summary Price List, and Applications Handbook.

Image Processing

Model	Resolution	Real-Time Frame Grab	Real-Time Processing	Software	Price
DT2851 Frame Grabber	512x512x8	✓	✓	✓	\$2995.
DT2858 Processor					\$1695.
DT2803 Frame Grabber	256x256x6	✓		✓	\$1495.

Array Processing

Model	FFT* 1024 Point Real	FFT* 1024 Point Complex	FFT* 256x256 Image	Software	Price
DT7010 Floating-Point Array Processor	23ms	41ms	3.9s	✓	\$4995.

*All execution speeds are real-world, not theoretical, and include overhead times.

Data Acquisition (24 Boards Total)

Series	Analog I/O	Digital I/O	12-bit & 16-bit	Throughput	Software	Price
DT2801	✓	✓	✓	13.7-27.5kHz	✓	\$295-\$2070
DT2821	✓	✓	✓	45-250kHz	✓	\$1345-\$2995
DT2811	✓	✓	12-bit	20kHz	✓	\$199-\$745

DATA TRANSLATION®

World Headquarters: Data Translation, Inc., 100 Locke Dr., Marlboro, MA 01752 (617) 481-3700 Tlx 951 646

European Headquarters: Data Translation Ltd., 13 The Business Centre, Molly Millars Lane, Wokingham, Berks, RG11 2QZ, England Tlx 849862 (#D)

International Sales Office: Australia (61) 2-662-4295; Belgium (32) 2-7352135; Canada (416) 625-1907; Chile (2) 2-253689; China (408) 727-8222, (86) 8-721-4017; Denmark (45) (02) 187188; England (44) 734-79383; Finland (358) 90-372144; France (33) (1) 69-28-01-73; Greece (30) (3) 152-7039, (30) (1) 361-4300; Hong Kong (852) 3-318585; India (91) 2-231040; Israel (972) 3-324298; Italy (39) 2-81821; Japan (81) (3) 502-5550, (81) (3) 375-1551, (81) (3) 355-1111; Korea (82) 778-0721; Malaysia (60) 3-36299; Morocco (21) 9-30-6949; Netherlands (31) 70996360; New Zealand (61) 2-662-4295; Norway (47) (02) 559050; Peru (51) (14) 31-8060; Philippines (63) 818-0103; Portugal (351) 1545313; Singapore (65) 271-3163; South Africa (27) 12469221; Spain (34) 14558112; Sweden (46) 8-7617820; Switzerland (41) 17231410, (41) 22360830; Taiwan (86) 2-709-1394; West Germany (49) 89809020.

Data Translation is a registered trademark of Data Translation, Inc.

PC/VI™

UNIX's VI Editor Now Available For Your PC!

Are you being as productive as you can be with your computer? An editor should be a tool, not an obstacle to getting the job done. Increase your productivity today by choosing **PC/VI**—a COMPLETE implementation of UNIX* VI version 3.9 (as provided with System V Release 2).

PC/VI is an implementation of the most powerful and most widely used full-screen editor available under the UNIX operating system. The following is only a hint of the power behind **PC/VI**:

- Globalsearch or search and replace using regular expressions
- Full undo capability
- Deletions, changes and cursor positioning on character, word, line, sentence, paragraph, section or global basis
- Editing of files larger than available memory
- Shell escapes to DOS
- Copying and moving text
- Macros and Word abbreviations
- Auto-indent and Showmatch
- MUCH, MUCH MORE!

Don't take it from us. Here's what some of our customers say: "Just what I was looking for!"; "It's great!"; "Just like the real VI!"; "The documentation is so good I have already learned things about VI that I never knew before." — *IEEE Software*, September 1986.

PC/VI is available for IBM-PC's and generic MS-DOS† systems for only \$149. Included are CTAGS and SPLIT utilities, TERMCAP function library, and an IBM-PC specific version which enhances performance by as much as TEN FOLD!

PC/TOOLS™

What makes UNIX so powerful? Sleek, Fast, and **POWERFUL** utilities! UNIX gives the user not dozens, but hundreds of tools. Now the most powerful and popular of these are available for your PC! Each is a complete implementation of the UNIX program. Open up our toolbox and find:

- | | | | |
|----------|---------|---------|-----------|
| • BANNER | • DIFFH | • PASTE | • SPLIT |
| • BFS | • DIFFS | • PR | • STRINGS |
| • CAL | • GREP | • RM | • TAIL |
| • CHMOD | • HEAD | • SED | • TR |
| • CUT | • MAKE | • SEE | • TOUCH |
| • DIFF | • OD | • SORT | • WC |

All of these for only \$49.00; naturally, extensive documentation is included!

PC/SPELL™

Why settle for a spelling checker which can only compare words against its limited dictionary database when **PC/SPELL** is now available? **PC/SPELL** is a complete implementation of the UNIX spelling checker, renowned for its understanding of the rules of English! **PC/SPELL** determines if a word is correctly spelled by not only checking its database, but also by testing such transformations as pluralization and the addition and deletion of prefixes and suffixes. For only \$49.00, **PC/SPELL** is the first and last spelling checker you will ever need!

Buy **PC/VI** and **PC/TOOLS** now and get **PC/SPELL** for only \$1.00! Site licenses are available. Dealer inquiries invited. MA residents add 5% sales tax. AMEX, MC and Visa accepted without surcharge. Thirty day money back guarantee if not satisfied! Available in 5¼", 3½" and 8" disk formats. For more information call today!

*UNIX is a trademark of AT&T. †MS-DOS is a trademark of Microsoft.

CUSTOM SOFTWARE SYSTEMS
P.O. BOX 678 • NATICK, MA 01760
617.653.2555



UNIX TOOLS FOR YOUR PC

UNIX TOOLS FOR YOUR PC

These protocols have been designed by computer vendors for use by their largest customers, transparently providing high-speed access for dozens (or hundreds) of computers.

Those with a single microcomputer and a modem have largely been ignored, even when their goals are far less ambitious. As an ASCII serial communications protocol for transferring files over a line or an RS-232C cable, Kermit provides an answer for the hobbyist, student, or small businessperson.

Kermit was originally designed by da Cruz and Catchings, but later enhancements came from a dialogue with its users. The latest extensions are designed for use with the current crop of high-speed modems and transmission through packet-switched networks.

Kermit has two advantages over other ASCII serial protocols: First, it was designed to run on many computer systems; and second, it is completely public and nonproprietary.

A valuable section of the book contrasts Kermit (the protocol) with another public domain microcomputer protocol, Ward Christensen's XMODEM/MODEM7, independently designed at about the same time. However, unlike the CP/M bias of XMODEM, Kermit has been successfully implemented on a wide range of microcomputers, workstations, and mainframes.

As independent software vendors crack the compatibility problem, they lock up their solutions in proprietary data protocols. In contrast, Columbia University has not only placed the specification of the Kermit protocol in the public domain but has freely distributed the source and object code for the several dozen programs that support it. By doing so, Columbia has performed a valuable educational service for the entire computer science community. As the sole participant at Columbia to remain from day one until the present, da Cruz is uniquely qualified to bring this project to the general computer public.

Levels Outlined in the Book

Kermit has three levels of target readers. The first such reader is the user of Kermit programs who may also be interested in the primer on data communications. The second is the local Kermit professional who supports such users. The third reader is someone who is writing a communications program that supports the Kermit protocol and who needs answers to specific questions.

A technical writer always faces a dilemma in trying to combine an easy-to-understand text with one that is technically detailed and precise, and the disparate audience makes the task even more difficult here. Da Cruz has done much better than most by addressing these distinct goals in separate sections. Witty drawings by George Ulrich enhance the book's light tone.

The goals and history of the Kermit effort include walks through several representative file-transfer sessions. Unfortunately, a published book in this field is a fixed snapshot of a moving target or, in this case, of the many evolving targets of the 42 different supported computers. The tutorial cannot list all possible systems or combinations and thus cannot supplant the specific, up-to-date documentation supplied by Columbia with each program. The documentation problem is made only slightly less grim by the use of a common command interface in many Kermit programs. It is doubtful, then, that any Kermit user would plunk down \$25 solely for the first 45 pages of this book.

Goals are followed by a primer on computers and serial communications. The novice should find it a reasonable introduction to these topics. For the experienced programmer, the most interesting sections document the differences in file formats for a variety of computers.

Next, a user's reference guide includes a complete description of the command interpreter developed by Columbia for the DECSYSTEM-20 implementation and used by many Kermit programs. When used with programs that feature this inter-

continued

Inquiry 293 for MS DOS Products.
Inquiry 294 for all others. —>

SILICON 1-800-354-7330 SPECIALTIES



\$346 With System A or B Only

MIT SYSTEMS TURBO PC/XT
256K Memory, 360K Brand Name Floppy Drive,
135 Watt Power Supply Slide Case,
AT Style Keyboard, 4-8MHz Clock Speed,
(Keyboard Selectable), 8 Expansion Slots



\$999 With System C or D Only

MIT SYSTEMS PC/AT
6-10 MHz Switchable, 512K RAM Expandable
to 1MB on Motherboard, a 1.2MB Floppy Drive,
192 Watt Power Supply, Dual Hard Drive
& Floppy Controller Card, AT Style Keyboard
and clock/calendar with Battery Back-up.

SYSTEM A	SYSTEM B	SYSTEM C	SYSTEM D
MIT XY Monochrome System MIT TurboXT MIT Monographics Card With Printer Port MIT Amber Monitor With Swivel Tilt Stand MIT I/O Serial/Clock Card MIT 4 Outlet Surge Suppressor	MIT XY Color System MIT TurboXT MIT Color Card With Printer Port MIT RGB Color Monitor MIT I/O Serial/Clock Card MIT 4 Outlet Surge Suppressor	MIT AT Monochrome System MIT 10 MHz AT MIT Monographics Card With Printer Port MIT Amber Monitor With Swivel Tilt Stand MIT AT Multi I/O Card MIT 4 Outlet Surge Suppressor	MIT AT Color System MIT 10 MHz AT MIT Color Card With Printer Port MIT RGB Color Monitor MIT AT Multi I/O Card MIT 4 Outlet Surge Suppressor
Turbo PC/XT w/640K & 1 Drive with System Order Only \$ 379	Turbo PC/XT w/640K & 1 Drive & 20 MG with System Order Only \$ 749	PC/AT 10 MHz w/1024K, 1.2 Floppy Drive with System Order Only \$1055	PC/AT 10 MHz w/1024K, 1.2 Floppy, 30 MG with System Order Only \$1645

Hardware Software

PRINTERS	BOARDS
Alps All Models Call Brother Printers Call Citizen Printers MSP-10 \$ 269 MSP-15 359 MSP-20 309 MSP-25 459 Premier 35 445 1200 169 Diablo D-25 759 635 469 Dyconics 150 \$ 299 Epson Printers Call NEC 3510, 3550 729 8810, 8850 1045 P-6 429 P-7 609 P-9 429 Okidata Call Panasonic 1080 I 189 1091 I 245 1092 I 319 1592 385 1595 465 3131 229 3151 369 Star Micronics Call Toshiba 321 465 341E 669 351 Model II 1045 351 Color 1029	AST Six Pack Plus 149 Hercules Color Card 145 Graphics Card 175 Intel All Above Boards Call Paradise EGA Autoswitch 305 5 Pack 99 Plus Development Plus Hard Card 20 Megabyte 609 Quadran Quad EGA Plus 329 Tecmar Graphics Master 409 Captain (No Memory) 109 Video-7 Vega Deluxe 335 Enhanced Graphic Adaptor 279 MONITORS Amdtek Monitors Call NEC Multisync \$ 575 Other Models Call Princeton Graphics Monitors Call TERMINALS Oume 101 Plus Green \$ 315 101 Plus Amber 315 Wyse 30 285 50 359 75 565 85 425 MODEMS Anchor Automation Anchor Express \$ 185 Hayes All Models Call Prometheus 1200B w/Software 129 US Robotics Password 1200 165 Counier 2400 335 Microlink 2400 349 DISK DRIVES Bernoulli Box 10 Meg \$1195 20Meg 1595 40Meg 2325

WORD PROCESSORS	SPREADSHEETS
Leading Edge Word Processor \$ 19 Leading Edge W/P with Spell & Merge 32 Microsoft Word 3.1 249 Multimate Advantage 299 PFS: Professional Write Call Volkswriter 3 136 Volkswriter Deluxe Plus 59 Webster New World Writer 73 Word Perfect (Ver. 4.2) 195 Wordstar w/Tutor 3.31 162 Wordstar Pro Pack 3.31 233 Wordstar 2000 2.0 233 Wordstar 2000 Plus 2.0 278	HAL \$108 Lotus 1-2-3 Ver. 2.01 Call Multiplan 3.0 108 Paradox 269 Twin 47 VP Planner 47
MONEY MANAGEMENT Dollars & Sense w/Forecast \$ 92 Tobias Managing Your Money 105	DATA BASE MANAGEMENT Clipper \$329 dBase III Plus 399 DB-XL 82 Paradox Special Price PFS: Professional File Call Revelation 449 R-Base 5000 System V 355
DESKTOP PUBLISHING Click Art Personal Publisher Call Harvard Professional Publisher Call Newsmaster \$ 48 Ventura Publishing 575	UTILITIES Brooklyn Bridge Call Carousel 2.0 \$ 29 Disk Optimizer 2.0 29 Double DOS 4.0 25 Fastback 84 Homebase 25 Call Microsoft Windows 55 Norton Utilities 4.0 48 Note It 58 PC Tools 19 Sidekick (Unprotected) 47
DISKETTES Maxell M2S (Qty. 100) \$ 85 Sony MD-2 (Qty. 100) 85 Sony 3 1/2" SS, D/D (Qty. 100) 120	PROJECT MANAGEMENT Harvard Total Project Manager II Call Microsoft Project \$219 Super Project Plus 269 Timeline 2.0 Call
COMMUNICATIONS CompuServe Starter Kit \$ 19 Crosstalk XVI 88 Microsoft Access 139 Mirror 38 Remote 88 Smartcom II 82	LANGUAGES Basic Compiler (Microsoft) \$219 C Compiler (Microsoft) 249 Cobol Compiler (Microsoft) 386 Fortran Compiler (Microsoft) 4.0 249 Genifer 188 Lattice C Compiler 236 Macro Assembler (Microsoft) 84 Run C Interpreter 65 Ryan McFarlan Fortran 305 Ryan McFarlan Cobol 479 Pascal Compiler (Microsoft) 166 Quick Basic 2 55 Turbo Jumbo Pack (New Ver.) 159 Turbo Pascal w/8087 & 8BCD 55 Turbo Prolog 54 Turbo Database Tool Box 38
INTEGRATIVE SOFTWARE Ability \$ 55 Enable 2.0 Call Framework II Call PFS 1st Choice Call Smart Software System 3.1 409 Symphony Call	
GRAPHICS/MICE Harvard Presentation Graphics Call IMSI Mouse (PC Mouse) w/Dr. Halo II \$ 92 Microsoft Bus Mouse 6.0 106 Microsoft Chart 164 Microsoft Serial Mouse 6.0 119 PC Bus Plus Mouse (New Ver.) Call PC Mouse (New Ver.) Call	



- No Charge for VISA and MasterCard
- You Pay the Ground Shipping - We Pay the Air
- Ground Shipping & Handling \$5.00
- Free Air Applies ONLY to orders up to 10 lbs. & Over \$50.
- All product carries a manufacturer's warranty. All Guarantees, rebates, trial period privileges & promotional programs are handled by the manufacturer only.
- No APO, FPO, or international orders, please.
- Call before submitting P.O. Numbers
- Personal and Company Checks Will Delay Shipping 2 weeks
- Prices & Availability Subject to Change Without Notice
- Add 3% for C.O.D. Orders
- We Do Not Guarantee Machine Compatibility
- All Sales Are Final

Mailing Address:
2222 E. Indian School Rd./Phoenix, Arizona 85016
Order lines: Mon-Fri. 7am-6pm.
Saturday 9am-1pm
Order Processing (602) 224-9345
10am-3pm, Mon-Fri.

NEW
EGA2001
 ■ 640 x 480
 ■ 132 COLUMNS
 ■ HERCULES® ON EGA
 ■ AUTO SWITCHING !
 ■ TERMINAL EMULATION SUPPORT

LIST \$369



- Hercules Mode on EGA/CGA Monitor
- 100% CGA (Color Graphics) Compatible
- 100% EGA Compatible
- 640 x 480 High Resolution Graphics
— Windows®, AUTOCAD® Drivers Available
- 132 x 25/44 on Mono/EGA Monitor
— Lotus 123® Drivers Available
- Absolutely NO Game Mode Diskette Required
- VT100, VT220 & Tektronix Emulation Support
- 256 KB Display RAM
- One Year Warranty
- FCC Class B
- Made in U.S.A.

PRICE/PERFORMANCE LEADER
 OEM, VAR, Distributors and Dealers
 Please call

AHEAD
 systems, inc.

1977 O'Toole Ave., Suite B105
 San Jose, CA 95131
(408) 435-0707

Also from AHEAD:
EGA2001/PLUS for Mainframe/PC Communications

- IBM® 3270 Mod 2, 3, 4, 5 & S3G
- 80 x 66 text mode for desktop publishing

Hercules, Windows, Autocad, IBM and Lotus are registered trademarks of their respective companies.

Turbo Pascal Programmers:

15 MINUTES = 200 HOURS!
 with new **turboMAGIC™** code generator.

Your productivity increased or your money back!

Let your imagination run wild! Turn your ideas into state-of-the-art programs. It's easy with **turboMAGIC**, the slickest code generator available for Turbo Pascal. Input forms and help windows up to 66 lines long. Pop-up menus. Pull-down menu systems. And **much more!** **turboMAGIC** will turn 15 minutes of your time into code that would take you hundreds of hours to write. When it comes to forms ... we do **more** than the others ... and we do it **better!**

Read what experts say: "Fast automatic updating of dependent fields adds flair to your input screens. ... **turboMAGIC** will be a blessing for programmers who would rather not write the user interface for every program." - Neil Rubenking, *PC Magazine*, 24 Feb 87.

Wouldn't you like some magic? Order **turboMAGIC** today. Just \$99.00. 30-day Money Back Guarantee. You can't lose. CALL NOW! 800-225-3165 or 205-342-7026. Requires Turbo Pascal 3.0 and a 256K IBM PC compatible. Not Copy Protected. No Royalties.

turboMAGIC™
 by
Sophisticated Software Inc.
 6586 Old Shell Road
 Mobile, AL 36608
 (205) 342-7026



BOOK REVIEWS

preter, the section will likely prove a well-thumbed reference for the user familiar with Kermit.

The remaining six chapters (some 100 pages) of Part IV walk through a complete program implementing the Kermit protocol with the most detailed commentary yet available. The narration covers Columbia's portable Kermit program written in C, which is the basis of Amiga, Macintosh, UNIX, XENIX, and other implementations.

In addition to describing the protocol's design and philosophy, the last section also includes practical efficiency calculations and many implementation caveats. The protocol description includes the two latest extensions: expanding the maximum packet size from 96 bytes to 837K bytes and support for multiple active data packets, the so-called sliding windows extension. Also included are valuable comparisons with the ISO's Open Systems Interconnection (OSI) reference model, Christensen's protocol, and a frank discussion of Kermit's design errors.

Dampening My Enthusiasm

The book has a number of weaknesses. The C example is the most portable implementation at Columbia, but the choice of C is unfortunate: Pascal programs are generally more readable to C programmers than vice versa. Although the use of short (five- and six-character) identifiers is proposed as a virtue for portability to archaic compilers, it is unnecessarily cryptic for a teaching example. The example also follows every trick for compactness in a C program at the expense of readability.

Despite the author's preeminent experience with Kermit (the programs), the book seems biased toward those programs where he has firsthand knowledge. The interest in the now-obsolete DEC-20, for example, seems to be to the detriment of its popular VAX/VMS cousin. The discussion of how to test a new program under IBM protocol converters may be important at Columbia, but it has little relevance to a developer hooking an Amiga to a UNIX box.

Finally, as da Cruz self-mockingly notes, the book is part "political tract" and part "polemic." Whether he's arguing against selling software or apologizing for the sexism of "male" and "female" labels on DB-25 connectors, da Cruz's infrequent diatribes grow tedious. His admonitions against military uses of Kermit seem particularly ironic when considering that the network sponsored by DARPA (Defense Advanced Research Projects Agency) has greatly facilitated Kermit's distribution.

Kudos to Columbia

Anyone not already familiar with Kermit (the program) should seek out a copy. Due to the efforts of those at Columbia and elsewhere, the programs are free and readily available from several user groups. Heavy users of Kermit, and those who must support such users, will find the book a valuable reference. It's essential for anyone writing a terminal program.

Joel West (P.O. Box 2733, Vista, CA 92083) has used or installed Kermit on six different computer types since 1984. His most recent article for BYTE was "Debugging Macintosh Applications" (December 1986).

MAC INSIGHTS and THE POWER USER'S MANUAL

Reviewed by Bonnie L. Walker

The authors of both *Mac Insights* and *The Power User's Manual* set out to write a comprehensive source of hints, tips, and shortcuts for using the Macintosh. If you are looking for a collection of tidbits about the Mac and its most popular

continued

AW...

WHAT THE HECK!

ProDesign II — Still \$299!

ProDesign II — the Easy-to-Use CAD System. The CAD system that was introduced two years ago for the amazingly low price of \$299. The CAD system that has undergone four major revisions with more than 400 enhancements. The CAD system that still costs only \$299!

How do we do it? Our accountants said to raise the price to cover research and development costs. Our business advisors said to charge more for the additional features. Our competitors said it's impossible to stay in business selling a comprehensive CAD package such as ProDesign II for only \$299.

And our customers said \$299 is great. So, we said:

"Aw... What the Heck! \$299 it is!"

Now, two years after its introduction, ProDesign II is one of the world's leading CAD packages. It has features previously found only on CAD systems costing thousands of dollars. For the single price of \$299, you get these features and more:

- Support for more than 180 printers (including color printers)
- Support for more than 80 plotters, with plotter optimization.
- Easy-to-Use single keystroke commands.

- On-screen menus accessible with a mouse.
- Comprehensive drawing commands, including the finest curve fitting in the industry.
- Editing features unsurpassed by ANY other CAD package.
- Extensive snap features, including snap to point, endpoint, midpoint, line, circle, ellipse, arc, intersection, and perpendicular.
- True Auto Dimensioning with several formats.
- Extensive Layering features.
- Full Macro capabilities.
- Specialized drawing aids, such as tangents to circles and ellipses, parallel lines, parallel curves, wide lines, and more.
- Complete hatching with up to 40 different patterns.
- Area and length calculation for line curves, circles, etc.
- Full Zoom, Pan, and Rotate capabilities.
- Capability to transfer drawings to and from other programs.
- Capability to Break/Trim Lines, Curves, Circles, Arcs, and Ellipses.
- Many more features — *All for only \$299!*

Where do you get ProDesign II? See your local computer dealer, or contact:

American Small Business Computers, Inc.

118 South Mill Street

Pryor, OK 74361

(918) 825-4844

Telex 9102400302 Inquiry 23

Want more information? Call or write for a detailed brochure and a free demo disk!

PRODESIGN II STILL ONLY \$299!



FRONT ELEVATION

1/4" = 1'-0"

Expansion Chassis/Tape Back-up



Specification

Model No.	No. of Slot	Space for 1/2 Height Drive	Power Supply (Watts)	Dimension D X W X H (cm)	Price
M-1*	0	1	50	30 x 15 x 6.5	\$139
M-2	3	3	100	42 x 25 x 16	\$299
M-3	5	3	100	39 x 30 x 15	\$239
M-4	12	2	100	40 x 49 x 14	\$299
M-5	0	2	45	39 x 18 x 15	\$149
M-6	0	1	50	26.5 x 18 x 13.5	\$169
M-7	5	2	100	38.5 x 30 x 13.5	\$299
M-8	0	2	45	39.5 x 18 x 13.5	\$149
M-9	0	2	60	38.5 x 49 x 9	\$249
M-10	8	4	135	43 x 49 x 14	\$239

* Extra space for a stand alone controller

EXT and RCV Adapters (Interfacing Computer & Chassis With Slots)...\$149

Tape Back-up (With Controller & Cable)...\$499

ORDER TOLL FREE: (800) 826-0267
In California Call (408) 434-0877

SOURCE ELECTRONICS CORP.

2380 Qume Drive, Suite E
San Jose, CA 95131

Telex: 279366 Fax: (408) 434-0539

NEW!

2 MEGABYTE MODEL AVAILABLE SOON!



THE 3.5" CONNECTION!

This internal 720K 3.5" disk drive is a "drop-in" replacement for 5.25" drives! It's the ideal solution for exchanging data between your PC/XT/AT and the new generation of laptops. Disk format is compatible with IBM, Toshiba and Zenith portables. The Model 853W drive kit contains everything you need, including interface adapters, premium SONY drive, and complete documentation. Uses your existing disk controller (no additional slots required). Requires DOS 3.2 for maximum performance. Ask about our special prices on SONY DISKS!

SONY DISKS
\$\$ SAVE \$\$



\$159.95
+ FRT. & TAX



2734-C Johnson Drive
P.O. Box 3717
Ventura, CA 93006



IMMEDIATE DELIVERY!

Call 805-658-7466 or 805-658-7467

software, either book will probably suit your needs. There are, however, a few differences between the books that may help you select the best one for you.

MAC INSIGHTS

Mac Insights is written by Lon Poole, the "get Info" columnist for *Macworld* magazine. His book consists of information that has appeared in his column and pointers he has gleaned from other publications, experts, and user groups. The tips are arranged by topic: troubleshooting, hardware hints, word processing, communications, and so on. Information about specific applications is located under appropriate topics. For example, under Word Processing you'll get tips about both MacWrite and Microsoft Word.

Topical Arrangement

Within each main grouping, the subtopics are not arranged in any particular order. For example, under the main topic Word Processing, Poole begins with a subtopic called Getting Around, in which he discusses the insertion point, followed by Keyboard Navigation and Place Markers. Under Place Markers, he suggests typing an unusual symbol and using FIND to locate the markers later. Under Selecting, he explains how to select lines, sentences, phrases, and paragraphs.

Throughout the book, Poole's emphasis is often on creative or commonsensical ways to use an application rather than on technical tips. Scattered among the practical tips, however, he does include some valuable technical tips such as the one that appears under the heading "Converting Documents." Here Poole explains how to remove unwanted return characters from an entire document using Microsoft Word, a situation that often occurs when transferring files from one computer to another.

More often though, Poole gives us information on how to use a particular application. For example, he explains in detail how to accommodate printed letterheads. "If your letter is only one page long," he writes, "the easiest and most reliable method of accommodating a letterhead in MacWrite is to insert the appropriate number of blank lines above the text of the letter."

Under the topic Editing, Poole's subtopics are so specific that only he would be able to find information in this book if he needed it. Examples are Saving often to avoid clogging memory, Efficient correction when typing, and Restoring backspaced text. Another topic in this category is Evaluating phrasing options. Fortunately, the book has a detailed index that helps to bridge the gap.

One of the best sections in *Mac Insights* is Resources. Poole provides detailed instructions on using ResEdit. He explains how to change a font, personalize an icon, and change Get Info comments, among other hints. More than 50 tips on graphics make the Graphics section among the most useful. The section of Communication tips focuses primarily on MacTerminal. About 50 applications are mentioned.

THE POWER USER'S MANUAL

The Power User's Manual was commissioned by *MacUser* magazine, in which author Randal Kottwitz's "Tip Sheet" column appears. Kottwitz also likes descriptive titles rather than generic ones, but since he has organized his book somewhat differently from *Mac Insights*, it's not as difficult to locate specific facts. The book begins with a section titled General Information and proceeds to group tips by application or hardware item, starting with Finder, Macintosh, and Macintosh Plus.

Desk Accessory Tips

Four full pages about desk accessories complement many useful tips. For example, Kottwitz warns us to always close all desk

continued

GET YOUR FEET WET.

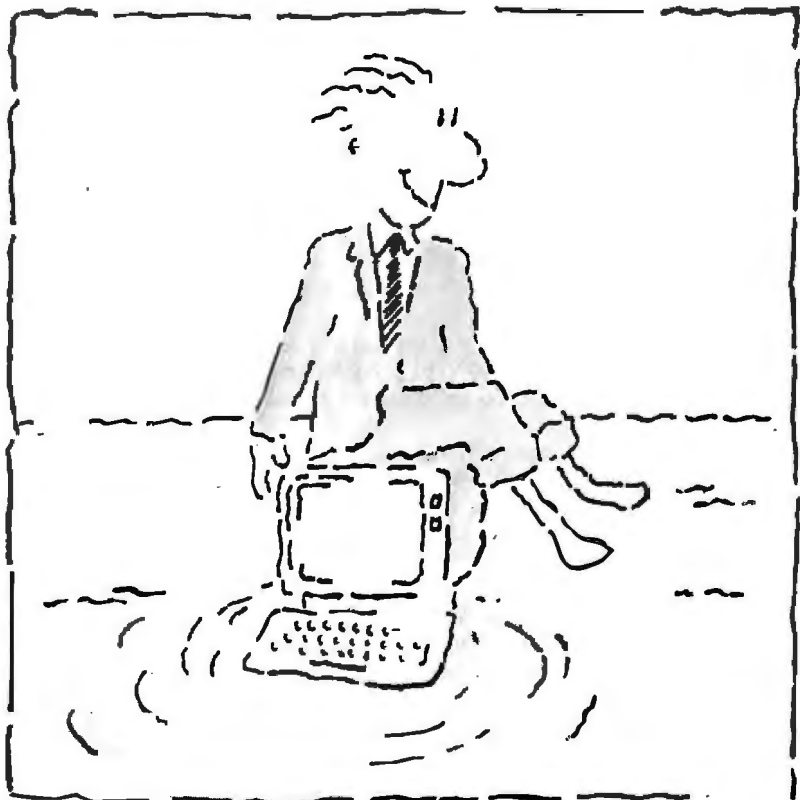

Sample Dow Jones News/Retrieval® — the nation's premier online

business and financial resource—without getting in over your head.

For only \$49.95, the News/Retrieval Membership Kit lets you and your colleagues plumb the depth of this valuable news and information service.

Eight free hours* of online time will get you started. There's a User's Guide to show you the way, step by step. And a year's subscription to *Dowline* (the magazine of News/Retrieval) gives

you background on and suggested applications for our offerings.

Stay on top of the competitive situation in your industry. Check on the positions of your company and clients. Keep up with breaking news or call up past news from *The Wall Street Journal* (online exclusively with News/Retrieval) back to January 1, 1984.

You can analyze a wealth of financial data, tap a pool of general knowledge, even plan a trip using almost any computer and modem, terminal or communicating word processor.

The Dow Jones News/Retrieval Membership Kit. It can help you embark on a wave of success... and not feel soaked.

To order or for more information, call **1-800-221-7700, Ext. 417E.** (Alaska, Hawaii and foreign, call 1-215-789-7008, Ext. 417E.)

Or use the coupon.

- YES! I WANT TO GET MY FEET WET!

- Corporate offer—\$49.95 Each** includes:
• 8 Free Hours* • Multiple Passwords
• User's Guide • 1 Year of *Dowline*
• \$12 Annual service fee waived for 1 year
 Send more information

- Personal offer—\$29.95 Each** for individual use, includes: • 5 Free Hours*
• Single Password • User's Guide
• 1 Year of *Dowline* • \$12 Annual service fee waived for 1 year

\$_____ ENCLOSED (Check/Money Order) Bill me later Charge to: AmExp MC VISA

(If you pay by credit card, all subsequent usage charges will be billed to your credit card.)

Card No. _____ Exp. Date. _____

Signature _____

Name _____ Title _____

Company _____

Address _____

City/State/Zip _____

Daytime Phone Number _____

Mail to: DJN/R Membership Kit, P.O. Box 300, Princeton, NJ 08543-0300
ATTN: John McGovern HOBV0507E

*Per account. Limited to new subscribers only. Free time (8 hours per Corporate offer; 5 hours per Personal offer) must be used within 30 days after receipt of password(s). Certain databases have fees over and above usage charges which are excluded from free time offer.

Dow Jones News/Retrieval®
Fuel for your ideas.

NEW! Profort802

- Water Resistant
- Dust Free

PORTABLE COMPUTER TERMINAL

For home, office,
factory, warehouse,
garage, shop, store.



LOW PRICE \$499

Features:

- Consumer/Industrial Application.
- Main frame computer & PC application
- Small and Light Weight.
- Display format of 5 X 7 Dot Matrix. 40 characters w/ASC II 96 characters.
- 32,000 character memory w/battery back-up.
- Full ASC II 128 character set-transmit.
- 5 user-defined function keys.
- Interface RS 232C. RS 422. TTL or 20mA loop.

EPOTEK CORPORATION

2151 O'Toole Ave., Suite L TEL (408) 922-0133
O'Toole Business Center 1-800-237-4590
San Jose, CA 95131 FAX (408) 922-0137

accessories before quitting an application or shut down from the Finder. If not, you could damage your System file, data files, or the application itself.

Sections about major applications are each like a short user manual for the application with only a few hints for advanced users. Other topics have one short tip and that's it.

For readers looking for communications information, this book offers a section on telecommunications and sections on MacTerminal. In addition, Kottwitz offers a section on Red Ryder plus Hayes modems and the Courier 2400 modem. *Mac Insights* focuses mainly on MacTerminal.

Because it is 100 pages shorter than *Mac Insights*, *The Power User's Manual* has less information about most of the topics it addresses. While Poole offers rather detailed, step-by-step instructions, Kottwitz focuses almost entirely on brief tips.

The Power User's Manual and *Mac Insights* both have fairly detailed indexes. Neither book has very many illustrations, although both contain lots of little icons.

Ingredients of Tip Books

To my way of thinking, a book of tips should offer information that is not in the applications' manuals. It might also include information that is in the manual but that is likely to be overlooked. A tip book should contain new ways of using applications that most people would not think of on their own.

Both these books follow that prescription, but both have significant flaws in organization, content, and clarity. Both books would benefit from a glossary of terms and a heavier emphasis on technical details, like a list of Finder versions and their specific characteristics, for example. Both would be improved by including more screen dumps from the applications they discuss.

Poole and Kottwitz have included as much current information as possible, given publishing constraints. There is a considerable amount of information about the Mac Plus, for example, in both books. One important piece of software was not included in either book, however: Microsoft Word 3.0 may well revolutionize word processing on the Mac. It will undoubtedly result in the need for new editions of both of these references.

Bonnie L. Walker, an independent consultant in Bowie, Maryland, is an instructional design specialist and systems analyst.

BALANCE OF POWER: INTERNATIONAL POLITICS AS THE ULTIMATE GLOBAL GAME

Reviewed by Rick Grehan

Chris Crawford is a designer of games noted for their unparalleled depth of perception. His latest creation—Balance of Power—is no exception. The game, about geopolitical interactions in the nuclear age, runs on the Macintosh. You play the role of either the President of the United States or the General Secretary of the Soviet Union. The computer plays the head of the opposing superpower. One goal of Balance of Power is to make it through to the end of 1994 alive, without engaging in a nuclear exchange. Another goal is to have as many powerful countries respecting your country as possible. The game refers to this latter accomplishment as prestige—the sum of the degrees to which countries show affinity to yours, weighted by their military strengths.

First a Game, Then a Book

Now Crawford has released a book by the same name that is as interesting as any game he has produced to date. *Balance of Power* is a carefully balanced investigation of the game's major

continued

New Quark®/PC Single Board Computer



Base model 5.75" x 8"

Only \$395.
Reg. Price ~~\$495~~

Quantity discounts available

- IBM PC® compatible single board computer mounts to 5 1/4" drive
- Includes Floppy Disk & Color Graphics CRT Controllers plus more

Also includes: Legal BIOS • Boots MSDOS® • Printer Port • 2 Serial Ports • 256K RAM • Clock Speed at 4.77 MHz • AlphaNumerics and Graphics Modes for Color Video Controller • Standard IBM® Keyboard Port.

Options include: 512K RAM • Piggyback I/O channel OEM Expansion Board • XT-Compatible Hard Disk SCSI Interface • Real Time Clock with battery-back-up • Clock speed of 9.5 MHz (twice as fast as a PC)

The Megatek Quark/PC is for OEM and end user applications that require PC compatibility in a compact single board computer. The Quark/PC BIOS will run most IBM PC® software including Flight Simulator and Lotus®. To meet your specifications a set of options let you add memory, speed and XT-compatible hard disk interface. Not only does it quickly mount to a 5 1/4" drive, it also comes with floppy disk and CRT color graphics controllers — all for just \$395.

To order or enquire call us today. Dealer enquiries welcome. Megatek Computer Technologies (416) 745-7214 150 Turbine Drive, Weston, Ontario M9L 2S2 Telex: 065-27453 U.S. Address: 1051 Clinton St., Buffalo, NY 14206 Distributors: NCS Electronics Varese, Italy • SES Electronics Noralngen, Germany • Perdex Microtronics Biggin Hill, U.K. • Microcomputing Ghent, Belgium • Asp Microcomputers Melbourne, Australia

Quark is a registered trademark of F. and K. MFG. CO. LTD., IBM, IBMPC and PCDOS are registered trademarks of International Business Machines Corp. Lotus is a registered trademark of Lotus Development Corp. MSDOS is a registered trademark of Microsoft Corp.

megatek

WRRROOM.



INTRODUCING FAST FORWARD.[™] NOW ANY SOFTWARE CAN RUN UP TO 10 TIMES FASTER.

No more doodling while your database goes digging. Or lollygagging while your spreadsheet loads. Or taking five while your word processing program takes forever.

With Fast Forward, any software runs 2 to 10 times faster.

CAN SOFTWARE REALLY DO THAT TO SOFTWARE?

Fast Forward can. Normally, your computer is constantly going to your disk and wading through massive amounts of data.

But with Fast Forward, data is retained in your computer's internal memory. Which is incredibly fast. Much faster than hard disks. Hundreds of times faster than floppies.

FAST FORWARD PERFORMANCE

■ With Fast Forward ■ Without Fast Forward

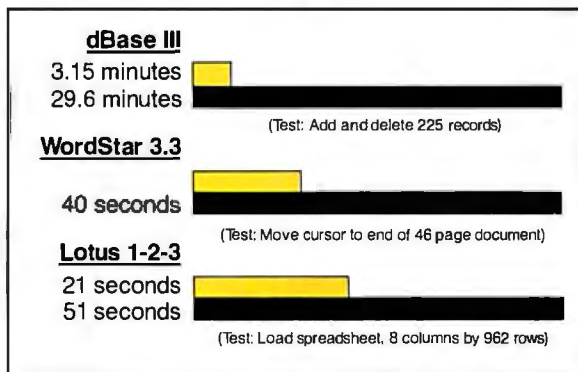

All tests done on 640K IBM PC, 20 megabyte hard disk and floppy drive. 320K RAM allocated to Fast Forward.

THE MORE YOU USE IT, THE FASTER YOU GO.

Once installed, Fast Forward works invisibly. As you use data, it's automatically stored in your computer's memory—and instantly available the next time you need it. Programs requiring frequent disk access (like dBase III) will show amazing improvements. And adding extended memory gives Fast Forward more room to work. So software runs even faster.

PERFORMANCE HAS A NEW PRICE: \$69.95.

You can buy a faster computer. Or an expensive accelerator board. But if you're ready to turn on the speed without turning over a bundle of money, ask for Fast Forward. It's from the Mark Williams Company, makers of quality software tools since 1976. And it's available at your software dealer. In the software department of your favorite bookstore. Or by calling 1-800-MWC-1700.* And hurry. Because it'll be going fast.

*In Illinois: (312) 472-6659

 Mark Williams Company

1430 West Wrightwood
Chicago, Illinois 60614

Fast Forward runs on IBM-PCs and 100% compatibles. Not copy protected. © 1987, Mark Williams Company

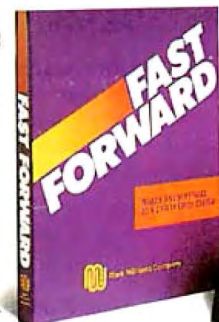

60-DAY
MONEY-BACK
GUARANTEE



8086
8088

AMX

8080
Z80
6809

Now
68000

Real-Time Multitasking Executive

- No royalties
- Source code included
- Fault free operation
- Ideal for process control
- Timing control provided
- Low interrupt overhead
- Inter-task messages

Options:

- Resource Manager
- Buffer Manager
- Integer Math Library

Language Interfaces :

C	Pascal
PL/M	Fortran

DOS File Access :

CP/M-80	AMX for 8080	\$ 800 US
IBM PC DOS	8086	950
	6809	950
	68000	1600
	Manual (specify processor)	75

AMX is TM of KADAK Products Ltd
CP/M-80 is TM of Digital Research Corp.
IBM, PC DOS are TM of IBM Corp

KADAK Products Ltd.

(604) 734-2796
Telex: 04-55670

206--1847 W. Broadway, Vancouver, B.C., Canada V6J1Y5

FOUR MEGABYTES LESS THAN ONE KILOBUCK!

The PC Tech Four Megger is long on a lot of things, like memory, reliability and performance. It's short on cost, power and length. The Four Megger comes complete with software for the Lotus, Intel, Microsoft Expanded Memory Specification as well as a fast memory disk program and an extensive diagnostic program. The Four Megger works in the IBM PC/XT/AT and compatibles at 4.77 or 8 MHz. All this for \$850.

Another smart idea from PC Tech.

Now Available: The 16 Megger. Expanded memory for AT and XT, as well as extended memory for the AT. Call!

904 N. 6th St.
Lake City, MN 55041
(612) 345-4555

Designers of the X16 and Other Fine Computer Products

forces. Within each of the chapters that define the game's ingredients, we are provided with a description of the real-world effect the author is attempting to simulate, a discussion of the algorithms he used, and several historical scenarios of events associated with the chapter's material. These historical outtakes demonstrate the author's meticulous research.

The Game's Design

Sprinkled throughout the book are the details of the author's efforts in designing the game. This is not Crawford's first publication on the subject: His earlier work is called *The Art of Computer Game Design: Reflections of a Master Game Designer* (Osborne/McGraw-Hill, 1984). The author reveals that this effort is composed not only of a series of additions, but more often requires the deletion of materials whose selection is derived painfully (and rarely scientifically). Particularly intriguing is the description of the feedback loop that evolved as Crawford developed the game. The act of representing (or attempting to represent) the intricacies of world geopolitics actually improved his understanding of them so much that he was able to redirect this new understanding into constructive modifications of the game.

What's Missing

As wonderful as this all sounds, the author himself points out important components missing from the game. In fact, he devotes an entire chapter to "The Unincluded Factors," the most important of which is the game's simple, bipolar view of the world (it ignores the potential emergence of China, for example, as a nuclear superpower).

Most omissions to the game, however, occurred either in response to the lack of resources (primarily memory, often time) or in an effort to make the game less overwhelming and more approachable.

Players of the game certainly appreciate its sophistication and would expect that software of such complexity was formulated using the latest development equipment. Yet it is interesting to read that the wonderfully detailed map of the world that is *Balance of Power's* primary screen was originally drawn freehand onto graph paper and laboriously entered into the Macintosh by hand.

Programmers who may find themselves considering year-long stints before a display screen in an effort to produce the next great computer-game blockbuster will find the chapter entitled "How *Balance of Power* Was Created" particularly interesting. It details the false starts, economic pitfalls, and other sordid details that might send even the best flowcharted plans of a formative game over the brink.

The Last Straw

Finally, the designer confronts his own creation in the appendix. Crawford plays a sample game and leads us through a step-by-step account of the action, particularly the activities below the surface. Most revealing is the author's analysis of his own miscalculations. We must stand in some awe of a program that puts its own designer into serious deliberations.

Balance of Power is a joy to read. Crawford is witty, lucid, and overflowing with ideas. The book is full of deep and often disturbing insights, such as the author's original proposal for the game: "I intend to show that good men can still annihilate the world through miscalculation."

You needn't be a computer programmer to read this book. However, if you are and you are interested in simulation or game design, you will find *Balance of Power* absorbing. ■

Rick Grehan is a BYTE technical editor. He can be reached at BYTE, One Phoenix Mill Lane, Peterborough, NH 03458.

A special kind of craftsmanship

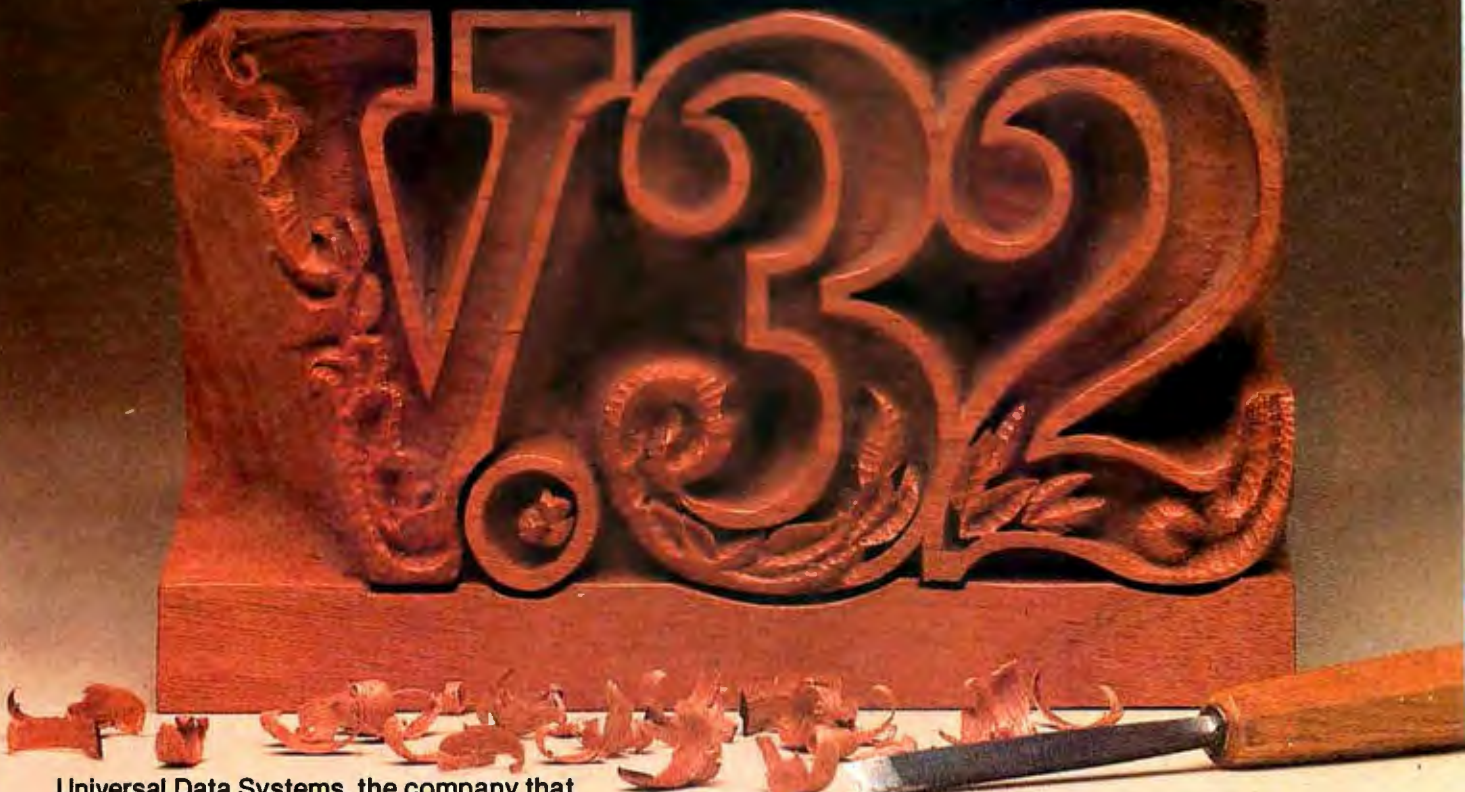

Universal Data Systems, the company that developed the first 9600 bps dial-up modem, has now applied its special brand of craftsmanship to the CCITT V.32 specification.

The result is a *full-duplex* 9600 bps device for the switched telephone network. When substandard line conditions are encountered, the device offers automatic fallback to 4800 bps, while maintaining the full-duplex communications capability.

As you expect from UDS, the device fully utilizes the latest in CMOS technology for low-noise performance and very low (less than 20W) power consumption. A new LCD control panel displays and configures modem set-up selections and displays outputs from the unit's comprehensive self-test regime. Auto-dial capability is also included.

If your system must accommodate periodic bursts of high-throughput, full-duplex communication, UDS craftsmanship and the V.32 standard provide a reliable, cost-effective solution. For complete technical details and quantity prices, contact Universal Data Systems, 5000 Bradford Drive, Huntsville, AL 35805. Telephone 205/721-8000; Telex 752602 UDS HTV.

Inquiry 333

\$2495⁰⁰
Quantity One



Universal Data Systems



MOTOROLA INC.
Information Systems Group

UDS modems are offered nationally by leading distributors. Call the nearest UDS office for distributor listings in your area.
DISTRICT OFFICES: Apple Valley, MN, 612/432-2344 • Atlanta, GA, 404/998-2715 • Aurora, CO, 303/368-9000 • Blue Bell, PA, 215/643-2336 • Boston, MA, 617/875-8868 • Columbus, OH, 614/895-3025 • East Brunswick, NJ, 201/238-1515 • Glenview, IL, 312/998-8180 • Houston, TX, 713/988-5508 • Huntsville, AL, 205/721-8000 • Issaquah, WA, 206/392-9600 • Livonia, MI, 313/522-4750 • Mesa, AZ, 602/820-6611 • Milwaukee, WI, 414/273-8743 • Mission Viejo, CA, 714/770-4555 • Mountain View, CA, 415/969-3323 • Richardson, TX, 214/680-0002 • St. Louis, MO, 314/434-4919 • Silver Spring, MD, 301/942-8558 • Tampa, FL, 813/684-0615 • Uniondale, NY, 516/222-0918 • Van Nuys, CA, 818/891-3282 • Willowdale, Ont, Can, 416/495-0008

Created by Dayner/Hall, Inc. Winter Park, Florida

**Gold Hill
delivers
GoldWorks.™**

Give me a GoldWorks preview.

- I'm ready to order **GoldWorks**. Please have a salesperson call.
- Send me the **GoldWorks** Demonstration Kit, including color video tape and complete User's Guide for just \$49 postpaid, refundable if I decide to purchase **GoldWorks**.
Send me VHS Beta.
- I don't want your Demonstration Kit right now, but send me more details about **GoldWorks**.

Name _____
 Title _____
 Company _____
 Address _____
 City _____ State _____ Zip _____
 Telephone (____) _____

- Check for \$49 enclosed (payable to Gold Hill Computers).
- Charge to my VISA MasterCard.

Acc't No.

--	--	--	--	--	--	--	--	--	--	--	--	--	--	--	--	--	--	--

 Exp. Date

--	--

Authorize Signature _____



B-M1

For phone orders or information, call toll-free:
1-800-242-5477.
 In Massachusetts, call (617) 492-2071.



GOLD HILL
 Gold Hill Computers, Inc.
 163 Harvard Street
 Cambridge, MA 02139

IMPORTANT: IF ORDERING BY CHECK OR CHARGE, PLEASE ENCLOSE THIS CARD IN AN ENVELOPE.

IMPORTANT:
IF ORDERING BY CHECK OR
CHARGE, PLEASE ENCLOSE
THIS CARD IN AN ENVELOPE.



NO POSTAGE
NECESSARY
IF MAILED
IN THE
UNITED STATES

BUSINESS REPLY MAIL

FIRST CLASS

PERMIT NO. 2811

BOSTON, MA

POSTAGE WILL BE PAID BY ADDRESSEE

Gold Hill Computers, Inc.
163 Harvard Street
Cambridge, MA 02139

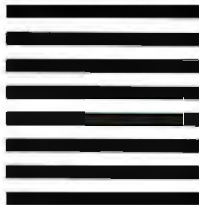

Now you can build and deliver serious expert systems on advanced PCs.

Introducing GoldWorks, formerly code-named Acorn.

GoldWorks is Gold Hill's premiere product for serious expert system building on 286- and 386-based PCs. It's designed for professional software developers who need to integrate expert systems with conventional applications running on conventional hardware. And it combines the best features of high-end expert system tools into a new standard for expert system development and delivery on advanced PCs.

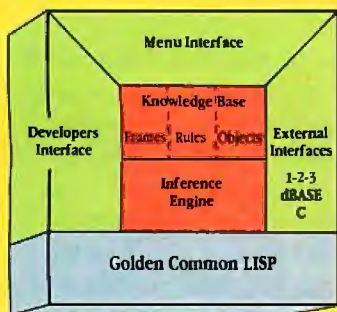

GoldWorks is the most comprehensive expert system tool available for advanced PCs.

Works like a shell.

GoldWorks gives you the best features of an expert system shell. With the easy-to-use menu interface, you can rapidly prototype and build expert system applications without knowing the underlying programming environment. And you get the GoldWorks tutorial, the San Marco LISP Explorer® tutorial, an on-line help system, and example applications to get you started quickly.

Works like a toolkit.

GoldWorks gives you the best features of an expert system toolkit. You can access the underlying pro-

gramming environment to extend and customize the system for your specific applications. And you can address up to 15 MB of extended memory on the PC AT (and even more on 386-based PCs).

Works like expert system tools previously available only on high-end workstations . . . at a fraction of the cost.

GoldWorks sets a new standard for expert system development and delivery on advanced PCs. You get frames with multiple inheritance for flexible knowledge representation. Rules supporting integrated forward and backward chaining for powerful inferencing. Object programming for developing modular applications. Plus advanced features for controlling the inferencing process, including rule sets, sponsors, rule priorities, certainty factors, and extensive rule inspecting and debugging facilities. All on conventional hardware—the PC you already use.

Works to develop and deliver your expert systems.

GoldWorks is the only tool that lets you develop and deliver serious expert systems on PC ATs. And GoldWorks also takes advantage of PCs based on Intel's powerful 80386 processor, including the COMPAQ DESKPRO 386 and Gold Hill's 386 LISP System.

Works to integrate expert systems with conventional PC applications.

With GoldWorks, you can integrate expert system applications with dBASE III and Lotus 1-2-3 . . . integrate C routines and libraries into your expert systems . . . and build and deliver expert systems in network environments.

Works the way you want an expert system builder to work.

GoldWorks from Gold Hill sets the standard by which all other expert system tools will be measured. It was extensively field-tested by developers in dozens of major corporations. And GoldWorks is backed by Gold Hill's comprehensive customer support, training and consulting programs.

Now you have the expert system builder that works the way *you* want to work—GoldWorks. To see how it works, order our unique Demonstration Kit, including full color video and complete User's Guide. It's only \$49 postpaid, refundable with your GoldWorks purchase. To order, call toll-free:

1-800-242-5477.

In Mass., call (617) 492-2071.

GoldWorks from Gold Hill. The expert in AI on PCs.

Gold Hill Computers, Inc.
163 Harvard Street
Cambridge, MA 02139



© Copyright 1987, Gold Hill Computers, trademark of San Marco Associates. Lotus are registered trademarks. DESKPRO 386 are trademarks of Compaq Computer Corporation.

GoldWorks, GCLISP, and 1-386 LISP System are trademarks of Gold Hill Computers, Inc. San Marco LISP Explorer and 1-2-3 is a trademark of Lotus Development Corporation. dBase is a trademark of Ashton-Tate, IBM PC-AT and Intel is a registered trademark and 80286 and 80386 are trademarks of Intel Corporation. COMPAQ and

Incredible Versatility. Incredibly Priced!

Now you can have it all with the incredible Mega-Link by Intellicom. This universal four port buffer features both serial and parallel ports plus automatic ABC switching. To make sure you never need to wait for the printer, the Mega-Link comes with a standard 256k of buffering (user expandable to a full megabyte).

The Mega-Link can be used with virtually any computer/printer system. Its four ports (two serial, two parallel) allow 1, 2, or 3 computers to share a conventional or laser printer. Naturally, the

The Mega-Link comes with both and they can be used in any combination. In addition, the 2 serial ports can be configured for use with the optional Intellicom Remote Computer Adapter*. The Remote Computer Adapter eliminates the inconvenient 10-foot limitation on parallel cables linking your computer and printer. Now, your computer can be over a mile away from the Mega-Link using inexpensive telephone cord.

ABC SWITCHING AND MORE: The ABC switching feature automatically selects active input ports

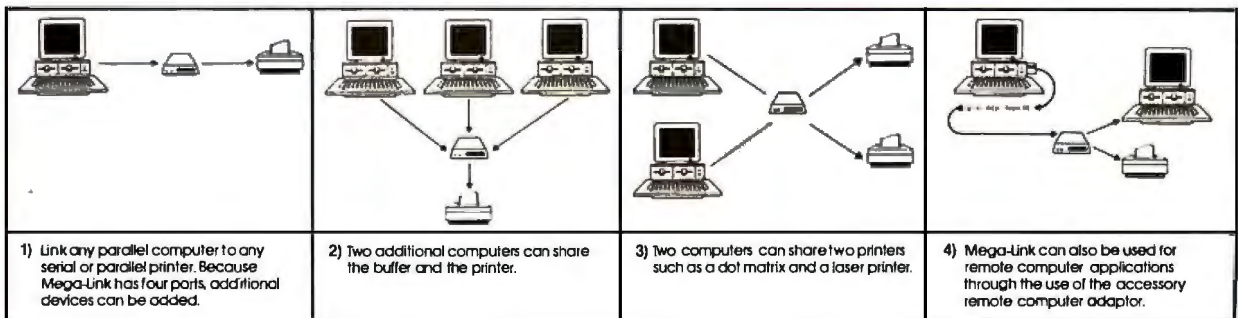

Mega-Link has all of the advanced features you'd expect; multiple copy, single sheet mode, pause and buffer erase plus a "top of forms" mode that assures each job will start with a fresh sheet of paper. For plotter users, the Mega-Link has a unique pause mode which allows you to change paper between jobs.

SERIAL AND PARALLEL:

PCs and printers can have 2 different types of interfaces, serial and parallel.

so up to 3 PCs can input into one Mega-Link. The Mega-Link keeps track of all documents and prints the jobs in the order received. Mega-Link is covered by Intellicom's full 2-year warranty and comes with an easy-to-understand graphics-based users' manual. Don't settle for less than the incredible.

Mega-Link™
\$349.00

Intellicom

800-992-2882 (outside CA)
800-422-4428 (in CA)
9259 Eton Ave.
818-882-8877
Chatsworth
CA 91311

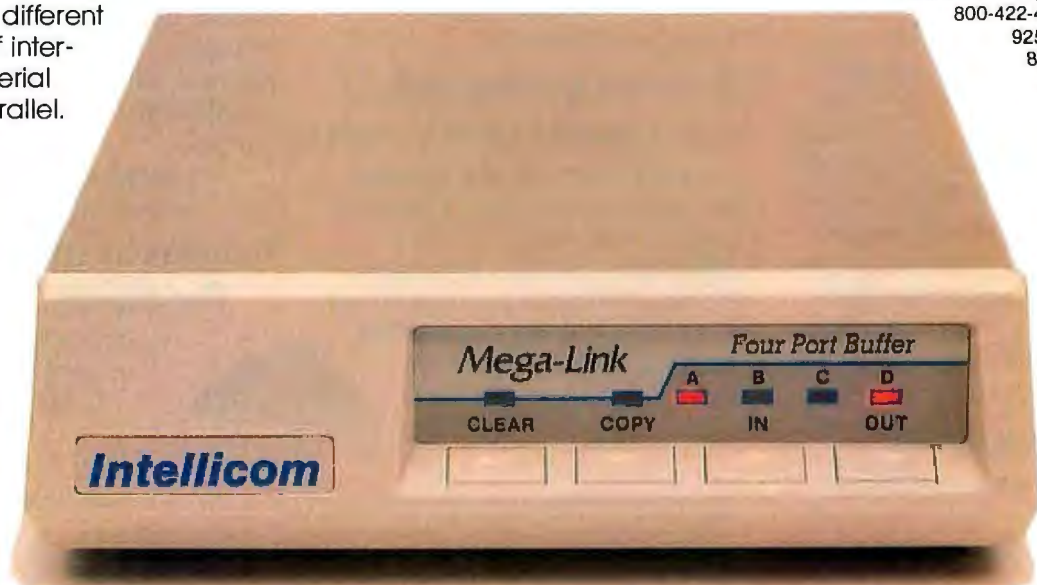

Features

Product Preview:
The Tandon PAC 286 85
by Jonathan Erickson, G. Michael Vose, and Charles Weston

Programming Project:
Pull-Down Menus in C 108
by James L. Pinson

Build BERT,
the Basic Educational Robot Trainer,
Part 2 113
by Karl Brown

An Adventure Authoring System 125
by David Betz

Interactive Fiction as Literature 135
by Mary Ann Buckles

Special BIX Supplement: "Power Protection for Microcomputers" by Mark Costello, a guide to understanding and selecting uninterruptible power supplies, appears in the topic UPS within the BIX conference may87.sup. (For information on joining BIX, see page 256.)

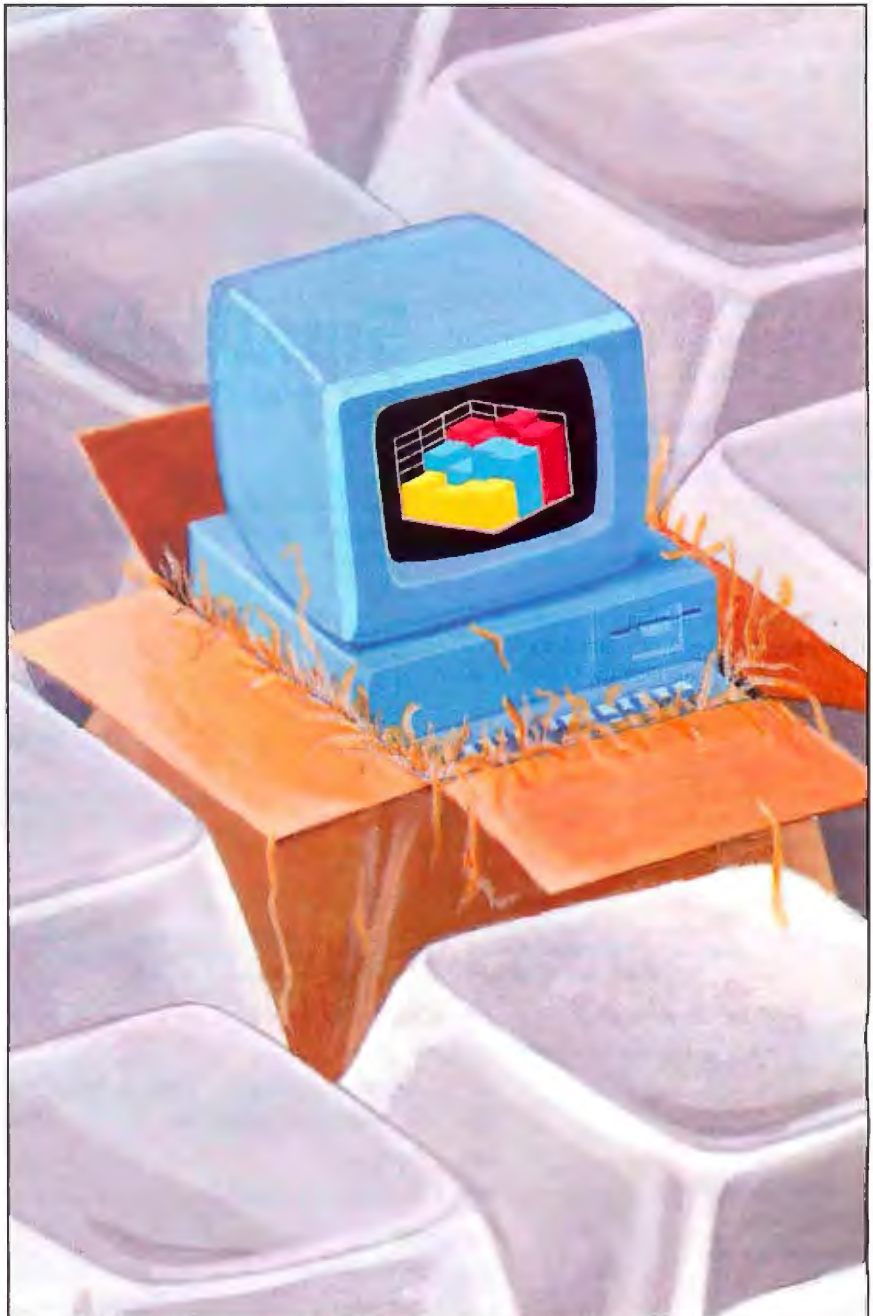

Why Are So Many People Switching to Smalltalk/V?

Why are scientists, engineers, and professionals switching to Smalltalk/V? Because it lets them do amazing things on their PCs, with a Mac-like interface and an easy-to-use object-oriented language. And with Smalltalk/V you get an unsurpassed array of problem-solving tools. You can even personalize the entire system to suit your needs.

Smalltalk/V is the programmable environment that gives you total control of your computer and makes it what it was meant to be, a truly personal tool for your mind.

"This is the real thing, folks. A super Smalltalk like this turns your PC into a hot workstation. It's fantastic . . . Highly recommended."

*John C. Dvorak,
Contributing Editor, PC Magazine*

"My background is in physical chemistry, not in programming. I like Smalltalk/V because I can use objects in the computer to represent objects in the physical world."

*Dr. Paul Sober, Senior Specialist
E. I. du Pont de Nemours & Co.*

"Smalltalk/V is a productive programming environment that allows us to quickly develop sophisticated medical applications."

*Dr. Mike McCoy,
Dean for Instructional Computing
UCLA School of Medicine*



"Smalltalk/V is the highest performance object-oriented programming system available for PCs."

*Dr. Piero Scaruffi,
Chief Scientist, Olivetti
Artificial Intelligence Center*

"Smalltalk/V is an excellent buy and makes a good alternative to other programming languages for the development of complex applications."

*Bill Wong, Director, PC Labs
PC Magazine*

\$99.00

Other Smalltalk/V Features

- Object-oriented Prolog integrated with the Smalltalk environment
- Supports exploratory programming and prototyping
- Class hierarchy with inheritance creates highly re-useable source code
- Smalltalk source code included, with browser windows for easy access and modification
- Object-swapping creates a virtual memory on hard or RAM disk
- Bit-mapped graphics with bit and form editors
- A sophisticated source-level debugger
- Automatic change log for easy recovery from errors
- Powerful directory/file browser system for organizing DOS files
- Access to other languages and DOS functions
- 500 page manual with comprehensive tutorial and reference sections
- Optional add-on modules
 - RS-232 communications interface with UNIX™ and TTY windows
 - EGA color graphics
 - "Goodies" diskette, including multiprocessing, music, zoom, object loader, and more

Smalltalk/V

The Programmable Environment

"Smalltalk/V, with its visual interface and class structure, is a perfect way to simulate the complex interactions of natural systems."

*Lee A. Graham, Research Assistant
Institute of Ecology, University of Georgia*

"I solve problems quickly using Smalltalk/V because its classes and objects help me organize my thinking. And besides, it's fun to use."

*Dr. Barry Fishman, Sr. Project Engineer
Hughes Aircraft Company*

BYTE and BDX are trademarks of McGraw-Hill, Inc. IBM, IBM-PC, and IBM PC-AT are trademarks of International Business Machines Corporation. Unix is a trademark of Bell Laboratories.

Inquiry 92

Yes! I want to turn my PC into a hot workstation! Send me . . .

- Smalltalk/V-The Programmable Environment \$99
- Communications Option \$49
- EGA Color Option \$49
- "Goodies" diskette \$49
- Shipping and Handling \$ _____
- CA residents add applicable sales tax \$ _____
- TOTAL** \$ _____

- Shipping and Handling**
- U.S., Canada, Mexico \$ 5.00
- Elsewhere \$15.00

I enclose Check Money Order

Credit card information MC VISA

Number: _____

Expiration: _____

Signature: _____

Name: _____

Street Address: _____

City/State/Zip: _____

Phone: _____

**NOT COPY PROTECTED, 60-DAY MONEY-BACK GUARANTEE
ON-LINE USER-SUPPORT CONFERENCE ON BYTE'S BDX™**

Smalltalk/V requires DOS and 512K RAM on IBM PCs (including AT) or "compatibles," and a CGA, EGA, Toshiba T3100, Hercules, or AT&T 6300 graphic controller. A Microsoft or compatible mouse is recommended.



5200 West Century Boulevard
Los Angeles, CA 90045 (213) 645-1082

Jonathan Erickson, G. Michael Vose, and Charles Weston

The Tandon PAC 286

An AT-class computer with a unique disk subsystem and memory management unit

Editor's note: *The following is a BYTE product preview. It is not a review. We provide an advance look at this new product because we feel it is significant. A complete review will follow in a subsequent issue.*

Of all the innovative technology that drives the personal computer business, none moves faster than new disk technology. Tandon Corporation, a company built on disk technology, recently developed a disk subsystem featuring portable hard disk data packs. To sell these unusual new disks, the company built an AT-class computer called the PAC 286 that uses the removable disk drive/data packs and incorporates a custom memory mapper chip to give the computer access to memory above the MS-DOS 640K-byte boundary.

The Tandon PAC 286 (see photo 1) sells for \$2995. Personal Data Packs (PDPs) cost \$300 to \$400 each (see the In Brief box on page 86 for a full description of the configurations of the PAC 286). A PAC 286 machine comes with two data pack receptacles, providing a total of either 30 or 60 megabytes of on-line storage capability. Data packs weigh 2½ pounds and can fit easily into a briefcase. PDPs are self-contained 15- or 30-megabyte hard disk drives with one or two 3½-inch platters and their read/write heads.

For now, PDPs can be used only in the Tandon PAC 286, although Tandon plans to offer add-on/add-in devices for exist-

ing IBM PC-, XT-, and AT-class machines later this year.

System Description

The Tandon PAC 286 features an Intel 80286 microprocessor that runs at either 6 or 8 megahertz. The machine uses a custom clock generator/bus controller with a 48-MHz oscillator. An MS-DOS software switch lets you select a processor speed that is either 1/6 or 1/8 of the oscillator frequency.

You can back up the 80286 with an optional 80287 math coprocessor for additional floating-point calculation speed. The PAC 286 features both real and protected mode operation and uses a 24-bit

address bus and an 8- or 16-bit data path.

The microprocessor uses a single wait state to interface to the standard 1 megabyte of on-board, 150-nanosecond RAM. With the addition of an optional RAM expansion board, motherboard RAM can be increased to a total of 5 megabytes. This RAM expansion board attaches to the CPU board via a special 60-pin connector and therefore does not use up any of the machine's expansion bus slots. (Tandon offers this expansion board in both a 1-megabyte and a 4-megabyte configuration.) You can expand total system RAM to 16 megabytes by adding additional memory cards into the expansion bus slots. In addition, the PAC 286 uses a

continued

Photo 1: *The Tandon PAC 286.*



© Robert Fujika Studios

Jonathan Erickson and G. Michael Vose are BYTE senior technical editors. Charles Weston is a BYTE technical editor. They can be reached at BYTE, One Phoenix Mill Lane, Peterborough, NH 03458.

IN BRIEF

Tandon PAC 286

Company

Tandon Corporation
405 Science Dr.
Moorpark, CA 93021
(805) 523-0340

Price

\$2995

Microprocessor

Intel 6-/8-MHz 80286, 16-/32-bit
microprocessor

Main memory

1 megabyte, expandable to 5
megabytes with optional piggyback
memory expansion board

Disk memory

360K-byte or 1.2-megabyte MFM-
recorded floppy; two 15-megabyte RLL
2-7 recorded Personal Data Pacs with
50-ms access time (Model 15); two
30-megabyte RLL 2-7 recorded
Personal Data Pacs with 50-ms access
time (Model 30)

Keyboard

Detachable 101-key AT-style
keyboard

Ports

9-pin serial port; 25-pin parallel port

Slots

One 62-pin XT-compatible slot; four
98-pin AT-compatible slots

Optional peripherals

80287 math coprocessor
2- or 4-megabyte piggyback board
with up to 4 megabytes of RAM
Expansion box
Mouse

proprietary memory mapper chip that lets the machine access all 16 megabytes of memory in the real address mode (see below).

Two 32K-byte by 8-bit EPROMs contain the ROM BIOS for the PAC 286. The ROM is mapped to the top of the first and last 1 megabyte of the address space of the memory installed in the machine (hexadecimal 0F0000 and FF0000).

The PAC 286 uses two 8237 direct memory access controllers cascaded to provide seven DMA channels with 16-bit data transfers permissible only through channels 5 through 7. In a similar arrangement, two 8259A interrupt controllers provide 15 levels of programmable system interrupt and one nonmaskable interrupt. In all, the PAC 286 CPU board comprises 29 chips—not counting memory parts—including five gate arrays.

The PAC 286 can be expanded even further through the use of an optional expansion box that is attached to the computer via a 100-pin printed circuit board edge connector. The expansion box can house an additional three PC, XT, or AT expansion boards, provides room for two additional half-height fixed disk drives, and is powered by its own power supply with cooling fan.

Since the PAC 286 is an AT-compatible computer, it uses the standard variety of PC, XT, or AT display adapters, from 320 by 200 monochrome output to EGA/PGA capability. The floppy disks read and write IBM-format disks. The machine uses MS-DOS 3.2 as its operating system. The PAC 286 differs substantially from AT-class computers, however, at the hard disk level.

The Personal Data Pac

From outward appearances, the one thing that sets the Tandon PAC 286 apart from other personal computers is a unique

mass storage system built around 15- and 30-megabyte PDPs. Technically, a PDP is a removable hard disk, but after using one for a while, you begin to realize that it is much more than “just another hard disk.” PDPs, which are fully interchangeable within a system and between systems, let you quickly, easily, and safely take your entire computing environment—productivity programs, data, memory-resident utilities, languages, macros, and so on—wherever you go. This has far-reaching implications for those who can or must use more than a single PC, are concerned about data security or data protection, or want to prevent software piracy. Additionally, each PDP has a unique software-coded serial number that permanently differentiates it from every other PDP in existence. This, too, offers many opportunities that haven't been possible before, as we'll discuss later.

Of course, removable, transportable mass storage devices have been around for some time, but the problem with them has been that they are too delicate, time-consuming to back up, and expensive to be useful for much more than archiving data. PDPs change all that. Because of their unique design, PDPs provide the most rugged PC hard disk storage environment—removable or stationary—available today. While you can't “slice it and dice it,” a PDP can withstand far greater abuse than the typical PC user would ever think about subjecting a storage device to. Backing up data isn't a chore with PDPs either, since it takes only about 2½ minutes to copy 30 megabytes of information. And at only \$350 to \$400 per 30 megabytes, PDPs may be one of the biggest data storage bargains anywhere.

A PDP (see photo 2) is a rectangular plastic box with a raw hard disk assembly. It measures 2½ inches high by 4¾ inches wide by 7 inches deep and weighs approximately 2½ pounds. Three edges of the PDP are squared, while one edge (the lower left) is angled to prevent the PDP from being inserted upside-down or backward into its *receptacle*, the PDP equivalent of a floppy disk drive. The PDP does not have disk access lights; these are on the receptacle units. Once the PC is powered up and under system control, a PDP is *self-loading* in that once you insert the PDP into the receptacle part way, a *sled* grips the bottom of the pack to pull it all the way into the receptacle, where a 36-pin male connector (I/O, power, etc.) on the back of the PDP mates with a connector at the rear of the receptacle. A motor then aligns and engages the disk. The insertion/ejection process is similar to that of a Macintosh disk, al-



Photo 2: Personal Data Pacs for the PAC 286 computer.

though PDP insertion/ejection is smoother.

By removing the plastic case (and possibly voiding your warranty), you can see that a PDP's main internal components are a Tandon Model 383 hard disk unit, a printed circuit board with an attached 36-pin connector, and a solenoid, all fastened within a metal cage by four rubber shock mounts.

Like other hard disks, a 30-megabyte PDP has two double-sided platters with four read/write disk heads, while a 15-megabyte unit has a single double-sided platter with two heads. Whenever the PDP is not loaded into a receptacle, the disk platters and disk heads (and ultimately the data) are protected by a unique head-locking mechanism and process.

This process, referred to as *end unloading*, gets under way when the system receives a PDP ejection command. The first thing that happens is that track 0 is identified so that the disk heads can be parked away from the directory track. Once track 0 is located, the disk heads move in 220 tracks, the 12-volt solenoid then moves a one-of-a-kind plastic comb (also called a *separator fork*, the main physical component of the locking mechanism) between the individual head stalks (the *arms* to which the heads are attached), and the heads move out 151 tracks and finally step out 69 more tracks.

Once in position, this comb holds the disk heads away from the surface of the platters and supports the head stalks. It is this mechanism that keeps the disk heads from banging against the disk platters as the PDP unit is moved about. The entire unloading and ejection process takes about 7 seconds. When a PDP is inserted into a receptacle, *head loading* (which is the reverse of the process described above), activates.

Currently, the PDP head unloads only as part of the PDP ejection process. As long as the PDP is loaded in the receptacle, it is susceptible to the same shock dangers as standard hard disks. Tandon will include a utility for head unloading without PDP ejection in production units of the PAC 286. You cannot remove a PDP from the receptacle except under system control after an eject command is issued. (In other words, there is no "poke hole" as found on the Macintosh.) This feature prevents a PDP from being removed without first locking the head and comb mechanism. The only way to manually eject a PDP is to remove the back cover of the receptacle unit and disengage the PDP by hand. If the power suddenly fails, there is no way to remove the PDP from the receptacle unless you remove the back cover. In most cases, this will not be a problem since the PDP becomes,

in effect, a conventional, stationary hard disk and should be treated as such. It may be an inconvenience, however, if you have grown used to the convenience or necessity of moving the PDP from one system to another for portability or security.

According to Tandon specifications, a PDP can withstand shocks of greater than 250 Gs or "a [flat] drop of 18 inches onto a rigid surface (such as concrete covered with vinyl tile) without sustaining functional damage." (Tandon defines functional damage as "either the case is damaged such that the PDP cannot be loaded into the receptacle or that data cannot be recovered.") Furthermore, Tandon claims that if a PDP is dropped and lands on any edge or corner, functional damage will not occur. Drops onto softer surfaces obviously can be made from greater heights.

The data transfer rate for PDPs is 7.5 megabits per second with a maximum access time of 100 milliseconds and an average seek time of 50 ms. Due to caching on the disk controller board, actual drive performance is greater than the specifications indicate. (Since a read/seek operation is performed between each read/write, the PDP is faster on reads than it is on writes.) Additionally, logical track 0 has been located in the middle of the disk to enable faster data access.

Each platter in both the 30-megabyte and the 15-megabyte PDP has 615 cylinders, while a 30-megabyte unit has 2448 tracks and a 15-megabyte PDP has 1224 tracks. Since RLL (run length limited) encoding is used on the disk controller board to physically format the unit, each PDP has 26 sectors with 512 bytes per sector. If some sectors have defects, their headers can be rewritten and reassigned to specially reserved sectors at the physical end of each track.

When compared to MFM encoding techniques, RLL encoding, which is emerging as the predominant approach to putting data onto hard disks, enables both a higher data transfer rate (1.5 times greater) and higher storage capacities. In this case, RLL data-encoding techniques enable Tandon to take a current-generation 20-megabyte hard disk design with minor modifications and allow it to be reformatted for 30 megabytes of capacity. RLL improves on conventional encoding schemes (including MFM) because it represents a binary data string as a data encoded pattern without separate clock or data bits (as does MFM encoding), hence there are fewer flux reversals and faster transfer rates.

In addition to supporting RLL encoding, the disk controller, which is con-

The data transfer rate for PDPs is 7.5 megabits per second with a maximum access time of 100 ms and an average seek time of 50 ms.

trolled by the 80286 CPU through the BIOS, also features 56-bit error correction coding (ECC) with the ability to recover bad sectors, consecutive disk sector reads and writes without interleave, full-track read buffers for random sector access, and the ability to relocate sectors on a track.

The disk controller is physically housed on two printed circuit boards; one board contains digital components, and the other contains analog components (we'll cover this in more detail later). In addition to supporting the PDP drives, the disk controller also provides support for two standard ST-506 fixed disk interfaces.

The components on the digital board include a control processor, a RAM buffer controller, DRAM, a digital multiplexer (for selecting between PDP or ST-506 devices), a phase comparator, a CMOS LSI disk controller chip, and the ST-506 interface. The disk controller chip performs most of the data transfer functions by accepting command and status signals from the CPU to provide the appropriate controls for both the ST-506 and PDP interfaces, including head select and I/O transfer. The disk controller also contains RLL encoding and decoding logic and error detection and correction logic.

Caching, or buffering, on the controller board is accomplished by a least recently used (LRU) buffer management process. When a request for caching is sent to the controller board, the BIOS first looks to see if the sector demanded is already in the cache. If the sector is in the cache, it is transferred from there to the user space, and access returns to the disk. If the request isn't satisfied, the system goes out and finds an available buffer. If a free cache buffer is available, the system just takes that buffer. If all buffers are used, then the system finds the oldest buffer and uses it. The total cache is 128K bytes in size, roughly divided among eight buffers.

The RAM buffer controller enables the PAC 286 to avoid using system RAM for

continued

The 80286 Problem

The Intel 80286 microprocessor suffers from what can best be described as a conceptual design flaw that hampers its use in protected virtual address mode. Programmers discovered that doing context shifts between real mode and protected mode was not a trivial task. The placement of the T-bit and the permission bits within the address/segment word (see figure A) required register manipulation of the address portions of this word before any address translation arithmetic (virtual, or logical, addresses to physical addresses) could be accomplished.

Because of the position of these non-address bits, simple 32-bit arithmetic for calculating addresses is not possible in 80286 protected mode. (See listing 1 for a pseudocode description of the 80286 virtual address calculation process.) Programs written for the 8086 and PC-DOS therefore require some significant manipulation of the address segments to be able to run in 80286 protected mode.

As you can see from figure A, only 14 bits of the value loaded into the segment register are significant. Therefore, segment register values less than 4 bytes from each other point to the same descriptor table entry.

In another approach to this problem, the descriptor table is programmed to zero, which causes a descriptor table limit exception. The operating system then recovers from the exception and calculates the physical address. It takes a significant amount of time, beginning at the exception caused by loading a segment register, to trace back through the various pointers and tables to figure out the value that should be loaded into an 8086 equivalent segment register during a context shift. A descriptor table must

Listing 1: The pseudocode for the 80286 virtual address calculation process.

```
Adding a displacement of 16 bits or less: (offset in DX, displacement in AX)
  Add new displacement to DX.
  If carry-out then
    Move DS into BX.
    Add '0008'x to BX. (Add 1 to index field.)
    Move BX back into DS.
```

```
Adding a displacement of more than 16 bits: (offset in DX, displacement in BX:AX)
  Add new displacement of DX. (DX <- DX + AX)
  Add carry-out to BX.
  Left-shift BX by 3. (Align with index field.)
  Move DS into CX.
  Add CX to BX. (Add displacement high to index field.)
  Move CV back into DS.
```

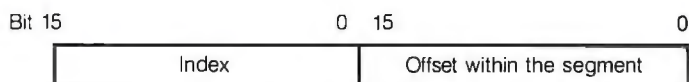

8086 address and 80286 real-mode address formats

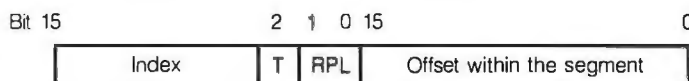

Field:

- Index Index of the segment descriptor within the selected descriptor table specified by the T-bit
- T-bit Table indicator (global versus local address space)
- RPL Requested privilege level (used in the 80286's protection scheme)
- Offset Offset within the specified segment

80286 virtual address format

Figure A: The placement of the T-bit and the permission bits within the address/segment word on the Intel 80286.

then be created with this value as its base. (To allow for any value to be loaded into a segment register, the descriptor table would have to be 64K bytes in size.)

This problem caused programmers to be reluctant to modify existing 8086 code to make it compatible with the 80286. In addition, if the operating system was modified and succeeded in

multiple sector reads/writes, thereby letting the disk access the 128K-byte sector buffer through a local DMA channel or directly through an address port dedicated to the host processor. The RAM buffer also contains DRAM refresh circuitry.

The limitations placed on the RAM buffer are dictated by the software control module, which divides the RAM sector buffer into four blocks. Two of the blocks are designated read/write track size blocks, one for each PDP. This effective-

ly prevents more than two PDPs from being used in the initial PAC 286 system. The third block is used by the verify track size command, while the fourth block is the control block. Each read/write track buffer contains storage for each sector on a track as well as track identification.

The analog board basically performs two functions: PDP receptacle control and actual drive control. All electronics are on the analog board, not inside the drive. This helps keep down the cost of individual PDPs. The analog board com-

ponents include the receptacle motor drivers for loading and unloading the PDPs, an analog multiplexer for selecting RLL-encoded data, a pulse detector with filter and automatic gain control for converting PDP data to digital pulses, a drive position control processor, stepping and spindle motor drivers, and two gate arrays for controlling head movement (track placement and step and direction sequencing). The drive position control processor is interfaced to the system bus via a parallel port used to transfer status

TANDON PAC 286

making programs compatible, address manipulation during context shifts could take hundreds of microseconds or more, compared to tens of microseconds or less for a Motorola 68000-type microprocessor. This factor would slow down the operating system drastically and de-grade system performance.

In protected mode the 80286 protects segments of coresident processes by marking them as execute-only or read-only. The 80286 provides four levels of security (0 to 3), designated by the bits that make up the RPL field within the segment selector words. This system is normally secure, allowing programs to access any segment with a numerically higher (or less secure) privilege level. The real problem occurs when an application tries to execute subroutines that are part of the operating system (normally the highest level of protection). These code segments should be protected from possible damage, but less privileged applications should still be granted access to them.

The mechanism used for this purpose is the descriptor *gate*, a passageway to a more privileged level of code. The gate has a privilege level that is separate from the code segment to which it points. A descriptor gate with a privilege level of 3 can point to a code segment with a privilege level of 0, for example. Thus, a lower-level application can issue a call through the gate and the CPU will alter (raise) that application's privilege level temporarily, while it executes secure operating system code.

When the return instruction is executed, the application's privilege level is once again lowered to its original level. All in all, this is a complicated scheme, and it has not achieved great popularity among software developers.

and commands for drive position control and PDP loading and unloading. The signals from the controller are used by the RAM buffer controller and the data controller (both on the digital board) for translating the commands/status into signals to be sent to the disk drive interface for read/write chain, stepping motor, and spindle motor control. The drive position control processor also monitors the PDP seeking, recalibration, and loading in addition to interrupt sourcing.

When you receive a PDP, it is prefor-

matted and configured with one partition that contains the operating system and utilities.

The Memory Mapper

PDPs are not the only unique hardware in the PAC 286. Tandon engineers also tackled the inability of the Intel 80286 to perform smooth context shifts between protected mode and real mode by developing a memory mapping device (see "The 80286 Problem" at left).

Tandon's engineers have not solved the 80286 protected mode problem, but they have found a way to work around it. In Tandon's scheme, the processor is not intended to run in protected mode at all. This machine can still run programs written for protected mode, but when it is in this mode, the same context-shift problems are still present as in any normal PC AT.

To avoid these problems, the processor is intended to run in real addressing mode all of the time, and the memory mapper/page register chip and the internal DMA registers control the remapping of memory for the three new operating modes—clone mode, mapped-clone mode, and extended mode. The on-chip DMA page registers were added to support DMA operations for the three addressing modes.

The memory mapper/page register chip serves three functions: mapping all addresses generated by the CPU into the physical address space, a DMA/page register mapping function that extends the addressing range of the DMA channels, and an interrupt redirection function for remapping system interrupts. Note that the memory mapper and DMA page register functions are separate and share only the silicon of the chip.

Clone Mode

In clone mode, the machine is like any other PC AT, with one exception. Memory between 640K bytes and 1 megabyte is not normally accessible on a PC AT. Tandon remaps this 384K-byte chunk of RAM, using hardware on the motherboard, so that it always appears above the highest address of any add-on memory present. (This function is not to be confused with the functions of the memory mapper/page register hardware.) The Setup menu checks the amount of RAM present when the machine is configured and reports where this chunk of bonus memory resides.

In clone mode the processor is capable of running protected mode programs, like any other PC AT, with all its attendant problems. All virtual memory address calculation is handled by the processor itself, and no memory mapping of any

continued

**Try It.
Then Buy It.
PC-Write.™**

A fast, full-featured word processing package for only **\$16**. Complete. You get a quick reference guide and tutorial on disk, 45 help screens, choice of function keys or menus, mail merge, spelling check, advanced formatting, and support for over 350 printers including the HP LaserJet Plus.

Try *PC-Write* for only **\$16**. Then register for **\$89** to get:

- o Latest diskette pair
- o Hardbound manual
- o Two updates
- o Phone support
- o Newsletter

Plus, your registration fee supports our development of new *PC-Write* features.

Shareware means you can freely copy and share the *PC-Write* diskette.

Register only if you decide to use it. No risk!

Byte Magazine
May 1987



Version 2.7 Features

50,000 word *Spelling Checker*. Clip text from other screens. supports Laserjet+ fonts. Site Licenses now available to companies and schools.

(This ad was created with *PC-Write*)

**Order *PC-Write* Today.
Satisfaction Guaranteed.**

Quicksort™
(206) 282-0452
310 First St. #224



kind, other than the hardware relocation of the 384K bytes just mentioned, takes place. The DMA registers are configured exactly as they are in an IBM PC AT (see the clone-mode addressing scheme in figure 1).

Mapped-Clone Mode

The PAC 286 powers up in clone mode, with the memory mapper turned off, and then the mapper must be turned on by some software, such as Tandon's memory management software. In this configuration (referred to as mapped-clone mode), the processor is operating in real address mode and has access to a full 16 megabytes of memory through the use of the memory mapper's two groups of 64 mapping registers. The processor has the ability to select either 64-register set when executing a context shift, which greatly speeds up the process (see the mapped-clone addressing scheme in figure 2). One set of registers is dedicated to

the operating system memory map, and the other set is used for the memory map of the current task.

All addresses presented to the DMA controller in this mode are below 1 megabyte and are considered virtual addresses. Processor address bits 14 through 23 are all seen by the mapper hardware. In this mode, if bits 20 through 23 are zero, virtual address translation is necessary. Bits 20 through 23 do not always have to be zero, but if they are not, the mapper is bypassed for that one bus cycle.

Bits 14 through 19 are used by the mapper to select a DMA register, and that DMA register supplies translated address bits 14 through 23. These bits make up the actual physical address derived from the virtual address.

This translation allows the processor, in Intel real address mode with the mapper turned on, to have access to any of 64 16K-byte pages within the full 16 megabytes of physical addresses rather

than the 1 megabyte normally available to the PC AT in Intel real address mode.

DMA Page Registers

The memory mapper chip also contains the DMA page registers used in all three addressing modes. There is no hard logical connection between the memory mapper and the DMA page registers. Either can be enabled independently of the other, depending on the addressing mode desired.

IBM PC ATs employ seven DMA channels. Channels 0 through 3 are 8-bit data channels, channels 5 through 7 are 16-bit data channels, and channel 4 is used to cascade channels 0 through 3 to the microprocessor. These channels normally transfer data in 128K-byte blocks throughout the 16-megabyte address space, but transfers can be any size, limited by the channel's address space of 64K bytes for byte DMAs and 128K bytes for word DMAs.

Each DMA channel normally has a DMA page register associated with it. Clone mode uses one register per channel and decodes it into the I/O location that corresponds to the standard AT register for that particular channel.

In mapped-clone mode the address contained in the DMA page register is translated by the mapper the same way the processor addresses are translated by the mapper. In other words, in mapped-clone mode the page registers contain a virtual address that is translated by the mapper into a physical address, just as a CPU virtual address would be. DMA operations will view memory space the same way that the processor does, allowing DMA transfers to extended memory

continued

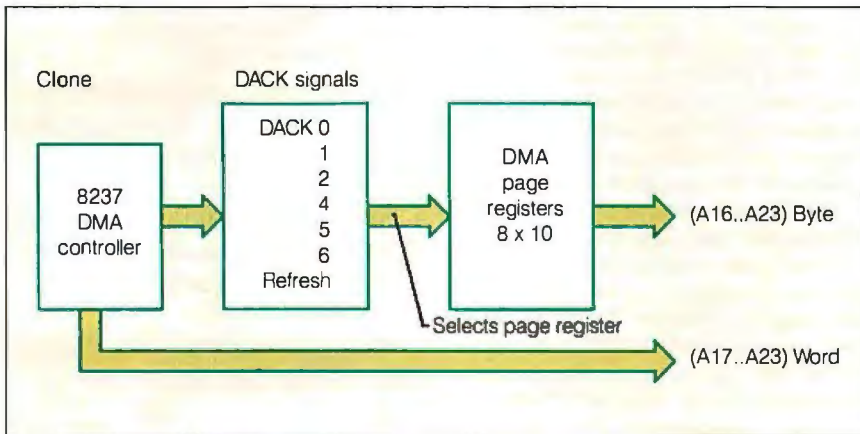

Figure 1: The clone-mode addressing scheme used by the memory mapper circuit.

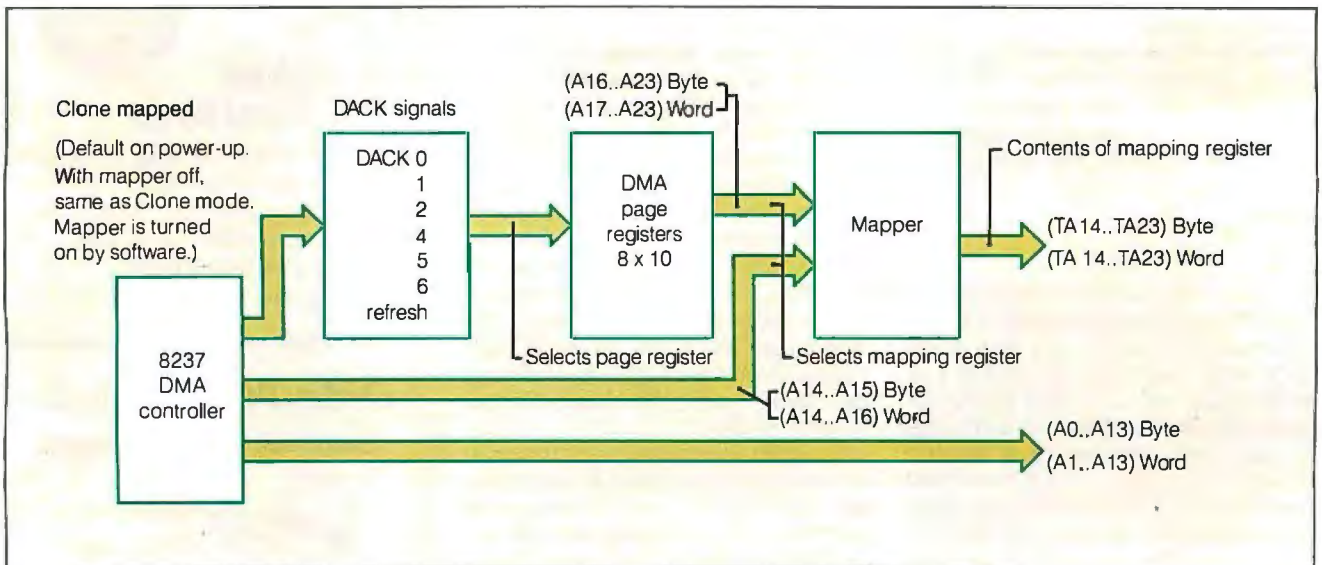

Figure 2: The mapped-clone addressing scheme used by the memory mapper.

The American Success Story:

Once upon a time, America led the world in innovation, quality, engineering, and manufacturing with names like Edison, Ford, and Bell...

Once again America returns:

\$755

Basic system



Basic system 8 MHz CPU with Option A \$1075
Basic system 10 MHz CPU with Option A \$1125

"Low price and blazing speed" ...
Joe Desposito
PC Magazine

FEATURES:

- Maxi switch keyboard/Pro™ keyboard
- 6/8/10 MHz selectable, depends on model
- 1MB of inboard memory (with 512K standard)
- 8 I/O expansion slots
- 195 watt power supply, 110V/220V switchable
- Fully compatible High Speed AMI BIOS
- Full 200 page documentation, operation manual with binder (written in U.S.A.)
- Full one year warranty



RUNS:

NOVELL DBASE
AUTO CAD LOTUS
XENIX SIDEKICK

FREE:

Fully configured and tested for your system requirements

"If imitation is the sincerest form of flattery, the CLUB AT pays the IBM AT a heartfelt compliment. The only failing of the (CLUB AT) is that it imitates the IBM machine too accurately...and you can't beat that..."

Karl Koessel PC World December 1986

EVEREX EVERCOM

"Fully Hayes™ Compatible"

300/1200 BAUD 1200/2400 BAUD

\$128



\$229



300/1200 BAUD, half size/half power, excellent for long distance calls, free BitCom communications software

Option A: 1.2MB Floppy Drive WD HD/Floppy Controller

CLUB 286 Mono system \$1309

- Complete system as described above plus mono display card and IBM quality mono monitor

CLUB 286 Color EGA system \$1740

- Complete system with EGA card & monitor

CLUB 286 Color system \$1500

- High quality
- Complete system as above
- Plus color display card and color monitor
- Fully assembled and tested, no installation required

GRAPHICS BOARDS

MULTIFUNCTION CARD

HARD DISKS TAPE BACKUP SUBSYSTEMS

OTHERS

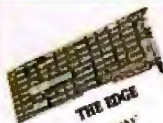

A. \$248



B. \$238

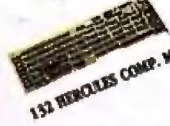

C. \$99



F. EGA \$480

D. MONO \$138



G. \$179

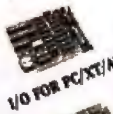

H. \$75



I. CALL



J. \$55

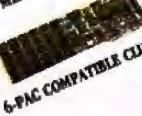

K. \$88

L. FAST HARD DISK FOR AT

20 MB 4026 \$528
30MB 4038 \$599
40 MB 4051 \$628
72 MB (23 MS) \$1095
80MB 4096 \$1195

M. FOR PC UPGRADE TO XT

INTERNAL
20 MB \$365
30 MB \$425
WITH FLOPPY CONTROLLER
ADD \$50 (20MB only)

EXTERNAL TAPE BACKUP SOFTWARE INCLUDED

INT EXT
20 MB \$580 \$680

N. 60 MB \$747 \$827

HARD DISK CONTROLLER

• Data Switch Box \$88
• PC/XT controller \$90
• Floppy controller \$49
• 25 Pin Serial Cable \$18
• Split Power Y-cable \$8
• IBM Type Printer Cable \$15
• IBM AT Bus Extended Card (good for test & debug) \$30
• AT HD/Floppy Controller \$170
• Compaq 286 HD Controller \$188
• PC/XT/HD Floppy Controller \$140
• Optical Mouse \$75 (Microsoft compatible)

SOFTWARE
Graphics DR. HALO \$49
Communications BIT-COM \$49
ADD ON
• Kits for Mini I/O, 2nd Serial Port \$25
• Kits for CLUB 2000, 2nd Serial Port \$25

WEEKLY SPECIALS
One of 3
Toshiba 73 HD \$1099
True Playable VGA \$85
Seagate 20 \$175

CHIPS

64K DRAM
150 ns (9 pcs.) \$9
120 ns (9 pcs.) \$12

256K DRAM
150 ns (9 pcs.) \$27
120 ns (9 pcs.) \$36
100 ns (9 pcs.) \$45

CLUB AT INC.

46707 Fremont Boulevard, Fremont CA 94539

Quality and volume is Our Business

All Sales Call (415) 490-2201
FAX No. 415-490-2687

Now open 7:30-6:30 for your convenience

University P.O.'s are welcome Quantity Discounts are Available
Corporate Buyer call for Neil Mehm Dealers are Welcome
International sales desk now open.

ORDER BY MAIL: Check or Money Order. California add 6.5% tax

ORDER BY PHONE: C.O.D., Cashier Check, VISA (3%).

American Express (4%) or Approved Company P.O.

TERMS: All prices are subject to changes and quantity may be limited and we reserve the Right to Substitute Equivalent Items. Unauthorized Returns are subject to 10% Restocking Fee. Call for RMA Numbers for Returns and Repairs. IBM, Hercules, Bitcom, Xenix are trademarks of the Respective Companies. Limited Warranty. 1 year parts and 6 months Labor. **Inquiry 60**

- A. Parallel port, Hercules compatible, 132 column text, color or mono.
- B. Short card, 256K Video memory, runs color/mono display, 16 colors. 640 x 350 resolution, and with Hercules emulation.
- C. Printer port, monochrome graphics, runs Lotus 123/graphics, 132 x 44 column display.
- D. Nonglare, 12" screen, 800 x 350 resolution.
- E. 640 x 200 resolution, IBM quality.
- F. 640 x 350, 640 x 200, EGA and CGA

- G. Game port, parallel port, 0-2MB memory, runs at 12 MHz, 2 serial ports (2nd optional)
- H. Parallel port, real time clock/calendar, 2 serial ports (2nd optional).
- I. Serial port, parallel port, game port (2nd serial optional), support base and EMS memory, real time clock.
- J. Club 576 (for PC Portable) software, short card, 0-576K memory, supports 64K/256K DRAM.
- K. Club 384 Serial port, parallel port, 0-384K memory, clock/calendar, game port and software.

- L. 39 ms access time, auto head parking, linear voice coil activator, one year limited warranty, cables, AT sliding rail and software included.
- M. 65 ms access time, boots from hard disk, Western Digital controller, manual, cables, hardware and software included, 20/30MB Seagate Hard Disk.
- N. 20 or 60MB backup, menu driven software, backup 5MB per minute, image & file-by-file backup.

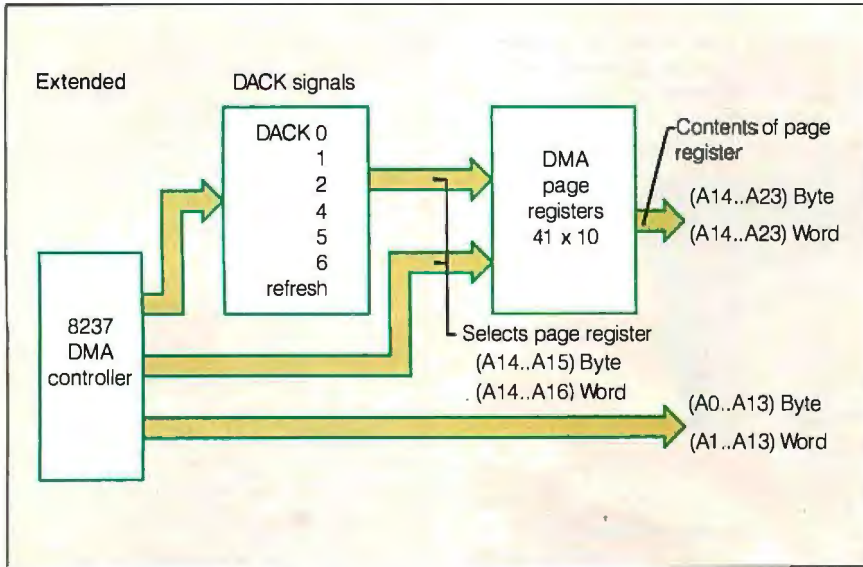

Figure 3: The extended-mode addressing scheme used by the memory mapper.

without having to change the values in the DMA page registers.

DMA Page Register Extended Mode

The DMA page registers can operate in an extended addressing mode. In this mode, 41 10-bit DMA page registers are used, one for each 16K-byte block of addressable memory per channel. Four registers are used for each of the 4-byte DMA channels, eight registers for each of the three Word DMA channels, and one register is dedicated to refresh cycles.

Eight-bit DMA channels (0 through 3) decode address bits 14 and 15 to select one 16K-byte block out of a 64K-byte block of addresses. Sixteen-bit DMA channels (5 through 7) decode address bits 14, 15, and 16 to select one of eight 16K-byte blocks from a 128K-byte block of addresses. Extended-mode addressing allows the DMA controllers to address any 16K-byte block within the total 16-megabyte physical address space (see the extended-mode addressing scheme in figure 3). These extra registers allow DMA operations to the noncontiguous memory space that results from memory mapping operations.

Interrupt Redirection

When the memory mapper is enabled, it watches for the 80286 to read an interrupt vector as a result of a hardware interrupt request. When the mapper detects a hardware interrupt, it disables itself temporarily during the interrupt vector fetch. This assures that all hardware interrupt vector fetches occur from physical page zero of the system rather than from the logical page zero.

Compatibility and Performance

We tested a prototype PAC 286 computer for compatibility and performance. The results of the standard BYTE Sieve and Calculation benchmarks, plus the Savage benchmark, are summarized in table 1.

The prototype machine shows obscured access to expansion slot J5 (see photo 3). Slot J2 contains the video adapter, and slot J4 holds the dual-board disk controller. Therefore, only slots J1 and J3 can be used for memory expansion or accessory boards. Cabling from the disk controller to the disks is not long enough to allow replacement of the disk controller to another slot.

Place in the Sun

The PAC 286's unique disk subsystem solves the data security and portability problems that some people experience in their work. When these disk subsystems become available for existing computers, they may make it possible to treat computers as appliances. ■

Table 1: Benchmark results for the Tandon PAC 286.

	Sieve	Calculation	Savage
IBM PC (BASICA)	191	69	891
IBM PC (QuickBASIC 2.0)	19.4	11.1	479
Tandy 3000 8 MHz (QB 2.0)	8.31	3.72	34.25
Tandon PAC 286 8 MHz (QB 2.0)	8.29	3.16	35.13

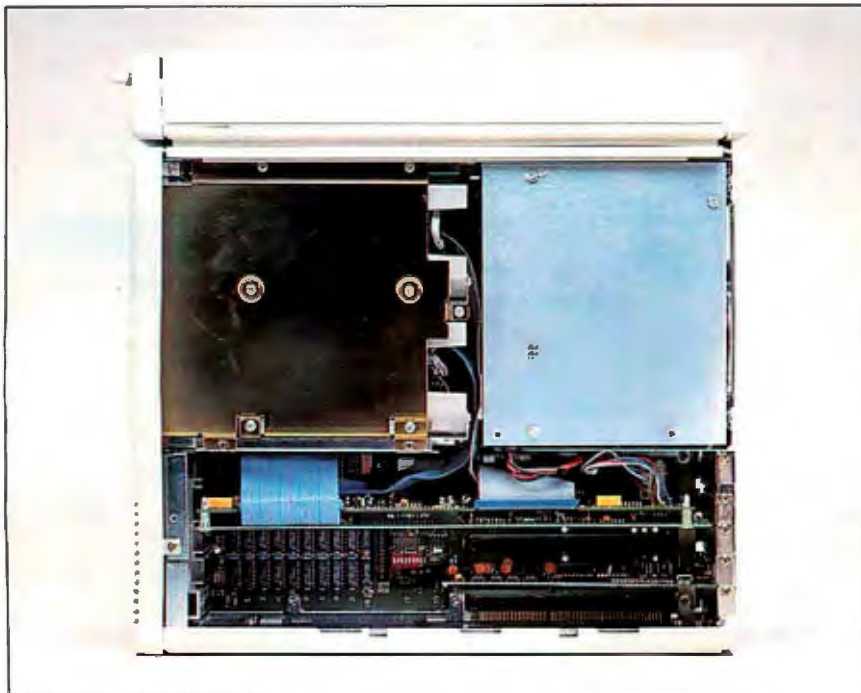

Photo 3: The interior of the PAC 286 system unit.

Softline

PRICE BUSTERS



Software

Word Processing/ Desktop Publishing	
FANCY FONT	\$139
FINAL WORD II	\$239
HARVARD	
PROFESSIONAL PUBLISHER	\$459
MICROSOFT	
WORD 3.0	\$279
MULTIMATE	\$249
MULTIMATE	
ADVANTAGE	\$299
LOTUS MANUSCRIPT	\$359
OFFICE WRITER/ SPELLER 5.0	\$259
PFS: PROF WRITE	\$129
SAMNA WORD IV	\$349
SPELLBINDER DESKTOP PUBLISHER	\$459
TURBO LIGHTNING	\$ 65
VOLKSWRITER 3	\$159
WORD PERFECT 4.2	\$209
WORDSTAR 2000 +	\$289
XYWRITE III	\$199

Database Systems	
CLIPPER	\$ 349
CONDOR III	\$ 339
DBASE III PLUS	\$ 399
FOXBASE +	\$ 299
GENIFER	\$ 219
KMAN 2	\$ 319
PARADOX	\$ 449
PFS: PROF FILE	\$ 149
Q&A	\$ 229
QUICKSILVER	\$ 359
R BASESYSTEM V	\$ 359
RAPIDFILE	\$ 249
REFLEX	\$ 89
REVELATION	\$ 499

Spreadsheets/ Integrated Packages	
ENABLE	\$ 349
FRAMEWORK II	\$ 399
JAVELIN	\$Call
LOTUS 1-2-3	\$ 319
MULTIPLAN	\$ 125
OPEN ACCESS II	\$ 299
PFS: FIRST CHOICE	\$ 109
SMART SYSTEM SPREADSHEET	\$ 439
AUDITOR	\$ 99
SUPERCALC 4	\$ 319
SYMPHONY	\$ 449
VP PLANNER	\$ 59

Communications/ Productivity Tools	
CARBON COPY	\$ 129
CROSSTALK XVI	\$ 99
CROSSTALK MKIV	\$ 139
PROKEY	\$ 85
RELAY GOLD	\$ 159
REMOTE	\$ 109
SMARTERM	\$Call
SMARTCOM II	\$ 99
SUPERKEY	\$ 55

*CALL FOR SHIPPING COSTS

THE INCREDIBLE JACK2 "Electronic Workspace" from PECAN™

Do Wordprocessing, Spreadsheets, Database and Graphics all on one screen at the same time.



Normally priced
at ~~\$99.95~~
NOW **\$9.95**

with purchase over \$1,000.

Graphics	
CHARTMASTER	\$209
CLICKART	\$119
DIAGRAPH	\$309
DIAGRAM MASTER	\$189
ENERGRAPHICS 2.0	\$299
FREELANCE PLUS	\$359
GEM DRAW +	\$189
GRAPHWRITER COMBO	\$349
HARVARD PRESENTATION GRAPHICS	\$239
IN-A-VISION	\$259
MAPMASTER	\$219
MS CHART	\$189
PC DRAW	\$209
PC PAINTBRUSH PLUS	\$109
PICTURE PERFECT	\$245
PRODESIGN II	\$179
SIGNMASTER	\$139
WINDOWS/DRAW	\$119

Statistics	
SPSS/PC+	\$699
STATGRAPHICS	\$469
STATPAC GOLD- WALONICK	\$399
SYSTAT	\$469

Network Applications	
CROSSTALK XVI	\$419
DBASE III LAN PAK	\$599
KMAN 2	\$899
MULTIMATE	\$639
MULTIMATE	
ADVANTAGE	\$749
REVELATION	\$999
WORD PERFECT SERVER	\$309
WORD PERFECT STATION	\$ 75

Desktop Environments	
GEM DESKTOP	\$39
MS WINDOWS	\$65
SIDEKICK	\$59

Project Management	
HARVARD TOTAL PROJECT MANAGER	\$279
MICROSOFT PROJECT	\$249
PROJECT SCHEDULER NETWORK	\$339
SUPERPROJECT PLUS	\$319
TIMELINE 2.0	\$239

Accounting	
BPI	\$ 309
GREAT PLAINS	\$ 499
COMPUTER ASSOC	\$ 399
ONE WRITE PLUS	\$ 159
OPEN SYSTEMS	\$ 409

Languages/Utilities	
APL + V6.0	\$ 389
COPYWRITE	\$ 45
FASTBACK	\$ 89
LATTICE C	\$ 239
MICROSOFT C COMPILER	\$ 289
MS BASIC COMPILER	\$ 249
MS FORTRAN	\$ 229
NORTON UTILITIES	\$ 59
QUICK BASIC	\$ 89
TURBO PASCAL	\$ 89
TURBO PROLOG	\$ 89
XENIX	\$Call

Hardware*

Emulation Boards	
AST 5211-11 +	\$ 649
AST 5251-12	\$ 499
AST BSC	\$ 489
AST SNA	\$ 599
FORTE	\$Call
IRMA	\$ 725
SMART ALEC 5251	\$ 699

Multifunction Boards	
AST ADVANTAGE (128K)	\$ 349
AST 6 PAK PLUS (64K)	\$ 169
AST I/O MINI II	\$ 189
AST PREMIUM PAK	\$ 169
AST RAMPAGE PC	\$ 279
AST RAMPAGE AT	\$ 439
INTEL ABOVEBOARD JRAM AT-3 (OK)	\$Call
JRAM 3 (OK)	\$ 259
JRAM 3 (OK)	\$ 199
PC TURBO 286 (1MB)	\$ 799
PC TINY TURBO 286	\$ 459
QUADBOARD (OK)	\$ 109

Modems	
AST REACH 1200	\$359
HAYES 1200	\$389
HAYES 1200B	\$349
HAYES 2400	\$579
HAYES 2400B	\$549
TRANSNET 1000	\$279
US ROBOTICS 1200B	\$109
US ROBOTICS 2400B	\$189
VENTEL 1200	
HALF CARD	\$389
VENTEL 1200 PLUS	\$299
WATSON	\$339

Display Boards	
ATIEGA WONDER + HERCULES GRAPHICS CARD PLUS	\$279
HERCULES COLOR CARD	\$189
ORCHID TURBO EGA PARADISE AUTO SWITCH EGA	\$159
QUADRAM EGA + SIGMA COLOR 400	\$819
STB EGA PLUS	\$369
TECMAR EGA	\$339
MASTER	\$449
MASTER	\$299
TSENG ULTRA PAK	\$429
TSENG EVA 480	\$399

Mass Storage/Backup	
IOMEGA 10+ 10 W/INTFC	\$1999
IOMEGA 20+ 20 W/INTFC	\$2599
IRWIN 120D 20MB TBU	\$ 469
IRWIN 145AT 40MB TBU	\$ 579
MOUNTAIN DRIVECARD 20MB	\$ 699
PLUS HARDCARD 10MB	\$ 569
PLUS HARDCARD 20MB	\$ 699
PRIAM 42MB AT	\$ Call
SEAGATE 20B W/INT	\$ 389
SYSGEN SMART IMAGE 20MB (INT)	\$ 625
TALLGRASS	\$ Call
TECMAR QIC-60AT TBU (INT)	\$1199

Monitors	
AMDEK 310A	\$159
AMDEK 600/722	\$429/539
NEC MULTISYNC	\$599
PRINCETON HX-12	\$449
PRINCETON MAX-12E	\$179
PRINCETON HX-12E	\$539
PRINCETON HX-9	\$529
SONY MULTISCAN	\$899
TAXAN 122 AMBER	\$159
TAXAN 650 / 760	\$599 / 579

Networks	
AST PC NET	\$Call
ORCHID PC NET	\$Call

Printers/Plotters	
EPSON EX-1000	\$ 619
EPSON FX-85	\$ 399
EPSON FX-286E	\$ 579
EPSON LQ-800	\$ 589
EPSON LQ-1000	\$ 769
HP 7475A	\$1499
NEC 3550	\$ 799
OKIDATA 192 +	\$ 389
OKIDATA 193 +	\$ 569
OKIDATA 292	\$ 539
OKIDATA 293	\$ 689
TOSHIBA P321	\$ 499
TOSHIBA P341E	\$ 769
TOSHIBA P351 MODEL2	\$1199

Input Devices	
KEYTRONICS 5151	\$189
KEYTRONICS 5153	\$299
MICROSOFT MOUSE	\$129
PC MOUSE W PAINT +	\$129

Accessories	
CURTIS RUBY	\$ 65
DATASHIELD S-100	\$ 79
GILTRONIX SWITCHES	\$Call
LOGICAL CONNECTION	\$259
MASTERPIECE PLUS	\$ 135
MICROFAZER II	\$269
256K RAM SET	\$ 39
8087 MATH CHIP	\$119
80287 MATH CHIP	\$189

FREE SHIPPING

on all orders over \$1000.00, credit card orders
and prepaid orders.

Our Policy:

* Visa or Mastercard - add 3% + CGO - Cash, M.O. or bank check only - add
\$5.00 per order * Prepaid personal or company check - allow two weeks to clear
* No sales tax on items shipped until NY State * Shipping via UPS Surface -
add \$3.00 per item UPS Blue - add \$3.00 per item * All returns require prior
authorization * Prices subject to change - call for latest prices



1-800

221-1260

In New York State call (718) 438-6057

Softline

P.O. Box 729, Brooklyn, NY 11230
TELEX: 421047 ATLN UI
FAX: 718-972-8346

MICROWAY ACCELERATES YOUR PC!

FastCACHE-286™

Runs your PC Faster than an AT!
Runs the 80286 at 9 or 12 MHz and the 80287 at 8, 9 or 12 MHz. Includes 8 kbytes of 55ns CACHE



Compatible with Leading Edge Model D, Compaq, and Turbo motherboards. Includes 8088 Reboot Switch, DCache, Print Spooler and Diagnostics... From \$449

LOTUS/INTEL EMS SPECIFICATION BOARDS

MegaPage™ The only EMS board which comes populated with two megabytes of cool-running, low power drain CMOS RAM installed. Includes RAM disk, print spooler, disk cache and EMS drivers. For the IBM PC, XT and compatibles...\$549

Mega Page with 0K..... \$149

MegaPage AT/ECC™ EMS card for the PC AT and compatibles includes Error Correction Circuitry. With ECC, 11 RAM chips cover 256K so the user never encounters RAM errors. Sold populated with 1 megabyte CMOS... \$699 or with 3 megabytes CMOS cool running low power drain RAM... \$1295. Optional serial/parallel daughterboard..... \$95
INTEL, JRAM, or Maynard..... CALL

NUMBER SMASHER/ECM™

Triples the speed of CAE and all applications!

From \$599

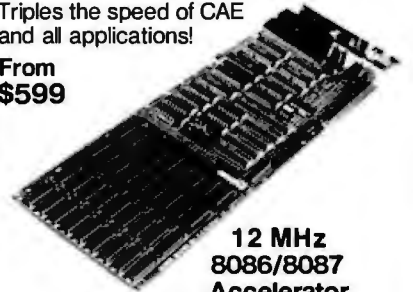

12 MHz
8086/8087
Accelerator
Plus

A Megabyte for DOS!

For the IBM PC, XT and compatibles

PC Magazine "Editor's Choice"

8087 SOFTWARE

IBM BASIC COMPILER..... \$465
MICROSOFT QUICK BASIC..... \$79
87BASIC COMPILER PATCH..... \$150
87BASIC/INLINE..... \$200
IBM MACRO ASSEMBLER..... \$155
MS MACRO ASSEMBLER..... \$99
87MACRO/DEBUG..... \$199
MICROSOFT FORTRAN V4..... \$299
RM FORTRAN..... \$399
LAHEY FORTRAN F77L..... \$477
MS or LATTICE C..... CALL
STSC APL★PLUS/PC..... \$450
STSC STATGRAPHICS..... \$675
SPSS/PC+..... \$695
87SFL Scientific Functions..... \$250
87FFT..... \$200
OBJ → ASM..... \$200
PHOENIX PRODUCTS..... CALL

287 Turbo™-10/12



287Turbo runs the 80287 at 10 or 12 MHz in the IBM PC AT, compatibles and the new Compaq 386 with 100% software compatibility.
10 MHz..... \$450
12 MHz..... \$550

PC Magazine "Editor's Choice"

8087 UPGRADES

All MicroWay 8087s include a one year warranty, complete MicroWay Test Program and installation instructions.

8087 5 MHz..... \$105
For the IBM PC, XT and compatibles

8087-2 8 MHz..... \$154
For Wang, AT&T, DeskPro, NEC, Leading Edge

80287-3 5 MHz..... \$179
For the IBM PC AT and 286 compatibles

80287-6 6 MHz..... \$229
For 8 MHz AT and compatibles

80287-8 8 MHz..... \$259
For the 8 MHz 80286 accelerator cards and Compaq 386

80287-10 10 MHz..... \$395

PC-PAL™ Programmer..... \$395
Call for great prices on V20, V30, 64K, 128K and 256K RAM

AT8™

Turns your AT into a high speed, multi-user Xenix business system!

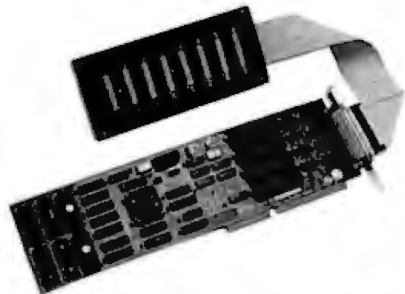

8 port, intelligent serial controller with 3% response degradation. Includes 8 MHz 80186 with built in DMA..... \$1299

MICROWAY SOFTWARE FOR LOTUS 1-2-3™

FASTBREAK™ employs the 8087 to increase the speed of Lotus 1-2-3™ Version 1A or 1A*. Users are reporting speed ups of between 3 and 36 to 1. When run with our NUMBER SMASHER accelerator card, recalculation speed ups of 10 to 30 are being reported..... \$79

PowerDialer® Add-In for Lotus 1-2-3 Release 2. Automated telephone dialing from within 1-2-3. Adds least cost routing, automatic carrier selection and automated phone book worksheet. Builds customized dialing applications. Can be used with DesqView..... \$79

HOTLINK™ adds easy linking of spreadsheets to Lotus 1-2-3 Version 1A.. \$99

287 TURBO-PLUS™

Adjustable 80286 Clock 6-12 MHz

10 MHz 80287 Clock

Plus Full Hardware Reset..... \$149

Optional 80286-10..... \$175

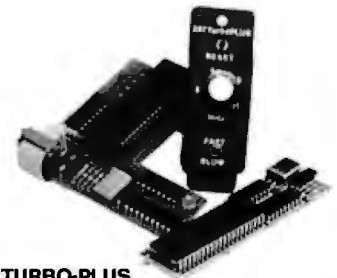

287TURBO-PLUS

With 80287 10 MHz..... \$549

With 80287 12 MHz..... \$629

CALL (617) 746-7341 FOR OUR COMPLETE CATALOG

MicroWay P.O. Box 79
Kingston, Mass.
02364 USA
(617) 746-7341

**You Can
Talk To Us!**

MicroWay Europe
32 High Street
Kingston-Upon-Thames
Surrey England KT1 1HL
Telephone: 01-541-5466

Steve Ciarcia

Part 1: Display/Receiver

Build a Gray-Scale Video Digitizer

An imaging system with remarkable features for the price



Video technology has always interested me. One look at all the monitors, TVs, and displays around my house suggests that it goes deeper than interest.

Freudian views aside, this is not the first time I have covered video technology in a Circuit Cellar project. In previous articles, I have described high- and low-resolution video display systems and even a low-cost digital camera. However, the one project I've always wanted to do has eluded me. Until now, I have had to hold off on the presentation of a cost-effective general-purpose high-performance gray-scale video-digitizing "frame grabber."

I'll explain all this later, but the key terms for the moment are "gray scale" and "frame grabber." Such terms usually indicate commercial units costing thousands of dollars.

While some video digitizers are designed as peripherals for specific computers, virtually all digitizers endent and involve significant trade-offs in performance to maintain low cost. Generally, their digitizing speed is significantly less than the rate necessary to capture a video image as it is transmitted in real time (1/30 to 1/60 second). Instead, they must repeatedly sample many sequential video frames. Digitizers like these—sequential field scanning digitizers—can deal only with stationary objects in front of a camera and can take as long as 30 seconds to scan and record an image. Such digitizers are useless if you are working with moving objects.

Another factor to consider is how a digitizer represents the intensity of each pixel. Most low-cost digitizers meet the minimum video display capabilities of their host computer and digitize each element only as black or white. Some allow a limited gray scale. Higher-performance

digitizers offer 64 or more levels of gray scale as well as a high digitizing speed.

Fortunately, both static memory and video integrated circuit technology have progressed to the point where I can finally offer a project that attempts to meet the level of perfection I have outlined. For the next two months, I will describe a complete digital video system. You can use it independently as a video camera digitizer and display (to implement a video telephone, for example), or you can connect it to any personal computer for tasks like image processing, character recognition, and desktop publishing graphics.

ImageWise consists of two separate boards: a digitizer/transmitter and a display/receiver. Each board can be used independently, or they can be connected to form a complete digitizer/transmitter/receiver system (see photo 1).

In contrast to other digitizers, ImageWise is a true frame grabber that takes only 1/60 second to capture an image. It accepts the video signals from devices like a standard TV camera (either monochrome or color), VCR, laserdisc player, and camcorder, and it then stores the picture as 244 lines of 256 pixels with 64 levels of gray scale—256 by 244 by 6 bits (see photo 2). The ImageWise digitizer/transmitter board converts the stored video image to RS-232 serial data that can be transmitted to any computer or to the ImageWise display/receiver board. Transmission rates are selectable from 300 bits per second up to 57.6k bps.

The ImageWise display/receiver board has a serial RS-232 input and a composite video output. It receives serial data directly from the digitizer/transmitter board or transmitted from a file downloaded from your computer and converts this data back into a picture on a composite video input black-and-white monitor (adding a pair of modems lets you send

the images over telephone lines). The displayed image is an interlaced 256 by 244 by 6-bit gray-scale picture. The following specifications for the display/receiver board sum it up better:

- Resolution: The three selectable resolutions are 256 by 244, 128 by 122, and 64 by 61. All resolutions support 64 levels of gray scale (each picture element is represented by 6 bits). Note that, regardless of resolution, the system displays all pictures as interlaced full-screen images. Lower-resolution images are composed of larger pixel blocks.
- Video output: 75-ohm, 1.5-volt peak-to-peak composite video.
- Serial input: RS-232, 8 bits, 1 stop bit, no parity. Transmission rate is selectable from 300 bps to 28.8k bps.
- Hardware: 8031 microprocessor, Telmos 1852 video D/A converter, 64K bytes of static video RAM.

The specifications of the digitizer/transmitter board are

- Resolution: Same as above.
- Video input: 1-V peak-to-peak, black and white or color, 75-ohm termination.
- Serial output: RS-232, 1 start bit, no parity. Transmission rate is selectable from 300 bps to 57.6k bps.
- Hardware: 8031 microprocessor, RCA CA3306 6-bit flash A/D converter, 64K bytes of static RAM.

continued

Steve Ciarcia (pronounced "see-ARE-see-ah") is an electronics engineer and computer consultant with experience in process control, digital design, nuclear instrumentation, and product development. The author of several books on electronics, he can be reached at P.O. Box 582, Glastonbury, CT 06033.

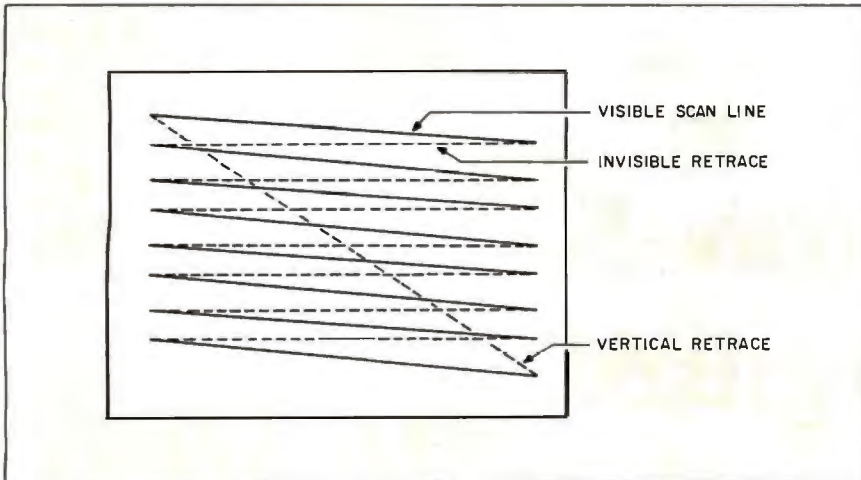

Figure 1: The path of the electron beam during a video scan.

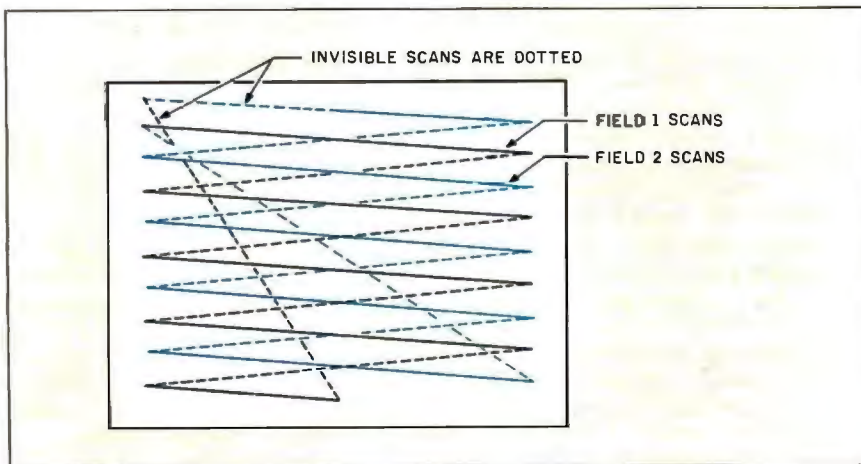

Figure 2: The path of the electron beam for an interlaced video scan.

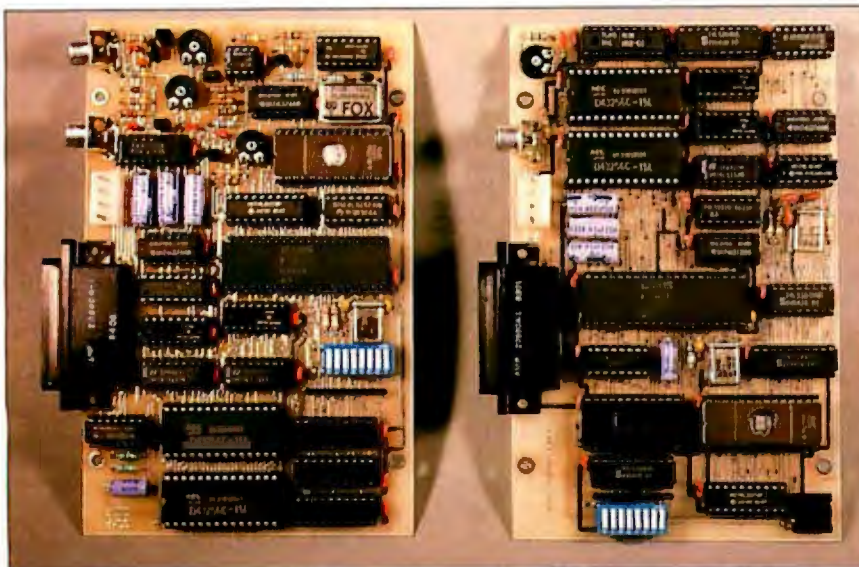

Photo 1: The ImageWise video digitizer system consists of two boards that can be used together or independently. The display/receiver board, shown on the right, reassembles and displays images that are flash-digitized and serially transmitted by the digitizer/transmitter board on the left.

The ImageWise video system is designed to be intelligent as well as functional. You can control many of its features—such as digitizer resolution and picture update—remotely from the receiver or another computer. In addition, the system incorporates various compression techniques, including run-length encoding, to considerably reduce image-transmission time (essential with slow modems).

ImageWise is no small project. Consequently, I will present it in two parts, beginning with the display/receiver section. (If you built the digitizer/transmitter section first, you would have no way of displaying a gray-scale picture other than converting it to a dot-dithered black-and-white-only image on your computer—and what would that prove?) You can check out the receiver using its internal test patterns and by downloading picture files from a computer or my bulletin-board system. It's much easier to verify that the transmitter is sending the correct data after you have a working receiver to show any problems.

Before I delve into the hardware and software, however, I think it's a good idea to review what goes into a "standard" TV signal. With that in mind, it will be easier to see how the ImageWise transmitter digitizes the video and the receiver reconstructs it. As you'll discover, there is a lot more to video than just another pretty picture.

Today's Class: TV Basics 101

Although there may be a few folks tucked away in odd corners of the country who don't have a TV set, I think it's safe to say that everyone who reads BYTE has at least seen a TV picture at one time or another. While most TV is color TV these days, I'll describe only monochrome (black-and-white) TV signals because that's what ImageWise uses. The circuitry required to digitize and reconstruct color TV signals is considerably more complex than seemed reasonable for this project. Fortunately, the color video standards include monochrome as a subset, so we can use color cameras and monitors as well.

Figure 1 shows a simplified diagram of the process used to build an image on a TV monitor. An electron beam is scanned horizontally across the screen, starting from the upper left corner. It is moved downward after each line, and the result is a set of lines scanned left to right and top to bottom filling the screen. After scanning the last line, the beam is returned to the upper left corner to begin scanning the next screen.

The faceplate of the screen is covered with a phosphor that glows when struck

by the electron beam and continues to glow even after the beam passes on. Because the entire screen is scanned rapidly enough to get the beam back to each spot before the phosphor glow fades out, the entire screen seems to be illuminated at once.

One key difference between a TV display and most computer CRT displays is that the electron beam in a TV set can take on a wide variety of intensities, ranging from completely off (black) through shades of gray to completely on (white). A computer display may allow only black, one shade of gray, and white. We'll see what this difference means a little later on. Most composite video input amber or green monitors also have some gray-scale (or should I say green-scale?) capability.

As you might expect, the actual details are a bit more involved. A TV screen is scanned twice for each image, with the two sets of scan lines interlaced on the screen (computer displays are generally noninterlaced). This allows the whole screen to be scanned in half the time a noninterlaced scan would take, without reducing the number of lines in the image. Figure 2 shows how interlaced scanning paints lines on the screen. Each vertical scan is called a *field*, and two matched fields make up a *frame*.

One field is completed in 1/60 second. There are 262.5 lines in each field (see figure 2 to locate the half lines), so each line must be scanned in 63.5 microseconds (1/60 second divided by 262.5). Figure 3 illustrates the signal voltage sent to the display for a single scan line, along with the allowable times for each part of the waveform. (Note: By strict definition, ImageWise is a field rather than frame grabber, since it digitizes only the first 244-line field of an interlaced frame. However, since the term frame grabber has come to mean a digitizer with the

speed to digitize within the time period of a video frame, I shall continue to use the term frame grabber.)

The horizontal sync pulse occurs every 63.5 μs and tells the monitor to end the current line, return to the left edge, and begin another line. Surrounding each sync pulse is a blanking voltage that ensures that the track of the retrace will not be displayed on the screen. After allowing time for retrace and blanking, about 52 μs are left for the actual video picture on the horizontal scan line.

A vertical sync signal tells the monitor

when to end the current field, return to the top of the screen, and begin the next field. Because the two fields in each frame are offset by exactly half a line, the timings at the end of each field are slightly different. Figure 4 diagrams the analog voltage required to display a complete field. To keep the size of the diagram down, only the first and last lines of active video are shown. The horizontal scale is distorted so that you can see the details.

You should note that the horizontal *continued*

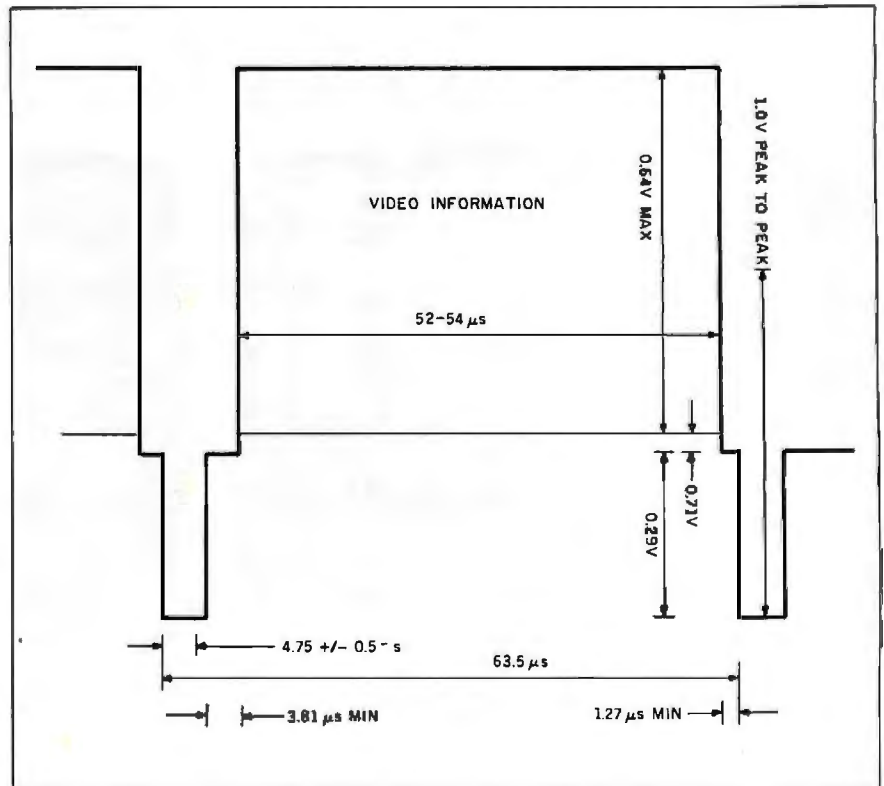

Figure 3: A profile of the signal voltage sent to the display during a single scan line. Note the bracketing 63.5-microsecond horizontal sync pulses.

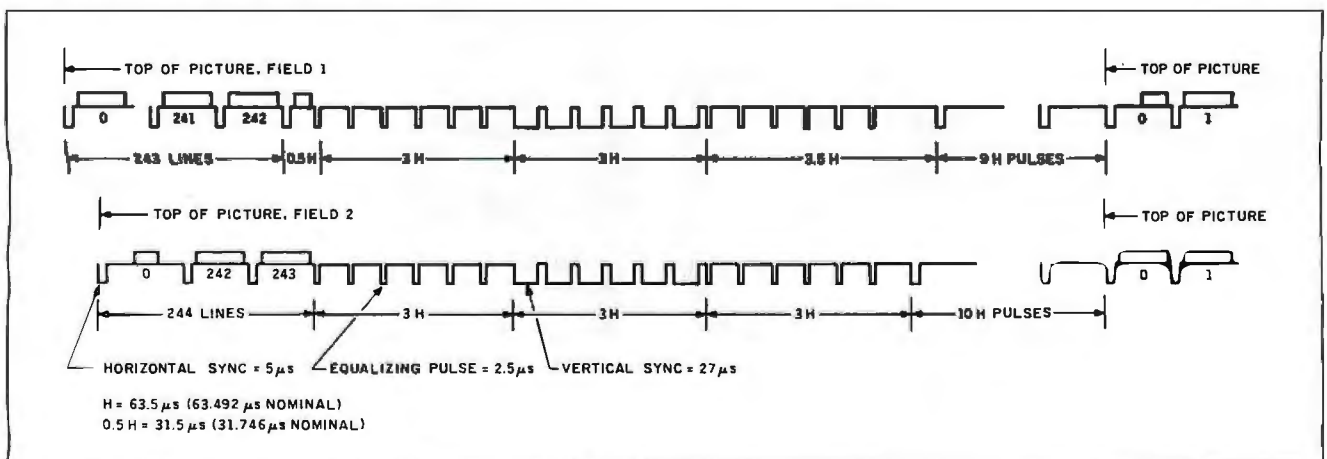

Figure 4: Signal voltage timing diagram for a complete field.

sync pulses do not stop during the vertical sync and retrace. In fact, to make sure that the monitor switches smoothly across the half line, sync pulses occur every $31.75 \mu\text{s}$ during most of the vertical sync period.

A blanking voltage surrounds the vertical sync pulse itself to ensure that the vertical retrace is not visible on the screen. Each field contains 244.5 visible lines, which you can verify by examining the timing diagram in figure 4.

Although video monitors can tolerate small variations in the number of displayed lines or the exact line timings, any errors will be immediately visible as jitter or distorted images. The sync voltages and timings must be exact to ensure a stable picture. The worst offense is to have

timings that vary "just a little" from field to field; this will cause the picture to jitter annoyingly.

Variations on a Theme

Now that you're acquainted with standard video, I can explain some of the basic design criteria for ImageWise. As with any project, there are trade-offs between "the ultimate system" and "the one that got built." I will try to explain why I made the decisions I did.

The most basic question was one of resolution: How many picture elements (pixels) should appear on each line? A single pixel corresponds to the smallest unit of video information handled by the system. Computer monitors typically have 300 to 1000 pixels per line. With

about $50 \mu\text{s}$ available in each line to display those pixels, a 1000-pixel line requires a new pixel every 50 nanoseconds. Since typical dynamic RAMs have a cycle time of 300 ns, allowing a few nanoseconds for the other circuitry would require about eight banks of RAM to ensure that a pixel was ready every 50 ns. Using 50-ns static RAMs, while feasible, would be very expensive.

I decided to look at it the other way: How many pixels will fit on a line with affordable hardware? We find that 32K-byte static RAMs are increasingly affordable, and they are considerably faster than DRAMs. Since even the "slow" ones have a cycle time of about 130 ns, one pixel every 200 ns is reasonable. That allows 256 pixels in $51.2 \mu\text{s}$. Be-



Photo 2: The ImageWise frame-grabber (or "freeze-frame digitizer") captures a video signal in $1/60$ second; fast enough to digitize live TV broadcast signals as easily as those from a stationary camera.



Photo 3: The high-quality gray-scale images of the ImageWise digitizer can be used in security, pattern recognition, a video telephone, and image database applications. (Phone me sometime; I may be looking back at you through the camera.)



Photo 4: Teletransfer of pictures for purposes of identification or verification is a legitimate application for ImageWise. Simply hold the part in front of the camera and transmit the picture to everyone.

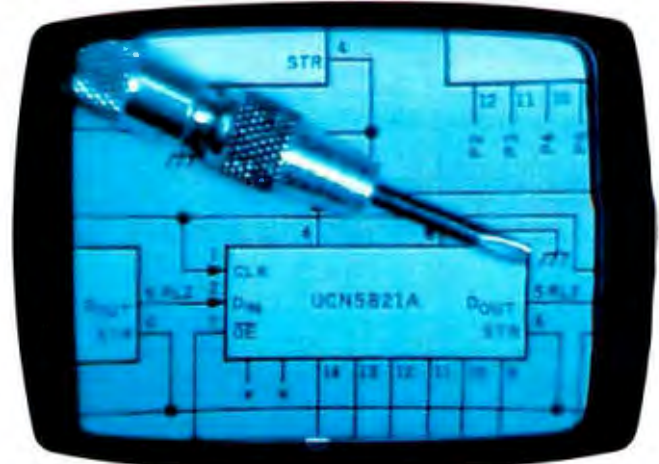

Photo 5: The 6-bit gray scale of ImageWise adds significantly more to the perceptible resolution of an image, whether it be a black-and-white schematic or a silver screwdriver. (The schematic and the screwdriver could not be represented accurately without gray scale.)

cause 256 is a "magic" number, I knew I was on the right track.

As I mentioned earlier, each field has about 244 visible lines. Therefore, a 64K-byte buffer could hold one field with some room left over. Two fields could be contained in 128K bytes. With two fields, however, the vertical resolution (488) is twice the horizontal resolution (256). This seemed excessive. Fortunately, because both fields often contain redundant information, I decided to keep the amount of RAM within reasonable bounds and digitize only a single field. But how would a 256- by 244-pixel picture look compared to the original?

All my experience with 320 by 200 computer displays suggested that I might not like the results and be forced to go back to expensive plan A. However, seeing is believing, so I figured I'd build it and decide then. (Often it is easier and faster to build a prototype and take a look at the results than to argue about what might be.)

Photo 3 shows the quality of the image I got with a 256 by 244 display. (So much for my prior experience with computer displays!) There's a good reason why I was wrong, and if you're as surprised as I was, here's the explanation.

You see jagged diagonal lines or "jaggies" on low-resolution computer displays because each pixel can have only a few levels of brightness. The jaggies can be reduced only by increasing the number of pixels on each line. Depending upon the subject material, resolutions of 640 pixels per line and 350 to 400 lines per screen are required to see noticeable improvement.

But there is another way to reduce the jaggies: If each pixel can take on many levels of brightness, the sharpness of the edges can be reduced. ImageWise uses 6 bits to represent each pixel, allowing 64 shades of gray. Real-world images don't have crisp, computer-generated edges, so each pixel tends to shade into the adjoining ones. The effect is a rather smooth picture that has more "effective" resolution than you'd expect (see photos 4, 5, and 6). This is why pictures shown on color displays that incorporate palette D/A converters often look better. Look closely at a line boundary and see if there is some gradual shading.

As an example, you're probably aware that a standard TV does not make a good computer monitor. Trying to fit more than 40 characters on a line results in an unreadable display. However, newspaper headlines displayed on a TV are easily readable even though the characters are very small, simply because each pixel can take on many brightness levels. Watch your TV carefully and see.

Finally, why does ImageWise use 6 bits per pixel and not more if gray scale is such a good idea? Again, it is a cost trade-off. We have to digitize and determine the gray-scale value of 256 data points in 50 μ s, or one every 200 ns. This requires a fast A/D converter called a flash A/D converter. The price of one is directly related to the number of bits it resolves. Eight-bit models are considerably more expensive than 4- or 6-bit chips. The device I ultimately chose was the RCA 3306 6-bit flash A/D converter, which can operate at 12 million to 16 million samples per second (our sample rate is 5 megahertz). I'll talk more about this next month.

Display/Receiver Hardware

The receiver has two main functions: It accepts data from the RS-232 serial port and displays the resulting picture on a monitor. Figure 5 shows the receiver hardware.

As in many recent Circuit Cellar projects, the receiver uses an Intel 8031 single-chip microprocessor to control the rest of the hardware. A 2764 EPROM stores the 8031's program. An Intel 8254 Programmable Interval Timer (PIT) produces the sync pulses. The video field data is held in a pair of 32K-byte static RAMs and is converted to an analog voltage by a specialized video D/A converter. The MC145406 converts RS-232 voltages into TTL levels for the 8031's serial port.

It was tempting to use the 8031 to produce the sync pulses directly, but a little study showed that there was no way to get the precise timings required for a stable picture. The 8254 is connected to produce repetitive pulses, so the 8031 need only program the appropriate values into

Often it is easier and faster to build a prototype and take a look at the results than to argue about what might be.

the 8254's registers when a change is required. The 8254 uses a 500-ns (2-MHz) clock divided from the 10-MHz crystal oscillator. Figure 6 shows the 8254 pulses for a normal video line.

The Telmos 1852 is a specialized video D/A converter that accepts up to 8 video data bits, a blanking input, and a sync input. The analog output conforms to the standard video specifications. Using this D/A converter eliminates a lot of hardware that would otherwise be required to combine the video, blanking, and sync signals to produce the right output voltage with enough power to drive the monitor. The 8031 ensures that the 2 unused bits (the low-order ones) are always 0.

The 16-bit address required by the 64K-byte field buffer is divided into two parts: a high byte supplied by the 8031 and a low byte that can come from either the 8031 or an 8-bit counter. Normally, the counter steps through the 256 pixels on each line, and the 8031 counts out the lines in the high byte. Both bytes are supplied by the 8031 when it reads or writes buffer data.

A pair of LS244s isolate the field buffer's data bus from the 8031's data bus,

continued



Photo 6: An in/out comparison. The camera is pointed at the magazine in the middle. The monitor on the left displays the image seen by the camera and the digitizer/transmitter. The monitor on the right shows the digitized image received by the display/receiver board.

CIRCUIT CELLAR

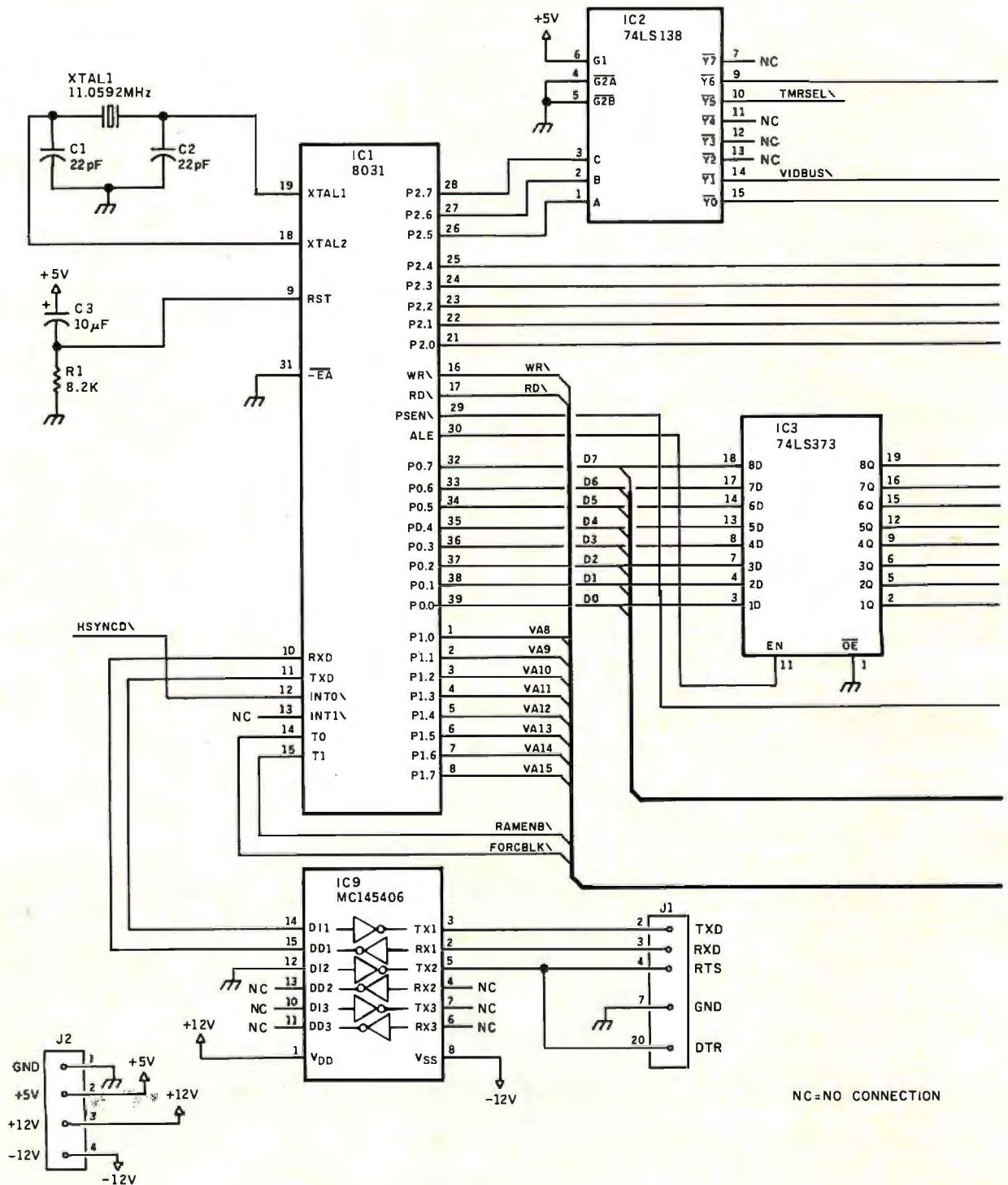
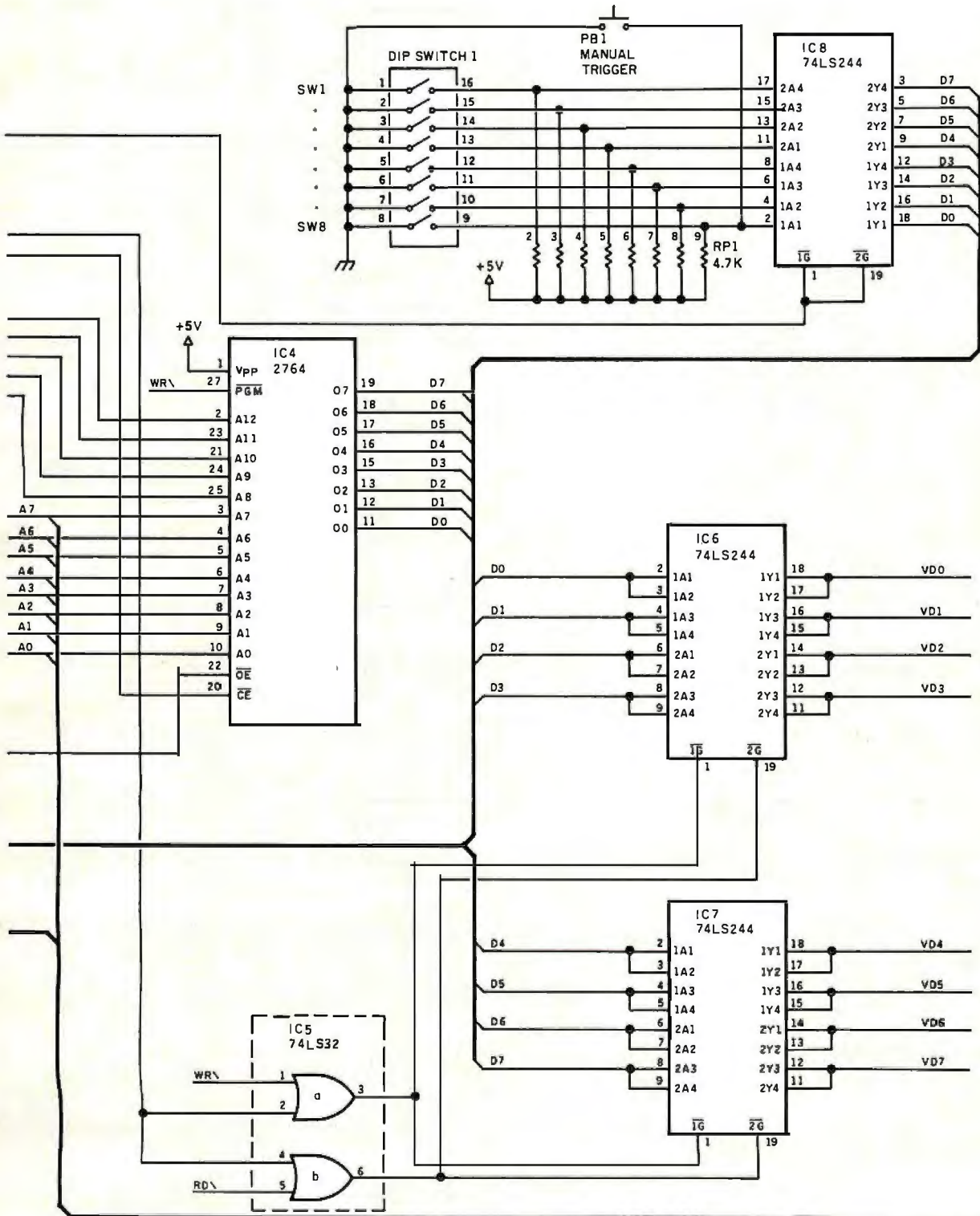

Figure 5: Schematic diagram of the ImageWise display/receiver hardware.

CIRCUIT CELLAR



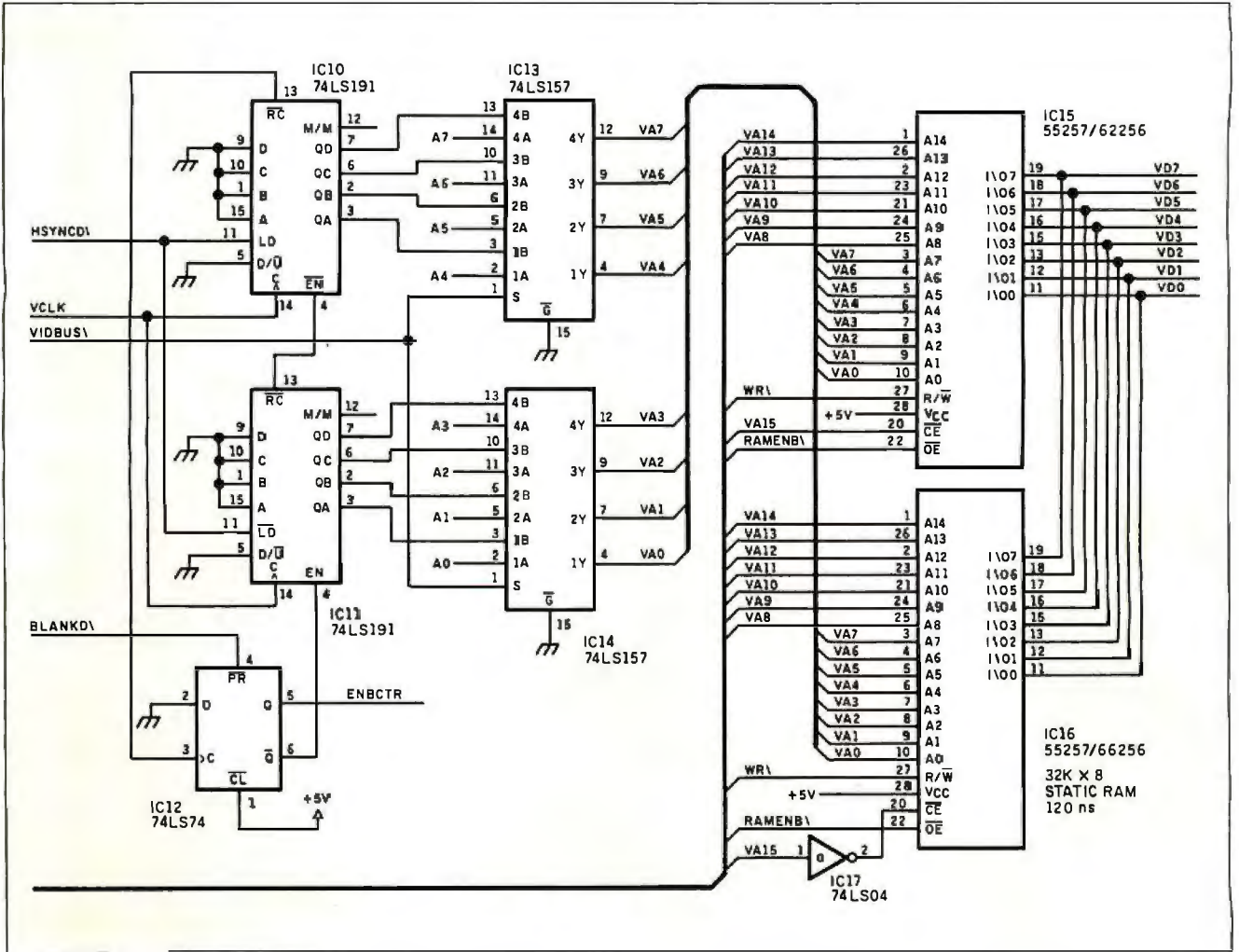

Figure 5: Continued.

except when the 8031 is reading or writing to the buffer. A third LS244 connects the DIP switches to the 8031's data bus. An 11.059-MHz crystal allows the 8031 to receive and generate standard RS-232 bit rates. The video data and sync timings are derived from a separate 10-MHz crystal oscillator circuit.

The divide-by-two counter that produces the video data clock is reset by the horizontal sync pulses from the 8254. This ensures that the pixel clock has the same phase in each line. Without the reset, the clock would alternate phases in successive lines because the length of each line is an odd multiple of the 500-ns clock. Worse, a given line would have a different phase in each frame because the frame length is also an odd multiple of the clock.

Serial Data

Each video field has 256 pixels on each line and 244 lines, for a total of 62,464 pixels (we round the half line up to a full
continued

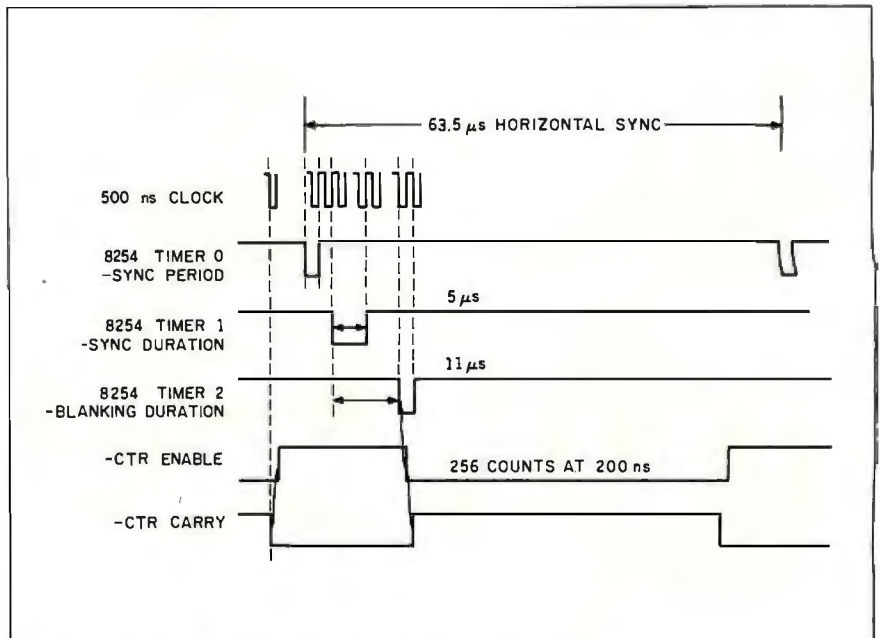

Figure 6: Timing pulses generated by the display/receiver's 8254 PIT.

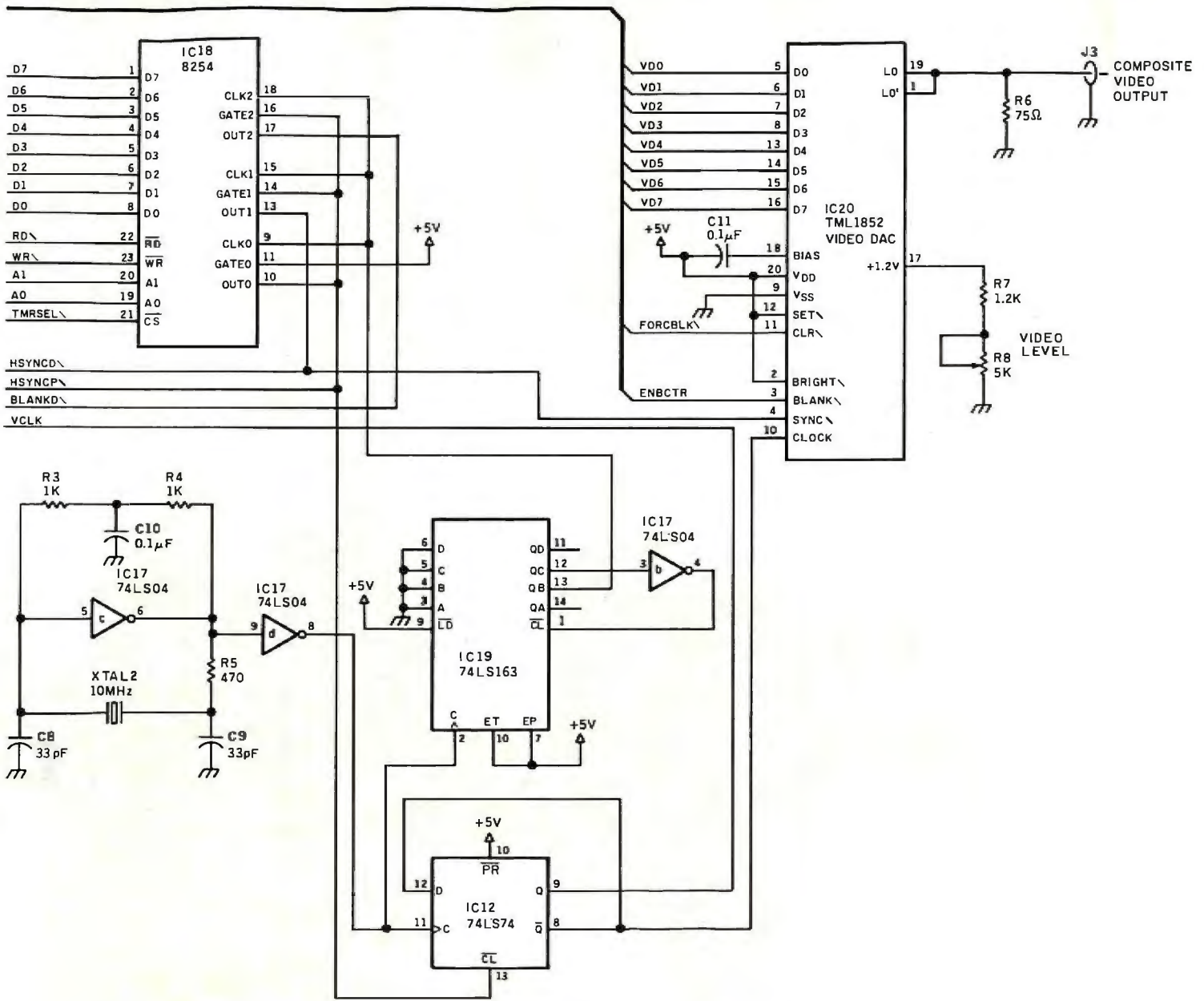

Figure 5: Continued.

line). Each pixel is contained in 1 byte, so there are 62,464 bytes in each field. If you use a serial rate of 3840 bytes per second (38.4k bps), a complete field will take about 16.2 seconds to transmit (it takes 10.8 seconds at 57.6k bps).

Fortunately, ImageWise takes advantage of the fact that most scenes have large areas of the same shade. The digitizer/transmitter (which I'll describe in detail next month) can compress each line of data by representing repeated bytes by a

value and repetition count. In actual practice, the amount of data in a field can be reduced by a factor of two to four, with a corresponding reduction in transmission time.

The serial data format is 8 data bits, 1 start bit, no parity, and 1 stop bit. I did not build error checking into the system because it is intended for relatively short, robust connections. In any event, an error will generally be confined to a single line on the display. Because the video data it-

self has only 6 bits, 2 bits in each byte can be used for control information. Table 1 details the byte encoding used by ImageWise. The 8031 shifts the video data left so that it goes to the high-order 6 bits of the D/A converter.

The receiver puts the bytes into the field buffer as fast as it can, but at the faster rates it's possible for the transmitter to get ahead of the receiver. A circular buffer in the 8031's internal RAM holds up to 48 bytes until they can be processed. If this buffer begins to fill, the receiver sends an XOFF character to tell the transmitter to stop sending data. The receiver will continue transferring bytes from the circular buffer to the frame buffer until the former is nearly empty. Just before the circular buffer runs dry, the receiver sends an XON character to tell the transmitter to resume sending. If the circular buffer does empty completely, the receiver will simply wait for more bytes to show up.

As we'll see next month, the transmitter waits for an XON from the receiver before beginning to send data. The receiver will send the XON sometime after the circular buffer empties, even if it has sent one before. A DIP-switch setting determines the time between emptying the buffer and sending the XON. The choices are continuous pictures, every 4 seconds, every 8 seconds, or manually triggered (see table 2). A push button is used to trigger a new field from the transmitter in manual mode.

The Software

It's worthwhile to describe how the software pulls the receiver hardware together. The two main jobs are maintain-

Table 1: ImageWise serial data encoding. (a) This data flows from the digitizer/transmitter to the display/receiver. (b) This data flows from the display/receiver to the digitizer/transmitter or is sent by a computer connected to the digitizer/transmitter. All other characters are ignored.

(a)								Bit Definition	
Bit number	7	6	5	4	3	2	1	0	
0	0	x	x	x	x	x	x	x	Video data byte
0	1	0	0	0	0	0	0	0	Start of video field
0	1	0	0	0	0	0	0	1	Start of video line
0	1	0	0	0	0	0	1	0	End of video field data
0	1	1	x	x	x	x	x	x	Reserved
1	0	0	0	x	x	x	x	x	Repeat previous byte x times (0 = 16 reps)
1	0	0	1	x	x	x	x	x	Repeat previous byte 16x times (0 = 256 reps)
1	1	x	x	x	x	x	x	x	Reserved

(b)								Bit Definition	
Bit number	7	6	5	4	3	2	1	0	
0	0	0	1	0	0	0	0	1	XON, starts or restarts transmission
0	0	0	1	0	0	0	1	1	XOFF, halts transmission
1	0	0	0	0	0	0	0	0	Use 256 by 244 resolution (full)
1	0	0	0	0	0	0	0	1	Use 128 by 122 resolution (half)
1	0	0	0	0	0	0	1	0	Use 64 by 61 resolution (quarter)

Table 2: Receiver DIP-switch settings. ON and OFF refer to switch positions. (a) SW1, SW2, and SW3 select the serial bit rate (must match transmitter rate). (b) SW4 and SW5 select the time-out interval. (c) SW6 and SW7 select the transmitter resolution. (Note: A manual push button is connected to the SW8 position, so SW8 must be OFF.)

(a)				(b)		
SW1	SW2	SW3	Serial transmission rate (bits/second)	SW4	SW5	Time-out interval
OFF	OFF	OFF	300	OFF	OFF	Continuous pictures, no delay
OFF	OFF	ON	600	OFF	ON	4-second delay between pictures
OFF	ON	OFF	1200	ON	OFF	8-second delay between pictures
OFF	ON	ON	2400	ON	ON	Send picture by manual push-button trigger
ON	OFF	OFF	9600			
ON	OFF	ON	19.2k			
ON	ON	OFF	28.8k			
ON	ON	ON	57.6k			

(c)		
SW6	SW7	Transmitter resolution
OFF	OFF	Full: 256 by 244
OFF	ON	Half: 128 by 122
ON	OFF	Quarter: 64 by 61
ON	ON	Reserved

(Note: 4800 bps intentionally omitted.)

ing stable video sync and accepting bytes from the serial interface. The code is written in assembly language to maximize the performance of the 8031. Figure 7 is a flowchart of the software's major components.

The 8254 PIT generates the precise sync signals for each line, so the 8031 need only reprogram the PIT when a change is needed. Because changes to the 8254's settings take effect with the next

8254 sync output, the 8031 must make the changes one sync pulse before they're actually needed. All timings are determined by counting sync pulses, which are connected to the 8031's INTO interrupt request pin.

The INTO interrupt handler decrements a counter and checks to see if it's 0. If so, an 8254 change is required; otherwise, the handler simply returns to the mainline code. Each change to the 8254

involves writing a few bytes and reloading the counter to tell how many interrupts will pass before the next change.

Each 8031 instruction takes 1 or 2 μ s. At most, only about 50 instructions can be executed per horizontal line. During the vertical retrace interval the sync pulses are only 31.5 μ s apart, giving time for only 20 instructions per sync pulse. The interrupt routine must have enough

continued

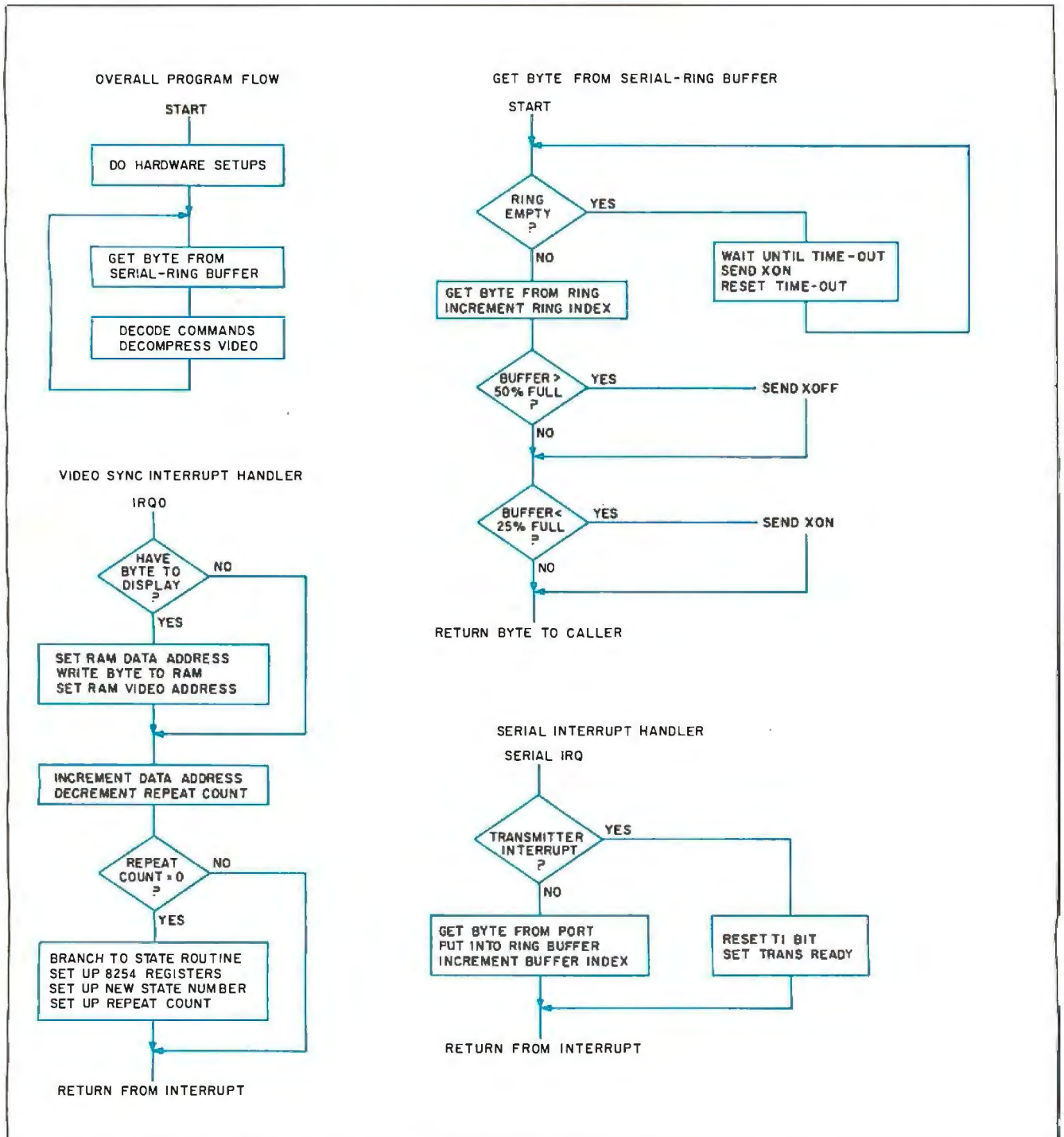

Figure 7: Flowchart for the ImageWise display/receiver system's software.

time to get ready for the 8254 loading during the short sync pulses in the vertical retrace interval, so control is passed to the routine two sync pulses before the change is needed. The interrupt routine then uses a polling loop to detect the last sync pulse.

Another interrupt is generated within the 8031 whenever a byte is received on the serial port. This interrupt awakens the serial interrupt handler routine, which reads the byte from the port and places it in the circular buffer in the 8031's internal RAM. The serial interrupt handler has a lower priority than the sync interrupt; consequently, the serial interrupt handler can be interrupted whenever a sync pulse occurs.

The sync and serial interrupt routines are linked by a background task that simply waits for bytes to show up in the circular buffer. Whenever a byte appears in the buffer, the background task takes it out and decides what to do with it. In most cases, the byte is either video data that should be put in the field buffer or a count that tells how many times the previous data byte should be repeated.

The ordinary way of putting a byte in the field buffer would be to have a subroutine that saves all the registers, sets up the buffer address, does the write, restores the registers, and returns to the caller. Unfortunately, this scheme doesn't work in our application because the writes to the frame buffer have to occur just after the video syncs to reduce sparkles in the display. Additionally, the sync interrupt routine must get control at the same time to reset the 8254. Something has to give!

The solution is to combine the two functions in the video sync interrupt handler. Whenever the background routine has a byte to be written in the buffer, it sets up the registers and turns on a flag bit. The sync routine checks the flag, does the write if it's on, then turns the flag off. The background routine sits in a loop until it sees that the flag has been reset, then continues on its way. Because the background routine has handled all the register setups, the interrupt routine can proceed at full speed and write the byte immediately without saving or restoring any registers.

The possibility arises that the serial interrupt handler will be interrupted by the video sync handler. Because the video sync handler assumes that the registers are set up for it, the serial interrupt handler has to take special precautions to make sure that the wrong byte doesn't get written at the wrong address.

The sync interrupt handler checks the switches once every frame (at the end of the second field) to see if anything's

changed. If so, it drops what it's doing and runs through the power-on initialization routine again. If a picture is being received when you flip the switches, it will get garbled because the serial port will miss a few characters. The rule of thumb is to change switch settings only when nothing else is happening.

Experimenters

While printed circuit boards and kits are available for the ImageWise system, I encourage you to build your own. If you don't mind doing a little work, I will support your efforts as usual. A hexadecimal file of the executable code for the 8031 digitizer and display system EPROMs, sample picture files, and the Turbo Pascal code for storing images on an IBM PC or SB180 are available for downloading from my BBS at (203) 871-1988. Alternatively, you can send me a preformatted IBM PC or SB180 disk with return postage, and I'll put the files on it for you (the hexadecimal file could be used with my serial EPROM programmer, for example). Of course, this free software is limited to noncommercial personal use.

Circuit Cellar Feedback

This month's feedback begins on page 58.

Next Month

Having a gray-scale video display is one thing, but where do you get all the pictures? I'll describe the digitizer/transmitter hardware that captures images from a camera or TV and sends them to either the receiver for immediate display or a computer for storage. ■

Special thanks to Ed Nisley for his expert collaboration on this project.

Editor's Note: Steve often refers to previous Circuit Cellar articles. Most of these past articles are available in book form from BYTE Books, McGraw-Hill Book Company, P.O. Box 400, Hightstown, NJ 08250.

Ciarcia's Circuit Cellar, Volume I covers articles in BYTE from September 1977 through November 1978. *Volume II* covers December 1978 through June 1980. *Volume III* covers July 1980 through December 1981. *Volume IV* covers January 1982 through June 1983. *Volume V* covers July 1983 through December 1984.

The following items are available from

CCI
P.O. Box 428
Tolland, CT 06084
(203) 875-2751

1. ImageWise digitizer/transmitter board experimenter's kit. Contains digitizer/transmitter printed circuit board, 11.05-MHz crys-

tal, programmed 2764 EPROM with transmitter software, and CA3306 flash A/D converter and manual with complete parts list.

DT01-EXP \$99

2. ImageWise display/receiver board experimenter's kit. Contains gray-scale display/receiver printed circuit board, 11.05-MHz crystal, programmed 2764 EPROM with receiver software, Telmos 1852 video D/A converter, manual with complete parts list, and an IBM PC 2.0 disk containing sample digitized images and test patterns.

DR01-EXP \$99

DT01-EXP and DR01-EXP together \$179

3. ImageWise digitizer/transmitter full kit. Contains all digitizer/transmitter components, including printed circuit board, 64K bytes of static RAM, IC sockets, crystals, programmed 2764, CA3306 flash A/D converter, manual, and IBM PC 2.0 disk containing utility routines for storing and displaying (dot-dithered, not gray scale) and downloading image files using an IBM PC. Does not include power supply or case.

DT01-KIT \$249

4. ImageWise display/receiver full kit. Contains all gray-scale display/receiver components, including printed circuit board, 64K bytes of static RAM, IC sockets, crystals, programmed 2764, Telmos 1852 video D/A converter, manual, and an IBM PC 2.0 disk containing sample digitized images and test patterns. Does not include case or power supply.

DR01-KIT \$249

DT01-KIT and DR01-KIT together \$489

While only kits are described above, ImageWise has been licensed for assembly. Call CCI for source and availability of assembled boards and complete systems, black-and-white TV cameras, 32K-byte static RAM chips, and power supplies. Software utilities are also available in SB180 format.

All payments should be made in U.S. dollars by check, money order, MasterCard, or Visa. Surface delivery (U.S. and Canada only): add \$3 for U.S., \$6 for Canada. For delivery to Europe via U.S. airmail, add \$10. Three-day air freight delivery: add \$8 for U.S. (UPS Blue), \$25 for Canada (Purolator overnight), \$45 for Europe (Federal Express), or \$60 for Asia and elsewhere in the world (Federal Express). Shipping costs are the same for one or two units.

There is an on-line Circuit Cellar bulletin board system that supports past and present projects. You are invited to call and exchange ideas and comments with other Circuit Cellar supporters. The 300/1200/2400-bps BBS is on-line 24 hours a day at (203) 871-1988.

To be included on the Circuit Cellar mailing list and receive periodic project updates and support materials, please circle 100 on the Reader Service inquiry card at the back of the magazine.

SMARTMODEM 2400

 Hayes®



CHOOSE THE NAME THAT COMMUNICATES QUALITY.

We'd like to pass along some data on why you should insist on a Hayes Smartmodem 1200™ or Smartmodem 2400.™

First and foremost, no one knows more about building reliable, high performance modems than Hayes. And no wonder. Hayes pioneered the personal computer modem a decade ago, and today is actually the de facto standard in computer communications with the widespread adoption of the Hayes Standard "AT" Command Set.

Second, Hayes has a long-standing and unwavering commitment to customer support, not just to service its products, but to serve as a resource for information, assistance, and technical advice for everyone from the home user to the corporate communications manager. Moreover, Hayes provides more than a warranty on the material and workmanship of its products. Hayes warrants they will perform as promised, as well.

Should you need further data to help you make up your mind, we offer this reassuring statistic: Year after year, more personal computer owners buy far more Hayes modems than any other kind.

And that may be because a Hayes modem is the only modem with the ability to transmit and receive data, and at the same time convey a feeling of peace of mind.

Hayes®

SAY YES TO THE FUTURE



{ SOUP ()
SPLIT PC SOUP = \$3.50
ALPHA NUMERIC SOUP = \$3.50
} Entrees ()
WORD PROSCUITO WITH = \$6.75;
FISHER DILL PIXEL = \$5.95;
BOSTON & RAM CHIPS = \$3.75;
SOFTWARE EGG WITH = \$4.25;
FLOPPY JACKS = \$4.25;
} Desserts ()
DATA NUT BARS = \$1.50;
RASPBERRY PARFAIT = \$2.50;
HOT BUTTERED RUM CAKE = \$2.00;
SPREAD SHEET CAKE = \$1.75;

"C"

TESKE HARRIS ©87

James L. Pinson

Pull-Down Menus in C

Add a user-friendly menu system to almost any IBM PC application



One aspect of commercial software that impresses me is the sharp-looking screen displays: the use of colors, the fast screen updates, and the easy-to-use, pull-down menus. Making a program look good is no substitute for making it perform well, but it certainly can make an impression on the user. With this in mind, when I began studying C, I decided to create a general-purpose, pull-down menu system in C for the IBM PC and its compatibles. I started by examining the pull-down systems I admired and trying to emulate their best features.

My idea of an excellent pull-down menu system is one that appears in a window at the top of the screen. In that window, you make selections by entering a letter that represents an option—the capitalized letter in the option name—or by highlighting options with the cursor-control keys.

If you use the cursor keys, the system will automatically pull down the appropriate menu when you highlight a main menu item to browse through its options. When a pull-down menu is present, you can select one of its options the same way. Pressing Escape puts away the current pull-down box and returns you to the previous highlighted menu level. It also takes you from the top level back to the DOS prompt. The pull-down menus are nondestructive of any text that they overlay; that is, any text underneath a pull-down box is restored when you withdraw the menu.

The BIOS Interface

The BIOS interrupts are one good way of controlling the video output and eliminating the need for external video drivers such as ANSI.SYS. Although the prospect of directly controlling the hardware

is somewhat intimidating, the task itself isn't too difficult. The article "POKEing Around in the IBM PC" by Hugh R. Howson (BYTE, November and December 1983) provided much of the information I needed.

While BIOS interrupts are not part of the standard C language, most versions come with functions that provide the interface. The Lattice C compiler lets you initiate BIOS interrupts with `int86()`. For example, to clear a rectangular area of the screen for a window, you load the registers as in table 1 and issue an `int86()` for interrupt 10 hexadecimal. Listing 1 contains the actual Lattice C code for the `clear_window()` function. Another function, `cls()`, uses `clear_window(1,1,80,25)` to clear the screen.

The windows in my program, PULLDOWN, are constructed by a fairly standard technique. [Editor's note: *PULLDOWN.C is available for the IBM PC and compatibles in Lattice C source code on disk, in print, and on BIX. This program provides the window structure for a pull-down menu system; individual routines for the various functions called from the windows are not included. See the insert card following page 324 for details. Listings are also available on BYTENet. See page 4.*] First, the program calls the function `win_save('s')` to save the screen image. Next, it calls `make_window()`, which actually draws the window, calling `box()` to draw the box and `clear_window()` to clear the area within it. When the window is no longer needed, the program calls `win_save('r')` to restore the previously saved screen image, making the window appear to vanish.

To make these functions work efficiently with the various video cards available, you need to know what type of card you have. The function `what_mon()` returns a 0 if you have a monochrome card

and a 1 if you have a color graphics card. Then PULLDOWN initializes two variables, `nor_attr`, the normal text attribute, and `hi_attr`, the attribute used to highlight menu selections.

Originally, I had used the function `bios_prt`, which uses DOS calls, for all screen writing. As a well-behaved function, it has the advantage of being compatible with future DOS versions and equipment. However, the display was too slow at pulling down menus. You could actually watch the pull-down box being drawn. So I wrote a function, `fast_write`, to write the characters directly to the screen buffer (see listing 2). Unfortunately, this sort of machine-specific code reduces program portability. The base address of the video text area may change with the introduction of new video cards. I believed, however, that the increase in performance justified the sacrifice.

PULLDOWN includes both the `fast_write()` and `bios_prt()` options for screen output. All of the text output to the screen is routed through the function `print(column,row,string)`, which calls either `fast_write()`, the default, or the slower `bios_prt()`. If you include the optional `s` parameter, for example, `pull-down s` runs in slow mode.

The function `fast_write()` calculates the starting point of the text buffer for whichever type of video card is present, monochrome or color graphics. Once you know the base address of the buffer, it is simple to calculate the position of

continued

James L. Pinson is the network coordinator for the College of Business Administration at the University of Georgia (Athens, GA 30602). He has a B.S. in marine biology from Auburn University and develops IBM PC and Apple II software in his spare time.

each screen character. The base address for a color graphics adapter card is B800h; the character appearing in the upper left corner of the display, `display(1,1)`, is located there.

To write directly to the display, you poke the value of a character into the proper address and then poke the appropriate text attribute into the adjacent memory position. In the video text buffer, each even-numbered byte repre-

sents a character position on the screen; the adjoining odd-numbered byte contains that character's attribute. If you are using a CGA card, the program must know which graphics page you are using. The global variables `page`, `attribute`, and `mon__type` provide the information needed for this and other functions.

To make PULLDOWN easy to modify, I used an array of structures to contain the main menu options, the pull-down

options, and the pointers to the functions these options call. As an example of the method I used, if you had a maximum of three options in each pull-down menu, you could create a structure like this:

```

structure menu__str
char *head;
char *body[3];
void(*fun1)();
void(*fun2)();
void(*fun3)();
};
    
```

The main menu option pointer is `head`; `body[3]` is an array of pointers to the pull-down options; and `(*fun1)()`, `(*fun2)()`, and `(*fun3)()` are pointers to the functions called. (I had to list them separately because Lattice C does not allow arrays of function pointers.)

Later in your program, you could assign the structure `menu__str` to the `options[]` array and initialize it (see listing 3). This structure represents the main menu option, File, which pulls down the options Path, Load, and Save. Selecting one of these options calls the appropriate function, `setpath()`, `loadfile()`, or `savefile()`. Further array elements can contain other main menu choices.

A function such as `setpath` may be called with either of two statements: `setpath();` or `(options[1].fun1)();`, which uses a pointer to the function's address rather than its name. Pointers to functions are particularly useful in creating multiple-choice menus.

The Program Flow

The `main()` routine makes calls to identify the type of video card present and sets up the proper text attributes. It defines the menu structure, calls `win__save('s')` to save the current text screen, then passes its address to the `menu()` function. Upon entering `menu()`, PULLDOWN draws the menu window at the top of the screen and prints the options within it, highlighting the first one. The `cur__opt` index points to the first option on the menu. If you touch a letter key, the program scans all the main menu options (`m__menu[i].head[j]`) to see if any of the options contain the same letter in upper case. If one does, then that option is highlighted, and the program calls `pull__down()`. Pressing a left or right arrow key adjusts the index and highlights a new selection. If you touch Enter, the program calls the `pull__down()` function that draws the pull-down menu, and interprets further selections. If you press either Enter or a cursor key, the program determines that you are using the highlighting option and sets the expert variable to 0. When ex-

continued

Table 1: Registers and the contents needed to clear a window on the screen.

Register	Value
AH	6 (scroll page up)
AL	0 (clear specified area)
BH	Attribute used to clear the area (BL unused)
CH	Row of the upper left corner (starts at 0)
CL	Column of the upper left corner (starts at 0)
DH	Row of the lower right corner
DL	Column of the lower right corner

Listing 1: The Lattice C code required to implement the `clear__window()` function defined in table 1. This function clears a rectangular area of the screen to make a window.

```

/* x = column, y = row, width and height = window size */
void clear_window(x,y,width,height)
unsigned int x,y,width,height;
{
extern unsigned int attribute;
struct { unsigned int ax,bx,cx,dx,si,di,ds,es; } regist;
y--;x--; /* DOS treats upper left as 0,0 */
regist.ax = 0x0600;
regist.bx = (attribute<<8);
regist.cx = (y<<8) | x;
regist.dx = (y+height-1) <<8 | x+width-1;
int86(0x10, &regist,&regist);
}
    
```

Listing 2: The `fast__write` function writes directly to the screen buffer.

```

void fast_write(x,y,string)
int x,y;
char *string;
{
extern unsigned int page; /* graphic page used */
extern unsigned int attribute; /* text attribute */
extern unsigned int mon__type; /* monitor type */
int position,offset,orig;
if (page <=3 && page >=0) offset = 4096*page;
orig = offset;
offset=offset+((y-1)*160)+(2*(x-1));
position =0xb800;
if (mon__type ==0) position=0xb000; /* monochrome */
while(*string){
poke(position,offset,string++,1); /* character */
poke(position,offset+1,&attribute,1); /* attribute */
offset=offset+2;
}
}
    
```



O/S ARCHITECTURE: sink with UNIX or soar with QNX.

If the sheer weight of UNIX brings the PC to its knees, all applications running under it will suffer. Conceived more than a decade and a half ago, UNIX is today the result of modifications, additions and patches by hundreds of programmers. It needs the resources of at least an AT.

Compare this to the QNX O/S, designed by a dedicated team with a common purpose and complete understanding of both the software and the environment in which it must run. Having elegantly solved the problem of inter-task communications, QNX is more than capable of both networking and real time performance – the superior choice for process control and office automation systems.

Quick and efficient on a PC, QNX soars on an AT. QNX occupies 70K (stand-alone version) to 104K (network version) of system memory and allows 40 tasks (programs) and up to 10 terminals per computer.

QNX modular architecture facilitates easy adaptation and extensions by software developers for specific requirements. In addition, PC-DOS runs as a single-tasking

guest operating system under QNX. With the DOS Development System, DOS EXE files can be developed in shorter time than under DOS itself.

Communication among all tasks is via "message-passing." Tasks anywhere on a network of up to 255 computers communicate rapidly and transparently with each other.

With the true distributed processing and resource sharing of QNX, all the resources on the network are available to any user. Application programs and data can be distributed over the network without having to go through a central file server.

Network growth is fast and simple. If your disk becomes a bottleneck, add a disk anywhere on the network. If your needs outgrow your present configuration, just add terminals and/or computers as required, without having to re-write programs and without system degradation.

If you would like to know the secret of the QNX architecture, please give us a call. We invite End Users, VAR's, OEM's and Software Developers to discover a whole new world of computing capabilities.

Over 25,000 systems have been installed worldwide since 1982.

Multi-User	10 serial terminals per PC, AT.	C Compiler	Standard Kernighan and Ritchie.
Multi-Tasking	40 (64) tasks per PC (AT).	Flexibility	Single PC, networked PC's, Single PC with terminals, Networked PC's with terminals. No central servers. Full sharing of disks, devices and CPU's.
Networking	2.5 Megabit token ring. 255 PC's and/or AT's per network. 10,000 tasks per network. Thousands of users per network.	PC-DOS	PC-DOS runs as a QNX task.
RealTime	2,800 task switches/sec (AT).	Cost	From US \$450. Runtime pricing available.
Message Passing	Fast intertask communication between tasks on any machine.		

For further information or a free demonstration diskette, please telephone (613) 726-1893.

The only multi-user, multi-tasking, networking, real-time operating system

QNX for the IBM PC, AT,
the HP Vectra PC,
and compatibles.

By Quantum Software.

Quantum Software Systems Ltd., Moodie Drive High Tech Park, 215 Stafford Road, Ottawa, Ontario, Canada K2H 9C1

Unix is a registered trademark of AT & T Bell Labs. IBM PC, AT, XT and PC-DOS are trademarks of IBM Corp.

pert is 0, the program calls pull_down() automatically. Either way, the pointer to the main menu option, cur_opt, and the address of the menu structure, m_menu, are passed to pull_down().

The pull_down() routine must calculate where to draw the pull-down box, based on the index variable, cur_opt, and the length of the main menu options. You can't set the position ahead of time, because this menu system is flexible. All

it has to work with is the structure passed to it, and this will vary according to the application. Once the program knows the box's starting position, it scans the list of pull-down options to find the longest one and sets the box width to that value. The function make_window() draws the pull-down menu box and prints the options within it. It is not a "true" window because text is not automatically confined within its borders, but it looks like one.

The program then waits for you to se-

lect a menu option and puts away the pull-down window with win_save('r') before calling the selected function. Touching Escape will also put away the pull-down window and return to the main menu, setting expert to 1. If you touch Escape when the main menu is active with no pull-down windows showing, the program removes the menu display window from the screen and exits.

Looking Through the Window

PULLDOWN allows you to add a user-friendly menu system to almost any IBM PC application. Due to the widespread use of pull-down menus, most users will find it easy to use and understand. If you like the menu system as it is, simply alter the structure statement to reflect your menu options and their interfaces and add the pull-down menus to your programs.

You can modify this system in many ways. You could add support for a mouse. Or you could have the pull-down box stay put when calling functions. This would be useful if you wanted to create another window for more options next to the current one. The PULLDOWN.C program listing may give you ideas for other functions and interfaces and can serve as a tutorial for implementing them. ■

Listing 3: The structure for the main menu option, File, which provides the options Path, Load, and Save. These options call the functions setpath(), loadfile(), and savefile(), respectively.

```
int setpath();
int loadfile();
int savefile();
static structure menu_str options[N]= {
    "File",
    "Path",
    "Load",
    "Save",
    setpath,
    loadfile,
    savefile,
    /* repeat for each element in main menu */
}
```

DOS Compatible . . .

SOFTWARE CONTROLLED RS232C SWITCH

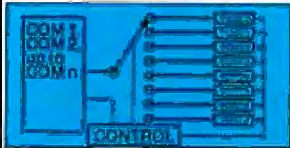

PCSS-8

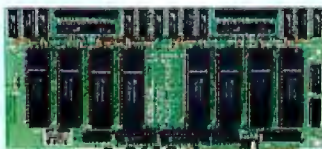

- Select one of 8 RS232C devices from the keyboard
- Use multiple serial devices **without modifying application software**
- May be used for real-time event driven applications
- Works like an eight position A-B switch

The Personal PAL® Developer's Success-kit



MODEL 7344 DEVELOPMENT SYSTEM

- Add PAL® design capability to your IBM PC
- Supports development, functional test, and programming of 20 and 24 pin devices
- PALXASM Compiler included
- Program devices from existing JEDEC files
- A complete solution—programmer, cable, and software

Also available — Personal EPROM systems, OEM programmers, and production programmers/duplicators

DRAWER 1346
BAY ST. LOUIS, MS 39520



ORDER TOLL FREE
1-800-255-GTEK (4835)

GTEK, PALXASM, MS-DOS, PC-DOS, & PAL are registered trademarks

Microsoft
is pleased to
announce that
Microsoft
QuickBASIC 2.0
is second best.



By any measure, Microsoft® QuickBASIC 2.0 was an outstanding success.

We'd taken all the things people loved in the BASICA interpreter, and added a ton of advanced features to make a compiler that was faster and more advanced than any BASIC ever.

A compiler that overwhelmed even the toughest judges:

“A snazzy new programming tool that bridges the gap between earlier BASICs and the high-performance languages like C.” Peter H. Lewis, *The New York Times*, July 15, 1986.

“(Microsoft QuickBASIC) ... represents an outstanding contribution to the microcomputer world.” Dennis Dykstra, *Byte*, February 1987.*

PC Magazine was so impressed, in fact, that they gave Microsoft QuickBASIC their Technical Excellence award. Before long, Microsoft QuickBASIC 2.0 was the most award-winning BASIC compiler ever.

But for us, excellence wasn't good enough.

Introducing Microsoft QuickBASIC 3.0.

We looked for more ways to make BASIC better. Ways to make the programming easier and faster. And then we set to work on what became Microsoft QuickBASIC 3.0.

Our first improvement was in debugging. Our new compiler includes an integrated debugger that is simply unparalleled.

Based on the technology of the famous CodeView™ debugger included with our

C Compiler, it gives you complete control over your program and data. You can observe the contents of any variable. You have your choice of single-step, animate or trace modes.

You can even set dynamic breakpoints at runtime while still using the source for reference. Which lets you easily trace your program's operation without the bother of PRINT statements and recompiling.

This debugger is completely integrated into the compiler. So you can, for example, start debugging your program while it's running by simply pressing CTRL-Break. Instantly, the debugger is activated and you're in control again.

Faster math.

And faster programming.

On PCs equipped with math coprocessors, Microsoft QuickBASIC 3.0 blazes through calculations. Our new in-line 8087 code is as fast as you can get. And that's just the start of the speed advantages.

“Microsoft QuickBASIC is phenomenally fast in compilation... (it) outstrips all other compilers.” Marty Franz, *PC Tech Journal*, December 1986.

Fast compiling is nice, but it's not the most important consideration. Program development time is.

Microsoft QuickBASIC makes your programming substantially faster by integrating a sophisticated editor into the compiler itself.

Any errors found during compilation trigger the editor to take over, putting your cursor right on the

trouble spot.

And if you have more than one error, the editor will keep track of them all, letting you fix your bugs one after another. No more hassles with the endless recompiling of other compilers.

Divide and conquer.

Microsoft QuickBASIC gives you the power of advanced languages without the headaches. A case in point: separate compilation.

Long used in languages like C, separate compilation simply means that you can compile your programs the same way you write them, a piece at a time. Once compiled, your individual modules can be combined into libraries and added to future programs without the bother of recompiling.

But that's just one way Microsoft QuickBASIC supports structured programming.

In addition to the previous Microsoft QuickBASIC extensions like block IF/THEN/ELSE statements, Version 3.0 adds a new set of control structures. Features like the new SELECT CASE, DO WHILE, and DO UNTIL make even the most complex programs amenable to reason.

Still the same. Only better.

After all this work on improvements, we didn't forget what made Microsoft QuickBASIC the success it is. This compiler is still the leader in BASICA compatibility. From graphics to sound, this BASIC commands the PC like no other.

For more Microsoft QuickBASIC advantages, just turn the page.

Introducing Microsoft QuickBASIC 3.0.

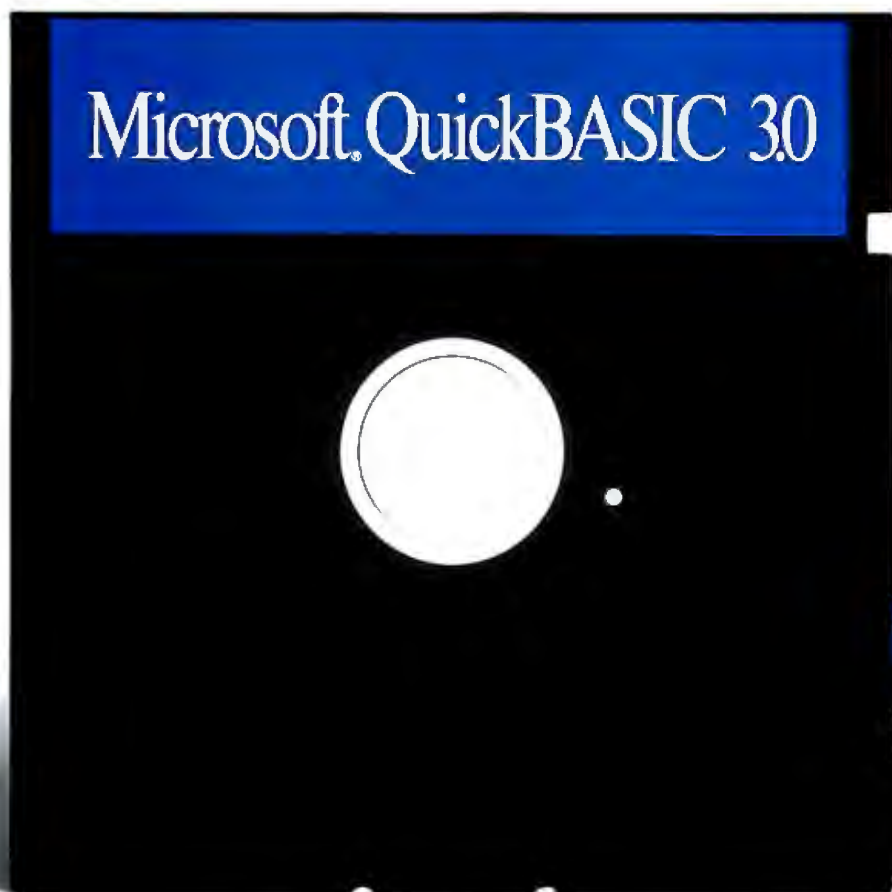

Integrated Program Debugging.

Microsoft QuickBASIC 3.0 includes the most advanced BASIC debugger available. This built-in debugger lets you track both program flow and the contents of variables with ease.

- ◆ Three debugging modes: single-step, trace, and animate.
- ◆ Set, clear, and examine breakpoints. NEW!
- ◆ Adjustable windows let you view source code, variable contents, and program output—all at the same time. NEW!
- ◆ Display and search through source code while debugging. NEW!

Advanced Integrated Editor.

The Microsoft QuickBASIC Editor is integrated with the compiler to make all your programming as fast and efficient as possible.

- ◆ Built-in editor places cursor on problem in source when error occurs in compilation.
- ◆ In contrast to other compilers that give up after finding a single error, Microsoft QuickBASIC's editor keeps track of all errors found during compilation. No more hassles with recompiling over and over.
- ◆ Editor supports both Insert and Overtyping modes. NEW!
- ◆ Fully compatible with SuperKey,[®] ProKey,[™] and SideKick.[®] NEW!

8087 Math Coprocessor Support.

The standard Microsoft QuickBASIC math package has been enhanced to take advantage of numeric coprocessors in machines that have them. Now you have several ways to optimize your program's performance.

- ◆ Microsoft QuickBASIC 3.0 generates fast in-line code for machines equipped with 8087 or 80287 coprocessors. Now your programs can be as fast as the hardware allows. NEW!
- ◆ Microsoft QuickBASIC includes full 80-bit IEEE Math support

for programs that demand the most precise calculations possible. NEW!

- ◆ Choose from the Microsoft Binary Math routines for faster math or the new 8087 software emulation routines for more accuracy when you don't have a coprocessor.

Structured Programming Support.

In addition to the standard BASICA commands, Microsoft QuickBASIC Version 3.0 has a variety of advanced statements and features similar to those found in C and Pascal. By making structured programming easy, Microsoft QuickBASIC makes programs both easier to write and easier to maintain. Older BASIC features like line numbers and GOTO statements are strictly optional.

- ◆ New statements include SELECT CASE, DO WHILE and DO UNTIL, LOOP WHILE and LOOP UNTIL, and EXIT. NEW!
- ◆ Block IF/THEN/ELSE/END IF statements virtually eliminate any need for GOTOs.
- ◆ Subprograms may be called by name and passed parameters.
- ◆ Microsoft QuickBASIC now supports user-defined CONSTANTS. NEW!
- ◆ Both true local and global variables are supported.
- ◆ Microsoft QuickBASIC supports alphanumeric labels as well as line numbers.

Modular Programming Support.

Microsoft QuickBASIC's separate compilation lets you create stand-alone programs a piece at a time. You just compile your routines and add them to a library. Future programs can use those routines by simply linking in your libraries.

- ◆ Create stand-alone programs, with or without a separate run-time package.
- ◆ Link support routines once at beginning of a programming session, then forget about linking.

- ◆ Includes library for access to DOS and BIOS interrupts.
- ◆ Microsoft QuickBASIC makes it easy to use professional support libraries such as Softcraft's Btrieve package.

A compiler with both speed and power.

Microsoft QuickBASIC gives you the most advanced compiler features and debugging possible, without any speed handicaps. Microsoft QuickBASIC 3.0 compiles code up to an astonishing 12,000 lines per minute on an IBM[®] PC/AT.

Microsoft QuickBASIC also supports extra-large programs. Your programs can use all available memory for any mix of code and data. Individual arrays may use up to 64K bytes each (to the PC's limit of 640K).

BASICA Compatibility.

It's not hard to see why Microsoft's QuickBASIC is more compatible with IBM's BASICA than any other compiler. After all, we wrote it for IBM. And we've kept the same features in Version 3.0.

- ◆ Graphics statements include WINDOW, VIEW, DRAW, GET, PUT, LINE, CIRCLE, LOCATE, and SCREEN.
- ◆ Sound statements include SOUND and PLAY.
- ◆ Support for EGA extended graphics modes including the new 43 line mode.
- ◆ Supports standard BASICA structures such as GOSUB/RETURN, WHILE/WEND, and event handling.

Dramatic execution speed enhancements.

Benchmark	Microsoft QuickBASIC 2.0	Microsoft QuickBASIC 3.0
Graphics (500 Circles)	21.42	9.83
Floating Point Math	16.92	6.48
Quick Sort	5.27	3.02

All test results in seconds. Tests were performed on an IBM PC/AT equipped with an 80287 coprocessor and an 8 MHz clock.

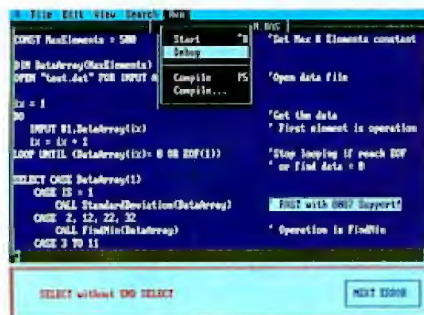

Programming is easier with the built-in editor that searches for all errors, letting you correct them and recompile without leaving the programming environment.

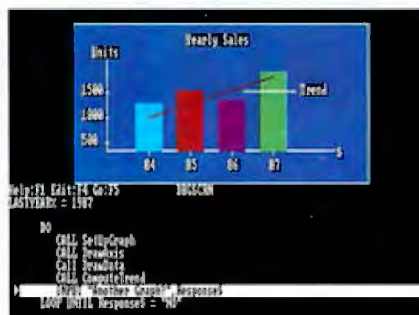

Pinpoint errors by tracing through your source code with the integrated debugger. You can set breakpoints and observe the contents of variables.

Microsoft[®] QuickBASIC

For more information or the name of your nearest Microsoft dealer, call (800) 426-9400. In Washington State and Alaska, call (206) 882-8080. In Canada, call (416) 673-7638.

Microsoft and the Microsoft logo are registered trademarks and CodeView is a trademark of Microsoft Corporation. SuperKey and SideKick are registered trademarks of Borland International, Inc. ProKey is a trademark of RoseSoft. IBM is a registered trademark of International Business Machines Corporation.

Microsoft[®]

Build BERT, the Basic Educational Robot Trainer, Part 2

This month we show how to troubleshoot and program your robot

Last month I introduced you to BERT, a simple, programmable robot made from inexpensive parts (see photo 1). I described how his circuits worked and how to build his circuit boards. Now I'll discuss how to troubleshoot and program your assembled BERT.

After the four main components—base, motor driver board, on-board computer, and speech board—have been built and connected (see photo 2 in part 1), you should have a working BERT. Well, he *should* work. To see if he is fully functional, put him on the floor and press the self-test button. He should perform the routine shown in table 1. If he doesn't perform as expected, you must determine the problem by first isolating it to one of the main components, then referring to that component's schematic and its troubleshooting section.

Motor Check

Testing of the motor driver circuitry is accomplished with some wires and a resistor. These will temporarily substitute for the on-board computer (OBC). First, secure the board to the robot base. Make sure all electrical connections to the motors, both batteries, speaker, sensors, and LED are secure. After this is done, we are ready to begin testing.

Caution! Do not stuff any wire into the connector socket while performing these tests. Doing so will cause the socket's

continued

Karl Brown teaches electronics at Vancouver Community College. His hobbies include computer hardware design and juggling. He can be reached at Vancouver Community College, Electronics Department, 250 West Pender St., Vancouver, British Columbia, Canada V6B 1S9.



Photo 1: BERT has "skin" constructed of acrylic salad bowls.

connector pin spacing to enlarge, making the connector's pins unable to correctly grip the DIP connector.

To check for motor operation, you will need three pieces of wire (approximately 10 centimeters long) and a 510-ohm resistor. Solder one end of the resistor to +5 volts. Then, strip 1 millimeter of insulation off each end of each wire. Now solder one end of each wire to the following points on the solder side of the motor driver board: wire 1 to IC2, pin 12; wire 2 to IC1, pin 11; and wire 3 to IC1, pin 3.

With the above connections made and power from both batteries being fed to the board, temporarily connect the free ends of wires 2 and 3 to ground. Then, connect the free end of wire 1 to the free end of the 510-ohm resistor. Both motors should spin in the reverse direction. If either one turns forward instead of backward, just reverse the connections to that motor's terminals.

When this test is completed, leave the connection between wire 1 and the resistor intact. Now, connect the free ends of wires 2 and 3 to the resistor as well. Both motors should spin in the direction required to move the robot forward. This concludes the motor driver circuitry test. Remove all three wires.

Beeper Test

To test the beeper speaker, simply solder one of the aforementioned wires to the free end of the 510-ohm resistor. Solder the other end of that wire to IC3, pin 9. Now, solder one end of another piece of wire to ground. With your ear right up against the beeper speaker, brush the free end of that wire against IC3, pin 9. You should hear some noise. When you've completed your testing of this circuit, remove the resistor as well as all wires.

Sensor Testing

Sensor testing requires a voltmeter. Connect the negative end of the voltmeter to ground. Connect the other end to the OBC socket (S1), pin 7. You should measure +5 V. Depress the right whisker sensor. You should measure 0.0 V. Perform the same test for the nose and left whisker sensors on pins 6 and 8, respectively, of the same connector (S1).

LED Test

Testing the LED (eye) circuitry is simple. All you do is temporarily ground IC3, pin 11. The LED should illuminate. The circuits involving the sensors, speaker, and eye are very simple. If any of these circuits fail to check out, first check the connections to the batteries, then their voltage level. After that, merely start at the beginning of the circuit (where the test wires are attached) and follow the levels

through the circuit until the break is found.

The motor driver circuits are a bit more complex, but not much. There are actually two circuits, one for each motor. Remember to troubleshoot only one at a time.

Again, check the power connections first. Next, check the inputs to the gates. Find out what logic levels are on the inputs; then, using the truth table for AND gates, figure out what levels should be on the outputs of the gates. With this information, and following the outputs to the bases of all four transistors, write down on the schematic what level should be on the base of each transistor.

At this point you will need a voltmeter. Attach its negative lead to ground. Check the TIP31's emitters. They must measure 0.0 V. Each base that should be high will measure approximately 0.7 V. Each base that should be low will measure less than 0.3 V. If they do not, trace the connections from the base back to its driving gate and check the value of its series resistor.

Some Helpful Hints

When BERT is powered up, the OBC is in a reset state. A power-on reset lasts only 1/10 second. If the reset button is pressed, the reset state will last as long as the button is held down, plus 1/10 second. In either case, as long as the reset state lasts, the motor driver board will cause both motors to turn in the forward direction. In fact, if the motor driver board does not receive signals from the OBC (as is the case during the OBC's reset state), it will always cause both motors to turn in the forward direction. Therefore, if at this stage BERT goes forward and keeps going forward, it is likely that the problem lies with the OBC or the connections between the motor driver board and the OBC.

The beep produced by the speaker is the result of the 6802 microprocessor causing the peripheral interface adapter to toggle one of its outputs (pin 14). If the

beep is not heard, use a logic probe or oscilloscope to check the PIA's pin for a 1/4-second train of pulses. If the train is there, follow the signal along its path to the speaker to find where the circuit is broken. If the pulses are not found at the PIA's pin, there is either a problem on the motor driver board that is holding the pin at a constant level (short to ground or +5 V) or you have a problem with the OBC and must troubleshoot it.

Feedback Problems

When the test button is pressed, pin 6 of the 6802 should go low and the OBC should enter its nonmaskable-interrupt routine. The first thing this routine does is output signals to the motor driver board that cause the motors to spin in a forward direction. These signals are output from the PIA's pins 10, 11, and 12.

Immediately after the test button is pressed, these pins should go high and remain in that state until the robot has gone a distance equal to 50 (decimal) holes from the hole sensor. The actual distance traveled will depend on the size of the wheels. Should these pins not respond as above, there is either a problem on the motor driver board that is holding the pins at a constant level (short to ground or +5 V) or you have a problem with the OBC and must troubleshoot it.

If the signals at these pins do transition, but only briefly, here is the most probable reason: BERT uses feedback from the drivetrain to determine how far he has gone. If he does not have this feedback, he has no way of knowing the distance he has traveled. This feedback comes from the hole-sensor circuit. If BERT fails to stop, look at the output of this circuit.

BERT counts these pulses at PIA pin 18. This input pin is a negative-going, edge-sensitive input. In the self-test mode, BERT will turn the motors on in the forward direction and leave them on until he has counted 50 negative edges (or holes) at PIA pin 18. Should the output of the hole-sensor circuit be faulty, or not arrive at the PIA, BERT will simply keep going.

Noise

There is a very subtle problem which can arise with BERT that relates to the hole-sensor circuit described above. Small DC motors are electrically noisy. This noise manifests itself as large (up to 100 V in amplitude) and narrow (100 nanoseconds to 20 microseconds) voltage transients, or spikes.

These spikes may be large enough to propagate through not only the power leads (from battery to boards), but also

continued

Table 1: BERT's self-test routine.

- Move forward,
- Turn eyes on,
- Speak the word "cookie,"
- Turn left,
- Turn right,
- Left to center,
- Beep once,
- Move backward (to original position),
- Beep once,
- Turn eyes off,
- Perform system initialization (reset).

Programming in BERTL

BERTL is BERT's control language. It is an interpretive language that does syntax checking at program entry time. Table A lists the BERTL commands and their functions.

Each of the commands (except E) requires a parameter. If you command BERT to go forward, for example, he needs to know how far. The entire command would be Fnn, where nn can be any hexadecimal number from 01 to FF (FF hexadecimal equals 255 decimal).

BERTL commands can be downloaded from any serial device with the following characteristics: 300 bps, 7 data bits, 2 stop bits, and no parity. One way to enter BERTL programs into your robot is to write a short program that receives characters from your computer's keyboard and then sends them via the serial port to the robot.

The only drawback to this method is that it is impossible to store the program for future use or to change the robot's program without reentering it entirely. I suggest that the program be edited on a computer using a word processor or text editor and then sent to the robot. This allows you to conveniently edit and store many different BERTL programs.

The Commands in Detail

Here is a description of the BERTL commands:

- Bnn (Backward): This command causes BERT to reverse both wheels. They will continue in reverse until the number of pulses from the feedback circuit equals the parameter. In BERT's case, a value of 32 (hexadecimal) equals approximately 32 centimeters.

- Ccn (Call subroutine): This command causes the conditional execution of a subroutine, depending upon the condition of the on-board sensors. The parameter determines both the condition upon which the subroutine is called and which particular subroutine (out of a possible four) is to be called.

The first digit in the parameter is the condition. If it is 0, the call is unconditional and will be done regardless of the status of the on-board sensors. If it is a hexadecimal number other than 0, the condition of the on-board sensors will be tested to see if they match c. The conditions specified by c are shown in table B.

(Note the logical conditions AND and OR.)

The second digit in the parameter specifies which subroutine will be called. The subroutines are 0, 1, 2, and 3 (see the command N). For the command B12 C00, the robot would go backward 12 cm, then call subroutine 0 regardless of the state of the on-board sensors. For the command F09 C51, the robot will first go forward 9 cm and then, if the nose button is low and both whiskers high, call subroutine 1.

- E (End): This command has no parameter. Upon receiving it, the robot "honks" to indicate that it has received the downloaded program. It waits for you to activate its nose sensor, after which it executes the program. It then waits for its nose sensor to be activated again. This procedure can be repeated indefinitely.

- Fnn (Forward): Turn both motors on in the forward direction. Otherwise, this

continued

Table A: The BERTL command set.

Command	Function
B =	Backward
C =	Call (subroutine, conditional or unconditional)
E =	End program
F =	Forward
G =	Goback (to main routine, unconditional)
H =	Honk
I =	Eye
L =	Left
N =	Name (of subroutine)
O =	Output
P =	Pause
R =	Right
S =	Shoot
T =	Talk (allophone or word)

Table B: Conditions for sensor parameter c. The symbol "&" represents the logical AND, and "+" is the logical OR condition.

Value of c	Logical condition of sensors
0	Don't care (disregard state of sensors)
1	Left low & Nose low & Right high
2	Left low & Nose high & Right low
3	Left low & Nose high & Right high
4	Left high & Nose low & Right low
5	Left high & Nose low & Right high
6	Left high & Nose high & Right low
7	Left high & Nose high & Right high
8	Left low + Nose low + Right low
9	Left low + Nose low + Right low
A	Left low + Nose low + Right high
B	Left low + Nose high + Right high
C	Left high + Nose low + Right low
D	Left high + Nose low + Right high
E	Left high + Nose high + Right low
F	Left high + Nose high + Right high

Table C: Allophones used by the SPO256 chip on the speech board.

00	Delay	10 ms	10	mm	milk	20	aw	out	30	wh	when
01	Delay	30 ms	11	tt1	part	21	dd2	do	31	yy1	yes
02	Delay	50 ms	12	dh1	they	22	gg3	wig	32	ch	church
03	Delay	100 ms	13	iy	see	23	vv	vest	33	er1	letter
04	Delay	200 ms	14	ey	beige	24	gg1	guest	34	er2	bird
05	oy	boy	15	dd1	could	25	sh	ship	35	ow	sew
06	i	sky	16	uw1	to	26	zh	azure	36	dh2	they
07	eh	end	17	ao	aught	27	rr2	brain	37	ss	vest
08	kk3	comb	18	aa.	hot	28	ff	food	38	nn2	no
09	pp	pal	19	yy2	yolk	29	kk2	sky	39	hh2	hoe
0A	jh	dodge	1A	ae	hat	2A	kk1	can't	3A	or	store
0B	nn1	thin	1B	hh1	he	2B	zz	zoo	3B	ar	alarm
0C	ih	sit	1C	bb1	rib	2C	ng	anchor	3C	yr	clear
0D	tt2	two	1D	th	thin	2D	ll	lake	3D	gg2	got
0E	rr1	rural	1E	uh	book	2E	ww	wool	3E	el	saddle
0F	ax	succeed	1F	uw2	food	2F	xr	repair	3F	bb2	business

command is identical to B.

- **G00 (Goback):** Go back to main routine. This command must be placed at the end of each subroutine. Its parameter is always 00.

- **Hnn (Honk):** Cause the robot's speaker to honk (beep) *nn* times, where *nn* is a hexadecimal number from 00 to FF. Note that all other robot activity will cease during the honk. The honk duration is 0.52 second.

- **lnn (Eye):** Turn the robot's lights on or off. If the parameter is 00, the lights will turn off. Any other value turns the lights on.

- **Lnn (Left):** This command causes the robot to pivot on its axis (the imaginary point between the drive wheels) in a counterclockwise (when viewed from above) direction. This is done by moving the left wheel in a forward direction while moving the right wheel in reverse. This motion continues until the feedback circuit outputs enough pulses to equal the parameter.

- **N00, N01, N02, N03 (Name of subroutine):** BERTL allows four subroutines. Each may be called unconditionally or only when the on-board sensors match a specific condition (see the command C). The format of a subroutine is as follows: name, commands, goback.

For the subroutine N00 F60 H02 B60 G00, the robot will go forward 60 cm, honk twice, go backward 60 cm, and then return to the main program.

- **Onn (Output):** If the parameter is 00, the output of the 1-bit OBC port will switch to a logic low. If the parameter is any other value, the output level of the port will be a logic high. The port will support two TTL logic loads and therefore may need buffering if it is used to switch higher-current loads.

- **Pnn (Pause):** This command causes the robot to pause (do nothing) for the decimal equivalent of the number of seconds specified in hexadecimal in the parameter. For example, the command P3C would cause the robot to pause for 60 seconds.

- **Rnn (Right):** Turn right (or, to be more specific, cause the robot to pivot in a clockwise direction). Otherwise, the command is identical to Lnn.

- **Snn (Shoot):** This is a light and sound effect. It causes the LED to light up and the speaker to produce a "phaser" sound. Otherwise, it is the same as Hnn.

- **Tnn (Talk):** This command is used to control the optional speech board. If the speech board is not used on the robot, the OBC's CA2 output must be connected to the CA1 line. If this is not

done, the robot will "hang" whenever this command is used.

BERT's speech chip is the General Instrument SPO256-AL2. This chip has specific sounds (allophones) stored in it. When strung together, these sounds simulate human speech. The parameter for this command is any hexadecimal number from 00 to 7B.

There are a total of 63 allophones and 63 words available to the BERTL programmer. Note that the speech chip continues to make the last portion of the last allophone it was commanded to emit. You can clear its throat by using 00 (silence) as the last sound emitted.

The command string T09 T2D T13 T2B T00 uses allophones to make the robot say the word "please." This can also be accomplished with the command T67, a command that uses BERT's pre-programmed 63-word vocabulary. Each word is represented by a number in the range of 40 to 7B hexadecimal. (See table C for the allophones and table D for BERT's vocabulary.)

Syntax Checking

When BERT receives commands via his serial port, he checks each one for syntax and validity. If bad syntax or an invalid command is detected, BERT will honk and light up his eye. If this happens, reset the robot and check your program for errors (a favorite error is typing o instead of 0).

Table D: *BERT's preprogrammed vocabulary. Each word is automatically terminated by the allophone "PA5" (04).*

40 ; ZERO	4F ; CAN	5E ; LIKE	6D ; START
41 ; ONE	50 ; CHECK	5F ; LITTLE	6E ; STOP
42 ; TWO	51 ; COMPUTER	60 ; ME	6F ; SORRY
43 ; THREE	52 ; COOKIE	61 ; MEMORY	70 ; SWITCH
44 ; FOUR	53 ; CORRECT	62 ; MOMMY	71 ; TALK
45 ; FIVE	54 ; DATE	63 ; NO	72 ; TEA
46 ; SIX	55 ; DO	64 ; NOT	73 ; THANK
47 ; SEVEN	56 ; EDUCATIONAL	65 ; OFF	74 ; TRAINER
48 ; EIGHT	57 ; EMERGENCY	66 ; ON	75 ; YES
49 ; NINE	58 ; ENTER	67 ; PLEASE	76 ; YOU (U)
4A ; ALARM	59 ; ERROR	68 ; READY	77 ; ALERT
4B ; ARE	5A ; ESCAPE	69 ; ROBOT	78 ; LEFT
4C ; BASIC	5B ; EYE (I)	6A ; ROBOTS	79 ; RIGHT
4D ; BE	5C ; HELLO	6B ; SEE (C)	7A ; WANT
4E ; BERT	5D ; IS	6C ; SPEAK	7B ; SILENCE

The BERTL language is also tolerant of the following characters: space, carriage return, and linefeed. While an error beep will not result from the preceding ASCII characters, nothing else will happen either. However, these characters must not come between the hexadecimal digits. For example, F44 L22H01 B 17 E would be acceptable, whereas, F44 L22H01 B1 7 E would not. (In this example, the robot would go forward, turn left, honk once, and go backward.)

I recommend that you make judicious use of subroutines to reduce your program's memory requirements. If something has to be done two or more times, use a subroutine. But bear in mind that no subroutine can call another subroutine. This is impossible due to the severely limited stack space of the OBC.

Should you decide to use a word processing program to enter, edit, and transmit a BERTL program, be careful. A lot of word processors embed non-printing characters (ASCII codes above 127 hexadecimal) in the text for their own purposes. If you are using WordStar, for example, always create and edit BERTL programs using the nondocument command. When "printing" your program to the robot, suppress page formatting.

The program shown in listing A will cause BERT to beep and say "hello." Following that, he will jog forward, stop and check his sensors, and then take appropriate action if any one of the sensors

Listing A: *A sample BERTL program. Note: Do not try to enter the comments into BERT.*

```
H01 T5C ; HONK ONCE & SAY "HELLO".
F0F ; GO FORWARD 15 UNITS, THEN
C30 ; IF SENSOR CONDITION "3" IS MET,
; CALL SUBROUTINE NAME0.
C51 ; IF SENSOR CONDITION "5" IS MET,
; CALL SUBROUTINE NAME "1".
C62 ; IF SENSOR CONDITION "6" IS MET,
; CALL SUBROUTINE NAME "2".
F0F C30 C51 C62 ; DO THE SAME THING AGAIN
F0F C30 C51 C62 ; AND AGAIN
F0F C30 C51 C62 ; AND AGAIN
N00 ; SUBROUTINE NAME "0" STARTS HERE.
T79 ; SAY "RIGHT", THEN
R09 G00 ; TURN RIGHT AND GOBACK TO MAIN
; PROGRAM.
N01 ; SUBROUTINE NAME "1" STARTS HERE.
T4A ; SAY "ALARM", THEN
B10 R06 G00 ; BACKUP 16 UNITS, TURN RIGHT AND
; GOBACK TO MAIN PROGRAM.
02 ; SUBROUTINE NAME "2" STARTS HERE.
T78 ; SAY "LEFT", THEN
L06 G00 ; TURN LEFT AND GOBACK TO MAIN
; PROGRAM.
E ; END OF PROGRAM.
```

is activated (low). If no sensor is activated (by bumping into some object), BERT will again go forward, stop, and check his sensors. If no sensors are activated throughout his journey, BERT will jog forward a total of four times, then finally stop and wait for either his nose or reset button to be pressed.

The appropriate action to be taken if a sensor is low depends upon which sensor is low. If the nose sensor is activated (by bumping into a wall, for example), then the subroutine N01 will be called. This subroutine will cause BERT to say "sorry," then back up, turn to the right, and return to the main program.

through the air, as radio frequency energy. This RF interference can be picked up by any antenna in the vicinity, even the piece of wire connecting the hole sensor to the PIA. The PIA interprets these spikes as hole transitions and soon counts enough of them to satisfy the command parameter. BERT thinks he has traveled the required distance when, in reality, he has moved a short distance, or not at all.

If this noise causes problems for your robot, you might consider using shielded cable from the hole-sensor circuit to the connector on the motor driver board. If

the problem persists, try increasing the size of filter capacitor C3 on the motor driver board.

If the LED does not illuminate at this point, check for pin 13 of the PIA going low. If it does not, your problem is likely the OBC. If it does go low and the LED refuses to illuminate, follow the signal from the PIA to the LED to find the circuit break.

If BERT has operated well up to this point, but has failed to turn, it is not likely that the problem is with the OBC. The guilty party is probably the motor driver board. To prove this, check the PIA's pin

12 at the precise time in the self-test when BERT is supposed to be turning left. Pin 12 should be low. Follow this signal through to the motor driver board. If it arrives there, you have isolated the trouble to the motor driver board.

If BERT fails to turn right, the PIA pin to look for is pin 11. It should be low. To cause the motors to spin in a reverse direction, PIA pins 11 and 12 should be low, while pin 10 is high. If this is the case, but the motors do not reverse, follow these signals to the motor driver board. If they arrive there, the problem is in the board. If BERT successfully completes all the above movements but fails at one of the self-test points, you probably have an intermittent connection. Check your wiring and soldering.



Photo 2: The results of a BERT construction class at Vancouver Community College.

Speech Board

Attempting the self-test without the speech board could get you into trouble as well. Since the OBC waits for the SBY signal from the speech board, it could wait forever (doing nothing else but waiting). To allow BERT to do the self-test without the speech board, short pins 39 and 40 of the PIA together.

If the speech board said "ready" when BERT was first powered up, but did not say "cookie" at this point, the most likely problem is an intermittent connection between the OBC and the speech board. Check all wiring.

The speech board produces sound in response to numbers sent by the OBC. These numbers are loaded into the speech board via a low-going pulse output at the PIA's pin 39. Using a logic probe or oscilloscope, check for this pulse at the PIA, then follow it to see if it actually gets to pin 20 of the SPO256 speech chip.

To tell the OBC that it is ready to receive another number, the SPO256 outputs a low-going pulse on its pin 8. If this pulse is not output by the SPO256, check the power on the speech board (it should be +5 V). If power is okay, check all solder connections and look for bent IC pins. If this pulse is output by the SPO256, you must make sure that it gets to the PIA's pin 40.

If all these handshaking signals come from and go to where they are supposed to, odds are that the SPO256 is working and the problem is in the LM386 audio-amplifier circuit.

Customizing

If you wish to modify BERT, please do. Any robot is only a beginning. Having built it yourself, you are the person best qualified to handle any modifications. My own personal BERT is an awful mess of add-ons and kludges. Perhaps someday I'll clean him up and make those tem-

Communicating with BERT

After a reset (either power-on or manual), BERT enters his "get commands" state. In this state he sits quietly, receiving and storing ASCII data arriving at his S.IN (serial input) connector. He will stay in this state until one of three events occurs:

1. An E ("End") instruction arrives.
2. His memory fills up with the received data.
3. Improper data is received.

Events 1 and 2 are normal. When they occur, BERT will beep, then enter his "nose?" state. While in this state, BERT constantly monitors his nose button. The only way out of this state is to punch his nose (press the sensor). He will then enter his "interpret" state.

In this state BERT acts like a robot, toddling around executing whatever commands you gave him during his "get commands" state. When he finishes doing all the things you told him to do, he reverts back to his "nose?" state and awaits his chance to do it all over again.

Event 3, however, is an abnormal event, and BERT does not like it. Improper data is defined as either "any data which represents a nonexistent command" or "any non-ASCII data."

Upon receipt of either of these types of garbage, BERT will make a rude noise and glare at you (make a beep and turn on his eye). To put him back in a good mood, press his reset button, then examine your code for the bad instruction, correct the error, and prepare to download the corrected code.

porary modifications more permanent—maybe just after I add a little more RAM, or perhaps after I modify the nose sensor. . .

Finally, should you start to feel limited by the BERTL language, or should you even wish to write your own robot control language, you may be interested in obtaining an optional ROM for BERT. After you've installed this ROM and added an RS-232C driver (to allow the OBC to talk back to the host computer), BERT will be transformed into a 6800 machine language development device. This will open the door to unlimited control over the hardware. It will allow you to enter, edit, and debug machine language code in the OBC. This ROM, complete with instructions and commented source code listing, is called KRMIN and is available through Amarobot.

[Editor's note: Since this article was written, the author has added design enhancements to BERT, such as increased motor drive capability, more RAM, and an additional output port. The BERTL language has been revised to accommodate instantaneous response to on-board sensors (allowing BERT to play a version of robot laser tag) as well as increased vocabulary. The circuit boards and the EPROM required for these modifications, in addition to the ones described here, are available from Amarobot. See the address at the end of this article.]

Pulling the Plug

Well, that's about all there is to it. If you follow all the steps in both parts of this article, you should have your very own robot—probably not the most elaborate robot ever featured as a construction article, but the most complete.

Everything, from hardware to software, is defined, debugged, and obtainable right now. Many configurations of BERTs are roaming around classrooms and basements (see photo 2). The first BERT users group has started here in Vancouver. You can correspond with them by writing the Vancouver Robot Club, c/o Seaport Pacific Services Ltd., Suite 611, 470 Granville St., Vancouver, British Columbia, Canada V6C 1V5.

If you wish to receive a copy of their latest newsletter, send your address and \$1 (don't send a stamped envelope unless the postage is Canadian). I wish you good luck with your BERT, and I hope that building and programming him provides you with the opportunity to enter the fascinating domain of robotics and artificial intelligence. ■

All parts for BERT are available from Amarobot, 2913 Ohio St., Richmond, CA 94804, (415) 451-6780.



INTEGRATED SOFTWARE

• Word Processing • Spreadsheet • Database • Graphics

**The Incredible JACK2[®] from Pecan
at the Incredible Introductory
Price of \$49.95* (regularly \$100)**

For the IBM PC and Compatibles Under DOS

**All it takes is one screen to do everything
you've always wanted to do, at one time.**

Word processing. Spreadsheet. Data base management. Charting. JACK2 is the first integrated software product to do them all, simultaneously, on a single screen. All without ever changing disks or exiting programs.

No need for windows. No need to close one file before you open another. And no need to learn a specialized computer language.

Easy to use. Easy to learn.

JACK2 is as easy to master as it is powerful to use. All commands are in English. All have the identical function throughout JACK2.

Integrated, the four applications of JACK2 offer unlimited potential as a business tool. Individually, they offer everything an expert could ask for.

Like multiple columns of word processing text on the same page. Spreadsheets that perform calculations in English, not with obscure formulas. No more complicated data base instructions. Even the charting function was designed for convenience.

Change a single piece of information in any one of the four related functions and JACK2 will change all the others, simultaneously, instantly and interactively. Now you can sort a data base. Perform spreadsheet calculations. Edit word processing text. And illustrate your results with a bar chart. All at once. All on the same screen.

Fast. Powerful. Because it was developed using UCSD Pascal[™]

From PC Magazine:

"Jack2's word processor is better than many dedicated word processors. It is easy to use, highly visual and delightfully fast."

"... a well-conceived, well executed program."

"... finishes a winner."

From PC World:

"... Jack2 is a likely choice."

*Half price introductory offer is valid on orders received by Pecan up to 5/31/87.

NOT COPY PROTECTED

Mail your check or money order to:
Pecan Software Systems, Inc.
1410 39th Street
Brooklyn, New York 11218
(718) 851-3100
ITT TELEX NUMBER: 494-8910
CompuServe ID: 76703, 500

PECAN[™]
The UCSD Pascal Company
Credit Card Orders **1-800-63-PECAN**
Call Toll Free
(NYS) 1-800-45-PECAN

Please add \$4.50 for shipping within the US. Foreign orders add \$15.00 and make payment by bank draft payable in US dollars on a US bank. New York State residents add appropriate sales tax. UCSD Pascal is a trademark of the Regents of the University of California.

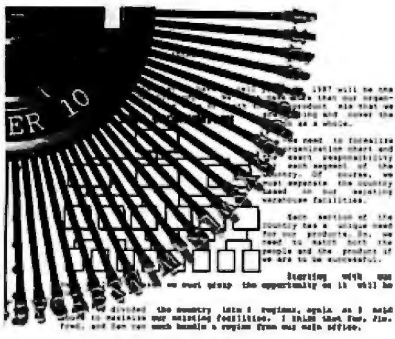

1987 will be the year that our department will be a whole lot better. We need to formalize our organization chart and clearly define the responsibilities of each person. We must separate the company's marketing and sales functions from our manufacturing facilities. Each division of the company has a unique need for our products. We need to make sure that the people and the product we sell are the same. We must grasp the opportunity we will be given to make our marketing facilities. I think that the new team and the new marketing program from our main office.

Yes, they'll have to be more than a sales department. They'll have to be a marketing department in the truest sense of the word. We need to make sure that the people and the product we sell are the same. We must grasp the opportunity we will be given to make our marketing facilities. I think that the new team and the new marketing program from our main office.

This is a major move for the company. I value everyone's input. And I expect everyone



Dear Customer:

Now you can have text and graphics together on one page with your own logo and even a border at the top, to the side or at the bottom. Now you won't have any more problems when you want to print out letters. And, the best of all is that there will be no steps to worry about in the program either.

Your letters will be checked at how easy it is to add pictures to your letters or reports. You can add drawings and charts to your business letters or proposals.

This program is so easy to use that you will use it from now on. And what's really great is that if you already use a word processing program, you can pick up files that you've written in your other program and use them in this one in minutes.

No matter where you live in the United States, you'll find that this program will let you really use your mind.

If you do use your brain, you can really get into the magic of using this great new program.

There is simply no limit to the input that drawings can provide for your letters. It doesn't matter if it's a chart, a graph or picture of a house. You can do it all with this exciting new program.

Don't let the article wall of disbelievers stand in your way. You don't need many graphs or drawings to make a really first class impression. After all, they say that a picture is worth 1000 words. Just think of how many ideas are represented on this simple page of COPY.

For formal proposals, for marketing reports or for persuasive letters, you can do it all with this powerful new program.



ones change.

Well, your sales for the last 7 months have been exceptional. I've just seen the latest graphs, and I must say I'm impressed. When you said that you could increase sales and keep royalties even, I must admit that I was skeptical.

But, I think this graph says it all. I'm also very impressed with manufacturing. We've seen a real benefit in the increased sales in a reduction in fixed costs. So, overall, not only have our sales increased, but as a percentage of sales, costs have gone down.

May we see the only month that didn't show an increase in sales. But, we showed a decrease in costs. So, you can bet that our bottom line increased.

I'm very impressed with the results and I think that the money we spent for automation and to implement your marketing effort was well spent. At year end, we'll really be able to see how long the payout will take, but from these early results and the fact that I know you'll REPLICATE your efforts for the next 8 months of the year, I think you'll be able to get some more of the things you want next year.

The second graph on this page is perhaps even more important. See the first. As you know we were receiving far too many customer complaints.

I'm very impressed with the reduction in calls that the new graph represents. The extra people in quality control and in customer service are really paying off. Considering the cost of complaints, this drastic reduction clearly shows a rewarding impact to the bottom line.

George, this has been a very good year so far. Let's push to make the last 3 months look as good as the first 7. I know at the board meeting that you'll be a major topic of conversation if this trend continues.

SALES AND COST REPORT

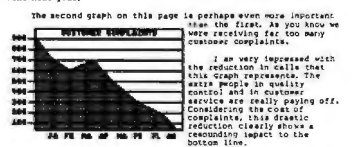
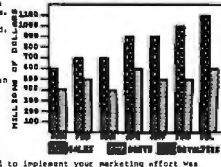

\$89⁹⁰ Desktop Publishing Breakthrough

Imagine using a word processing and drawing program that lets you integrate charts and pictures that you 'paint' or 'clip' into your text. Well, if you use an IBM PC or Clone, now you can have graphically dramatic documents, from business or personal letters, to proposals; to organization charts, even with a daisy wheel printer.

By Drew Kaplan

It's easy. It's impressive. And, now your thoughts can be powerfully illustrated in both words and graphics.

After all, for illustrating abstract data and thoughts, nothing beats a dramatic chart or drawing. So, let your ideas leap off the page by using integrated text and graphics. Your thoughts are sure to make an impressive impact.

Whether you write letters, bank proposals, term papers, company manuals or news letters, you can forget complicated and expensive laser printing. And, you can forget complicated expensive desktop publishing programs.

Now for just \$89⁹⁰, you can use your daisy wheel, dot matrix or ink jet printer to print normal text. Plus, you can integrate simply fabulous graphs and drawings into your creations.

INCREDIBLY EASY

Savtek, a brain trust group, has developed an easy to use yet incredibly sophisticated integrated word processing and graphics program.

Just create your letters, proposals, or reports as you would with any other word processor. In fact, if you already have a document created in virtually any other word processor, you can 'grab' it into Savtek's instantly.

You'll produce visually powerful technical papers and manuals with drawings and charts, and dramatic marketing reports with graphs. You'll produce sales proposals with panache.

And since there's no complicated training needed (if you can run a word processor, you can run Savtek), you'll make great impressions, fast.

Anyway, once you've created the written part of your report, using Savtek's sophisticated automatic word processing features, you're ready to add pictures, charts and graphs.

Just select from the over 100 supplied changeable pictures or draw your own, using the automated ICON based drawing program.

the sophisticated drawing program that lets you draw, paint, fill, expand, reduce, copy, and move your pictures.

And, you'll form squares, circles and triangles automatically. Anyone can draw with it because it's totally automated and uses arrow keys and doesn't require a mouse. But, read on.

Once you've selected a picture, the computer will produce an automatically sized box representing it. Just position the box wherever you want the picture to be in the text.

Like magic, the actual picture will appear and the text will automatically reformat itself around it.

And, speaking of reformatting, this program will automatically make page-breaks and recalculate each page as you write or edit. If you make an addition to page 1 of a 10 page report, the effect will ripple through all 10 pages.

So, whatever length you've chosen for each page (including headers, footers and automatic page numbering), will automatically be preserved.

You'll particularly like the cut and paste features of this word processing program which allow you to copy, move or delete sections of your text.

Of course, you'll have automatic Word-wrap, Hidden Hyphenation, Justified Smooth Right or Ragged Right text. Plus, you'll have Find, Replace and Search.

And look how you can format your document. There are 5 page templates called rulers which allow you to automatically set up your page.

You can select any right and/or left margins, your tabs, one, two or three line spacing, and the number of blank lines at the top and bottom of your page.

Each of the 5 rulers comes with different default settings. But, you can adjust and save them or change them and even use several at one time on a page.

HOW DO THE PRINTERS WORK?

I use a daisy wheel printer because I like my letters to look personal. I've always had to switch to a dot matrix printer for graphs and illustrations.

Unfortunately, I couldn't have my graphics on the same page as my text.

Now, because this program can use the period on the daisy wheel to create all the charts and graphic symbols you see within this ad, I don't need to switch printers any more.

And while it doesn't create the graphics as fast as a dot matrix, the quality is superb. Now my graphics can be impressively integrated into my text.

Note: Every single sample page shown in this ad, was printed out on my EXP 400 Silver Reed daisy wheel printer.

Note: This program does not produce two column news letters in a single action. Simply create a double length column and cut it when you have it printed.

No matter what printer you use, daisy wheel, dot matrix (with or without near letter quality printing) or ink jet (color or single color), you'll have powerful looking documents to really present your ideas in the most professional manner.

DESKTOP PUBLISHING

Desktop publishing is about the hottest category of computer programming. It seems that everyone has discovered the impact of combining text and graphics.

And very impressive presentations are just what Savtek's ETG Desktop publishing system provides for you.

Imagine leveraging the capabilities of your own IBM or Clone, your own printer and your own keyboard to produce the documents you see on these pages, with nothing else to buy.

THE 1000 WORD PICTURE

First a confession. I can't draw. That's why you don't see drawings in DAK's catalogs. But I've been amazed at how creative I can be with this paint program.

It's easy. You do everything with the arrow keys and the return key. By using the arrow keys you can draw in any direction with a choice of 12 brush shapes.

There's an erase function to eliminate anything you don't like. And here's my favorite function. UNDO is a function that works throughout this program.

...Next Page Please

...Publishing Continued

It simply removes the last thing you did. So, no matter what you do wrong, you're a button away from removing it.

If you don't want a solid line, just spray an area. It's like using a spray can.

Let's say you want to connect two points with a straight line. Use the Angle Line. It produces a computer generated straight line between any two points.

What if you want a circle? Just touch the return key. Then use the diagonal arrow key to enlarge or reduce the circle. If you use the up/down or right/left arrows, you'll get an ellipse.

In the same way you can create squares, rectangles or triangles. And you'll be amazed how many things, from houses to technical drawings, are made up of squares, rectangles, circles and triangles.

But, that's not all. You can choose any of 32 background patterns to fill in enclosed areas or broad lines. And if 32 isn't enough, you can design your own.

There's so much more. You can juggle a picture. Imagine, turning it over or sideways with the touch of a button.

You can copy or move a picture or even part of a picture right on the screen. So, draw it once and copy it or move it.

But, here's my favorite. You can enlarge or reduce any picture or part of a picture right on the screen. So you can change its size equally, or you can stretch it out or make it tall and thin. Wow!

There are 12 included font/sizes. So you can have large or small type in your choice of styles within a picture or integrated with your text.

And, each of the 12 font/sizes can be shown on the screen and printed normally, in bold, in italic, in outline, or in shadow. Plus, you can write normally across the page, up the page, down the page or upside down.

Finally, you can zoom into any small section of the screen and edit your pictures, pixel by pixel. With this kind of power, you don't need to be an artist, just have the ability to push a button.

You can operate this Paint program independently. Or, you can access any picture from within word processing.

So, for banners and pictures, you can

print directly from the Paint Program. Or, for everything previously described, simply access your pictures, captions, graphs or charts through the desktop publishing section.

This program is incredibly powerful, yet you'll be comfortable using it within just a few hours.

Every picture in this ad was created with this program. And, you haven't even seen the tip of the iceberg of its capabilities. For example, if you have a picture on the screen, you can bring a second picture up and join them together.

WHO CAN USE THE SYSTEM

All you need is an IBM PC, AT, XT or 100% compatible with standard IBM CGA or EGA graphics capability. It must have at least 256K, and either two floppy disk drives or one floppy and a hard disk.

Below is a list of some of the dot matrix, ink jet and daisy wheel printers that have been tested with this program. If your printer is compatible with any of these printers, it should work too.

Special Note: Most daisy wheel printers are Diablo 620/630 compatible, so they will work with this program.

Special Note: With a color printer you can print 3 colors plus black text.

C. Itoh 8510, Epson Fx-80, Fx-185, JX-80 (color), LQ-800, LQ1500, LX80, MX80with Graftek Plus or Graftek, RX-80, Hewlett Packard 2225C Think Jet or QuietJet, LaserJet, or LaserJet Plus, IBM BCOPCS Graphics Printer, IBM Printer, IBM 3852 Jetprinter (color), Juki 6100, Mennessmann Tally Spirit 80, NEC 3500, 3510, 3520, 3530, 3550, 5500 series, 8023A, NEC Pinwriter P5XL, P6, P7, (single or color), OKIDATA Microline 92, ML92, w/IBM Plug & Play, Microline 193, 20 (color), Panasonic KX-P1091, KX-P1091i, Quadram Quadjet (color), Radio Shack DMP-200, Silver Reed EXP400, 600, 800 and all EXP series, Star Micronics SG-10, Texas Instruments 855, 865, Xerox (Diablo) 620, 630.

FINAL FACTS

There's a pop down calculator which lets you deposit your results right into your text. A clock/timer picks up the time from your computer, and there's a 7,300 year calendar. They are all available as pop-down windows. Savtek's program is backed by a standard limited software warranty/license. It comes with a superb, easy to use reference manual. **DESKTOP PUBLISHING FOR YOU RISK FREE**

Make your ideas explode in front of your readers. When you send out a letter or proposal, let it be really dramatic. They will be your ideas, but you'll be presenting them like never before.

If you're not 100% satisfied, simply return it in unused condition within 30 days for a courteous refund.

To order Savtek's ETG Integrated Word Processing and Graphics Desktop Publishing System for your IBM PC or Clone, call toll free or send your check for the breakthrough price of just \$89⁹⁰ (\$4 P&H) Order No. 4801. CA add tax.

Look at the 12 sample pages I created. You'll see graphs, pictures and charts mixed into my text. I even designed a logo for my newsletter. Just think about the impact you'll make when you present your ideas with a combination of text and graphics. And oh, it's so incredibly easy to use. IBM is a registered trademark of International Business Machines.

DAK INDUSTRIES INC.
 Call Toll Free For Credit Card Orders Only
 24 Hours A Day 7 Days A Week
BY 65 1-800-325-0800
 For Toll Free Information, Call 6AM-5PM Monday-Friday PST
Technical Information. . . 1-800-272-3200
Any Other Inquiries. . . . 1-800-423-2866
 8200 Remmet Ave., Canoga Park, CA 91304

SHOCKING

Bar chart with 5 bars of increasing height. Text to the right discusses 'SHOCKING' data.

DESIGN LAYOUTS

Organizational chart with a central box and several branches. Text to the right discusses 'DESIGN LAYOUTS'.

THE NEWSLETTER

HELP NOW

Sample newsletter page with columns of text, a graphic of vertical bars, and a small illustration of a person.

TOTAL PICTURE CONTROL

Map of the United States with various regions highlighted. Text to the right discusses 'TOTAL PICTURE CONTROL'.

CHAPTER 2

Pie chart divided into four segments. Text to the right discusses 'CHAPTER 2'.

IDEA STARTERS

Collage of various icons including a bee, a house, a car, a tree, a person, and other symbols.

TOTAL CREATIVE CONTROL

ALL AROUND TEXT

THIS IS NORMAL
 THIS IS BOLD
 THIS IS ITALIC
 THIS IS OUTLINE
 THIS IS SHADOW
 THIS IS STRIKE
 THIS IS UNDERLINE

Graphic for Valentine's Day with a heart and the text 'HAPPY VALENTINE'S DAY'.

BEAUTIFUL PAGES

THANK YOU!!

HAPPY BIRTHDAY

Decorative page borders and graphics for 'THANK YOU!!' and 'HAPPY BIRTHDAY'.

IDEA STARTERS

Collage of various icons including a bee, a house, a car, a tree, a person, and other symbols.

Bad News For Escort

Dear Customer,

From Drew Kaplan

Escort has ignored DAK's second, one-on-one Maxon versus Escort radar challenge. And frankly, I'm fighting mad. I suppose they have a right to ignore me. But after referring to my challenge as only an "advertising gambit" and calling Maxon's radar detector an off-shore, primitive, and bottom-end unit, I'd think they'd be glad to wipe us out in a head to head duel to the death. But, I'm really mad for two other reasons

Mad Reason 1. Road and Track Magazine held an independent general radar detector test in their September 86 issue.

As far as I can see, Maxon beat Passport in Uninterrupted Alert, and Passport beat Maxon in Initial alert. Now to be fair, neither of us seem to have beaten the other by even 2 seconds at 55 miles per hour. So, we didn't win or lose by much.

And, Maxon's \$99⁹⁰ detector was tested against the \$295 Passport, not the \$245 Escort we challenged. What's interesting is that Road and Track had nice things to say about Passport and even about Escort, which wasn't even included in the tests any more.

Now, if you've been following DAK's challenge, you know we've only been challenging Escort. If you've read Road and Track's tests, you'll be amazed when you read Boardroom Reports, which I've reprinted for you to the right. What's really interesting is that it's the exact same person in both publications.

Actually, Maxon did extremely well. Road and Track only used 'over hill' and 'around curve' tests because on straight-aways the differences weren't worth describing. (Imagine that!)

It's just as I've said in my challenge. I don't think there's much difference between Maxon's and Cincinnati's Radar detectors when it comes to sensing radar.

THE CHALLENGE GROWS

In view of the opinions stated in the article in Boardroom Reports about the \$245 Escort, DAK hereby adds the \$295 Passport to our challenge.

Mad Reason 2. Did you ever hear about the cure for dandruff that was developed in the middle-ages? It was the guillotine. And frankly, I think you should be aware of Cincinnati Micro-

wave's advertising cure for the Rashid VRSS Collision Avoidance System.

The Rashid VRSS system, as described in Popular Science magazine, January 1986, sends out a radar signal on the K band ahead of your car. The good part is that it can help you avoid running into things higher than your front bumper. The bad news is that since it operates on K band, it sets off radar detectors.

Well, hats off to Cincinnati Microwave. I've tested the Passport against the Rashid unit and, as usual, they have done a splendid job. While every other detector I tested, including Maxon's, was driven crazy, theirs didn't utter a peep.

But then, my Maxon hasn't uttered any peeps lately either and let me tell you why. I was on my way to the Far East to visit Maxon, so I asked Tom, a manager at DAK, to purchase and test the Rashid.

Well, did I ever hear from him. First the unit cost \$558 plus about \$100 to install. Then buying it and finding someone to install it took almost a month.

But the real reason he was unhappy was that the recommended method of installation involved cutting a 6½" hole in the front grill of his neat new car.

Well, much to my wife's chagrin, it's now installed in her station wagon.

After installation, it has to be set by an installer. He drives between 15 and 30 miles per hour toward a solid object. When the installer thinks he's reached a safe stopping distance, he adjusts the warning alarms to sound. Then in the future, when a similar distance is reached, lights will flash and an alarm will sound.

Of course, if you accelerate too quickly into a lane behind another car the same alarms can go off.

And, I haven't figured out what to do if

there's a dog in the road, dirt on the radar sensor, or how to compensate for the different stopping distances encountered on dry, wet, icy or snowy roads.

MOST IMPORTANT PART

Speaking of advertising gambits, in virtually every magazine I pick up, I've been seeing Cincinnati's Bad News for Radar Detector ads spelling out the obsolescence of all other detectors.

If it's such an important feature that distinguishes them from us, there had better be some of these devices on the road, or Cincinnati Microwave's credibility may just be on the road as well.

I will add \$10,000 to my Escort/Passport challenge if Cincinnati Microwave can prove that there are even 1000 Rashid units on the road anywhere in the U.S. Oh heck, I'll add \$5000 if they can even find 500. (And, look at this.)

NOTE: There are several other potential collision avoidance systems on the drawing boards and each may have a DIFFERENT FINGERPRINT.

So, if you're a current Escort or Passport owner, I suggest that you find out how many Rashid units there are and what Cincinnati Microwave will do about the 'other' units before you pay \$\$\$ to have your current detector upgraded.

Besides, with over 3,000,000 square miles in the U.S., even 1,000 units would work out to less than one unit for every 3,000 square miles.

If a major car company successfully sells a collision avoidance system, then Maxon will be ready. But, the car companies currently can't even get consumers to pay \$200 for air bags. So, you decide. Is it significant, or an advertising gambit?

Below is the NEW version of the challenge. Escort, a reply please!

A \$20,000 Challenge To Escort

Let's cut through the Radar Detector Glut. We challenge Escort & Passport to a one on one Distance and Falsing 'duel to the death' on the highway of their choice. If they win, the \$20,000 check pictured below is theirs.

By Drew Kaplan

We've put up our \$20,000. We challenge Escort to take on Maxon's new Dual Superheterodyne RD-1 \$99⁹⁰ radar detector on the road of their choice in a one on one conflict.

Even Escort says that everyone compares themselves to Escort, and they're right. They were the first in 1978 to use superheterodyne circuits and they've got a virtual stranglehold on the magazine test reports.

But, the real question today is: 1) How many feet of sensing difference, if any, is there between this top of the line Maxon Detector and Escort's or Passport's? And 2) Which unit is more accurate at interpreting real radar versus false signals?

So Escort, you pick the road (continental U.S. please). You pick the equipment to create the false signals. (Don't forget our \$10,000 Rashid challenge). And finally, you pick the radar gun.

Maxon and DAK will come to your
...Next Page Please



... Challenge Continued highway with engineers and equipment to verify the results.

And oh yes, we'll have the \$20,000 check (pictured) to hand over if you beat us by more than 10 feet in either X or K band detection with the Escort, or by 2 seconds at 55mph with the Passport.

BOB SAYS MAXON IS BETTER

Here's how it started. Maxon is a mammoth electronics prime manufacturer. They actually make all types of sophisticated electronic products for some of the biggest U.S. Electronics Companies. (No, they don't make Escort's).

Bob Thetford, the president of Maxon Systems Inc., and a friend of mine, was explaining their new RD-1 anti-falsing Dual Superheterodyne Radar detector to me. I said "You know Bob, I think Escort really has the market locked up." He said, "Our new design can beat theirs".

So, since I've never been one to be in second place, I said, "Would you bet \$20,000 that you can beat Escort?" And, as they say, the rest is history.

By the way, Bob is about 6'9" tall, so if we can't beat Escort, we can sure scare the you know what out of them. But, Bob and his engineers are deadly serious about this 'duel'. And you can bet that our \$20,000 is serious.

We ask only the following. 1) The public be invited to watch. 2) Maxon's Engineers as well as Escort's check the radar gun and monitor the test and the results.

3) The same car be used in both tests. 4) We'd like an answer from Escort no later than July 31, 1987 and 60 days notice of the time and place of the conflict. 5) If Escort can prove that there are 1,000, or even 500 Rashid units in operation, we will present them with the appropriate \$10,000 or \$5,000 check at the beginning of the conflict. And, 6) We'd like them to come with a \$20,000 check made out to DAK if we win.

HOW'S THIS FOR FAIR

Cincinnati Microwave will be deemed the winner and given the check if either

Escort beats Maxon by 10 feet in both uninterrupted and initial alerts, OR if Passport beats Maxon by 2 seconds at 55mph in both uninterrupted and initial alerts. So, DAK wins only if we beat both Escort and Passport.

A tie will exist only if both the \$295 Passport and \$245 Escort fail to beat Maxon's \$99⁹⁰ Dual Superheterodyne RD-1 Radar Detector.

SO, WHAT'S DUAL SUPERHETERODYNE?

Ok, so far we've set up the conflict. Now let me tell you about the new dual superheterodyne technology that lets Maxon leap ahead of the pack.

It's a technology that tests each suspected radar signal 4 separate times before it notifies you, and yet it explodes into action in just 1/4 of one second.

Just imagine the sophistication of a device that can test a signal 4 times in less than 1/4 of one second. Maxon's technology is mind boggling.

But, using it isn't. This long range detector has all the bells and whistles. It has separate audible sounds for X and K radar signals because you've only got about 1/3 the time to react with K band.

There's a 10 step LED Bar Graph Meter to accurately show the radar signal's strength. And, you won't have to look at a needle in a meter. You can see the Bar Graph Meter with your peripheral vision and keep your eyes on the road and put your foot on the brake.



So, just turn on the Power/Volume knob, clip it to your visor or put it on your dash. Then plug in its cigarette lighter cord and you're protected.

And you'll have a very high level of protection. Maxon's Dual Conversion Scanning Superheterodyne circuitry combined with its ridge guide wideband horn internal antenna, really ferrets out radar signals.

By the way, Escort, we'll be happy to have our test around a bend in the road or over a hill. Maxon's detector really picks up 'ambush type' radar signals.

And the keyword is 'radar', not trash signals. The 4 test check system that operates in 1/4 second gives you extremely high protection from signals from other detectors, intrusion systems and garage door openers.

So, when the lights and X or K band sounds explode into action, take care, there's very likely police radar nearby. You'll have full volume control, and a City/Highway button reduces the less important X band reception in the city.

Maxon's long range detector comes complete with a visor clip, hook and loop dash board mounting, and the power cord cigarette adaptor.

It's much smaller than Escort at just 3 1/2" Wide, 4 3/4" deep and 1 1/2" high. But, it is larger than Passport. It's backed by Maxon's standard limited warranty.

Note from Drew: 1) Use of radar detectors is illegal in some states. 2) Speeding is dangerous. Use this detector to help keep you safe when you forget, not to get away with speeding.

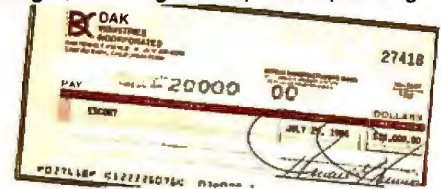

CHECK OUT RADAR YOURSELF RISK FREE

Put this detector on your visor. When it sounds, look around for the police. There's a good chance you'll be saving money in fines and higher insurance rates. And, if you slow down, you may even save lives.

If you aren't 100% satisfied, simply return it in its original box within 30 days for a courteous refund.

To get your Maxon, Dual Superheterodyne, Anti-Falsing Radar Detector risk free with your credit card, call toll free or send your check for just \$99⁹⁰ (\$4 P&H). Order No. 4407. CA res add tax.

Special Note: Now that we're challenging Passport, we've added an optional suction cup windshield mount and extra coiled power cord. (Sorry we can't afford to throw them in for free.) They're just \$5⁹⁰ (\$1 P&H) Or. No. 4800.

OK Escort, it's up to you. We've got \$20,000 that says you can't beat Maxon on the road. Your answer, please?

Escort and Passport are registered trademarks of Cincinnati Microwave. Rashid VRSS, and Rashid Radar Safety Brake are registered trademarks of Vehicle Radar Safety Systems, Inc.

DAK INDUSTRIES
 Cell Toll Free For Credit Card Orders Only
 24 Hours A Day 7 Days A Week
 BY64 **1-800-325-0800**
 For Toll Free Information, Call 8AM-5PM Monday-Friday PST
Technical Information. . . 1-800-272-3200
Any Other Inquiries. 1-800-423-2866
 8200 Remmet Ave., Canoga Park, CA 91304

John Tomarin, Road & Truck Radar detectors

Today's best radar detectors aren't much bigger than a pack of cigarettes. They weigh less than eight ounces and have exacting new circuitry. What to look for:

- Y-band and K-band sensitivity. Both different types of good radar. Y-band radar is used in the newer interior radar units where police locate short-range ambushes. K-band is used in older radar units. Both can be detected from as far as 1000 feet. A warning buzz starts as you get close. Y-band is usually the alarm in most garage door operators and home burglar alarms, when makes it much more likely to generate false alarms.
- False alarm filtering. Most newer detectors have a feature that filters out false alarms. This is important because you don't want to be annoyed by false alarms.
- Good protection for half the price. The Escort and Passport offer many of the same features as the Escort for a significant price difference. B.E.L. - Tronics Limited's Micro Eye, DAK J.P. \$299.95 and Whistler \$299.95.

Reprinted with permission of Boardroom Reports, 330 West 42nd Street, New York, NY 10036.

Get a new handle on your business with SBT.



Now you can handle up to 254 users, all working in the same data files, with the SBT MultiNet Database Accounting Library. The accounting software written in dBASE III PLUS.

So whether your business is large or small, you can grow to the limits of the most advanced PC networks available.

When you want that special report, or your business needs something we didn't think of, you can quickly and easily modify our programs to meet your needs exactly (because our dBASE source code is included **absolutely free**).

And if you don't have time to make the changes yourself, there's a nearby consultant who can make them for you.

So if your company has two users or two hundred and fifty, you can add customers, update records, and have as many people enter orders as it takes to keep your business growing.

Isn't it nice to know there's software you can't outgrow? The SBT MultiNet Database Accounting Library.

Now you can get a new handle on your business.

Call today for our demo disk and brochure.

THE SBT DATABASE ACCOUNTING LIBRARY.

dProfessional	Time & Billing	\$395
dOrders	Sales Order Processing	\$295
dInvoice	Billing/Inventory Control	\$295
dStatements	Accounts Receivable	\$100
dPurchase	Purchase Order	\$295
dPayables	Accounts Payable	\$395
dPayroll	Payroll/Labor	\$395
dLedger	General Ledger/Finance	\$395
dAssets	Asset/Depreciation	\$295
dProject	Project/Job Accounting	\$395
dProperty	Tenant/Unit Management	\$395
dMaterials	Material Requirements	\$395
dMenu/Backup	Menu/Backup	\$ 65

MultiNet versions \$200 additional per module

Call today for the name of the SBT consultant in your area.

One Harbor Drive
Sausalito, CA 94965 (415) 331-9900
Telex 9102404708



*Compiled versions also available. dBASE III and dBASE II are registered trademarks of Ashton-Tate, Inc. Copyright 1986, SBT Corporation.

An Adventure Authoring System

A tour of AdvSys, a tool for writing text adventure games

[Editor's note: "Interactive Fiction as Literature," a companion piece to this article, begins on page 135.]

AdvSys is a system I designed for writing text adventure games. In adventure games, the player acts as an adventurer in a simulated world (real or imaginary). Players determine their own course of action by typing commands that trigger events in the simulated world.

You can approach the writing of an adventure game in many ways, and a number of books describe how to use traditional programming languages to write adventures. The most commonly used language is BASIC. But while you can certainly build very complex and interesting adventures using BASIC, it was not designed specifically for that purpose.

Much of the task of building an adventure game program consists of constructing complex data structures that model the game universe. BASIC has no convenient means for describing these data structures. Even Pascal, which is rich in data structuring facilities, has no easy means of constructing complex initialized data structures.

Another approach to writing adventures is to use a special language specifically designed for the purpose. This article describes such a language.

A language for writing adventures must have three essential features: a parser to handle commands typed by the player, an object-description facility, and a language for specifying the events that take place in response to the players' commands.

continued



David Betz is a BIX senior editor. He can be reached at BIX, One Phoenix Mill Lane, Peterborough, NH 03458.

Adventure games generally take place in a world made up of a network of interconnected 'locations.'

The Parser

The parser is responsible for prompting the player to enter a command. It must read the command from the keyboard and break it into pieces that can be digested by the action code. All commands are broken into one of five different types of phrases:

1. an actor phrase
2. a verb phrase
3. a list of direct-object noun phrases
4. a preposition
5. an indirect-object noun phrase

Not all of these phrases are present in every command, and the parser recognizes only a limited set of command forms. AdvSys recognizes these forms:

1. [actor,] verb
2. [actor,] verb direct-objects
3. [actor,] verb direct-objects preposition indirect-object
4. [actor,] verb indirect-object direct objects

where "direct-objects" is defined as:

direct-object [conjunction direct-object]*

(In this article, phrases within square brackets are optional. Phrases followed by an asterisk may be repeated zero or more times.)

The terms "actor," "direct-object," and "indirect-object" all represent noun phrases. Each noun phrase is of the form

[article] adjective* noun

In other words, a noun phrase consists of an optional article followed by zero or more adjectives followed by a noun. Here are some examples of noun phrases recognized by the AdvSys parser:

sword
the angry man
the thick red book

Now that we have defined the command forms that are handled by the parser, let's

look at some complete commands. I will precede each example with a number indicating the form on which it is based:

1. Look
1. Fred, wake up
2. Drop the book
2. Take the sword and the orange vial
3. Give the book to the librarian
4. Librarian, give me the book
4. Show the librarian the book

The second example illustrates another feature of the parser. Verb phrases can consist of either a single word like "take" or a pair of words like "pick up" or "wake up." If a verb phrase consists of two words, the words do not have to be immediately adjacent to each other in the command. Either "Pick up the book" or "Pick the book up" will produce the intended result.

After breaking the command into phrases, the parser sets a small number of global variables to communicate the results of its work to the rest of the adventure system. The parser stores each noun phrase in an internal array, indexed by the noun phrase number. The index associated with the actor noun phrase is stored in the global variable \$actor, the index associated with the first direct-object noun phrase is stored in the variable \$dobject, and the index of the indirect-object noun phrase is stored in the variable \$iobject. If a noun phrase is missing from the command, its corresponding variable is set to nil (which is the same as zero in this system). These noun phrase numbers will be used later to determine which objects the noun phrases refer to.

The parser uses the verb phrase and the preposition to select an action to handle the command. It stores the selected action in the global variable \$action. (More details about actions later.) The adventure language statements you use to define the vocabulary used by the parser are

(adjective word*)
(preposition word*)
(conjunction word*)
(article word*)

In addition, it is useful to define synonyms of some words. This is accomplished by the statement

(synonym word synonym*)

Objects

Adventure games generally take place in a world made up of a network of interconnected "locations." Each location has a set of exits that connect it with adjacent locations. The player explores the game world by moving an actor from location to loca-

tion through these exits.

In the course of exploring these locations, the player encounters "things" and other "actors." In a fantasy adventure, for example, the player might encounter a magic sword or an angry dwarf.

AdvSys groups locations, actors, and things in the general category of *objects*. Each object in the adventure has an associated set of *properties*. Each property has an associated *value*.

A location object, for example, has a property for each of its exits. The values of these exit properties are the locations a player will reach by passing through the corresponding exits. Location objects also have *description* properties whose values are text strings describing the location under different circumstances. The concept of objects with properties is very general in this system, leaving you, as you write your game, free to invent new properties appropriate to a particular type of game and to define new classes of objects that share common properties, structure, and behavior.

For instance, a location object might be defined as

```
(location living-room
 (property
  description "You are in the living
  room. \n"
  north library
  south entrance
  east dining-room))
```

This is a definition of living-room, a location object with the properties description, north, south, and east. The description property has the string "You are in the living room. \n" as its value. (A back slash followed by the letter n instructs the program to start a new line). The property north has the value library (the location the player reaches when traveling north from the living room), the property south has the value entrance, and the property east has the value dining-room.

Things are objects that the player can manipulate. A thing must have a noun associated with it. And since the same noun can refer to different objects, you can associate adjectives with the objects to make references to the objects unambiguous. Here is an example of an object description:

```
(thing sword
 (noun sword weapon)
 (adjective red)
 (property
  description "a red sword"
  weight 20
  value 10
  initial-location entrance))
```

continued

The Tandy® 3000 HL makes 286 technology affordable.



We beat the competition . . .

If you're using MS-DOS® based computers and want to expand with more power for less, take a good look at the Tandy 3000 HL. It beats out the IBM® PC/XT-286 in price, performance and choice of options.

on performance . . .

Operating at 8 MHz (vs. 6 MHz for IBM's 286), the 3000 HL's advanced, 16-bit microprocessor delivers up to seven times the speed of a standard PC's microprocessor. This means you can run the business software you've grown accustomed to faster than ever.

on flexibility . . .

We let you choose your options. Expand with more memory, hard disk drives, communications and more. And you can connect the 3000 HL with other MS-DOS based computers with the ViaNet™ Local Area Network.

and on price!

The floppy-based Tandy 3000 HL starts at only \$1699. The IBM PC/XT-286 costs \$3395*. *And a comparably equipped Tandy 3000 HL with a 20-megabyte hard disk and other options still costs less than IBM's 286.*

Compare the Tandy 3000 HL. It delivers today's advanced computer technology . . . for less.

Send me a Tandy 3000 HL brochure.

Mail To: Radio Shack, Dept. 87-A-366
300 One Tandy Center, Fort Worth, Texas 76102

Name

Company

Address

ZIP Phone

Available at over 1200
Radio Shack Computer Centers and at
participating Radio Shack stores and dealers.

Radio Shack®
COMPUTER CENTERS

A DIVISION OF TANDY CORPORATION

MAY 1987 • BYTE 127

TANDY COMPUTERS: In Business . . . for Business™

*Based on IBM price list as of Jan. 13, 1987. Tandy 3000 HL price applies at Radio Shack Computer Centers and participating stores and dealers. Monitor sold separately. MS-DOS/Reg. TM Microsoft Corp. IBM/Reg. TM International Business Machines Corp. ViaNet/TM ViaNetix, Inc.

Inquiry 275

This definition describes the object sword, which has the nouns sword and weapon and the adjective red. Thus, a player could refer to this object as "the sword," "the weapon," "the red sword," or "the red weapon."

The sword object also has four properties: description has the value a red sword, weight has the value 20, value has the value 10, and initial-location has the value entrance.

The weight property might be used to provide the player with a limited carrying capacity. If each object has a weight, you can prevent the player from carrying a set of objects whose combined weight exceeds the player's load capacity. Similarly, the value property could be used for scoring. Each object has an associated value that the game will add to the player's score when the object is carried to some specified location. The meaning of these properties is up to you, the game author.

Defining Objects

Actors are objects that represent characters in the adventure. The player controls a special actor that is the "player character." The player "sees" through this actor's eyes and takes part in the action by controlling this actor's movements. In AdvSys, the player character is called the "adventurer." Other actor objects represent nonplayer characters. These nonplayer characters are controlled by the adventure program (the code that you have written) rather than by the player, and they may include both friendly and hostile characters with whom the adventurer must interact to solve the adventure. An example of a nonplayer character might be

```
(actor troll
  (noun troll dwarf)
  (adjective angry)
  (property
    description "There is an angry troll here."
    short-description "an angry troll"
    initial-location "dungeon"))
```

This defines a troll that the player can refer to as "the angry troll," "the dwarf," and so on, and is initially found in the dungeon, where the adventure will see the words "There is an angry troll here" upon entering.

So far we have seen how to describe the static portions of an adventure game. Location objects allow us to build the adventure universe, things allow us to place interesting objects in this universe, and actors allow us to populate the universe with other characters.

I have defined locations, things, and actors as part of a run-time package that

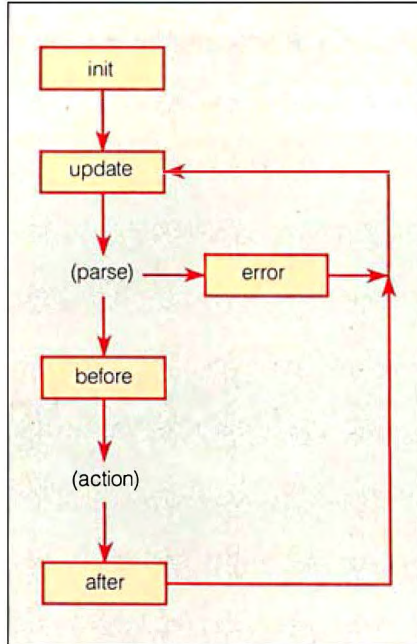

Figure 1: The action in an AdvSys game is controlled by "handlers," described below.

comes with AdvSys, but you can define your own objects if you wish. The statements used to define these objects, as shown in the previous examples, are

```
(object object-type
  object-statement*)
```

```
(object-type name
  object-statement*)
```

where the object-statement may be defined using one of the following:

```
(noun word*)
(adjective word*)
(property [property-name initial-value]*)
(class-property [property-name
  initial-value]*)
(method (selector arg-name* [&aux
  tmp-name*]) expression*)
```

Now we will explore how things happen in the adventure universe.

Handlers

All action within an AdvSys adventure is controlled by a set of "handler" and "action" procedures. There are five different handlers that are part of the main control loop. Each of these handlers contains user-defined code written in the adventure language. Figure 1 illustrates the control flow of the adventure system.

At the beginning of the game, the AdvSys interpreter calls the "init" handler. The init handler is responsible for printing any introductory text explaining the

initial situation and for performing any initialization. Here is an example of an init handler definition:

```
(init
  (print "Welcome to the sample
  adventure! \n")
  (setq curloc nil))
```

This example handler prints a welcome message and sets the variable curloc (the current location of the adventurer) to nil.

The first handler in the main loop is the "update" handler, which is responsible for handling changes in the game state. If the player has moved a new location, the update handler should print a description of the new location. Here is an example:

```
(update
  (if (not (= (getp adventurer parent)
    curloc))
    (progn
      (setq curloc (getp adventurer
        parent))
      (send curloc describe))))
```

This handler checks to see if the adventurer's new location is different from the current one. If it is, the handler updates the current location and prints a description of the new location by sending the message describe to the new location object. (Note that on the first pass through the control loop, the update handler sees the location of the adventurer as being different from that stored in curloc and prints a description of the initial location.)

After the update handler has finished, the AdvSys interpreter calls the parser. The parser prompts the player for a new command, allows the player to enter the command, and parses the command according to the description above. The parser communicates its results to the remaining handlers by setting the global variables \$actor, \$action, \$dobject, \$ndobjects, and \$object. If an error occurs during the parsing of the command, the system prints an error message, calls the error handler, and goes back to the start of the main loop (the update handler).

Assuming that the parser succeeds in parsing a syntactically valid command, the AdvSys interpreter calls the "before" handler, which handles any general preprocessing that needs to be done before the command-specific code is performed.

Next, the action associated with the player's command is performed. This is the action that was stored in the global variable \$action by the parser. This code is responsible for actually carrying out the player's request (if it is allowed in the current situation).

The last handler in the main loop is the

continued



Newbury's solution to The Great American Printer Hang-up.

We've taken all the wrinkles out of paper handling.

Now you can have reliable paper handling for more high-speed, dot matrix printing time. Newbury Office Systems Printers (OSP) are designed to more than match the capabilities of your Personal Computer—whether your application is word processing or financial modeling, using shared resources or local area networks.

Set-ups and change-overs have never been easier with our 3-way paper handling.

In addition to speedy printing, Newbury gives you a new standard in 3-mode convenience and flexibility. We've integrated a unique, automatic paper-feed mechanism that is fast and reliable. It features self-registration auto-load for single sheets. Simply snap in an interlocking paper cassette for faster automatic sheet-feeder applications. Or, snap in the interlocking tractor option with single belt and gear for true alignment of continuous forms.

Newbury offers more things for more offices.

Even at speeds of 200 cps, noise levels are quieted to less than 50 dBA. For print quality that is truly outstanding Newbury offers 9, 12 or 18-wire OSP models. All feature high-speed printing thru-put with Newbury's exclusive 3-line look-ahead logic, low-mass, high-efficiency printheads, and fast-line advance. And when you're ready for color, you have it by just inserting a clip-in color ribbon cartridge.

Document after document, Newbury delivers faster thru-put rates and a total-feature-package that just makes more sense for more offices.

Get more details immediately.

Newbury Data

A member of the DRI Group

Europe's Leading Peripherals Manufacturer

Newbury Data, Inc. U.S. Headquarters

2200 Pacific Coast Hwy., Suite 208
Hermosa Beach, CA 90254

Phone: **So. West** 213/372-3775, **No. West** 415/254-8350,

No. East 617/273-2161, **So. East** 512/834-7746

For OEMs and Distributors Only.

- Rush details on Newbury's OSP Printers.
- Send info on Newbury's 8850 300 lpm serial dot matrix printer.
- Send info on Newbury's model 8933 240 cps Text Processing Printer.
- Send data on Newbury's 3.5" / 50MB and 5.25" / 65 to 380MB high-performance Disk Drives.

Name _____
Company _____
Address _____
City _____ State _____ Zip _____

“after” handler, which handles any processing that must happen after the action is complete, such as updating the game clock or the player’s score, or anything that should happen only at the end of a successful turn.

The adventure language statements that are used to define handlers are:

```
(init expression*)
(update expression*)
(before expression*)
(after expression*)
(error expression*)
```

Actions

The only part of the adventure system left to describe is the method for defining actions. Each action definition handles a specific command form and verb/preposition combination. Let’s look at an example:

```
(action a-take
 (verb take get (pick up))
 (direct-object)
 (code
  (setq %dobject (in-location
    $dobject))
  (if (getp %dobject takeable)
    (progn
```

```
(if (send %actor carrying?
    %dobject))
 (complain "You are already
 carrying the "
 $dobject "! \ n"))
 (send %actor take
 %dobject)
 (print-noun $dobject)
 (print " taken. \ n"))
 (complain "You can't take the "
 $dobject "! \ n"))))
```

This action definition handles commands like “take the lamp” or “pick up the sword.” It handles any command with the verbs “take,” “get,” or “pick up” and at least one direct object. The code begins by determining to which object the direct-object noun phrase refers. The function in-location looks for an object in the current location (curloc) that matches the noun phrase it receives as its argument. The function returns the matching object or signals an error if no object in the current location matches the noun phrase.

Assuming that in-location finds a matching object, the action code assigns that object to the variable %dobject and then checks to see if it is possible to pick up the object. This is done by checking the value of the property takeable. If the

result is true, the object may be taken. If not, the program prints an error message and the turn ends.

If the object is takeable, the code then checks to see if the player is already carrying it. It does this by sending the message carrying? to the actor object. This message checks to see if the object is currently being carried by the actor receiving the message. Both actor and location objects support the concept of containment. If the adventurer is already carrying the object, the program prints a message saying so and the action is complete. If not, the program adds the object to the adventurer’s inventory by sending the actor object the take message and the program prints a message indicating the successful completion of the command.

This example illustrates the use of object-oriented programming techniques in the specification of action code. AdvSys lets you define “methods” to handle messages sent to objects. Each message requests that the object perform some operation. The specific operation that is performed in response to a message is determined by a method definition associated with the object that receives the message. AdvSys supports hierarchical in-

continued

FORTRAN PROGRAMMERS

Looking for the right PC FORTRAN language system? If you're serious about your FORTRAN programming then you should be using F77L - LAHEY FORTRAN.

"Lahey's F77L FORTRAN is the compiler of choice. It's definitely a 'Programmers FORTRAN,' with features to aid both the casual and the professional programmer. . . F77L compiled the five files in a total of 12 minutes, which was 4 times as fast as MS FORTRAN and an astounding 6 times as fast as Pro FORTRAN." - PC Magazine

Compare the features and performance of other PC FORTRANs with F77L and you will find that F77L is clearly the superior product.

- Full Fortran 77 Standard (F77L is not a subset)
- Popular Extensions for easy porting of mini and mainframe applications
- COMPLEX*16, LOGICAL*1 and INTEGER*2
- Recursion - allocates local variables on the stack
- IEEE - Standard Floating Point
- Long variable names - 31 characters
- IMPLICIT NONE
- Fast Compile - Increases productivity
- Source On Line Debugger (Advanced features without recompiling)
- Arrays and Commons greater than 64 K
- Clear and Precise English Diagnostics
- Compatibility with Popular 3rd Party Software (i.e. Lattice C)
- Easy to use manual
- Technical Support from LCS

• NEW FEATURE - NAMELIST

F77L - THE PROGRAMMER'S FORTRAN

\$477.00 U.S.

System Requirements: MS-DOS or PC-DOS, 256K, math coprocessor (8087/80287)

FOR MORE INFORMATION: [702] 831-2500



Lahey Computer Systems, Inc.
P.O.Box 6091
Incline Village, NV 89450
U.S.A.

International Dealers:

England: Grey Matter Ltd., Tel: (0364) 53499
Denmark: Ravenholm Computing, Tel: (02) 887249
Australia: Computer Transitions, Tel: (03) 537-2786
Japan: Microsoftware, Inc., Tel: (03) 813-8222

SERVING THE FORTRAN COMMUNITY SINCE 1967

MS-DOS & MS FORTRAN are trademarks of Microsoft Corporation. Pro FORTRAN refers to Professional FORTRAN a trademark of International Business Machines.



Editor's Choice
- PC Magazine

How to process documents instead of words.

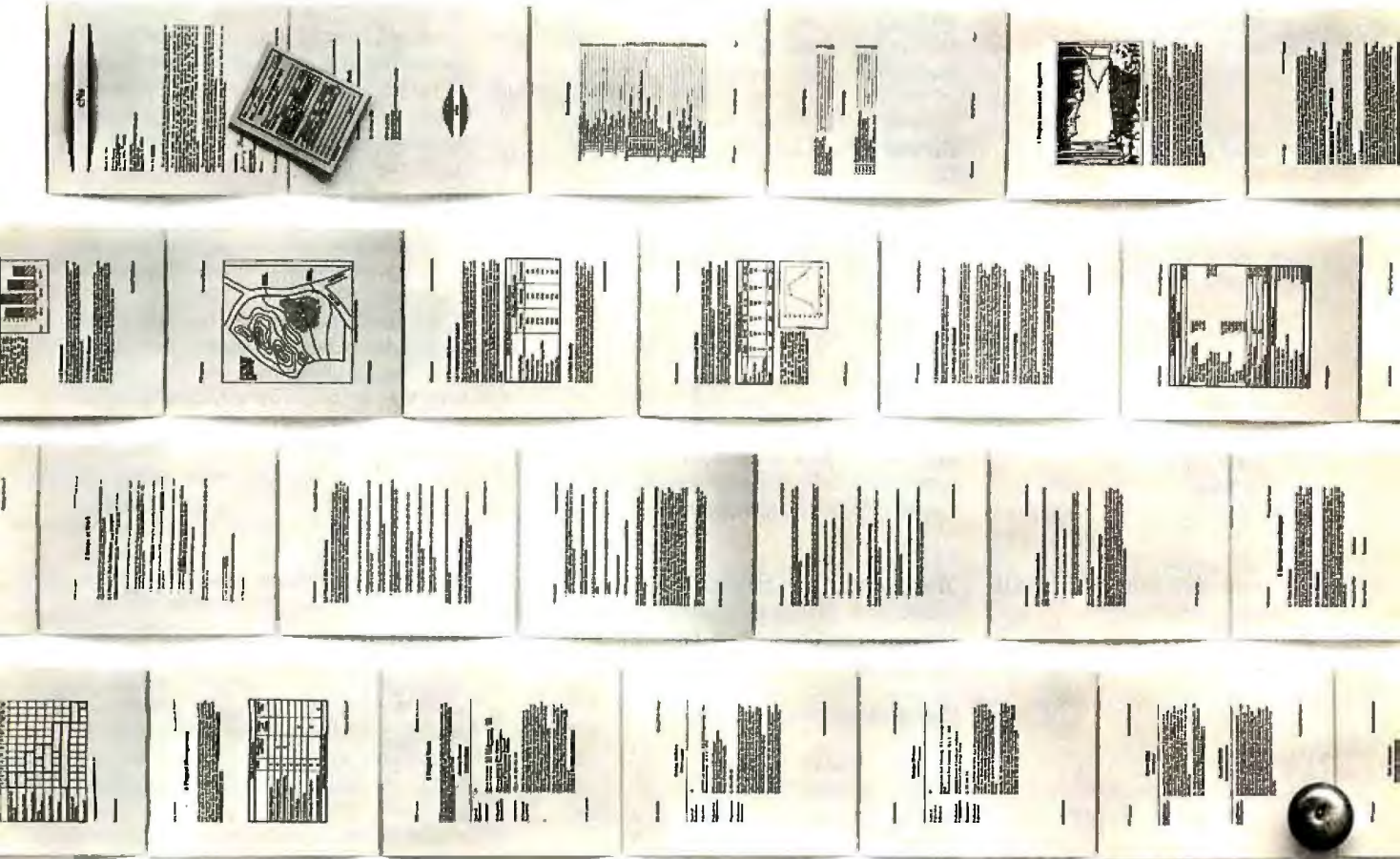

Ho hum, your word processor enables you to process words. But today, when you're creating long, complex documents, you often have to process much more. Graphics, equations, columns, tables, etc.

Lotus Manuscript™ is a complete document creation system that can handle documents from 1 to 800 pages. Manuscript can mix text and graphics on the same page, graphics from Lotus® 1-2-3®, Symphony® and Freelance® Plus. It can also import spreadsheets and charts, plus diagrams and scanned images.

With our Integrated Outliner you can collapse a document to navigate the outline, or move any size section with just a few keystrokes.

You can globally format an entire Manuscript document, or format by sections.

Manuscript's Document Compare feature highlights changes between revisions for foolproof proof-reading.

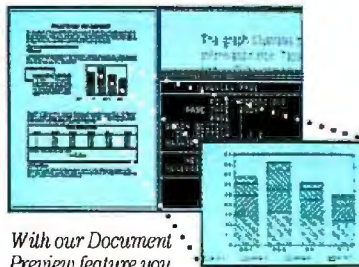

With our Document Preview feature you can see how any page will look before it's printed. Zoom capability lets you take a closer look at graphics and equations.

Also, Manuscript automatically sizes and generates math equations as well as Greek symbols, diacritical marks and brackets.

Our powerful Print Formatter gives you control over the look of your document, from position and size of graphics, to fonts, point sizes and more.

Manuscript also takes full advantage of

today's printing technology, from dot-matrix to laser, including PostScript® printers.

Manuscript is designed to work on most IBM® PCs and compatibles.* Its familiar 1-2-3 interface makes it easy to use. And our Manuscript evaluation kit makes it easy to try. For \$10.00, you'll get a presentation disk, working software, and a tutorial manual. To get your evaluation kit, call 1-800-345-1043, ask for lot #YD-1450.

Or, for more information, see your authorized Lotus Dealer, or write Lotus Development Corp., 90 Annex, Atlanta, GA 30390-0370.



Lotus Manuscript™

Table 1: *The executable statements used in actions and handlers to control an adventure game written with AdvSys.*

(+ expr1 expr2)	Add two numbers
(- expr1 expr2)	Subtract two numbers
(* expr1 expr2)	Multiply two numbers
(/ expr1 expr2)	Divide two numbers
(% expr1 expr2)	Remainder after dividing two numbers
(& expr1 expr2)	Bit-wise AND of two numbers
(: expr1 expr2)	Bit-wise OR of two numbers
(expr)	Bit-wise complement of a number
(< expr1 expr2)	Is expr1 less than expr2?
(= expr1 expr2)	Is expr1 equal to expr2?
(> expr1 expr2)	Is expr1 greater than expr2?
(setq sym value)	Set the value of a variable
(getp obj prop)	Get the value of a property
(setp obj prop val)	Set the value of a property
(and [expr]*)	Logical AND of a set of expressions
(or [expr]*)	Logical OR of a set of expressions
(not expr)	Logical NOT of an expression
(cond [clause]*)	LISP style conditional
(if expr then-expr [else-expr])	Traditional "IF" statement
(while expr [expr]*)	Traditional "WHILE" statement
(progn [expr]*)	Group expressions into a block
(return [expr])	Return from a function
(expr [expr]*)	Call a user-defined function
(class obj)	Get the class of an object
(send obj sel [expr]*)	Send a message to an object
(send-super sel [expr]*)	Send a message to the superclass of an object
(randomize)	Initialize the random-number generator
(rand expr)	Generate a random number between 0 and n-1
(yes-or-no)	Prompt the user and accept YES or NO
(print expr)	Print a string
(print-number expr)	Print a number
(print-noun expr)	Print a noun phrase
(terpri)	Start a new print line
(match np obj)	Does this noun phrase match this object?
(finish)	Finish this turn (go to the AFTER handler)
(chain)	Exit this handler and go to the next
(abort)	Abort this turn (go to the UPDATE handler)
(exit)	Exit the adventure (back to DOS)
(save)	Save the current game state to a file
(restore)	Restore the game state from a file

heritance of both properties and methods so you can define classes of objects that share the same property structure and behavior.

The default run-time environment for AdvSys adventures (contained in the file OBJECTS.ADI) defines methods that implement the default behavior for the built-in object classes. But the power of the system is that it lets you define subclasses of these default classes that implement either objects or classes of objects whose behavior and properties are unique to a particular adventure. This allows you to build on the existing classes rather than "reinventing the wheel." The default run-time environment is thus a framework for building an adventure rather than merely a sample program.

If a command contains multiple direct objects, the parser will store the first direct object noun phrase number in \$dobject and the number of direct objects in \$ndobjects. If your action code doesn't touch the value of \$ndobjects, at the end of the after handler, the system will assign the next direct object to the variable \$dobject, decrement the count stored in \$ndobjects, and loop back to the before handler again. This means that you don't need to do anything special to handle commands with multiple direct objects. However, if you have a reason to want to handle all of the objects yourself, you can do so on the first pass through the action code and then set the variable \$ndobjects to nil to prevent the system from looping back to handle the additional direct objects.

The adventure language statements used to define actions are:

```
(action name
  action-statement*)
```

with action-statement defined as one of the following:

```
(actor [flag])
(verb [word | (word1 word2)])
(direct-object [flag])
(preposition word*)
(indirect-object [flag])
(code expression*)
```

and where flag is one of the following:

```
required
optional
forbidden
```

Expressions

Handlers, actions, and methods all contain executable statements called expressions. The complete list of expression types allowed in AdvSys is shown in table

continued



Our thanks to NASA for supplying this computer enhanced ultraviolet photo taken by Skylab IV of a solar prominence reaching out 350,000 miles above the sun's surface

Genius Begins With A Great Idea ...

But The Idea Is Just The Beginning

What follows is the time consuming task of giving form and function to the idea.

That's why we concentrate on building into our software development systems functions and features that help you develop your software ideas in less time and with less effort.

We've started 1987 by releasing new versions of our MS-DOS, Macintosh, Amiga, ROM, and Apple II C development systems. Each system is packed with new features, impressive performance, and a little bit more genius.

Aztec C86 4.1

New PC/MS-DOS • CP/M-86 • ROM

Superior performance, a powerful new array of features and utilities, and pricing that is unmatched make the new Aztec C86 the first choice of serious software developers.

Aztec C86-p Professional System . . . \$199

• optimized C with near, far, huge, small, and large memory + Inline assembler + Inline 8087/80287 + ANSI support + Fast Float (32 bit) + optimization options • Manx Aztec 8086/80x86 macro assembler • Aztec overlay linker (large/small model) • source level debugger • object librarian • 3.x file sharing & locking • comprehensive libraries of UNIX, DOS, Screen, Graphics, and special run time routines.

Aztec C86-d Developer System . . . \$299

• includes all of Aztec C86-p • Unix utilities make, diff, grep • vi editor • 6+ memory models • Profiler.

Aztec C86-c Commercial System . . . \$499

• includes all of Aztec C86-d • Source for library routines • ROM Support • CP/M-86 support • One year of updates.

Aztec C86 Third Party Software

A large array of support software is available for Aztec C86. Call or write for information. The following is a list of the most requested products: Essential Graphics • C Essentials • C Utility Library • Greenleaf Com. • Greenleaf General • Halo • Panel • PC-lint • PforCe • Pre-C • Windows for C • Windows for Data C terp • db Vista • Phact • Plink86Plus • C-tree.

CP/M • TRS-80 • 8080/Z80 ROM

C compiler, 8080/Z80 assembler, linker, librarian, UNIX libraries, and specialized utilities.

Aztec C II-c (CP/M-80 & ROM) . . . \$349

Aztec C II-d (CP/M-80) . . . \$199

Aztec C80 (TRS-80 3&4) . . . \$199

Aztec C68k/Am 3.4

New Amiga Release

Amiga user groups across the USA voted Aztec C68k/Am release 3.3 the best Software Development System for the Amiga. Release 3.4 is more impressive.

Aztec C68k/Am-p Professional . . . \$199

A price/feature/performance miracle. System includes: optimized C • 68000/680x0 assembler • 68881 support • overlay linker • UNIX and Amiga libraries • examples.

Aztec C68k/Am-d Developer . . . \$299

The best of Manx, Amiga, and UNIX. System includes: all of Aztec C68k/Am-p • the Unix utilities make, diff, grep and vi.

Aztec C68k/Am-c Commercial . . . \$499

Aztec C68k/Am-d plus source for the libraries and one year of updates.

Aztec C68k/Mac 3.4

New Macintosh Release

For code quality, reliability, and solid professional features, Aztec C for the Macintosh is unbeatable. This new release includes features and functions not found in any other Macintosh C development system.

Aztec C68k/Mac-p Professional . . . \$199

• optimized C • 68000/680x0 assembler • 68881 support • overlay linker • UNIX and Macintosh libraries • examples.

Aztec C68k/Mac-d Developer . . . \$299

The best of Manx, Macintosh, and UNIX. System includes: all of Aztec C68k/Am-p • the Unix utilities make, diff, grep • vi editor.

Aztec C68k/Mac-c Commercial . . . \$499

Aztec C68k/Am-d plus source for the libraries and one year of updates.

Aztec C65

New ProDOS Release

Aztec C65 is the only commercial quality C compiler for the Apple II. Aztec C65 includes C compiler, 6502/65C02 assembler, linker, library utility, UNIX libraries, special purpose libraries, shell development environment, and more. An impressive system.

Aztec C65-c Commercial . . . \$299

• runs under ProDOS • code for ProDOS or DOS 3.3

Aztec C65-d Developer . . . \$199

• runs under DOS 3.3 • code for DOS 3.3

Aztec ROM Systems

6502/65C02 • 8080/Z80 • 8086/80x86 • 680x0

An IBM or Macintosh is not only a less expensive way to develop ROM code, it's better. Targets include the 6502/65C02, 8080/Z80, 8086/80x86, and 680x0.

Aztec C has an excellent reputation for producing compact high performance code. Our systems for under \$1,000 outperform systems priced at over \$10,000.

Initial Host Plus Target . . . \$750

Additional Targets . . . \$500

ROM Support Package . . . \$500

Vax, Sun, PDP-11 ROM HOSTS

Call for information on Vax, PDP-11, Sun and other host environments.

C' Prime

PC/MS-DOS • Macintosh

Apple II • TRS-80 • CP/M

These C development systems are unbeatable for the price. They are earlier versions of Aztec C that originally sold for as much as \$500. Each system includes C compiler, assembler, linker, librarian, UNIX routines, and more. Special discounts are available for use as course material.

C' Prime . . . \$75

Aztec Cross Development Systems

Most Aztec C systems are available as cross development systems. Hosts include: PC/MS-DOS, Macintosh, CP/M, Vax, PDP-11, Sun, and others. Call for information and pricing.

How To Become An Aztec C User

To become a user call 800-221-0440. From NJ or international locations call 201-542-2121. Telex: 4995812 or FAX: 201-542-8386. C.O.D., VISA, MasterCard, American Express, wire (domestic and international), and terms are available. One and two day delivery available for all domestic and most international destinations.

Aztec C is available directly from Manx and from technically oriented computer and software stores. Aztec Systems bought directly from Manx have a 30 day satisfaction guarantee.

Most systems are upgradable by paying the difference in price plus \$10. Site licenses, OEM, educational, and multiple copy discounts are available.

To order or for more information call today.

1-800-221-0440

In NJ or international call (201) 542-2121 • TELEX: 4995812



1. Each of the forms shown computes a result, which is returned as the value of the expression.

Here is an example of an expression derived from table 1:

```
(setq x (+ (* a b) (* c d)))
```

This executable statement is an arithmetic expression that multiplies a times b and c times d, adds the two products, and stores the result in the variable x. Even

the setq form returns a value. Its value is the new value of the variable after the assignment is done.

Run-Time Functions

Not all of the functions that I have used in the examples are listed in table 1. The missing functions are part of the run-time package OBJECTS.ADI (see table 2) and are not built into the language. These functions are defined in adventure code and can be changed by the adventure

author to suit a variety of tasks.

I wrote the run-time package so that you would not have to start from scratch when writing adventures. The run-time package defines commonly used object types such as locations, actors, and things; common actions such as look and take; game control commands like save and restore; and methods for handling common messages. These methods define the default behavior of objects, but can be easily supplemented or overridden by methods defined in ob-

Table 2: The functions included in the basic run-time package for the AdvSys adventure writing system, OBJECTS.ADI.

BASIC-THING		THING Things that can be taken.	
superclass: object		superclass: basic-thing	
properties: initial-location Initial location of the object. parent Current location of the object. sibling Next object in the location.		properties: takeable Can the thing be taken? (defaults to T)	
methods: (none)		methods: (none)	
ACTOR The adventurer or non-player characters.		STATIONARY - THING Things that cannot be taken.	
superclass: basic-thing		superclass: basic-thing	
properties: child First object carried by the actor.		properties: (takeable) Can the thing be taken? (Because this property is missing, GETP will return NIL as its value.)	
methods: (move dir) Move in the specified direction. (take obj) Take an object. (drop obj) Drop an object. (carrying? obj) Is actor carrying the specified object? (inventory) Show the actor's inventory.		methods: (none)	
PORTAL Connections between locations.		LOCATION Locations in the adventure.	
superclass: basic-thing		superclass: object	
properties: other-side Counterpart in the other location. closed Is it closed? locked Is it locked? key Key to lock and unlock.		properties: description Long description. short-description Short description. visited Has the player been here? child First object in this location. (exit directions) Exits.	
methods: (knock? obj) Can this object enter? (enter obj) Cause this object to enter the location. (open) Open the portal. (close) Close the portal. (lock key) Lock the portal. (unlock key) Unlock the portal.		methods: (knock? obj) Can this object enter? (enter obj) Cause this object to enter the location. (leave obj dir) Leave in the specified direction. (describe) Describe the location.	

jects or subclasses defined by the adventure author. In this way, you can build your adventure game on the basic framework provided by the run-time package. For example, the run-time package supplies a method for the message leave, which allows an actor to leave a location.

Associated Definitions

The following method definition could be associated with a particular location and would require the actor to be carrying the "rusty key" in order to leave the location:

```
(method (leave obj dir)
  (if (send obj carrying? rusty-key)
    (send-super leave obj dir)
    (print "You seem to be missing
something! \ n")))

```

This example also illustrates the use of the send-super form. Send-super passes a message to the parent (or super) class of the current object. This definition says that if the actor (the value of obj) is carrying the rusty key, the leave message should be handled normally. If not, the program prints a message and the action is aborted.

The adventure language statements used to define constants, functions, variables, and property-names are:

```
(define symbol value)
(define (function-name symbol*)
  expression*)
(variable symbol*)
(property symbol*)

```

Summary

AdvSys is a tool for writing adventure games, much as a word processor is a tool for writing novels. It is not a substitute for good creative writing, but a tool for the writer. I hope the availability of this system will inspire potential adventure authors to write adventure games and share them with the rest of us. (See the article "Interactive Fiction as Literature," which begins on this page.) ■

Editor's note: *The source code for AdvSys, the adventure game writing system, was written in C and includes the following files: ADVCOM, the adventure game compiler; ADVINT, the adventure game interpreter; OBJECTS.ADI, a run-time package containing the basic definitions needed for a game; and the AdvSys documentation.*

The files are available on disk, in print, and on BIX. See the insert card following page 324 for details. Listings are also available on BYTEnet. See page 4. In order to run the programs, you will need a C compiler appropriate for your computer system.

Interactive Fiction as Literature

Adventure games have a literary lineage



When Willie Crowther and Don Woods wrote the narrative-based game Adventure, they most likely did not foresee that they were creating a new way of telling a story or that Adventure might some day be considered a work of literature.

The adventure game genre is now called interactive fiction (IF). In some ways, IF closely resembles the traditional literary genres of mysteries, science fiction, fantasy, and adventure tales. These types of popular literature are based on rules, games, and the creation of fantasy worlds. They all emphasize a step-by-step, action-consequence type of thinking and imagination.

Mystery Literature: Detection as a Game

Edgar Allen Poe would have loved IF; he was a master at solving cryptograms and thought problems, and he wrote the first detective story, "Murder in the Rue Morgue." Ever since then, mystery literature has been compared to games. The Sherlock Holmes stories, for example, have been called "crossword puzzles." Mystery novels like those of Agatha Christie and Dashiell Hammett are more like jigsaw puzzles, while James Bond novels and spy stories can be compared to games of chess.

Mysteries challenge the reader's powers of deduction; they are games in the form of stories, in which the reader competes with the author, matching wits in the game of "who done it" and how.

Some writers have even established mystery literature "rules" to make sure the competition between the reader and the characters, or the reader and the author, is fair. One set of rules that was set forth to give the reader a sporting chance requires that the author at least mention the criminal early on in the story, that there be no more than one secret passage per story, and that no secret twin brothers or sisters may suddenly appear to explain the crime. To promote such fair play with the reader, the famous Detection Club (founded by G. K. Chesterton, Agatha Christie, Dorothy Sayers, and others) re-

quires new members to swear to the following initiation oath (see reference 1):

Ruler: Do you solemnly swear never to conceal a vital clue from the reader?

Candidate: I do.

Ruler: Do you promise to observe a seemly moderation in the use of Trap-Doors, Chinamen . . . and utterly and forever to forswear Mysterious Poisons unknown to science?

Candidate: I do.

Of course, fair play in no way hinders an author from trying to fool the reader; trickery and the ability to manipulate the rules to one's own advantage are admired qualities in gamesmanship.

As in mystery literature, the fascination of the intellectual challenge in IF may make up for weaknesses in characterization and style, which often suffer from the all-consuming goal of making the plot as thick as possible. In both IF and in detective literature, events and characters' choices are often not explained psychologically. In many mystery stories, the author simply establishes that the crime is puzzling, without providing any plausible motivation for it.

However, the suspense in mysteries can evoke total involvement and escape from our real-world problems. Because the reader is the detective and unraveller of puzzles in IF, and therefore more actively and intensely involved in solving the problems, IF can become a more powerful type of suspense and escape literature than current mystery literature.

IF and Adventure Literature

Crowther and Woods' Adventure is a story of exploration, like Jules Verne's *Journey to the Center of the Earth*. Both take place in caves, and many of the descriptions are similar. Perhaps surprisingly, the cave

continued

Mary Ann Buckles (9240-L Regents Rd., La Jolla, CA 92037) is co-owner and writing consultant of Transgalactic Software. This article is based on her doctoral dissertation written at University of California at San Diego.

DISC DATA MANAGER: For people who need a lot of storage now...

Introducing the DISC DATA MANAGER™ from Seagate. The high-capacity storage subsystem that expands module by module to meet your changing needs.

Since you choose the capacity, you never pay for more storage than you need. Yet, affordable growth is there when you need it.

The DISC DATA MANAGER is a SCSI subsystem that provides compatible storage for many environments. Including PC-DOS* and Novell's popular Advanced Network.*

As your needs for storage sharing increase, the DISC DATA MANAGER can be converted into the LAN DATA MANAGER™, a high-performance, IBM*-compatible file server.

But this is just half the story.

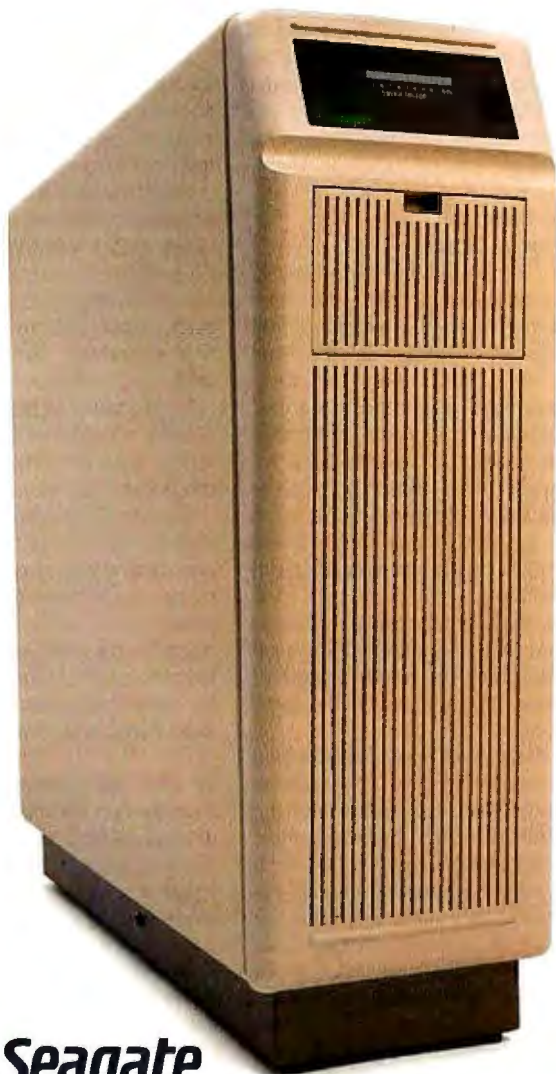

 **Seagate**

descriptions in Adventure are often more realistic and vivid than in Verne's story. Whereas Jules Verne explored only in his imagination, Willie Crowther is a real-life spelunker. Adventure began as a map, a computer model of an actual Colossal Cave in Kentucky, which Crowther explored and then accurately duplicated in the first few levels of Adventure's cave.

Similarly, Adventure is related to Robert Louis Stevenson's *Treasure Island*. The desire for treasure motivates both stories, and both were inspired by maps. Location and physical setting dictate the process of action. Stevenson once explained how he got the idea for his famous story:

I made the map of an island; it was elaborately and (I thought) beautifully coloured; the shape of it took my fancy beyond expression; it contained harbours that pleased me like sonnets; and with the unconsciousness of the predestined, I ticketed my performance 'Treasure Island'. . . as I paused upon my map of 'Treasure Island,' the future character [sic] of the book began to appear there visibly among imaginary woods; and their brown faces and bright weapons peeped out upon me from unexpected quarters as they passed to and fro, fighting and hunting treasure, on these few square inches of a flat projection. The next thing I knew I had some papers before me and was writing out a list of chapters . . . the map was most of the plot. (See reference 2.)

Chivalry is Alive

Adventure, which was made possible by technological advancements in computers, is similar to the first "novels," which were also dependent upon a new technology, the printing press. These novels of chivalry were prose versions of medieval knightly verse epics that, with the introduction of the printing press, could be mass-produced for a wide audience.

Compare Irving Leonard's comments on the romances of chivalry to the reactions of Adventure lovers:

These tremendously popular works of fiction . . . stimulated the emotions and won the passionate devotion of all literate classes of Spain, from the great Emperor Charles V himself to the lowliest clerk in his service. . . . The pages of this chivalric fiction were thumbed with an enthusiasm amounting to a passion. . . . The aristocracy of every shade and degree, including its womenkind, and even the clergy, devoted much of their ample leisure to this diverting pastime." (See reference 3.)

The prose novels of chivalry, which Cervantes satirized in *Don Quixote*,

delight in childlike fantasies of overcoming all difficulties, vanquishing all foes, and being rewarded with treasure and success in the process. The hero and characters in the chivalry stories are basically cardboard figures without internal conflicts and can be said to have no psychology at all. The pop-up characters in Adventure are limited in the same way.

Adventure and the novels of chivalry are based on a story structure of more or less independent units that are strung together and can be expanded infinitely. Today, we do not usually consider plot profusion and complexity as positive literary attributes, but this was not always the case. In the Renaissance, entangledness and complexity of plot were regarded as admirable qualities; the novels of chivalry have been considered "vast, almost unreadable jumble(s) of episodes that stand as a fitting monument to sixteenth-century taste for the fantastic." (See reference 4.)

Similarly, complexity in Adventure is achieved through the difficulty of remembering the layout of the cave and through the intricacies of the brainteasers you encounter. Such complexity seems to appeal to the computer enthusiast mentality. In *The Second Self* (see reference 5), Sherry Turkle comments on the worship in the computer subculture of the fantastic, the bizarre, and the intricate. This applies not only to a style of programming but also to tastes in literature (science fiction and fantasy) and music (baroque and jazz).

The loose structure in the prose novels of chivalry promoted joint or multiple authorship, another characteristic of text adventures. John O'Conner writes: "In general, the longer a chivalric prose narrative, the better and more influential it was. This kind of tale was written in such a way that, if popular response warranted, succeeding books could easily be added. Hence, the number of volumes a romance finally attained is an approximate gauge of its popularity." (See reference 4.)

The same can be said for text adventures as they get passed around on computer networks, modified, and expanded: the longer, the better.

IF and Fantasy/Science Fiction

In fantasy and science fiction, the author makes up an imaginary world and plays with the probable consequences of a set of rules that may be different from those governing our real lives. The author can set up the rules for the imaginary world in any way desired, but he or she must abide strictly by them.

This attitude toward rules is similar to that in computer programming, where the rules are arbitrary but absolutely binding. It is also an age-old literary technique.

continued

...and a lot more in the future.

With the DISC DATA MANAGER, you can add more disc drives as your need for storage grows. Adding one or more drives gives you a capacity range from 160 MB to over 1 gigabyte.

Using multiple drives, you can perform overlapping operations. Or back up important files on separate drives. There's even an optional 40 MB tape drive for archival storage.

Best of all, the DISC DATA MANAGER is made by Seagate, the people who have built reliable performance into more than 5 million 5¼" hard disc drives.

For more information on the storage subsystem that grows with you, call us. 800-468-DISC. In California, 800-468-DISK. Ask for Tim.

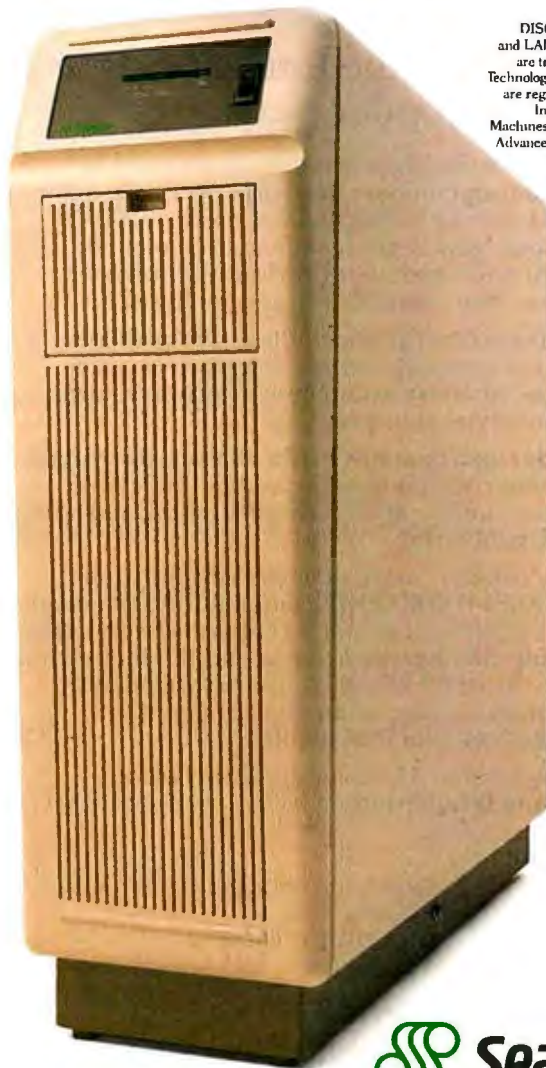

DISC DATA MANAGER and LAN DATA MANAGER are trademarks of Seagate Technology. IBM and PC-DOS are registered trademarks of International Business Machines Corporation. Novell Advanced Netware is a trademark of Novell, Inc.

 **Seagate**

C the Advantage.

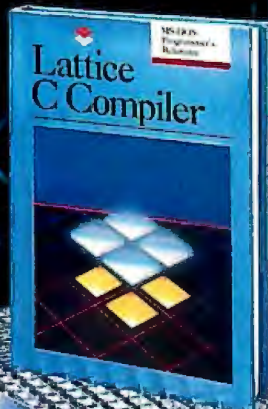

Now, with
MS Windows
Support!

Introducing the Lattice[®] MS-DOS C Compiler, Version 3.

There's never been a better time to buy Lattice C. Professional programmers the world over have made Lattice C the standard compiler for serious MS-DOS programming. Now Version 3 offers even more of the features that have made our previous versions so popular. Our new compiler features include:

ANSI language constructs including, *unsigned* as a modifier, *void* data type, *enum* data type, structure assignments, structure arguments, structure returns, and argument type checking.

The compiler also contains better aliasing algorithms, more efficient code generation, and more flexible segmentation, in-line 8087 code generation, and 80186/80286 code generation.

The library contains more than 200 new functions, including: ANSI/UNIX/XENIX compatibility; extended support for MS-DOS; extended support for networking including file sharing, file locking, and I/O redirection; and flexible error handling via user traps and exits. Plus the library has also been re-engineered to produce much smaller executables.

Try the new Version 3 C Compiler from Lattice. Because C-ing is believing.



Lattice

Lattice, Incorporated
P.O. Box 3702
Glen Ellyn, IL 60138
312/858-7950 TWX 910-291-2190

INTERNATIONAL SALES OFFICES:

Benelux: Ines Datacom (32) 2-720-51-61

Japan: Lifeboat Inc. (03)293-4711

England: Roundhill (0672)54675

France: SFL (1)46-66-11-55

Germany: (49)7841/4500 (49)8946/13290

ADVENTURE AUTHORIZING

Around 330 B.C. Aristotle wrote

The poet should choose probable impossibilities rather than incredible possibilities . . . if a poet does take such [an impossible] plot and appears to have handled it with some appearance of probability, the absurdity may be pardoned. Even the improbabilities about putting Odysseus on shore in the Odyssey would clearly not be tolerable if treated by an inferior poet. As it is, the skill of Homer conceals the absurdity and makes it pleasing." (See reference 6.)

Adventure's authors drew some of the content, characters, and motifs from science fiction and fantasy literature, especially from Tolkien's *The Lord of the Rings*. Don Woods says that he had glanced at Tolkien's description of Orodruin (Mount Doom, the volcano in the Land of Mordor where the evil Sauron forged the One Ring of Power) before he wrote the "Breathtaking View" scene in Adventure. Tolkien says of Mount Doom,

. . . its ashen cone would grow hot and with a great surging and throbbing pour forth rivers of molten rock from chasms in its sides. . . some would wind their way into the stone plain, until they cooled and lay like twisted dragon-shapes vomited from the tormented earth. Sam beheld Mount Doom, and the light of it. . . now glared against the stark rock faces, so that they seemed to be drenched with blood." (See reference 7.)

Compare this to the beginning of Wood's "Breathtaking View":

Far below you is an active volcano, from which great gouts of molten lava come surging out, cascading back down into the depths. The glowing rock fills the farthest reaches of the cavern with a blood-red glare, giving everything an eerie, macabre appearance.

How is Interactive Fiction New?

Although the story content of Adventure and other interactive works is related to established forms of literature, IF also differs from them on a very basic level—the reader's participation in creating the story and text makes the reader both a character and, in some sense, the coauthor of the story.

In IF, the nature of the text is also changed. The fluid computerized text allows a personalization and individualization of a literary work. The reader can talk to the text, and the text, in the form of the story's narrator, can talk back to the reader.

continued

SYNC TWICE.

MULTISYNC™ SETS ANOTHER INDUSTRY STANDARD WITH A GRAPHICS BOARD THAT OFFERS PGA RESOLUTION AT AN EGA PRICE.

Another standard from MultiSync.™ First, the MultiSync monitor, the original color monitor compatible with CGA, EGA, and PGA graphics adapters.

Now, the new MultiSync GB-1 graphics board.

With a MultiSync monitor, the GB-1 actually takes EGA all the way to PGA resolution — 640 X 480!

Compatibility is no problem. The GB-1 syncs with EGA and CGA color text and graphics, and with MDA and Hercules™ monochrome.



Built-in screen drivers ready for 1-2-3,™ Windows,™ AUTOCAD,™ Dr. Halo II.™

So you're ready for the top spreadsheet, window and CAD/CAM programs in ultra high resolution, without investing in more boards. Even a parallel printer port is included.

Free Dr. Halo II software.

This powerful program provides dramatic color for business graphics. With smoother scrolling, Hardware Zoom. Hardware Viewport. And pixel panning.

Desktop publishing comes true.

When you create graphics for business presentations, your free Dr. Halo II software works like a paint brush. Just pick your palette, and



MULTISYNC™ COLOR GRAPHICS BOARD

work in the clearest colors. It accommodates a wide assortment of type fonts, too.

132 column spreadsheets.

You can display up to 132 columns by 44 lines. With text, your screen will show nearly a full page.

See your MultiSync dealer. He has the graphics board and the monitor that will open your eyes. Your computer's too.

For product information and sales assistance, call 1-800-447-4700.

For technical assistance and information, call 1-800-NEC-SOFT.

**NEC Home Electronics (U.S.A.) Inc.
Computer Products Division
1255 Michael Drive
Wood Dale, Illinois 60191.**

C&C Computers and Communications

MultiSync is a registered trademark of NEC Home Electronics (U.S.A.) Inc. 1-2-3 is a registered trademark of Lotus Development Corp. Windows is a registered trademark of Microsoft Corporation. AUTOCAD is a registered trademark of Autodesk, Inc. Hercules is a registered trademark of Hercules Computer Technologies. Dr. Halo II is a registered trademark of Media Cybernetics, Inc.

NEC

*An acquaintance
has calculated that
the 'battery maze'
in Adventure can
be experienced in
187 billion trillion
unique ways.*

In conventional literature, a "gap" occurs when readers must interpret for themselves what the text means; the story is told, but its meaning is not. IF, however, contains not only gaps in meaning, but physical gaps in the text that the reader must fill in. These physical gaps in the interactive text allow such a wide range of explanations or interpretations of the fictional events taking place in Colossal Cave that it often seems as if different readers are not reading the same story. Some people play Adventure strictly as a game, while others read it as a straight story about exploring a cave and discovering the treasures.

Many, however, see Adventure as a story with deeper meanings. One player/reader believed the treasures in the cave were left by the good wizard of a long-vanished civilization, whose long-lost secrets would be revealed only when all of the puzzles in the cave were solved completely.

Another reader, a camper-backpacker, imagined that careless spelunkers had left the treasures in the cave. Yet another reader interpreted taking the treasures in the cave as stealing them.

The texts these three readers created were completely different because they read different stories into Adventure. This apparent drive to make context is a reflection in some ways of readers' psychological needs.

Some attempts have been made in more conventional literature to allow the reader choices about how a story unfolds, such as the "Choose Your Own Adventure" series. These books contain many story units; each lasts only a few pages and is complete in itself. At the end of a unit, either the story ends or you are given a choice and the story continues.

The artistic effects of these techniques fall far short of those in IF, due to the linear nature of text printed on paper. In IF, you make choices about each individual step and construct the story units for yourself; the choices are not predefined.

The quantitative difference between the number of possible stories in computer-based fluid text and the printed texts is also great. In one printed book, *The Cave of Time* (see reference 8), for example, there are 56 possible stories. In Adventure, the number of different stories must be, strictly speaking, infinite, since you can travel in repetitive loops within the cave and type in any comment and elicit at least some response. Even without resorting to loops and nonsense commands, though, the number of distinct possible texts is astronomical. A scientist acquaintance has calculated that the "battery maze" in Adventure alone (which has 12 different locations, 11 of them connected to 9 or 10 of the others) can be experienced in 187 billion trillion unique ways.

The fluid nature of interactive text and its computer medium explodes the traditional literary concept of the individual authorships of a printed text. In some ways, the authorship and transmission of the interactive text is similar to those of oral literature. With a printed text, we generally have the idea that there is a single author who "owns" the text; copy-righting reflects our views about this. But in oral literature and IF, single, joint, multiple, communal, unknown, and anonymous authorships are common. Adventure, for example, was first written and released by William Crowther, enlarged and improved by Don Woods, and released again. There are now many versions of Adventure, and programmers often personalize the programs so that the dwarves have the names of their friends, enemies, or despised professors, for example.

Bringing Beauty to the Beast

For those who would like to write interactive fiction, a few suggestions and observations follow. I have based them on the scripts of the texts readers created while playing Adventure and on the varying degrees of enthusiasm the readers expressed in interviews when they discussed Adventure's literary qualities.

1. Provide a unified but open text. In traditional literature, almost everything of importance to the story itself is explained to the reader. If a cave bear were locked up in golden chains in a conventional story, the author would probably explain somewhere who locked it up and why. This doesn't happen in Adventure. You not only stumble in surprise upon the events; you never really find out what they mean. Unfortunately, in Adventure, they usually don't mean anything.

I would suggest that any text adventure writer make up a supra-story, that is, a story that explains every object and the

behavior of every creature, even though you don't reveal this supra-story to the reader directly. The events will then have an inner coherence, but readers can project their own supra-story onto them, just as each person arrives at a personal meaning for a poem.

2. Take advantage of step-by-step build-ups. "Breathtaking View" was the aesthetic highpoint of Adventure for many readers. From the first hint of rumbling in the distance, through the stifling passages with their trembling walls, to the stunning vision of the volcano, most readers were gripped with emotion. Not surprisingly, many readers felt let down when they found out that nothing happens at the viewpoint. This letdown was one of the aesthetic low points of the game. The lesson to be learned is, if you build up story tension, make sure something exciting happens!

3. Give the puzzles a moral quality. For many people, merely winning points for gathering treasures is not as emotionally satisfying as doing good and overthrowing evil to win the points or treasures. Most readers preferred using the treasures and doing something with them later on, not dragging them back to the surface to win points. For example, several people told me they thought the hungry bear bound with the golden chains was the most enticing problem because they were emotionally involved with it. They didn't want to hurt the bear, yet they were mildly afraid of it. When the puzzles have a moral dimension, it gives them emotional depth.

Although there is no moral basis to the text in Adventure or to the solutions of the narrative puzzles themselves, the reader practices reality testing as a principle of action, which can be useful when carried over into the real world. While playing Adventure, readers test their interpretation of the story and events many times over. If you can't solve a puzzle, you must face the fact that you don't have enough information, that you overlooked or misjudged the information you do have, or that your general view of the story might be wrong. You have to maintain a critical attitude toward yourself and the fictional situations you confront, even as you are making choices. Needless to say, this can be a useful philosophy of life.

4. Create a narrator with a unified personality and vision. The narrator of a story is the one who tells the story in the text. Readers know that whoever or whatever they are talking to has a personality. Sometimes it is peevish, petulant, or whining; sometimes it seems to laugh at the reader. Make sure that your game has a personality that is consistent

continued

THE POWER OF POSITIVE SYNCING.

THE ONE COLOR MONITOR WITH COMPATIBILITY ACROSS THE BOARD.

The NEC MultiSync™ is the most popular color monitor in its class today. In fact, it's in a class by itself. It's the first color monitor compatible with all three PC graphics boards made by IBM®—PGA, EGA and CGA.

Dollar for dollar, it delivers the best color resolution as well. With clarity and detail limited only by the board in your machine.



THE INTELLIGENT MONITOR.

NEC technology gives MultiSync circuitry that automatically scans incoming frequencies, then adjusts to anything from 15.75 KHz to 35 KHz. No switches to switch, no instructions from the keyboard. The monitor does it. Automatically.

MultiSync functions in TTL and analog modes. Delivers 7 switchable colors. And its resolution climbs as high as 800 horizontal dots and 560 vertical lines on a 14 inch screen.

C&C Computers and Communications

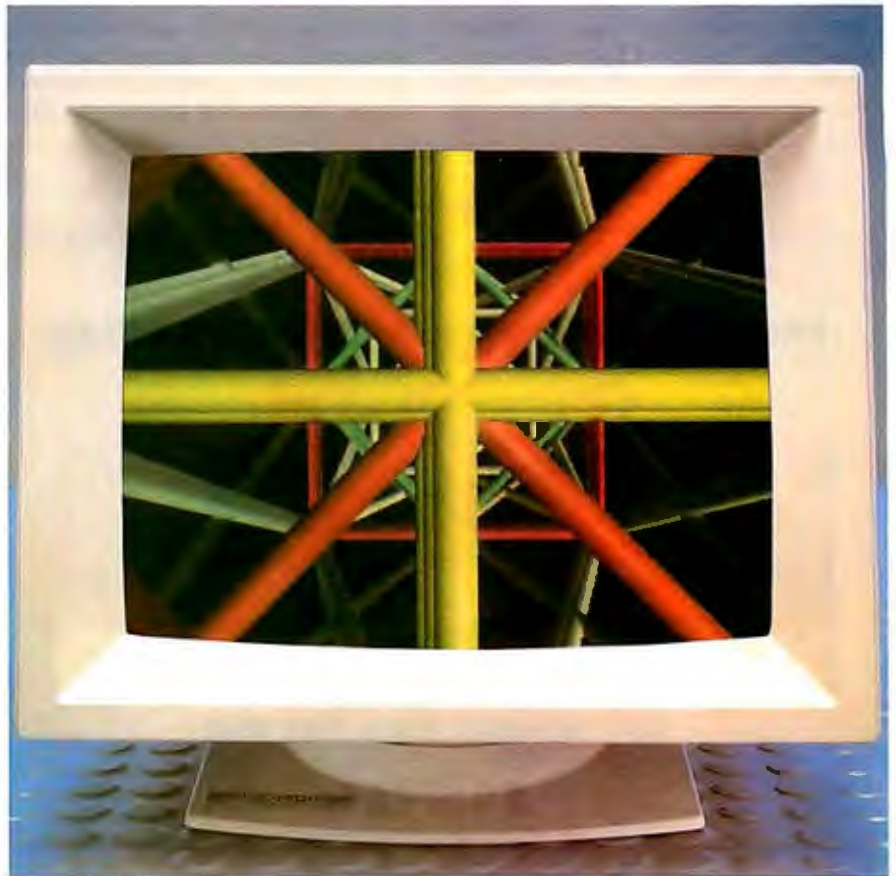

M U L T I S Y N C™

THE INTELLIGENT CHOICE.

MultiSync is the first monitor you should consider, because it's good enough to be the last monitor you'll ever need.

So whether you're buying your first system, upgrading to color, or moving into professional business graphics, desktop publishing or CAD/CAM, visit your nearest dealer.

See a demonstration of the power of positive syncing. It will give you something great to think about.

For product information and sales assistance, call 1-800-447-4700.

For technical assistance and information, call 1-800-NEC-SOFT.

NEC Home Electronics (U.S.A.) Inc.
Computer Products Division
1255 Michael Drive
Wood Dale, Illinois 60191.

NEC

MultiSync is a registered trademark of NEC Home Electronics (U.S.A.) Inc. IBM is a registered trademark of International Business Machines.

from the reader's point of view.

You should also watch the narrator for consistency in what it does or doesn't know. For example, in Adventure, some readers seem confused as to whether the narrator knows the entire layout of the cave and is simply hiding it from them, or whether the narrator only knows about what it sees directly in front of it. They also are not quite clear about what the narrator is: a robot like R2D2, a computer like "HAL" in *2001, A Space Odyssey* or some entity with feelings of its own. You don't need to explain the narrator to the

readers directly, just make sure you've got a clear image of it in your own mind.

5. Test your interactive story on other people. Get as many people as you can, in as many combinations as possible to play or read your story for you. Then watch them and ask them questions, during or after the game. (Some people are not able to explain what they are thinking or get frustrated if they get interrupted while they're playing.) The most revealing interviews or readings are often made by two or three people playing together at once. Group players often discuss and argue

about whose interpretation of the fictional events is correct. This is an excellent way of finding out the various ways people interpret the events.

Have the computer make a script of the game as it is being played, which includes both the game prompts and the reader's responses. After studying the scripts, you can modify your program to deal with players' commands and vocabulary that you hadn't considered before. For example, one Adventure player assumed that "lamp" meant "flashlight," while others thought of it as Aladdin's lamp. The authors were clever enough to prepare responses consistent with either meaning.

The Future of Interactive Fiction

The first interactive texts were written by programmers who thought of them mostly as games, and the literature they created is unsophisticated. The computer itself, however, does not limit IF to frivolous works. Consider the development of film. Early film was an unsophisticated medium, "so crude in its initial stages that it was considered to be beneath contempt" (see reference 9). Only with D. W. Griffith's "Birth of a Nation" and, later, Charlie Chaplin's films, did audiences become aware that film could transmit and aesthetically mature experiences.

Now interactive stories are being written by traditional authors with technical assistance from programmers. Perhaps it will take someone who is both a programmer and an author to explore the artistic promise of IF and create works of literature that rank with the classics of traditional literature. ■

REFERENCES

1. Buchloh, P., and J. Becker. *Der Detektivroman*. Darmstadt: Wissenschaftliche Buchgesellschaft, 1973, page 70.
2. Stevenson, R. L. *Treasure Island*. London, New York, Toronto: Oxford University Press, 1955, pages xiv-xv.
3. Leonard, I. *Books of the Brave*. New York: Gordian Press, 1964, pages 19-20.
4. O'Conner, J. *Amadis de Gaule and Its Influence on Elizabethan Literature*. New Brunswick, NJ: Rutgers University Press, 1970, page 4.
5. Turkle, S. *The Second Self: Computers and the Human Spirit*. New York: Simon and Shuster, 1984, pages 175-183.
6. Gilbert, A. (ed.). *Literary Criticism: Plato to Dryden*. Detroit: Wayne State University Press, 1962, page 107.
7. Tolkien, J. R. R. *The Lord of the Rings*. New York: Ballantine Books, 1954, page 214.
8. Packard, E. *The Cave of Time*. New York: Bantam Books, 1979.
9. Deer, H. and Deer, I. *The Popular Arts: A Critical Reader*. New York: Charles Scribners Sons, 1967, page 9.

SYMMETRIC
ΣΥΜΜΕΤΡΙΚΟ

THE 375 - A SOFTWARE DEVELOPER'S DREAM

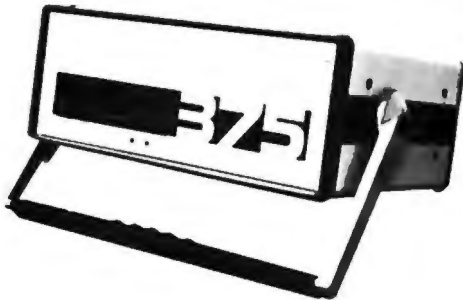

THE BEAUTY AND THE BSD

\$4,995*

OVER 1,000 PROGRAMS, 3,000 FILES !

Full 4.2BSD UNIX™

Each 375 comes standard with a complete configurable 4.2BSDUNIX system. We don't skimp on software. And we can even give you EMACS, INGRES, TEX and SPICE for those special applications.

Loaded With Languages

Turn on your 375 and start developing your own applications. It's that easy. C, FORTRAN, PASCAL, BASIC, APL, Assembler, LISP and PROLOG: they all come standard on every 375.

Loaded With Standard Features

- ★ 50MB Winchester Disc Drive
- ★ 1MB 5¼" Floppy
- ★ 2MB RAM (8MB optional)
- ★ Integral SCSI & ST506 Interfaces
- ★ 4 RS232 Ports (up to 36 optional!)
- ★ Parallel Printer Port
- ★ External Winchester and Floppy Ports
- ★ Series 32000, 10MHz, VM, FPU

Also Available: 10 Mb ETHERNET, up to 280MB disk memory, streaming tape, and more !

A Portable Computer for the Serious User

At last, a powerful, portable (22lbs) scientific computer for all your serious work. The 375 combines the advantages of a VAX™ with the size, versatility, and price of a micro. All the software tools are there. It's even small enough to leave on your desktop or take wherever you need it. **And it's available direct to you right now !**

CALL US TODAY (408) 279-0700

SYMMETRIC COMPUTER SYSTEMS - 1620 Oakland Rd. Suite D200 - San Jose, CA 95131

* Prepaid. Sales tax and Shipping Costs not included.
UNIX is a registered trademark of AT&T Bell Labs.
VAX is a trademark of Digital Equipment Series 32000 is a trademark of National Semiconductor Corp.

Now the best is twice as good.

How could anything be twice as good as the Norton Utilities™?

Good question.

After all, the Norton Utilities is far and away the best-selling program of its kind in the world.

Its remarkable UnErase™ feature has rescued the data—and the derrières—of thousands of grateful PC users.

While its passel of popular disk management programs is about the most useful thing to happen to PCs since MS/DOS.

So what could possibly be better than the Norton Utilities?

Better than ever.

Well, for starters there's the Norton Utilities Version 4.0.

It works all the same time-saving and data-saving wonders of our earlier versions—many of them three to five times faster than before.

It also performs several entirely new functions that are worth the price of the program all by themselves.

Like the unique *File Info* which lets you attach descriptions of up to 65 characters to your files.

(That is, if you can think of one that long.)

The new *Norton Integrator* lets you control every single Utility from a single program, and gives you on-line help for each function.

While the new user

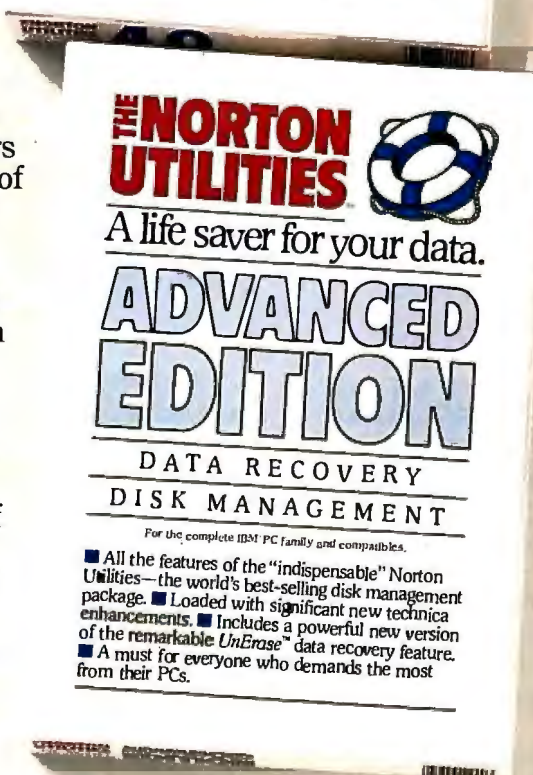
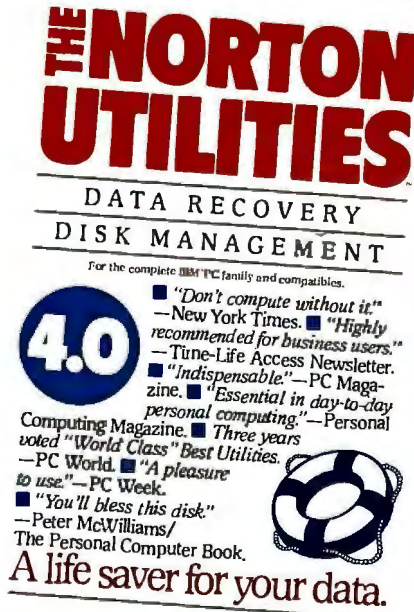

interface makes the Utilities so quick and easy to run it's ridiculous.

Better yet.

All of which brings us to the new Advanced Edition of the Utilities.

Because the Advanced Edition contains all of the features, functions and enhancements of Version 4.0.

Along with a wish list of technical features and functions sufficient to satisfy the yearnings of all those customers who've been politely writing and calling to request them.

Like *Speed Disk*, for tightening up disk space and optimizing access.

And *Format Recover*, for unformatting your accidentally reformatted hard disk.

If you're so inclined, you can explore absolute disk sectors, edit file directories, even attack the FAT table.

And, for the first time, get the upper hand on your hard disk's partition table.

Which of the new Norton Utilities is best for you is up to you, of course.

But one thing's for sure.

Either way, you'll get the best of Peter Norton.

Peter Norton
COMPUTING

The improvements

The original 8-MHz
COMPAQ DESKPRO 286.
Best in its class.



Introducing the new 12-MHz
COMPAQ DESKPRO 286.
50% faster, 100% Compaq.

You've never seen this much performance in an 80286-based desktop. Numerous enhancements to its proven technology are one more example of how Compaq maintains its industry leadership by improving and innovating.

Compaq raised the standard from 6- to 8-MHz processing speeds. Now we're setting the pace again with 12 MHz, so you can run industry-standard software up to 50% faster.

And so you won't lose compatibility, we pioneered dual-speed processing, which reduces speed from 12 to 8 MHz in the few cases it's needed.

Compaq also maintains hardware compatibility with 8-MHz expansion slots that let you use industry-standard expansion boards, modems and add-ons without sacrificing your 12-MHz speed.

Hidden assets

While many manufacturers cripple high-speed processors with low-speed RAM, Compaq gives you up to 2.1 Megabytes of 12-MHz RAM on the system board without using an expansion slot, 8.1 Megabytes using only three.

Speed is also boosted by high-performance 20-, 40- or 70-Megabyte fixed disk drives with some of

are out of sight



The new 12-MHz
COMPAQ DESKPRO 286.
Now the best is better.

the industry's fastest access times. And to protect data, we offer an internal 40-Megabyte fixed disk drive backup system, another innovation.

Uncompromising vision

The COMPAQ DESKPRO 286 gives you better display options than any other PC in its class.

The COMPAQ Dual-Mode Monitor displays both high-resolution text *and* graphics. And the COMPAQ Color Monitor and COMPAQ Enhanced Color Graphics Board support EGA and CGA standards, displaying 16 colors at once from a palette of 64.

You get more expandability too—with seven available full-height expansion slots and room for four *internal* half-height storage devices, including 1.2-Megabyte or 360-Kbyte diskette drives.

See for yourself

Our improvements may be hidden, but they're clearly apparent in superior performance. That's why the most demanding users prefer Compaq. And why we can offer a full-year limited warranty.

Seeing is believing. For the location of your nearest Authorized COMPAQ Computer Dealer, or for a free brochure, call 1-800-231-0900, operator 20. In Canada, 416-449-8741, operator 20.

©1987 Compaq Computer Corporation, all rights reserved.

COMPAQ[®]

It simply works better

The single best way to turn your PC-AT into a multi-user system.



Introducing the Wyse WY-60.

Now there's a perfectly compatible, reliable, economical, Wyse way to get multi-user mileage from your PC-AT. Wyse WY-60 terminals give you complete compatibility for your IBM Personal Computer AT systems, right down to the exact keyboard layout, character set and display features.

The only thing different is how much cleaner and more readable your information is with the WY-60's high resolution and flat, non-glare, 14" tilt/swivel screen.

Multiple display formats go up to 132 columns and 44 lines on one screen, to get the most out of applications such as Multiplan and WordStar.

And a 512-character downloadable soft font is also there when you need mathematical symbols or customized character sets.

The adjustable arm is optional, and you can choose a green, white or amber screen.

No wonder we ship more terminals than anybody but IBM.*

Call toll-free or write, today, for more information. Wyse Technology, Attn: Marcom Department 60-AT, 3571 N. First St., San Jose, California 95134.

Call 1-800-GET-WYSE

WYSE

YOU NEVER REGRET A WYSE DECISION.



Wyse is a registered trademark of Wyse Technology. WY-60 and the "V" shaped design are trademarks of Wyse Technology. IBM and IBM Personal Computer AT are trademarks of International Business Machines Corporation. WordStar is a registered trademark of MicroPro International. Multiplan is a registered trademark of Microsoft Corporation. © 1986 Wyse Technology. *Dataquest 1985 terminal shipment update.

Desktop Publishing

The Desktop-Publishing Phenomenon..... 149
by John W. Seybold

Make My Page!..... 159
by Thom Holmes

Designing a Raster-Image Processor.... 171
by Jon Barrett and Kirk Reistroffer

Programming in PostScript..... 185
by Denis G. Pelli



Introduction

Desktop Publishing



Very few developments in microcomputers have grabbed the attention of computer users quite like desktop publishing. In essence, desktop publishing gives you total control over the creation of the printed word. It provides a method for producing professional-looking documents without the need for outside typesetters and graphic artists. You can now write text, edit text, draw illustrations, incorporate photographs, design page layouts, and print a finished document with a relatively inexpensive computer and laser printer. Desktop-publishing systems can decrease the cost of producing documents and increase the flexibility for producing timely results.

But "desktop publishing" is a deceptively simple description for an extremely complex group of hardware and software tools. This new technology came about through a unique combination of existing technologies: faster personal computers, sophisticated word-processing programs, and laser printers based on photocopier technology. Practically every functional use of a microcomputer, from text processing to graphics manipulation to communications, is involved in the average desktop-publishing program.

John W. Seybold, a pioneer in the field of computer-aided typesetting and publishing, examines how desktop publishing has developed. His article "The Desktop-Publishing Phenomenon" describes how the development of the multi-function Altos workstation at the Xerox Palo Alto Research Center, the Xerox Star computer, and the Apple Lisa led to today's crop of sophisticated computers and graphics environments. He also establishes the criteria for what he considers a useful "platform" for a desktop-publishing system.

Choosing the correct software is a critical step in building a desktop-publishing system. There is a bewildering hierarchy of programs, from sophisticated word processors to typesetting programs, page layout programs, and dedicated publishing systems. Some are designed for novice users or simple applications such as pamphlets or small newsletters. Other packages are designed for more technical uses, such as page composition for book publishing. Thom Holmes, in his article "Make My Page!," takes you through this jungle and

gives you a specific set of guidelines for the selection of software. He describes the composition features to look for, examines the strengths and weaknesses of several page-composition packages, helps you decide between the Apple Macintosh and the IBM PC computers, and lists all available desktop-publishing packages.

Jon Barrett and Kirk Reistroffer give a behind-the-screen look at how the image you see on the screen eventually appears on paper. In their article "Designing a Raster-Image Processor," they take us through a generic electronic-publishing system. Starting with a screen display of characters, the authors explain how a bit map of the text is manipulated and how proportional spacing, kerning, and ligatures are handled by software and hardware. They describe several page-description languages and explain how a PDL can take a 75 dot-per-inch screen display and transform that into data for a 300-dpi laser printer. Finally, they explain how the raster-image processor takes this data stream and transforms it into pulses of laser light in the laser printer.

Some desktop-publishing products are being used in ways their developers never imagined. Denis G. Pelli, a visual psychophysicist, has developed a different way of using the page-description language PostScript. In "Programming in PostScript," Pelli describes how he realized that Postscript-based output devices, such as laser printers or typesetting machines, could be programmed directly and used to create graphic images from mathematical descriptions. Writing his own PostScript programs, Pelli has developed subtle graphics patterns that help him study how people interpret visual information. He shares his knowledge and PostScript code and shows how you can program PostScript-based output devices to produce your own graphics.

Jerry Pournelle once said that microcomputers are a hardware implementation of the First Amendment. Desktop publishing is certainly a new form of freedom of speech. It enables us to manipulate and distribute information more easily than ever before. Yet there is a price to be paid for this freedom. With total control comes total responsibility.

—Stanley J. Wszola, *Technical Editor*

The Desktop-Publishing Phenomenon

*Personal printing has come a long way
in a short time*

John W. Seybold

EVERYBODY UNDERSTANDS WHAT you mean when you say "desktop publishing," even those who have never used a computer. As a concept, it's compelling. As a product offering, it's the best thing that ever happened to personal computers. As a fillip for a market that—at least temporarily—had lost its momentum, it has been a godsend. As a harbinger of personal-productivity tools, it has been and will continue to be a prime example. Yet, in a sense, desktop publishing is a slippery product without a clear-cut definition.

The term is not old, and its origins are readily traceable. Paul Brainerd of Aldus, father of PageMaker, gets credit for coining the phrase. Apple Computer, looking for a vehicle to dramatize the Macintosh's capabilities, had the perspicacity to go all out on a promotional campaign. Without the Apple LaserWriter, desktop publishing would never have existed—desktop publishing didn't really make its debut until Apple announced the LaserWriter in January 1985. That was a short time ago, and a lot has happened since.

But the concept didn't just come out of the blue; an interesting history lies behind it. It originated in 1973, when an experimental multifunction workstation was developed at the Xerox Palo Alto Research Center (PARC). That workstation, the Alto, was the most important unannounced computer product of the 1970s. It was conceived as a completely self-contained, single-user computer, although its principal mission was to communicate with other similar devices over

the original 3-megabit Ethernet local network. Because its designers had graphics applications in mind, the Alto had a high-resolution bit-mapped display screen and a mouse-pointing device.

No one intended the Alto to be a widely used system. Each run of Altos was supposed to be the last, but by 1981 over 1200 had been installed on 46 Ethernet networks in seven geographic areas. Outside of Xerox, Altos were assigned to a few selected sites, including the White House, the House of Representatives, the Senate, a few universities (especially Stanford), and several undisclosed locations in the U.S. and Europe. The large base of users provided input as to what was right and what was wrong with the Alto and the various software packages that had been developed for it. These included Bravo, Gypsy, Markup, Draw, SIL, and Laurel—for text editing and formatting, creating pictures and diagrams, and providing electronic mail by means of a central file server.

Even more important, PARC alumni disseminated their fascination with this product, and the ideas it generated, throughout the computer industry—especially on the West Coast—wherever they took on new roles as key members of advanced development teams.

From the Alto came the Star, developed under the aegis of Dave Liddle, vice president of office systems within Xerox's Office Products Division, and announced on April 27, 1981. The Star perpetuated four key concepts. The first was "seeing and pointing" rather than "remembering and typing." "Progress-

sive disclosure" reduced the apparent complexity of the system by presenting you with only the information relevant at that moment. "Uniformity of commands across domains" made system procedures consistent. Once you understood the basic logic of the machine, you could deduce what to do next without recourse to manuals. Last was WYSIWYG (what you see is what you get). The display on the screen should always be a close facsimile of the final printed document.

The Descending Star

The Star never reached any kind of ascendancy. It was poorly marketed, was too expensive, and lacked a reasonable output device. The 8044 Print Server, offered as an Ethernet peripheral, cost \$30,000.

But Steve Jobs had visited PARC and saw it all happen. He enlisted the support of some of the Star's major developers and brought out the Lisa, a \$10,000 desktop unit with a high-resolution bit-mapped display screen, a Motorola 68000 processor with a million bytes of memory, two high-capacity floppy disk drives, a 5-megabyte hard disk drive, a

continued

John W. Seybold (P.O. Box 644, Media, PA 19063) has been a pioneer in the field of computer-aided typesetting and publishing since 1963. He is the founder of The Seybold Report on Publishing Systems and author of The World of Digital Typesetting and Publishing from the Desktop.

The publishing process has suddenly become democratized and affordable beyond the fondest dreams of only a few years ago.

mouse, a user interface inspired by the Xerox Smalltalk system, and an impressively complete set of office application programs (LisaCalc, LisaGraph, LisaDraw, LisaProject, LisaList, and LisaWrite).

But the Lisa didn't have anything to write with that wasn't anticlimactic, even though its dot-matrix printer (with a standard resolution of 96 by 72 dots per inch) could move into a double-write mode of 160 by 144 dpi. The Lisa, too, was overpriced, ahead of its time, and not quite all there.

Still, the Lisa perpetuated the desktop metaphor of the Star and Alto. This metaphor is the origin of the "desktop" in desktop publishing.

The concept used almost all the screen to portray a desktop environment on which icons represented various familiar objects, images that you could point to and move about to make things happen. *The Seybold Report on Publishing Systems*, in describing this product in its January 31, 1983, issue, included a footnote that argued that, while some believe that the physical environment of an office needs significant change and shouldn't be emulated and "while we recognize many of the failings of the existing office, we also object to the arcane user interfaces typical of most computer systems . . . There can be no doubt that Lisa is different from many systems, and we are convinced that it is better than many systems because it uses icons."

Still, there was no desktop-publishing phenomenon. Nor did the phenomenon begin when Apple moved away from the Lisa and introduced the Macintosh in January 1984. It began in January 1985, when the LaserWriter made its debut. This \$7000 plain-paper "typesetter" incorporated Adobe's RIP (raster-image processor) and Adobe's professionally designed fonts licensed from the International Type Face Corporation. Moreover, the event received the blessing of the most famous professional typesetting manufacturer: Allied Linotype (formerly

Mergenthaler) threw tradition to the winds and embraced the technology, offering an interface, via Adobe's PostScript, to drive its Linotronic 101 and Linotronic 300 typesetters to produce truly professional output quality.

Aldus president Paul Brainerd had been in on the ground floor and played a role in persuading Apple that a typesetting application would be popular. The word "typesetting" is used in this context only because desktop publishing hadn't yet been invented, although with Aldus's PageMaker, and the hype that surrounded it, the term quickly emerged and conquered.

What Is Publishing?

As you can see from its history, the "desktop" part of desktop publishing was a product of the Xerox desktop metaphor, implying icons, bit-mapped screens, and the other features described above. The "publishing" part suggests that the LaserWriter would be more than a typesetter, since it could also serve as a final output device.

A typesetter produces only camera-ready copy from which printing plates are made, but you could use the LaserWriter to print multiple copies for distribution. This isn't very practical, however, because you'd want to print on both sides of the sheet (which is awkward), and the duty cycle of the LaserWriter won't support extensive emulation of a printing press.

"Publishing" also implies going beyond typesetting to produce graphics. While typesetting devices (now of the raster-image variety) have become increasingly capable of producing illustrative matter, this (with a few exceptions) was and is not commonly the way that graphics are reproduced. Generally, the platemaker or the camera operator combines graphics with text by stripping film onto the indicated page positions or double-burning illustrations onto printing plates that already contain the text.

Finally, "publishing" implies distribution to a readership. In its broadest sense, the word means to make known, presumably in a general way, to differentiate the activity from mere communications. Traditionally, publishing has implied the use of printing presses and paper, although today many publishers have ventured into nontraditional activities that make use of alternative media.

Thus, just as "desktop" is either too specific or too vague a term to provide a definitive description of the activity in question, so "publishing" is probably too ambitious or presumptuous. But the fact remains that the new technology has spawned a whole host of desktop publish-

ers who are publishing—writing, producing, and distributing—to a readership, and the publishing process has suddenly become democratized and affordable beyond the dreams of only a few years ago.

Not Just the Mac

So far, I have focused on Apple's Macintosh. This has been intentional because, without the Mac, I doubt if desktop publishing as we know it today would ever have happened. But nowadays desktop publishing isn't limited to the Mac, and it may not be principally pursued on the Mac in the future. However, desktop publishing does not necessarily include any and all efforts to apply personal computers to text processing (or even typesetting). No product deserves inclusion in the category unless it meets all or, at least, most of the following criteria (although many people might be inclined to argue with me).

First, the system should let you compose text in a manner that comes close to the requirements of typesetting—that is, well-designed and proportionally spaced characters—along with the ability to produce justified lines if desired, including automatic hyphenation. The latter is what the graphic arts industry calls h&j (hyphenation and justification). The process of composition also generally implies other typographical considerations, including the use of more than one type font or size, and a character repertoire more extensive than that available on a typewriter. It also embraces the setting of tabular matter, indents of all kinds, and perhaps aesthetic character kerning.

Second, the system should let you perform the composition tasks I've alluded to in a manner that is considerably less code-intensive than that which characterizes traditional computer typesetting. This strongly supports the WYSIWYG bit-mapped screen and an interface that lets you point to the effects desired rather than requiring that you describe them by some sort of command language. Command codes might inevitably be embedded in the text stream or in some sort of pointer file, but in either case they are transparent to the user.

Already I have excluded from my definition a good many typesetting programs written to perform professional typesetting, or which emulated them. These were code-intensive and required considerable user experience in markup and composition programming. There are a good many programs of this sort. In fact, they antedate desktop publishing. Some of them are powerful and go well beyond the capabilities of desktop publishing, but they are something else again.

continued

THE
ADVANTAGE



IS
EXPERIENCE

Experience counts.
Kaypro Corporation's 35 years of electronic products innovation can be seen in every detail of the new KAYPRO 386. In speed, power, and performance, the KAYPRO 386 is at the head of the class.

Time is money.
The KAYPRO 386, powered by Intel's 80386 microprocessor, runs most popular software two to three times faster. And when the pressure's on, every second counts. Whether it's engineering, business, networking, or any high-power pursuit, the KAYPRO 386 makes sense. Starting at \$4995, even the price makes sense.

Kaypro Is Computers
From the no-nonsense KAYPRO PC to the world's first AT-compatible, the KAYPRO 286i, Kaypro is computers. As with all Kaypro products, the KAYPRO 386 is backed by service and support that ensures maximum benefits for you and your business. And the advantage? Experience, pure and simple.

Seeing is Believing
To fully appreciate what the KAYPRO 386 can do, see it in action at your nearest Kaypro dealer. Put the KAYPRO 386 to the test. It's faster than you think.

KAYPRO[®]
COMPUTERS

The Future's Built In

KAYPRO
Lease-Link

Kaypro's Commercial Leasing

Trademarks: IBM and AT are trademarks of International Business Machines, Inc.; Intel, Intel Corporation.



For the Kaypro dealer near you, call 1-800-4KAYPRO.

Ask about...



Kaypro's Revolving Charge Plan

Third, the system should let you include graphics and output illustrative matter along with the text. This implies, for example, the existence of some sort of pagination or area composition program—not just what the industry calls “galley composition.” This feature also implies that you can create graphics on your system, import graphics into the system, or both. Graphics features created within the system do not necessarily need to be produced by the same software that handles composition, but the relationship between the handling of text and graphics must be as seamless as possible.

Illustrations can be generated by business graphics programs that pull figures from a spreadsheet and convert them into bar or pie charts. They can be created by painting, drawing, or CAD programs, or be scanned in from a peripheral device such as a scanner. They can even be captured by means of a video camera. Or perhaps the pictures can be moved over from a digitized clip-art collection. The pictures need not be derived from photographs (continuous-tone images) and screened to become halftones for purposes of reproduction, but they might well be. The system should also provide some means, within itself, to perform

a variety of manipulative tasks, such as sizing, cropping, image rotation, or enhancement.

Fourth, the system should offer some reasonably good editing capabilities. Ideally, you should be able to use the same kinds of editing tools offered by the best word processors and to make changes interactively, not merely to uncomposed text, but to text in the process of interactive composition. In other words, you want a system sophisticated enough to let you look at a composed page on the screen, identify a paragraph that needs rewriting, and make that change then and there, without reverting to some sort of input file. Whatever the system's capabilities are, desktop publishing clearly demands an effective editor as part of the package.

Finally, the system must be able to produce output on at least one device that offers a resolution of 200 or more (I would prefer to say 300 or more) dpi. Without this, you can't handle graphics, except a few bar charts and the like, and the quality of type doesn't deserve to be considered publishable. Beyond that, the system should interface to (or contain) one or more RIPs that work with PDLs (page-description languages) capable of pro-

ducing a variety of outputs, including output to a high-resolution typesetter. This is the beauty of PostScript, Interpress, and Document Description Language as page-description languages. And this is what RIPs are for—the hardware and software necessary to interpret and translate that language into commands to drive the desired device.

Not all so-called desktop-publishing systems meet all the criteria outlined above. Some of them fall quite short. Even PageMaker was unable to perform automatic hyphenation until recently. Many program developers have never heard of kerning. Some programs use type-width values that are simply too gross to produce good-quality output. I believe that type-width increments as tiny as 1/216 inch are essential, and I would prefer much finer increments. This figure is based on the reasoning that an increment should not be less than 1/18 of a printer's em (a unit of measure based on a piece of type that is as wide as it is tall), and an em needs to be at least as small as six points (1/72 inch).

Putting It All Together

A happy coincidence of events has been engendered or accelerated by powerful,

6.0 Now Released!
 • Larger Variables
 • Added Features

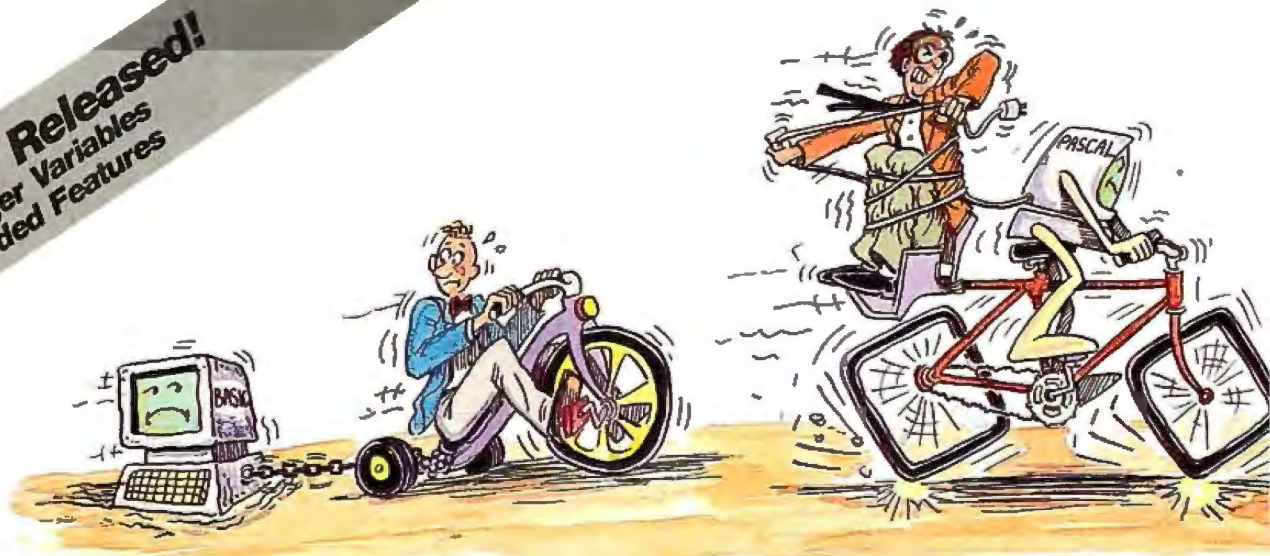

A Personal Language

When it comes to problem solving, the APL*PLUS System is the undisputed leader.

That's because the APL*PLUS System works with you. It goes far beyond what application software like Lotus® or dBASE® could possibly ever offer. And, it won't tie you down with the details of standard programming languages.

The APL*PLUS System is a personal language, with productivity features that help you concentrate on getting answers,

rather than struggle with intricate calculations and modeling.

With it you can manipulate tables of numbers as easily as single numbers and get quick results from your computer using short, simple statements.

When you've reached the limits of other packages, move up to the APL*PLUS System. It's a powerful and flexible tool that grows with you as your needs become more sophisticated. With over 200 built-in

applications—like graphics, report formatting and communications—you have all the tools at your fingertips to quickly and easily solve those seemingly impossible problems.

Best of all, the APL*PLUS System interfaces well with software packages you're already using—like databases, spreadsheets, and graphics packages. The APL*PLUS System also makes it easy to link those packages that aren't

low-cost computer chips: the advent of scanning and graphics packages, for example, and the ability to store a hyphenation dictionary in memory along with tables of width values and typesetting macros.

Another important technology was pioneered by Bitstream. It was able to transfer the art of type design into a computer science, and develop the contacts and initiative to get the rights to a library of classical type fonts and transform them into a database. The authority and persuasiveness of true type makes a significant difference between publishing and mere communications.

For many users, desktop publishing will end with laser-printer output. For others, such 300 dpi output, while a significant improvement over letter-quality daisy wheels, is the first step. The laser printer often furnishes merely the proofing copy, and then the output can be redirected to a true typesetting system, either convenient to the desktop of the user or by arrangement with a neighborhood trade typesetter.

Again I come back to the desktop. The implication is clear that the devices must be inexpensive, small, easily installed without the need for professional assis-

tance, and easily maintained. One person should be able to easily take control of the entire process. He or she can learn and practice all phases of it, more or less intuitively, keep track of all the components within the system, and function effectively in a creative and a production environment to produce publication-worthy products.

Publishing Platforms

Although the Macintosh and the LaserWriter started it all, others soon got into the desktop-publishing act. The IBM PC was, in some respects, an ideal platform for the development of a desktop-publishing system because it is ubiquitous, powerful, and open. In other respects, the PC has been awkward and frustrating. Graphics capability does not come easily to it, and no intuitive and seamless way exists for the user to flow copy and graphics into and through the system.

When applied to the Macintosh, the term "platform" is easy to understand. It consists of a certain amount of hardware and a clearly understood set of operating conventions sufficient (with the aid of an RIP in the output device) to provide a platform for the development of application software.

But the PC has no comparable platform. You must specify what kind of graphics board is available, and, to get an appropriate environment, you need Windows under MS-DOS or GEM under its own set of conventions.

Nevertheless, in describing available systems, you will often hear of a PC platform as if it did exist. I would caution you to make sure that some degree of seamlessness is possible with the aid of the particular planks used to build the platform you choose.

In a sense, the IBM platform, despite its ambiguities, is more congenial for the development of future desktop-publishing applications than the Macintosh, simply because it's more "naked" and can be clothed or ornamented more easily by clever designers. Some of the desktop systems for the PC platform are so powerful that it becomes impossible to draw a clear-cut distinction between desktop and professional publishing.

To draw such a distinction, once you are satisfied that all the typographical niceties are provided for, you have to look closely to determine whether you can "grow" a given desktop system for simultaneous use, in some sort of sharing and

continued

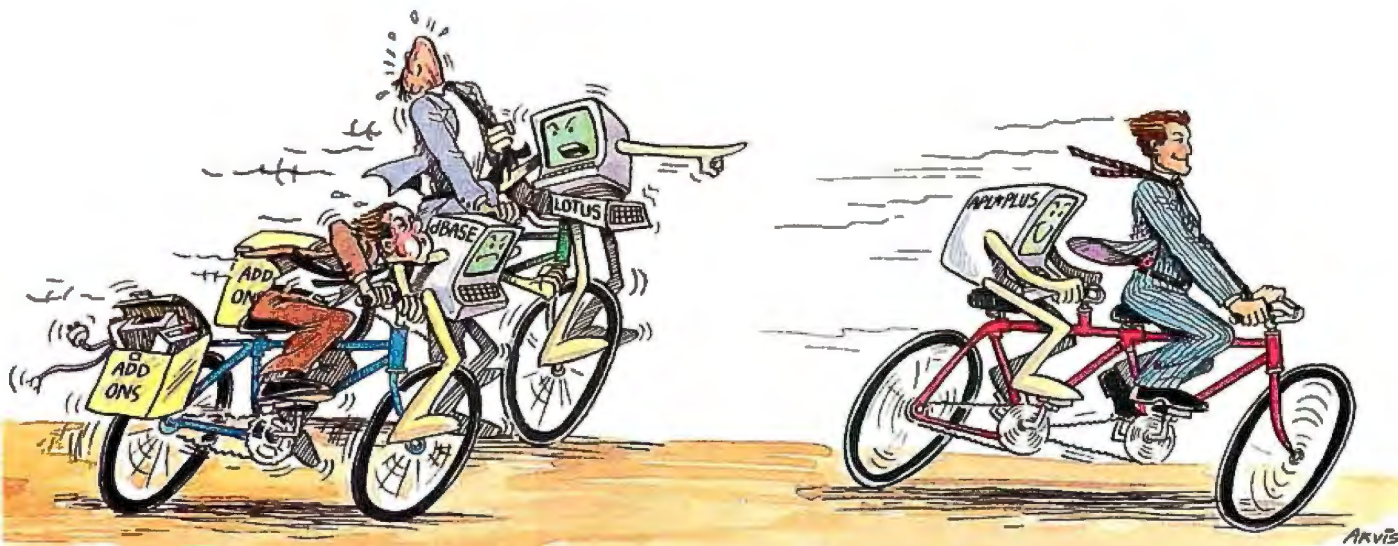

The APL★PLUS® System and You.

currently talking with each other.

With all this problem-solving power, it's no wonder STSC's APL★PLUS System is the personal choice of so many business professionals—financial planners, business analysts, actuaries, scientists, mathematicians, engineers, statisticians, and consultants. Especially since the APL★PLUS System is available on a full range of computers from desktops to mainframes.

Put the power, speed, and flexibility of the APL★PLUS System to work for you. See your local dealer today to get your APL★PLUS System. If they don't have it, refer them to STSC or call STSC toll-free, **(800) 592-0050**. In Maryland or Canada, **(301) 984-5123**.

Available nationally through Softset, Micro Central, and distributors worldwide. Dealer inquiries welcome.

Problem-Solving at the Speed of Thought

STSC STSC, Inc.
2115 East Jefferson St.
Rockville, MD 20852

APL★PLUS is a service mark and trademark of STSC, Inc. PLUS★WARE is a trademark of STSC, Inc. Lotus and dBASE are registered trademarks of Lotus Development Corporation and Ashton-Tate, respectively.

A PLUS★WARE™ PRODUCT

Inquiry 310

©1986 STSC, Inc.



FOCUS Computers

DO IT YOURSELF SPECIALS	
64K CHIPS	\$512.95
256K CHIPS	\$2.99ea.
8 873 INTEL	\$176.50
8 872 INTEL	\$165.50
8 286 INTEL	\$177.50
32 MEG HARD DRIVE	\$329.50
20 MEG HARD DRIVE	\$369.50
32 MEG HARD CARD	\$525.95
47 MEG HARD DRIVE	\$749.50
10 MEG HARD CARD	\$435.95

• COMPUTERS •

NEW SHARP PC 7000 A
Lightweight transportable that's also a desktop **LOW LOW LOW PRICE!**

AT&T The right choice
6300 20 MEG SYSTEM

6300 COMPLETE SYSTEMS WITH NEW EGA COMPATIBLE BIOS WITH 640 K MEMORY, 20 MEG WE HAVE MEMORY, FLOPPY DRIVE, THE BEST MONITOR, KEYBOARD. **PRICES**

AT & XT PACKAGES
WITH THE LOWEST PRICES

APPLE COMPUTERS

APPLE IIC CALL
MAC 512K/ENHANCED 1275
MAC PLUS 11649

SPERRY

SPERRY IT W/40 MEG LOW
SPERRY MICRO W/20 MEG CALL

COMPAQ

COMPAQ PORTABLE 256K WITH FLOPPY & 20 MB DRIVE LOW
COMPAQ PORTABLE II MODEL 4 WITH 80286 PROCESSOR AND 20 MEG DRIVE CALL

PANASONIC

FX600 WITH 8086, 256K FLOPPY AND 20 MEG DRIVE*1088 SR. PARTNER CALL

• MODEMS •

H Hayes Smartmodem 1200B/IBM 299.95

H Hayes Smartmodem 2400/RS 232 549.95

Amazing Modems 1200 Baud internal with software 98.45

Amazing Modems 2400 Baud internal with software 196.95

• MONITORS •

AMDEK 310A TTL (IBM) CALL

NEC multi sync everything all in one monitor EGA/PGA/CGA/ NEW LOW

Princeton Graphics HX12 hi res color RGB 398.95

• SOFTWARE •

PFS File +PFS Report 79.90

D Base III Plus 369.50

Evelyn Wood Speed Reading 38.50

One and Only Full Accounting Package 29.95

The Twin (EPlus 123 Clone) 49.95

Amazing Things Word Processor w/spell check 49.95

• PRINTERS •

PANASONIC (2 year warranty)

KXP 1080i NLO faster (120 cps) 188.50

KXP 1091i top rated (160 cps) 239.50

KXP 1595 15" carr. (240 cps) 449.95

EPSON

EPSON FX86E 358.95

EPSON EX1000 (300 cps) Heavy duty design 529.50

LX86 New (120 cps) 232.50

NEC

3550 Spinwriter LQ 729.50

OKIDATA

OKI 232 200 cps NLO LOW PRICE OKI 293 529.95

TOSHIBA

TOSHIBA P321 459.50

TOSHIBA P341 572.50

BROTHER

M1509 Serial/Parallel 358.95

All Printer Prices when purchased with cable

• LAP TOP COMPUTERS •

ZINUS data systems

Z181 Super Lightweight Laptop with 640K with 31/2" pop up floppys and many more features **SWE Have the Lowest Prices!**

TOSHIBA

T1100 Plus weighs under 10 lbs., yet has an 80C86 16-bit processor and 640K to run twice as fast as many other PCs **CALL**

Focus Computers, 1303 46th St., Brooklyn, N.Y. Tel. (718) 871-7600. Open Mon. - Thurs. 10-7; Sun. 10-6; Fri. 10-3. Most orders shipped within 24 hours. MasterCard, VISA, American Express gladly accepted. All prices in this ad reflect cash discount. New York State orders must add local sales tax. All merchandise available while supplies last. Price guaranteed subject to verifiable suppliers increases. Money back guarantee if returned within 14 days in mint condition with all papers and packing material intact. No returns accepted on open software. Printers sold only with cable.

Call Toll Free
1-800-223-3411

networking mode, with a fairly large number of users.

In my opinion, the primary difference between a professional front-end system and a desktop-publishing system lies not so much in the system's composition and graphics capabilities as in supporting a fairly large number of users. In other words, the file-handling capabilities of, say, a newspaper or magazine editorial system must be powerful and sophisticated. I haven't seen anything in the low-end, desktop market that offers the queue and directory structures essential to the copy-flow requirements of a major publishing venture. These will no doubt come in time, and when they do, the distinction between desktop and other publishing systems will probably fade away.

This is not to suggest that all systems will offer the same capabilities. Significant differences exist between desktop offerings, not only in terms of typographical niceties, the ways in which illustrative matter is handled, and throughput speeds, but more specifically in terms of the type of work the system can best handle.

For example, some systems are built around yet a third platform: workstations that support UNIX, which are patterned after Donald Knuth's T_EX and which handle multilevel mathematics, scientific notation, and book pagination in an environment that is primarily batch-oriented, rather than interactive in nature.

Some systems, built on either a Mac or PC platform, are superb at area composition (making up blocks of copy—like newspaper display ads) but can't cope with running the pages of text necessary for book composition. Still other systems intended primarily for short pieces—brochures and newsletters—try to offer something a bit more appealing than word-processing output. However, they don't come to grips with what makes for good-quality composition, such as control over interword spacing; letter spacing; frequency of hyphenation; handling of hangers, widows, and orphans (lines or portions of lines that stand by themselves when they should join to larger text blocks); and all of the other features that contribute to the artistry of composition.

Opportunities at Hand

Desktop publishing has come a long way in a short period of time. Now on the desktop are tools that take advantage of the knowledge and experience of generations of artisans and designers. Without serving a long term of apprenticeship in a specialty such as photoengraving or hand or machine composition, you can quickly and pleasurably become a desktop publisher. ■

What is a Best Western?



The right place at the right price.

Make reservations at any Best Western, see your travel agent, or call toll-free
1-800-528-1234



"World's largest chain of independently owned and operated hotels, motor inns and resorts"

Discover the true potential of laser printing.

Unleash The Power. It has harnessed the awesome energy of light. With that power, it will move mountains of work in minutes.

Introducing the Genicom 5010 Laser Page Printer; twenty-five percent faster than yesterday's laser printers. Printing everything from letters and legal size paper to transparencies—at 10 pages a minute. So fasten your seatbelt. And prepare for laser speed.

Superior Handling. When it comes to paper handling, the Genicom 5010 Laser is the printer to beat. It delivers double the standard input and 10 times the output capacity of other leading brands.

Handle big jobs easily with the 5010's automatic 200 sheet feeder. Shift into overdrive with a Genicom exclusive: an optional 50 sheet feeder cassette. There's even a manual feed slot, so you can print single sheets and transparencies without interrupting your work flow. And keep your work moving without a hitch, thanks to Genicom's efficient paper path.

But no matter what you feed the 5010, the result is laser perfect. Whether it's word processing that approaches typeset quality or high resolution graphics, the Genicom 5010 leaves nothing to the imagination.

It's Convertible. With Genicom's unique personality cartridges, the 5010 converts into multiple identities. Like a Diablo® 630, an IBM® Graphics Printer, or a Hewlett-Packard® LaserJet Plus for starters. Changing personalities is easy. Simply plug in a new cartridge. In seconds, the 5010 is up and running with any computer worth mentioning, plus the very latest laser software.

When it comes to print styles, the 5010 converts to your personality. Choose from a variety of fonts. Insert up to four font cartridges at once, and vary type styles within the same document.



Take Command. The 5010's prominent control panel is sophisticated simplicity. Just push a button to select fonts, input cassette, forms overlay, paper size, characters per inch, lines per inch and form feed. Even the 5010's diagnostic readout speaks your language, with a 32 character LCD that informs you of printer status in plain English.

Pass The Limit. Genicom designed the 5010 to surpass the standard limits for printer reliability. That's why the 5010's OPC drum and developer last 28,000 pages. And the toner cartridge has a 5000 page life, instead of just 3000 pages like other lasers.

Finally, Genicom backs its laser with a full year warranty on parts and labor. So stop by your nearby Genicom dealer today and discover what a true laser printer can do. Put a 5010 through its paces. You'll see the light.

For the Genicom dealer nearest you, call
1-800-437-7468.
In Virginia, call
1-703-949-1170.

Diablo® is a registered trademark of Xerox Corporation. IBM® is a registered trademark of International Business Machines Corporation. Hewlett-Packard® is a registered trademark of Hewlett-Packard Company.



GENICOM

The Printers That Mean Business.
One Genicom Drive, Waynesboro, VA 22980

How to 386

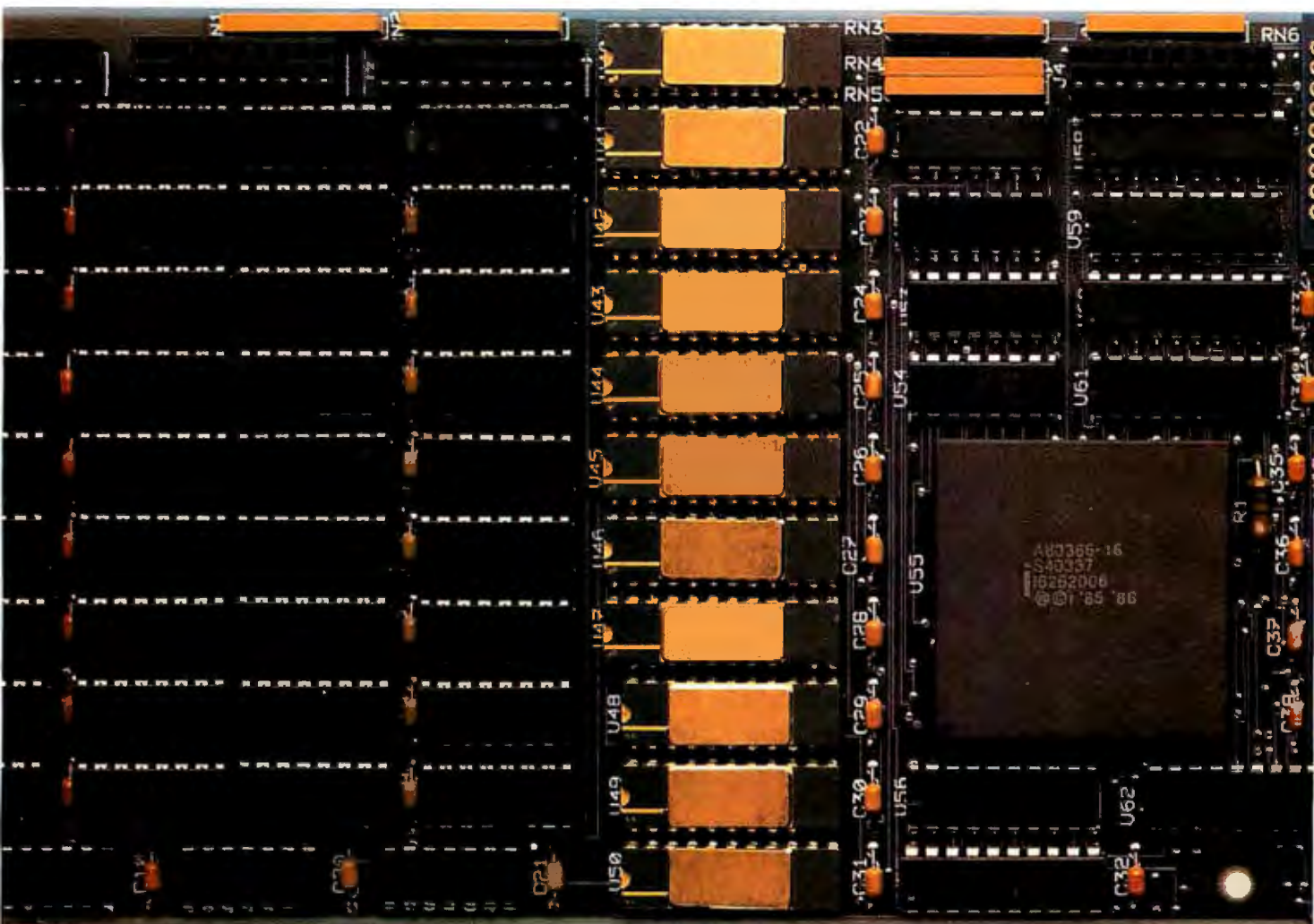

It's simple.
With Intel's Inboard™ 386/AT.
It fits right into your IBM® AT or compatible, and gives you all the performance of a 386 system.

Without having to buy a 386 system. (Which, if you've priced one lately, is about three times as expensive.)

Inboard 386 is based on the revolutionary 32-bit, 16 MHz 80386 chip *we* invented. So it'll work with all the

software you've got sitting on your desk. As well as any add-in boards you may have hiding in your computer—like, just for instance, the Above™ Board. Which we also invented.

Inboard 386 lets you whiz through recalcs with Lotus® 1-2-3®. And it makes your network server serve you even faster. In fact, it'll make any program serve you faster.

And with 386 control software,

Inboard and Above are trademarks and Intel a registered trademark of Intel Corporation. IBM is a registered trademark of International Business Machines Corp. Lotus and

your AT.

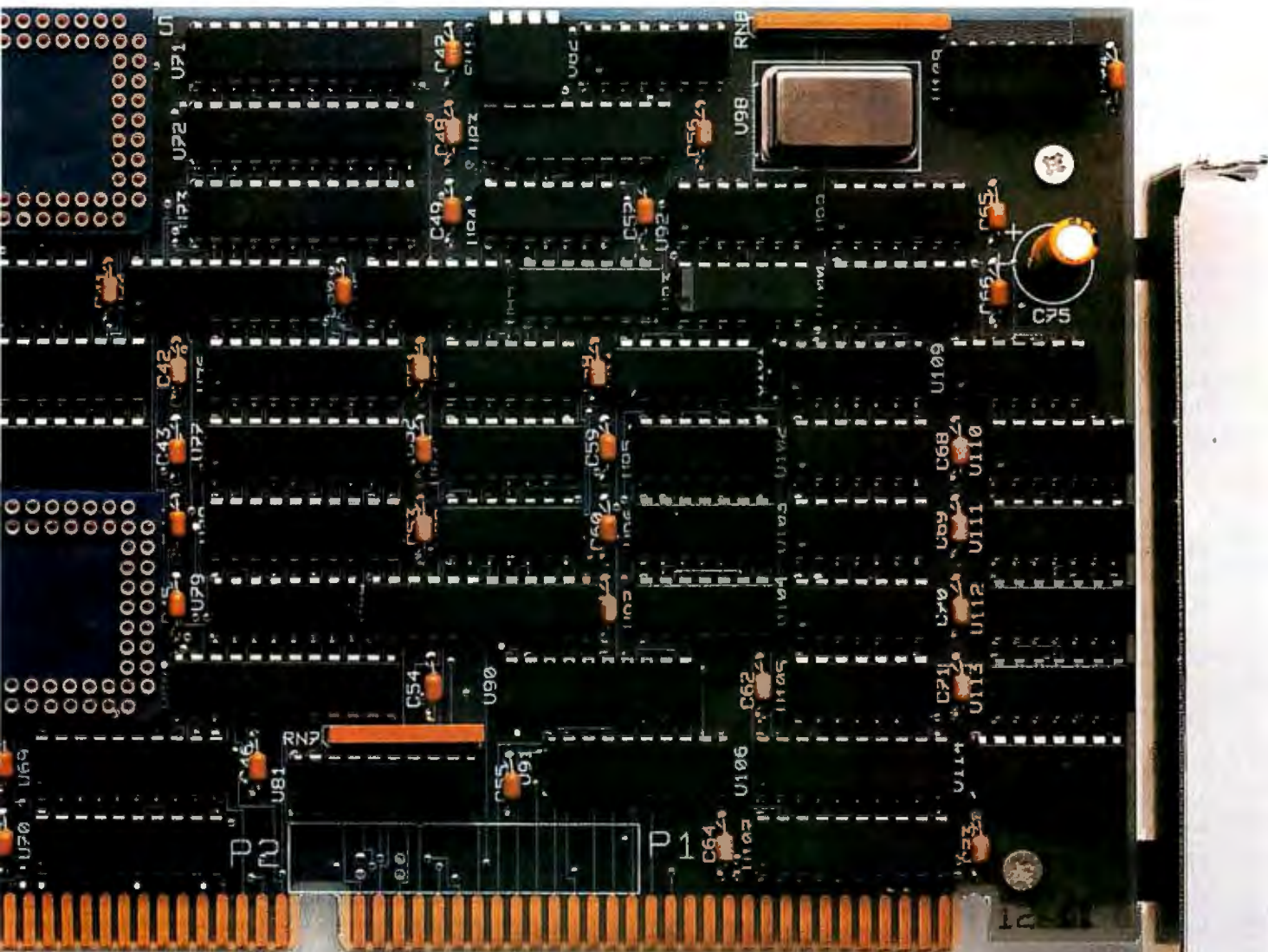

you can take advantage of exceptional multitasking capabilities. Like putting together a presentation while your computer is downloading data. (A slightly more efficient way of doing business.)

Don't forget our five-year warranty. Or toll-free technical support line.

1-2-3 are registered trademarks of Lotus Development Corp. © 1986 Intel Corporation

Inquiry 152

To find out more, check with your favorite computer dealer or call us at (800) 538-3373.

And see why Inboard 386 beats the system.

intel[®]

MAY 1987 • BYTE 157

Take Full Advantage of 80386 Power

386

We offer you the CSS 386-A™ as the best value in 80386 based personal computers. It costs a lot less than the Compaq® Deskpro 386™ and with the 20MHz option, it's 30% faster.

Memory Advantage

The CSS 386-A features a full 2 Megabytes of Parity Checked Static Column RAM at 16 MHz -0 Wait State and 1 32 bit Memory Expansion Slot at 16 MHz. And to help you take full advantage of all this memory we've included the CSS Memory Manager (EMS).

Compatibility Advantage

The CSS 386-A allows you full advantage of existing Add-on Boards and Peripherals. You won't have any compatibility problems because it's I/O Bus runs at 8MHz.

CSS 386-A

- Co-processor 16M processor upgradable to 24MHz.
- 80387 socket providing the following options:
 - 80387 co-processor
 - 10 MHz 80287 daughterboard (80387 emulator)
 - Weitek 1167 extended co-processor

- True 32 bit data path between CPU and memory
- 2Mb parity checked static column RAM at 16MHz 0 wait state
 - 1 32 bit memory expansion slot at 16MHz
 - Utilizes existing AT™ power supply, and peripherals
 - 7 I/O expansion slots
 - 5 16 bit
 - 2 8 bit
 - Keyboard switchable clock frequencies of 8 and 16MHz
 - Standard 8MHz I/O channel timing
 - Supports the AT and AT enhanced keyboards
 - Easy installation
 - Full technical support
 - 1 year warranty
 - Made in U.S.A.



CSS Laboratories, Inc. is in the business of manufacturing personal computer products with distinct advantages including a full line of AT compatible PCs, EGA Superior™, Turbo RAM™ card, Turbo LAN™ (Ethernet, Starlan, Cheapernet), 386 memory board and the new Laser jet controller. Call CSS Labs today at (714) 540-4141 and let us tell you about all the advantages of owning a CSS 386-A



2134 So. Fitchey Street, Santa Ana, California 92705
Tel: 714/540-4141 Telex: 3720012 FAX 714/540-2925

<p>Canada Distributor: Inter-Micro Distributors 4455 99 Street Edmonton Alberta, Canada (403) 438-3997</p> <p>Austria Distributor: System & Software Luegerstrabe 27 Postfach 6 9022 Klagenfurt, Austria (04222-21764)</p>	<p>Germany & Switzerland Distr.: Howell American Systems Classen-Kappelman-Strasse 24 D-5000 Koeln 41 West Germany 0221-4008225</p> <p>France Distributor: MIEL: 60 Rue de Wattignies 75012 Paris, France (1) 43429207</p>	<p>Australia Distributor: Napier Computers Unit A 3739 Smith Street Parramatta, N.S.W. 2050 Australia (02) 633-5659 (02) 689-1041</p> <p>Turbolan 16th Floor 65 Berry Street North Sydney, N.S.W. 1585 Australia</p>
--	--	---

Compaq® and Deskpro 386™ are registered trademarks of Compaq Computer Corporation. AT™ is a registered trademark of International Business Machines Corp. CSS 386-A™, EGA Superior™, Turbo RAM™, Turbo LAN™, are registered trademarks of CSS Laboratories, Inc.

Make My Page!

*Here's how to choose the best
desktop-publishing program for your needs*

Thom Holmes

RECENT ADVANCES IN microcomputer technology and the development of relatively low-cost laser printers have made it possible to use desktop computers in place of traditional composition systems for many publishing applications. Assembling a desktop-publishing system involves little more than buying a microcomputer, laser printer, and publishing software.

The most critical of these choices is software. It is also the most difficult choice to make because of the bewildering variety of publishing software available for microcomputers. The programs are designed for many different levels of users. Some are meant for novices and provide easy-to-use, although simplistic, WYSIWYG (what you see is what you get) functionality; others are intended for technical people already familiar with composition coding and the extensive use of key commands.

In desktop publishing you use off-the-shelf hardware and software components, as opposed to turnkey systems that use proprietary software and special workstations. The basic components making up a desktop-publishing system include a personal computer, hard disk, high-resolution monitor, mouse or other control device, laser printer, and composition software. In addition, the system will probably include a word-processing program and any number of graphics programs for paint or draw functions. A final option, for incorporating existing images into documents, is a digital scanner.

Whether you choose an IBM PC, Apple Macintosh, or other hardware base

for your system, the cost of a basic setup can run between \$10,000 and \$15,000. Publishing or composition software itself, which is the focus of this article, ranges anywhere from \$200 to \$8000, a range that is likely to close during the coming months as competitive packages begin to be more comparable. Tables 1 and 2 list IBM PC-based and Macintosh-based publishing packages and their distinguishing features.

Software Basics

All publishing software packages are not created equal. Some are designed to focus on one or two specific functions, while others are broad-based and provide a little bit of everything. Not many of the programs for microcomputers are strong in all areas. Among the features of these programs are text creation and editing; graphics creation and editing; interactive page layout using a mouse and a graphics display of the page; batch composition in which all pages are automatically composed according to preset page and typographic specifications; importing of text and graphics from other programs; true typographic control over hyphenation, justification, leading, kerning, and other features; automatic page numbering; and automatic repagination (renumbering of pages) once a document has been edited.

The heart and soul of desktop-publishing programs are the composition features—those elements that let you design a page format, control typographic specifications, and perform pagination prior to output. For this reason, most microcomputer publishing programs focus on com-

position features, rather than text and graphics features. The text and graphics elements of a publication are commonly created using programs other than the desktop-publishing package, and are imported into the publishing program at the time when pages are being composed. Keep in mind that, in addition to the publishing program itself, you will probably need to find compatible word-processing and graphics-illustration programs.

Publishing software for microcomputers is relatively expensive compared to the cost of software to which most users have become accustomed. Compared to the cost of using outside text compositors and typesetters, however, the software can pay for itself in less than a year. The programs make no particular demands on personal computers; they often require some extra memory and a hard disk drive, but these are features that many users already have.

Menu-Driven vs. Command-Driven

The two basic approaches to the design of publishing software for microcomputers are based on the two leading hardware products: the IBM PC and the Apple

continued

Thom Holmes (1805 Underwood Blvd., Delran, NJ 08075) is director of the Office Automation and Microcomputer Publishing groups at Datapro Research Corporation, which recently introduced Datapro Reports on Electronic Publishing Systems, containing in-depth reviews of desktop-publishing software and larger publishing systems.

Table 1: IBM PC-based desktop publishing packages and their features.

Vendor	Product	Hardware requirements	Imports from word processing programs	Import ASCII files Command-driven Menu-driven Icon/mouse-driven Spelling verification	Size(words)
Addison-Wesley Publishing Company	MicroX 1.5a1	IBM PC, XT, AT 512K RAM		• •	
Aldus Corporation	PageMaker 10 for the PC	IBM PC AT or compatible, EGA or other windows-compatible card, 512K RAM, hard disk	Microsoft Word, WordStar 3.3, MultiMate, XyWrite, WordPerfect, DCA files, Volkswriter	• • • •	
Alphatype Corporation	Work Station III-PC 4.1	IBM PC, XT, AT, 640K RAM, hard disk, Hercules graphics card		• • • •	160,000
Amgraf	Mecca III 2.00	IBM PC AT or compatible, 1.5-megabyte expansion memory, math coprocessor, 30-megabyte hard drive, high resolution, color monitor	WordStar, VI Text Editor	• • • •	90,000
Award Software	Laser-Press 52.04	IBM PC or compatible	WordStar, MultiMate	• • • •	64K bytes
BestInfo	Superpage 2.0	IBM XT, AT or compatible, 640K RAM, Hercules card, hard disk		• • • •	
Compugraphic Corporation	PTS Composer 1.0	IBM PC, XT, AT or compatible, two drives (one must be 360K disk)		• • • •	
CyberResearch	CyberType, CyberMerge 1.3	IBM PC, XT, AT or compatible, Hercules adapter, 384K RAM	MicroSoft Word	• • • •	
Data Transforms	Printrix 2.4/Fontrix 2.8	IBM PC or compatible, 256K, 512K, CGA, supported printer (Fontrix)	Microsoft Word, WordPerfect, WordStar 2000, PFS:Write	• • • •	
G.O. Graphics	DeskSet 1.0	IBM PC, XT, AT or compatible, dual disk drives or hard disk, 512K RAM, Hercules card	WordStar, MultiMate, WordPerfect, PC Write, DisplayWrite	• • • •	
Itak Graphix Corporation	PTW 2.0	IBM PC, XT, AT or compatible, hard disk, Hercules graphics card		• • • •	
Lexisoft	Spellbinder Desktop Publisher 6.2	IBM PC or compatible w/ 256K RAM, and CGA, EGA, Hercules Vectra Multimode, or AT&T 6300, graphics card		• • • •	50,000
Magna Computer Systems	Magnatype 1.5	IBM XT, AT or compatible, 640K w/ hard disk		• • • •	25,000
Megahaus Corporation	First Impression	IBM XT, AT or compatible, hard disk, 512K RAM, Hercules, CGA, EGA, or MDS Genius Graphic	DisplayWrite (DCA), WordStar, MultiMate, WordPerfect	• • • •	
Microsoft Corporation	Word 3.1	IBM PC or compatible, 256K RAM, MS-DOS 2.0, two disk drives or hard disk		• • • •	
Network Technology Corporation	The Gutenberg Laser Composition System 2.0	IBM PC, XT, AT or compatible, 512K RAM, hard disk		• • • •	
New American PagePlanner	PagePlanner-PRO 3.0	IBM PC, XT, AT or compatible, 256K RAM, Hercules or CGA	WordStar	• • • •	
Personal TeX	PC T _E X 2.0	IBM PC or compatible, 10-megabyte hard disk		• • • •	
ProSoft	Fontasy 2	IBM PC or compatible, 512K RAM, CGA or Hercules graphics adapter		• • • •	
The Puter Group	PageWriter 2.1a	IBM PC or compatible, 640K RAM, color graphics card		• • • •	
The Puter Group	PC-Preview 2.1a	IBM PC or compatible, 640K RAM, color graphics card		• • • •	
The Puter Group	PC-Transfer 1.0	IBM PC or compatible, 256K RAM		• • • •	
ScenicSoft	ScenicWriter 4.0	IBM PC, XT, AT or compatible, 256K RAM, hard disk		• • • •	
Software Channels	scLASERplus 1.2	IBM PC, XT, AT or compatible, 256K RAM, graphics card	WordPerfect, WordStar 2000	• • • •	50,000
Software Publishing Corporation	Harvard Professional Publisher 1.0	IBM PC, XT, AT or compatible, 640K RAM, Hercules graphics card or IBM EGA	DCA-compatible	• • • •	
Studio Software Corporation	FrontPage 1.1	IBM PC, XT, AT or compatible, 512K RAM, math coprocessor, and graphics card	DisplayWrite 2/3, EasyWriter, PFS:Write, MultiMate, WordPerfect	• • • •	
TYX Corporation	TYXSET 3.1	IBM PC, XT, AT or compatible, 512K, Venix 5	WordPerfect, WordStar, MultiMate, Perfect Writer	• • • •	20,000
West End Film	Pagework	IBM PC, XT, AT or compatible, 512K RAM		• • • •	
White Sciences	Pagebuilder	IBM PC, XT, AT or compatible, 512K RAM, JLASer or JLASer Plus card; EGA, Hercules, or Genius Display System		• • • •	
WordPerfect Corporation	WordPerfect 4.2	IBM PC or compatible, 256K RAM, hard disk or two disk drives	MultiMate, WordStar	• • • •	
Xerox Corporation	Xerox Ventura Publisher 1.0	IBM PC, XT, AT or compatible, hard disk, 512K, EGA, CGA, Hercules, Genius, or Xerox Full Page	WordStar, MultiMate, Microsoft Word, WordPerfect, Xerox Writer	• • • •	
Xyquest	XyWrite III 3.1	IBM PC, XT, AT, Jr-compatible, single disk drive, 256K RAM		• • • •	

SAVE \$20



United States One Year \$22 2 Years \$40
Canada/Mexico One Year U.S. \$25
Europe \$69 (air delivery), U.S. Funds enclosed
 \$37 (surface mail), U.S. Funds enclosed

BILL ME. If I'm not completely satisfied with my first copy, I'll simply write "cancel" across your invoice, mail it back, and my subscription will be cancelled.

Check Enclosed Bill VISA Bill Mastercard

Please allow 6-8 weeks for processing your subscription.

Name _____ 4750SU
Address _____
City/State/Zip _____
Acct.# _____ Expires _____
Signature _____



SAVE \$20



United States One Year \$22 2 Years \$40
Canada/Mexico One Year U.S. \$25
Europe \$69 (air delivery), U.S. Funds enclosed
 \$37 (surface mail), U.S. Funds enclosed

BILL ME. If I'm not completely satisfied with my first copy, I'll simply write "cancel" across your invoice, mail it back, and my subscription will be cancelled.

Check Enclosed Bill VISA Bill Mastercard

Please allow 6-8 weeks for processing your subscription.

Name _____ 4750SU
Address _____
City/State/Zip _____
Acct.# _____ Expires _____
Signature _____





NO POSTAGE
NECESSARY
IF MAILED
IN THE
UNITED STATES

BUSINESS REPLY MAIL

FIRST CLASS PERMIT NO. 39 MARTINSVILLE, NJ

POSTAGE WILL BE PAID BY ADDRESSEE

BYTE

Subscription Dept.

P.O. Box 597

Martinsville, NJ 08836-9956

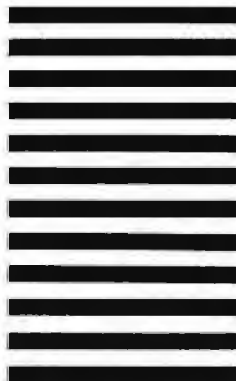

NO POSTAGE
NECESSARY
IF MAILED
IN THE
UNITED STATES

BUSINESS REPLY MAIL

FIRST CLASS PERMIT NO. 39 MARTINSVILLE, NJ

POSTAGE WILL BE PAID BY ADDRESSEE

BYTE

Subscription Dept.

P.O. Box 597

Martinsville, NJ 08836-9956

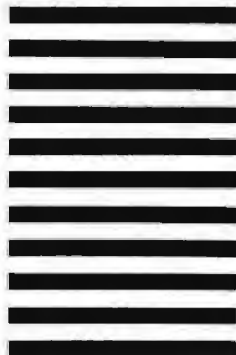

Table 2: *Macintosh-based desktop-publishing packages and their distinguishing features.*

Vendor	Product	Hardware requirements	Imports from word processing programs	Import ASCII files Command-driven Menu-driven Icon/mouse-driven Spelling verification	Size(words)
	TExture 1.0			• • • •	
	PageMaker 2.0 for the Mac	drive.	Microsoft Word, Microsoft Works, MacWrite	• • • •	
	MacPublisher III 1.0		Microsoft Word, MacWrite	• • •	
	MacTeX 2.0			• • •	
	ReadySetGo 3.0	Switcher	MacWrite, Microsoft Word	• • • •	
	Megaform 2.3		Megafiler	•	
	Megaform 2.3/Megafiler		MacWrite	•	
	Word for Macintosh 1.0		MacWrite	• • •	
	PS Compose 1.0			• • • •	
	Stylo-Type I 1.11			• • • •	

Macintosh. Programs written for the IBM PC tend to be command-driven and appeal to the more technical end user, while Macintosh programs are menu-driven and appeal to nontechnical people. There are exceptions to these rules, but for the most part, software seems to fall into one of these categories, which have relative advantages and disadvantages. Menu-driven programs are easy to learn, interactive, and appeal to nontechnical users, but they can lack full composition functionality, have both limited text formatting and typographic options, and are often slower to use than command-driven programs.

Command-driven programs can offer a high level of composition functionality, extensive text formatting and typographic options, and faster response time. Thus, they will appeal to technical people and those already familiar with composition. However, they can have commands that are difficult to learn and remember, and they do not always employ interactive page makeup using a graphics display. When examining a program, you should consider the level of technical expertise

of the intended users as well as your requirements for interactive page makeup using a graphics display.

The following is a brief discussion of some of the relative advantages of Macintosh-based publishing software versus IBM PC-based programs. Most of the time, the program's capabilities are directly tied to the machine's capabilities.

The Macintosh Platform

High-resolution, easy-to-manipulate graphics are the Macintosh's forte, and the user interface provided with the Macintosh operating environment is by far its biggest virtue. Publishers of desktop-publishing software have used this interface to their best advantage, predominantly relying upon the mouse and limiting keystrokes to a few commands. Macintosh programs generally make it easy for you to import text and graphics and to arrange these elements in the document.

Macintosh-based programs can, however, present problems for more demanding users. In a business setting, for example, although some of these programs can

serve for many internal applications, none seem to have all the features necessary to produce true typeset-quality documents. These programs cater to ease of use and let you produce nice-looking documents quickly. But often the Macintosh programs cannot produce camera-ready output and generally do not permit composition of a lengthy document.

The early market leaders in the electronic-publishing software market for the Macintosh include PageMaker from Aldus, MacPublisher from Boston Publishing Systems (formerly Boston Software), and ReadySetGo, developed by Manhattan Graphics and sold by Letraset. All three packages can import text and graphics from other Macintosh programs such as Microsoft Word, MacWrite, and MacPaint.

The packages differ in the way they let you design a page, the type of tools they offer, and so on. For example, PageMaker lets you decide how many columns you want, and you can then adjust column sizes with a mouse. ReadySetGo is less interactive but more precise: You tell the system exactly how big you want a

Columns Snaking Number available	Tables Index/table of contents generation Footnotes Hyphenation Automatic Discretionary Interactive Batch Kerning Leading Layout visible on screen Text/graphics integration Graphics from ext. sources	Source	Automatic pagination Interactive pagination Batch pagination Drawing Data-driven charts	Typesetters supported	Laser printers supported	Suggested list price
	• • • • •	is	• •		Postscript-compatible	
•	• • • • •	Programs, scanner	• •		Apple LaserWriter, LaserWriter Plus, Dataproducts LZ4 2665	
• •	• • • • •	Programs, scanner	• •		PostScript-compatible	
• •		Scanner	• •		Apple LaserWriter, LW Plus and other PostScript-compatible	
	• • •	Programs	• • •		Apple LaserWriter and LaserWriter Plus	
• •	•	Programs, scanner	• • •		Apple LaserWriter	
• •	•	Programs, scanner	• • •		Apple LaserWriter	
• •	• • • • •	Programs	• •		Apple LaserWriter	
• •	•	Programs, scanner	• • • •		PostScript-compatible	
	• •	Programs	• •		Apple LaserWriter	

column to be by typing in a size. ReadySetGo can also repaginate automatically, a feature missing in PageMaker.

PageMaker was originally the most expensive of the three major publishing applications for the Macintosh—at \$495, it cost nearly two and a half times as much as MacPublisher or ReadySetGo, even though PageMaker did not at the time offer a proportionately larger number of features. Still, it became the leading seller for the Macintosh. All three programs currently feature many more professional composition features than they did in 1986, with consideration finally given to hyphenation, page numbering, kerning, and leading.

The IBM PC Platform

Desktop-publishing packages available for the IBM PC appear to place emphasis on producing text-based documents. In keeping with the system's features, IBM PC-based packages tend to be command-driven systems that can provide full composition functionality. This feature is attractive to composition professionals but does require that you have some familiar-

ity with the operating system. One feature lacking in text-only composition systems is the ability to merge graphics with text.

Perhaps the most capable of PC-based publishing programs is Ventura Publisher from Xerox. Built upon the GEM desktop environment, Ventura Publisher combines a screen-based WYSIWYG interface with "style sheets" that let you determine the exact specifications for any page, paragraph, image, or other element by choosing from a menu of predefined "tags."

Text files written or changed from within Ventura Publisher can be saved and used by word-processing programs—a unique feature and a good one if you want to archive text and use it again.

Finally, the recently released version 1.1 of Ventura Publisher is compatible with a variety of page-description languages such as PostScript, Interpress, and DDL. Ventura can produce output on Apple's LaserWriter, the HP LaserJet and a host of other printers. At \$895, Ventura is more expensive than other PC-based packages but is considered by some to rival expensive dedicated publishing

systems produced by companies like Interleaf.

Aldus Corporation has begun shipping an IBM PC-based version of PageMaker that is similar in look and feel to the Macintosh version. PageMaker PC uses the MicroSoft Windows environment to support a mouse and interactive WYSIWYG page makeup.

MagnaType, from Magna Computer Systems, is one of a small number of packages available for use on a personal computer that act as a front end for an actual typesetting system. Its ability to compose text or import it for composition further narrows the field of competition. Deskset from G.O. Graphics and PC-Type from Modtek are typesetting composition programs that compete with MagnaType, but Magna has the reputation and exposure that these other packages lack. MagnaType's capabilities reside in its ability to drive a wide variety of typesetters as output devices and to take advantage of the composition features of these machines. As a typesetting software package, MagnaType has few peers.

continued

MULTI USER BBS

Off-the-shelf and custom systems for:

- ★ Multi-User Teleconferencing
- ★ Multi-User Electronic Mail
- ★ Multi-User File Upload/Download
- ★ Multi-User Order Entry
- ★ Multi-User Games and Amusements
- ★ Multi-User Database Lookup
- ★ Multi-User Online Expert Systems
- ★ Multi-User Catalog Scanning
- ★ Multi-User Classified Advertising
- ★ Multi-User Educational Services

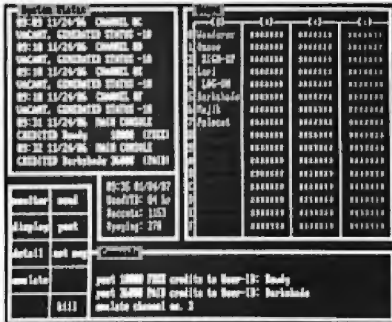

What do you need for your Multi-User Bulletin Board System?

	Us	Them
16 modems on one card	YES	?
Up to 64-user capability	YES	?
Runs under MS-DOS V3.1	YES	?
C source code available	YES	?
Menu-oriented operation	YES	?
Accounting w/audit-trail	YES	?
Extensive SYSOP displays	YES	?
Powerfail-protected data	YES	?
"Midnite cleanup" option	YES	?
1-year hardware warranty	YES	?

We sell hardware and software for the IBM PC family and compatibles. Our product line is centered around the GALACTICOMM BREAKTHROUGH, a single-slot card with 16 independent modems on it. You will simply have a cable coming out the back of your machine, going straight into the jacks in the wall installed by the telephone company. No external hardware needed.

Call our multi-user demo system with your modem, at (305) 922-3901. Then call (305) 472-9560, voice, for more information. Why not call right now?

GALACTICOMM

GALACTICOMM, Inc., 11360 Tara Drive, Plantation, FL 33325

MAKE MY PAGE

Some documents such as newsletters or brochures can be done page by page, which is handled best on an interactive graphics display.

Bestinfo's Superpage is a high-end desktop-publishing system in the same league with MagnaType as a typesetting composition package. However, Superpage offers a greater degree of display interactivity than other typeset composition packages. This ability to see what you are designing is important for newcomers to text composition or typesetting.

Superpage also lets you design forms precisely, an important feature if you plan to read data off of the form with an optical character reader (OCR), which often requires precise alignment of material. The program's filing capability lets you keep track of the text files with which you are working, which version you are using, and so on. All these features are important in producing composed documents, especially to the inexperienced user. In comparison, MagnaType is much more code-intensive for these functions.

Frontpage (formerly Do-It) from Studio Software is an IBM PC-based desktop-publishing program that is easy to use and takes advantage of a mouse. Those intimidated by any command-driven software might gravitate toward packages such as Frontpage. Frontpage allows for professional-looking typeset-quality text and also permits a degree of manipulation in terms of the location and size of the text. Although considered a low-end typesetting package, Frontpage has a relatively high price (compared to the more capable systems mentioned above) when you take into consideration the add-ons it requires.

If you have already invested in an IBM PC and HP LaserJet printer, the package of choice may be Lexisoft's Spellbinder Desktop Publisher. This composition software package lets you graphically depict a made-up page before outputting it. Lexisoft was the first to offer this feature at a relatively low cost.

Like most desktop-publishing programs, Spellbinder Desktop Publisher lets you incorporate into your publication any file created on another word proces-

sor as an ASCII file. Although this can also be said of the typeset composition packages from Magna and Bestinfo, these are several times more expensive.

Word Processor as Publisher

Word-processing programs are limited in what they can do to affect text size, appearance, and layout. Composition programs, on the other hand, are designed to manipulate the size and style of characters as well as the placement of copy and graphics on the page. Finding a powerful word processor to serve as a front end to the composition program is as important as selecting the publishing package itself.

A number of IBM PC-based word processors are well suited to interface with composition software. Microsoft Word, for example, has more flexibility in selection of fonts and more detail in spacing and margin specification than its competitors; it will convert files from other formats; and, perhaps most important, it will store page formats for later recall—an important step toward publishing periodical material.

The Macintosh version of Word is alone in its competitive class. MacWrite is its only serious competitor at the word-processor level, but early versions of MacWrite were more of a beginner's word processor than a package for the prolific writer.

The MS-DOS version of Word has a distinct advantage in output flexibility. It offers a greater choice of output devices, which gives you a variety of configuration options. The ease with which you can choose different fonts encourages creative use of type in Word documents, an important aspect of publishing. And the MS-DOS version of Word is easy to learn and use.

Word's biggest challenger appears to be WordPerfect from WordPerfect Corporation (formerly Satellite Software). The programs have similar capabilities and are very popular with professional writers.

Another popular word processor is XyWrite III. As a text-processing system that supports minimal graphics and can drive a laser printer for the production of newsletters and manuals, XyWrite III compares favorably with Word and WordPerfect. It is also less expensive.

As a microcomputer-based text generator for composition systems, XyWrite has no competitors. XyWrite's compatibility with almost every other system in the composition-systems market has made it the most popular text-processing package for microcomputers in the publishing industry. It has become the program of choice for people in the composi-

continued

Companies Mentioned

Addison-Wesley Publishing Company
1 Jacob Way
Reading, MA 01867
(617) 944-6795

Aldus Corporation
411 1st Ave., Suite 2100
Seattle, WA 98104
(206) 622-5500

Alphatype Corporation
7711 N. Merrimac Ave.
Niles, IL 60648
(312) 259-6800

Amgraf Inc.
1501 Oak St.
Kansas City, MO 64108-1424
(816) 474-4787

Award Software Inc.
130 Knowles Dr.
Los Gatos, CA 95030
(408) 370-7979

Bestinfo Inc.
130 South State St.
Springfield, PA 19064
(215) 891-6500

Boston Publishing Systems
1260 Boylston St.
Boston, MA 02215
(617) 267-4747

CyberResearch Inc.
5 Science Park Center, P.O. Box 9565
New Haven, CT 06536
(203) 786-5151

Cybertext Corporation
702 Jefferson Ave., P.O. Box 3488
Ashland, OR 97520
(503) 482-0733

Data Transforms Inc.
616 Washington St.
Denver, CO 80203
(303) 832-1501

FTL Systems Inc.
234 Eglinton Ave. East, Suite 205
Toronto, Ontario, Canada M4P 1K5
(416) 487-2142

G.O. Graphics
18 Ray Ave.
Burlington, MA 01803-4721
(800) 237-5588

Itek Graphix Corporation
34 Cellu Dr.
Nashua, NH 03063
(603) 889-1400

Letraset USA
40 Eisenhower Dr.
Paramus, NJ 07653
(201) 845-6100

Lexisoft Inc.
P.O. Box 1950
Davis, CA 95617
(916) 758-3630

Magna Computer Systems Inc.
14724 Ventura Blvd.
Sherman Oaks, CA 91403
(818) 986-9233

Megahaus Corporation
5703 Oberline Dr.
San Diego, CA 92121
(619) 450-1230

Microsoft Corporation
16011 Northeast 36th Way
P.O. Box 97017
Redmond, WA 98052-6399
(206) 882-8080

Network Technology Corporation
6825 Lamp Post Lane
Alexandria, VA 22306-1321
(703) 765-4506

New American PagePlanner Inc.
One Maple St.
East Rutherford, NJ 07073
(201) 933-4868

Personal TeX Inc.
12 Madrona Ave.
Mill Valley, CA 94941
(415) 388-8853

ProSoft
7248 Bellaire Ave.
North Hollywood, CA 91605
(818) 765-4444

PS Publishing
290 Green St., Suite 1
San Francisco, CA 94133
(415) 433-4698

The 'Puter Group
1717 West Beltline Highway
Madison, WI 53713
(608) 273-1803

Scenic Soft Inc.
100 Second Ave., South
Edmonds WA 98020
(206) 776-7760

Software Channels Inc.
1320 Young St., Suite 301
Toronto, Ontario, Canada M4T 1X2
(416) 967-1024

Software Publishing Corporation
1901 Landings Dr.
Mountain View, CA 94043
(415) 962-8910

Studio Software
17862-C Fitch
Irvine, CA 92714
(800) 821-7816

Typesetting Network Inc.
161 Vine St., P.O. Box 5279
Reno, NV 89513
(702) 322-1884

TYX Corporation
11250 Roger Bacon Dr., Suite 16
Reston, VA 22090
(703) 471-0233

West End Film
1825 Q St. NW
Washington, DC 20009
(202) 232-7733

WordPerfect Corporation
266 West Center St.
Orem, UT 84057
(801) 227-4404

Xerox Corporation
101 Continental Blvd.
El Segundo, CA 90245
(800) 822-8221

Xyquest Inc.
3 Loomis St.
Bedford, MA 01730
(617) 275-4439.

PROM/PAL PROGRAMMING?

From \$250.00

Finding a Low-Cost PROM or PAL* programmer is only half of the battle. Finding a company that won't desert you when you need support or service is the other half.

Logical Devices Products **cost** you **less** because we offer the best price performance ratio in the market, **and** because once you buy our products you will experience less down time and **more reliable** operation than most other units. In addition you get features that were evolved from our years of experience of serving people who program chips.

We offer a wide range of products from dedicated programmers to universal software driven models.



GANGPRO-8 production programmer. 8 EPROMs to 27512 with RS-232 option.

PROMPRO-8X universal portable. RS-232. Programs PROMs/PAL*s/ micros

PALPRO-2X Low Cost PAL* only programmer. Dedicated, RS-232 unit.

SHOOTER Low cost EPROM only programmer. RS-232, Stand-Alone.

PC-PRO IBM PC plug-in EPROM card 2716-27512

ALLPRO pin driven software based *universal unit*, programs every imaginable fuse programmable IC.

CAST boolean software/silicon compiler for PLDs. JEDEC output

UV ERASERS FROM \$49.95

All products carry 90 day Warranty & 14 day Money Back Guarantee

**CALL 1-800-331-7766
LOGICAL DEVICES INC.**

USA 305-974-0967
ENGLAND 44 272 277323
FRANCE 39.54.91.13

*PAL IS A REGISTERED TRADEMARK OF MONOLITHIC MEMORIES INC.

MAKE MY PAGE

*The word processor
that serves as a
front-end to the
composition program
is as important as
the publishing
package itself.*

tion business and is commonly used to emulate the editing functions of large editorial systems such as Atex—perhaps because its founders came from the publishing systems industry rather than the office-automation industry.

Guidelines for Selecting Software

Before looking for a desktop-publishing program, you should ask some questions. First, what user interface level do you desire? Are the users nontechnical or technical people? If you prefer using a mouse or similar pointing device, the number of programs to choose from narrows.

What programs will be used to create text and graphics? They must be compatible with whatever publishing program you select.

Does the application call for graphics capability? Knowing specifically the kind of graphics you require will greatly aid in selecting software. Some programs let you draw or construct graphics from within the program. Others allow merging with externally produced illustrations and even scanned images. More common are packages that simply allow holes or windows for inserting photos or illustrations after the text is composed.

Is networking a need or possible need?

Is the page makeup performed interactively or in a batch mode? Some short documents such as newsletters or brochures can be done page by page, which is best done with an interactive graphics display, while long documents that have a strict predesigned format can best be made up in an automatic batch mode that puts text files into the desired page layout.

Finally, will the program need to interface to a laser printer or typesetter? Many programs allow the use of many fonts and character sizes. The use of these features naturally requires a laser printer as an output device. You can use a dot-matrix printer for producing draft-quality output for review. More advanced (and therefore more expensive) programs provide interfaces to typesetting devices.

As you might expect, the cost of micro-

computer-based publishing programs runs the gamut from about \$195 for a basic Macintosh program to between \$2000 and \$8000 for a high-level IBM-based program. You must study the level of commitment and desired results closely before selecting a program.

Distinguishing Features

To the casual observer, most desktop-publishing programs look the same. It is common to come away from a trade show featuring publishing software and not have the slightest idea of the differences between one program and another. All the demonstrations tend to look the same, and unless you attempt some kind of benchmark using each program, the pros and cons of a package are not likely to surface immediately.

If the programs' specifications read the same and they all seem somehow adequate for your application, take a closer look by exploring the following nuts-and-bolts considerations. These features are often overlooked but largely define the true usefulness of a publishing program.

What output devices are supported? Which makes and models of laser printers? Which typesetters?

What interfaces exist between this program and word-processing and graphics programs? Can it accept files from your text and graphics software?

How does the system paginate? Is it done interactively (page by page) using a WYSIWYG display? Or is it done in a batch manner based on user-programmable document specifications? Keep in mind that paginating long documents is no fun if you have to do them manually, page by page on the screen.

Is a hyphenation program available?

Can you specify the leading (line spacing), or do you have to live with a limited number of default settings?

Is kerning (intercharacter spacing) available? Kerning permits the professional spacing of words and characters on a line for the sake of justifying copy.

Is automatic page numbering available?

Will the program automatically produce a table of contents and/or an index of your document?

Can the program create equations as graphics elements in a document?

Does the program provide footnoting capability?

These features separate the good, the bad, and the ugly in desktop-publishing software. By answering the questions about your application and then applying the answers to table 1, you can be confident that the program you buy will do the task you have in mind with a minimum of headaches. ■

THE OPTIMIZER. TAKE TURBO TO THE LIMIT.

Turbo OPTIMIZER™ helps you squeeze down, rev up, and fine tune your compiled Turbo Pascal programs. Now there's no need to write in assembler...you program faster and easier in the language you love.

A LEANER TURBO

Small programs of 12K bytes are often reduced to only 2K. Medium-sized programs can shrink by 7K bytes.

The Object Code Compactor makes code smaller by automatically removing the unused portions of the run-time library as well as unused procedures and functions in your own code.

You save valuable disk and RAM space.

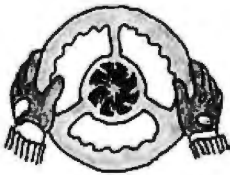

A FASTER TURBO

The Object Optimizer scans the object code and removes unnecessary instructions like null jumps and register reloads. Your Turbo Pascal programs run up to 30% faster.

CALL ON THE LIBRARIAN

Store compiled versions of your often-used procedures in relocatable form using The Object Librarian. The Object Librarian then creates External procedures that you include in your source code. You cut compile time.

*"A real lifesaver...I saved
10K bytes in the latest version of Note-It.®"*

Dave Whitney, author, Note-It



Call or send today for Turbo OPTIMIZER. It's only \$75. (With source code, \$125) Call toll free for credit card orders:

(800) 538-8157 x830

(800) 672-3470 x830 in CA.

Satisfaction Guaranteed or your money back within 30 days.

For other information call (408) 438-8608. Shipping and taxes prepaid for U.S. and Canadian customers. Others please include \$6 per item for shipping.



More ways to take Turbo to the limit:

T-DebugPLUS, the symbolic run-time debugger, only \$60, Turbo EXTENDER breaks the 64K barrier, only \$85, TurboPower Utilities, nine powerful programs, only \$95 with source.



TurboPower Software, 3109 Scotts Valley Dr., Suite 122, Scotts Valley, CA 95066
© 1987 TurboPower Software

These products require Turbo Pascal 3.0 (standard, 8087, or BCD), PC-DOS 2.X or 3.X, and IBM PC/XT/AT or compatibles. Note-It is a registered trademark of Turner Hall Publishing, a division of Symantec.



Programmer's Paradise Gives You Superb Selection, Personal Service and Unbeatable Prices!

Welcome to Paradise. The MS/PC-DOS and XENIX software source that caters to your programming needs.

Discover the Many Advantages of Paradise ...

- Lowest price guaranteed
- Huge inventory, immediate shipment
- Special orders
- Latest versions
- Knowledgeable sales staff
- 30-day money-back guarantee*

Discover Paradise Contest — Search for the Hidden Clues to our Island's Identity and Win!

	LIST OURS	
C++		
ADVANTAGE C++	\$ 495 479	
PFORCE++	395 CALL	
C COMPILERS		
AZTEC C-86 COMMERCIAL	499 CALL	
AZTEC C-86 DEVELOPER	299 CALL	
C-86 PLUS	497 379	
DATALIGHT — DEVELOPER'S KIT	99 79	
DATALIGHT — OPTIMUM C	139 119	
LATTICE C 3.2	500 279	
LATTICE C W/SOURCE	900 545	
LET'S C	75 59	
W/CSO DEBUGGER	150 109	
MICROSOFT C 4.0	450 275	
MARK WILLIAMS C	495 289	
UNWARE 68020 C CROSS WIZARD C	595 CALL	
	450 309	
C INTERPRETERS		
C-TERP	300 235	
INSTANT C	500 379	
INTERACTIVE C	249 219	
INTRODUCING C	125 105	
Q C	60 CALL	
RUN/C	120 89	
RUN/C PROFESSIONAL 1.1	250 169	
ASSEMBLERS		
ADVANTAGE LINK	395 359	
ASMLIB	149 129	
MACRO ASSEMBLER	150 99	
PASM-86	195 119	
PLINK 86 PLUS	495 325	
QUELO 68000 X-ASM	595 509	

	LIST OURS	
HALO — FIVE MICROSOFT LANGUAGES	595 399	
METAWINDOW	185 115	
METAWINDOW PLUS	235 189	
METAFONTS	80 59	
METAFONTS PLUS	235 189	
C UTILITY LIBRARIES		
ASYNCH MANAGER	175 135	
BASIC C	175 129	
BLACKSTAR C FUNCTION LIBRARY	99 89	
C ESSENTIALS	100 85	
C FOOD SMORGASBORD	150 95	
W/SOURCE	300 189	
C TOOLS PLUS	175 135	
ESSENTIAL C UTILITY LIBRARY	185 135	
ESSENTIAL COMMUNICATIONS	185 135	
WBREAKOUT DEBUGGER	250 195	
GREENLEAF FUNCTIONS	185 135	
GREENLEAF COMM	185 135	
THE HAMMER	195 159	
LIGHT TOOLS	99 89	
MULTI C	149 135	
MULTI COMM	149 135	
PFORCE	395 235	
SQUARE KILOMETERS	18,376 CALL	
TIMESLICER	295 265	
W/LIBRARY SOURCE	1000 CALL	
TOPVIEW TOOLBASKET	250 179	
SCREEN DISPLAY, WINDOWS FOR C		
C WORTHY	295 269	
COURSES	125 89	
W/SOURCE	250 179	
FLASH UP WINDOWS	90 79	
GREENLEAF DATA WINDOWS	225 165	
W/SOURCE	395 309	
HELP!	149 CALL	
MICROSOFT WINDOWS DEVELOPMENT KIT	99 65	
ON-LINE HELP	500 310	
PANEL	149 109	
POLYWINDOWS	295 219	
SCREENPLAY (LATTICE)	CALL CALL	
SOFTSCREEN HELP VIEW MANAGER	150 135	
VITAMIN C 3.0	195 175	
VC SCREEN	275 199	
WINDOWS FOR C	225 199	
WINDOWS FOR DATA	99 85	
Z VIEW	195 145	
	295 239	
	245 189	
FILE MANAGEMENT		
ASMTREE	395 339	
BTRIEVE	245 195	
REPORT OPTION	145 119	
XTRIEVE	245 195	
BTRIEVE/N	595 465	
REPORT OPTION/N	345 279	
XTRIEVE/N	595 465	
C-ISAM	225 195	

	LIST OURS	
C TREE	395 319	
R TREE	295 249	
C TREE/R TREE BUNDLE	650 529	
CQI	395 329	
DBC III	250 179	
W/SOURCE	500 359	
DBC III PLUS	750 599	
DB VISTA	195 155	
W/SOURCE	495 425	
DB QUERY	195 155	
W/SOURCE	495 425	
FABS	150 129	
FABS PLUS	195 169	
INFORMIX	795 639	
INFORMIX 4GL	995 799	
INFORMIX SQL	795 639	
PHACT	295 265	
DEBUGGERS		
ADVANCED TRACE 86	175 125	
BREAKOUT	125 99	
CODESMITH 86	145 105	
C SPRITE	175 129	
CSD SOURCE DEBUGGER	75 59	
PERISCOPE I 3.0	345 295	
PERISCOPE II 3.0	175 145	
PERISCOPE II-X 3.0	145 109	
PERISCOPE III	995 CALL	
PFIX 86 PLUS	395 235	
XVIEW 86	60 49	
EDITORS		
BRIEF	195 CALL	
DBRIEF	95 CALL	
BRIEF/DBRIEF BUNDLE	275 CALL	
C SCREEN	75 CALL	
CVUE	75 59	
W/SOURCE	250 195	
EDIX	195 155	
EMACS	295 265	
W/SOURCE	995 895	
EPSILON	195 159	
FIRSTTIME (C)	295 229	
KEDIT	125 105	
LSE	125 89	
PMATE	195 119	
PC/VI	149 119	
SPECIES OF PLANTS AND BIRDS	3,000 22	
SPF/PC	195 145	
VEDIT	150 109	
VEDIT PLUS	185 139	
XTC	99 79	
SORT UTILITIES		
AUTOSORT	150 129	
MICROSOFT SORT	195 129	
OPT-TECH SORT	149 115	
PROFILERS		
CODE SIFTER	119 95	
PFINISH	395 235	
THE PROFILER	125 89	

	LIST OURS	
LINT		
PC LINT	139 99	
PRE-C	295 159	
MAKE UTILITIES		
ADVANTAGE MAKE	125 99	
LMK	195 139	
PMAKER	125 79	
POLYMAKE V.2.0	149 125	
SAPIENS MAKE	79 75	

80386 DEVELOPMENT TOOLS	
386/1 ASM/LINK	495 399
HIGH C	895 CALL
PROFESSIONAL PASCAL	895 CALL

TRANSLATORS BRIDGES	
BASTOC	495 399
BAS_C	85 79
BAS_PAS	85 79
MB 86	895 CALL
PTRAL	179 CALL
R BRIDGE	395 339

BASIC	
BETTERBASIC	199 139
BETTERBASIC ADD ONS	CALL CALL
DEVELOPMENT TOOLS	99 89
BETTER TOOLS	95 89
EXIM TOOL KIT	50 49
FINALLY	99 89
HEAVENLY HORSESHOE	CALL CALL
MICROSOFT QUICKBASIC	99 89
PROFESSIONAL BASIC	99 75
8087 MATH SUPPORT	50 45
PANEL-BASIC	145 115
TRUE BASIC	150 105
ADD ONS	CALL CALL
TURBO BASIC	100 75

FORTRAN COMPILERS UTILITIES	
FLIB	149 CALL
MICROSOFT COBOL	700 439
MICROSOFT COBOL TOOLS	350 229
MICROSOFT SORT	195 129
MICRO/SPF	175 155
OPT-TECH SORT	149 115
REALIA CICS	995 785
REALIA COBOL	995 785
RM/COBOL	950 649
RM/COBOL 8X	1250 909
SCREENPLAY	175 155
SCREEN I/O	400 CALL
VISUAL COBOL (MBP)	795 CALL

FREE TECH JOURNAL
Resource Directory for Technical Users

Buy at least two products totaling over \$300 and receive a free copy of the 1987 PC Tech Journal Directory, a comprehensive source and reference to the articles and products reviewed and featured in PC Tech Journal.

GRAPHICS	
ESSENTIAL GRAPHICS	250 195
GRAPHIC	350 289
GSS GRAPHICS DEVELOPMENT TOOLKIT	495 379
GSS KERNEL SYSTEM	495 379
GSS METAFONT INTERPRETER	295 239
GSS PLOTTING SYSTEM	495 379
HALO — ONE LANGUAGE	300 209
W/TEN FONT PACK	425 299

American Made Computer—Overseas Price

Features:

- 8 MHz/10 MHz Operation
- 512K RAM expandable to 1MB
- Also runs Xenix, Unix, Pick, AutoCad and Network systems
- Systems are fully tested and burned in for 48 hours
- 80286-8 Micro processor
- 1.2MB floppy disk drive
- Hard disk and floppy disk controller
- AT® style keyboard
- Battery backup clock/calendar
- ROM BIOS
- Complete documentation
- One year limited warranty

Options:

- 1.2MB TEAC floppy drive
- Hard Disk/Floppy controller for AT®

Accessories:

- EGA monitor & EGA card \$615
- Mono monitor & mono card \$187
- 512K of RAM \$52
- 80287 Math Co-processor \$235
- 360K floppy disk drive \$99
- 1.2MB floppy disk drive \$135
- MS DOS and Basic version 3.2 \$85
- RAM chip 64K \$1 256K \$3
- AT® style keyboard, 5151 \$88

8 MHz System with Option

without mono monitor and Video card **\$1028**

10 MHz System with Option

without mono monitor and Video card **\$1128**

Upgrade to 30MB 39 ms add **\$195**

SCSI-286 8 MHz version

\$756
Basic system

Made in U.S.A.

Monitor not included



SCSI-286 FULLY CONFIGURED AT® SYSTEMS

SCSI-286m

Mono AT® System **\$1215**

Basic system as described above, Monochrome monitor with Tilt swivel base, Hercules compatible Monochrome Graphics card with Printer port

SCSI-286s

The 286 Steal with 20MB HD **\$1699**

Basic system as described above, 20MB H.D., Monochrome monitor with Tilt swivel base, Hercules® compatible monochrome graphics card, 1MB of RAM, expandable to 3MB, four I/O ports, fully tested and burned in for 60 hours, fully configured systems

SCSI-286e

Special EGA 20MB H.D. **\$1895**

Basic system as described above, 20MB H.D., fully configured, EGA/CGA compatible monitor, EGA color display card with parallel port, fully assembled and tested before shipping

Desktop Publisher
SCSI Press Pac I \$7945
SCSI Press Pac II \$5555

HARD DISK FOR PC, XT & AT

Hard Disk for AT®

*39 ms access time

- *20MB ST4026 \$528
- *30MB ST4038 \$628
- *40MB ST4051 \$699
- 80MB/28 ms ST4096 **\$1195**
- 72MB/25 ms Toshiba **\$1095**

Seagate 20/30MB Hard disk Subsystem

- 20MB Internal ST225 **\$350**
- 20MB External ST225 **\$499**
- 30MB Internal ST238 **\$470**

With Floppy Controller add \$55 (20MB only)



MODEMS

Evercom 12

- Hayes compatible
- Software included
- Half size/Low power **\$128**
- 300/1200 Baud internal
- Runs Smartcom and all Hayes comp software
- Excellent for Long Distance Calls

Evercom 24

- Hayes compatible
- Half size/Low power **\$249**
- 1200/2400 Baud internal
- Software included
- Runs Smartcom and all Hayes comp software
- Excellent for Long Distance Calls



GRAPHICS DISPLAY CARDS

Mono Hercules Compatible

- Printer port **\$99**
- Hercules compatible
- Software switchable
- Runs Lotus 123 Graphics
- Runs 132 columns

EGA Graphic Card

- Parallel port **\$229**
- Fully IBM compatible
- 256K video memory
- Runs color/mono enhance display
- 6 colors, 640 x 350 resolution
- 1 printer port

Micro EGA

- External Switch **\$238**
- 640 x 350 EGA
- 320 x 200 CGA
- 640 x 350 Monochrome
- Hercules compatible



MONITORS

Mono monitor

- Nonglare **\$99**
- 800H x 350V resolution
- FCC class 'B' approved

EGA monitor

- 640 x 350 **\$429**
- 640 x 200
- EGA and CGA

NEC Multisync

- 800H x 560V **\$555**
- Text Mode Switch
- EGA, VGA, CGA compatible



MULTIFUNCTION CARDS

Multifunction for AT®

- Software and game port
- 0-2MB memory
- Two serial ports **\$169**
- One parallel port
- Runs on 12 MHz AT®
- 2nd serial port optional

Mini I/O for PC/XT/AT

- Parallel port **\$79**
- Real time clock/calendar
- 2 serial ports (2nd optional)

Six-Pac Compatible

- Serial port **\$88**
- Parallel port
- Clock/calendar
- 0-384K Memory
- Game port and software



TAPE BACKUP

Tape Backup Subsystem

- Backup 5MB in 1 minute
- Image/File-by-File
- Mounting hardware
- Software and tape
- Controller included

	INT.	EXT.
TEAC 20MB	\$580	\$794
Wangtek 60MB	\$727	\$827
Archive 60MB	—	\$675



MEMORY CARDS

Memory card for PC

- Short card **\$68**
- 0-576K Memory
- Support 64K/ 256K DRAM

Memory card for the AT®

- 0-3MB **\$135**
- 256KB RAM chip
- Split Memory address
- One year limited warranty



TURBO XT

- Hercules Monographics card
- Fully IBM compatible
- 8088-2, 8 MHz CPU
- 20MB Hard Disk Drive
- 4.77 and 8 MHz keyboard selectable
- With 360K Floppy Drive
- 1 parallel port
- Option math Co-processor

- 640K memory
- 135 watt power supply
- Keyboard
- MS DOS 3.1
- FCC Class 'B' approved
- One Year warranty



\$995

OTHERS

Turbo PAC-286

- Makes your PC/XT 33% faster than IBM
- 80286 processor
- Socket for 80287
- 128KRAM **\$399**

Everex Edge

- Parallel port **\$235**
- 132 column text, color or mono
- Color display 16 colors
- color software thru mono monitor

Microsoft Compatible

- 200 dots/inch
- Work with AutoCad
- 3 buttons/built-in microprocessor **\$76**

Mouse with DR. HALO **\$109**

HD/Floppy controller

- Hard disk & Floppy controller for AT **\$160**
- PC/XT Hard disk & Floppy controller **\$128**
- PC/XT Western Digital (chipset) Hard disk controller **\$108**

Quantity Discounts available

Dealers are Welcome

ORDER BY MAIL: Check or Money order, California add 6% sales tax.

ORDER BY PHONE: C.O.D., Cashier Check, VISA, MasterCard, American Express (3% extra) or Approved Company P.O.



Southern California Systems, Inc.

10525 Humboldt St., Los Alamitos, CA 90720 (In Orange County, Los Angeles)

CALL us now toll free at 1-(800) 237-7274 (Outside CA)

1-(213) 493-6633 (Sales)

For Technical Support Call (213) 596-9748 FAX # 1-(213) 493-5187 Corporate accounts call Anil and get total satisfaction for your money.

TERMS: Due to our Low Price, all sales are final. All prices are subject to change and some quantities may be limited and we reserve the right to substitute equivalent items. Unauthorized Returns are subject to 10% Restocking Fee. Call for RMA numbers for Returns and Repairs. *All Prices are subject to change without notice. IBM, Hercules, BitCom, Xenix are Trademarks of their Respective Companies

Designing a Raster-Image Processor

*The road from screen display
to hard copy is circuitous*

Jon Barrett and Kirk Reistroffer

ASKING THE QUESTION "How do you drive a laser printer?" is less like "How do you drive a car?" than like "How do you drive to Cambridge?" The question "How do you drive a car?" has a fairly specific and uniform answer having to do with using a steering wheel and two or three floor pedals. But "How do you drive to Cambridge?" depends on where you are starting from and whether you want to take the fast or the scenic route. Similarly, "How do you drive a laser printer?" depends upon where you are starting from and what kind of results you expect.

Despite this, some generalizations can be made about the aims and methods of driving laser printers. In this article we will talk about a generalized front end for a raster-image processor (RIP) and explain how what shows up on-screen finally shows up on a laser-printer output. First we will describe some of the page-description languages (PDLs) important in the desktop-publishing world. Then we will explain how RIPs work in general. Finally, we will discuss our approach to the hardware and software necessary to drive a laser printer, with emphasis on what we think are some innovations in the technology.

In our generalized example of an electronic publishing system (EPS), we have several aims. First, we want it to show on-screen what will appear on paper. That is, we want a WYSIWYG (what you see is what you get) system. Second, it must generate sophisticated graphics, allow easy revision of them, and display them on-screen. Third, it must allow for mix-

ing typefaces and sizes on any one page, preferably without limit. Fourth, it must allow mixing of graphics and text, preferably without any limit on complexity. Fifth, it must be able to print out, with fidelity, all that the user has created. Sixth, the quicker it can do this, the better.

To accomplish these aims, we need several components. The front end on the host computer must let you create documents of arbitrary graphic and typographic complexity. Second, documents must be translated into a PDL, a series of commands which a laser printer can "understand." Finally, the system must have hardware that takes the digital information describing the page and turns it into modulations of the laser, causing the image to appear on the paper. This hardware is called a RIP. (A raster, or raster scan image, as used in the context of computer graphics, is a two-dimensional array of pixels.)

It might seem that the process of getting the document's image onto the CRT screen is essentially the same, from the logical point of view, as getting it onto paper. To a certain extent, that is correct. The image on paper and the CRT image are both views into the same database, in this case a document. But several issues arise that distinguish the two processes. Chief among these are the questions of hardware and resolution dependence. Most EPSs have opted for some form of independence in both regards. That is one reason why PostScript is so popular; a PostScript description of a page will theoretically produce the same page, given

differences in resolution, on any PostScript output device. Thus, EPS software designers can write a single driver for their system and have confidence that it will produce accurate printed pages when hooked up to a variety of printers. The chief disadvantage is that this dependence prevents an EPS from taking full advantage of a specific output device.

In fact, as we shall explain, in our design we opted for some limited device and resolution dependence. This means that we do not have to pass parameters with enough information to drive a typesetter at 2000 dots per inch if we are in fact driving a 300-dpi laser printer. This optimizes for data compression, which can improve the printer's total throughput. This is especially true when the communication channel is relatively slow, as in the case of the 9600-bit-per-second serial AppleTalk line used by Apple's LaserWriter. Obviously, a resolution-dependent system demands more initial work from the designers. Also, our device dependence enables us to hand-tune fonts for the particular printers we support, optimizing them for legibility and style.

The question of machine dependence is not academic. For example, some laser printers write to white and some write to black. That is, some consider the image

continued

Jon Barrett (Zedex, 215 First St., Cambridge, MA 02142) was formerly manager of hardware development at Interleaf. Kirk Reistroffer is a senior software engineer at Interleaf (Ten Canal Park, Cambridge, MA 02141).

drum in the printer to be a black object that must be "erased" to carve out black letters, and others consider it to be a white object onto which black dots must be placed. In either case, you want to lay down dots that are slightly larger than a pixel so they will overlap. If you are writing to black (laying down black dots), the character so constructed will be noticeably fatter than one carved out of a black background (see figure 1). A font that works well on one printer can look ungainly on another. Therefore, there is a real reason to use machine-dependent drivers.

But to understand how RIPs and PDLs have evolved the way they have, it is necessary to know a little about the short history of laser printers.

History of Laser Printers

Although laser printers have been around since the mid-1970s, they were text-oriented and in the \$500,000 price range. Thus, when Canon introduced the LBP-10 laser printer in 1979 for \$10,000, it caused a great deal of excitement.

The first laser printers using the Canon engine, while exciting, were inadequate for the needs of the generalized EPS that is our example. They did support downloaded fonts, but they did not have sufficient graphics capabilities. For example, they could not fill an arbitrary polygon.

Then, in 1981, Imagen introduced a laser printer with an important advance. To compose an entire page before printing, you need enough memory to hold

data about each of the dots to be printed, about a megabyte's worth for a 300-dpi printer. At that time, a megabyte was expensive. So Imagen figured out a way to print full pages without having the entire page in memory. This technique was implemented in their RIP. The Imagen technique was clever. It internally considered a page to consist of a matrix of "postage stamps," each of which it could compose in real time. If a "stamp" were text only, it would create the raster image on the fly. If the data were part of a large, uniform area, it would take one "stamp" and replicate it, saving memory.

This was an improvement over the Xerox laser printers of the time, for while they could print as much text as wanted on a page, virtually the only graphics they would print were horizontal and vertical lines for tables. But the early Imagen laser printer could not print pages with very complex graphics. And it did not do clipping. (To clip an image is to crop off selected portions of it.) Also, the amount of memory available too severely limited the number of vector lines that could be printed. (Vector-line graphics is a method for drawing graphics using straight lines. Each line is usually described by its end points.) This is an important limitation when your set of geometric primitives does not include circles and arcs, so curves have to be represented by hundreds or even thousands of vector lines. Finally, because the letters were logically ORED into the graphic "stamps," the printer could not produce white text on a

black background: Assuming that a set bit is one that prints, ORing a set and a reset bit results in a set bit.

Previously available laser printers, such as the Hewlett-Packard LaserJet, were very popular although not the most functional. They could handle text adequately but did not shine when it came to complex graphics. The latest generation of laser printers from Hewlett-Packard, Imagen, and other vendors has overcome many of the limitations of earlier models, in large part because memory has become cheap enough to make large memory boards that can hold a full-page bit map. The memory generally consists of at least 1.5 megabytes. Of this, about 1 megabyte is for the page bit map, and the other 0.5 megabyte is for temporary storage, variables, and cached fonts. (Cached fonts are, in essence, fonts downloaded from the host computer or computed from outlines.)

In addition, ROMs are available that may contain font bit maps that the printer will use to compose the text on a page whenever the PDL has told it to insert some characters. The ROM's bit map is compatible with the printer's resolution if the PDL is device-independent. Most printers in this class offer between 1.5 and 2 megabytes of memory. Improved software has enabled these printers to produce pages of considerable complexity.

Putting the Image on Screen and Paper

The main section of an EPS program, which puts the characters on the display screen, is fairly standard. The basic display loop for our generalized EPS has to grab the bits that compose the character and put them into an arbitrary place in memory, typically a screen buffer dedicated to the task. To draw the character quickly, you need to grab the largest chunk of data you can at a time. Our imaginary computer uses the Motorola 68000 that has a 16-bit data bus. Thus, the most data available for grabbing in any one cycle is 16 bits. These bits are then moved into a two-dimensional array.

This would be fairly straightforward if you were dealing with monospaced text, since each character would then occupy a bit map of the same size. But our generalized EPS does not. It provides on-screen proportional spacing. Further, there is the problem of kerning letter pairs in which one character hangs over another as in the case of the letters VA or italicized lower case f's (see figure 2). (Some systems treat some commonly kerned pairs, such as ff, as single bit maps. In traditional typography, such pairs, occupying a single piece of type, are called ligatures.) To achieve this, you cannot

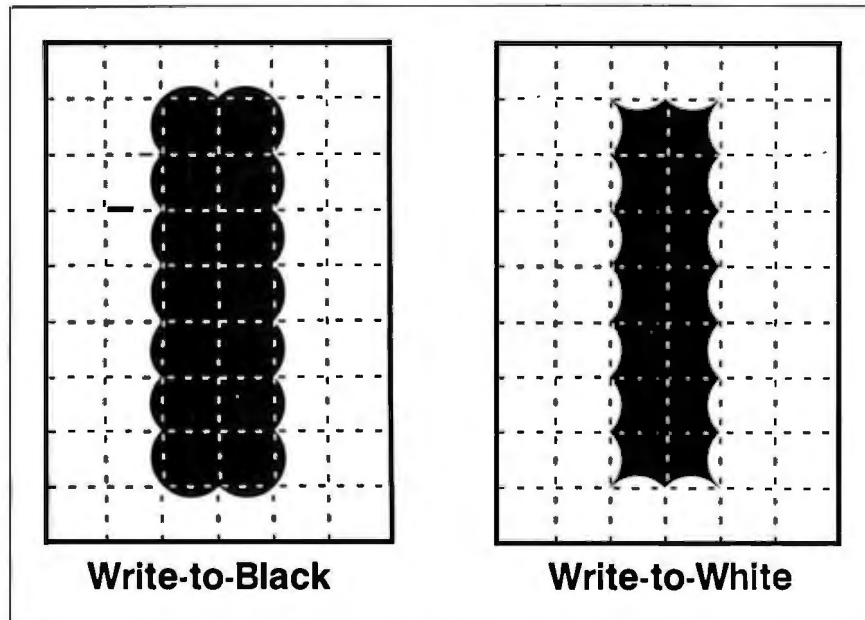

Figure 1: With write-to-black printers, black pixels are written to a white background. With write-to-white printers, white pixels are written to a black background. The resulting fonts can appear substantially different, as in the case of the sans serif l's shown here. Hand-tuning fonts for specific printers can enhance legibility and style.

treat each character as occupying an inviolable rectangle. Rather, you must logically OR bit maps that intersect. When you OR them, all bits currently set in the destination bit map remain set, while those set in the intersecting source bit map next set the appropriate bits in the destination bit map.

This solves the problem of displaying bit-mapped, proportionally spaced characters on-screen. But the 300-dpi resolution of a laser printer is four times greater than the approximately 75-dpi resolution of workstation display screens, which means the printer has 16 times the number of dots per page. Although the algorithm is basically the same, because it is 16 times the data, the job is slower.

The problem is how to blit, that is move or logically OR a source bit map of a glyph (i.e., a bit map that contains a character or a symbol, typically one that will be reused) into the destination bit map (screen or printer). ("Blit" as a verb comes from BLT, an acronym for bit boundary block transfer.) As an example, let's take a simple case such as blitting the letter A. If the source is an array one word wide, we want to write this to a destination that is also one word wide. But remember that we are dealing with proportionally spaced text. Thus, glyphs will not necessarily fall on word boundaries in the destination. With a 16-bit

word (which is the size of the word we actually deal with), the chances are only 1 in 16 that the glyph will fall on the boundary. Thus, our problem is writing a glyph that is one word wide to a destination where it will straddle two words. (In general, if n is the width of the glyph in words, the problem will be to write it to a destination $n+1$ words wide.)

The basic loop for a software blit (see figure 3) consists of the following steps: First, you get the source word, then shift it right to reflect the offset from the destination's word boundary. Next, get the destination word. OR the shifted source and destination word, and write it to the destination. Get the source word again (or keep it in a register), then shift it left to reflect the offset. Get the destination

+1 word. OR the shifted source and destination +1, and write to destination +1.

The second access of the source word is necessary to take care of any portions of the source bit map that run over into a second word space.

Document to PDL

We now have some characters on the screen. How do we get them to the printer? Remember that what is written to screen and what is written to the printer are two views of the same document. This document, at least the text portion of it, is one-dimensional. In putting it on the screen, the EPS software has to make decisions about how to bring it into two dimensions: where should the line breaks

continued

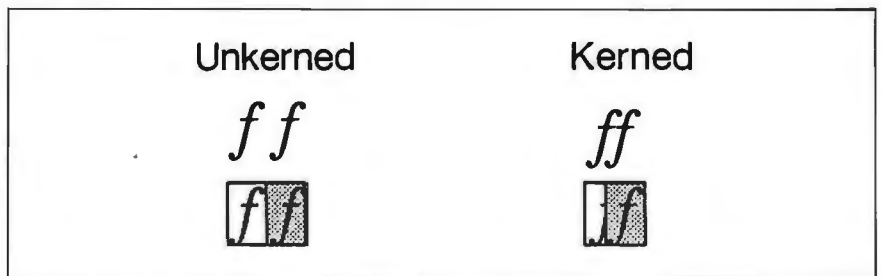

Figure 2: Unkered italicized *f*'s, shown on the left, each occupy an inviolate rectangle. Kerned letters, on the right, overhang each other, complicating the bit-mapping algorithms.

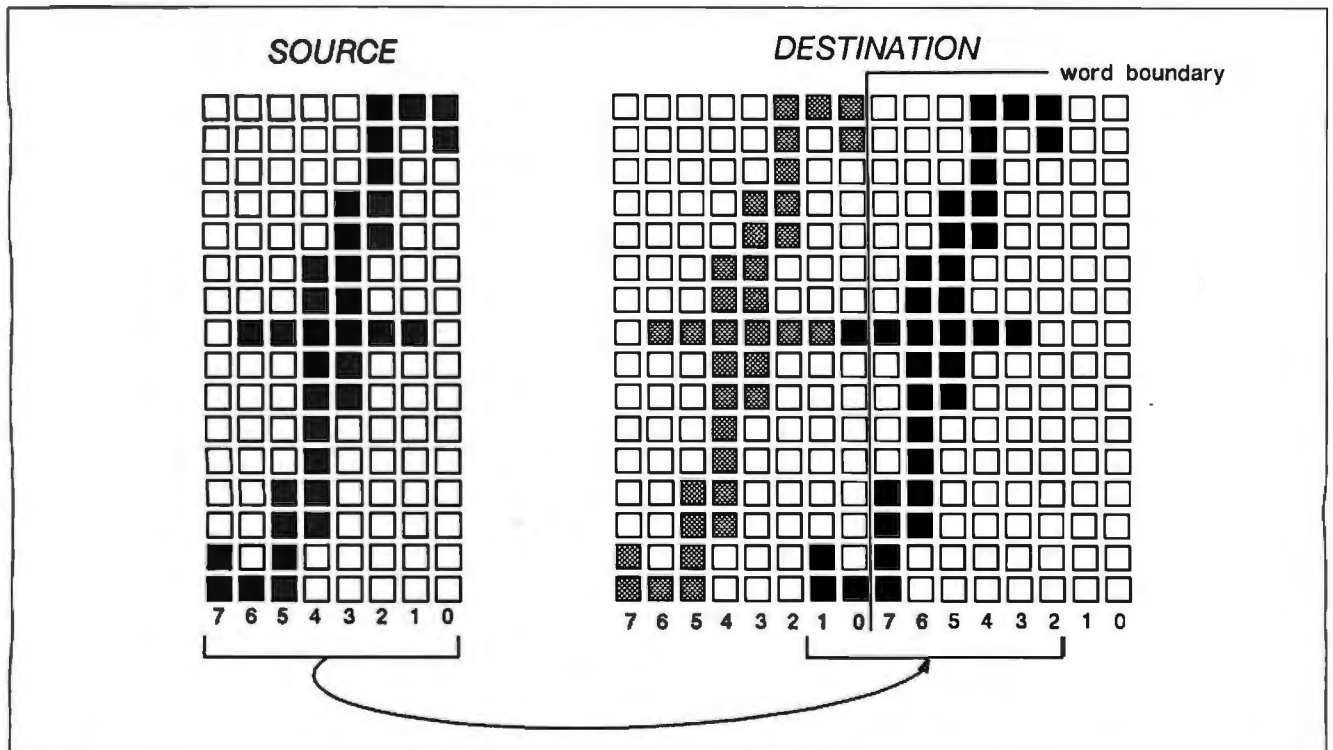

Figure 3: To move the source bit map row by row into the destination bit map (which can straddle word boundaries), each row must be shifted by the offset from the word boundary. In this case, the offset is six. In this example, kerned italicized *f*'s are shown, but the problem can occur with any letter. This figure uses 8-bit words to simplify the diagram.

**NOW! FULLY FUNCTIONAL
XTURBO SYSTEMS
ALL COMPLETE WITH
HARD DRIVE AND
TTL AMBER MONITOR**

ALL PRICES ARE FOR COMPLETE SYSTEMS

30MB HARD DRIVE

\$995⁰⁰

OPTION 1

OPTION 2

20MB \$949⁰⁰

10MB \$845⁰⁰



**No Hidden Costs, No Gimmicks
A True IBM Compatible at
Hundreds Below Competition
DELIVERED TO YOU FULLY
TESTED, AND READY TO RUN**

**TURBO SPEED 4.77/8 MHZ WITH
16-BIT 8088-2 PROCESSOR
PLUS THESE QUALITY FEATURES:**

1. Dual Speed—Keyboard Switchable
2. 256K Installed. 640K Optional
3. 8087 Co-Processor Socket
4. Eight Expansion Slots
5. 150 Watt Power Supply
6. Front Panel Turbo/Power/HD Lights+Lock
7. Unique, Heavy-Duty AT Style Case
8. Runs all MS-DOS programs including 1-2-3, Flight Simulator, etc. and GW BASIC
9. Brand New (Not Rebuilt) Famous Brand Hard Drive and Controller Card
10. System Boots From Hard Drive
11. 360K Drive With Controller
12. AT-Style Keyboard, 84 Keys, LED Indicators and Large Return Key. Enhanced AT Style Keyboard Available as Option.
13. Monographics (Hercules Compatible) Card With Printer Port
14. High Resolution TTL Amber Screen Monitor. Color and EGA also available.
15. System Assembled and Diagnostic Tested in our Labs.
16. One-Full-Year Limited Warranty
17. 30-Day Return For Refund Policy

CALL NOW **612 553-0320**
VISA • MASTER • COD



2905-Northwest Boulevard Suite 250
Plymouth, Minnesota 55441

Products Formerly Sold by Olla Computers

RASTER-IMAGE PROCESSOR

be, where should the page breaks be. In non-WYSIWYG systems, such as batch systems, those decisions are made after all editing has been completed. In a WYSIWYG system, those decisions have to be made on the fly to keep the screen updated. This can be a daunting task, since inserting a single letter while editing can cause a sentence to drop onto the next page, setting off pagination ripples throughout the document. Further, some EPSs (such as Interleaf) provide on-screen hyphenation, which means that after you type each word-terminating character, you have to check the preceding character string against a dictionary to find the hyphenation points. (You can use an algorithm in lieu of a dictionary.)

In a true WYSIWYG system, those problems have been solved, and document integrity is maintained at all times. No post-editing formatting is required to prepare for printing. But you cannot simply ship bit maps over the screen to get the printer to work well, if only because that would grossly underutilize the printer's ability to produce relatively high-quality output.

A variety of techniques have evolved, but the fundamental steps are the same. The PDL must generate the commands to tell the printer which fonts to use. (If it does not have fonts stored, describe the fonts by sending bit maps or mathematical descriptions of them.)

The PDL then generates the commands to tell the printer where to place the characters. It describes the graphics and takes care of bookkeeping chores, such as sending an end-of-page command when appropriate.

The first step is for the host to translate the document into pages that can then be described by the PDL. (In our generalized EPS, pagination is done in real time; some older-generation systems require a separate pagination process after editing is complete.) If the system designers want to be able to deal with several different sorts of printers and PDLs, they might decide to have the host generate an intermediate language sufficiently generic to be intelligible to various PDLs. The intermediate language might also be optimized for graphics. For example, a circle can be described in various ways, including treating it as a polygonal shape, using coefficients, or giving its center and radius. The intermediate language might optimize for data compression by describing the circle in the way that requires the least data, while still providing sufficient data for various PDLs to reconstitute it accurately.

It is perfectly possible, and not uncommon, to use no intermediate language at all. But in a network environment it is

useful to separate the different phases of the translation from document to PDL, and consequently intermediate languages become more important. For example, if the document's host emits an intermediate description of the page, the printer server can translate it into the specific PDLs of the various printers it might service. Thus, one server can drive several different sorts of printers. Also, the intermediate language can be optimized for data compression, which is especially important when operating in a network environment.

Page-Description Languages

At the moment, several PDLs are vying to become the standard, although there is even debate about whether a standard is desirable. The two best-known ones are PostScript from Adobe Systems and Interpress from Xerox Corporation. A more recent contender in the standards fray is Imagen's Document Description Language (DDL).

PostScript seems to be gaining ground in the low-end desktop-publishing market. For example, PostScript drives the Apple LaserWriter. Interpress might prove to be more adept at dealing with very high speed printers such as the 120-page-per-minute Xerox 9700. DDL is a strong contender, especially since Hewlett-Packard has announced that it will support this language in some future products. One such product is a low-cost RIP that can be added to IBM PC AT systems to turn a previously installed LaserJet into a full-functionality text and graphics printer. Finally, RPrint is the PDL we designed; we will discuss it later (see reference 1).

Interpress

Interpress was created in 1982 by Robert Sproull and William Newman at the Xerox Palo Alto Research Center. It remained for internal use only until 1984, when some versions were made public.

Interpress is a tokenized language, within which documents are represented in an encoded form. Each variable is preceded by a length field so that the interpreter knows in advance how much data the current token requires to be read from the input stream. This facilitates the transmission of documents quickly and reliably over a network without recomposition. This is an advantage for demand publishing on high-throughput printers, but for most users the benefit seems small.

The body of an Interpress document contains the characters to be printed and printing instructions as to the desired appearance of the document (e.g., whether

continued

Alsys launches
PC AT-TO-370 ADA
Cross-Compiler at
November ADA Expo;
80286 Debugger also
introduced.

A new Alsys cross-compiler permitting Ada programs to be written on an IBM-PC AT and executed on an IBM 370 was introduced at the November Ada Expo in Charleston, W. VA. The cross-compiler, pre-validated to AJPO test suite 1.7, is priced at \$2,995 and includes a 4 MB RAM board.

Two compilers, the Alsys validated PC AT self-hosted compiler, and the AT-to-370 cross-compiler, are offered as an option at \$4,995. One RAM board serves both compilers.

The cross-compiler, and especially the two-compiler option, implements a "distributed programming" environment for which the Ada language and its "package" concept is particularly suited. The two-compiler option permits developers to program in

Ada and test their results at their workstations before uploading 370 object code to the mainframe.

Alsys also introduced its PC AT debugger called AdaPROBE at the Expo. AdaPROBE combines a unique Ada-VIEWER with regular debug facilities.

The Alsys logo is written in a stylized, green, italicized font. The letters 'A', 'S', and 'Y' are larger and more prominent than the 'I' and 'S' in the middle.

ALSYS, INC.,
1432 Main Street, Waltham, MA 02154
BY587

ADA NOW. Tell me more about the
cross-compiler.

Name/Title _____

Company _____

Address _____

City/State/Zip _____

Phone/Ext _____

In the US: Alsys Inc., 1432 Main St., Waltham, MA
02154 Tel: (617) 890-0030

In the UK: Alsys Ltd., Partridge House, Newtown
Rd., Henley-on-Thames, Oxon RG9 1EN
Tel: 44 (491) 579090

In the rest of the world: Alsys SA, 29, Avenue de
Versailles, 78170 La Celle St., Cloud, France
Tel: 33 (1) 3918.12.44

*Ada is a registered trademark of the U.S.
Government (AJPO). Alsys is the trademark of
Alsys, Inc. References to other computer systems use
trademarks owned by the respective manufacturers.

Prices refer to U.S. only. Contact Alsys for prices in
other countries.

Inquiry 19

NOW AVAILABLE
AdaPROBE™
Program Viewer and
Symbolic Debugger for
the AT and Compatibles

Ada now

DDL can produce both a user-readable and a tightly encoded form.

to print on two sides, and how to stack it in the printer). The document creator can determine and alter the coordinate system at any time, affording a measure of device independence. Generally, Interpress documents do not carry with them bit maps of characters. Bit-map images are supported for printers with resolution of about 300 dpi (the standard for low-end laser printers). Publicly available Interpress printers support limited transforms on characters, permitting, for example, rotations of only 90 degrees.

PostScript

Adobe was formed in late 1982 by John Warnock and Charles Geschke, both of whom left Xerox to design PostScript. The first PostScript-based laser printer, the Apple LaserWriter, became available in the spring of 1985.

PostScript is an interpreted language for describing, in a device-independent fashion, the way in which pages can be composed of characters, shapes, and digitized images in black and white, gray scale, or color. PostScript characters are produced by specifying a font name and size. As with Interpress, the creator can determine and alter the coordinate system at any time. Because PostScript is a rather rich programming language, a PostScript program is likely to specify graphics objects in some normalized, parameterized form and apply an appropriate transform, derived from the param-

eters, to the object before committing its image to the page. It is completely user-readable, in 7-bit ASCII form. For this intelligibility, however, you pay a performance price in lower communications throughput.

When dealing with complex pages (a function of the amount of detail in the page), PostScript is severely limited. For every change in font or size, the printer must compute a bit map from the outline font (unless that font is cached). The bit map is preserved (so it does not have to be recomputed) until memory runs short; then it is discarded to make room for new bit maps. The result is that complex pages that contain text print slowly. The same is true, but more so, for pages that contain complex graphics. For example, *The Seybold Report on Publishing Systems* (the major independent industry source) reported that a map of the United States took 13 hours to typeset using PostScript. Further, the maker of the typesetter defended its performance by saying that this was because the user had encoded the graphic poorly. When the typesetter company recoded it, it still took six hours to output (see reference 2).

Document Description Language

The designers of DDL sought to avoid what they regarded as the bad design features of Interpress and PostScript, while incorporating the good. For example, DDL can produce both a user-readable and a tightly encoded form. The first allows more rapid application development, but the second allows faster host-to-printer communication.

Also, DDL has the graphics richness of PostScript, but produces document-description (as opposed to purely page-description) facilities, as does Interpress.

This latter facility is important for making intelligent spooling systems that might need to know about page size, fonts needed for the entire document, where the page data ends, and so on. This kind of capability is so useful that Adobe Systems promulgated a PostScript "comment convention" by which a PostScript creator can indicate these parameters in a standard way. In effect, this convention is a recognition of PostScript's inability to deal with certain problems that arise when printing a document.

Digits to Dots: RIPs

Now that the PDL has transmitted the information describing the page, the RIP must decode the information and translate it into instructions for the printer.

The basics of a RIP are fairly uniform. In the simplest case, such as with the original Apple LaserWriter RIP, the RIP takes input, uses instructions in ROM to compose a page bit map in RAM, and then outputs it line by line through a video output section.

Let's look at this a little more closely (see figure 4). The input section receives a page description from a host computer. As the page description comes in, the 68000 CPU interprets the PDL, using the interpretation code in ROM, and generates a page bit map in RAM. When the bit map is ready, the 68000 reads a word and sends it to a shift register in the video section. The video section sends the contents of the register to the printer as a raster, much like a television signal, over a single line. The contents of the register control the laser, which in turn places the dots on the paper, producing the end result you see.

The entire operation is under the con-

continued

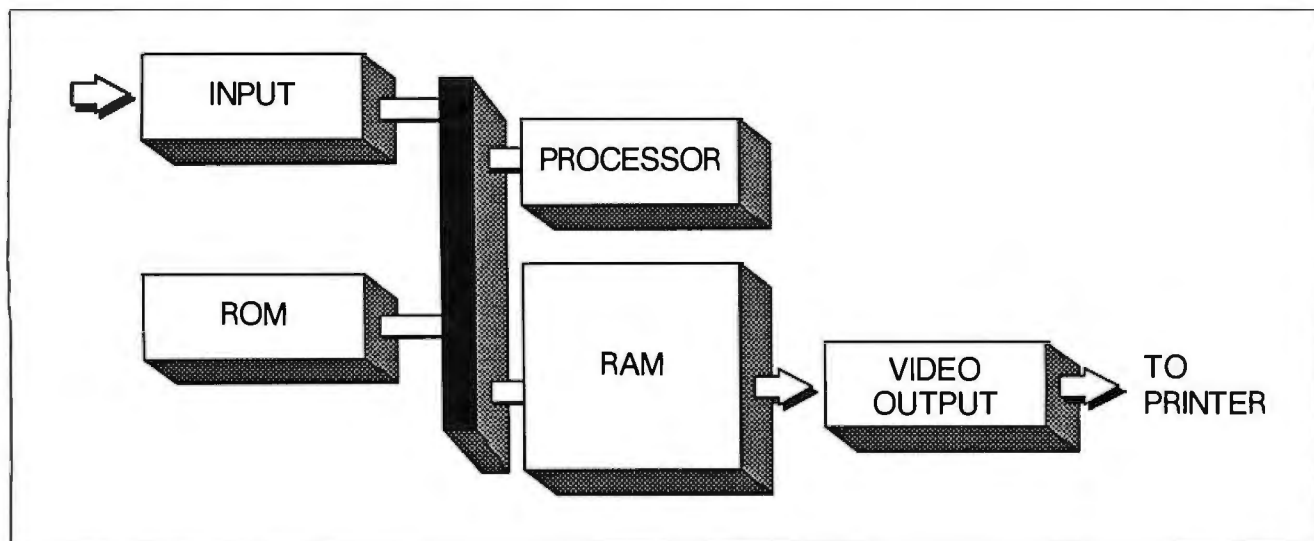
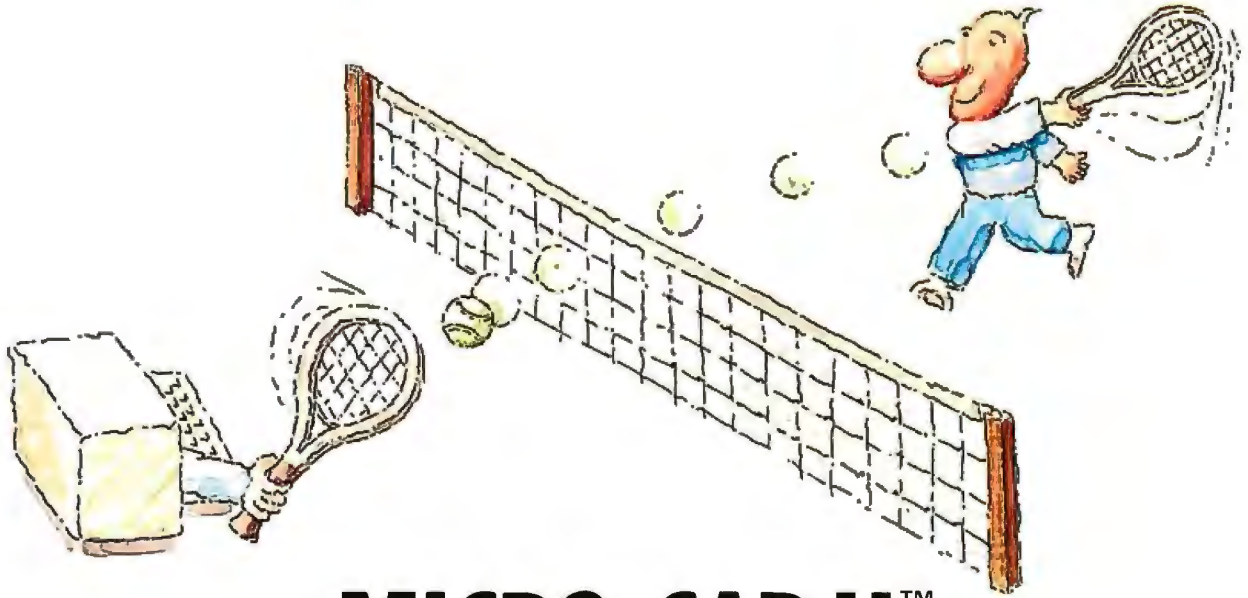

Figure 4: A simple raster-image processor.



MICRO-CAP II.™

The CAE tool with fully interactive analog simulation for your PC.

Spectrum Software's MICRO-CAP II® is fast, powerful, and feature rich. This fully interactive, advanced electronic circuit analysis program helps engineers speed through analog problems right at their own PCs.

MICRO-CAP II, which is based on our original MICRO-CAP software, is a field-proven, second-generation program. But it's dramatically improved.



Schematic Editor

MICRO-CAP II has faster analysis routines. Better resolution and color. Larger libraries. All add up to a powerful, cost-effective CAE tool for your PC.

The program has a sophisticated integrated schematic editor with a pan capability. Just sketch and analyze. You can step

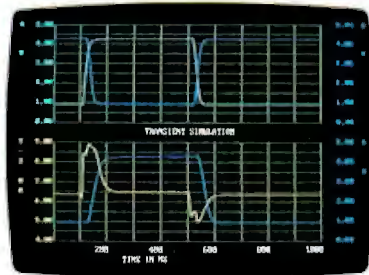

Transient Analysis

component values, and run worst-case scenarios—all interactively. And a 500-type* library of standard parts is at your fingertips for added flexibility.

MICRO-CAP II is available for IBM® PCs and Macintosh.™ The IBM version is CGA, EGA, and Hercules® compatible and costs only \$895 complete. An evaluation version is available for \$100. Call or write today for our free brochure and demo disk. We'd like to tell you more about analog solutions in the fast lane.

- Integrated schematic editor
- Fast analysis routines
- High-resolution graphic output
- Standard parts library of 500* types

*IBM versions only.

- Transient, AC, DC, and FFT routines
- Op-amp and switch models
- Spec-sheet-to model converter*
- Printer and plotter* hard copy



AC Analysis



1021 S. Wolfe Road, Dept. E
Sunnyvale, CA 94087
(408) 738-4387

MICRO-CAP II is a registered trademark of Spectrum Software.
Macintosh is a trademark of McIntosh Laboratory, Inc. and is being used with express permission of its owner.
Hercules is a registered trademark of Hercules Computer Technology
IBM is a registered trademark of International Business Machines, Inc.

A RIP needs memory for three purposes: to store code, to store glyphs, and to act as a page buffer.

trol of a 68000 CPU. In the case of Apple, data is sent either serially or through AppleTalk. The CPU handles all handshaking and timing details for inputting from the host, composing the bit map according to the ROM-based specifications, and outputting through the video section to the printer itself.

RIP Innovations

So far, we've described a generalized picture of how RIPs work. Getting more specific, we'll discuss the Interleaf RIP in particular and look at some hardware modifications that improve performance. By describing them, we can present the next level of detail in RIP technology.

In our design, we decided to allocate the RIP's memory dynamically. A RIP needs memory for three basic purposes: to store code, to store glyphs, and to act as a page buffer. While it is tempting from the hardware point of view to segregate memories (reflecting the analytic,

segmented nature of most hardware design), we had reasons for leaving the memory unsegmented.

First, having separate memories for each function can require complicated memory circuits. Also, with a minimum of 2 megabytes of dynamic RAM, not only can a second 8- by 11-inch page be composed while the first is printing, but with dynamic memory allocation, the same RIP can also print 11- by 17-inch pages by using the second megabyte for the oversize page's composition. Similarly, if you need a huge amount of font storage for some task, the memory is there to be allocated.

The bit map is made by a series of reads and writes. The reading and writing occupy much of the RIP's processing time required by the 68000 CPU. Therefore, we decided to add a hardware assist in the form of a blitter.

The 68000 can address up to 16 megabytes of memory. The Interleaf RIP has 3 megabytes installed so that it can compose the next page while the current page is being printed. Because this leaves the upper 2 address bits unused, we can use these bits to select the memory's mode. The most significant bit of the address is used to select the blit mode. When the hardware sees this bit set, it knows to address the existing 3 megabytes, but in the blit mode. The data is shifted to the right, inverted, and then put on the write-enable pins of 16 dynamic RAMs. This process

is then repeated for the second word, except with a shift to the left and with the memory address incremented (see figure 5). Both writes are done in one write instruction. The data input pins on the RAMs during this process may all be set to ones or zeros. If set to one, the result is an OR. If zero, the result is a KO, or knock out (i.e., every one in the source data results in a zero in RAM).

This is a direct OR to memory, done in one cycle. It speeds up the drawing of glyphs and bit-map images by a factor of eight. A character of up to 32 by 32 pixels that are not word-aligned, for example, may be ORed to the bit map in less than 200 microseconds.

The word-boundary offset (n) arrives via its own special hardware path. The 68000 cannot address particular bits within words in one cycle, which is precisely what we need it to do. So we created a special bit-address register that contains, in 4 bits, the information necessary to address a bit within a word.

The system also has direct-memory addressing for the output to the printer, for the input from the host, and for refreshing the dynamic RAMs used. The DMA output to the printer can also be used to clear the bit map, saving approximately 0.25 second of processor time per page. To enable this function, the DMA controller uses an otherwise undefined function code when it reads the data from the

continued

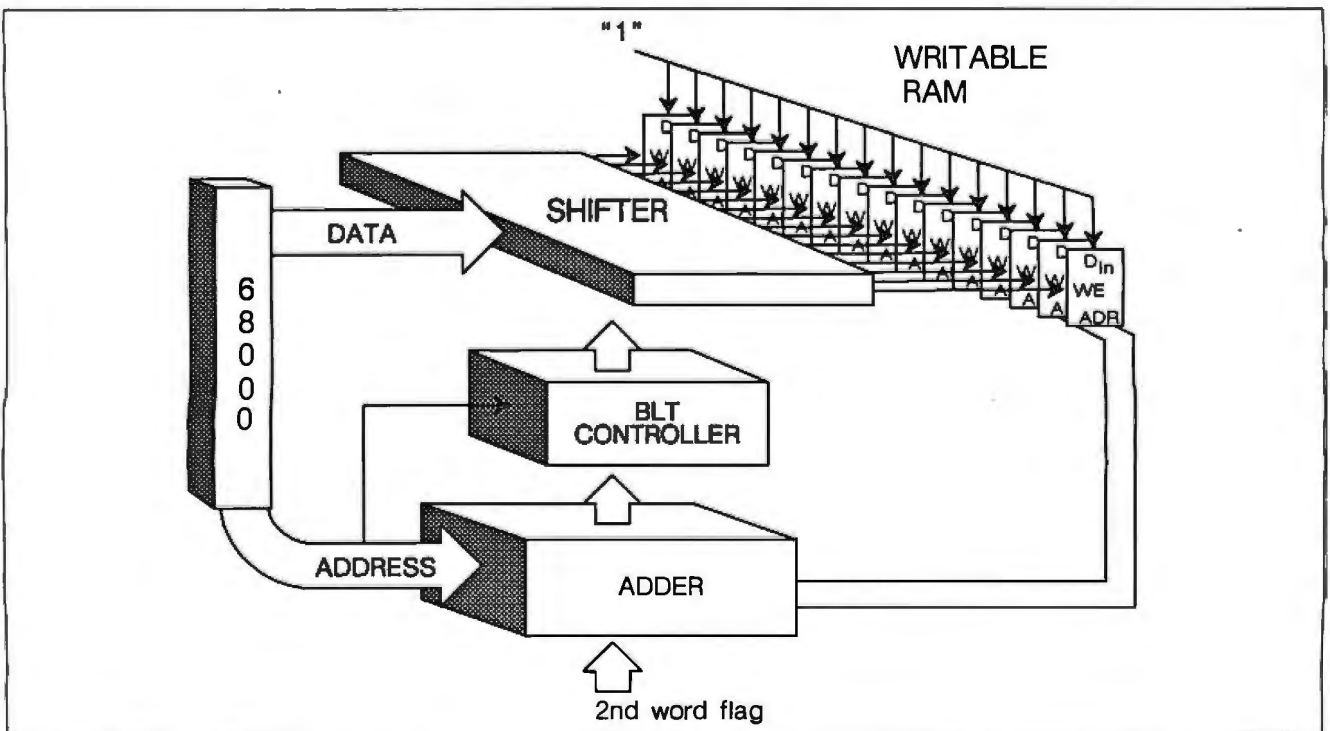
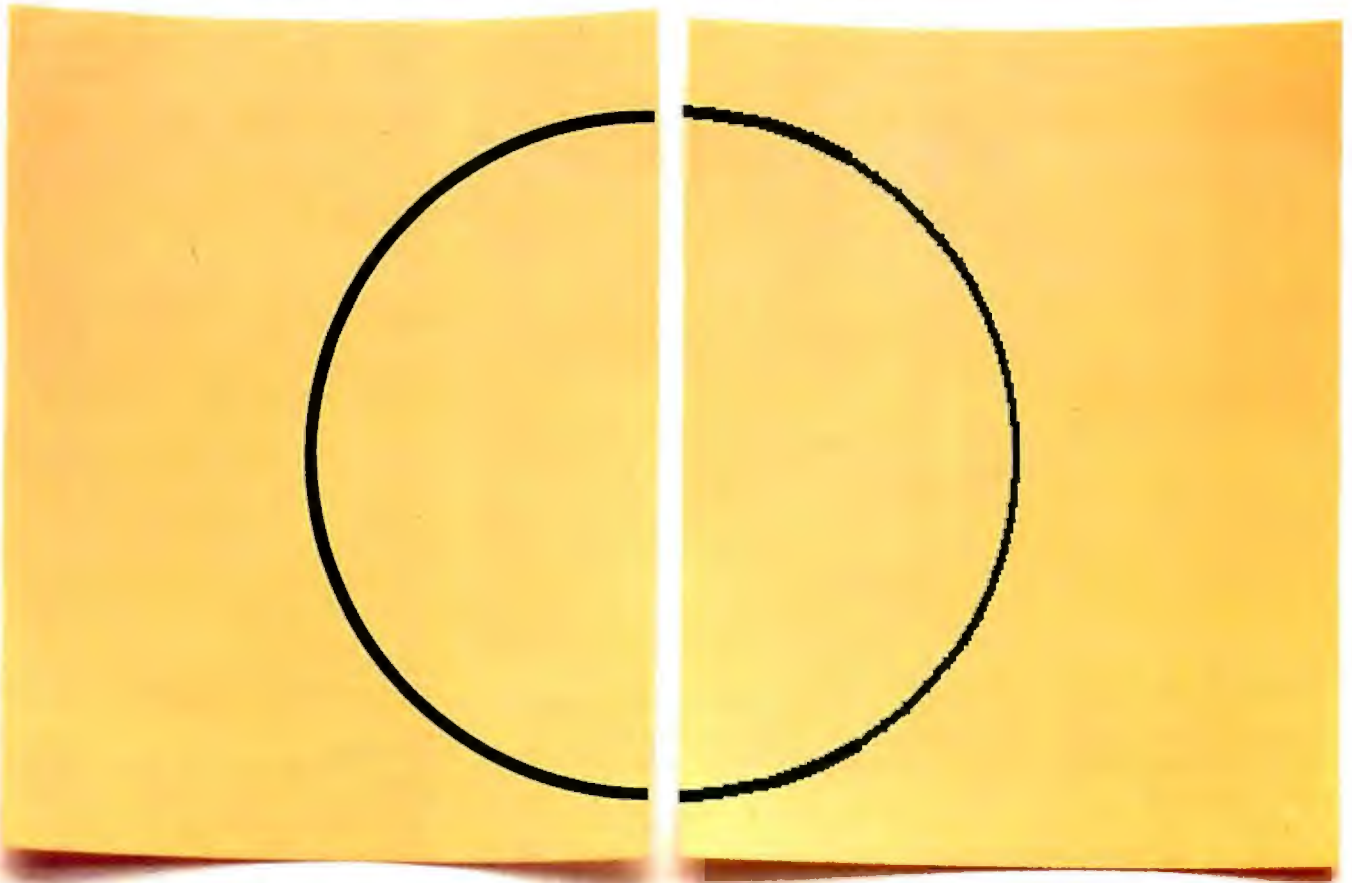

Figure 5: The most significant flags blit mode. Data is shifted and sent to the write-enable pin of the dynamic RAMs. For the second word, the address is incremented. The result is a direct OR to memory in one cycle.

QuadLaser™ draws circles around the competition.



QuadLaser's full page resolution of 300 dpi creates graphics that give you smooth curves and sharp detail.

The competition's full page resolution creates images that look jagged.

QuadLaser looks better than the competition. Here's why:

With QuadLaser, circles look like circles, not jagged lines. And solid areas look black, not dull gray.

BLACK!

BLACK?

QuadLaser looks better than the competition because QuadLaser comes with 2 megabytes of memory. That means

you get sharp, crisp images every time.

Plus QuadLaser comes with 70 type fonts which can be printed in portrait and landscape. And

QuadLaser emulates Epson, Qume, and HP LaserJet printers.

Epson is a registered trademark of Epson America, Inc. Qume is a registered trademark of Qume Corp., a subsidiary of ITT. HP and HP LaserJet are registered trademarks of Hewlett Packard.



QuadLaser lasts longer than the competition. Here's why:

QuadLaser's durable design supports a 10,000 page per month duty cycle and a 600,000 page engine life.

That's over three times better than the competition's promise of only 180,000 pages.

For increased productivity, QuadLaser features 8 original pages per minute printing, 250 sheet input and output capacity, face down collating, and over 500K of buffer space.

The competition? It can't compare.

For more information contact us at One Quad Way, Norcross, Georgia, 30093. Or call 404-564-5566.

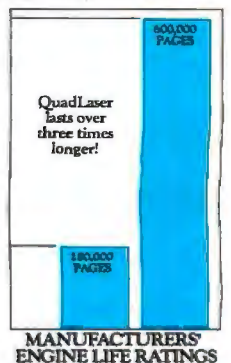

QUADRAM
An Intelligent Systems Company

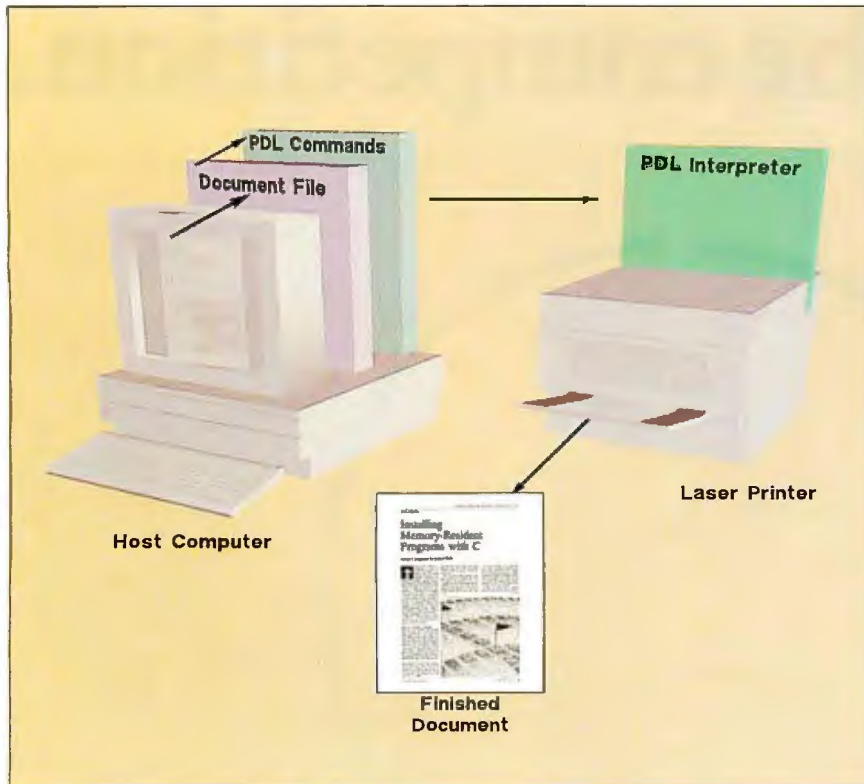

Figure 6: The document is created on the host computer and converted into a document file, in this case a Printerleaf file. A filter translates that file into the appropriate PDL. The PDL commands are passed to the PDL interpreter on the RIP. The RIP translates the commands in the pulses of the laser, which produces the finished document.

memory for the printer. This function code causes the memory controller to do a read-clear cycle rather than a read cycle. If you want multiple copies of a page, the bit map is not cleared.

These changes in design make a RIP capable of printing pages of great complexity at very high speed.

Software Decisions

Interleaf also designed its own document description language (Printerleaf), comparable to Interpress in many of its design considerations, and its own PDL (RI-Print) to take special advantage of the design of our RIP. The design considerations are, we think, illustrative of the challenges PDLs create.

We knew that the output from our electronic publishing software would be directed toward a wide variety of printing devices, ranging from laser printers to typesetters. Thus, we decided that the most flexible approach was to provide printing systems capable of supporting device and language independence so that documents could be transparently directed toward many existing and to-be-announced printers. Also, we recognized that many users would want to direct output to a choice of printers in an office set-

ting that might contain various printers roughly in the same class (e.g., 300-dpi printers). In such a situation, you do not need device independence with the performance penalty it inevitably exacts (e.g., passing 2000 dpi's worth of information to a laser printer capable of only 300 dpi).

Further, we decided our PDL would be resolution-dependent, although the code would be device-independent. By making it resolution-dependent, we hoped to gain speed, quality, and control. We would gain speed because we would not have to go through the complicated algorithms necessary to translate a generic, resolution-independent, mathematical description of a font into bit maps; we would download the bit maps directly and save transmission time for lower resolution printers. In short, resolution dependence means more work at our end but produces qualities users desire.

The overall RIP software design allows for any selection of PDL interpreters to be either resident on, or downloaded to, the RIP. The RIP software is divided into the low-level RIP system interface and the higher-level PDL interpreters. The lower-level software provides communications services, print-engine interface

services, memory management services, and access to functions such as blt(), which might have hardware support. This layer of software shields the PDL interpreters from any particular hardware implementation dependencies. It also modularizes the software, easing ports to new RIP hardware implementations and adaptation to new print engines.

Our PDL, RI-Print, includes an extensive set of commands for drawing on the page, as well as controls for the printer. A RI-Print file is actually a series of immediately executed commands. Because they are immediately executed, not buffered, there is no limit to the number of commands you can use to describe a page.

The commands are encoded in binary, not ASCII. This results in compact code and efficient machine-to-machine transfer; the time savings can be orders of magnitude. If the most significant byte is set, the byte is considered a high-level command. If the MSB is not set, it is considered the Draw Thyself command. In fact, a single byte can cause a character to draw itself and set the XY position of the next character. The four Boolean operators included (OR, KO, MOV, and XOR) can, unlike with most typesetters, be applied to both text and graphics.

Summary

In general, the method for getting a document on the screen to paper is as follows (see figure 6): The document editor on the host computer produces the document file. Then a filter translates the document file into the PDL for the target printer. The PDL commands are then passed as a data stream to the PDL interpreter on board the RIP. The RIP translates the commands into the pulses of the laser in the laser printer. These pulses cause the toner to adhere to the paper to produce the printed words and graphics.

The result is a successful interaction of hardware and software to produce a high-quality document with minimum effort on the part of the user. ■

ACKNOWLEDGMENTS

We would like to thank Michael Mark, Riaz Moledina, Robert Morris, and David Weinberger for their help.

REFERENCES

1. We wish to thank Robert A. Morris, of Interleaf and the University of Massachusetts at Boston, for his contribution to this section on PDLs, much of which is drawn from his article, "Page Description Languages," Proceedings of the ProText II Conference, Boole Press, Dublin, 1985.
2. "PostScript: Can It Cut the Mustard?" *The Seybold Report on Publishing Systems*, March 17, 1986, Vol. 15, No. 12, page 20.

TEST EQUIPMENT THAT MEASURES UP TO YOUR SPECIFICATIONS



DMM-300 \$79.95
3.5 DIGIT DMM / MULTITESTER

Our best model. A highly accurate, full function DMM loaded with many extra features. Audible continuity, capacitance, transistor, temperature and conductance all in one handheld meter. Temperature probe, test leads and battery included.

- * Basic DC accuracy: plus or minus 0.25%
- * DC voltage: 200mv — 1000v, 5 ranges
- * AC voltage: 200mv — 750v, 5 ranges
- * Resistance: 200 ohms — 20M ohms, 6 ranges
- * AC/DC current: 200uA — 10A, 6 ranges
- * Capacitance: 2000pf — 20uf, 3 ranges
- * Transistor tester: hFE test, NPN, PNP
- * Temperature tester: 0° — 2000° F
- * Conductance: 200ns
- * Fully over-load protected
- * Input impedance: 10M ohm



DMM-200 \$49.95
3.5 DIGIT FULL FUNCTION DMM

High accuracy, 20 amp current capability and many range settings make this model ideal for serious bench or field work. Tilt stand for hands-free operation. 2000 hour battery life with standard 9v cell. Probes and battery included.

- * Basic DC accuracy: plus or minus 0.25%
- * DC voltage: 200mv — 1000v, 5 ranges
- * AC voltage: 200mv — 750v, 5 ranges
- * Resistance: 200 ohms — 20M ohms, 6 ranges
- * AC/DC current: 200uA — 20A, 6 ranges
- * Fully over-load protected
- * Input impedance: 10M ohm
- * 180 x 86 x 37mm, weighs 320 grams



DMM-700 \$49.95
3.5 DIGIT AUTORANGING DMM

Autorange convenience or fully manual operation. Selectable LO OHM mode permits accurate in-circuit resistance measurements involving semi-conductor junctions. MEM mode for measurements relative to a specific reading. Probes and battery included.

- * Basic DC accuracy: plus or minus 0.5%
- * DC voltage: 200mv — 1000v, autoranging or 5 manual ranges
- * AC voltage: 2v — 750v, autoranging or 4 manual ranges
- * Resistance: 200 ohms — 20M ohms, autoranging
- * AC/DC current: 20mA — 10A, 2 ranges
- * Fully over-load protected
- * Audible continuity tester
- * Input impedance: 10M ohm
- * 150 x 75 x 34mm, weighs 230 grams



DMM-100 \$29.95
3.5 DIGIT POCKET SIZE DMM

Shirt-pocket portability with no compromise in features or accuracy. Large, easy to read .5" LCD display, 2000 hour battery life with standard 9v cell provides over two years of average use. Probes and battery included.

- * Basic DC accuracy: plus or minus 0.5%
- * DC voltage: 2v — 1000v, 4 ranges
- * AC voltage: 200v — 750v, 2 ranges
- * Resistance: 2k ohms — 2M ohms, 4 ranges
- * DC current: 2mA — 2A, 4 ranges
- * Fully over-load protected
- * Input impedance: 10M ohm
- * 130 x 75 x 28mm, weighs 195 grams



MODEL 2000 \$349.95
20 MHz DUAL TRACE OSCILLOSCOPE

Model 2000 combines useful features and exacting quality. Frequency calculation and phase measurement are quick and easy in the X-Y Mode. Service technicians will appreciate the TV Sync circuitry for viewing TV-V and TV-H as well as accurate synchronization of the Video Signal, Blanking Pedestals, VITS and Verticle/Horizontal sync pulses.

- * Lab quality compensated 10X probes included
- * Built-in component tester
- * 110/220 Volt operation
- * X-Y operation * Bright 5" CRT * TV Sync filter



MODEL 3500 \$499.95
35 MHz DUAL TRACE OSCILLOSCOPE

Wide bandwidth and exceptional 1mV/DIV sensitivity make the Model 3500 a powerful diagnostic tool for engineers or technicians. Delayed triggering allows any portion of a waveform to be isolated and expanded for closer inspection. Variable Holdoff makes possible the stable viewing of complex waveforms.

- * Lab quality compensated 10X probes included
- * Delayed and single sweep modes
- * Z Axis intensity modulation
- * X-Y operation * Bright 5" CRT * TV Sync filter



DPM-1000 \$54.95
3.5 DIGIT PROBE TYPE DMM

Autoranging, pen style design for the ultimate in portability and ease of use. Custom 80 pin LSI chip increases reliability. Audible continuity tester and data hold feature for added convenience. Case, test leads and batteries included.

- * Basic DC accuracy: plus or minus 1%
- * DC voltage: 2v — 500v, autoranging
- * AC voltage: 2v — 500v, autoranging
- * Resistance: 2k ohms — 2M ohms, autoranging
- * Fully over-load protected
- * Input impedance: 11M ohm
- * 162 x 28 x 17mm, weighs 75 grams

2 YEAR WARRANTY ON ALL MODELS

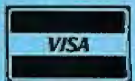

JDR INSTRUMENTS

110 Knowles Drive, Los Gatos, CA 95030

(408) 866-6200 • FAX (408) 378-8927 • Telex 171-110

Inquiry 161

COPYRIGHT 1986 JDR MICRODEVICES
THE JDR INSTRUMENTS LOGO IS A REGISTERED TRADEMARK OF JDR MICRODEVICES.
JDR INSTRUMENTS IS A TRADEMARK OF JDR MICRODEVICES.

ORDER TOLL FREE 800-538-5000

OR VISIT OUR RETAIL STORE
1256 SOUTH BASCOM AVE.
SAN JOSE, CA. (408) 947-8881

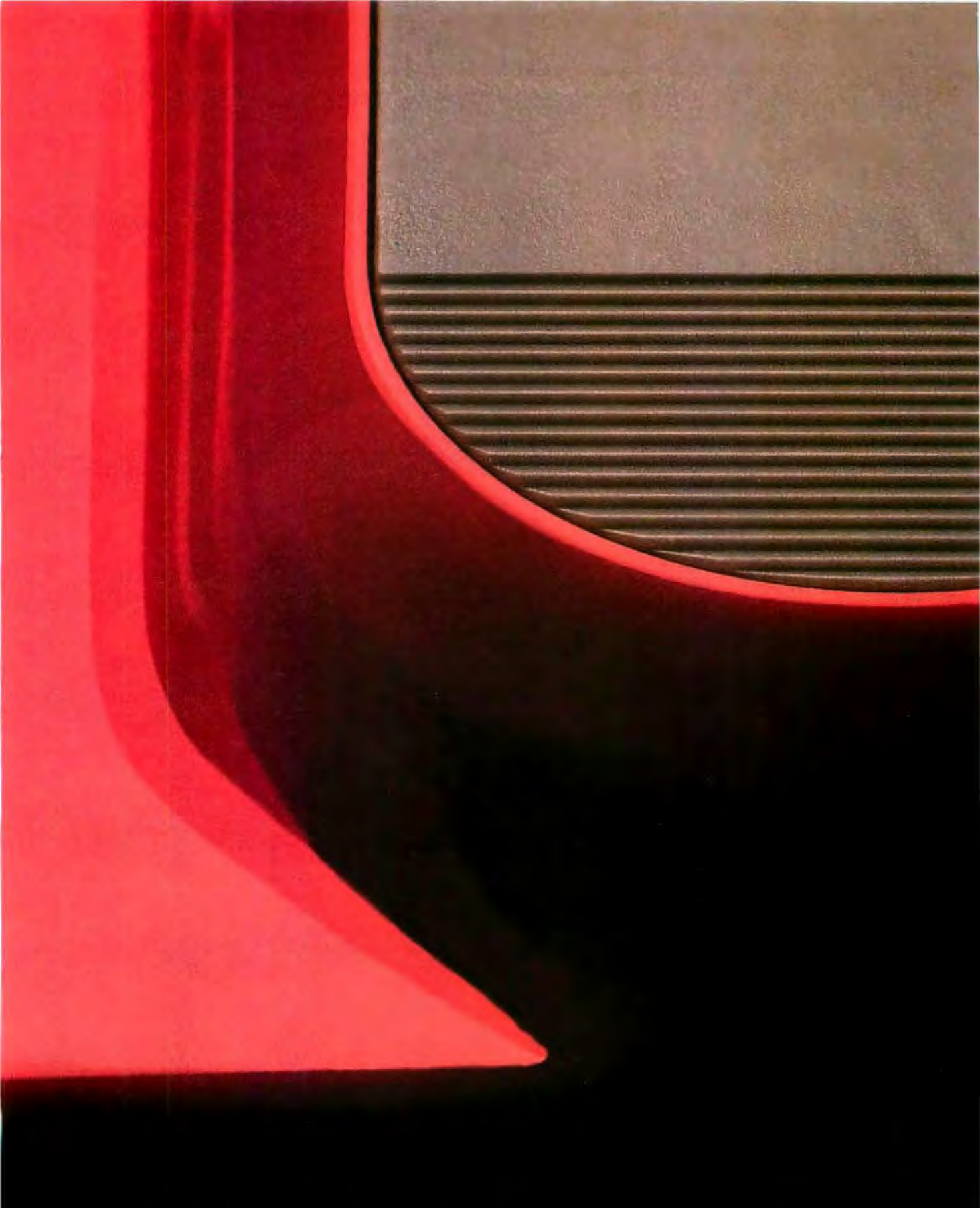

THE MIGENT POCKET MODEM™. A STATE-OF-THE-

It's ironic. These days, modems bring the world to you at the speed of light. But for all their awesome speed and power, these high-performance machines just sit there on your desk like a low-tech toaster.

But now, we're introducing the Migent Pocket Modem. It's 100% Hayes-compatible, so it works with virtually any PC: IBM, Apple, or whatever. It runs at both 300 and 1200 bps. It has a full set of Hayes AT commands. A 28-character non-volatile memory. Remote ring and tone sensing. Busy and dial tone monitoring. And even dual phone jacks.

But that's where all similarities end. The whole modem is smaller than a 3" x 5" card and works on a 9 volt battery or AC power. So you can put it in your shirt pocket or briefcase, and take it home, on the road, or anywhere else you need your PC.

The Migent Pocket Modem. If you'd like to know more, send in this coupon or call **800-633-3444**, Dept. 607, and ask for Alexis. We'll send you full information and the name of your nearest dealer. But in the meantime, you may be wondering why this modem isn't beige like the rest. Because we think it's about time a high-powered information machine looked like one.

Inquiry 208

Please send me more information about the Migent Pocket Modem. And send me the name of the dealer in my area.

NAME _____

ADDRESS _____

CITY _____ STATE _____ ZIP _____

PHONE _____

MIGENT™

Send to: Migent, Inc., 865 Tahoe Blvd., Call Box 6, Dept. 607, Incline Village, Nevada 89450-6062, Attn: Alexis

Registered trademarks: Apple, Apple Computer; Hayes, Hayes Microcomputer Products; IBM, International Business Machines. Trademark: Pocket Modem, Migent.



ART INFORMATION MACHINE THAT LOOKS LIKE ONE.



CLEO is your SNA or BSC Gateway

CLEO Software products allow microcomputers to communicate with IBM minicomputers and mainframes, and to emulate their workstations. CLEO products have been providing REMOTE communications between micros and mainframes since 1981. Over 44,000 CLEO users worldwide are running on all major brands of micro computers; the largest number of these users run CLEO software on IBM Personal Computers and NETBIOS LANs.

The qualifier REMOTE is a key factor distinguishing CLEO products from traditional emulators. All of the models contain full emulation of all the equipment at the remote site: the modem, the cluster controller, and the terminals.

Software features:

- PC/XT/AT compatible
- Stand-alone or NETBIOS LAN operation
- Supports Bisync or SDLC links
- 3780 and 3270 protocols install for operation in 19 different countries
- Application program interface
- Point-to-point or multi-drop selection
- Auto-dialing with selected modems

Call for information

on how one of our 5 hardware models will solve your communication problem.

- V.26/212AT/201 internal modem (2400 baud)
- V.26/201 internal modem (2400 baud)
- V.27/208 internal modem (4800 baud)
- SNA/BSC synchronous LAN gateway
- SNA/BSC stand-alone synchronous gateway

Distributors:

Benelux, Scandinavia
31(71)899202

Canada

514-737-3631

(Western Canada)

800-361-1210

(Ontario, Quebec and
Maritimes)

800-361-3185

Colombia, S.A.

2875492

France

46 87 33 66

Germany, Austria,

Switzerland

49(2823)18408

Italy

039 636191

Mexico

596-4825

Peru, S.A.

234-464

UK

44(1)2420012

0800-898404

U.S.A.

(800) 433-CLEO
(2536)

In Michigan

(313) 540-4600

CLEO Software

1639 North Alpine Road

Rockford, IL 61107

(815) 397-8110

Telex 703639

CLEO 

Programming in PostScript

*Techniques and applications in vision research,
plus a survey of PostScript hardware and software*

Denise G. Pelli

MOST PEOPLE WHO use PostScript-driven printers have never seen a PostScript program because their application software generates and sends the necessary PostScript commands automatically whenever they say "Print." For routine applications, this is as it should be. However, programming directly in PostScript opens up many new possibilities, particularly for creating images from mathematical descriptions.

For instance, I use PostScript to produce patterns to help my study of the visual system. In this article, I will use some of those patterns to illustrate PostScript's power. I'll also list some useful PostScript products and services.

PostScript programming is best for those occasions where you begin by knowing only a mathematical description of an image and want to find out what the image would look like. This approach is old hat to anyone who has done computer graphics on a video display. Unfortunately, it is difficult and expensive to obtain an accurate photograph of what's on the screen, primarily because of the non-linearity and variability of photography. PostScript lets you get faithful renditions directly on paper.

Another attraction of PostScript is that you can debug and refine your picture-generating programs using a relatively low-cost (around \$5000) laser printer such as the Apple LaserWriter, which will produce fair-quality drafts (300 dots per inch) immediately for a few cents per page. For the final output, you can send the same program by modem to a \$60,000 printer like the Linotype L300,

which will produce superb quality prints (2540 dpi) for \$10 per page. The same program runs on both printers because PostScript is machine independent. (This article includes examples produced by both printers.)

Overview

PostScript is a full-fledged structured language. Like FORTH, it is stack oriented and uses postfix notation. For example, to add 2 and 2 you say 2 2 add. Each PostScript printer has a built-in microprocessor and a PostScript interpreter that will run your program. The page is represented by a bit map, with 1 bit per pixel. (PostScript incorporates some limited support for color, but none of the available printers supports color.) When the page is printed (usually by the showpage command), the bit map is transferred to the page, making each pixel either black or white. However, to preserve machine independence, you are not allowed to read from or write to the bit map. Instead, your program includes "painting" operators that set and clear bits within defined areas of the bit map.

PostScript offers three kinds of painting operators, allowing three quite different approaches to describing your image: one-dimensional paths, two-dimensional sampled images, and text. Before explaining the three kinds of painting, I should say a few words about an operation that can be applied to all three: digital halftoning.

Each pixel in a PostScript image is either black or white. PostScript produces the illusion of intermediate gray

levels by digital halftoning—breaking the image up into cells, each containing many pixels, and setting some of the pixels to white and the rest to black. If the cells are too small for the eye to resolve, the viewer will see a uniform gray, and the illusion will be successful.

You can adjust the size of the cell by the screen operator, which lets you specify how many cells per inch. When you request a particular gray level, PostScript will set approximately that fraction of the pixels in each cell to white and the rest to black.

Obviously, there's a trade-off here. You'd like to have very small cells so that the eye can't resolve them and the picture will look continuous. But if the cells are small, they will contain few pixels and you will have only a few possible gray levels.

Your gray levels will be coarsely quantized (approximated by the nearest available discrete level). In images where the gray level varies smoothly, such as in a person's face, coarsely quantizing the gray level will produce noticeable contours at the transition between gray levels.

Note that digital halftoning is quite new and the terminology has not yet settled. In particular, the word "dot" refers

continued

Denise G. Pelli is a visual psychophysicist studying the information rate of the human visual system. He is an associate professor at the Institute for Sensory Research, Syracuse University, Syracuse, NY 13244-5290.

to two quite different things. If the resolution of a printer is specified as "300 dpi," it means 300 pixels per inch. If a halftone image is "18.75 dpi," it means 18.75 halftone cells per inch. If the image is produced by digital halftoning, you can assume that each cell has many pixels. For example, nearly all the black-and-white continuous-tone images in BYTE have 120 cells per inch. Most of those images were produced by traditional halftoning, which does not involve pixels at all.

The faces below (see figure 2) were produced by digital halftoning with 120 cells per inch and 2540 pixels per inch, so each square cell contains $(2540/120)^2 = 448$ pixels. In principle, this would allow for 449 different gray levels (from 0 to 448 pixels set to white in each cell), but an undocumented limitation of PostScript is that the requested gray level is quantized to 8 bits, allowing, at the most, 256 different gray levels.

Paths

One of the fundamental design goals of PostScript is to be independent of the details—especially the dot resolution—of the particular printer used. To achieve and enforce this, PostScript does not let you ask any questions about the state

(black or white) of the pixels that make up the page's image. Instead, you create an image by defining an area or "path" and then filling it.

A path is a series of lines and curves, like a line drawing. However, the path itself is not a drawing. To make an image, you must use a painting operator. The two painting operators that can be applied to paths are stroke and fill. Stroking a path produces an image on the page consisting of a line of specified thickness. (You can also specify the gray level, the kind of dashes for a dashed line, the type of line termination, and the shape of corners.) Filling a path causes areas that are inside the path to be painted with a specified gray level, without affecting areas that are outside. The meanings of "inside" and "outside" are obvious for a simple closed curve. For more complex paths, PostScript offers a choice of two different rules for determining which areas are inside and out.

Figure 1 was produced by stroking paths. The R and V are two of the ten characters (C D H K N O R S V Z) in the Sloan font, named after its designer, Louise Sloan. The Sloan font is recommended for vision testing (reference 1).

Obviously, if you are designing vision tests, it is helpful to be able to use the officially sanctioned font. Listing 1 shows the programs that I wrote to produce R and V. I wrote similar programs for the other eight characters in the Sloan alphabet. With some extra statements, you could make this a proper PostScript font, usable in any place where you would like to display text.

The first two statements in listing 1 are comments. Everything from a % to the end of the line is ignored. It is traditional for the first line of a PostScript program to begin with %! to help your computer identify it as a PostScript file. The third

line begins /preSloan, which pushes the name preSloan onto the stack. Then comes a procedure enclosed in braces that extends over several lines. PostScript treats spaces and carriage returns merely as separators. The procedure is compiled and pushed onto the stack as one item. After the closing brace of the procedure is the word def. That causes PostScript to pop the top two items from the stack and use these to define the word preSloan to refer to the given procedure. It does that by putting the word preSloan in a dictionary, with the procedure as the meaning. From now on, the word preSloan will invoke that procedure.

The following lines similarly define the procedures postSloan, R, and V. The line 50 700 moveto first pushes 50 onto the stack, then pushes 700 onto the stack. Then the operator moveto pops the top two items from the stack and moves the current location to that x-y coordinate. (The default coordinate system puts the origin at the lower left corner of the page and measures distance in "points," 72 to the inch, so the location [50,700] corresponds to [0.69 inches, 9.72 inches], which is 0.69 inches from the left margin and $11 - 9.72 = 1.28$ inches down from the top of the 8½-by-11-inch page.)

The 40 40 scale command amplifies the scale so that one unit corresponds to 40 points. R invokes the R procedure, which draws an R one unit wide and one unit high (where one unit is now 40 points). The R is made up of lines and arcs. It is all "clipped" by a unit square, set up in preSloan, so that only what falls inside the square appears in the final image. It is the same for V. Finally, showpage transfers the image to paper and ejects the page from the printer. You can send this program to any PostScript printer to obtain an image like figure 1.

Figure 2 was also produced by paths.

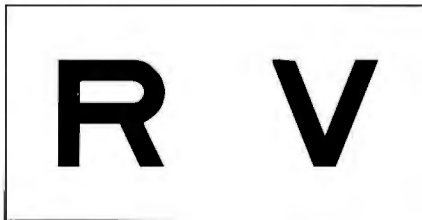

Figure 1: Two letters of the Sloan font for vision testing produced by listing 1 on a Linotype L300 at 2540 dots per inch.

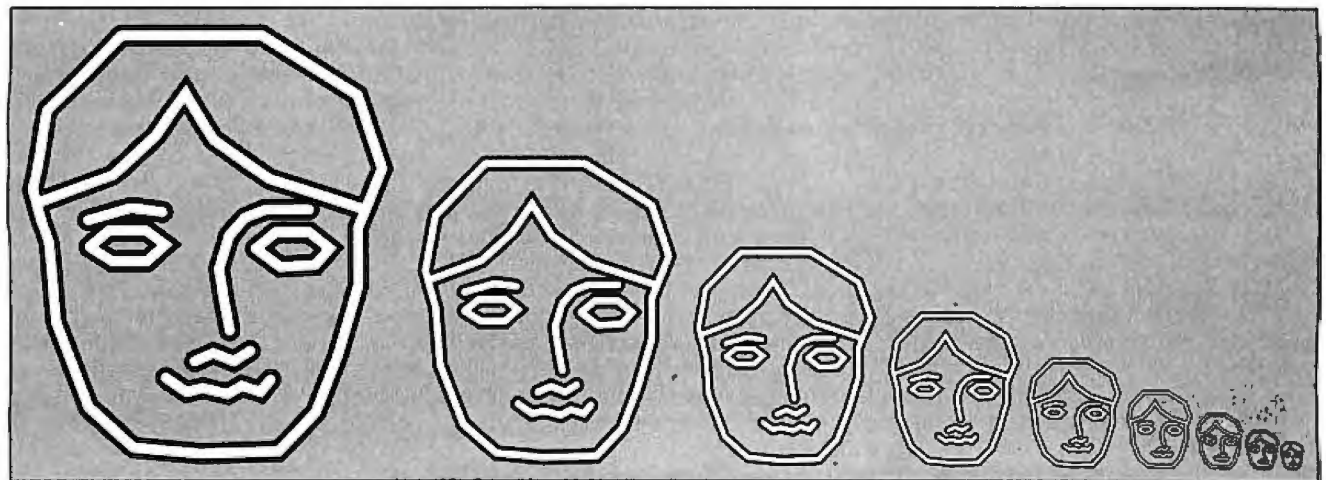

Figure 2: Faces for testing infant acuity produced by listing 2 on a Linotype L300 at 2540 dots per inch.

The face in the figure is designed for acuity testing of infants. When you can see anything at all, you can see that it's a face. The black and white lines making up the face disappear when they are too thin for the eye to resolve. The biggest face will disappear when you are about 24 feet away, depending on your visual acuity. The smaller faces will disappear at proportionally shorter distances. The smallest face will disappear at about 18 inches. The trick to making it disappear is to draw it with a ribbon consisting of equal parts of white and black, so that when the white and black are blended together by the eye, the resulting average is identical to the gray background (references 2 and 3).

Listing 2 gives the PostScript program used to produce figure 2. After a few comments the face procedure is defined; it consists solely of moveto and lineto commands that trace a path. The draw procedure is defined next. Then the whole page is painted gray.

The program is optimized for the Linotype L300 running at 2540 dpi. For best results at 300 dpi, such as on a LaserWriter, you should remove the % from the beginnings of two lines labeled "at 300 per inch" and place the % symbol at the beginning of the two lines marked "at 2540 dots per inch." The % causes the rest of the line to be treated as a comment—in other words, ignored. After you remove the % from each line, those lines will give you the best choice of screen density for a LaserWriter.

Note that this does not contradict the claim that PostScript is device independent. When you go from higher resolution to lower resolution, you have to make some trade-offs in coarseness of screen and precision of gray level. You can often get acceptable results by letting the PostScript printer make the trade-off itself, but if you understand the underlying issues, you can usually get better results by specifying exactly what you want. The two gray levels were found by trial and error to produce 50 percent reflectance on the two printers at these screen densities.

The main program is next. It consists of a loop 9[. . .]repeat, which means that the procedure enclosed in braces should be repeated nine times. Inside the braces you will find the commands face, which lays down the path of the face, and draw, which paints the path, and the operators translate and scale, which shift and shrink the coordinate system to get ready for the next face.

To produce a black-and-white ribbon, the draw procedure must stroke the same path twice. This requires a trick, since

continued

Listing 1: *The PostScript program to produce R and V in the Sloan font.*

```
%!
% Produce Figure 1
/preSloan {gsave currentpoint translate 0.2 0.2 scale
  newpath 0 0 moveto 0 5 lineto 5 5 lineto 5 0 lineto
  closepath clip newpath 1 setlinewidth 2 setlinecap 0
  setlinejoin} def
/postSloan {stroke grestore 2 0 rmoveto} def
/R {preSloan 0.5 0.5 moveto 0 4 rlineto 3.5 3.5 1 90 270
  arcn -3 0 rlineto 4.44370 0 moveto -0.97547 2
  rlineto postSloan} def
/V {preSloan 0 6.34629 moveto 2.5 -6.25 rlineto 2.5 6.25
  rlineto postSloan} def
50 700 moveto
40 40 scale
R
V
showpage
```

Listing 2: *The PostScript program to produce the faces in figure 2.*

```
%!
% Produce Figure 2

% path of face
/face {39 210 moveto 108 210 lineto 155 181 lineto 167
  146 lineto 155 117 lineto 155 89 lineto 145 55
  lineto 134 27 lineto 116 8 lineto 78 7 lineto 46
  10 lineto 23 30 lineto 7 71 lineto 4 110 lineto -
  3 136 lineto 4 174 lineto 39 210 lineto 1 130
  moveto 36 143 lineto 57 162 lineto 71 182 lineto
  85 160 lineto 112 141 lineto 158 126 lineto 24
  121 moveto 45 127 lineto 60 125 lineto 24 108
  moveto 34 116 lineto 52 116 lineto 61 109 lineto
  52 101 lineto 35 101 lineto 24 108 lineto 105
  107 moveto 115 115 lineto 131 115 lineto 141 107
  lineto 134 99 lineto 117 98 lineto 105 107 lineto
  131 126 moveto 110 126 lineto 100 122 lineto 92
  113 lineto 87 97 lineto 89 83 lineto 92 67 lineto
  61 44 moveto 71 37 lineto 79 39 lineto 91 36
  lineto 98 40 lineto 107 37 lineto 112 43 lineto
  75 52 moveto 84 56 lineto 94 52 lineto 102 57
  lineto} def

% Draw high-pass ribbon
/draw { gsave 0 setgray stroke grestore gsave
  currentlinewidth 2 div setlinewidth 1 setgray stroke
  grestore newpath} def

% Set up screen, etc.
%120 currentscreen 3 -1 roll pop setscreen % at 2540 dpi
%0.69 setgray clippath fill 0 setgray % at 2540 dpi
%30 currentscreen 3 -1 roll pop setscreen % at 300 dpi
%0.58 setgray clippath fill 0 setgray % at 300 dpi
1 setlinecap
10 setlinewidth
30 560 translate

% Ever smaller faces across page
9{
  face
  draw
  190 0 translate
  .707 .707 scale
} repeat

showpage
```

PostScript-Related Products

Publications

- Colophon PostScript* newsletter (free). Adobe Systems Inc., 1870 Embarcadero Rd., Palo Alto, CA 94303, (415) 852-0271.
- Computer Shopper*, \$21 per year. The "Ask the Guru" column by Don Lancaster has occasional tidbits on PostScript. Computer Shopper, P.O. Box 1419, Titusville, FL 32781.
- Graphic Perspective PostScript* newsletter, \$40 per year. Ashley House, 176 Wickstead Ave., Toronto, Ontario, Canada M4G 2B6.
- PostScript Language Tutorial and Cookbook*, \$16.95, and *PostScript Language Reference Manual*, \$22.95, by Adobe (Reading, MA: Addison-Wesley, 1985).
- PostScript Supplement for the Linotype Series 100*, Version 38.0, 1985, revised May 15, 1986. Adobe Systems Inc.
- The PostScript Language Journal*, \$15 per year. Pipeline Associates Inc., 39 East Twelfth St., New York, NY 10003.

Software

- Appewriter/Laserwriter Utilities Package (ProDOS software), \$49.50. Synergetics, 746 First St., Box 809, Thatcher, AZ 85552, (602) 428-4073.
- AppleTalk PC Card, \$399. Apple Computer Inc., 20525 Mariani Ave., Cupertino, CA 95014, (408) 996-1010.
- Colophon 2 Images disk includes program and sampled image data to produce figure 3. \$12 including postage & handling. Adobe Systems Inc.
- Cricket Draw program, \$295. Cricket Software, 3508 Market St., Suite 206, Philadelphia, PA 19104, (215) 387-7955.
- SendPS 1.0 downloader program. Included on the Colophon 2 Images disk. Adobe invites free distribution of SendPS but forbids selling it without permission.
- Ehandler.ps 2.1 error break page handler program (free). Adobe Systems Inc.
- JustText program, \$195. Knowledge Engineering, G.P.O. Box 2139, New York, NY 10116, (212) 473-0095.
- MockWrite 4.3.2 desk accessory program, \$35, shareware. CE Software, 801 73rd St., Des Moines, IA 50312, (515) 224-1995.
- Onyx projection plate media. 3M Company, 6850 South Harlem Ave., Bedford Park, IL 60501.
- PC MacBridge Appletalk network interface board and LaserWriter utilities and network software for IBM PCs, \$350. Tangent Technologies Ltd., 5720 Peachtree Parkway, Suite 100, Norcross GA 30092, (404) 662-0366.
- Post-a-Matic 3.3z program, Canadian \$50, shareware. Peter Bennett, Graphic Presentation Charts, 23 Exford Dr., Scarborough, Ontario, Canada M1P 1L5, (416) 751-2727 home, CompuServe 76314,1670.
- PostHaste downloader program, \$50. Micro Dynamic Ltd., 8555 Sixteenth St., Suite 802, Dept. 2, Silver Spring, MD 20910, (800) 634-7638.
- TOPS, AppleTalk network fileserver for Macintoshes, \$149 per computer; for IBM PCs, \$389 per computer on an AppleTalk network. Centram Systems West, 25609th St., Berkeley, CA 94710, (415) 549-5900.

PostScript-compatible printers (more than 300 dpi)

- Agfa-Gevaert P400PS (400 dpi)
 CompuGraphic CG400PS (400 dpi)
 Linotype Linotronic L300 with PostScript RIP (up to 2540 dpi)
 Linotype Linotronic L100 with PostScript RIP (up to 1270 dpi)

PostScript-compatible printers (300 dpi)

- Apollo Domain/Laser 26
 Apple LaserWriter and LaserWriter Plus
 Dataproducts LZR-2665
 DEC PrintServer 40
 Diconix Dijit 1/PS
 Facit Opus 2E and 3 (with optional PostScript cartridge)
 Hanzon Data LP-5000
 ITT Qume Scrip TEN
 Laser Connection PS Jet (upgrade for existing printers, including HP LaserJet)
 NBI Model 908
 NEC SilentWriter LC-890
 QMS PS 800 and PS 2400
 Sun Microsystems LaserWriter
 Texas Instruments OMNILASER 2108 and OMNILASER 2115

stroking a path eliminates the path. The first command in draw is gsave, which saves the graphics state, including the path. Then the line width is set, the gray level is set to 0 (i.e., black), and the path is stroked. This produces a black line drawing of a face on the gray background. Next, the grestore command restores the graphics state, including the path but not affecting the image, which is not part of the graphics state. Now, after reducing the line width by half and setting the gray level to 1 (i.e., white) draw strokes the path again. This produces a white line running down the center of every black line. After the nine iterations of the main loop, the image is done. All that remains to put it on paper is to give the showpage command.

A reasonable question to ask at this point is: How did I obtain the sequence of lineto and moveto commands to produce the face? I could have drawn the face in pencil on graph paper and read off the coordinates. In fact, I obtained this sequence by using MacDraw to draw the face freehand. I then captured the PostScript output of MacDraw and cleaned that up using Post-A-Matic (a program that translates Macintosh's abbreviated PostScript to standard PostScript commands) and a bit of editing. A new program called Cricket Draw makes this much easier. (Further information on items mentioned appears in the text box at left.)

To test an infant's vision, I would print up many gray cards, each with a single face on either the left or the right. The testing technique is called "Forced Choice Preferential Looking." A person who can't see the test card looks at the infant's eyes and tries to guess on which side the face is by which way the infant is looking. By testing many times, you can determine how reliably the person observing the infant's eyes can guess where the face is. If the infant's eyes tell you where the face is, you can reasonably conclude that the infant can see the face (reference 4).

Sampled Images

The second way to produce an image in PostScript is to use the image operator and provide it with the gray level of the desired image at each point on a regular grid. The most obvious application of this would be to reproduce a photograph that has been sampled previously. Figure 3a is an example. Each sample from the photograph is imaged by a cell containing many pixels. The fraction of the pixels in the cell that are white determines the gray level. Figure 3a was produced by a Linotype L300 at 2540 pixels

continued

Borland's Turbo Lightning™ FREE



Enlarged Shift keys

Two Ctrl and Alt keys for ambidextrous access.

Positive-tactile, firm-feel keys.

12 Function keys for increased automatic operation.

Extra-wide, easy-to-find Return key. IBM changed sizes again by shrinking their Return key.

Dedicated Function Control keys.

Caps, Num and Scroll Lock indicator lights. IBM has no lights on their XT.

Separate Dedicated Numeric Pad with enlarged Enter key, four Arithmetic Function keys.

Separate Cursor and Screen Control keys.

Switch-selectable compatibility with IBM, PC, XT, AT, PCjr, AT&T and all compatibles. IBM's new Enhanced Keyboard runs only on their new XT's, AT's and ignores their installed base which probably includes you.

Switch allows you to swap position of Ctrl and Caps lock. IBM moved Ctrl to bottom row, you have no choice!

Here it is...DATADESK'S TURBO-101 ENHANCED KEYBOARD for the 10 million PC users IBM just ignored!

IBM just announced their new redesigned "standard" keyboard for personal computers. There's only one problem: *it won't work on your IBM computer if it was purchased prior to June 1986 or on any PC compatible purchased at any time!*

Not to worry. Our new Turbo-101 Enhanced Keyboard gives you the layout and enhancements of the IBM with some logical improvements (see above photo). And it works on your existing PC, XT, AT, PCjr, AT&T, Epson and virtually all compatibles!

Get Borland's Turbo Lightning™ For FREE!

To really turbocharge your productivity, we are including, free-of-charge, Borland's red-hot Turbo Lightning software with each keyboard. Now, when using SideKick, WordPerfect, Micro-soft Word, 1-2-3 or most popular programs, our Turbo-101 Keyboard will check your spelling as you type, gives you instant access to Random House's 80,000-word Concise Dictionary and 60,000-word Thesaurus and much, much more!



"Lightning's good enough to make programmers and users cheer, executives of other software companies weep," says Jim Seymour of PC Week. Sold separately, Turbo Lightning retails for \$99.95!

The Turbo-101 is the best data entry tool since the pencil!

For users of spreadsheets like 1-2-3, the Turbo-101's separate cursor and numeric data into cells and moving from cell to cell as natural as moving your fingers. And for word-processing, the 'Selectric' typewriter layout makes the Turbo-101 as easy to use as a pencil; and with the extra large Enter, Shift & Control Keys, you'll make so few mistakes, you won't even need an eraser!

Up to now, DataDesk International may be one of the best kept secrets, but here's what's being said about our first end-user Keyboard/Borland software bundle:

"Who Can Pass Up a Deal? Department. Talk about an aggressive product!"
John C. Dworak, InfoWorld Mar 86

"It solves all of the problems exhibited by their regular PC/XT keyboard...it's a great bargain!"
PC Productivity Digest May 86

"DataDesk Intl. has designed a sturdy and handsome keyboard that has tactile response...is the hardware bargain of the year" says Charles Humble, Oregonian Jan 86

"The best part of the keyboard is the way it feels. It's ideal! And fast. I've never worked on a keyboard with a nicer touch."
Business Computer Digest Aug 86

"It's a good keyboard. Good feel: the keys have tactile feedback. No mush at all. This is about as good a keyboard deal as you're likely to find...I have absolutely no hesitation in recommending the Model PC8700."
Jerry Pournelle, Byte Magazine Sept. 86

"This keyboard is neat to type on and feels solid. It has tactile feedback keys...I can type much faster on it."
Test Drive Scorecard: DataDesk-10 Key Tronics-9 Teleconnect Magazine May 86

SPECIAL OFFER!
ONLY \$149.95* FOR BOTH
KEYBOARD & SOFTWARE
Includes 30-day money back guarantee and 2 year full warranty.
To prove that we don't ignore you or your pocketbook, you get our Turbo-101 Enhanced Keyboard and Borland's Turbo Lightning for an astounding \$149.95.* No, you didn't read it wrong. During this amazing **Introductory Offer** you get both keyboard and software for less than most software programs by themselves! Now, if you're still feeling ignored, you can always do what you-know-who wants you to do...and buy a new computer to get their keyboard!

The Only Alternative
datadesk™
INTERNATIONAL

7650 Haskell Avenue
Van Nuys, California 91406 (818) 780-1673

Turbo-101 is a trademark of DataDesk International. Turbo Lightning is a trademark of Borland International. IBM and IBM AT are registered trademarks of International Business Machines, Inc.

Inquiry 88 for End-Users.
Inquiry 89 for DEALERS ONLY.

credit card orders call
(800) 826-5398
in CA call
(800) 592-9602

*Price does not include adapter cables required by certain compatibles. * A Limited offer—price subject to change without notification.



BOTH TURBO-101 ENHANCED™ KEYBOARD AND BORLAND'S TURBO LIGHTNING™ SOFTWARE FOR ONLY:
\$149.95* LIMITED OFFER
*Plus \$10 Shipping & Handling. California Residents Add \$8.75 Per Unit Sales Tax

NO. UNITS: _____
PAYMENT: VISA MC CHECK
AMOUNT ENCLOSED: \$ _____

Enter ←

NAME: _____
ADDRESS: _____ STATE: _____ ZIP: _____
CITY: _____ COMPUTER TYPE: _____
PHONE: _____ EXP: _____
CC NO.: _____

per inch. Figure 3b was produced by sending exactly the same program to an Apple LaserWriter Plus, which prints at 300 pixels per inch.

However, there is a more interesting application of the PostScript image command. You can use mathematics to synthesize an image that never existed before. Figure 4a is an example. By just looking at this pattern, you can perform a systems analysis of your visual system.

Any patch of the pattern is a sinusoidal grating, varying from white to black and back again. However, from left to right across the image, the fineness of the grating increases until it disappears. Similarly, from bottom to top the contrast of the grating decreases until it disappears. The lower the contrast of the grating, the higher the contrast sensitivity required to see it. If you follow any one bar in the image from the bottom up until it disappears, the height at which it disappears is the contrast sensitivity of your visual system for a grating of that fineness.

The fineness of a grating is usually specified as a spatial frequency—in cycles per inch, for example, where a cycle is a pair of light and dark stripes. However, the sensitivity of your eye depends not on the number of cycles per

inch but on the number of cycles per degree of visual angle subtended at the eye (try looking at the pattern from various distances), so for vision work it is preferable to specify spatial frequency in cycles per degree.

The outline of visibility of all the bars describes the sensitivity of your visual system over a wide range of spatial frequencies. Notice that the vertical bars when taken together form a hump, peaking in the middle and falling off toward the left and right. The falloff to the right is determined largely by the optical quality of your eye. The falloff to the left is determined by neural limitations of your eye. This outline of visibility explains many characteristics of vision, including many visual illusions.

Figure 4a was produced by the program in listing 3. After a few commands to set up the coordinate systems of the sampled image and the page, the equation for the image is supplied to the image operator. The equation is essentially

$$g = 0.5 (1 + 10^{-y} \sin 10^x),$$

where g is the desired gray level (i.e., re-
continued)

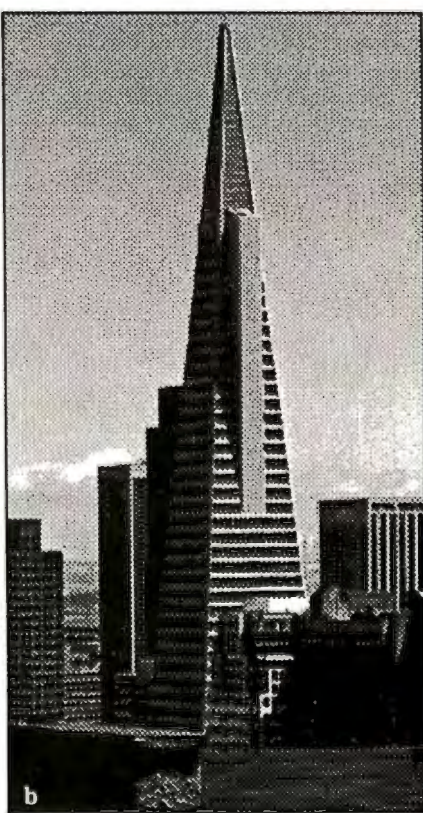

Figure 3: Digitized image of the San Francisco skyline. Program and image file courtesy of Adobe Systems Inc. (Included on the COLOPHON 2 IMAGES disk; see the text box.) 3a: Produced on a Linotype L300 at 2540 dots per inch. 3b: Produced on a LaserWriter Plus at 300 dpi.

All this—and only 15 pounds!

Power for performance:

- IBM PC AT compatible
- 80286 processor, running at 8MHz
- MS-DOS™ 2.11* operating system, BASIC

More storage for more applications:

- 640KB RAM, extendable to 2.6MB
- Built-in 10MB hard disk
- Built-in 720KB 3½" diskette drive

The display with clear advantages:

- High-resolution gas plasma display
- IBM Color Graphics Adapter (CGA) compatible
- 80 x 25 character display
- 640 x 400 bit-mapped graphics display

Interfaces to make connections a snap:

- RGB color monitor port
- Parallel printer port
- RS-232C serial port

Built-in convenience:

- Full-sized 81-key keyboard
- 110/220 VAC switch-selectable power supply
- Only 12.2" W x 3.1" H x 14.2" D

Important extras included:

- SideKick® and SuperKey® software
- Attractive carrying case

"Big" system expansion options:

- Internal 300/1200 bps Hayes®-compatible modem
- Internal 2MB extended memory card
- 15-key numeric keypad
- External 5¼" 360KB diskette drive
- Floppy Link to desktop 5¼" diskette drive
- Expansion chassis with five IBM-compatible slots

The T3100. So powerful—and so portable—it's like being able to take your whole office wherever you work.

*MS-DOS 3.2 operating system available soon.

TOSHIBA

14" x 12" x 10MB x 80286*



AT Power, Toshiba-Style.

Until now, working away from your office meant having to settle for lesser computers—or no computer at all.

Toshiba ends that compromise. The T3100 delivers the power of an IBM® PC AT™ in a lean, 15-pound computer that you can take with you. With a full-sized keyboard and advanced gas plasma display that give you equal comfort and clarity on your desk—or on the road.

Don't let its size fool you.

Though the T3100 is no bigger than many laptop computers, it offers the power of a full-function IBM compatible desktop AT system. You get the speed and ease of a built-in hard

disk, communications and expansion options, and more—including dual-voltage power that lets you plug in and go to work just about anywhere in the world.

*Okay, we exaggerated. It's actually 14.2" x 12.2". But you really get a 10.6MB built-in hard disk.

See the system that has all of the industry experts so excited. Call: **1-800-457-7777** for your nearest Toshiba computer and printer dealer.

In Touch with Tomorrow

TOSHIBA

TOSHIBA AMERICA, INC., Information Systems Division

Trademarks: PC AT—International Business Machines Corporation; MS-DOS—Microsoft Corporation. Registered Trademarks: IBM—International Business Machines Corporation; Hayes—Hayes Microcomputer Products, Inc.; SideKick, SuperKey—Borland International, Inc.



flectance), and x and y specify the position on the page. As x increases, the argument of the sine function, namely 10^x , increases more and more rapidly and the value of $\sin 10^x$ oscillates between -1 and $+1$ more and more rapidly. The program figures out the resolution of the printer and chooses the maximum spatial frequency (and thus the maximum value of x) accordingly. This is because proper representation of a sinusoid requires at least two samples per cycle. If the grating is so fine that fewer than two samples occur in each cycle (a pair of light and dark stripes), there will be a moiré effect, resulting in very broad stripes where there should be fine stripes.

The PostScript printers are not smart enough to take into account the content of your image in their efforts to print the image faithfully at whatever the printer's resolution happens to be. Thus, programmers must watch out for moiré effects. Figure 4a was produced by running listing 3 on a Linotype L300, at 2540 dpi and 127 cells per inch. Figure 4b was produced by running the same program on an Apple LaserWriter Plus at 300 dpi and 18.75 cells per inch. Note that figures 4a and 4b represent different

images because the program explicitly changed the image to best take advantage of each printer's resolution and avoid moiré effects.

This kind of image, a sinusoidal grating swept in frequency and contrast, was first produced by Fergus Campbell and John Robson at Cambridge University in the early sixties (reference 5). John Robson explained to me how they did it. They used two sawtooth oscillators to sweep the beam of an x - y oscilloscope in a vertical raster pattern, so that one vertical line took about 20 milliseconds and a whole frame took about a minute. The sinusoidal grating was produced by a sinusoidal oscillator connected (via a relay and capacitor) to the oscilloscope's intensity-control input.

Campbell and Robson produced the vertical fading in contrast by using a high-speed relay to quickly charge a capacitor to the oscillator voltage at the bottom of each vertical line and letting the capacitor discharge through a resistor as the beam swept upward. The horizontal variation in frequency (fineness of the grating) was produced by manually adjusting the frequency of a sinusoidal os-

continued

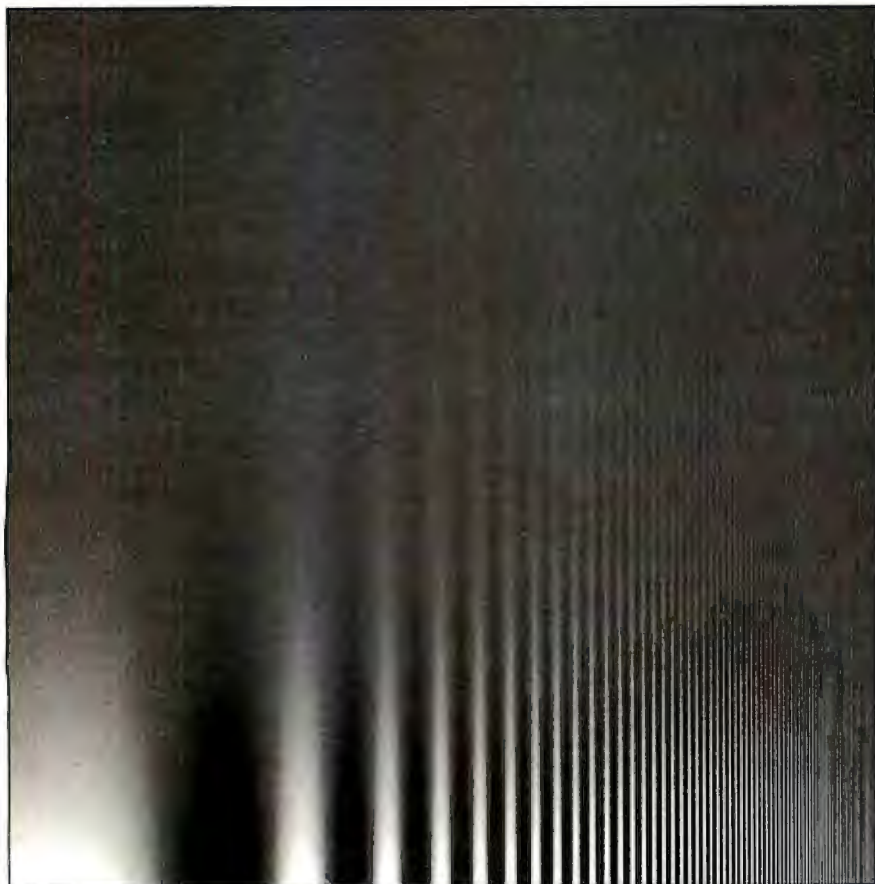

Figure 4a: Sinusoidal grating swept in frequency and contrast. Produced by listing 3 on a Linotype L300 at 2540 dots per inch and 127 cells per inch.

AUTHORIZED DATASPEC DEALERS

ABAX CORPORATION (205) 536-7292 Huntsville, Alabama • **COMPUTERLAND** (907) 561-5191 Anchorage, Alaska • **DATAFIX, INC.** (501) 582-3554 Little Rock, Arkansas • **CHRISMANN CMP. SVC.** (602) 939-8660 Glendale, Arizona • **JAMECO ELECTRONICS** (415) 592-8718 Belmont, California • **ABCC** (818) 846-9700 Burbank, California • **GAAN COMPUTER SUPPLY** (408) 370-6747 Campbell, California • **COMPUTERLANE** (818) 884-8644 Canoga Park, California • **KEYSTROKES UNLIMITED** (714) 980-7663 Cucamonga, California • **CENTAUR** (619) 588-2766 El Cajon, California • **ADVANCED COMPUTER SOLUTIONS** (818) 501-7883 Encino, California • **BOOTS CAMERA CORP.** (209) 432-0446 Fresno, California • **COMPUTERLAND** (818) 246-2453 Glendale, California • **COMPUTER TECHNICIANS** (415) 487-9060 Hayward, California • **HEATH/ZENITH** (213) 749-0261 Los Angeles, California • **PRESTIGE OFFICE PRODUCTS** (213) 484-9995 Los Angeles, California • **HW COMPUTERS** (818) 886-9200 Northridge, California • **COMPUTER** (714) 876-3333 Rancho, California • **SALINAS VALLEY COMPUTERS** (408) 422-1355 Salinas, California • **BYTE AND FLOPPY** (619) 271-0611 San Diego, California • **FOCUS** (619) 277-0112 San Diego, California • **FORCE 4 D.P. SUPPLIES** San Francisco, California (415) 397-1446 Portland, Oregon 503 620-8888 Seattle, Washington (206) 575-2221 Salt Lake City, Utah (801) 973-9111 Schaumburg, Illinois (312) 397-8444 **COMPUTERLAND** (806) 541-4884 San Luis Obispo, California • **COLETTE'S COMPUTERS** (707) 579-1122 Santa Rosa, California • **DATA SYSTEMS WEST** (818) 907-9110 Sherman Oaks, California • **ADRAYS** (818) 908-1500 Van Nuys, California • **NATIONAL COMPUTER** (303) 650-5522 Denver, Colorado • **COMPUTERLAND OF WESTERN COLORADO** (303) 245-2373 Grand Junction, Colorado • **LIPMAN COMPUTERS** (203) 523-4203 Hartford, Connecticut • **NEW ENGLAND COMP. ASSOC.** (203) 429-2035 Storms, Connecticut • **COMPUTER SUPPLY STORE** (515) 288-6688 Des Moines, Iowa • **MITTINGS ELECTRONICS** (219) 563-8774 Wabash, Indiana • **THE COMPUTER STORE** (502) 456-4486 Louisville, Kentucky • **MODERN BUSINESS MACHINES** (504) 885-5961 Metairie, Louisiana • **HARPER ELECTRONICS** (207) 772-1156 Portland, Maine • **ATLANTIC COMPUTERS** (617) 693-3639 Waltham, Massachusetts • **COMPUTER HORIZONS** (313) 464-6502 Livonia, Michigan • **INACOMP COMP. CENTER** (313) 739-2955 Sterling Hts., Michigan • **COMPUTER STATION** (612) 822-0777 Minneapolis, Minnesota • **CORD CABLE** (507) 282-7252 Rochester, Minnesota • **FRON-TRONICS** (417) 623-7170 Joplin, Missouri • **OTTO ELECTRONICS** (609) 448-9165 East Windsor, New Jersey • **SOUND CENTER RADIO SHACK** (505) 672-9824 Los Alamos, New Mexico • **MICRO BUY, INC.** (516) 420-1633 Farmingdale, New York • **SENECA COMPUTER SYSTEMS** (315) 789-0734 Geneva, New York • **UNICORN ELECTRONICS** (607) 798-0260 Johnson City, New York • **FACILITIES MANAGEMENT** (212) 227-2317 New York, New York • **HARBOR RESEARCH CORP.** (716) 473-8963 Rochester, New York • **C. S. BUSINESS SYSTEMS** (716) 634-7528 Williamsville, New York • **PC MART** (704) 568-7470 Charlotte, North Carolina • **COMP. MAINTENANCE CORP.** (919) 722-9064 Winston-Salem, North Carolina • **BORDER COMPUTER SYSTEM** (701) 746-6987 Grand Forks, North Dakota • **COMPUTERLAND CLEVELAND** (216) 621-7262 Cleveland, Ohio • **HEATH/ZENITH COMP.** (216) 292-7553 Cleveland, Ohio • **MAYCOM COMPUTER & SUPPLY** (918) 336-5911 Bartlesville, Oklahoma • **DATA WAREHOUSE** (405) 843-8739 Oklahoma City, Oklahoma • **PACIFIC DATAWARE, INC.** (503) 620-9858 Lake Oswego, Oregon • **GENERAL COMPUTER CENTER** (717) 386-3900 Tamaqua, Pennsylvania • **HI-TECH CABLE CONNECTION** (215) 372-1401 Reading, Pennsylvania • **SOFTWARE CITY** (803) 574-4713 Spartanburg, South Carolina • **EL PASO MICRO MART** (915) 595-1188 El Paso, Texas • **PAIGE COMPUTERS** (713) 833-8385 Houston, Texas • **P.C. ETC.** (214) 226-1163 Mesquite, Texas • **PERMIAN MICRO MART** (915) 367-6778 Odessa, Texas • **DARE SYSTEMS** (801) 377-5591 Provo, Utah • **ORMSBY COMPUTER STORE** (802) 476-6663 Barre, Vermont • **JENTRONIX COMPUTER CABLE** (206) 254-9228 Camas, Washington • **PROGRAMS PLUS** (206) 575-1375 Seattle, Washington • **COMPU-C** (509) 965-4788 Yakima, Washington • **TODAY COMPUTER BUSINESS CENTER** (304) 345-5566 Charleston, West Virginia • **WISCONSIN COMP. SUPPLY** (414) 228-8930 Milwaukee, Wisconsin

The PC1025 control unit is available from additional authorized DATA SPEC dealers not listed above. Contact your local dealer for more information.

FEATURISTIC PROTECTION

The PC1025 by DATA SPEC

With full-featured convenience and sleek contemporary styling, the PC1025 is a new dimension in control protection.

Its slim-line design, color-matched to your PC, fits easily on top of your computer without intruding into your workspace.



The PC1025 combines the complete safety of system and modem surge protection, the easy convenience of five lighted power switches and a Master Switch, with the versatility of a built-in data switch. Added features include a digital clock, LED status lights, and more.



FEATURISTIC protection that gives you more system control and convenience than you thought possible from one source.



DATA SPEC[®]

A DIVISION OF ALLIANCE RESEARCH CORPORATION

20120 Plummer Street • P.O. Box 4029 • Chatsworth, CA 91313

IN JAPAN: DATA SPEC JAPAN LTD. Tokyo Japan.

THE ULTIMATE IN COMPUTER ACCESSORIES

© Copyright 1987 Alliance Research Corporation

CP/M Emulation

Run CP/M software on your IBM-compatible personal computer. We have Z80-HD64180 co-processor cards, V20 or software emulation. At low prices from \$99.95.

New! Z80 At 12.5 MHZ!

We offer the world's fastest Z80 co-processor cards. For \$599.95 our *Blue Thunder Super-speed* crunches through your work. Almost as fast is the 10-MHZ *High Speed* model at \$399.95. The 6-MHZ *Standard* model is \$249.95. Including software.



Blue Thunder \$249.95

RUN ISIS
Very Fast

Plug in one of our co-processors, then run your Intel development tools, on your PC, as much as 20 times faster. Run ASM51, ASM80, CREDIT, etc. \$395.00 and up for a complete package, including serial communications. ISIS diskette translate packages available.

HD64180

Hitachi's new microprocessor has taken the Z80 world by storm. Z80-compatible, but 15% faster for the same clock speed. Counter-timers, serial ports and DMA channels on chip. CMOS. Our customers have reported instances to us where the HD64180 blows away an 80186 at similar clock speeds. This baby moves!

Our \$295.00 D64180LP co-processor comes with our CP/M emulator and real-time programming support. 2-RS232 serial ports and 64K of memory. An excellent basis for a Z80-HD64180 development system. Clock speeds to 9.216 MHZ available.

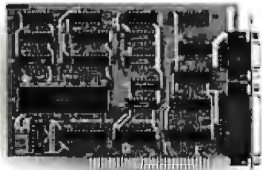

D64180LP \$295.00

For \$445.00 you can get our high powered D64180 real-time co-processor. 256K memory, expandable to 512K. 2 SBX bus connectors which allow you to use hundreds of commercially available interface modules, such as synchronous communications, disk interface, etc.

Software Developers

Let us configure a complete Z80 or HD64180 development system for your PC. Our DSD80 *Remote Debugger* eliminates the need for an ICE. We have VAX and PDP-11 co-processors too.

Z-World
2065 Martin Ave. #110
Santa Clara, CA 95050
(408) 980-1678



In Germany: iSystem Tel: 08131/1687

POSTSCRIPT

Listing 3: *The PostScript program to produce the sinusoidal grating test in figure 4a.*

```
%!
% Produce Figure 4
/inch {72 mul} def
/width 4.54 inch def
50 400 translate
% make square image of desired width
width width scale
/dpi
  72 0 matrix defaultmatrix dtransform dup mul exch dup
  mul add sqrt
  def
/screen dpi 16 div def
screen 127 gt {/screen 127 def} if
screen currentscreen 3 -1 roll pop setscreen
% number of cells across image
/n width screen mul 72 div 2 sqrt mul 0.99 add cvi def
/nx n 2 mul def
/ny n 2 idiv def
/fbase 0.5 n mul 1.0 nx div exp def
/fa 360 nx div fbase ln div def
/c 1 def
/cbase 0.003 1.0 ny div exp def
/S nx string def

nx ny 8 [nx 0 0 ny 0 0]
  {/c c cbase mul def /f fa def
  0 1 nx 1 sub{S exch f sin c mul 1.0 add 126.5 mul cvi
  put /f f fbase mul def}for

S}
image

showpage
```

cillator as the beam swept across the screen.

Campbell read out the desired frequencies from a table, and Robson adjusted the dial. They recorded the image on film by taking a long-exposure photograph.

Working with Text

The third way to produce an image in PostScript is to use text.

PostScript makes it very easy to create characters of arbitrary size and rotation. In fact, the font machinery for producing text is built from the commands for producing paths. Each character is created by its own program. Typically, a program to produce a character creates a path and then fills or strokes it. However, because writing text is such an important use of PostScript, several things were done to make it easy and fast.

First, fonts are stored in special dictionaries inside the printer, with a little program for each character, and special commands are provided for specifying what font you want to use and at what size. Commands are also provided to produce a whole line of text from an

ASCII string, which is just a list of the desired characters. There are even facilities for kerning, or adjusting, the spacing between particular letter pairs, such as "TA," which looks best if the "A" is tucked slightly under the hat of the "T."

Second, it takes a lot of computation to run the programs corresponding to each character in a page of text. To alleviate this burden, whenever PostScript computes a character to paint it onto the page, it also saves a copy of the character's bit map in a special area of memory called the "font cache." If the character is needed again, PostScript retrieves it from the cache instead of computing it again. Naturally, the cached copy can be used only for the same character from the same font at the same size and rotation.

Figure 5 (produced by listing 4) is a simple example of the use of text. This is a test chart to measure visual acuity, much like one you might see in an optometrist's office. The letters are all at high contrast and get smaller and smaller until they disappear. The smallest letter that you can read is a measure of the resolution limit of your eye.

continued

Aztec C ... The Best C

Frees the genius in you

You've got a great idea . . .

. . . you're ready to write your programs.

You don't want to be sidetracked by all the paperwork. With Manx Aztec C and the ingenious **make** function, your creative processes won't get bogged down in program administration and housekeeping. Manx Aztec C has the most sophisticated, hardworking program administrator available to you. Once you've described your project, adding new features or enhancements is simple. You never have to concern yourself with the repetitive, tedious task of rebuilding your systems.

The development process moves quickly. Compiles, assemblies, link edits . . . all finish in record time.

Manx Aztec C is the fastest, most efficient C development system in the industry. Benchmarks show it . . . reviews commend it . . . users praise it.

You're ready to test the program. You're ahead of schedule. The Manx Aztec C Source Level Debugger shows you the exact C language statement giving you a problem. You fix the problem quickly . . . you're still ahead of schedule.

You've got some time for fine tuning. The Manx Aztec C Profiler examines your program, tells you where the slow spots are and validates your test procedure. A few changes and it's exactly what you wanted.

You've made it!

Aztec C is available for MS-DOS/PC DOS. Call for details on Macintosh, Amiga, Apple II, CP/M-80, CP/M-86, TRS-80, ROM and others.

To order, or, for information

Call Today

1-800-221-0440

In NJ or outside the USA call
(201) 542-2121

30-day satisfaction guarantee. Special Discounts are available to professors, students, independent developers, and on a "trade-in" basis. Site licenses.



Manx Software Systems
One Industrial Way
Eatontown, NJ 07724

MS is a registered TM of Microsoft, Inc., CP/M TM DRI, HALO TM Media Cybernetics, PANEL TM Roundhill Computer Systems, Ltd., PHACT TM PHACT Assoc., PRE-C, Plink-86 TM Phoenix, db Vista TM Rains Corp., C-terp, PC-lint, TM Gimpel Software, C-tree TM Faircom, Inc., Windows for C TM Creative Solutions, Apple II, Macintosh TM Apple, Inc., TRS-80 TM Radio Shack, Amiga TM Commodore Int'l.

" . . . a superb linker, a profiler, an assembler, and a set of development utilities are only the beginning of this package . . . performed admirably on the benchmarks, with short compile times and the best link times in this review . . . includes the most professional make utility . . . documentation is clear and complete. There is no doubt that this is a valuable and powerful programming environment." **Computer Languages Feb. '86**

" . . . execution times are very good, close to the best on most tests . . ." **PC Tech Journal Jan. '86**

" Easily one of the fastest compilers overall . . . library provides a lot of flexibility . . . generates small .EXE files." **Dr. Dobbs Journal Aug. '85**

C'Prime (Compiler, Assembler, Linker)	\$ 99.
Aztec C 86-d Developer's System	\$299.
Aztec C 86-c Commercial System	\$499.
PC ROM (8086, 68000, 8080, or 6502)	\$750.

Third Party Software for Aztec C: HALO, PHACT, C-tree, PRE-C, Windows for C, PC-lint, PANEL, Greenleaf, db Vista, C-terp, Plink-86, FirstTime, C Util Lib, and others.

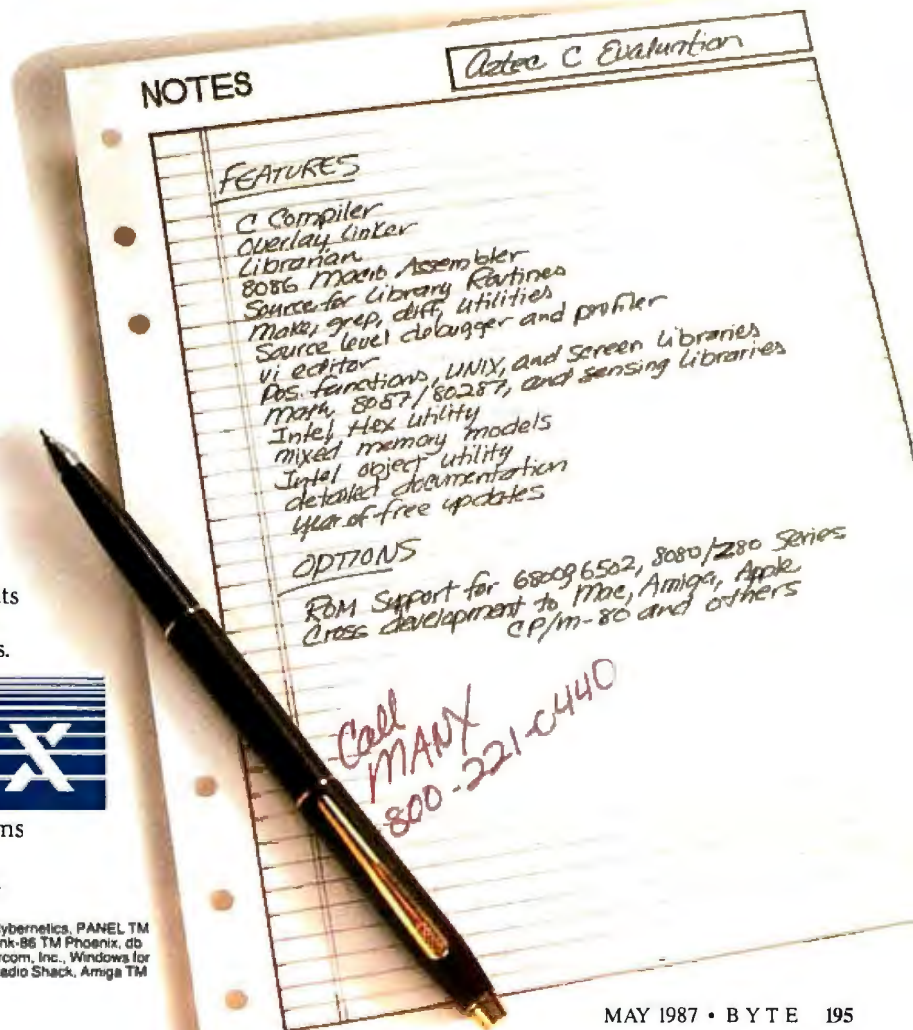

The Better Net

The CompuPro ARCNET® PC Board



Better Compatibility

The CompuPro ARCNET PC is compatible with all versions of Novell Netware and Advanced Netware™, and DR-NET™ running in all types of PC-compatibles. No other board can say that!

Better Reliability

The CompuPro ARCNET PC board offers distinctly more reliability than other boards. Why? Read on.

Better Design

The CompuPro ARCNET PC board uses unique circuit design to increase signal margins. Better interface circuitry insures operation with even the fastest PC-compatibles.

Better Specs

The CompuPro ARCNET PC board meets all FCC requirements!

Better Made

The CompuPro ARCNET PC board is manufactured, tested and burned in right here in the USA. It is not subject to the wide swings in quality often experienced with foreign-manufactured boards.

Better Value

All of this adds up to the fact that the CompuPro ARCNET PC board is the best value in Novell compatible network boards.

Better Call Today

Call us today for the name of your nearest CompuPro dealer. They are prepared to discuss a variety of network and multi-user solutions to meet your requirements.

CompuPro™

Viasyn Corporation
26538 Danti Court
Hayward, CA 94545-3999
(415) 786-0909
TWX: 510-100-3288
Easylink Mailbox 62877579

Trademarks: CompuPro: Viasyn Corporation. ARC-NET: Datapoint Corporation. Netware, Advanced Netware: Novell, Inc. DR-NET: Digital Research Inc.

Figure 6 (produced by listing 5) is a new kind of test chart. The letters are all the same size, but they vary in contrast, fading out until they disappear. The lowest contrast that you can read is a measure of the contrast sensitivity of your eye. The combination of acuity and contrast sensitivity results in a more complete assessment of the visual function of your eye than would acuity alone.

Incidentally, you may note a similarity between figure 4a and figures 5 and 6. In fact, the finest letter that you can read provides a useful estimate of the finest grating that you can resolve (the right edge of the hump in figure 4a), and the lowest contrast letter that you can read provides a useful estimate of your contrast sensitivity for gratings—the height of the hump in figure 4a (reference 6).

Figures 5 and 6 were produced by moving to a new location on the page for each character, setting the gray level, setting the font size, and printing the character by the show command. The programs are given in listings 4 and 5.

Note that figures 5 and 6 were produced with the Sloan font, which you won't have. The programs in listings 4 and 5 explicitly check to see if Sloan is

available; if not, they substitute Helvetica.

Tools for Programming in PostScript

First you'll need the *PostScript Language Reference Manual* and the *PostScript Language Tutorial and Cookbook*, both written by Adobe Systems, the company that invented PostScript and put it in the public domain. These clear, well-organized books are models for how manuals should be written, with a clear separation of the tutorial and reference functions. The tutorial has lots of real examples, and the reference manual is organized alphabetically.

You'll also need a computer with a plain text editor (to write your program) and connection to a PostScript printer. Your computer won't be doing much, just sending your program to the printer and receiving any messages from the printer. It's the printer that interprets and runs your program.

The simplest way to connect any computer to a PostScript printer is by a serial line, using any simple communication program. However, most users do not

continued

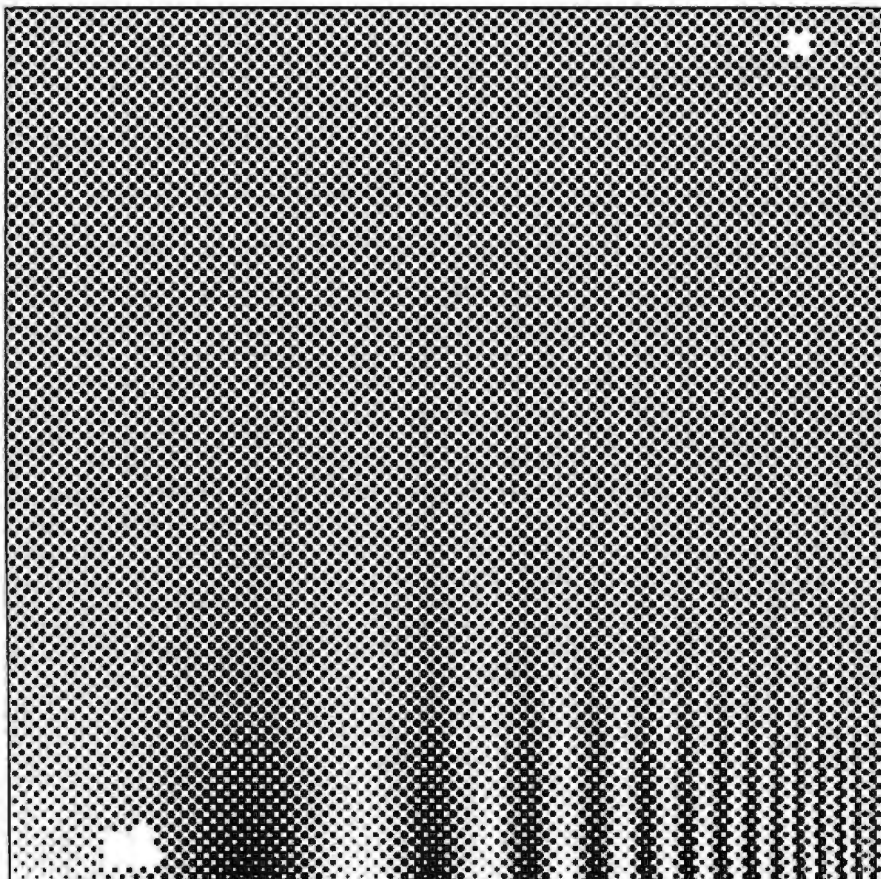

Figure 4b: Sinusoidal grating printed at 18.75 cells per inch on a LaserWriter Plus.

Our Development Tools Generate A Lot of Positive Feedback.

Jeffrey Zurkow, President of Avocet Systems

Microprocessor development tools without the shock of a big price tag.

The AVMAC family of assemblers from Avocet lets you develop microprocessor code on your personal computer or VAX. Avocet has been developing PC software since before there *were* PC's. Our products have been refined over several generations giving you powerful and flexible development tools. They work with your existing operating system and text editor, so they're easy to install and easy to use.

Do all of your development on a single PC or VAX without switching systems.

If your next project calls for a different microprocessor, just call Avocet. There are Avocet assemblers for most common microprocessor families. So modifying your development system is as easy as changing diskettes. Check the chart—the assembler you need is probably there.

Call 1-800-448-8500.

Avocet Systems Inc., 120 Union St.
P.O. Box 490, Rockport, ME 04856

Inquiry 34

With Avocet, you're wired into a family of support products you can trust.

Each assembler package includes the AVLINK linker, AVLIB librarian, AVREF cross-reference generator and other utilities. And Avocet also offers you a host of other tools you need, such as TRICE self-powered in-circuit emulators, AVPROM programmers, text editors and the AVSIM full-screen simulator/debugger. So the PC on your desk can hold a workbench full of development tools.

Try before you buy. And we'll ship in 48 hours or less.

You probably need your tools right away. And that's when you'll get them. When you order from Avocet, we'll also send you a complete demonstration kit for both our assembler and our AVSIM simulator/debugger.

Try the demo for thirty days—if you aren't completely satisfied, we'll refund your purchase price, less \$35.00 for the demo disk. That's yours to keep, which is a good deal by itself! We're sure you'll find Avocet the best connection you've ever made.



Avocet offers an entire line of low-cost microprocessor development tools.

Target Microprocessor Families Supported

1802/1805	68000/68010	COP400
6502/65C02	68020	HD64180
6801/6301	8048/8041	NEC 7500
6804	8051	TMS-32010
6805/6305	8085	TMS-32020
6809	8096	Z8
68HC1	F8/3870	Z80

Host Operating Systems

CP/M DOS VAX Unix VAX VMS

AVMAC Macro

Assemblersfrom \$349

AVSIM Simulator/

Debuggersfrom \$299

Other Development

toolsCall for full catalog

AVOCET

SYSTEMS, INC.

own a PostScript printer. Typically, they share one over a network. This arrangement requires that you use a downloader program to send your PostScript program (a text file) via the network to the printer. A good downloader should also be able to receive, display, and save any messages sent back from the PostScript printer.

Receiving messages from the printer is very important; otherwise, you'll only know when your program crashes by the fact that no paper comes out of the printer. I debugged my first few PostScript programs that way, running to the other room, waiting to see if I got any output—usually I didn't—and walking back to edit my program a bit and trying again. It's reminiscent of using the toggles on a PDP-11/20 to program in machine code—obviously something best left to "real programmers," as no sane person would enjoy such a tedious procedure.

If you can't receive messages from the printer, a less convenient solution is to use Adobe's free "error break page handler," a PostScript program you send to the printer once. From then on (until you reset the printer), when any program crashes you'll get a printed page showing the error message, the offending command, and a peek at what's on the stack. However, this still requires running back and forth between your computer and the printer.

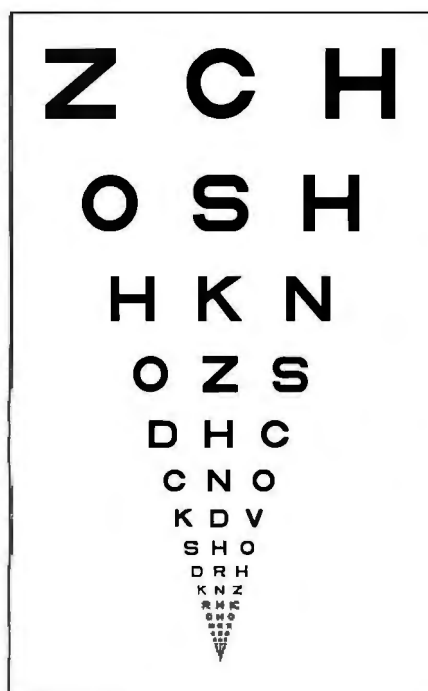

Figure 5: Conventional acuity chart produced by listing 4 on a Linotype L300 at 2540 dots per inch.

Several good downloader programs are now available for the Macintosh. The best one is free. SendPS from Adobe Systems will send your program over AppleTalk to the Apple LaserWriter. It will also receive any messages sent back over AppleTalk from the printer, show them to you as they arrive, and automatically store them in a file for your later perusal. You can also ask for a report on the status of the printer at any time, and you can initiate a remote reset of the printer. SendPS doesn't include a text editor, so you'll need one. (I recommend the shareware desk accessory MockWrite.) PostHaste and JustText have all the features of SendPS (except showing messages as they arrive), plus built-in multiwindow editing, and JustText comes with extra programs that convert MacPaint, Thunderscan, and MacVision files into PostScript.

Cricket Draw, from Cricket Software, lets you edit and download a PostScript program but does not receive messages from the printer. Its main attraction for the PostScript programmer is that it lets you make a MacDraw-like drawing (or read in a MacDraw file) and convert it into pure PostScript. It has a handy PostScript help function that lets you look up a brief explanation of any PostScript operator—moveto, for example.

One feature I'd like to see in future PostScript downloaders is an %include: filename statement that would indicate to the downloader that another file (e.g., containing your favorite subroutines) should be included when the program is downloaded. This is a standard feature of most modern languages, but PostScript lacks it and thus deprives the programmer of many of the main advantages of modular programming. You have to put everything in one file, making nontrivial PostScript source files unreasonably long and making it difficult to keep all your copies of a given subroutine up to date.

At present, much less software is available for PostScript downloading for nonMacintosh computers. Synergetics sells some utilities for programming in PostScript on an Apple IIGS, IIC, or IIE. Several companies offer hardware and software (see table 1) to connect an IBM PC-compatible to an AppleTalk network; some of these products let you receive messages from the printer. Now that IBM has endorsed PostScript for use in its future desktop publishing products, things are bound to improve for IBM PC users.

Many computer companies, such as Digital Equipment Corporation and Sun Microsystems, are bringing out new PostScript printers and providing them

with interfaces to connect to computers from those manufacturers. (A list of PostScript printers appears in the text box on page 188.) Most of the existing and forthcoming printers have 300-dpi resolution, like the Apple LaserWriter.

Linotype makes two high-resolution *continued*



Figure 6: Pelli-Robson Letter Sensitivity Chart produced by listing 5 on a Linotype L300 at 2540 dots per inch. Copyright 1987 by Denis G. Pelli.

We've taken the work out of doing Windows.

Microsoft® Windows is becoming the most popular operating environment for PC systems.

It's not surprising. Windows provides the foundation for an exciting new generation of applications that users are demanding. In addition, Windows handles many of the details involved in a software project allowing you to spend more time enhancing your application. That's why a growing number of corporate and independent software developers are building Windows applications.

The Microsoft Windows Software Development Kit is your key to this extraordinary new environment. It's packed with full reference documentation, libraries, utilities and sample programs. Together with our C Compiler or Macro Assembler, it's a comprehensive package that lets you make the most of your application.

Software with a new view.

Giving your applications the Windows treatment begins with a new look. The rich graphical environment allows you to rethink how you want your program to be presented on screen. It lets you mix text and graphics. You can incorporate multiple fonts in a variety of sizes, faces and styles. And it provides the basic building blocks that make it easy to create drop-down menus, dialog boxes, scroll bars, icons and more.

These features not only simplify your application design, but also provide the familiar interface that makes your software easier to learn and use.

Easing the data shuffle.

Of course, there's more to Windows than just looks. Now, different applications can work together. In concert.

The Windows Clipboard provides support for users to cut and paste information between your applications and others. Or you can use messages to establish "hot links" to transfer data automatically.

Upgrading made easy.

Windows' device independent design allows you to build your application today and take advantage of new technology as it becomes available. When new graphics cards, printers and pointing devices appear they can be used with your software, without modifying your code. Simply by installing the new driver.

Your window of opportunity.

The Microsoft Windows Software Development Kit is your fastest route to better applications. And with it, we also offer DIAL, our on-line technical support service to help you with the tough questions, and development courses that cover everything from using the dialog editor to memory management.

Find out how you can get your Microsoft Windows Software Development Kit. Pick up the phone and call (800) 426-9400. In Washington State and Alaska, call (206) 882-8088. In Canada, call (416) 673-7638. And we'll open the door to Windows.

The Microsoft Windows Software Development Kit includes:

- Dialog editor.
- Icon editor.
- Font editor.
- Resource compiler.
- Linker.
- MAKE (program maintenance utility).
- Symbolic debugger.
- Heap analysis utility.
- Sample programs.
- Windows libraries.
- Programmer's reference.
- Programmer's utility guide.

System requirements:

- 512K memory, DOS 2.0 or higher.
- Two double sided disk drives.*
- Graphics adapter card.

*hard disk recommended

Microsoft® Windows Software Development Kit

The High Performance Software.

Microsoft is a registered trademark of Microsoft Corporation.

Listing 4: *The PostScript program to produce the conventional acuity test chart in figure 5.*

```

%!
% Produce Figure 5
50 750 moveto
/width 250 def
/size width 6 div def
/cuberoot2 2 1 3 div exp def
width 2 div size -1.5 mul rmoveto

/showrow
{gsave
FontDirectory /Sloan known
{/Sloan findfont size scalefont setfont}
{/Helvetica findfont size 1.8 mul scalefont setfont}
ifelse
dup stringwidth pop -2 div 0 rmoveto
show
grestore
/size size cuberoot2 div def
0 size -2 mul rmoveto
} def

(Z C H) showrow (O S H) showrow
(H K N) showrow (O Z S) showrow
(D H C) showrow (C N O) showrow
(K D V) showrow (S H O) showrow
(D R H) showrow (K N Z) showrow
(R H K) showrow (C H O) showrow
(N K S) showrow (C Z R) showrow
(S O K) showrow (D N C) showrow
(C H D) showrow (R O H) showrow
(S N D) showrow (O C H) showrow
(Z H K) showrow (C V H) showrow
(V N Z) showrow (S C K) showrow
(N D C) showrow (C N D) showrow
(O V N) showrow (Z H V) showrow
(H S K) showrow (D N O) showrow
(N S K) showrow (D C Z) showrow
(V H K) showrow (S K V) showrow
(V R K) showrow (V R S) showrow
(K Z N) showrow

showpage

```

PostScript-compatible printers, the L100 (\$35,000) with a maximum resolution of 1270 dpi, and the L300 (\$60,000) with a maximum resolution of 2540 dpi. Linotype calls them its Series 100 printers. Oddly enough, the resolution of these computerized printers must be set manually, to 615, 1270, or (on the L300) 2540 dpi.

The 300-dpi LaserWriter is fine for drafts, and the 2540-dpi L300 will produce excellent final prints on either Kodak RC (resin-coated) paper or film. (3M has just announced a polyester plate called onyx that can be exposed on the Linotype L100 or L300 and used as a plate on small duplicator presses to print up to 25,000 copies.)

My experience is that the L100 is useless for halftoning because any gray areas that you print will have dark streaks every inch or so down the page. Appar-

ently, this is a result of the many stops and starts during printing and of the L100's poor paper handling when compared with the L300. (The dark streaks seem to be due to enlarged dots. It's only a problem for halftones and bit maps. Solid black and white areas, even fine text, are not noticeably affected.) Prices for using the L100 and L300 are similar, about \$10 per page, so use the L300.

Table 1 lists the print shops I know of that will run PostScript jobs on Linotype L300 printers. All will accept job submissions by modem or on a Macintosh disk. They typically charge \$10 per page (plus postage) and try for, but do not promise, one-day turnaround. I always ask to have my printout sent by express mail. (I've only used MacTypeNet, and I'm happy with its service, though it doesn't always achieve one-day turnaround.)

Some Linotype print shops will charge extra or refuse to run jobs that take many hours. For example, figure 4a took seven hours on an L300, and I was told, "Never again!" However, the Adobe books give no information about timing. Some of my jobs take only slightly longer to run on the Linotype than on the LaserWriter; others take much longer.

I find that I can get an upper bound on Linotype run time by measuring how long the job takes on the LaserWriter and multiplying by the factor by which the number of pixels will be increased. For instance, if the job takes 1 minute at 300 dpi on the LaserWriter, it might take up to $(2540/300)^2 = 72$ times as long (i.e., 72 minutes) at 2540 dpi on the L300. This is because the LaserWriter (and the LaserWriter Plus) and the Linotype L100 and L300 all use the Motorola 68000 microprocessor.

However, I've just learned that Linotype plans to upgrade the ROMs in all the Linotype L100 and L300 printers to PostScript version 42.5 soon. Apparently, this upgrade speeds up printing a lot, ranging from a factor of 1.5 times faster for printing noncached fonts to a factor of nearly 20 for bit-mapped images.

An odd deficiency of PostScript, given that it is a device-independent page-description language, is that it lacks any general device-independent way to describe the size of the page. To obtain nonstandard page sizes on the Linotype printers (up to 11.7 inches by 25.7 inches at 1270 dpi, less at 2540 dpi), you need to use a special operator, `setpageparams`, which is documented in a supplementary manual for the Linotype printers (see the text box on page 188).

PostScript Displays

Sun Microsystems recently announced a machine-independent standard for windows, called NeWS (Network/extensible Window System), which is based on building a PostScript interpreter into each window. What is to be displayed in a window is transmitted to the window as a PostScript program. NeWS is good for networking because you can easily load into the window a PostScript program that will interpret other window protocols, such as MIT's X windowing protocol, thus making NeWS highly compatible. NeWS will be a boon to PostScript programmers because it will let them try out their programs quickly on any display supporting NeWS, without waiting for a printer.

Debugging

The error messages from PostScript are quite specific and helpful, particularly

continued

Get the Courier HST™ 9600-bps modem. Then watch the rest of the world play catch-up.



USRobotics new high speed technology delivers over 1,000 characters/second on more dial-up phone lines. For less than \$1,000.

The new Courier HST (High Speed Technology) dial-up modem combines four great ideas that add up to a new standard for personal computer data communications.

It's full-duplex, with high speed (9600-bps) and low speed (300-bps) channels—automatically assigning the high speed channel direction. This asymmetrical solution avoids the problems of echo-cancelling technology or inefficient half-duplex schemes.

The most powerful data signalling technique—Trellis Encoded Modulation—lets Courier HST achieve maximum speed over a much wider range of phone line conditions than other 9600-bps modems.

A unique error- and flow-control method allows Courier HST to send up to 1,100 characters a second over long distance phone connections.

It's familiar as any 2400- and 1200-bps modem. Same features, commands and, in most cases, the same software. In fact, Courier HST automatically falls back to 2400, 1200 and 300-bps, connecting you with nearly all modems.

High speed. High accuracy. High value. And a two-year parts and service warranty. Get the USRobotics Courier HST, priced under \$1,000. And watch the rest of the world play catch-up.

**CALL 1-800-DIAL-USR
In Illinois (312) 982-5001**

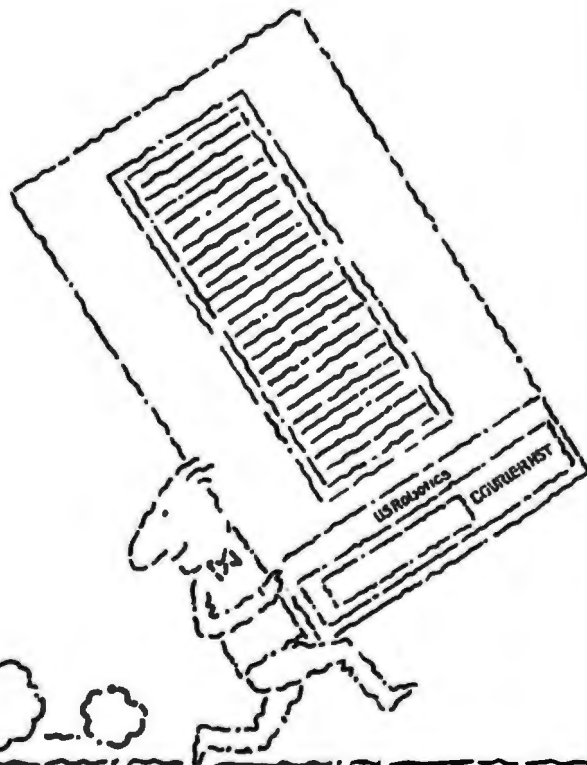

Yes, please send me your FREE 8-page book explaining the new Courier HST and today's new high speed technology.

Name _____

Title _____

Company _____

Address _____

City _____ State _____ Zip _____

Business Phone () _____

6/87-BY-2400F

USRobotics™

The Intelligent Choice in Data Communications.
8100 McCormick Blvd., Skokie, Illinois 60076.

Listing 5: The PostScript program to produce the Pelli-Robson Letter Sensitivity test chart in figure 6.

```

%!
% Produce Figure 6
50 750 moveto
/width 250 def
/size width 6 div def
width 2 div size -1.5 mul rmoveto
FontDirectory /Sloan known
  {/Sloan findfont size scalefont setfont}
  {/Helvetica findfont size 1.8 mul scalefont setfont}
  ifelse
/dpi
  72 0 matrix defaultmatrix dtransform dup mul exch dup
  mul add sqrt
  def
/screen dpi 16 div def
screen 127 gt {/screen 127 def} if
screen currentscreen 3 -1 roll pop setscreen
/c 1 def

/setcontrast {1 sub neg setgray} def

/showrow
  {gsave
  dup stringwidth pop -2 div 0 rmoveto
  c setcontrast
  show
  grestore
  /c c 2 div def
  0 size -2 mul rmoveto
  } def

(N C R) showrow (C H V) showrow
(Z R H) showrow (S H N) showrow
(V D K) showrow (N K Z) showrow
(S Z O) showrow (R D N) showrow
(R Z S) showrow (Z R N) showrow

showpage
    
```

Table 1: Print shops that output PostScript jobs on Linotype L300 printers.

Company	Location	Telephone
Ampersand Typographers	Toronto, Canada	(416) 422-1444
Cobb Typesetting	Cincinnati, OH	(513) 241-1146
Design Nor h Inc.	Racine, WI	(414) 762-1320
Desktop Publishing Inc.	San Rafael, CA	(415) 258-0767
MacTypeNet	Livonia, MI	(313) 477-2733
National Colorite Corp.	New Berlin, WI	(414) 784-8980
ProTypography	Chicago, IL	(312) 266-8973
Typesetting Services Corp.	Providence, RI	(401) 421-2264

because all the PostScript operators do extensive type and range checking of their arguments and give out a specific error message if they don't like them.

PostScript has several "print" commands that are helpful in debugging. They do not put ink on paper—instead, they send a message back to the host. (To put ink on paper, you say `showpage`.) One especially useful print command is `==`, which will print whatever is on the

top of the stack. What's great about that is that anything can be put on the stack, even a compiled procedure, and `==` will uncompile it and print it out for you. It took me a while to realize just how useful printing is, since the Adobe books don't say much about debugging.

Incidentally, there are bugs in the PostScript interpreters (version 38.0) resident in the PostScript printers. For example, I discovered that stroking very

large arcs can get a PostScript printer so confused that all subsequent jobs fail with a limit-check frame device error until you reset the printer. Adobe has acknowledged the bug and promises to fix it in a future release of the PostScript interpreter. The PostScript operator `version` returns a string with the version number of the interpreter.

Wrapping Up

You might find four periodicals interesting. Don Lancaster's "Ask the Guru" column in *Computer Shopper* has clever ideas for nonobvious uses of PostScript and the LaserWriter. *Colophon* and *Graphic Perspective*, glossy newsletters illustrated with fancy PostScript illustrations, often include program listings. Finally, the *PostScript Language Journal* will publish its first issue about the time you are reading this.

PostScript isn't really meant for programming, but it is very handy as a programming language to create images from mathematical descriptions. It offers various ways of describing your image, a high degree of machine independence, the possibility of debugging on moderately priced, widely available printers, and final printing at 2540 dpi for \$10 a page. PostScript makes it easy to produce images on paper that would be difficult or impossible to produce otherwise. ■

REFERENCES

1. NAS-NRC Committee on Vision (1980) Recommended Standard Procedures for the Clinical Measurement and Specification of Visual Acuity. *Advances in Ophthalmology*, volume 41, pages 103-148.
2. Howland, B., A. Ginsburg, and F. W. Campbell. "High-Pass Spatial Frequency Letters As Clinical Optotypes." *Vision Research*, 1978, volume 18, pages 1063-1066.
3. Dobson, V., and D. Y. Teller. "Visual Acuity in Human Infants: A Review and Comparison of Behavioral and Electrophysiological Studies." *Vision Research*, 1978, volume 18, pages 1469-1484.
4. Harris, S. J., R. M. Hansen, and A. B. Fulton. "Assessment of Acuity in Human Infants Using Face and Grating Stimuli." *Investigative Ophthalmology & Visual Science*, 1984, volume 25, pages 782-786.
5. Ratliff, F. *Mach Bands: Quantitative Studies on Neural Networks in the Retina*. San Francisco: Holden-Day Inc., 1965, page 156.
6. Pelli, D.G., G.S. Ruben, and G.E. Legge. "Predicting the Contrast Sensitivity of Low-Vision Observers." *Journal of the Optical Society of America*, volume A3, page P56.



Terms: We accept cash, check, Money Orders, Visa, MasterCard. 3% extra on American Express, wire transfers, qualified P.O.'s and C.O.D.'s. All equipment carries a new factory warranty. Prices are subject

to change. Any return item must be accompanied by a return authorization number and description. IBM, Compaq, Seagate, NEC, Toshiba, and Sony are registered trademarks of their respective companies.

Product Blitzes

Hardware

Computers

IBM

XT 256K 1 DR *\$1072
AT 256K 1 DR *\$2475

Multitech

1100 *****\$3399
Intel 80386, 16MHz;
40 MB up to 2MB Ram
Accel 900 ****\$1495

IBM AT Comp. Computer

The Accel 900 comes with Intel 80286 chip operating at 10 MHz, eight expansion slots, HardDisk Drive/Floppy Disk adapter, 512K RAM, expandable to 1MB, one 1.2 floppy, and MS DOS 3.2. The system works with Concurrent Dos, Xenix, and Unix. Hard disk drives, additional floppies, and expansion cards available. It comes with a one year warranty from TRW to give you dedicated service and support at an economical price.

Compaq

Deskpro 386
40 MB, 16MHz *\$4900
70 MB, 16MHz *\$5700
130MB, 16MHz *\$7475

The ultimate in performance for anyone who needs exceptional power and speed.

Portable 256K *\$1644

Portable II

2DR 256K *****\$2640

Portable III

Model 20 ****\$3850

640K 20MB

Model 40 ****\$4950

640K 40 MB

It features 12MHz, 80286, Two 5 1/2" 1.2 dr., 18 lbs., expandable to 6.6 MB. Full size 640 x 400 Display. Optional internal modem.

PCAM

8 MHz Turbo System

IBM XT Compatible Computer

20MB, 8MHz ****\$895

30MB, 8MHz ****\$955

Two floppies ****\$555

The PCAM Computer can give you performance, expandability, compatibility, durability and versatility at an economical price. It comes with 640K, eight expansion slots, 150 watt power supply, the ERSO BIOS ROM and AT style keyboard. To insure you get the support you need PC American offers you a one year limited warranty and a 10 day Money Back Guarantee.

Floppy Drives

TEAC

55BV 360K *****\$99

1.2 MB *****\$129

Toshiba

ND040 360K ****\$99

3.5" 720K *****\$129

Fujitsu 360K**\$79

Laptop Computer

NEC

Multispeed **\$1539

Multispeed is smaller, lighter and twice as fast as the other leading portable. Only 11.2 pounds, with a Super Twist LCD. What's more it has a separate numeric keypad so it is easier to use.

Toshiba

T 1100+ *****\$1555

Now has the Super Twist screen. The clock speed switches between 7.36/4.77 MHz, two 720K floppies, parallel, serial, and RGB ports.

T 3100 *****\$2990

One 720K Drive with 10MB Hard drive. Only 17lbs., take it with you anywhere.

External 5 1/4"***\$399

Hard Disk Drives

Seagate

20MB ST225 KIT \$368

30MB ST238 KIT \$459

40MB ST251 KIT \$669

30MB ST4038 **\$569

40MB ST4051 **\$669

80MB ST4096 **\$1049

+ Software

Tape Backup

Archive

20 MB Internal **\$456

60 MB Internal **\$695

60 MB External **\$695

Everex

Excel 20MB INT **\$629

Excel 60MB INT **\$789

Excel 60MB EXT **\$875

Automatic Back up, File by File retrieval, Mirror Image.

Graphics Board Monochrome

Hercules

Graphics + ***\$194

Clone

Mono Graphics \$89

Mono/Color

Graphics Board

Everex Edge * \$239

STB

Chauffer HT **\$199

Monochrome Monitor

Samsung

SM12SSA TTL * \$79

Multitech

14" Reversible, BK/W \$149

Princeton

MAX 12 *****\$154

Amdek

310A Amber TTL \$149

410W 132 Col * \$165

1280 1280 x 800 15" * \$778

EGA Graphics Card

Quadram

Prosync *****\$329

(CGA, EGA, Auto Switch)

NEC

GB-1 *****\$359

Multisync Graphics, 640x840 132 Col., Hercules/CGA/EGA 16 Colors

Paradise

Auto EGA 480 \$394

STB

EGA + CGA/EGA \$299

Video 7

Vega Deluxe * \$333

Auto switchable

Tseng

EVA 480 *****\$379

Color Monitor

CTX

14" RGB *****\$269

640 x 200 (same as Multitech)

Princeton

PL 14" *****\$478

770 x 400, .26 dot pitch

Multitech

Color 14" *****\$329

640 x 200 + Switch

EGA Monitor

NEC Multisync \$559

Autoswitchable, 800 x 560, Wonderful display quality, Dot pitch .31

Sony Multisync \$599

Autoswitchable, 800x560, Dot Pitch .26

Mitsubishi

Diamond Scan \$569

JVC

GD-H3214 ****\$569

Thompson

Ultra Scan ****\$688

Monochrome, Hercules, CGA, PG, 800 x 500 pixels, 45 to 75 Hertz.

Plotter

Hewlett Packard

7475A *****\$1599

7550 *****\$3329

Houston

Instruments

DMP 40 *****\$889

DMP 42 *****\$2539

DMP 52 *****\$3847

Full Screen Monitor

Micro Computer

Genius 402 * \$1295

8 1/2" x 11", 736x1008 Pixels

Princeton

LM300 *****\$1049

Portrait Display, 8 1/2" x 11", 1200 x 1664 pixels

WYSE

700 *****\$769

Printer

Dot Matrix

Diconix

150P Ink Jet ****\$339

NEC 24 WIRE

P9XL *****\$1265

132 Col. 400/330/140 CPS

P7 *****\$651

136 Col/216/180/85 CPS Color

P8 *****\$461

80 Col. 216/180/65 CPS, Color

Citizen

120D *****\$190

80 col/120 CPS

Toshiba 24 WIRE

P321 *****\$434

80 col/216/72 CPS

P341 *****\$699

132 col/216/72CPS

351C Model 2 \$1224

132 col/300/100/132 CPS

P351 *****\$949

132 col/300/250/100CPS

Panasonic

1080I 120CPS **\$217

1091I 160CPS **\$281

1592 180/38CPS **\$439

1092I 240CPS **\$355

Epson

FX 86E *****\$429

FX 286E *****\$624

EX 800 *****\$499

EX 1000 *****\$699

Printer—Laser

Hewlett Packard

Laser Jet

Series II *****\$1990

Gives you 8 Pages per min.

Toshiba

Page Laser II \$2797

12 Pages per minute. Six times the product life of Competition.

Kyocera

F1010 **** * \$3191

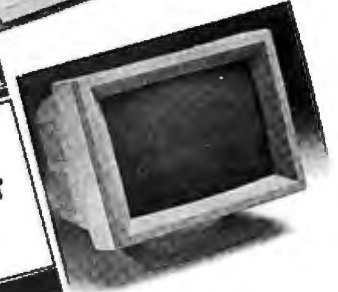
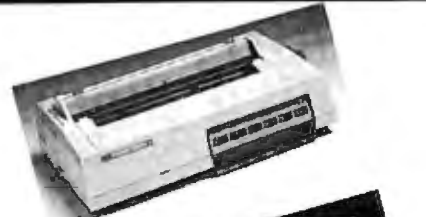

Tall Tree

J Laser+ PC **\$392

J Laser+ AT **\$479

Printer Buffer

Quadram

Microfazer VI \$749

256K exp. to 1MB

Memory Expansion

Multifunction

PISIC/IG/OK *****\$89

AST

Sixpac

Premium *****\$308

Sixpac+ (384K) \$227

Rampage PC * \$234

256K + Deskview

Rampage AT **\$445

512K + Deskview

Everex

2 MB EMS *** \$129

Scanner

Princeton

LS-300 *****\$1046

Desktop Image Scanner with OCR Software. LS-300 Allows you to go from paper to PC with text, graphics and photos.

Software. LS-300 Allows you to go from paper to PC with text, graphics and photos.

Modem

US Robotics

Direct 2400 Int.\$179

Courier HST

9600 Baud ****\$699

Direct 1200 Int.\$109

1200 External**\$115

Courier 2400

External *****\$369

US Robotics provides the most advanced data communications devices in the world. The modems are Auto Answer/Auto Dial and Hayes compatible.

Software. LS-300 Allows you to go from paper to PC with text, graphics and photos.

Software. LS-300 Allows you to go from paper to PC with text, graphics and photos.

Software. LS-300 Allows you to go from paper to PC with text, graphics and photos.

Software. LS-300 Allows you to go from paper to PC with text, graphics and photos.

Software. LS-300 Allows you to go from paper to PC with text, graphics and photos.

Software. LS-300 Allows you to go from paper to PC with text, graphics and photos.

Software. LS-300 Allows you to go from paper to PC with text, graphics and photos.

Software. LS-300 Allows you to go from paper to PC with text, graphics and photos.

Software. LS-300 Allows you to go from paper to PC with text, graphics and photos.

Software. LS-300 Allows you to go from paper to PC with text, graphics and photos.

Input Devices

Logic Mouse C7 \$85

Mouse Systems

PCMouse *****\$126

Bus + PC Paint

CH Products

Mach III Joystick \$35

Mach IV Joystick \$40

Power Supply

150 Watt *****\$79

Data Shield

300 WT (XT) * \$349

500 WT (AT) * \$549

Software

Business Software

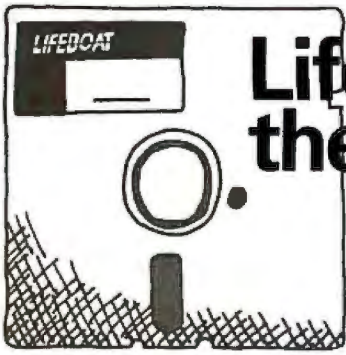

Lifeboat. Your best source for the best names in software.

ADVANTAGE C++

This new object-oriented language lets you develop large and complex programs with greater resilience, fewer bugs. Write reliable, reusable code that is easier to understand and maintain. Fully compatible with existing C programs and tools. All the benefits of C without its limitations. Available for Lattice and Microsoft C compilers; MS-DOS and XENIX operating systems.



Lattice C Compiler

The latest update of the ideal tool for developing high-performance MS-DOS applications in C. Full implementation of K&R C with UNIX and ANSI extensions. Offers the widest selection of C support tools. Now with Microsoft Windows support.



Lattice

Microsoft FORTRAN

New version produces smallest, fastest PC code. Uses the same optimizer and code generator from the Microsoft C compiler. Full ANSI FORTRAN 77 compatibility. GSA-certified to be error-free at the highest level. Includes advanced intrinsic math functions, Microsoft's CodeView debugger, a MAKE utility, linker, library manager and many other enhancements.

Microsoft

Pascal-2

Have you reached the limits of Turbo? Upgrade to Pascal-2 without loss. Easy migration path from Turbo with compatible strings, equivalent procedures and access to Turbo graphics. Cut execution time by 200% over Turbo. Use all of DOS-accessible memory through efficient, large memory model. Speed development time with sophisticated error checking and reporting. Call Microsoft languages. Plus interactive source-level debugger, error walkback, Intel CEL87 math library, high-level profiler.

OREGON SOFTWARE

ADVANTAGE Link

The fastest, most powerful PC-DOS linker available, and the first to take full advantage of EMS. Accepts Microsoft and Phoenix command files, and is compatible with Microsoft CodeView.



VEDIT PLUS

For years, thousands of programmers have depended on VEDIT. If you take your editing seriously, take a good look at the all-new VEDIT PLUS. Open windows to simultaneously edit several files. Access editing functions with pop-up menus. Use keystroke macros to speed editing. And run other programs within VEDIT PLUS—all with uncompromising speed, flexibility and power. VEDIT PLUS is completely customizable and available for MS/PC-DOS, CP/M 80/86. Ask for your FREE demo/tutorial disk.

CompuView

Greenleaf Data Windows

A new concept C library containing overlaid logical windows, transaction data entry and three kinds of menu systems. Features virtual windows, many data types, device independence, total screen management and more. Simple to use, yet highly sophisticated. Supports all major compilers, all models, auto installation. Over 125 functions, no royalties, source available.



PANEL Plus

Advanced screen manager with a screen designer, code generator and function libraries. Works with popular graphics libraries to allow data entry in graphics modes. Includes full, portable library source code.



HALO

HALO, since 1981, the industry standard library of graphic sub-routines. HALO has the largest installed base of end-users and more ISV's than any PC graphics software environment. Why? Because HALO grows with the industry. Constantly improved, HALO now supports 16 programming languages and over 125 devices. Media Cybernetics offers HALO programmers professional support, practical licensing and the continuing commitment to assure that HALO will always be one of the most effective graphic toolkits available. media cybernetics, inc.

TimeSlicer

A library of C functions to create multitasking and real-time programs at the application level rather than interfacing with the operating system. Create, suspend or terminate tasks at run-time. Compatible with Lattice C, Microsoft C, ADVANTAGE C++ and object-oriented programming.



We make the best software even better.

After 10 years of publishing software, we know what's important to you. Our expert staff can help you choose the right programs and provide full technical support. Count on Lifeboat for the complete solution to all your programming needs.

The names of the products listed are generally the trademarks of the sources of the products.

Call **1-800-847-7078**

In NY **914-332-1875**

or see your local Lifeboat Affiliated Dealer

The Full-Service Source for Programming Software

LIFEBOAT

55 South Broadway
Tarrytown, NY 10591
Telex # 510-610-7602

INTERNATIONAL SALES OFFICES

Australia/New Zealand: Charlton Distributors
Phone: (64) (09) 766-361
Canada: Scantel Systems
Phone: (416) 449-9252

England: Grey Matter, Ltd.
Phone: (44) 384-53499
System Science, Ltd.
Phone: (44) (01) 248-0962
France: Compusol
Phone: (45) 30.07.37

Italy: Lifeboat Associates Italia
Phone: (02) 464601
Japan: Lifeboat, Inc.
Phone: (03) 293-4711
Spain: Micronet, S.A.
Phone: (34) 1-262-3304

The Netherlands: SCOS Automation BV
Phone: (31) 20-10 69 22
West Germany: MEMA Computer GmbH
Phone: (69) 34-7226
Omnitex
Phone: (76) 23-61820

Reviews

Reviewer's Notebook	207
<i>by Cathryn Baskin</i>	
High-Speed Internal Modems	209
<i>by Stephen Satchell</i>	
Compaq's New Carryon	221
<i>by John Unger</i>	
The Commodore 64C	229
<i>by Alastair J. W. Mayer</i>	
SCSI Hard Disk Drives for the Macintosh	237
<i>by Chris Crawford and Eva White</i>	
BASIC Compilers for the Macintosh ...	241
<i>by Scott L. Norman</i>	
Q&A 2.0	249
<i>by Phillip Robinson</i>	
Lyrix	251
<i>by George R. Allen</i>	
Review Feedback	254

Special BIX supplement: The following bonus reviews appear in the may87.supp BIX conference: "Removable-Cartridge Drives" by Alexis Lane, an evaluation of removable-media drives for the IBM PC and compatibles; "OPSS+" by Leonard Moskowitz, a review of this production-system language for the IBM PC, XT, AT, and compatibles; and "The Cauzin Softstrip System" by Gregg Williams, an evaluation of a device that hooks up to an Apple II, IBM PC, or Macintosh and reads high-density paper data strips. (For information on joining BIX, see page 256.)

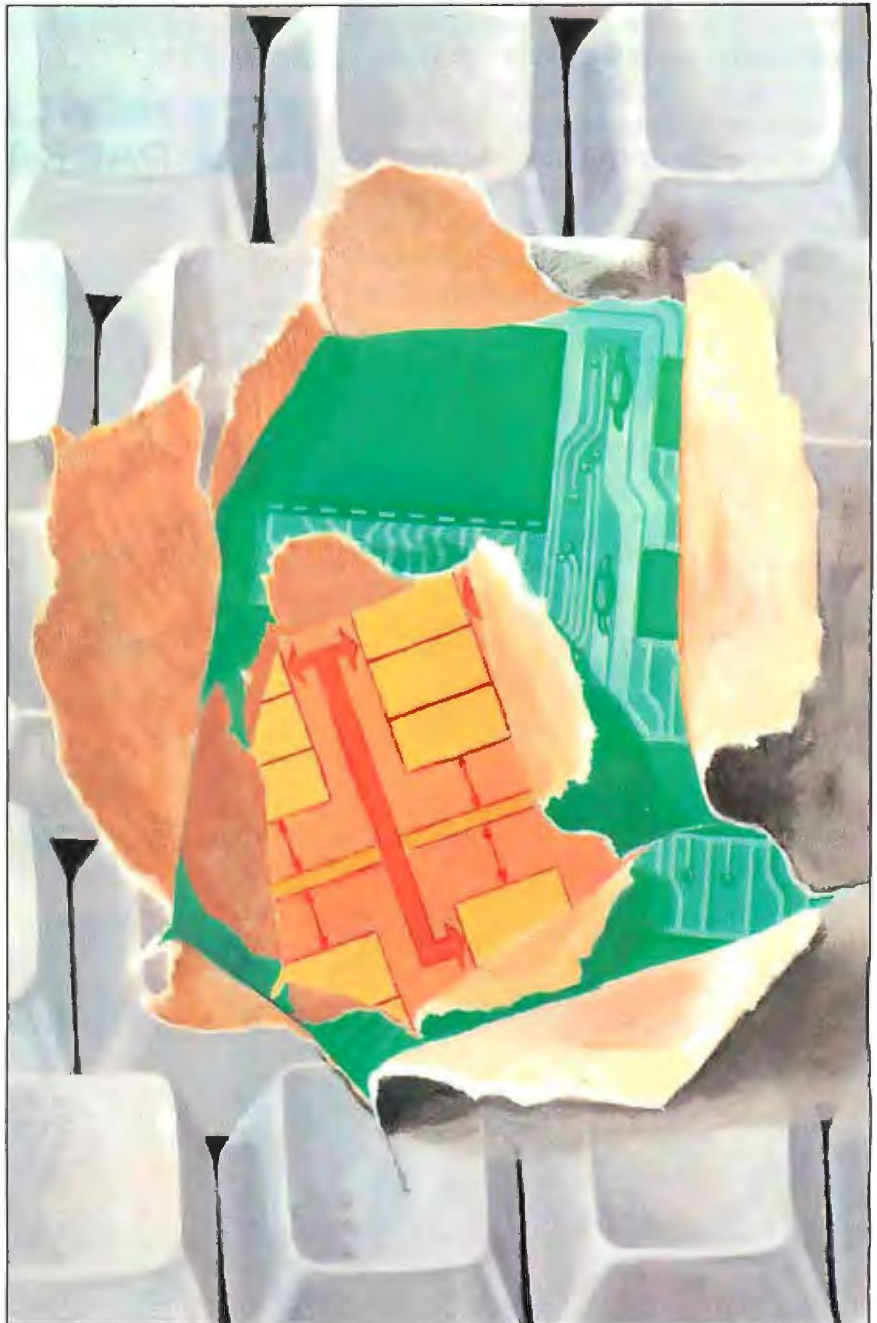

What can you expect from the new LaserJet Series II Printer?

Everything.

Because the LaserJet Series II

Printer from Hewlett-Packard is the product of experience.

It's a second generation printer from the company with the world's largest installed base of laser printers.

Whatever your company's needs, the LaserJet Series II will deliver the performance you expect, at up to 8 pages/minute.

Take a simple memo like the Soup letter we created with Microsoft Word. As you can see, you can print in a variety of formats and type styles with our wide selection of LaserJet fonts.

Or you can create a sophisticated combination of text and graphics. With additional plug-in memory, you can also produce full-page 300 dpi graphics, like

our Nuts form shown below. To do this, we used HP's new ScanJet desktop scanner, Microsoft Windows and Pagemaker® from Aldus.

With support by more than 500 of the most popular software packages, the LaserJet Series II Printer can produce whatever type of business document you need. And LaserJet Series II works with all popular PCs.

In fact, only the price is unexpected — starting as low as \$2495.*

For the authorized dealer nearest you, call us at 1 800 367-4772, Ext. 900A.



**HEWLETT
PACKARD**

Business Computing Systems

Microsoft is a registered trademark of MicroSoft Corp. Pagemaker is a U.S. registered trademark of Aldus Corporation.

*Suggested U.S. list price. © 1987 Hewlett-Packard Co PE12701

Inquiry 143



Mr. J. C. Ryan, President
Flossmoor Soup Company
Flossmoor, Illinois 60422

August 1, 1987

Dear Mr. Ryan:

In an effort to help you stay competitive, we are publishing 5-year sales projections for two soup categories: canned and dry. Please keep these projections handy as they will aid you in your product planning over the coming years. Of special interest to you are the dry soup projections.

	CANNED	DRY
1987	\$6,700,000	\$1,100,000
1988	\$7,300,000	\$2,100,000
1989	\$8,400,000	\$2,600,000
1990	\$9,300,000	\$4,800,000
1991	\$9,900,000	\$7,300,000

As you can see, industry experts project that the gap between dry and canned soups will begin to close by 1990. They also believe mergers will follow.

Noodle Price Hike

Bad news this month comes from TNG (The Noodle Group). By year's end they project the price of noodles to double — up to eighteen cents a barrel. How will this price hike affect you? A two-cent per can increase on all noodle soups you sell.

Recommended Reading: "Cup or Bowl"

This in-depth study discusses the habits of the American soup eater. Call and I'll send you a copy.

Sincerely,

Robert Welke
Mr. R. Welke
Director, Canned Soup Council

NUTS

Deluxe Assortment

Spring 1987



Peanut

A tasty, unique assortment from plantations in Africa and Southeast Asia. And, yes, from Georgia too!

Brazil Nut

Exclusively from South America, these Brazils are fat, hard-shelled and delicious. They'll be much in demand.



Hazelnut

Cakes, cookies, ice cream, chocolate, salads. They'll never taste better than with this delicious French variety.

Almond

They're popular and they're versatile. Available whole, sliced or chopped, they're usually at home in Mom's favorite recipes.



Pecan

Another great favorite in the bakery. And our own superb pecans will satisfy even the most discriminating Southern taster.



Walnut

Stand English Walnuts are just one of the many varieties available, in the best nutcracking tradition.



Pistachio

With an unusually subtle and delicate flavor, these perennial favorites will be perfect for either sweet or savory dishes.



Chestnut

Superior varieties from our own plantations in Italy and France. All the best for more than seasonal consumption.

REVIEWER'S NOTEBOOK

Last month's review of more than 50 dot-matrix printers included results of benchmark tests for all but a few models, which we were unable to test in time for the review. BYTE technical editor George Stewart has completed the tests on two of these printers: NEC Information Systems' Pinwriter P5XL, a 24-wire printer that sells for \$1674, and Newbury Data's OSP-3, an 18-wire model that costs \$1560. Throughput for the Pinwriter P5XL came in at 137 characters per second in draft mode, 58 cps in near-letter-quality mode, and 598 cps in graphics mode. Corresponding measurements for the OSP-3 are 136, 86, and 338 cps. Sound levels in draft, NLQ, and graphics modes were measured at 69, 73, and 75 decibels for the Pinwriter P5XL, and 71, 72, and 84 dB for the OSP-3. Finally, on a scale of 1 to 5 (5 being the best and 1 being the worst), BYTE editors rated print quality for the Pinwriter P5XL at 3, 4, and 3 in draft, NLQ, and graphics modes; the OSP-3 was rated at 3, 4, and 4, respectively.

We've also discovered that table 1 (page 205) in the April printer review contains a consistent error in the sound levels recorded for the printers' graphics modes. The dB levels we published are far too high; the correct figures appear on page 254 in this issue. Generally, sound levels for the graphics mode ranged from 5 percent to 10 percent higher than those for NLQ mode. At the low end of the sound range, for example, dB levels for the Tandy DMP 130 rose from 62 in NLQ to 65 in graphics mode. Near the high end of the range, Output Technology's OT-700e had a 10-point jump from 79 to 89 dB. In the more common mid-range level, the Alps America ALQ324 shifted only slightly from 71 to 72 dB.

Our lineup this month starts off with Stephen Satchell's review of 10 high-speed internal modems, a follow-up to his evaluation of 23 external modems in the December 1986 issue. Once more, Stephen simulated a bad telephone line to test the modems. For this review, he also ran a set of "street tests" to see how the units are likely to hold up during transmission on an average telephone line.

Another highlight this month is John Unger's review of the Compaq Portable III, a 12-MHz transportable with a 20- or 40-megabyte hard disk. The Portable III

has more power and speed than many desktops; its performance is unmatched by any other portable computer—at least those available at press time.

Completing this month's section are reviews of the Commodore 64C, a \$229.95 8-bit computer bundled with the GEOS window-and-icon operating system; SCSI hard disk drives and BASIC compilers for the Macintosh; Q&A version 2.0, a file manager teamed with a word processor and natural-language front end; and Lyrix, a word processor that runs under UNIX and XENIX.

As a bonus, three additional reviews are available on BIX in the may87.supp conference, the supplement to this issue of BYTE. (For information on joining BIX, see page 256.) Here are brief summaries for readers who don't subscribe to BIX.

First, Alexis Lane evaluates removable-cartridge drives for the IBM PC and compatibles: Iomega's Bernoulli Box Plus, Sysgen's DuraPak, and IDEAssociates' Diskit 2 and Diskit 2 Plus. All four units use 10-, 15-, or 20-megabyte removable cartridges to provide virtually unlimited disk storage, file security, and transportability of data.

Of the units tested, Alexis's favorite was the Bernoulli Box Plus, though it was also the most expensive at \$3775 (a price that includes a booting controller board). This model holds one 80-megabyte hard disk drive and two 20-megabyte removable-cartridge drives. The unit is reliable, its documentation is complete, and it comes with a useful selection of utilities. For more information, contact Iomega Corp., 1821 West 4000 South, Roy, UT 84067, (801) 778-3000.

The DuraPak, the least expensive unit at \$2295, also performed well. It holds two 15-megabyte removable-cartridge drives and comes with a controller card. Contact Sysgen Inc. at 556 Gibraltar Dr., Milpitas, CA 95035, (408) 263-4411 for details. The Diskit 2 (\$2995) and Diskit 2 Plus (\$3595) each have two 10-megabyte removable-cartridge drives; on the 2 Plus, you also get DES-based file-encryption capabilities for added security. For more information, contact IDEAssociates Inc., 29 Dunham Rd., Billerica, MA 01821, (617) 663-6878. The two Diskit units, Alexis found, have the best installation program; but one of the car-

tridges developed many bad sectors, causing data loss.

The benchmark tests show that, in general, removable-media devices are slower than their fixed-disk counterparts. Overall, though, their compactness and the convenience of the cartridges make them an alternative to fixed hard disks.

Next in the may87.supp conference is Leonard Moskowitz's review of OPS5+, a production-system language for the IBM PC, XT, AT, and compatibles from Computer*Thought Corp. (840 Avenue F., Suite 104, Plano, TX 75074, (214) 424-3511). Version 3.0B, Leonard reports, provides a standard command mode and a menu- and mouse-driven windowing environment.

The benchmarks show OPS5+ to be an excellent performer on a PC AT, sometimes faster than VAX OPS5, and about half as fast as OPS5 on the Symbolics 3670. The \$1800 package offers hooks to external Lattice C procedures, first-rate documentation, and useful language extensions. A few minor problems showed up during the review, and the DOS 640K-byte memory restriction limits the size of the production systems you can build. But all in all, Leonard says, it's a professional package that will give you excellent code compatibility.

Finally, BYTE senior technical editor Gregg Williams reviews the Cauzin Soft-strip System. This device hooks up to a serial port on an Apple II, IBM PC, or Macintosh and reads high-density data strips printed on paper. Each 8-inch strip encodes about 1000 to 5000 bytes, with up to seven strips per page. The reader (\$199.95) comes with an accessory kit (\$19.95) containing cables, software, instructions, and sample programs.

Gregg found the system easy to use and reliable on all three computers. He also experimented with The Stripper, a \$29.95 program from Cauzin for creating low-resolution data strips with a dot-matrix printer. Cauzin Systems Inc. (835 South Main St., Waterbury, CT 06706, (203) 573-0150) also sells a program for making high-density data strips with laser printers. Gregg concludes that this well-designed piece of technology will be of use if you need to distribute small amounts of software or data.

—Cathryn Baskin
Senior Technical Editor, Reviews



When it comes to choosing the best monitor, you can't get more serious than the Princeton *HX-12E*.

The *HX-12E* switches automatically from CGA to EGA for complete IBM compatibility at the best value. And Princeton delivers performance to meet your immediate needs today. And every day. Right away.

But that's just part of how serious we are. At Princeton Graphic Systems, we believe the best monitor is still the monitor with the best picture.

The *HX-12E* sets the image standard with the finest dot pitch (.28mm) to

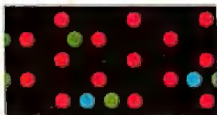

.28 mm dot pitch.

create the sharpest, clearest and most colorful image of any monitor in its class. It's a difference you can see, and it's the difference that gives Princeton the visible edge.

So the next time you're wondering who's got the best monitor, take a look at the Princeton *HX-12E*. It's where you'll find the finest components matched to the highest engineering standards for uncompromising performance and value. And we simply can't picture it any other way. And that's no fooling.

PRINCETON
GRAPHIC SYSTEMS
THE VISIBLE EDGE



High-Speed Internal Modems

Stephen Satchell

An evaluation of 10 plug-in modem cards for the IBM PC family

For my review entitled "23 Modems" (December 1986 BYTE), I simulated a bad telephone line and tortured 23 stand-alone modems to see what they could tolerate. For this review, I tested 10 modems that you install inside the IBM PC family of computers (see table 1 for a complete list of the modems and company names). Seven of these modems support 300/1200/2400-bit-per-second operation, and three can transmit at 9600 bps.

A word of caution: I tested these modems only for their ability to originate calls. The resulting data is valuable to people who use their modems for calling information services, bulletin boards, and message systems. I made no tests of the modems' ability to answer calls. This means that service providers and bulletin board operators should not depend solely on these results to select a modem for such services.

Features

Table 2 lists some of the features I looked for when examining these modems. This is by no means a complete comparison chart, but it details some of the basics. The first section shows some elementary capabilities and convenience items, such as the size of the card, whether a speaker is located on the card (this lets you monitor call progress audibly when making attended calls), and whether a phone jack is included on the card for an external telephone (this lets you plug a phone in without a Y adapter).

Luxury features include such things as a real-time clock, support for COM ports 3 and 4, CCITT V.22 quadrature phase-modulation capability at 1200 bps, security support (such as modem passwords and auto-callback), and the number of user-defined communications-parameter setups that you can store in each modem.

The second section of table 2 details the user diagnostics available with each modem. There is nothing like being able to isolate a problem yourself to save need-

less trips to the repair shop. I consider local analog loopback capability a necessity because it checks the carrier transmit and carrier receive; I would not purchase a modem without it. The other three diagnostic modes (local digital loopback, initiate remote loopback, and response to remote loopback) are nice to have but not absolutely necessary.

Special dialing features such as stored directory entries and automatic redial are duplicated in most IBM PC terminal-emulator programs.

All modems sense the presence of a dial tone, and most allow you to wait for a secondary dial tone (when connecting to a toll trunk, for instance). All can switch from Touch-tone to pulse dialing and back. All allow you to repeat the last command given, providing some limited redial capability. Some modems have a remote-ring indication, telling you that the other end is ringing, while the US-Robotics Microlink 2400 and the Cermetek 2400 SPC will tell you if a voice answers.

Call-progress monitoring is best done by listening on a speaker. Programs that run unattended or hide the mechanics of making a connection require some information to aid in error recovery. All the modems I reviewed return the standard Hayes call-progress-monitoring result codes with the exception of the Cermetek 2400 SPC.

The last section of table 2 details the compatibility of each modem's command set with the basic Hayes command set. For this purpose, I checked to make sure that the commands shown in table 3 were functional. S-registers 0 through 12 and result codes 0 through 10 should be as defined for the Hayes 1200- and 2400-bps modems. Other commands, registers,

and results can be anything the modem company wishes to make them. Deviations are listed for each modem.

Several modems require you to set an S-register to indicate the speed you wish to use. If you use the default, the auto-baud feature will cause the modem to attempt to connect at the fastest rate that the remote modem responds to. This means that if you use an on-line information service and wish to use a speed of 300 bps because it is cheaper, you must set an S-register to make this happen. Otherwise, the modem will connect at a faster, more expensive speed.

Modem Basics

In my "23 Modems" article, I went into considerable detail as to how a modem works. For this article, I'll summarize briefly.

A modem (which stands for modulator-demodulator) takes digital data and converts it into a signal for transmission at the originating end of the transmission line, and another modem receives and regenerates the digital data at the other end. Depending on the modulation method, 8 or more data bits are grouped to represent a character, and the characters are transmitted over the telephone line using one of the standard communications modulation schemes.

In full-duplex connections over the switched network (local and long-distance direct-dial telephone service) a maximum of 600 symbols, each consisting of one or more modulation changes, are sent in each direction. In half-duplex connections, up to 2400 symbols are sent in one direction at a time, with the direction changing at prearranged intervals; this is known as line turnaround. A sym-

continued

Stephen Satchell (Satchell Evaluations, 16 Searing Ave., Morristown, NJ 07960) has been active in computer product development and evaluation since 1971.

Table 1: Label definitions and prices for the modems tested.

<p>*AJ: AJ 2400-2H01 Anderson Jacobson 521 Charcot Ave. San Jose, CA 95131 (408) 435-8520 \$650 (no software)</p>	<p>DCA: IRMA Fastlink Digital Communications Associates Inc. 1000 Alderman Dr. Alpharetta, GA 30201 (404) 442-4000 \$1195 (includes Crosstalk-Fast)</p>	<p>OMN: Encore 2400 HB OmniTel Inc. 5415 Randall Place Fremont, CA 94538 (415) 490-2202 \$449 (includes Bitcomm)</p>
<p>*ANC: Lightning f/i Anchor Automation Inc. 20675 Bahama St. Chatsworth, CA 91311 (818) 998-6100 \$499 without MicroNet protocol \$599 with MicroNet Level 4 protocol (prices include LYNC software)</p>	<p>EV: Fastcomm 2496B Fastcomm Data Corp. 12347-E Sunrise Valley Dr. Reston, VA 22091 (703) 620-3900 \$1079 (no software)</p>	<p>TEL: TrailBlazer Telebit Corp. 10440 Bubb Rd. Cupertino, CA 95014 (408) 996-8000 \$1195 without software \$1390 with Crosstalk XVI-Fast</p>
<p>CER: 2400 SPC Cermetek Microelectronics Inc. 1308 Borregas Ave. Sunnyvale, CA 94088-3565 (408) 752-5000 \$395 without software \$445 with Mirror software</p>	<p>HAY: Smartmodem 2400B Hayes Microcomputer Products Inc. 705 Westech Dr. Norcross, GA 30092 (404) 449-8791 \$799 (includes Smartcom II)</p>	<p>USR: Microlink 2400 USR Robotics Inc. 8100 North McCormick Blvd. Skokie, IL 60076 (312) 982-5010 \$599 (includes Telpac software)</p>
<p>CTS: Half-Pak #24 CTS Fabri-Tek Inc. Datacomm Products Division 6900 Shady Oak Rd. Eden Prairie, MN 55344 (612) 941-9100 \$395 (no software)</p>	<p>MER: Mercury Fastmodem Creative Digital Inc. 1662 West 820 North Provo, UT 84601 (801) 373-9843 \$495 (includes Mirror software)</p>	<p>VEN: Half Card 24 Ven-Tel Inc. 2342 Walsh Ave. Santa Clara, CA 95051 (408) 727-5721 \$599 (includes Crosstalk XVI)</p>

*These modems were not tested due to failure during initial pretest operations.

bol encodes 1 or more data bits using a variety of modulation changes. The data rate is defined as the reciprocal of the length (in seconds) of the shortest element in the transmitted signal. The data rate can therefore be different from the bps rate; again, this is dependent on the type of modulation used. Generally, though, for the commonly used frequency-shift modulation, they are considered to be the same.

What Goes Wrong

Most modems have no difficulty recognizing the symbols transmitted on an ideal telephone connection, such as the one you get when you connect two modems together with a standard modular telephone cord. Very little degradation of the modulated signal occurs.

As you start putting more wire between the modems, transmission imperfections start appearing. These imperfections, called impairments by the telephone industry, can interfere with the modem's ability to recognize each symbol correctly. At some point in the telephone net-

work, the telephone company will split your connection into two, handling each direction separately. This eases some of the difficulties of long-distance telephoning, but it also means that each half of the connection can have its own problems. You can have a clean connection going in one direction and a noisy one going in the other direction.

To complicate the matter of testing a modem on a switched network, you cannot depend on having the call routed the same way twice. But even if the calls could be routed, line conditions change due to the weather, the age of the telephone lines, replacement of lines and switch equipment, and even introduction of new technology into the circuits, such as fiber optics.

Test Setup

To subject these modems to exactly the same conditions with each other and with the modems that I evaluated in my other review, I built a telephone connection simulator (see figure 1) by using a Bradley Telcom Corporation 2A/2B line sim-

ulator, a reference modem (an AT&T 2224B), a Hewlett-Packard 4437A attenuator, passive hybrid splitters, and a Ramsa 8210 recording mixer (used to synthesize the line amplifiers). The computer used was an IBM PC AT model 099. The modem being tested was installed in slot 4 of the PC AT.

In my prior evaluation, I placed the AT&T 2224B in digital loopback mode. Thus, the data was sent from the modem under test to the reference modem over a clean line, looped back into the reference modem, and then returned to the modem under test through the impairment generator. For this review, I elected to send the data directly from the reference modem (see figure 1). This better approximates actual operation. I spot-checked several modems with the 2224B in loopback mode and obtained exactly the same results.

This change supports realistic testing of the high-speed modems: the Fastcomm 2496B, the Telebit TrailBlazer, and the DCA IRMA Fastlink. Since the throughput of the modem under test could be

Table 2: Features of the modems listed in table 1.

Modem	AJ	ANC	CER	CTS	DCA	EV	HAY	MER	OMN	TEL	USR	VEN
Feature												
Half Card	—	—	Y	Y	—	Y	—	—	Y	—	—	Y
Speaker	Y	Y	Y	Y	—	Y	Y	Y	—	—	Y	Y
Com 3 and 4 support	—	Y	Y	—	Y	Y	—	Y	Y	Y	Y	Y
CCITT V.22 (1200 bps)	Y	Y	—	Y	Y	—	Y	Y	Y	Y	—	—
Phone jack	Y	Y	Y	Y	—	—	Y	Y	Y	—	Y	Y
User-stored setups	1	1	—	1	—	1	2	—	—	—	—	—
Real-time clock	—	—	—	—	—	—	—	—	—	—	Y	—
Security support	Y	—	—	—	—	—	—	—	—	—	—	—
Speed set by auto-baud	—	Y	Y	Y	—	—	Y	Y	Y	—	Y	Y
In-modem help	Y	Y	—	—	Y	Y	—	—	—	Y	Y	—
Diagnostics												
Local analog loopback	Y	Y	—	Y	—	—	Y	Y	Y	—	Y	Y
Local digital loopback	Y	—	—	Y	—	—	Y	Y	—	—	—	Y
Initiate remote loopback	Y	—	—	Y	—	—	Y	Y	—	—	—	Y
Response-to-remote loopback	Y	—	—	Y	—	—	Y	Y	—	—	—	Y
Dialing												
Directory entries	20	10	—	1	10	—	4	—	—	10	—	—
Automatic redial	Y	—	—	—	—	—	—	—	—	—	—	—
Call-progress status (exceptions)												
Busy signal	Y	Y	Y	Y	Y	—	Y	Y	Y	Y	Y	Y
Remote ringing	—	—	Y	—	Y	—	—	—	—	Y	Y	—
Voice answer	—	—	Y	—	—	—	—	—	—	—	Y	—
Hayes command set												
Missing/different basic commands	—	—	M,W	—	X	W	—	—	!,W	X	—	—
Missing/different S-registers	—	11	—	11	—	—	—	—	10	—	—	—
Missing/different results	—	—	6-9	—	—	—	—	—	—	—	—	—

The call-progress result codes and Hayes commands from table 3 that are not shown are present in all the modems tested.

limited by the ability of the test program in the IBM PC AT to feed and check data, I tried using the package on a null modem cable, creating a data-turnaround loop. The modem test program was able to pump 1813 characters per second over a 19,200-bps connection.

Mortality

Before running the battery of tests, the subject modem had to prove that it was working properly. This was necessary for two reasons—to make sure I knew how to get the modem under test working properly in my test setup, and to make sure that the single-impairment studies wouldn't be marred by spurious errors caused by a flaky modem. As a result, I found out how to get the modems to connect at every speed. However, two modems didn't make the cut.

The first Anderson Jacobson AJ 2400-2H01 that I tested was unfriendly enough to short out the power supply in the IBM PC AT. When I examined the way the board was placed in the slot, I discovered

continued

Table 3: Hayes-compatible commands.

A - Answer	P - Pulse dial	W - Wait for dial tone
D - Dial	Q - Response disable	X - Select response set (X0,X1)
E - Command echo	R - Reverse orig/ans	Z - Reset
H - Hook control	S - Read/set S-registers	, - Pause
M - Speaker control	T - Tone dial	; - Stay in command mode after dialing
O - Go on-line	V - Verbose/terse responses	! - Hookflash

Table 4: Definitions of impairment labels.

Sens:	Sensitivity in dBm to initiate error-free connection.
P-mod:	Phase modulation in degrees.
A-mod:	Amplitude modulation in percent.
White:	White noise signal-to-noise ratio in dB.
G-hit:	Gain hit in dB.
P-hit:	Phase hit in degrees.
Err:	Number of errors in the two-minute worst-case test.
CPs:	Throughput in characters per second in the worst-case test, truncated to the nearest character by the test program.

that the edge connector was misaligned with the PC AT system board connector. This was due to improper manufacturing tolerances when the board outline was trimmed, as well as improper location of the support bracket. Luckily, this caused no damage to the PC AT. The second AJ 2400-2H01 that I tested was able to get a clean connection at 300 bps, but 1200- and 2400-bps connections were not error-free. Repeated calls to Anderson Jacobson about this problem produced no response.

The first sample of the Anchor Automation Lightning f/i that I received would not connect cleanly at any speed. The second sample was better at 300 bps, but it was not error-free at 1200 bps and, at 2400 bps, I couldn't get the modem to finish the connection sequence. Anchor Automation said it was surprised at this result but offered no explanation.

Test Conditions

A test series consisted of two sensitivity measurements, four test sets, and two

error-count measurements. The first set was run at -8 dBm (decibels referenced to 1 milliwatt, measured at the modem), the second at -16 dBm, and the third at -26 dBm. The fourth set was run at -8 dBm. All levels were set using the 2225-Hertz answer tone of the AT&T 2224B reference modem.

A test group consisted of 23 single-impairment tests. I increased the level of each impairment until the modem under test started to generate errors. I then backed the level of impairment off until the modem transmitted data for 15 seconds without error. (See the text box "Impairment Parameters" on page 213 for a detailed description of the impairments.)

Error Count and Throughput

The real test of a modem is how well it transfers data in the face of anything a telephone line can throw at it. The main difference between this evaluation and my last one is that I used no filtering during the error-count test. This is mostly be-

cause the frequency response reported in the AT&T/Bell Laboratories' "1982/83 End Office Connection Study" (see bibliography) shows that the frequency response is flat within 2 dB. Because of this difference in test methods, you cannot directly compare these numbers with the numbers reported in my prior evaluation.

I performed two separate error-count tests on each modem at speeds of 300, 1200, and 2400 bps. The first test is the torture-track test, which is characterized by excessive levels of impairments. The signal level is -16 dBm with 10 degrees of 60-Hz phase modulation, 2 percent of second- and third-order harmonic distortion, white noise at 23 dB below the signal level, and a combined phase and amplitude hit of 10 degrees and 2 dB once every 5 seconds. The modems were allowed to sit with the connection for 15 seconds; I then took error counts and a character throughput count for two minutes.

The second error-count test, which I did not perform in my previous evaluation, is more of a "street test" of the modems, simulating a typical 1983 average telephone line as defined in the "1982/83 End Office Connection Study." Here I threw only three impairments at the modems: 4 degrees of 60-Hz phase modulation, 1 percent of second- and third-order harmonic distortion, and a 33-dB signal-to-white-noise distortion. All the modems breezed past this two-minute test at 300, 1200, and 2400 bps. This data, therefore, does not appear in the result tables.

For the three high-speed modems, I contrived an additional set of throughput tests for their top speed. All these tests were run with an interface speed of 19,200 bps for five minutes to reduce

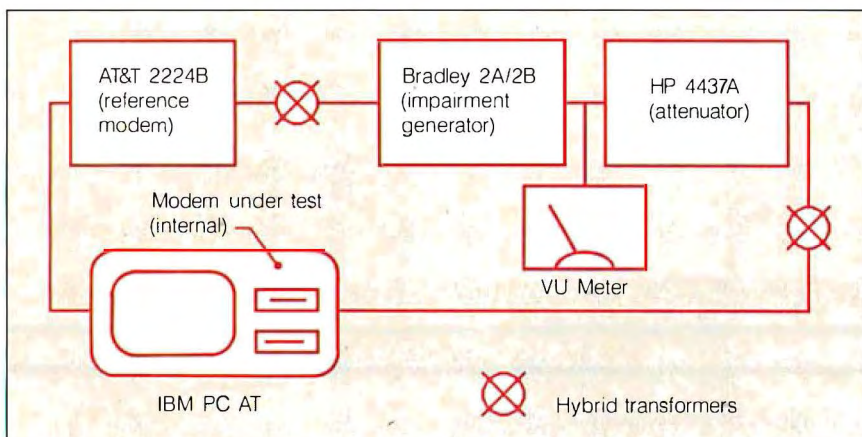

Figure 1: The impairment-generating test setup used for modem evaluation.

Table 5: Results of the 300-bps connection test. With the exception of White Noise, higher numbers indicate better performance. The number-of-errors and throughput results are from worst-case tests.

	Sens	P-mod	A-mod	White	G-hit	P-hit	Err	CPS
CER	-39	45 to >85	70 to 80	13 to 12	11 to 14	70 to >85	0	29
CTS	-40	55 to >85	70 to >85	12 to 10	18 to >20	65 to >85	0	29
DCA	-39	30 to >85	20 to 60	16 to 14	6 to 11	60 to >85	0	29
EV	-40	45 to >85	70 to 80	13 to 12	12 to 14	70 to 90	0	29
HAY	-40	45 to >85	60 to 80	13 to 11	11 to 14	60 to >85	0	29
MER	-42	50 to 65	65 to 85	13 to 11	5 to 08	65 to >85	0	29
OMN	-44	35 to >85	35 to >85	27 to 26	7 to >20	30 to >85	55	21
TEL	-39	30 to >85	20 to 60	16 to 14	6 to 11	60 to >85	0	29
USR	-36	25 to >85	30 to 55	25 to 24	4 to 10	35 to >85	19	27
VEN	-35	45 to >85	60 to 80	14 to 13	10 to 14	55 to >85	0	29

An entry of 29 in the CPS column indicates a perfect run at 300 bps due to the test program truncating the cps to whole characters and the timing starting at the beginning of the test instead of when the first character reaches the serial port.

Impairment Parameters

The following are the details of the impairment parameters I used to test the 10 modems. Based on the "1982/83 End Office Connection Study," I used two distinct impairment levels: a level of impairment higher than that measured on 95 percent of the connections in the study (the 95 percent level), and a level higher than that measured on 50 percent of the connections (the 50 percent level). Table 4 lists the abbreviations of the test parameters as they appear in the test results. In cases where all modems passed the tests, I did not list the results.

Sensitivity

A sensitivity measurement determines the lowest signal level at which the modem will answer and receive random data without errors for 30 seconds. This is a signed value, so lower numbers in the tables represent better performance; that is, -45 is better than -40.

Phase Modulation

Phase modulation (also known as phase jitter) is a regular back-and-forth shift in the waveform with respect to time. Moderate amounts of phase modulation should not affect 300-bps operation. Other more complex modulation methods use phase modulation to encode symbols, so any unwanted phase modulation can make decoding difficult or impossible. I used steps of 5 degrees and took measurements at 20 Hz, 60 Hz, and 120 Hz. I found the frequency band from 10 Hz and 300 Hz to be the most sensitive to phase modulation. Higher numbers in the tables represent better performance. The 95 percent level is 8 degrees, and the 50 percent level is 4 degrees.

Amplitude Modulation

Amplitude modulation is a regular change in signal level. It is the equivalent of turning a volume control up and down at a regular rate. I used steps of 5 percent and took measurements at 20 Hz, 60 Hz, and 120 Hz. Higher numbers in the tables represent better performance. The 95 percent amplitude mod-

ulation level is 4 percent, while the 50 percent level for 20-Hz to 300-Hz modulation is 3 percent.

White Noise

White noise, the hiss you hear on long-distance calls, is a band noise distributed evenly throughout the frequency spectrum. As this noise gets louder in relation to the signal level, the modem has a harder time determining what is part of a symbol and what is background noise. The values reported in the tables are the differences between the noise level and the signal level. I made adjustments in 1-dB increments. The connection study reports noise in absolute levels. From my -8-dBm reference, the 95 percent level is 43 dB, and the 50 percent level is 53 dB. From the -16-dBm level used in the error-count test, the 95 percent value is 35 dB, and the 50 percent value is 45 dB. In other words, a higher dB value indicates less noise in relation to the signal; 45 dB is a noise level that is 45 dB below the indicated signal level. Therefore, lower number values indicate better noise rejection.

Gain (Amplitude) Hit

A gain hit is a long-term step in the level of the signal; I used steps of 5 percent. The modem was subjected to one gain hit per second. Each hit shifted the level, held the new level for 100 milliseconds, and then shifted the level back. Three shift speeds, which measure the time required to accomplish the shift, were used: 20 ms, 2 ms, and 200 microseconds. Adjustment was in 5 percent increments. Higher numbers in the tables represent better performance. No gain hits were counted in five minutes at either the 95 percent level or the 50 percent level.

Phase Hit

A phase hit is a short-term shift out of phase, with possibly a shift back. Each modem was subjected to one hit per second. Each hit shifted the signal, held the shift for 100 ms, and then unshifted the signal. I tested three shift speeds: 2 ms,

20 ms, and 200 μ s (essentially instantaneous).

Adjustment was in 5 percent increments here also. Higher numbers in the tables represent better performance. One 10- or 15-degree hit in five minutes is the 95 percent level, and no hit is the 50 percent level.

Frequency Shift

A frequency shift is a long-term translation of signal frequency. No modem in this or the prior evaluation was affected by a shift of as much as 5 Hz up or down. Testing was complicated by the Bradley 2A/2B's tendency to change the signal's amplitude as I changed the frequency. Once I equalized this, all the modems turned in error-free performance.

Single-Frequency Interference

Single-frequency interference is a single-frequency signal superimposed on the modem signal. For this evaluation, I restricted single-frequency interference to 20 Hz, 60 Hz, and 120 Hz. No modem was affected by a level exceeding 6 to 8 dB above the modem signal level.

Harmonic (Nonlinear) Distortion

This impairment is almost always due to a telephone line amplifier that does not faithfully represent at its output what it sees in its input. No modem in either of my evaluations was affected by a level of 5 percent of both second- and third-order harmonic distortion.

The "1982/83 End Office Connection Study" does not provide information for harmonic distortion but instead reports intermodulation distortion. The 95 percent level is under 2 percent intermodulation distortion, and the 50 percent level is under 1 percent IMD for both second- and third-order IMD.

Impulse Noise

Impulse noise is a transient voltage (amplitude) spike on the transmitted signal caused by lightning, relays, repairs, or other causes. None of the modems reviewed was affected by impulse noise that was 2 dB above the signal level.

biasing the numbers with the initial start-up of the transfer. I used no protocols; I blasted bytes to the modems as fast as they would accept them. My first test was the same torture-track test used at the 300/1200/2400-bps speeds. The second test was the torture-track test with white

noise at 28 dB below the signal level of -16 dBm. The third test was done with the street-test setup. The fourth test was done with no impairments at all to show how fast the modems can operate under local connections.

The reason that the character rates are

29, 119, and 239 for perfect runs at 300, 1200, and 2400 bps in tables 5, 6, and 7 is that the program truncates the calculation of characters per second to whole numbers, and the timer starts when the test begins, not when the first character actu-

continued

Table 6: Results of the 1200-bps connection test. With the exception of White Noise, higher numbers indicate better performance. The number-of-errors and throughput results are from worst-case tests.

	Sens	P-mod	A-mod	White	G-hit	P-hit	Err	CPS
CER	-38	65 to 75	70 to >85	12-11	16 to >20	40 to 65	0	119
CTS	-40	25 to 65	30 to 50	14-13	6 to 10	30 to 60	0	119
DCA	-44	40 to >85	10 to 70	13-12	7 to 9	35 to >85	0	119
EV	-40	60 to 75	75 to >85	13-12	18 to >20	40 to 65	0	119
HAY	-40	60 to 70	70 to >85	12-13	18 to >20	40 to 65	0	119
MER	-43	60 to 70	65 to 80	12-11	5 to 8	35 to 65	0	119
OMN	-43	50 to >85	50 to >85	14-13	16 to >20	40 to >85	0	119
TEL	-44	40 to >85	10 to 70	13-12	7 to 9	35 to >85	0	119
USR	-36	35 to 70	50 to 75	16-12	3 to 7	40 to 90	0	119
VEN	-38	65 to 75	75 to 80	12-12	16 to >20	35 to 65	0	119

An entry of 119 in the CPS column indicates a perfect run at 1200 bps due to the test program truncating the cps to whole characters and the timing starting at the beginning of the test instead of when the first character reaches the serial port.

Table 7: Results of the 2400-bps connection test. With the exception of White Noise, higher numbers indicate better performance. The number-of-errors and throughput results are from worst-case tests.

	Sens	P-mod	A-mod	White	G-hit	P-hit	Err	CPS
CER	-38	20 to 30	20 to 25	21 to 20	2 to 3	15 to 35	22	214
CTS	-40	5 to 20	5 to 20	22 to 22	2 to 3	10 to 25	44	188
DCA	-39	20 to 60	20 to 25	23 to 21	2 to 3	15 to 70	28	205
EV	-40	20 to 25	20 to 25	22 to 21	2 to 3	15 to 30	20	215
HAY	-40	20 to 30	20 to 25	21 to 20	2 to 3	15 to 35	15	222
MER	-43	20 to 25	20 to 25	21 to 20	2 to 3	15 to 30	103	84
OMN	-39	10 to 25	15 to 20	21 to 20	2 to 2	15 to 40	*	0
TEL	-39	20 to 60	20 to 25	23 to 21	2 to 3	15 to 70	28	205
USR	-32	10 to 15	10 to 15	24 to 21	2 to 3	15 to 30	29	206
VEN	-38	15 to 25	15 to 25	21 to 20	2 to 3	15 to 30	111	82

*The OmniTel Encore 2400 HB would not pass the worst-case phase-modulation impairment test, and it disconnected. It passed all the other tests.

An entry of 239 in the CPS column would be a perfect run at 2400 bps due to the test program truncating the cps to whole characters and the timing starting at the beginning of the test instead of when the first character reaches the serial port.

Table 8: High-speed 19,000-bps connection test results. The Worst results are from a torture-track test. The Modified Worst results are from a torture-track test with the noise at 28 dB below a signal of -16 dBm. The Average results are from a street test. The Best results are obtained when there are no line impairments.

	Worst		Modified Worst		Average		Best	
	Err	Cps	Err	Cps	Err	Cps	Err	Cps
EV	*	0	0	495	0	773	0	985
TEL	0	265	0	555	0	886	0	1495
DCA	0	265	0	555	0	886	0	1495

*Unit failed to connect under worst-case conditions.

ally gets to the serial port hardware. (For a complete tabulation of the test results, see tables 4 through 8.)

Winners and Losers

Common wisdom says that "if all else fails, use 300 bps." Unfortunately, this rule of thumb does not hold for the US-Robotics Microlink 2400 and the Omni-Tel Encore 2400 HB. The problem is that these modems are more susceptible to noise than the others by more than 10 dB. I was able to verify this by reducing the white noise level by 6 dB with the Microlink 2400 and was rewarded by an error-free run (see table 5).

When the going was easy, all modems performed well at 2400 bps and worked well with local connections. When the going got tough, they all had problems at

2400 bps. The modem that performed best in this test was the Hayes Smartmodem 2400B, followed closely by, in order of performance, the Fastcomm 2496B, Cermetek 2400 SPC, Telebit TrailBlazer, DCA IRMA Fastlink, US-Robotics Microlink 2400, and the Half-Pak #24. The Mercury Fastmodem and the Ven-Tel Half Card 24 brought up the rear. The OmniTel Encore 2400 HB never made it out of the starting gate; it failed to establish a connection on my worst-case line with the reference modem.

All 10 modems passed the street test and handled the torture-track test at 1200 bps without problems. This is a welcome finding, since more and more bulletin board services offer connections at 1200 bps.

Finally, with the high-speed modems, making the initial connection in the torture-track tests required repeated attempts. I almost gave up on the Telebit TrailBlazer, but I had to give it just one more try and was astounded when it connected and passed data. The Fastcomm 9600 Turbo couldn't operate when the white noise was 23 dB below the signal level, but at 28 dB it was fine. The TrailBlazer and the DCA IRMA Fastlink proved to be faster modems, but they are also more expensive.

The winner in the 300/1200/2400-bps modem class is the Cermetek 2400 SPC (\$395 for the modem only, \$445 with Mirror software). It placed third in the torture-track test. Its lack of a speaker-control command, a wait-for-dial-tone command, and its nonstandard call-progress result codes can cause trouble with software that relies on exact result codes but, overall, it is the clear winner of the price/performance trade-off. ■

BIBLIOGRAPHY

Abramson, N., and F. Kuo. *Computer-Communications Networks*. New York: Prentice-Hall, 1973.

Bartee, Thomas C. *Data Communications, Networks & Systems*. Indianapolis, IN: Howard W. Sams & Co., 1985.

Chorafas, Dimitris N. *Telephony: Today & Tomorrow*. New York: Prentice-Hall, 1984.

Davenport, William P. *Modern Data Communications: Concepts, Language, and Media*. Hasbrouck Heights, NJ: Hayden Book Co., 1971.

Hewlett-Packard, Delcon Division. *Data Communications Testing*. Hewlett-Packard, 1980.

"1982/83 End Office Connection Study." *AT&T/Bell Laboratories Technical Journal*, volume 63, number 9, 1984.

Sherman, Kenneth. *Data Communications: A User's Guide*. New York: The Telecom Library, 1981.

FORTRON PRESENTS THE DEPENDABLE POWER



While some power supply importers reduce their selling prices by using cheaper materials, we at Fortron do not jeopardize our discriminating customer's faith in our standards of quality by such compromises.



Here are some differences:

- UL recognized, CSA certified
- OVP, OCP, short circuit protection
- Meets VDE requirements
- MTBF 34,000 hrs.
- Four drives connectors
- Use Burndy® connectors
- Shielded power cord
- Built-in EMI filter
- One full year warranty

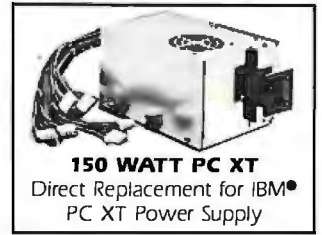

and now offering Lowest Cost Ever On GRAPHICS ADAPTORS (HEGA, EGA, CGA, MGP for PC, XT, AT)

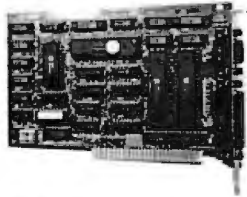

MGP \$89⁰⁰
(Retail)

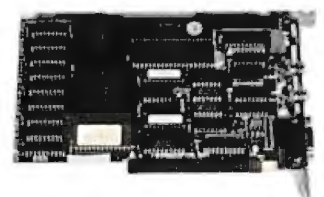

EGA \$199⁰⁰
(Retail)

- Hercules® IBM Monographics Compatible
- With Printer Port
- 720x348 Hi-Resolution
- Non-Flicker
- Works at 6, 8, 10, 12 mhz CPU speed
 - IBM® is a trademark of International Business Machines.
 - Hercules® is a trademark of Hercules Computer Technology.
- IBM EGA, CGA, MDA Compatible
- 640x350 Hi-Res, 16 Colors
- Support 256K Memory
- Light Pen Interface

HUGE DISCOUNT FOR VOLUME PURCHASE, DEALERS AND SYSTEM INTEGRATORS

End user please call for the name of Fortron dealer nearest you.

800-821-9771 ORDERS ONLY
415-490-8171 Information & Calif. Residents



FORTRON CORPORATION

3225 Seldon Court • Fremont, CA 94538
TLX 559291 • FAX (415) 490-9156

The fastest, tightest code.



(Though the same can hardly be said of the name.)

We have to tell you, we had a hard time getting the name down this short.

Because Microsoft's new FORTRAN Compiler actually has a far longer list of features.

It uses the same optimizer and code generator technology that made our C Compiler the industry leader.

And we've also added special loop optimizations that give you the

smallest, fastest FORTRAN code a PC can handle.

"Now Microsoft's FORTRAN Optimizing Compiler generates such fast code that an IBM PC/XT approaches the speed of the VAX."

Peter Osgood, MIT, Project Athena, Director of the Real Time Lab Project.

This compiler has already passed the toughest test there is. It's been

Microsoft FORTRAN Optimizing Compiler Version 4.0.

◆ Uses the Microsoft C optimizing technology, plus loop optimization to generate the fastest executable code for MS-DOS. NEW!

Execution Speed (in Seconds)	Microsoft FORTRAN v. 4.0	Ryan-McFarland FORTRAN v. 2.11	IBM Professional FORTRAN v. 1.22
Sieve	7.97	9.33	38.51
Whetstone	53.82	58.67	79.04
Lookup	5.82	18.61	26.02

◆ Fully GSA certified for ANSI 77 compatibility with no errors at the highest level. NEW!

◆ Numerous IBM VS and DEC VAX extensions. NEW!

◆ Microsoft CodeView: Window-oriented source-level debugger. NEW!
— Debug using your original source code, the resulting disassembly or both intermingled.

— Watch and change the values of your local and COMMON variables as you debug.

— Set conditional breakpoints on variables, expressions or memory; trace and single step.

— Debug Microsoft C programs as well as Microsoft Fortran programs.

— Watch and change registers and flags as you execute.

— Easily debug graphics oriented programs since program output is kept separate from debugger output.

GSA-certified as Full ANSI FORTRAN 77, and 100% error-free.

"The Microsoft FORTRAN Optimizing Compiler let us port the 200,000 line Boeing Mathematical Library (BCSLIB) with virtually no changes. This ANSI FORTRAN 77 code was ported directly from Cray, CDC, DEC, IBM and other mainframes and workstations."

*Ivor Philips, Boeing Computer Services, Program Manager
Mathematical Software Libraries.*

We've also included the same advanced intrinsic math functions found on VAX® and IBM® VS systems. Add

Compiler v. 4.0 with CodeView™

improvements like our new HUGE memory model, and porting the biggest mainframe programs has never been easier.

Among the many additions we've made to our package is our exclusive CodeView™ windowing debugger.

It lets you trace through programs at any level you want, from source code to assembly language.

You can open windows and watch both variables (local and COMMON) and CPU registers change.

You can set conditional breakpoints using variables and expressions.

Debugging gets even easier with the compiler's advanced diagnostics. Detailed error messages are thoroughly explained and cross-referenced in our new manuals.

Documentation that has been completely revised and expanded with tons of examples.

If we're talking your language, use one of the numbers below for more details about the Microsoft® ANSI FORTRAN 77 Optimizing Compiler

Version 4.0 with CodeView,

and the name of your nearest dealer.

(Even if the call's toll-free, it may be a good idea to refer to it as "FORTRAN 4.0" for short.)

Microsoft® FORTRAN

The High Performance Software. Inquiry 203

Call (800) 426-9400. In Washington State or Alaska, (206) 882-8088. In Canada, (416) 673-7638.

Microsoft and MS-DOS are registered trademarks and CodeView is a trademark of Microsoft Corporation. IBM is a registered trademark of International Business Machines Corporation. VAX is a registered trademark of Digital Equipment Corporation.

- ◆ Medium, Large and Huge Memory Model Libraries. NEW!
- ◆ Mix models with NEAR, FAR and new HUGE pointers.
- ◆ Common blocks and arrays greater than 64K.
- ◆ Choose from three math libraries and generate in-line 8087/80287 instructions or floating point calls:
 - floating point emulator (utilizes 8087/80287 if installed)
 - 8087/80287 coprocessor support
 - alternate math package—extra speed without an 8087/80287
- ◆ Link your FORTRAN routines with Microsoft C (v. 4.0 or higher), Microsoft Pascal (v. 3.3 or higher) or Microsoft Macro Assembler.
- ◆ Largest number of 3rd party support libraries available.

- ◆ Provides more detailed diagnostic error messages (almost twice as many as competitors) and extensive documentation with non-ANSI 77 features highlighted. NEW!
- ◆ Proven reliability—tested with over 2.5 million lines of code compiled and executed.
- ◆ MS-DOS® network support with file/record locking and sharing.
- ◆ Microsoft Program Maintenance Utility rebuilds your applications after your source files have changed. NEW!
- ◆ Other utilities including faster overlay linker (links over 1Mbyte object code), library manager, EXE file compression utility, EXE file header utility, MS-DOS environment setting utility and setup utility.

The fastest C

Your search for execution speed is over. The new Microsoft® C Compiler Version 4.0 is here. With blazing performance. We've added common sub-expression elimination to our optimizer that produces code that rips through the benchmarks faster than ever before.

“...the Microsoft performance in the benchmarks for program execution is the best of the lot overall.”
— William Hunt, *PC Tech Journal*, January, 1986*

But speed isn't the only edge you get with Microsoft C. Other advantages include a variety of memory models like our new HUGE model that breaks the 64K limit on single data items. Plus our NEAR, FAR and HUGE pointers, which provide you greater flexibility. All this allows you to fine tune your program to be as small and fast as possible.

“Excellent execution times, the fastest register sieve, and the best documentation in this review ... Microsoft Corporation has produced a tremendously useful compiler.” — Christopher Skelly, *Computer Language*, February, 1986.

No more debugging hassles. Introducing CodeView. Free.

Now, for a limited time, we'll give you an unprecedented programming tool when you buy Microsoft C, free. New Microsoft CodeView™ offers the most powerful tool yet in



the war on C bugs. Forget the hex dumps. Now you can view and work with programs at any level you want. Use the program source, the disassembled object code, or

Microsoft C Compiler Version 4.00

Microsoft C Compiler

- Produces fast executables and optimized code including elimination of common sub-expressions. **NEW!**
- Implements register variables.
- Small, Medium and Large Memory model libraries.
- Compact and HUGE memory model libraries. **NEW!**
- Can mix models with NEAR, FAR and the new HUGE pointers.
- Transport source and object code between MS-DOS® and XENIX® operating systems.
- Library routines implement most of UNIX™ System V C library.
- Start-up source code to help create ROMable code. **NEW!**
- Full proposed ANSI C library support (except clock). **NEW!**
- Large number of third party support libraries available.
- Choose from three math libraries and generate in-line 8087/80287 instructions or floating point calls:
 - floating point emulator (utilizes 8087/80287 if installed).
 - 8087/80287 coprocessor support.
 - alternate math package — extra speed without an 8087/80287.
- Link your C routines with Microsoft FORTRAN (version 3.3 or higher), Microsoft Pascal (version 3.3 or higher) or Microsoft Macro Assembler.
- Microsoft Windows support and MS-DOS 3.1 networking support.
- Supports MS-DOS pathnames and input/output redirection.

Microsoft Program Maintenance Utility. **NEW!**

- Rebuilds your applications after your source files have changed.
- Supports macro definitions and inference rules.

Other Utilities

- Library Manager.
- Object Code Linker.
- EXE File Compression Utility.
- EXE File Header Utility.

C Benchmarks

	In seconds				
	Microsoft C 4.0	Lattice C 3.0	Computer Innovation C 2.3	Aztec C86 3.2	Wizard C 3.0
Sieve of Eratosthenes (register)	82.9	151.4	172.3	88.0	91.9
Copy Block	86.9	231.7	199.0	123.8	189.5

Run on an IBM PC XT with 512K memory

Microsoft CodeView

Window-oriented source-level debugger. **NEW!**

- Watch the values of your local and global variables and expressions as you debug.
- Set conditional breakpoints on variables, expressions or memory; trace and single step.
- Watch CPU registers and flags as you execute.
- Effectively uses up to four windows.
- Debug using your original source code, the resulting disassembly or both intermingled.
- Use drop-down menus to execute CodeView commands.
- Access the on-line help to lead you through CodeView's options and settings.
- Easily debug graphics-oriented programs since program output is kept separate from debugger output.
- Keyboard or optional mouse support.
- Enter in familiar SYMDEB or DEBUG commands.

*Reprinted from *PC Tech Journal*, January 1986, copyright 1986, Ziff-Davis Publishing.

you've ever seen.

both at the same time. Open a window to view CPU registers and flags. Watch local and global variables as well. All while your program is running.

CodeView gives you complete control. Trace execution a line at a time—using source or assembly code. Or set conditional breakpoints on variables, memory or expressions. CodeView supports the familiar SYMDEB command syntax, as you'd expect. Commands are also available through drop-down menus. Combine the new window-oriented interface with our on-line help and debugging has never been easier. Or quicker.

Take the \$5 CodeView tour.

You may find it hard to believe our debugger can do all we've claimed. So we're offering test drives. Five bucks will put you behind the wheel of a Microsoft C demo disk with CodeView.† See for yourself how fast debugging can get.

For more information about the CodeView demo disk, the new Microsoft C Compiler, a list of third party library support or the name of your nearest Microsoft dealer, call (800) 426-9400. In Washington State and Alaska, (206) 882-8088. In Canada call (416) 673-7638.

```
File Search View Run Watch Options Calls Trace! Go! pi.exe
| math.c |
0) island : 244
1) tiszero() : 1
2) 4034:0000 00 00 00 00 00 00 00 00 43 72 .....

3DB5:00EE B00200 MOV AX,0002
3DB5:00F1 E89402 CALL _chkstk (0388)
3DB5:00F4 56 PUSH SI
3DB5:00F5 8B7604 MOV SI,Word Ptr [BP+04]
13: t[0] = 1:
3DB5:00F8 C606441A01 MOV Byte Ptr [t (1A44)],01
14: div(s); /* t[] = 1/s */
3DB5:00FD 56 PUSH s
3DB5:00FE E82601 CALL _div (0227)
3DB5:0101 83C402 ADD SP,+02
15: add():
3DB5:0104 E84D00 CALL _add (0154) ;BR0
16: island = 1;
3DB5:0107 C746FE0100 MOV Word Ptr [island],0001
17: do {

>da 33 0x29
4034:0021 Microsoft
>
```

Microsoft® C Compiler

The High Performance Software

Microsoft, MS-DOS and XENIX are registered trademarks and CodeView is a trademark of Microsoft Corporation. UNIX is a trademark of AT&T Bell Laboratories. IBM is a registered trademark of International Business Machines Corporation. †Offer expires 12/31/86.



DO NOT ATTEMPT WITHOUT COMPU SERVE.

Get all the facts as fast as the experts do before you try to tame the market.

Without accurate, up-to-the-minute data you can easily get taken for a ride on Wall Street. That's why it's important to get your hands on CompuServe. The fastest, most reliable source of comprehensive financial data available.

Now, just like Wall Street's most prestigious firms, you can check out a tip or find a hot, money-making lead in a matter of seconds. Investigate any area of interest. Or scan CompuServe's financial news highlights to find new areas to investigate. Including...

Continuously updated quotes on over 10,000 issues.

MicroQuote II—12 years of daily historical prices, along with dividends, splits, distributions and interest payments on more than 90,000 stocks, bonds, mutual funds, options, foreign exchange rates and hundreds of market indexes.

Graph trends quickly online. Review your portfolio performance, investigate returns in bull and bear markets. Screen for stocks to buy, or transfer prices and dividends to your microcomputer for detailed analysis.

Standard & Poor's descriptive information on over 3,000 companies.

Value Line Data Base II—extensive, fundamental data for analyzing the performances of over 1,800 major corporations.

Disclosure II—descriptive and financial information from the SEC filings and annual reports of over 8,500 companies.

Institutional Broker's Estimate System (I/B/E/S)—earnings projections from top research analysts on over 3,000 widely followed companies.

You can also research technical market trends, review economic projections and high-powered market analyses. Get expert advice on retirement, financial planning, managed accounts, taxes and insurance. Evaluate your own portfolio, even connect to a variety of at-home banking and brokerage services.

And all this comes with CompuServe's base of news, weather, telecommunications, special interest and entertainment services.

Compare CompuServe's rates to the cost of expensive floppy-based sources. Compare our up-to-the-minute delivery to time-consuming publication research. Compare the depth and breadth of our virtually infinite databases to any other source of investment information.

Then see your nearest computer dealer for a CompuServe Subscription Kit. Suggested retail price is only \$39.95 and includes \$25 of online time.

For more information or to order direct, call or write:

CompuServe[®]

Information Services
P.O. Box 20212
5000 Arlington Centre Blvd.
Columbus, OH 43220
800-848-8199
In Ohio, call 614-457-0802



An H&R Block Company



Compaq's New Carryon

John Unger

*The Portable III
doesn't sacrifice performance
for portability*

The Compaq Portable III Model 20 is neither a laptop nor a desktop computer; it lies somewhere between the two. Its size (10 by 16 by 8 inches), weight (20 pounds), and AC line voltage (instead of batteries) dictate that it should reside on a desk or tabletop. However, it is also smaller and lighter than the average desktop computer—small enough to fit under an airline seat or in an overhead rack and light enough to be carried. It is the smallest and lightest of Compaq's portables to date: It is two-thirds the size and three-quarters the weight of the Portable II Model 4.

The Portable III's 80286 microprocessor is user-switchable between 12 and 8 MHz. The computer can also use an optional 8-MHz 80287 math coprocessor. It has 640K bytes of RAM on its main board and comes in three configurations: the Model 1 (\$3999), which includes a 1.2-megabyte floppy disk drive; the Model 20 (\$4999), the unit that I reviewed, which comes with the same size floppy disk drive and a 20-megabyte shock-mounted 3½-inch hard disk drive; and the Model 40 (\$5799), which has a 40-megabyte hard disk drive in addition to the floppy disk drive. The machine also features a high-contrast, dual-mode (640- by 400-pixel text/graphics mode and 640- by 200-/320- by 200-pixel IBM CGA mode) gas-plasma display, a full-size detachable keyboard with a numeric keypad, a hefty power supply, and a voltage sensor for the power line with automatic switching between 110 and 220 volts (domestic and international currents, respectively). Options include a 360K-byte floppy disk drive to use in place of the 1.2-megabyte floppy drive, an external expansion unit capable of containing two full-length PC



AT-compatible 8- or 16-bit add-on cards, an internal 300/1200-bps Hayes-compatible modem, and up to 6.6 megabytes of RAM.

The exterior case of the Portable III is made of light gray plastic, and, except for the power supply's case and the metal cage holding the disk drives, all its internal partitions and structural elements are also plastic. The inside of the Portable III and the expansion unit are coated with a metalized spray to suppress RFI (radio-frequency interference). The keyboard fits securely over the gas-plasma display to protect it when you carry the computer. After sliding two plastic latches to detach the keyboard and expose the display, you simply plug in the Portable III to get it up and running. The power switch is located at the bottom of the left rear of the computer; a green LED in the

upper right corner of the front panel glows when the computer is turned on. Depressing two more plastic latches on the top edge of the display screen releases the display and activates an ingenious arrangement of levers and grooves that enable you to raise the display about 4 inches and tilt it forward or backward 10 to 15 degrees. An optional desktop tilt-and-swivel pedestal provides a secure base for the computer, raises it 2 inches, and gives the unit and its display a wide range of viewing angles.

The organization of the Portable III's major components is straightforward. Its internal layout is composed of three sections. The screen occupies the front section, the main circuit board and I/O interfaces are mounted in the rear section, and the space in the middle is taken up by the power supply and disk drives.

A large and comfortably padded handle is located on the top of the Portable III. If you need to move the computer for any great distance, you will want the optional padded carrying case; its shoulder strap makes the 20-pound computer easier to carry, and the padding protects it.

Unlike the smaller keyboards found on laptop computers, the Portable III's keyboard is large enough for a full-function keypad/cursor section on its right side. Its overall layout is similar to that found on the early IBM PC ATs except that the 10 function keys are located in a row across the top. The keys have a somewhat

continued

John Unger (P.O. Box 95, Hamilton, VA 22068) is a geophysicist for the U.S. government who writes graphics software and uses computers to study the structure of the earth's crust.

Compaq Portable III Model 20

Company

Compaq Computer Corp.
20555 FM 149
Houston, TX 77070
(713) 370-0670

Size

10 by 16 by 8 inches; 20 pounds

Components

Processor: 16-bit 80286 running at 8

or 12 MHz; optional 80287 math

coprocessor running at 8 MHz

Memory: 640K bytes of 100-ns RAM,
expandable to 6.6 megabytes internally

Mass storage: One 1.2-megabyte
floppy disk drive and one 20-megabyte
hard disk drive

Display: Red-orange 5¼- by 8¼-inch
flat gas-plasma with 80-column by 25-row
text and 640- by 400-pixel high-
resolution monochrome graphics; also
emulates IBM CGA 320 by 200 and
640 by 200 modes

Keyboard: 84 keys; 10 function keys;
separate keypad/cursor keys; LED
indicators for Caps Lock, Num Lock,
and Scroll Lock keys

I/O interfaces: RS-232C port with 9-
pin D-shell male connector; Centronics-
compatible parallel printer port with
25-pin D-shell female connector; RGB
monitor port with 9-pin D-shell female
connector

Software

Software

ADAPT (Advanced Display Attribute
Programming Tool); Screen-Save

Options

Internal modem:	\$399
20-megabyte hard disk drive:	\$1399
40-megabyte hard disk drive:	\$2199
360K-byte floppy disk drive:	\$225
External expansion unit:	\$199
Compaq enhanced color graphics board:	\$599
Compaq color monitor:	\$799
Memory-expansion board:	\$225
512K-byte memory upgrade:	\$250
2-megabyte memory upgrade:	\$1299
8-MHz 80287 math coprocessor:	\$349
Nylon carrying case:	\$89
Desktop pedestal:	\$89
MS-DOS/BASIC release 3.2:	\$95
Technical Reference Guide:	\$99

Documentation

Operations Guide, 58 pages

Price

Model 1: \$3999
Model 20: \$4999
Model 40: \$5799

DISK ACCESS IN BASIC (IN SECONDS)

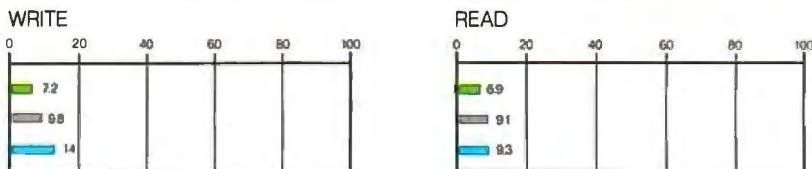

BASIC PERFORMANCE (IN SECONDS)

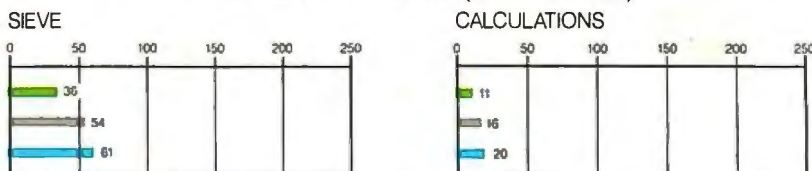

SYSTEM UTILITIES (IN SECONDS)

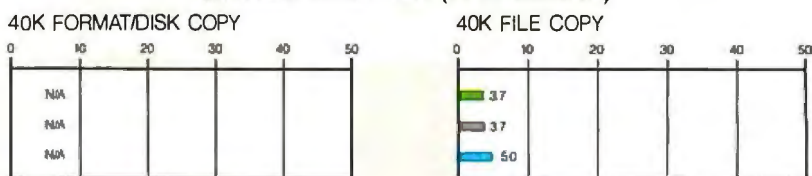

SPREADSHEET (IN SECONDS)

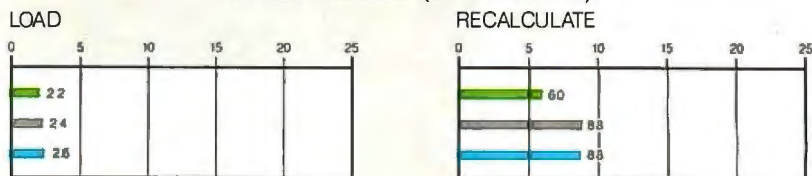

■ COMPAQ PORTABLE III (12MHz) ■ IBM PC AT (8 MHz)
■ COMPAQ PORTABLE III (8 MHz)

The graphs for Disk Access in BASIC show how long it takes to write and then read a 64K-byte sequential text file to a 20-megabyte hard disk. (For the program listings, see BYTE's *Inside the IBM PCs*, Fall 1985, page 195.) The Sieve graph shows how long it takes to run one iteration of the Sieve of Eratosthenes prime-number benchmark. The Calculations graph shows how long it takes to do 10,000 multiplication and 10,000 division operations using single-precision numbers. The 40K Format

Disk Copy benchmark was not performed because the computers had only one floppy disk drive. The 40K File Copy graph shows how long it takes to copy a 40K-byte file from a floppy to a hard disk using system utilities. The Spreadsheet graphs show how long it takes to load and recalculate a 100-row by 25-column Microsoft Multiplan (1.10) spreadsheet in which each cell equals 1.001 times the cell to its left. All BASIC benchmark programs were run with MS-DOS 3.10 and GW-BASIC 3.0.

softer feel than the PC AT's and give very little audible feedback. However, by pressing the Ctrl/Alt/+ key combination, you can increase the volume of a software-generated click from low to full volume over a range of 15 distinct levels. The Ctrl/Alt/- key combination decreases the volume.

The tightly coiled cable that connects the detached keyboard to the main unit begins to pull the keyboard out of your grasp when you try to get farther away than about two feet from the main unit. This is a nuisance if you like to type on your lap. Also, the cable runs diagonally from the left rear of the keyboard to the right front of the computer; you can't move the keyboard away from the main unit without the cable's tending to twist it clockwise. The bottom rear of the keyboard has two small plastic feet that flip out and raise it about $\frac{3}{4}$ inch.

High-Horsepower Hardware

The Portable III is made for speed. Its 80286 runs at 12 MHz, a speed unmatched by many full-size desktop computers. You can use the Ctrl/Alt/ \ (backslash) key combination to toggle between 12 and 8 MHz, or you can use Compaq's AUTO mode, which allows the 80286 to run at 12 MHz and automatically switch to 8 MHz when accessing the floppy disk drive to avoid copy-protection-scheme compatibility problems. The boards in the optional external expansion unit operate at 8 MHz (with the 80286 at either 12 or 8 MHz). The machine has no hardware reset switch for rebooting the system when the normal Ctrl/Alt/Del combination won't bail you out. In these cases, you must then turn the power switch off and on.

The optional 80287 coprocessor runs at 8 MHz regardless of the speed of the 80286, and the 640K bytes of RAM are made up of 100-ns 256K-bit chips. The RAM chips are mounted nine to a card and come in half-size DIP packages with connector pins at the ends and on the sides. They are mounted on the cards side-by-side and on top of each other, overlapping in a space-saving shingle-like fashion. Compaq uses CMOS gate arrays with surface-mount technology to implement six ASICs (application-specific integrated circuits) of its own design—three work with the 80286 to improve processing speed, one acts as the hard disk controller, one works with the floppy disk drive and the printer-interface controller, and one is for the gas-plasma display. All the system components, including the disk controller and display adapter circuits, are mounted on one system board (see photo 1).

The only empty area inside the tightly

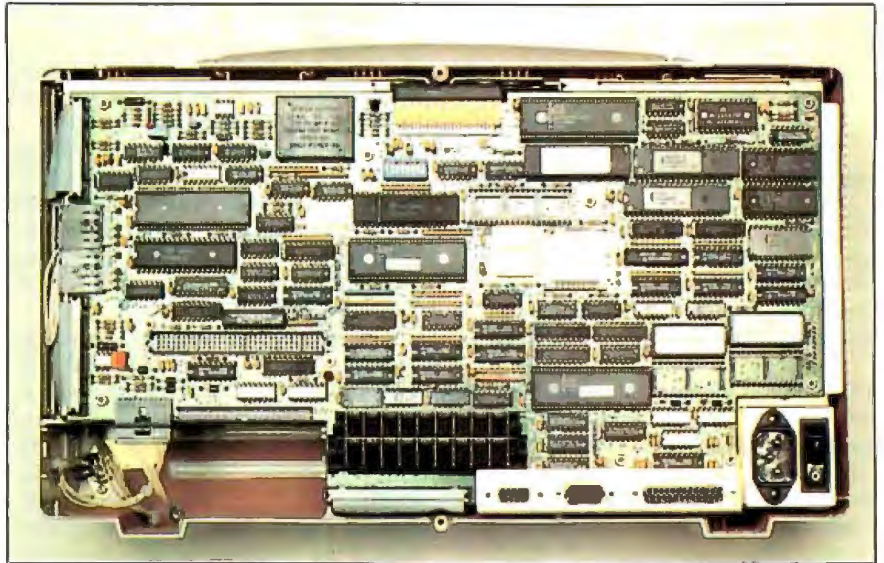

Photo 1: The internal configuration of the Portable III Model 20.



Photo 2: The rear view of the Portable III Model 20. Note the various ports, the sliding cover over the 96-pin port, and the machine's built-in padded handle.

packed machine lies beneath the two disk drives, where the optional internal modem and RAM expansion slots are located. Once the memory-expansion board is installed, you can choose one of two possible memory-upgrade paths with 100-ns chips: The first uses 256K-bit RAM chips and consists of three modules of 512K bytes each; the second has 1-megabit RAM chips, and each of the three modules adds 2 megabytes to the system. The total amount of RAM available with the first option is 2.1 mega-

bytes; the second option provides an impressive total of 6.6 megabytes of high-speed memory.

The internal modem and the memory-expansion board fit on the same internal memory/modem interface card. If you order either option, you also receive the interface card.

The power supply is rated at 145 watts and is adequate to power not only the internal components, but also any other add-on boards you might want to install in

continued

The display is as sharp as that found on any standard CRT.

the two-slot external expansion unit that attaches to the rear of the machine. The Portable III also has a small, quiet fan to pull cooling air in through the rear of the computer and exhaust it out the left side.

One of the Portable III's most interesting options is the external expansion unit, which is electrically connected to the computer by a 96-pin port (see photo 2). This unit is a more flexible option than the completely detached expansion units made for other portables. Because it gets its power from the computer via this port, you can securely attach it to the Portable III, leave it in place, and carry it with you as if it were part of the machine. You can also have more than one expansion unit configured for different needs, allowing considerable versatility. The expansion unit adds 2½ inches to the depth of the Portable III. Compaq's enhanced color graphics board is not an internal option and, if installed, must be used in the external expansion unit. It is compatible with IBM's EGA. I did not test any expansion boards with my review unit.

Dual-Mode Gas-Plasma Display

The Portable III's gas-plasma screen displays clear, bright, orange-red pixels on an orange-tinted gray background. The display is as sharp and readable as that found on any standard CRT display and is steady and free from flicker. However, the 12-MHz microprocessor is so fast that when you scroll a long file with the TYPE command, the display becomes a blur; it's difficult to stop the scrolling where you want.

The display is thin—only about 1¼ inches thick. The screen surface is flat, so you must be careful about glare and reflections. For example, when bright lights or objects are in front of the screen, it can act like a mirror, making viewing difficult. The screen's aspect ratio is 1.6 to 1 (width to height), a bit larger than the 1.3 to 1 or 1.4 to 1 found on most CRTs but less than the aspect ratio on many laptop LCD displays, which generally ranges from the Toshiba T1100 Plus's 2.3 to 1 to the Bondwell 8's 3.1 to 1. (The Zenith Z-181 is unique to the laptop world with its 1.3 to 1 aspect-ratio screen.) The main impact of this difference is that the shapes produced on machines with other aspect ratios by graphics software written for a CRT will become more distorted as the aspect ratio

diverges further from 1.3 to 1 or 1.4 to 1. For example, pie charts produced by Reflex look a bit squashed on the Portable III's screen but are not as badly distorted as they would be on the average laptop.

A convenient dial located at the bottom right corner of the Portable III's front panel controls the display contrast and brightness. Although I used this control near its maximum level most of the time, I never felt as if I were running out of sufficient brightness.

The Portable III is highly compatible with the IBM PC AT: It runs IBM software and can use PC AT-type 16-bit bus-expansion cards in its external expansion unit. It ran my collection of IBM software, including WordPerfect, Reflex, Ready!, WordStar, Jet, and Starflight, without a hitch. The major incompatibility is in the monochrome gas-plasma display. Although it can display graphics with software that uses the IBM CGA 320 by 200 mode, the gas-plasma display has a more limited range of intensity and therefore cannot display the various shades of gray used by a monochrome CRT to emulate colors. However, you can add an external color monitor via the RGB port to display full-color software.

In text mode, characters are formed from a 640 by 400 matrix of pixels. Text is displayed in 80 columns by 25 rows; each character is derived from an 8- by 16-pixel matrix. The characters are not as sharp as those generated with the IBM Monochrome Display Adapter, but they are well formed and easy to read. The display shows all the normal monochrome text attributes except highlighting; that is, it displays normal, reverse-video, blinking, high-intensity, half-intensity, and underlined characters. I found it most effective to show highlighted text as half-intensity characters. For programs that use highlighting to distinguish between choices on a menu, the Portable III has two programs that allow you to display highlighted characters. One is an expanded version of the familiar Mode program that can use arguments that enable you to change the appearance of highlighted text. The other is a memory-resident program called ADAPT (Advanced Display Attribute Programming Tool), which you can use from within an application program to change the display. According to Compaq, the Portable III will come with a disk of supplemental programs, including ADAPT and Screen-Save, a program that lets you set an inactivity time limit at which the system will blank out the display. The supplemental disk was unavailable at the time of this review.

Besides the standard IBM text and graphics modes, the Compaq BIOS

includes a high-resolution (640- by 400-pixel) text/graphics mode for the gas-plasma display. You can access the 640 by 400 mode by calling mode 40h with the BIOS video interrupt 10h, the same as that used by the AT&T PC 6300 to access its 640 by 400 monochrome graphics. This means that you can use graphics-based software that has an AT&T PC 6300 high-resolution driver, such as Microsoft Windows or Borland's Reflex, to obtain the Portable III's high resolution. When I used Reflex's AT&T driver with the Portable III, Reflex displayed in 43-line text mode as well as 640- by 400-pixel high-resolution graphics mode. The Portable III also functioned perfectly with graphics software I have written specifically for the PC 6300's high-resolution mode.

Internal and External Peripherals

The Portable III Model 1 comes with a single 1.2-megabyte one-third-height 5¼-inch floppy disk drive. I had no trouble formatting or writing files to 360K-byte floppy disks with this drive, nor did I have any problem reading those files on my PC 6300's standard 360K-byte drive.

To use this computer to its fullest, you will need a hard disk of some kind. The performance of the Model 20's 20-megabyte hard disk at 12 MHz on the Write benchmark shows a 48 percent improvement over that of the 8-MHz IBM PC AT. Even at 8 MHz, the Model 20's increase is 29 percent (see the benchmark results on page 000). The Read benchmarks also show improvements, although they are more modest: 26 percent at 12 MHz and 2 percent at 8 MHz. Compaq rates its hard disk's access time at less than 30 ms; my tests measured an average access time of 26 ms.

Two LEDs located below the power indicator turn on when there is activity in either the floppy or the hard disk. The documentation says that the floppy disk's LED is supposed to be orange when the computer reads or writes to a 360K-byte disk and green when it accesses 1.2-megabyte floppies, but I got a green light regardless of the type of disk I used. Both drives are extremely quiet, and the only clue you have that the hard disk is doing anything is its blinking LED.

The Portable III comes with a standard Centronics-compatible parallel printer port with a 25-pin female connector and an RS-232C serial port with a 9-pin male connector like the IBM PC AT's. The CGA-compatible display card has a 9-pin female port for connecting an optional RGB monitor. The memory-expansion card and internal modem attach to an internal connector on the system board. The modem installation kit also includes

standard telephone jacks that are accessible on the right side of the computer beneath the disk drives. A sliding panel on the rear of the computer conceals a 96-pin male connector for attaching the external expansion box.

Documentation and Service

The documentation that came with my review unit was in preliminary form. Both the *Operations Guide* and the optional *MS-DOS Reference Guide* are essential for using the Portable III. (The MS-DOS guide comes with the optional MS-DOS 3.2 operating system.) The optional *Technical Reference Guide* is valuable if you want to access some of the machine's special features, such as writing software that manipulates the dual modes of the gas-plasma display, but you won't need it to operate the machine with regular software.

The Portable III has a one-year limited warranty for parts and repairs on the computer and internal options installed by an authorized Compaq dealer; external options such as the color monitor and the expansion unit are not covered under this warranty but have their own warranty coverage (usually 90 days). You can obtain warranty service from Compaq or an authorized dealer, but you are responsible for the transportation to Compaq or the dealer.

Performance and Portability

At the present time, there is nothing else available in a portable with the computing power of the Compaq Portable III. The 12-MHz 80286 microprocessor, large potential memory capacity, and fast hard disks make this machine a stunning performer. The Sieve and Calculations benchmarks show that the computer is significantly faster than an 8-MHz IBM PC AT. Because of obvious similarities—the gas-plasma display, 80286 microprocessor, and internal hard disk—this microcomputer will inevitably be compared to the Toshiba T3100. The T3100 is smaller, five pounds lighter, and, although it needs an AC power source like the Portable III, it looks and feels more like a true laptop. However, the T3100's 10-megabyte hard disk drive has a slower average access time (between 80 and 90 ms) and microprocessor (8 MHz). The Portable III Model 20 clearly outperforms the T3100; however, it also costs \$800 more.

The Portable III does not sacrifice performance for portability. While Compaq designed it as a carryon, you can add options such as the two-card expansion unit, internal memory expansion and modem, and desktop pedestal to make it into a full-featured desktop machine. ■

Computers For The Blind

Talking computers give blind and visually impaired people access to electronic information. The question is how and how much?

The answers can be found in "The Second Beginner's Guide to Personal Computers for the Blind and Visually Impaired" published by the National Braille Press. This comprehensive book contains a Buyer's Guide to talking microcomputers and large print display processors. More importantly it includes reviews, written by blind users, of software that works with speech.

Send orders to:

**National Braille Press Inc., 88 St. Stephen Street
Boston, MA 02115, (617) 266-6160**

NBP is a nonprofit braille printing and publishing house.

For IBM® PC's, XT's, AT's and other DOS machines. This is the one you've heard so much about—with faster compile times than many COBOL compilers costing hundreds of dollars more! It's based upon ANSI-74 standards. Now comes standard with source code programs demonstrating full screen, cursor control, color, reverse video, etc., another program shows how to even reprogram your keyboard and much more.

Don't let our mail order prices fool ya! This is a new improved version of our best selling COBOL compiler previously offered at \$300.00 a copy. Look at the December 1979 issue of Byte Magazine for one of our first COBOL ads!

Other outstanding values at \$39.95 are: Utah FORTRAN, Utah BASIC, Utah PASCAL, Utah PILOT and Utah EDIT. Used by 50,000 professionals, students, and teachers in 40 countries.

To order:
(702) 827-3030

SINCE 1977
ELLIS COMPUTING™

IBM is a registered trademark of International Business Machines.

Ellis Computing, Inc. • 5655 Riggins Court, Suite 10 • Reno, Nevada 89502

Every good b a double

The corporation wants power.
Individuals want ease-of-use.
Put those two qualities in a single
database and what have you got?
The overwhelming
industry standard.

And the standard
that won't overwhelm
individuals.
dBASE III PLUS™ from

Ashton-Tate.®

More corporations choose it than all
the other databases combined. Because
they want broad compatibility across the
whole company. And true networking
capability. And the opportunity to unify
their support and training resources.
In short, they want one product that's
flexible and powerful enough to meet the
needs of all.

And with dBASE III PLUS, they get it
all. Plus the broadest third-party support



The Industry Standard

in the industry. You see, more applications
are written for dBASE® than for any other
database. So in many cases, the appli-
cations you need are already available.

More individuals choose dBASE as well.

Because we've made it easier for
individuals to use. Particularly the sort
who get queasy when they think they
might have to program.

They can start using dBASE without

business needs standard.

ASHTON · TATE

dBASE III PLUS

The data management standard.



The Individual's Standard

any programming experience. Because the Assistant feature, with its pull-down menus, guides them step-by-step through the creation and use of a database.

When they're ready to create applications, our Applications Generator writes the code.

And to make the complex even simpler, we have catalogs that let them recall relationships among files with a single

command. Complex commands can also be stored for automatic use by our "history" capability.

Best of all, we've added these ease-of-use features without alienating the people who made dBASE the industry standard



in the first place. The advanced users and programmers. Who still get all the power and programming features they need to develop their sophisticated applications.

So if you're looking at databases from either the corporate or the individual perspective, your choice is simple.

dBASE III PLUS.

Or dBASE III PLUS.

For the authorized Ashton-Tate dealer nearest you call (800) 437-4329, Ext. 282.*

 ASHTON · TATE®

*In Colorado and outside of the U.S., call (303) 799-4900, Extension 282. Trademarks/owner: dBASE, dBASE III PLUS, Ashton-Tate/Ashton-Tate. © 1986 Ashton-Tate. All rights reserved.

Integrating All Your Necessities in a Single Board

JUKO G7-A MULTI-DISPLAY AND I/O ADAPTER

- IBM Color Display Adapter compatible
- Hercules™ Mono Graphics Card compatible (720x348 pixels)
- Connects to composite Mono/Color Monitor
- Connects to 640x400 Hi-Res Color Monitor
- Connects to PAL+ / NTSC / SECAM+ system TV
- Microsoft™ Bus Mouse compatible interface
- Parallel printer port and game port
- Light pen interface
- One year warranty

For use with IBM PC, PC/XT, PC/AT and compatibles

JUKO G7-B Super MULTI-DISPLAY AND I/O ADAPTER

- IBM Color Display Adapter compatible
- Hercules™ Mono Graphics Card compatible (720x348 pixels)
- Connects to composite Mono/Color Monitor
- Connects to 640x400 Hi-Res Color Monitor
- Connects to PAL+ / NTSC / SECAM+ system TV
- Microsoft™ Bus Mouse compatible interface
- Parallel printer, game, serial ports
- Floppy Disk Drive controller
- Clock/Calendar standard
- Light Pen interface
- One year warranty

For use with IBM PC, PC/XT and compatibles

+ JUKO G7 (PAL/SECAM) version only



Suggested USA retail price

JUKO G7-A US\$98.00

JUKO G7-B US\$160.00



JUKO ELECTRONICS INDUSTRIAL CO., LTD.

Flat A, 7th Floor, CDW Building, 388, Castle Peak Road,
Tsuen Wan, Hong Kong. Telephone: 0-4114701
Telex: 52432 NDYEL HX Fax: 0-4993486

U.S.A.

Advantech Corporation Tel: 617/481-6009 Fax: 617/481-5215 Telex: 251100

Canada:

MNM Sales Tel: (514) 738-6580 Fax: (514) 487-2187 Telex: 055-66314

V-Com Technology Ltd. Western Tel: (604) 266-1113 Eastern Tel: (416) 817-8113

Netherlands:

Scop International BV Tel: 03402-44144 Telex: 47172

Singapore:

Logitec Electronics (S) Pte. Ltd. Tel: 344-2020 Fax: 345-8335 Telex: 60710

IBM PC, XT & AT are trademarks of International Business Machines.
Hercules™ is a trademark of Hercules Computer Technology.
Microsoft™ is a registered trademark of Microsoft Corporation.
Specifications are subject to change without notice.



The Commodore 64C

Alastair J. W. Mayer

*Commodore's latest
personal computer is a C-64
in new clothing*

The Commodore 64C personal computer is simply the old Commodore 64 repackaged in a beige C-128-style case and bundled with the disk-based GEOS (graphic environment operating system) version 1.3. The GEOS is a surprisingly good window and icon operating system, considering that it runs on an 8-bit microprocessor in 64K bytes of memory. The combination sells for \$229.95; you can purchase the GEOS software separately for \$59.95 if you already own a C-64 or a C-128. The 64C's case is more attractive than that of the C-64, and the mechanical action of the keyboard is slightly more responsive, though it is still not great.

For those not familiar with the hardware of the C-64, both it and the 64C use the 6502-compatible 6510A microprocessor running at 1.02 MHz. (For more information, see the review of the Commodore 64 by Stan Wszola in the July 1983 BYTE.) It has 20K bytes of ROM, which contains the operating system and the BASIC interpreter version 2.0; 64K bytes of RAM; 320- by 200-pixel graphics; up to 16 colors (although the graphic modes restrict your choices); an impressive three-voice Sound Interface Device (SID); and, alas, a slow serial disk interface, although the GEOS uses some proprietary techniques to speed this up.

Some recent additions to the line of peripherals available from Commodore for the 64C are the 1541C disk drive (\$229) which, internally, is the same as the 1541, but it has a beige case to match that of the 64C. The 1351 two-button mouse (\$49), which can operate in either proportional or joystick mode, is quite an improvement over the 1350 two-button mouse, which could operate only in joy-



stick mode. In joystick mode, the 1351 mouse transmits joystick-like commands to the computer, for example, move up, move down, move right, and move left, depending on which direction you move the mouse. In proportional mode, the mouse knows and transmits its position as an analog signal (in modulo 64) to the computer. A proportional mouse is more responsive, but the joystick mode is provided for use with joystick-compatible software. The 1802 color monitor (\$249) accepts both composite and RGB video signals and has a button on the front that changes the screen to green. According to Commodore, the 1764 RAM expander (\$149), which boosts the system RAM to 256K bytes, will be available this spring. This expander, a cartridge that plugs into the cartridge/expansion port, comes with an external power supply. Due to limita-

tions of the built-in BASIC interpreter, the extra RAM is accessible only if you use machine language programs or PEEKs and POKEs, or you can use it as a RAM disk.

GEOS—The 64C Does Windows

GEOS, developed by Berkeley Softworks, is an icon-oriented system similar to the Xerox PARC model popularized by the Macintosh. It provides windows and icons, and you can control it by using the cursor keys, a mouse, or a joystick. Drivers are also included for bit pads, such as the Koala Pad, and for light pens.

Berkeley Softworks has implemented a copy-protection scheme wherein you must always boot from the original GEOS disk. The first thing that you should do when you start working with GEOS is make a backup of the system disk so that if you accidentally delete or otherwise lose a file on the original disk, you can restore it from the backup. However, if the original disk gets physically trashed, you are out of luck. Once you've backed up the GEOS disk, you must create a work disk—a pared-down system disk that you can use once you have loaded GEOS.

GEOS comes on one double-sided disk. On one side is the GEOS operating system, geoPaint, and geoWrite, and on the opposite side is a telecommunications program, Q-Link, for accessing QuantumLink (a bulletin board designed spe-

continued

Alastair J. W. Mayer is a member of GeoVision Corp. (1600 Carling Ave., Suite 350, Ottawa, Ontario, Canada K1Z 8R7), a developer of geographic information systems. He is also the author of CoSy, the BIX conferencing software.

GEOS is impressive, considering it's used on a five-year-old, 8-bit computer.

cifically for Commodore users). The GEOS provided with the 64C also includes a tailored work disk.

Desktop and Accessories

The GEOS desktop (see photo 1) consists of a pull-down menu bar along the top, icons representing the disk drive or drives, a wastebasket and printer, and a Disk Notepad window, initially showing icons for the active disk. The Disk Notepad window works a little differently than that on the Macintosh or the Atari ST. On the latter machines, the disk window is a viewport for a larger area. If there are too many file icons to fit the display all at once, you can scroll the Disk Notepad window up and down or sideways. In GEOS, the Disk Notepad page has room for eight files, and its size and position on the screen are fixed. The technique GEOS uses is to let you "flip the pages" of the window as though it were a book. While the GEOS desktop is not as versatile or elegant as that of the Macintosh or Atari ST, it's pretty impressive when you remember that GEOS is implemented on a five-year-old, 8-bit computer. The Macintosh and the Atari ST both use the 32-/16-bit 68000 microprocessor; the

Macintosh has been around for only about two years, and the Atari ST for one year.

The desk accessories provided with the 64C are a notepad, a calculator, and a preference manager (similar to the Control Panel of the Macintosh) that allows you to set the time and date; set the velocity or edit the shape of the pointer; change the background, foreground, border, or pointer colors; and reset the values back to the standard GEOS default value. The photo manager and text manager enable you to cut and paste pictures and text among different applications.

The "language" of mouse-button clicks and moves is similar, but not identical, to that used by the Macintosh and the Atari ST. As with the other systems, double-clicking on an icon on the 64C will open that file or activate that application. However, with the other two systems, you hold the mouse button down throughout the entire operation, using a technique commonly referred to as press-drag-release. With GEOS, you do not hold the mouse button down throughout the entire operation; instead, dragging an icon (or a drawing in the paint program) is done by clicking once, moving the mouse, and clicking again (called a click-drag-click). The problem with this procedure is that if you are a little slow in double-clicking to open an application, GEOS may instead interpret this as a click-drag-click.

You can run Commodore's BASIC interpreter from the GEOS desktop by choosing "BASIC" from the menu. GEOS replaces the default nonmaskable

interrupt vector with the reboot code vector for the desktop, which is located between C000 and C100 hexadecimal. This enables you to reboot the desktop from the original GEOS disk by pressing the Restore key. It takes the same amount of time to reload the GEOS desktop whether you type LOAD "GEOS",8,1 or hit the Restore key; however, the latter method saves you some keystrokes.

If your BASIC program is smaller than 26K bytes, the GEOS will be able to use some of its techniques for speeding the program's load into memory. Otherwise, you use the normal Commodore DOS routines.

While Berkeley Softworks will not disclose the techniques it uses to speed up the serial drives, one well-known technique is to use the clock line as a data line, which gives you two data lines going into the drive, and then to asynchronously send information to the disk drive. You can also shorten the software timing loops used to control this process. Shortening the timing loops may make the serial transfer more prone to noise, but this has not been a problem from my experience.

Since the GEOS is necessarily disk-based, it is somewhat limited by the serial disk drives. The software speedups that Berkeley Softworks includes with GEOS help some. It also helps if you have a second disk drive. Installing the second drive is simple; if it is configured as a peripheral other than unit 8, nothing further needs to be done. Otherwise, you turn the drives on one at a time, selecting "install drive" from the pull-down menu before turning on the second drive. Having two drives is almost a necessity if you are going to make extensive use of geoPaint: On a single-drive system, the software insists that a copy of the program must exist on the same disk as the data files. (Copying geoPaint is permitted; only the GEOS kernel is copy-protected.)

GeoPaint version 1.2, a paint program, and geoWrite version 1.2, a word processor, are easily integrated with GEOS; you simply double-click on their respective icons. GeoPaint provides a window onto a full 8½-by 11-inch page and enables you to combine images and text on a document. A full array of brush styles, fill patterns, and colors is provided, although I had occasional problems with color due to the way the 64C's graphic modes work: The screen can contain all 16 colors at once, but any 8-by 8-pixel region is restricted to two colors in high-resolution mode, and 4-by 8-pixel regions are restricted to four colors in medium-resolution mode.

GeoWrite comes with a small font library. You can display a variety of text

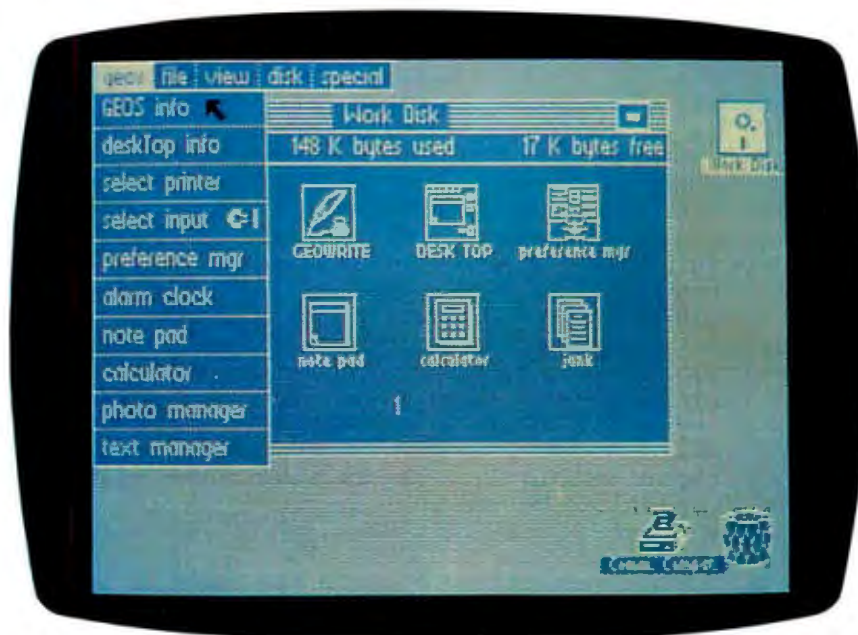

Photo 1: The GEOS desktop.

Commodore 64C**Company**

Commodore Business Machines Inc.
1200 Wilson Dr.
West Chester, PA 19380
(215) 431-9100

Size

16 by 8 by 3 inches

Components

Processor: 6510A running at 1.02 MHz
Memory: 20K bytes of ROM; 64K bytes of RAM, expandable to 256K bytes
Mass storage: See Options
Display: 40-column by 25-row text; 320- by 200-pixel high-resolution graphics
Keyboard: 66-key Commodore 64-style keyboard; four function keys; keyboard-selectable graphic characters and character colors
I/O interfaces: Two 9-pin control ports; 44-pin bus-expansion port; RF output; video, serial, cassette, and general-purpose user ports

Software

BASIC 2.0 in ROM; GEOS 1.3 operating system; geoWrite 1.2; geoPaint 1.2; QuantumLink V.4 Telecom

Options

1764 RAM expander: \$149
1802 color monitor: \$249
1541C disk drive: \$229
1351 mouse: \$49
GEOS software: \$59.95

Documentation

Commodore 64C Introductory Guide, 32 pages
Commodore 64C System Guide, 198 pages
GEOS and QuantumLink User's Guide, 126 pages
The Official GEOS Programmer's Reference Guide, 340 pages

Price

\$229.95

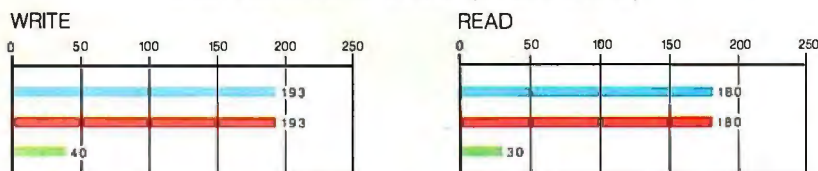
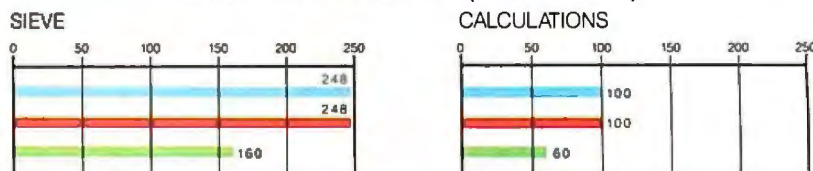
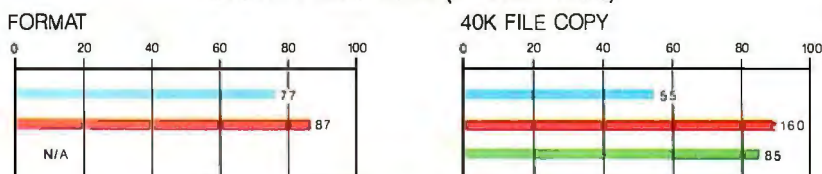
DISK ACCESS IN BASIC (IN SECONDS)**BASIC PERFORMANCE (IN SECONDS)****SYSTEM UTILITIES (IN SECONDS)**

■ 64C WITH GEOS ■ 64C WITHOUT GEOS ■ C-128

The graphs for Disk Access in BASIC show how long it takes to write and then read a 64K-byte sequential text file to a blank floppy disk. (For the program listings, see *BYTE's Inside the IBM PCs*, Fall 1985, page 195.) The Sieve graph shows how long it takes to run one iteration of the Sieve of Eratosthenes prime-number benchmark. The Calculations graph shows how long it takes to do 10,000 multiplication and 10,000 division operations using single-precision numbers. The System Utilities graphs show how long it takes to format a disk using the 1541C drive. Also shown is the time required to copy a 40K-byte file using the system utilities. The times for the Commodore 128 with a 1571 drive are shown as a comparison.

fonts simultaneously on the 64C's screen with GEOS, since it uses the graphic screen rather than the character screen. You can also print these text fonts.

Setup and Documentation

The 64C comes with a 32-page *Commodore 64C Introductory Guide*, which describes the various components: the monitor, disk drive, and all the necessary cables. Setup is quite easy; it is simply a matter of plugging the cables into the only connectors that they will fit and then turning everything on. The power transformer is a separate unit, as are the disk

drive and the monitor. This can make for a bit of a cable snarl, and, when everything is set up, there is little clear space left on a desktop. A separate shelf for the monitor and disk drive is definitely recommended.

Also included with the 64C is a 198-page *Commodore 64C System Guide*, subtitled "Learning to Program in BASIC 2.0." The book includes examples of the various BASIC commands, as well as short sample programs for using the 64C's graphics and sound capabilities. These use a lot of PEEKs and POKEs; BASIC 2.0 does not have built-in com-

mands to manipulate graphics and sound. A novice programmer may want to look for something more tutorial about programming in general, and any programmer interested in digging into the system will want the separately available *Commodore 64 Programmer's Reference Guide*.

The GEOS documentation is quite good, containing many examples. The 64C comes with a 126-page *GEOS and QuantumLink User's Guide* for those people interested in writing GEOS applications. This manual is not recom-

continued



Copying diskettes will never be easier than pushing one button.

While your computer is busy doing other things, your Victory Duplicator can be making as many as eight copies of a diskette at once —producing up to 400 copies in an hour. DualMaster™ models can even make multiple copies of two different diskettes simultaneously. Just insert the diskettes and press one button.

Copy different formats, flawlessly.

An automatic format analysis program makes it possible for the Victory Duplicator to

copy virtually any 5¼, 3½ or 8-inch diskette. The system tests for quality and accuracy at every stage of the process.

It practically services itself.

Each drive has a separate controller to maximize up-time. Simple diagnostics to verify drive alignment and industry standard drives allow you to maintain your system without waiting for outside service.

All at an attractive price.

Victory Duplicators offer fast copying, serialization,

copy protection, a communications port, a four-month warranty and much more—all for one low price.

Call 1-800-421-0103.

Call today for more information. (In Texas, call 512-450-0801.)



VICTORY ENTERPRISES

Technology, Inc.

8910 Research Blvd., Suite B2
Austin, Texas 78758

Come see us at Fall COMDEX.

REVIEW: COMMODORE 64C

mended reading for the casual user, however, unless he or she has an interest in making system calls. Also included with the 64C is a 340-page manual entitled *The Official GEOS Programmer's Reference Guide*.

Benchmarks

The system that I reviewed included two 1541C disk drives, a 1902A composite/RGB monitor, the 1351 mouse, and GEOS version 1.3. Since the hardware of the 64C is the same as that of the C-64, I ran the benchmarks of the 64C with and without GEOS and compared these results to those from tests on the C-128. The BASIC benchmark results for the 64C were the same whether BASIC was entered from the GEOS menu bar or directly from boot-up. The System Utilities test results show the effect of the GEOS speedup on the serial access of the drive. See page 231 for the benchmark results.

The Bottom Line

The Commodore 64C is an attractive restyling of the venerable Commodore 64. It has the C-64's built-in BASIC, a vast library of software, and impressive sound and graphics capability for an 8-bit, 64K-byte machine. The serial disk drive is a bottleneck that is alleviated somewhat by tricks used in GEOS. The inclusion of the GEOS graphic environment with the 64C is a smart move on Commodore's part, and it will also breathe new life into the C-64. However, Commodore should bundle the mouse with the 64C, as it is a much better way of interacting with GEOS than the cursor keys.

The GEOS itself is worth serious consideration by any C-64 or C-128 owner who is not entirely comfortable with those systems' rather primitive command interfaces but is not ready to upgrade to a completely new machine. The geoPaint and geoWrite programs also make an upgrade to GEOS an attractive consideration. The copy protection on the kernel disk is a negative factor, however.

Still, the 64C is only an 8-bit, 64K-byte machine. Even with a RAM upgrade to 256K bytes, this computer still does not have the graphics capability or computing power of the newer 68000-based machines. With BASIC included in ROM and the GEOS, the 64C is an attractive entry-level system for the new user, and, with the existence of more than a million Commodore 64s, you'd hardly have to worry about the 64C becoming an "orphan." However, if you'll want to expand your system significantly or if you get frustrated by slow disk drives, you would do well to balance the cost against the extra power of some of the newer Amiga, Macintosh, or Atari 1040ST systems. ■

A CROSSTALK[®] XVI SuperKlone™



MIRROR™ provides:

- Crosstalk XVI compatibility
 - Background communications
 - Built-in text editor
 - Learn-mode for automatic script file generation
 - Transaction log
- AND MUCH MORE...

MIRROR™
\$69.95

Site Licensing Available
60-Day Money-back Guarantee
Not Copy Protected

MIRROR is available for the IBM PC/XT/AT and compatibles running MS-DOS 2.0 or higher. MIRROR™, SuperKlone, KloneWare and SoftKlone are trademarks of Software Distributing Corporation. Crosstalk XVI and MicroSoft are registered trademarks of Microsoft, Inc.



1210 E. Park Ave., Tallahassee, FL 32301
For information call 1-904-878-8564
TXL 6714280 KLON

Shipping/handling 5.00
(COD orders add \$3.00)
International shipping/handling..... 18.00
Florida residents must add 6% sales tax

To Order Call (904) 878-8564

Distributed in Canada by:
Saraquely Software Distributors
Telephone (416) 923-1000

Distributed in Scandinavia by:
LINC (Norway)
Telephone 07 38 39 10

Distributed in the UK by:
Management Data Processing Ltd
Telephone (0225) 60491
Irish Ltd Telephone (0276) 3021

Distributed in Australia by:
Delta Computer Systems Pty. Ltd.
Telephone (03) 633-4255
P.O. Boxes Pty. Ltd.
Telephone (03) 319-2655

FEATURES STANDARD WITH US, OTHERS DON'T EVEN OFFER AS OPTIONS.

Take our ARC Turbo 12,
for example.

Take its speed. The fastest
off-the-shelf AT™ compati-
ble you can buy. (12.5 MHz,
50% faster than IBM.™)

Take the ARC Turbo 12's
exclusive MIPS Meter™
which gives you a digital
read out of the actual
number of millions

of instructions per second
currently being processed.

And take ARC's
unmatched reliability. Which
is what you'd expect from
one of the fastest growing
computer manufacturers.

We back our equipment
with a two-year limited
warranty, the longest in the
industry. Each
unit also comes

with 90 days of Free on-site
service. And our technical
support Hot Line gives you
direct access to our expert
staff.

Ask your ARC Author-
ized Dealer for all the
details. (For a list, call
800-654-6151.)

It's a fast world. With
ARC, it won't pass you by.



ARC American
Research
Corporation
In California: (213) 265-0835.

**COMPATIBLE DESIGN.
INCOMPARABLE PERFORMANCE.
INCREDIBLE VALUES.**

In three years, PC's Limited has revolutionized the way America buys personal computers by manufacturing demonstrably better systems and then selling them directly to end users at remarkably low prices. That's why we've shipped tens of thousands of computers to date.

It's also why the trade press has praised our machines with comments like "a perfect tool" and "an incredible value." And it's no wonder. Because PC's Limited gives you more speed with 8 and 12 MHz machines. Plus a megabyte of high-speed RAM. We provide SmartVu™, an exclusive alphanumeric display that gives you real-time diagnostics. And you even get your choice of chassis sizes, plus a wide selection of drives, monitors, and add-on boards.

What's more, we back what we sell with industry-leading free 800-line technical support, an unconditional 30-Day Money-Back Guarantee, and a full One-Year Limited Warranty.

Right now, you can select from a wide variety of fully configured systems at dramatically reduced prices. If you are just getting acquainted with us, there's never been a better time to find out what you've been missing. Because with PC's Limited, everyone can afford to be a power user.



PC'S LIMITED TURBO PC™

Monochrome Systems

- Intel 16-Bit 8088-2 System Unit running at 4.77 MHz and 8.0 MHz
- 640K on Motherboard
- AT™-Style Keyboard
- 130 Watt Power Supply
- Hercules Compatible Graphics Adapter with one Parallel Port
- PC's Limited Mono-I High Resolution Monochrome Monitor

with one 360K Floppy Disk Drive—**\$799**

with one 360K Floppy Disk Drive and one 20 Meg, 65 MS Hard Disk Drive—**\$1199**

EGAds! Color Systems

- Intel 16-Bit 8088-2 System Unit running at 4.77 MHz and 8.0 MHz
- 640K on Motherboard
- AT™-Style Keyboard
- 130 Watt Power Supply
- PC's Limited EGAds! Card
- PC's Limited EGAds! Monitor

with one 360K Floppy Disk Drive and one 20 Meg, 65 MS Hard Disk Drive—**\$1699**

with one 360K Floppy Disk Drive and one 40 Meg, 40 MS Hard Disk Drive—**\$2199**

PC'S LIMITED 286⁸

Monochrome Systems

- Intel 80286 running at 8 MHz
- 1024K on Motherboard
- 1.2 Meg Floppy Disk Drive
- Combined Floppy and Hard Disk Controller
- AT™-Style Keyboard
- 192 Watt Power Supply
- Clock/Calendar with Battery Backup
- Hercules Compatible Monochrome Graphics Card
- 2 Serials and 2 Parallel Ports
- PC's Limited Mono-I High Resolution Monochrome Monitor
- SmartVu™ (Real Time Diagnostic Display)

with 20 Meg, 65 MS Hard Disk Drive, Space Saving Chassis—**\$1799**

with 40 Meg, 40 MS Hard Disk Drive, AT™ Standard Chassis—**\$2249**

EGAds! Color Systems

- Intel 80286 running at 8 MHz
- 1024K on Motherboard
- 1.2 Meg Floppy Disk Drive
- Combined Floppy and Hard Disk Controller
- AT™-Style Keyboard
- 192 Watt Power Supply
- Clock/Calendar with Battery Backup
- PC's Limited EGAds! Card
- 2 Serials and 1 Parallel Port
- PC's Limited EGAds! Monitor
- SmartVu™ (Real Time Diagnostic Display)

with 20 Meg, 65 MS Hard Disk Drive, Space Saving Chassis—**\$2299**

with 40 Meg, 40 MS Hard Disk Drive, AT™ Standard Chassis—**\$2749**

PC'S LIMITED 286¹²

Monochrome Systems

- Intel 80286 running at 12 MHz
- 1024K on Motherboard
- 1.2 Megabyte Floppy Disk Drive
- Combined Floppy and Hard Disk Controller
- AT™-Style Keyboard
- 192 Watt Power Supply
- Clock/Calendar with Battery Backup
- Hercules Compatible Monochrome Graphics Card
- 2 Serials and 2 Parallel Ports
- PC's Limited Mono-I High Resolution Monochrome Monitor
- AT™-Standard Chassis
- SmartVu™ (Real Time Diagnostic Display)

with 40 Meg, 28 MS Hard Disk Drive—**\$2999**

with one 80 Meg, 28 MS Hard Disk Drive—**\$3399**

EGAds! Color Systems

- Intel 80286 running at 12 MHz
- 1024K on Motherboard
- 1.2 Megabyte Floppy Disk Drive
- Combined Floppy and Hard Disk Controller
- AT™-Style Keyboard
- 192 Watt Power Supply
- Clock/Calendar with Battery Backup
- PC's Limited EGAds! Card
- 2 Serials and 1 Parallel Port
- PC's Limited EGAds! Monitor
- AT™-Standard Chassis
- SmartVu™ (Real Time Diagnostic Display)

with 40 Meg, 28 MS Hard Disk Drive—**\$3499**

with one 80 Meg, 28 MS Hard Disk Drive—**\$3899**

A GUARANTEE THAT STANDS UP.

PC's Limited has established itself as the leader in PC technology. And the guarantee and warranty programs we offer put us ahead of the pack, too. Here are our terms in plain English.

30-Day Total Satisfaction Guarantee—Any item bought from PC's Limited may be returned within 30 days from the date it was shipped for a full refund of your purchase price. Returned items must be as-new, not modified or damaged, with all warranty cards, manuals, and packaging intact. Returned items must be shipped prepaid and insured, and must bear a PC's Limited Credit Return Authorization (CRA) on the shipping label.

One Year Limited Warranty—PC's Limited warrants the products it manufactures to be free from defects in materials and workmanship for one year following the date of shipment from PC's Limited. During the one year warranty period, PC's Limited will repair or replace, at its option, any defective products or parts at no additional charge, provided that the product is returned, shipping prepaid, to PC's Limited.



To buy PC's Limited computers, call us directly at . . . 1-800-426-5150
Calls inside Texas, 1-800-252-8336.

Sales lines open 7 a.m. until 7 p.m. Monday-Friday, 10 a.m. until 3 p.m. Saturday, Central Standard Time

1611 Headway Circle, Building 3, Austin, Texas 78754

Sales Calls from anywhere in the country, (512) 339-6962, Technical Support Calls, 1-800-624-9896 or PC's Limited BBS (512) 339-4127

Customer Service Calls, 1-800-624-9897 or MCI MAIL: PC's Limited, Telex No. 9103808386 PC LTD FAX (512) 339-6721

F 2

Introducing OptiLab™

The Complete Microprocessor Development Toolbox.

You need the right tools to speed completion of your project and improve its quality.

That's why we created the OptiLab toolbox. The tools you want for beginning-to-end development and optimization of microprocessor code. OptiLab's fully-integrated, PC-based system lets you debug, analyze, modify, optimize, and test code in a seamlessly integrated environment. You can add your own cross-assembler, too.

The star of the OptiLab is Program Performance Analysis that helps you uncover invisible bugs, eliminate unneeded code, and cure program inefficiencies. OptiLab runs in real-time, is non-intrusive, and gives you outstanding performance at a remarkably low price.

There's more. OptiLab's 48-channel analyzer lets you track bus state activity and trap bugs fast. Monitor your software as it executes in real time with

the full-featured 8/16-bit In-Circuit Emulator. Send test patterns with the Input Stimulus Generator and observe their effects. With the built-in EPROM Programmer, you can program devices without leaving OptiLab.

Orion offers you ready support for more than 150 different microprocessors. MicroTargets™ allow you to run and test your software even before you have working hardware. And our crack team of

Applications Engineers is standing by if you need assistance.

But here's the real news. OptiLab is priced under \$7,000. Or, you can start with a basic Orion system for as little as \$2,995 and add capabilities as you need them.

Call now for complete information on OptiLab or other Orion microprocessor development tools. All Orion products are sold with a 15-day money-back guarantee.

	WRITE
Analyzer	
In-Circuit Emulator	ASSEMBLE
Line-by-Line Assembler	
Debug Package	DEBUG
Performance Analyzer	
Stimulus Generator	TEST
EPROM Programmer	OPTIMIZE
	SHIP

OptiLab™

Everything from assembly to final optimization of your software can be done with the OptiLab toolbox.

OptiLab presents a graphical display of actual program performance.



ORION
INSTRUMENTS, INC.

Call Toll Free: 1-800-245-8500
In California: (415) 361-8883

Orion Instruments, Inc., 702 Marshall Street, Redwood City, California 94063, U.S.A. Telex: 530942

Inquiry 230



SCSI Hard Disk Drives for the Macintosh

Chris Crawford and Eva White

Before the Macintosh Plus, the only way to add a hard disk to a Macintosh was through the slow floppy disk drive or the serial port. Although no SCSI (small computer system interface) drives were available at the time the Mac Plus was announced, third-party companies have wasted no time in coming out with fairly inexpensive drives. The benchmark tests on the 10 external 20-megabyte SCSI drives reviewed here indicate that they are all roughly comparable in performance. (See the complete benchmark results in table 1.) The 10 drives are the SuperMac DataFrame 20 and XP 20, General Computer's HyperDrive FX/20, Relax Technology's Hard 20 Plus, the ProAPP 20, Western Computer's Big Mack Twinpack, Peripheral Land's PL20, Mirror Technologies' MagNet 20X, the LoDown 20, and Peak Systems' Plus-20. Potential buyers of hard disks should base their decisions on the support software provided (such as backup utilities and print spoolers), the drive's footprint, price, and, if expandability is important, the ease of daisy-chaining the drives.

Chaining SCSI Devices

One of the big selling points of SCSI devices is that you can daisy-chain up to seven of them together. Most SCSI devices come with two SCSI ports so that when you want to add another, you simply plug it into the unused port of the last one. Daisy-chaining these drives is fairly simple, but not without some drawbacks. Not all SCSI cables are alike. Some drives come with DB-25 SCSI ports and require a cable with a DB-25 connector on either end, while others come with 50-pin SCSI ports and require a cable with a DB-25 connector for plugging into the Mac and a 50-pin Ampherol connector on the other end for plugging into the drive. All the drives mentioned in this review come with their own cables, but you have to purchase a cable with 50-pin male connectors on both ends to chain the

*These 20-megabyte
units vary widely in most features
except benchmarks*

drives with 50-pin SCSI ports. The drives with the DB-25 connectors have the advantage since you can simply use the cables included with the drives to daisy-chain them together.

Once you have the right kinds of cables, you have to set the SCSI address of the drive. The HyperDrive FX/20 and the DataFrame XP 20 make this easy by allowing you to change the SCSI address with software. Two of the drives, the Big Mack Twinpack and the ProAPP 20, have DIP switches accessible on the outside of the drive case. All the other drives have jumpers on the SCSI controller card that you have to open the case to get to.

If you are chaining three or more drives, you must make sure the terminating resistor packs are present only on the drives on either end of the chain. The HyperDrive FX/20 comes with an external terminating resistor pack that you plug into the unused SCSI connector. The other drives have socketed resistor packs on the SCSI controller boards.

Distinguishing Characteristics

One problem with reviewing these drives is that the software, manuals, and, in some cases, even the drives themselves are changing rapidly. When we first received the review drives, much of the system software was buggy and unstable, and many of the manuals were photocopied 8- by 11-inch paper stapled in the upper left corner. Some of the manuals had diagrams that did not match the hardware. For example, the Peak Systems' Plus-20 manual explained how to chain drives, but it showed a picture of a controller board that looked nothing like the actual board inside the drive. According to the manual that came with the LoDown 20, there are plugs on the bottom of the

case that you can pop out to get to the jumpers. Unfortunately, on the model we reviewed, the holes did not line up over the jumpers and we had to open the case to get to them. According to LoDown, a redesigned case

will be shipped with later models.

Many of the manuals sidestepped the whole issue of daisy-chaining by recommending that only a service technician make any necessary changes. Each time we called the technical help line provided, we were able to locate the right jumpers and set the addresses. Also, in most cases, we got an updated manual and the latest system software.

SuperMac Technology has a faster version of its DataFrame 20 drive, the DataFrame XP 20, which is supposed to be faster for large contiguous transfers to and from the disk. A DataFrame XP 20 costs \$1299, but for \$149 you can obtain a kit that upgrades a DataFrame 20 to an XP 20. You simply install a new ROM in the drive and change a jumper to complete the transformation. We upgraded our DataFrame 20 for this review. The benchmarks show only a slight speedup for the Boot test and for opening a 67K-byte MacWrite file. We backed up 10 megabytes from the comparison non-SCSI Apple Hard Disk 20 onto the DataFrame 20, installed the upgrade, and backed up again. This didn't show any real speedup, either; the backup took 798 seconds on the DataFrame 20 and 776 seconds on the DataFrame XP 20.

The HyperDrive FX/20 comes with more system software than the other drives, is rugged, and has a built-in han-

continued

Chris Crawford (5251 Sierra Rd., San Jose, CA 95132) is a freelance computer game designer. He is the author of eight games, including Balance of Power, and three books. Eva White is a BYTE technical editor. She can be reached at BYTE, One Phoenix Mill Lane, Peterborough, NH 03458.

Table 1: SCSI drive features, bundled software, and benchmark results. All dimension sizes are in inches; footprint sizes are in square inches. All times are in seconds. The benchmark tests were performed using Apple's System 3.2 and Finder 5.2. The Boot test was timed from the sound of the "bong" on the Mac Plus to the appearance of the File, Edit, View, and Special menus. LineWrite writes a single linear file 512K bytes long; FileRead reads that file. FragWrite writes sixteen 2K-byte files and then appends fifteen 2K-byte sections onto them in an interleaved fashion. Microsoft BASIC version 1.0 was used for these tests. The file entitled "What's New," which is included with MacWrite version 4.5, was used in the 67K-byte MacWrite file test. For comparison, we also performed benchmarks on the non-SCSI Apple Hard

updates on hardware and software features.

Name	DataFrame 20	DataFrame XP 20	HyperDrive FX/20	Hard 20 Plus	ProAPP 20	Big Mack Twinpack
Company	SuperMac Technology				ProAPP Inc.	
LineWrite	76	80	89	88	89	85
LineRead	91	90	92	92	91	91
FragWrite	523	530	494	489	522	482
		145				
	Yes	Yes	Yes	Yes	Yes	No
	Yes	Yes	Yes	No	No	No
	Yes	Yes	Yes	Yes	Yes	No
	No	No	Yes	No	No	No
Price	\$1099			\$1195	\$1495	

dle. The design of the case gives the drive a lot of stability; it measures 3½ inches at the bottom and tapers off to 3 inches at the top. The FX/20 also lets you change the SCSI address in software.

Given that Relax Technology also re-tails surge-protected power strips, you might guess that its drive, the Hard 20 Plus, comes with a four-outlet, independently controlled power strip with a 30-decibel noise filter and surge and isolation suppression.

The Big Mack Twinpack comes with an integrated tape drive; it also comes with the most unstable system software of the group and a woefully thin manual entitled *Temporary Operating Manual*. A

call to Western Computer's technical help line did not get us a new manual or updated software. We used a Teac CT-5000 high-density cassette drive to back up 10 megabytes; this took about 6 minutes. If we erased the tape first and then backed up the drive, we got a system bomb. The drive backed up with no problems if we didn't erase the tape first. Only backups of the entire disk are possible.

The LoDown 20 is the only bottom-placement drive of the group without a fan. The case is made of pressed metal and has ventilation holes on the bottom, side, and top. Although the drive heated up, we left it on under a running Macintosh for a couple of days with no prob-

lems. The LoDown 20 comes bundled with scads of public domain software and shareware, though none of the software fell into the categories listed in table 1. These programs can save you the connect charges and phone bills required to download them from bulletin boards, but, if you decide you want to use these programs, you must be sure and check to see if the author requires a shareware fee.

Peripheral Land's PL20 and Peak Systems' Plus-20 are solid, basic drives. The ProAPP 20's selling point is that you can also hook it up to the Apple IIe/IIc line. The drive has three ports on the back—a SCSI port, a floppy disk port, and a printer port.

PL20	MagNet 20X	LoDown 20	Plus-20	Hard Disk 20 (Non-SCSI for comparison)
Peripheral Land	Mirror Technologies	LoDown	Peak Systems Inc.	Apple
8.2	8.1	8.9	8.5	9.7
79	88	79	89	84
90	90	90	92	89
500	478	476	490	558
141	136	136	139	147
14.3	13.6	14.1	13.2	18.5
Jumper	Jumper	Jumper	Jumper	N/A
50-pin	25-pin	25-pin	50-pin	N/A
Yes	Yes	No	Yes	N/A
No	Yes	No	No	N/A
No	Yes	No	Yes	N/A
No	No	No	No	N/A
No	No	No	No	N/A
9.5	5	9.5	9.5	9.5
9.5	9	9.5	11	10.5
3	3	3.5	3	3
90	45	115	104	100
Bottom	Side	Bottom	Bottom	Bottom
Yes	No	No	Yes	Yes
No	No	No	No	No
No	Yes	No	Yes	Yes
Internal	External	Internal	Internal	Internal
\$995	\$1095; \$1195 with MacServe	\$995	\$1095	\$1195

For an extra \$100, you can get Mirror Technologies' MagNet 20X bundled with Infosphere's MacServe disk server. If purchased separately, MacServe is a \$250 package. The MagNet 20X depends on the capabilities of MacServe for backup programs and print spooling. Both the ProAPP 20 and the MagNet 20X have external power supplies.

Software

The software included with these drives is where the differences in the drives really show (see table 1). This set is not all-inclusive; we included only what we considered to be relevant to this review.

Many of the drives include a head

parker, which moves the disk drive read/write head to an unused sector on the platter. The heads should always be parked before you move or ship a drive; this gives added protection to files when you shut off the drive.

The Imagewriter spooler on the Data-Frame 20 is superior to that on the HyperDrive FX/20. The Data-Frame 20's Imagewriter print spooler, SuperSpool, is accessible from a desk accessory, which allows you to view the status of your print jobs or delete and reorder individual jobs in the print queue. The HyperDrive FX/20's Imagewriter print spooler is accessible only from the desktop; you must leave your application to

get to it. While you can view each job, you cannot alter the job's order, and the only way to delete a job is to flush the whole queue. The MagNet 20X's Imagewriter spooler is part of the MacServe package bundled with that drive.

All the drives except for the LoDown 20 and Peripheral Land's PL20 have some sort of backup utility. We found those included with the Data-Frame 20 and the HyperDrive FX/20 easy to use. They both have incremental, individual-file, and volume backup. They also worked only with these drives. The ProAPP 20 has a very good backup utility, Quickbackup, which is licensed for ProAPP 20 users only. Relax Technology's Hard 20 Plus comes with a shareware backup program, HardSave version 1.1; you must send the author at least \$20 if you decide to keep it and use it. Hard-Save 1.1 can back up an entire volume or individual files and folders and then save the output of the backup program to a file. Peak Systems' Plus-20 comes with a backup program called Archiver that, according to a message on the program, is provided free by the author. We couldn't get Archiver to work, and the program has no help screens. The Big Mack Twinpack, being an integrated drive and tape-backup unit, does not need a backup-to-floppy program. The MagNet 20X's backup utility is part of MacServe.

The HyperDrive FX/20 is the only drive of this group that comes with a LaserWriter spooler. The program, LaserSpooler, consists of a printer resource that creates the PostScript file and a desk accessory that spools these files to the printer and shows you the printer's status. It took 23 seconds to spool out the 12,620-byte file, Release Notes version 1.00, included with the HyperDrive FX/20. Checking the print queue gives only the job that is currently printing. Unfortunately, Aldus PageMaker documents will not spool with LaserSpooler; these documents simply print as if LaserSpooler were not installed.

Both the HyperDrive FX/20 and the Big Mack Twinpack have a file-encryption utility. The program included with the HyperDrive FX/20 is explained thoroughly in the user's manual and is easy to use. The utility included with the Big Mack Twinpack is not mentioned in the user's manual, and we noticed it only when looking at the desk accessories.

The final entries in table 1 give the physical characteristics of the SCSI hard disks. The footprint is the amount of desk area taken up by the drive; this is less significant with those disks that are placed underneath the Macintosh. The ability to be placed underneath the Mac is indi-

continued

cated in the Placement row. The cables supplied with all the drives are too short to permit anything other than placement at the side or the bottom of the Macintosh.

Benchmarking SCSI Drives

Table 1 shows the results of the benchmark tests we ran and some of the distinguishing characteristics of each drive, such as software included and footprint size. The main set of tests was written in Microsoft BASIC version 1.0, and the tests were run on a Macintosh Plus with 2 megabytes of memory and one 800K-byte internal floppy disk. To decrease the variables in the tests, we formatted each SCSI drive with the low-level format provided with it and put only the amount of data on the drive that was required to run the benchmarks. This consisted of the System 3.2, Finder 5.2, the Apple Hard Disk 20 (which enabled us to compare SCSI drives to a drive on the floppy port), the Clipboard file, the four BASIC programs (LineWrite, LineRead, FragWrite, and FragRead), MacWrite version 4.5, and the 67K-byte MacWrite file. We disabled the Mac's disk cache and did not move the mouse during the test. For comparison, we also ran the benchmarks on the non-SCSI Apple Hard Disk 20, which plugs into the floppy port. [Editor's note:

The benchmarks are written in Microsoft BASIC version 1.0 for the Macintosh and are available on disk, in print, and on BIX. See the insert card following page 324 for details. Listings are also available on BYTENet. See page 4.]

In the Boot test, we measured the time between the first "bong" of the Mac Plus and the appearance of the File, Edit, View, and Special selections on the top line of the desktop. Opening the 67K-byte MacWrite file was timed from the double click on its icon to the appearance of the I-beam cursor. The LineWrite program writes a single linear 512K-byte file to the disk, while LineRead reads that same file back.

Fragmentation

To understand the purpose of FragWrite and FragRead, we must explain the notion of file fragmentation. Ideally, the system software for a hard disk will write all the bytes for a file in one long sequence. This minimizes the amount of movement that the read/write head must go through to reach the information on the disk surface. Since head motion is one of the major factors in determining a hard disk's speed, this ideal case produces the fastest times for the hard disk.

Unfortunately, most hard disks in the real world don't work so well. Every time

you delete a file, you create an empty spot in the hard disk where that file had been stored. Later, when you create a new file, some of that file might be placed in the gap left by the earlier file. As more files are deleted and added, more gaps are created and filled. After a while, the disk surface is pockmarked with hundreds of little gaps left over from all this activity. New files fill these gaps and are thereby scattered all over the surface of the disk. Retrieving fragmented files is slower than retrieving linear files because the head must move over a larger area of the disk to get to the information. Most simple benchmarks of hard disks never address this common problem because the reviewer normally works with a brand-new disk drive that has not been pockmarked with heavy use.

To simulate the effect of fragmentation, the FragWrite test creates deliberately fragmented files. The technique was to write sixteen 2K-byte files and then append 15 more 2K-byte chunks onto these 16 files in interleaved sequence. FragRead reads these fragmented files.

Which Should You Buy?

Most of these hard disks perform similarly in the benchmark tests. The stability and ease of use of the software bundled with them varies greatly. We found the DataFrame 20's software easiest to use, with the HyperDrive FX/20's running a close second. The PL20, Plus-20, LoDown 20, and Hard 20 Plus are all roughly comparable. Western Computer's Big Mack Twinpack would be a good choice if ease of making backups is important, but Western Computer needs to provide better system software and support. The MagNet 20X and the ProAPP 20 work well enough, but their external power supplies are just one more thing to find room for on your desk or floor.

If you are interested in using the hard disk as a file server, then getting MacServe bundled with the drive would be attractive. The ProAPP 20 would be good for people who have both a Macintosh and an Apple II. ■

[Editor's note: *By press time, many of the SCSI hard drive companies told us they had made changes to either their hardware or software. Relax Technology said its Hard 20 Plus now has the ability to change the SCSI address in software. Peak Systems has made the SCSI jumpers on its Plus-20 accessible outside the case as DIP switches, and it has also added an Imagewriter print spooler. The LoDown 20 now has a head-parking utility, and the MagNet 20X now has a fan and a head-parker. Peripheral Land's PL20 now has a backup-to-floppy utility.]*

Products Mentioned

DataFrame 20, DataFrame XP 20
SuperMac Technology
950 North Rengstorff Ave.
Mountain View, CA 94043
(415) 964-8884

HyperDrive FX/20
General Computer
215 First St.
Cambridge, MA 02142
(617) 492-5500

Hard 20 Plus
Relax Technology Inc.
3101 Whipple Rd., #22
Union City, CA 94587
(800) 848-1313
(415) 471-6112

ProAPP 20
ProAPP Inc.
10005 Muirlands, Suite O
Irvine, CA 92718
(800) 424-2425
(714) 855-9088

Big Mack Twinpack
Western Computer

17781 Mitchell
Irvine, CA 92714
(714) 553-1611

PL20
Peripheral Land
47800 Westinghouse Dr.
Fremont, CA 94538
(415) 657-2211

MagNet 20X
Mirror Technologies
2209 Phelps Rd.
Hugo, MN 55038
(612) 426-3276

LoDown 20
LoDown
10 Victor Square, Suite 600
Scotts Valley, CA 95066
(408) 438-7400

Plus-20
Peak Systems Inc.
1201 Spyglass
Austin, TX 78746
(512) 328-0747



BASIC Compilers for the Macintosh

Scott L. Norman

Three packages from Addison-Wesley, Zedcor, and Pterodactyl Software

Addison-Wesley's True BASIC 1.0 (\$99.95), Zedcor's ZBasic 3.01 (\$89.95), and Pterodactyl Software's PCMacBasic 1.65 (\$39.95) enable you to produce programs that capitalize on the familiar Macintosh interface.

Each compiler has its strong and weak points, as well as a distinctive feel. These programs also follow different design philosophies. True BASIC and ZBasic come in several versions for different computers, while PCMacBasic is a more specialized Macintosh-only product intended to be highly compatible with the IBM PC's BASICA dialect at the source code level. The degree to which the development cycle intrudes on the creative process varies among the three.

True BASIC

True BASIC bears the cachet of John G. Kemeny and Thomas E. Kurtz, two of the major forces behind the development of the original BASIC. Kemeny and Kurtz have been forceful advocates for their version of the language, energetically opposing the spread of a dialect of BASIC they call "Street BASIC."

True BASIC is a structured language that encourages you to adopt a convenient, modular programming style. It offers several types of decision-making constructs, some interesting facilities for handling arrays and doing matrix arithmetic, and some extremely handy features for manipulating graphics. It is also supported by site licensing and, in the Macintosh version, additional libraries for sorts, searches, three-dimensional graphics, and communications. Unfortunately, True BASIC does not generate stand-alone applications by itself; its Compile option generates tokenized versions of the source code that requires True BASIC to run. You need the runtime package, which is available separately for \$150, to generate stand-alone programs.

You can divide the True BASIC screen into separate windows for command en-

try, source code editing, and program output. You can also shape the output window to leave the code visible while a program runs, or you can use the default full-screen window. A nonstandard Control Box at the left edge of the screen includes icons for opening and closing the command and output windows, and it has a unique "traffic light" symbol that lets you start, stop, or interrupt programs by clicking on one of the lights. You can also handle these control functions via a conventional Run menu with command-key options.

The editor is similar to other Macintosh text editors except for its ability to select a block of lines according to either line numbers or ordinal positions in the code. There is also an Include feature that is handy for importing library source code into a new program. The editor also supports the numeric keypad of the Macintosh Plus.

A Format menu contains commands to number or unnumber your source code, and it can also put keywords into all-capitals format or indent the interior statements of loops. It does not generally capitalize the second keyword in a construct like DO UNTIL, however. The editor seems to be forgiving of mixing uppercase and lowercase text, but it does not tolerate the omission of spaces. For example, terminating a loop with NEXTj instead of NEXT j constitutes an error.

Line numbers are not necessary in True BASIC, and, in fact, they are not even mentioned in the user's guide. However, you cannot refer to blocks of ordinary code (as distinguished from subroutines) by labels, so you will need line numbers if you use GOSUB or GOTO to control program flow.

In normal operation, True BASIC sim-

ulates the interactive nature of a BASIC interpreter by recompiling the source code each time you give the RUN command. The compiler is fairly fast; it compiled the benchmark programs in well under 1 second, and you get the impression of quick feedback when debugging a new program. You might be reluctant to go through the process with a long, thoroughly tested routine, however. It is possible to save your tokenized code and subsequently execute it instead.

Syntax and Features

True BASIC's code should look familiar to anyone who learned programming with Microsoft BASIC. This is because Kemeny and Kurtz didn't start from scratch. They did make some changes in the syntax, however. One change that is not likable is that the keyword LET is mandatory in assignment statements (e.g., LET x = 1), just as it was in the earliest BASICs. Also, you cannot have multiple statements in one program line (comments excepted), and each of the alternatives in a multibranch decision-making structure must be written on its own line. That, at least, makes for clarity.

To allow for repeated calculations, True BASIC adds DO UNTIL... LOOP UNTIL and DO WHILE... LOOP WHILE statement pairs to the familiar FOR...NEXT construct. In addition, a flexible Pascal-like SELECT CASE statement directs program flow among discrete alternatives. For example:

```
SELECT CASE character
  case "0" to "9"
    call process__number__digit
  case "A" to "F"
```

continued

Scott L. Norman (8 Doris Rd., Framingham, MA 01701) works at the GTE Laboratories in Waltham, MA. He has a Ph.D. in physics from the University of Chicago.

```
call process__char__digit
case else
print "You didn't enter a
hexadecimal number"
```

allows your program to handle numeric input in a reasonable fashion without a large amount of code.

An improved DIM statement lets you adjust the bounds on an array's subscripts to suit the particular problem; for example, DIM expenses(1980 to 1986) sets up an array named "expenses" whose elements can be instantly identified by year. True BASIC supports the series of MAT commands that let you read, print, add, subtract, and multiply arrays. Arrays can have up to 255 dimensions on a 512K-byte Macintosh. The accuracy of variables is 14 digits, and it is 10 digits for transcendental numbers.

Graphics and ROM Support

True BASIC allows you to define the screen boundaries to any value you like rather than using a fixed coordinate system. You use the SET WINDOW command to specify the range of values (say, dollars and years) that you would like the screen dimensions to represent for a particular problem. For example, you can plot sales prices versus years using the actual sales figures by typing the statement SET WINDOW 1980, 1986, 1000, 10000. This eliminates writing an algorithm for translating these values to screen coordinates.

True BASIC introduces the concept of a "picture," the graphic equivalent of a subroutine. Pictures add flexibility to True BASIC graphics, but they are not Macintosh QuickDraw routines. You can store pictures in libraries, which are called with a DRAW statement, and you can geometrically transform them. Built-in transformation functions are available for shifting, scaling, and rotating picture data. These routines work on all computers that support True BASIC.

To make use of special Macintosh ROM features (e.g., the Menu Manager, Dialog Manager, Event Manager, and QuickDraw), you need the 13 libraries on the True BASIC Toolbox disk. A document called "Read Me (512K)" explains them briefly, but, to use them effectively, you need a copy of *Inside Macintosh* or some other detailed treatment of the Mac's ROMs. All three compilers that I tested required this document.

Many of these libraries are concerned with I/O and actually conflict with the generic syntax of True BASIC. For example, you can use Macintosh windows and menus for I/O, or you can stick to True BASIC's INPUT and PRINT statements; you cannot mix the two. However, you

can use ROM QuickDraw graphics routines along with True BASIC graphics commands. True BASIC includes its own commands for reading the mouse position and button status, allowing you to supply nontextual input to a program.

The TrueBASIC package comes with a 310-page user's guide and a 331-page reference manual. The former could serve as a step-by-step introduction to BASIC for the novice; it also contains material specific to the Macintosh. The reference manual is machine-independent and delves more deeply into issues of syntax. One result of this approach is that little information about disk files is in the reference manual, and the information in the user's guide is buried in an appendix. Each book has an index that covers both books, but the boldfaced page entries aren't the first place that a given topic appears, nor the major entry. Instead, the bold entries indicate that the information is located in the reference manual, and plain entries are in the user's guide. This is initially confusing.

[Editor's note: *True BASIC is now in version 1.2; this version supports the Mac Plus's 128K-byte ROMs.*]

ZBasic

Like True BASIC, Zedcor's ZBasic is available in different versions for a number of computers. Zedcor's philosophy is to maintain the highest possible degree of source code portability, which means that device-independent file and graphics functions are included. At the same time, the syntax has been modified to optimize the compiler's performance. The resulting implementation has a few syntactic oddities, and the graphics scheme is a little unusual. [Editor's note: *For details on the IBM PC version of ZBasic, see TJ Byers's review of ZBasic in the May 1986 BYTE.*] On the positive side, if you're a technically inclined user, ZBasic offers some exciting possibilities for extended-precision arithmetic.

The Macintosh version of the language has two editors: the ZBasic line editor, which has a window that you must use to enter direct commands, and Edit, a conventional stand-alone Macintosh editor.

The ZBasic line editor is the core of what Zedcor calls its interactive programming environment. It has an annoying characteristic: It will not rewrite text that is temporarily covered by, say, a dialog box. To assist in program development, a Minicompile feature enables you to interactively test single lines of code just as an interpreter would. These lines cannot start with an E or an L because those letters would be interpreted as the EDIT and LIST commands of the line editor.

The language is case-sensitive and requires line numbers for editing, merging, and appending programs. You can also refer to lines with labels to control program flow. You can't use ZBasic keywords anywhere within the names of variables unless you enter the names in lowercase and have not instructed the compiler to convert everything to uppercase. A Configure window lets you specify this conversion and other attributes.

After writing your source code, you can compile what is in memory and run it in one step with the RUN command or its command-key equivalent. Families of commands are available for compiling and running a source file previously saved on disk and for compiling from disk and saving the object code so that you do not have to recompile for every run. For example, RUN* filename compiles a disk source file and saves the result back to disk under the same name.

Once you have saved object code with RUN* filename, that program becomes a stand-alone application. To run it, you leave ZBasic and double-click the program's icon. At this point, you no longer need ZBasic itself. You can go even further and create programs that have their own icons (the RMaker resource compiler utility needed for this comes with the package) or create programs that open automatically when you double-click on any associated data file.

ZBasic allows you to chain or link programs together by using shared or independent variables through a family of LOAD, MERGE, and APPEND commands. The LONG FN command allows you to write multiline function definitions that are terminated by END FN. Subroutines are supposed to be saved as unnumbered source code (using SAVE+) so that you can insert them at any desired point of a calling program.

Major Features

Many other aspects of ZBasic's operation will be familiar to experienced BASIC users. Looping structures include FOR...NEXT, WHILE...WEND, DO...UNTIL, and LONGIF...ENDIF. A good assortment of branching commands is included, but there is no SELECT CASE selection statement, as in True BASIC.

ZBasic arrays can have up to three dimensions. The user's manual describes the storage requirements for the digits of accuracy for variables (4 bytes of memory for 6 digits of single-precision accuracy per variable, 8 bytes for 14 digits of double-precision accuracy per variable, and a user-configurable accuracy on the Macintosh for up to 240 digits). You can configure ZBasic for greater or lesser math precision depending on whether

	True BASIC	ZBasic	PCMacBasic
Type	BASIC language for the Macintosh	BASIC language for the Macintosh	BASIC language for the Macintosh
Company	Addison-Wesley Publishing Company Inc. One Jacob Way Reading, MA 01867 (617) 944-3700	Zedcor Inc. 4500 East Speedway Suite 93 Tucson, AZ 85712 (602) 795-3996	Pterodactyl Software 905 West California St. Mill Valley, CA 94941 (415) 388-4827
Format	Two 400K-byte 3½-inch disks	One 400K-byte 3½-inch disk	One 800K-byte 3½-inch disk
Computer	128K-byte Macintosh; 512K-byte Macintosh and external drive recommended	512K-byte Macintosh or Macintosh Plus; external drive recommended	512K-byte Macintosh with an external drive
Documentation	310-page user's guide; 331-page reference manual; reference card	User's manual that contains a 227-page tutorial, a 170-page reference guide, and four appendixes; reference card	162-page user's manual with 80 pages of appendixes
Price	Compiler: \$ 99.95 Run-time package: \$ 150 Sort/search library: \$ 49.95 Communications library: \$ 49.95 Three-dimensional graphics: \$ 49.95 Advanced strings: \$ 49.95	\$89.95	\$39.95

your requirements are execution speed or accuracy, and the manual describes the trade-offs. This isn't the sort of information you need every day, but it comes in handy if you're attempting to optimize the performance of your BASIC program.

If you plan to use extensive calculations in your application, you should know that the Macintosh version of ZBasic features enhanced numerical ranges—up to 240 digits of accuracy, as mentioned earlier, for double-precision floating-point calculations (e.g., 9.99¹⁶³⁸³ to 9.99¹⁶³⁸⁴). The defaults are 12 digits for double precision, 6 digits for single precision, and 8 digits for scientific precision. Both 2-byte and 4-byte integers are supported, and integer arithmetic is assumed as the default unless the compiler is configured otherwise.

The manual states that the execution speed is the same for single- and double-precision calculations, which is contrary to my experience with the BYTE Floating-Point benchmark (see table 1). I used the Reconfigure ZBasic option under the Configure menu to set the default variables to single or double precision when I ran this benchmark, and the double-precision computations ran significantly faster.

In addition to ZBasic's device-independent graphics described in TJ Byers's review, the Macintosh version has special enhancements: All MacPaint's patterns are available for filling in figures or for the pen, although the numbering scheme

shown in the documentation is incorrect. The pattern identifications actually run from 0 to 37 rather than from 1 to 38 as indicated.

ZBasic's graphics commands will generally be familiar to users of Microsoft BASIC, but oddities such as the use of "brads" (which run from 0 to 255) to measure angles in the CIRCLE command exist. Also, simply plunging ahead with ZBasic graphics will generate elliptical circles; a RATIO command is required to set things right.

One of ZBasic's graphics commands is less versatile than Microsoft BASIC's: You may have to repeat the FILL command with different starting points if you want to fill in the background around a complex object. This is because the algorithm for area-filling starts from the uppermost point in the region and fills from left to right as it works downward. It's possible that this method might miss certain areas in the region, requiring additional calls to FILL. The GET and PUT commands for doing animation by copying, erasing, and redrawing regions of the screen do not appear in conventional ZBasic, but they are available in the Macintosh version.

ZBasic does a good job of invoking pull-down menus and dialog boxes. ROM Toolbox functions and procedures are supported, but *Inside Macintosh* or a similar reference is a necessity.

The latest version of the ZBasic user's manual consists of 227 pages of tutorial

material, a 170-page reference section, four appendixes for various operating systems, a reference card, and the unavoidable errata sheets. The Macintosh appendix is 115 pages long. The whole thing is reasonably well-written, but, as with the True BASIC documentation, it can be a little wearisome for the beginner to flip back and forth between general-reference material and Macintosh-specific information.

[Editor's note: *ZBasic is now in version 3.03. It features faster printing, and it supports 20 new Macintosh Toolbox calls.*]

PCMacBasic

A Macintosh compiler designed for maximum syntactic compatibility with the IBM PC's BASICA is something of an oddity. You'll probably be more interested in PCMacBasic's ability to use Macintosh resource files—files that enable you to customize icons, windows, menus, dialog boxes, character fonts, and other attributes of the Macintosh display. PCMacBasic can, in principle, produce the most thoroughly Mac-like programs of the three BASICs described here, but at a price. The package is not simple to use, and, to get the most from it, you should have either Apple's Macintosh Development System (MDS) or Signature Software System's McAssembly assembler and linker.

No special multiple-window program-

continued

ming environment is available in PCMacBasic. It most resembles the conventional development environment in that you use an editor to write the source code, use the compiler to generate object code, and then attempt to run the program. You can use any text editor to create the code for the two input files the compiler needs: the BASIC source program and the associated resource file.

From these files, PCMacBasic can create a stand-alone program. The compiler can also produce an assembler source file in MDS or McAssembly format, should you want to hand-tune the assembly language.

PCMacBasic has a built-in resource compiler, and the documentation contains a certain amount of information on the syntax of resources. A couple of demonstration files are on the disk, but not

enough for the novice. To learn about resource files, you are referred to the ubiquitous *Inside Macintosh*. You are also referred to the IBM BASICA manual if you want more than the sketchy information on BASICA commands that is included in an appendix entitled "The Rest of the Statements."

PCMacBasic can compile large (100K-byte) programs, but you must break them into segments, each less than 32K bytes long. You can chain segments together in the source code so that one will call another, and you can pass variables between them by using the COMMON identifier.

The compiler is case-insensitive. Line numbers are optional, and, as in FORTRAN, they do not have to appear in numerical order when you use them. Each program segment must begin with a line

number, however, and you can refer to lines only by number—not by label.

Some Syntax Features

PCMacBasic has 13 mouse-sensing commands that you can use to write the editing portion of an application program. The BASIC program can detect single, double, and triple clicks with a single MOUSE(0) function call.

Other MOUSE calls return the starting, ending, and current locations of the mouse. These points are available both as graphic coordinates and as the nearest text-line and column location. PCMacBasic handles all mouse activity for the system, menus, dialog boxes, and scroll bars. You can take care of clicks only within the main windows.

There are no restrictions on the num-
continued

Table 1: Results from the standard BYTE benchmarks (for the program listings, see *BYTE's Inside the IBM PCs, Fall 1985, page 195*). The Sieve program measures the time required to execute one iteration of the Sieve of Eratosthenes benchmark. The Floating-Point benchmark determines how long it takes to do 10,000 multiplication and 10,000 division operations. The Write program measures the time required to write a 64K-byte sequential text file to a blank disk 128 bytes at a time; the Read benchmark measures the time required to read this file into memory 128 bytes at a time. The benchmark programs had to be modified slightly to run with True BASIC's syntax. For True BASIC, the Read and Write benchmarks in

normal mode required a SET MARGIN 128 statement after the OPEN statement to set the record size to 128 bytes. A LINE INPUT statement was required in True BASIC to allow the Read benchmark to read a file in the normal mode. Computers used were a Macintosh with an internal 20-megabyte HyperDrive using Finder 4.1 and System 2.0, and a Macintosh Plus with floppy disks formatted for 400K bytes in the internal drive and using Finder 5.3 and System 3.2. For the disk I/O benchmarks, normal mode indicates that PRINT and INPUT statements were used in the benchmark code; binary mode indicates that WRITE and READ statements were used. All times are in seconds.

	Microsoft BASIC 2.1(b)	True Basic 1.0*	ZBasic 3.01	PCMacBasic
Sieve	86	11	0.8	153 Compiled using simple template file.
Floating Point	22	7	46 Single precision. 32 Double precision using DEFDBL.	43
Write	15 Internal 20-megabyte HyperDrive used, normal mode.	6 Internal 20-megabyte HyperDrive used, binary mode.	3 Internal 20-megabyte HyperDrive used, binary mode.	6 Internal 20-megabyte HyperDrive used.
	21 400K-byte blank floppy disk, normal mode; 65,535-byte file output.	12 400K-byte blank floppy disk, normal mode; 66,048-byte file output.	123 400K-byte floppy disk, normal mode; 66,048-byte file output.	15 400K-byte floppy disk, normal mode; 66,048-byte file output.
Read	14 Internal 20-megabyte HyperDrive used, normal mode.	5 Internal 20-megabyte HyperDrive used, binary mode.	2 Internal 20-megabyte HyperDrive used, binary mode.	7 Internal 20-megabyte HyperDrive used.
	16 400K-byte blank floppy disk, normal mode; 66,048-byte file read.	10 400K-byte blank floppy disk, normal mode; 66,048-byte file read.	58 400K-byte floppy disk, normal mode; 66,048-byte file read.	12 400K-byte floppy disk, normal mode; 66,048-byte file read.
		7 400K-byte blank floppy disk, binary mode; 65,535-byte file output.	4 400K-byte floppy disk, binary mode; 65,535-byte file read.	

* True BASIC's run-time package was not available; all benchmarks were run in interpreter mode.

Think You Need an AT?

The Next Generation in IBM PC Speedup Boards



Make Your IBM PC Faster Than an AT in Just 5 Minutes!

	IBM PC	IBM AT	BREAKTHRU 286	
Clock speed in MHz (IBM PC is 4.77)	4.77	6	8	12
Empty Loop	1	1.99	3.34	5.15
Integer add from memory	1	3.35	4.41	6.02
Integer multiply from memory	1	6.06	6.55	8.3
Floating point without coprocessor	1	3.33	4.42	5.76
Prime number test	1	1.95	2.85	3.7
Lotus 123 macro (640K)	1	2.64	3.69	4.62
Lotus 123 macro (256K)	1	1.77	3.54	4.38
Norton System Information Test	1	5.73	7.34	10.2
PRICE			\$395	\$595
LIGHTNING™ FREE with Breakthru speedup hardware — \$89.95 purchased separately				
In every case but clock speed the numbers indicate how many times faster a test is performed than on a regular IBM PC				

* All but Norton SI are the PC magazine Labs public domain benchmark tests.

We are excited about our three speedup products. You probably know about our Lightning disk access speedup software that was awarded PC Magazine's Best of 1986 award (see box). After the smashing success of Lightning, in late '86, we

guaranteed the Breakthru 286 board to be literally the most advanced, fastest, most feature-rich board available. The runaway success it has enjoyed truly proved that assertion. Now we go ourselves one better with the Breakthru 286-12. This new board has the clock speed cranked up from 8 to 12 MHz for speeds up to 10.2 times faster than an IBM PC. It is 50% faster than an 8MHz IBM AT, and up to a whopping 1,000% faster than a regular PC.

HERE'S WHY THESE TWO BOARDS ARE SO SPECIAL.

First, they install so easily. A half-slot card means you don't even have to give up a full slot. What's more, unlike competing

products it works in the Compaq Portable and most clones. Easy diagrams show how you just place the card in an open slot, remove the original processor and connect a single cable. There is no software required. From that moment you are running faster than an AT.

Second, they are advanced. The BREAKTHRU 286 replaces the CPU of the PC or XT with an 80286 microprocessor that is faster than the one found in the AT. Has a 80287 math coprocessor slot for numeric intensive applications. A 16K cache memory provides zero-wait-access to the most recently used code and data. Speed switching software allows you to drop back to a lower speed on the fly for timing sensitive applications.

Third, you have full compatibility. All existing system RAM, hardware, and peripheral cards can be used without software modification. Our boards operate with LAN and mainframe communication products and conform to the Expanded Memory Specification (EMS). Software compatibility is virtually universal.

Faster and smarter than an AT - PCSG guarantees it.

Fourth, these are the best. There are several other boards on the speedup market. We at PCSG have compared them all, but there simply is no comparison. Many cards offer only a marginal speedup in spite of their claims and others are just poorly engineered.

We are really excited about these products. PCSG makes the unabashed statement that the BREAKTHRU 286 card represents more advanced technology than boards by Orchid, Quadram, P.C.

Technologies, Phoenix...we could go on. Breakthru 286 is undisputedly the turbo board with the biggest bang for the buck. And we include FREE the \$89.95 acclaimed Lightning software. Call today with your credit card or COD instructions and we will ship your card the very next day.

But, no speedup board cuts disk access time in half

LIGHTNING™

software can - \$89.95 or FREE w/Breakthru

"Lightning is almost mandatory..." - Steve Manes, PC Magazine Best of 86 review

Loads with the DOS - always ready as a background program to accelerate disk access. You do nothing - everything is automatic. Programs that frequently access the disk (hard or floppy) are made instantly up to 2 to 4 times faster. Uses a principle greatly enhanced from mainframe technology called caching. Fully exploits Above Board memory.

LIGHTNING is the standard against which all our competition measures itself because we achieve universal compatibility with other software. Data is never lost. Order **LIGHTNING** separately or get it free with your Breakthru 286 board.



Think Again.

DON'T TAKE OUR WORD FOR IT. USE EITHER BREAKTHRU 286 SPEEDUP BOARD FOR 60 DAYS. IF YOU ARE NOT TOTALLY SATISFIED SIMPLY RETURN IT FOR A FULL REFUND.



Inquiry 247

PERSONAL COMPUTER SUPPORT GROUP



11035 Harry Hines Blvd. • Suite 206 • Dallas, Texas 75229 • (214) 351-0564

ber of FOR...NEXT loops in a program, and an inner loop can be ended by the NEXT statement of an outer one. You can also terminate loops by a RETURN statement. And, WHILE...WEND loops are available.

Arrays are dynamic, and you can erase and re-create them in a different size while a program is running. An array can't use more than 32,766 bytes. The OPTION BASE statement can designate any integer, not just 0 or 1, for the lowest subscript in an array. You can use special ERASE and FRE(" ") commands within a program to fully recover the space taken by unused arrays.

Single- and double-precision numbers are in Apple's SANE format (using 4 or 8 bytes, respectively). Hexadecimal and octal constants are limited to 16-bit integers.

As mentioned earlier, PCMacBasic has extensive facilities for setting up menus. In the same way, it allows you to define function keys, the command-key-stroke equivalents of items on a special Function menu. I found that the simplest way to set up the BYTE benchmark programs was to use one of the sample programs as a template. I assigned each benchmark routine to a function key and then simply inserted its code at the designated spot in the sample program outline. The associated sample resource file handled the actual establishment of the Function menu.

Graphics are available in either the medium resolution (40-character-wide) or high resolution (80-character-wide) screen modes, which must first be specified with a SCREEN command. This is a familiar requirement to people who have

used Microsoft BASIC on other computers, but it is unusual for the Macintosh. Unfortunately, you have to go through some calculations to get from BASIC coordinates to screen coordinates.

Generalized CIRCLE and LINE statements are available, which have the usual options for drawing ellipses, arcs, and boxes. The photocopied user's manual (which is 162 pages long, including appendixes) does not devote a great deal of emphasis to graphics, but it does describe how to call QuickDraw routines.

[Editor's note: PCMacBasic's latest version is 1.96. This version provides Hierarchical File System compatibility, and it enables you to compile one program and then link in other modules. A new spiral-bound user's manual is also included.]

Observations

For the complete benchmark results, see table 1. I used a 512K-byte Macintosh equipped with an internal 20-megabyte HyperDrive for the tests. Since I didn't have the run-time package for True BASIC, I ran all the True BASIC benchmarks using True BASIC as an interpreter. [Editor's note: Microsoft BASIC interpreter benchmarks are provided for comparison. Also, disk I/O benchmark times for 400K-byte floppy disks are provided. The file I/O benchmarks varied considerably depending on the I/O mode being used. For example, ZBasic didn't fare well using PRINT and INPUT statements, but it did considerably better using WRITE and READ statements for binary file I/O. This also affected the size of the benchmark file, since each BASIC

adds a carriage return to the end of a string output by a PRINT statement. See table 1 for the file sizes generated.]

I have discussed these products in order of increasing difficulty of use, at least for me. True BASIC's operation and documentation have a professional look, and, although I might quibble with some of its syntactic rigidity, I find it the easiest of the three to use for one of my most common jobs: the construction of fairly short programs that end by putting a financial or technical graph on the screen. I find True BASIC's user-defined coordinate system a terrific convenience.

ZBasic is more of a chore to unlimber for simple applications, but I have other things in mind for it. My professional interests include the mathematical modeling of physical systems, for which I generally use mainframe-style FORTRAN. I am therefore very intrigued by the numerical precision that ZBasic claims, although I am not optimistic about its speed, a judgment based on the floating-point benchmarks. Still, I have every intention of turning it loose on some sizable problems in heat-transfer and semiconductor-device modeling.

And how would I assess PCMacBasic? I guess I must be a graphics-oriented Macintosh advocate, because I can't see the sense of using PC-style graphics on the Macintosh. Although PCMacBasic has a great deal of flexibility by virtue of its ability to use resource files, I had trouble justifying this power with the language's IBM PC emphasis. The manual makes no pretense of catering to the novice. As a result, I often found it difficult to determine whether I was expecting too much from the system or too little. ■

DataSaver[®] Standby UPS

90 Watt. The original micro-UPS that brought standby AC power to Apple users in 1980. Still the POWER SOLUTION for serious applications of the MAC, small micros, and portables.
Model 9012060 \$350. FCC(15A&B).

400 Watt. Now, POWER PROTECTION and MASTER CONTROL for full-size micros. Filters electrical noise/spikes and provides up to 10 minutes of AC power for the AT and supermicros.
Model 40012060 \$695. UL-E101268.

200 Watt. This DataSaver standby UPS offers compact, cool and quiet line conditioning and backup power to PC, XT, and COMPAQ markets. Data and hardware are protected.
Model 20012060 \$495. CSA-LR51253.



Cuesta Systems Corporation
3440 Roberto Court
San Luis Obispo, California 93401

1986. Made with pride in the U.S.A.
805/541-4160 TLX:4949381 CUESTA
Dealer, VAR, & OEM inquiries invited.

"A Work of Art"

AA

TO: Joan Prentiss-Winston, CEO
FROM: Bertram W. Finch, CFO

PROPOSAL

After researching all our options, I can confidently recommend a software product by SoftCraft, Inc. The product is called Fancy Font and it would meet all our typesetting needs. Fancy Font is cost effective and is compatible with all our laser and dot matrix printers, as well as any of our installed word processors.

Fancy Font can meet the needs of the following departments:

Graphics

Our graphic artists will find Fancy Font useful for creating vu-graphs, presentation materials and advertisements. There are now commands to create and work with graphic images. SoftCraft also offers a special service to digitize logos and symbols our artists design.



Documentation



Fancy Font will save time and money in the production of our manuals and technical documents that require several sized chapter, title and section headings in a variety of text formats including portrait and landscape mode. The kern option creates ligatures for the most polished looking documents.

Manufacturing



With Fancy Font, we can design our own product labels. The SoftCraft font library even has a bar code font available for inventory control purposes.

Research and Development

Fancy Font provides the special symbol and mathematical fonts this department needs to produce proposals and technical reports containing scientific notation and mathematical formulae.

$$\pi(n) = \sum_{k=2}^n \left\lfloor \frac{\phi(k)}{k-1} \right\rfloor$$

Public Relations and Marketing



Fancy Font can make all our promotional materials look more professional. It is a software package versatile enough to produce news releases, invitations, company newsletters, even last-minute sales presentations, all looking as though they had been done by a professional typesetting service.

Accounting

Fancy Font can produce columns of figures in small typefaces and can be used with our Lotus spreadsheets and graphs. Perfect for doing annual financial reports.



RECOMMENDATION: Fancy Font can meet the special needs of virtually every department in the company. No special hardware or installation is required, so we can use it as soon as it arrives. Fancy Font would cut company costs by reducing printing and typesetting fees and bring in-house, several services that we now send out. I recommend that we purchase Fancy Font immediately.

Bertram W. Finch
Bertram W. Finch

Mix different sizes and styles of native and SoftCraft fonts on the same line.

Create and print your own characters and logos up to 2" high and 2 2/3" wide.

Special formatting features let you wordwrap, or position text centered, justified, flush left or right, and much more.

Automatic pagination makes formatting long documents easy! No length limits!

Kerning option kerns a document and automatically forms ligatures.

Hundreds of optional fonts from 4 to 72 points available.

Send us your logo or signature for digitization.

Create boxes shaded or patterned according to your specifications. (new!)

Standard fonts include Sans Serif, Roman, Script, Old English, bold, italic in sizes from 8 to 24 points.

Automatic column command. (new!)

Includes over 1500 mathematical, foreign language and special symbols that can be scaled to any size up to 1 inch.

Drop in graphic images captured from a file or from the screen display of programs such as Lotus 1-2-3. (new!)

Let Fancy Font turn your printer into a personal typesetter.

Fancy Font gives you the utmost in document versatility by allowing you to mix a variety of font styles and sizes in either portrait or landscape mode with your printer's native fonts.

If you have an inexpensive dot matrix printer, Fancy Font turns low-resolution print quality into stunning high-resolution, proportionally-spaced text rivaling laser printer output.

If you have a laser printer, Fancy Font turns it into an economical desktop publishing system. Fancy Font prints with a wide variety of typestyles and sizes normally available only from expensive typesetting services.

Fancy Font runs on all IBM PC's and compatibles and works with word processors, spreadsheet and database programs.

SoftCraft, Inc. offers a wide variety of personal typesetting software and fonts. Call our toll-free number for information on these and other products:

Fancy Font	\$180
Fancy Word	\$140
Laser Fonts	\$180
SoftCraft Font Editor	\$290
Business Font Pack	\$90
Font disks	\$15 each

Now with graphics!

 **SoftCraft, Inc.**

16 N. Carroll St., Suite 500, Madison, WI 53703 (608) 257-3300 1-800-351-0500

The sample letter above was printed in one pass with Fancy Font on an HP LaserJet+.

Inquiry 295 for End-Users. Inquiry 296 for DEALERS ONLY.

COMPUTER WAREHOUSE

CALL TOLL FREE **1-800-528-1054**

FREE **FEDERAL EXPRESS**

Air Express Shipping

See Details Below

NOW

BEST PRICES

No Charge for Bank Cards

HARDWARE

PRINTERS

Alps	
All Models	Call
Brother All Models	Call
Citizen MSP-10	\$269
MSP-15	\$359
MSP-20	\$309
MSP-25	\$459
Premier 35	\$445
120 D	\$169
Diablo D-25	\$469
635	\$759

EPSON

All Printer Models	Call
Hewlett-Packard LaserJet II	\$1799
NEC	
3510, 3550	\$729
8810, 8850	\$1045
P6	\$429
P7	\$609
P9	\$429

OKIDATA

All Printer Models	Call
Panasonic 10801	\$189
1091 I	\$245
1092 I	\$319
1592	\$385
1595	\$465
3131	\$229
3151	\$369

STAR MICRONICS

All Printer Models	Call
Toshiba 321 Parallel & Serial	\$455
341E Parallel	\$669
351 Model II	\$1045
Laser Printer	Call

MONITORS

Amdex All Monitors	Call
NEC Multisync	\$569
Multisync Graphic Board	Call
Princeton Graphics	Call

VIDEO TERMINALS

Qume 101 Plus Green	\$315
101 Plus Amber	\$315
Wyse 30	\$285
50	\$359
75	\$565
Wyse 85	\$425

MODEMS

Anchor Automation	
Signalman Express	\$185
Practical Peripherals	
Practical 1200 Baud	\$124

HAYES

All Modems	Call
Prometheus All Models	Call
US Robotics Courier 2400	\$335
Password 1200	\$165
Microlink 2400	\$349
Ventel	Call

DISK DRIVES

Imega Bernoulli 10 meg	\$1195
Bernoulli 20 meg	\$1595
Bernoulli 40 meg	\$2325

SEAGATE

20 meg w/Western I/O	\$349
----------------------	-------

DISKETTES

Maxell MD2 (Qty 100)	\$85
Sony MD/2 (Qty 100)	\$85

COMPUTERS

PANASONIC

Business Partner	\$719
Sr. Partner	\$969
Exec. Partner	\$1299
Other Models	Call

TOSHIBA

T-1100 Supertwist	\$1399
T-3100	\$3049

FCC Approved

\$389

MIT SYSTEMS Turbo PC/XT

256 Memory, One 380K Brand Name Floppy Drive • 135 Watt Power Supply, Slide Case, AT Style Keyboard • 6 MHz Clock Speed, (Keyboard Selectable), 8 Expansion Slots

BOARDS

AST Advantage	\$329
Rampage AT	\$395
Rampage PC	\$239
Six Pack Plus	\$149
Hercules Color Card	\$149
Graphic Card	\$179
Intel Above Board PS/PC (1110)	\$239
Above Board AT (2010)	\$315
Above Board PS/AT (2110)	\$345
Above Board PC 1010	\$1210
NEC Multisync Graphic Board	Call
Orchid Tiny Turbo 286	\$415
Turbo EGA	\$565
Paradise Five Pak	\$99
EGA Autoswitch	\$305

Plus Development

Plus Hard Card 20 Megabyte	\$609
Quadram Quad EGA+	\$359
Tec Mar Graphics Master	\$409
Captain No Memory	\$109
EGA Master	\$239
Video-7 Vega Deluxe	\$319
Vega Enhanced Graphics Adapt	\$279

PLOTTERS

Epson Hi-30	Call
-------------	------

COPIERS

Canon
«PC»

Canon PC-25 \$929

SOFTWARE

IBM PC and 100% Compatibles

TRAINING

Flight Simulator	\$28
PC Logo	\$69
Typing Instructor	\$27
Typing Tutor III	\$27
MS Learning DOS	\$28

LANGUAGES

C Compiler (Microsoft)	\$249
Fortran Compiler (Microsoft)	\$249
Macro Assembler (Microsoft)	\$84
Pascal Compiler (Microsoft)	\$166
Quick Basic 2	\$55
Turbo Jumbo Pack	\$159
Turbo Pascal w/8087 & BCD	\$155
Turbo Database Tool Box	\$38
Turbo Prolog	\$54

PROJECT MANAGEMENT

Harvard Total Project Manager II	Call
Microsoft/Project	\$219
Super Project Plus	\$269
Timeline 2.0	Call

COMMUNICATIONS

CompuServe Starter Kit	\$19
Crosstalk XVI	\$88
MS Access	\$139
Mirror	\$38
Remote	\$88
Smartcom II	\$82

INTEGRATIVE SOFTWARE

Enable 2.0	Call
Framework II	\$395
Smart Software System 3.1	\$409
Symphony	Call
Ability	\$55

GRAPHICS

Chartmaster	Call
Diagram Master	Call
Energraphics 2.0	\$269
In-A-Vision	\$259
Microsoft Buss Mouse 6.0	\$106
Microsoft Chart	\$164
Microsoft Serial Mouse 6.0	\$119
Newsroom	\$31
PC Buss Plus Mouse	Call
Click Art Personal Publisher	Call
IMS! Mouse w/Dr. Halo II	\$92
PC Mouse	Call
Printmaster	\$29
Signmaster	Call
Turbo Graphix Tool Box	\$38

WORD PROCESSORS

Leading Edge Word Processor	\$25
Leading Edge W/P/W/Spell & Mail	\$59
Lightening	\$55
Microsoft Word 3.1	\$249
Multimate Advantage	\$299
Wordstar/Tutor	\$162
Wordstar Pro Pack 4.0	\$233
PFS: Professional Write	Call

Word Perfect (Ver.4.2) \$199
Wordstar 2000 + 2.0 \$278

SPREADSHEETS

Lotus 1-2-3	Call
Multiplan	\$108
Spreadsheet Auditor 3.0	\$82
VP Planner	\$47

Supercalc 4 \$269

MONEY MANAGEMENT

Dollars & Sense w/Forecast	\$92
Tobias Managing Your Money	\$105

UTILITIES

MS Windows	\$55
Copy II PC	\$19
1 DIR Plus	\$46
Fastback	\$84
Norton Utilities 4.0	\$48
Printworks	\$36
Sidkick (Unprotected)	\$47
Travelling Sidkick	\$39
Sideways 3.1	\$34
Superkey	\$39
Xtree	\$25
SQZ	\$46

DATA BASE MANAGEMENT

Clipper	Call
Cornerstone	\$53
dBase II	Call
dBase III Plus	\$395
Extended Report Writer	\$149
Knowledgebase II PromoPack	\$319
Quickcode Plus	\$138
QuickReport	\$138
Reflex	\$82
DB-XL	\$82
PFS: Professional File	Call

R:Base 5000 System V \$355

Many other titles available.

Inquiry 72 for MS DOS Products. Inquiry 73 for all others.

COMPUTER WAREHOUSE

Order Line: 1-800-528-1054
Order Processing: 602-224-9345
2222 E. Indian School Rd.
Phoenix, Arizona 85016
602-954-6109

Store Hours: Mon-Fri 10-5:30
Saturday 9-1
Order Line Hours: Mon-Fri 7-5:30
Saturday 9-1
Order Processing Hours: Mon-Fri 10-3

Product shipped in factory cartons with manufacturer's warranty. Please add \$6.00 per order for UPS ground shipping on orders up to 10 lbs. Orders 10 lbs. and under you pay for ground service, receive air service at no extra charge. Available on orders 11-30 lbs. \$17 for air service. Prices & availability subject to change without notice. Send cashier's check or money order. All other checks will delay shipping two weeks.



CWF-287



Q&A 2.0

Phillip Robinson

A file manager with a natural-language interface and word processor

Q&A version 2.0 from Symantec is primarily a flat-file manager for the IBM PC and compatibles. Its File and Report modules are modeled after the original PFS:File program from Software Publishing. Although the Q&A modules retain the familiar interface of that program, they also add a host of sort, format, and search features.

But Q&A is more than a flat-file manager. It also contains a word processor called Write that is complete enough to be a worthwhile product on its own. You call the word processor's features with the File module to create forms, but you can also use it for writing memos, letters, and other documents. A Merge facility in Q&A lets you incorporate information from the data files into Write documents.

Both the database and word processor in Q&A are supported by export and import functions grouped under the "utilities" heading in Q&A's main menu. Other utilities concern printer installation and DOS functions such as listing file names and renaming, copying, or deleting files. A macro facility is available at all times within Q&A; you can use it to capture a series of Q&A commands or to simplify the repetitive input of a long text string during word processing or data entry.

Finally, Symantec beefs up this \$349 package with a natural-language front end called the Intelligent Assistant. The IA can analyze a wide range of questions posed in everyday English phrases to directly manipulate the database or to generate reports.

Memory Hungry

Q&A eats up a lot of memory. The program requires a minimum of 512K bytes of RAM, and 640K bytes is recommended. When you use Q&A with the IA, work with a large database, or do reports with multiple sort levels, you'll need the maximum amount of memory. For simple databases, writing, or report generating, 512K bytes will suffice. This

demand for memory led Symantec to offer inexpensive (\$50) 256K-byte RAM add-on boards to Q&A buyers (through its Turner Hall Publishing subsidiary).

Q&A's hunger for memory doesn't end with RAM: The program comes on six 5¼-inch floppy disks (three disks if you use 3½-inch floppies) comprised of a Startup disk, a File/Report/Utilities disk, the IA disk, a Write/Proof disk, a Tutorial disk, and a Samples disk. Although a couple of these disks come into play only during initial installation, you still need the other four during regular use of Q&A. That leads to a lot of disk shuffling; each of the major components—Write, File, and the IA—are on separate disks. The program prompts you for disk changes but, for efficiency's sake, you'd best use a computer equipped with a hard disk, even if you use 3½-inch floppies.

Welcome Changes

Version 2.0 of Q&A has quite a few changes from earlier versions. [Editor's note: *See the Product Preview of version 1.0 by Jon R. Edwards in the January 1986 BYTE.*] These changes include an improvement in the speed of the IA, inclusion of a database-recovery utility for slightly damaged databases, tighter integration with Lotus 1-2-3, improved macros and programming, more formatting options for reports, networking support in the form of file-locking, and international versions (French, German, and Dutch versions are currently available). The database-recovery tool is particularly welcome because Q&A databases, like other databases, can be damaged when the program is interrupted by a power loss or by a reboot from any point other than a Q&A menu.

Q&A has several features that tailor it

to work closely with Lotus 1-2-3. First, you can install 1-2-3 as one of Q&A's main menu choices. That means you can run 1-2-3 directly from Q&A almost as if it were another module. You can also import 1-

2-3 worksheets directly into either Write or File and include 1-2-3 graphs in the printed version of Write documents.

Version 2.0 of Q&A can read database files from Q&A 1.0 and 1.1 and put them into 2.0's format, but versions 1.0 and 1.1 cannot use 2.0 files. The user's manual says that 2.0 can use macro files created with 1.0 or 1.1, but changes to some of the menus and the additional use of function keys "may make some macros behave differently." In other words, you'd better write new macros.

I tested Q&A on an IBM PC with 512K bytes of RAM and two 5¼-inch floppy disk drives. Although I did not test Q&A on a network, the user's manual says that the program is compatible with all major LANs that support DOS 3.1 or higher including 3+ from 3Com, NetWare from Novell, and IBM's PC Network and Token-Ring Network. Two people cannot run the same copy of Q&A at the same time on a LAN, but they can share the database. Q&A has file locking, so when one person is using the database, others are locked out.

The Write Module

I wrote this review with the Write word processor. Like the other modules of the program, Write loads slowly. You do most of the editing on the 21 lines of the simple editing display using function-key commands (or WordStar cursor commands, if you prefer). Across the bottom

continued

Phillip Robinson is a BYTE contributing editor and an editor of The Architect's PC and Desktop Engineering News. He can be contacted at Desktop Engineering News, P.O. Box 40180, Berkeley, CA 94704.

Q&A version 2.0**Type**

File manager and word processor

Company

Symantec
10201 Torre Ave.
Cupertino, CA 95014
(408) 253-9600

Format

Six 5¼-inch disks or three 3½-inch disks

Computer

IBM PC or compatible with two disk drives and a minimum of 512K bytes of RAM (640K bytes recommended) running DOS 2.0 or higher

Language

C

Documentation

648-page user's manual; quick-reference guide; quick-reference card

Price

\$349; optional thesaurus program: \$50. If you bought Q&A version 1.0 or 1.1 after September 14, 1986, a free upgrade to version 2.0 is available. All registered owners of 1.0 and 1.1 who bought Q&A before this date can purchase an upgrade to 2.0 for \$50.

are a tabs-and-margins line, two status lines (including one that tells the percent of memory used), and a function-key menu line. The status line gives you a blinking bulletin such as "Saving ..." whenever the program performs some task.

Write has many of the usual word processing features such as edit, delete, set and release tabs and margins, center a line, bold, underline, indent, and search and replace, in addition to block manipulation and printing facilities. But the module also offers more advanced features such as headers and footers, a display of the current date and time, line and box drawing, italics, superscripts and subscripts, a spelling checker, restoring blocks (an Undo function), searching with wild cards (which you can also use to count the words in a document), and math calculation within the text. It can work with documents of up to 20 to 30

pages on systems with 512K bytes of RAM and up to 80 pages with 640K bytes. The spelling checker, unfortunately, is one of the slowest I have used. It does, however, enable you to add words to the 60,000-word dictionary.

For printing, Write has microjustification control, column printing for up to eight columns per page, an envelope-printing routine, and a mail-merge facility. In addition to Lotus 1-2-3 and Symphony spreadsheets and .PIC files, you can incorporate PFS:Graph picture files and BASIC BSAVE formatted files into Q&A printed documents.

Write can import PFS:Write, IBM Writing Assistant, ASCII, WordStar, Lotus 1-2-3, and Symphony documents, and it can write files in its own format or in ASCII. An automatic backup function that you can invoke from the Utilities menu lets you periodically save active files without manual intervention.

Filing

Q&A uses a flat-filing scheme based on forms (equivalent to records) and fields. You design your own forms using the same editing commands as the Write module. You can choose the length, position, label, and information type for each field, make forms up to 10 screens long, and draw boxes on the forms for screen design and printing.

Each file can be up to 256 million bytes and can handle up to 16 million records. In other words, these disk-based files are limited only by your disk space. (The word processing files are RAM-based.) Each form can have as many as 2182 fields or 16,780 characters. The information types for fields are Text, Number, Money, Keyword, Date, Hours, and Yes/No. The Keyword information type lets you input several entries on one information blank, or field, and retrieve entries selectively by searching for keyword combinations.

To add data to the database, you simply call up a blank form and fill it in. Q&A will check the entry for each field and will not allow you to enter the wrong information type. To make data entry easier for someone else, you can define your own help screens to explain the labels and have the screens pop up whenever the user presses F1.

To retrieve a form, you fill out a Retrieve Spec screen that duplicates the labels and fields of the forms. You can specify within each field what range to search using a large variety of operators from "equal to" and "empty" to keyword searches on "includes X, Y, and Z, in that order." You can also use wild-card searches.

Sorting is just as easy to control: You

move directly from the Retrieve Spec screen to a similar Sort Spec screen. There you specify each field you want to sort, its sort priority (up to 512 levels), and its sort direction (ascending or descending). Q&A shows you how many records it has searched and sorted as it performs the task. If you want to view more information at once, select the Table View of Forms option to see 17 records stacked vertically with the first five fields laid out horizontally across the screen. You can use another option to change the fields that appear on the table. To change information in a form, you simply retrieve the form, type the new information, and then save the form.

You can print individual forms and mailing labels without going to the Report module. To modify a Q&A database, you change the design, labels, information types, field lengths, and other aspects. If your new field won't accommodate the old information, Q&A will warn you before truncating the information. You can customize databases by selecting the display colors, shading, and underlining; by setting up custom help screens, including programming statements to save keystrokes; setting automatic initial values; and restricting values to prevent data entry mistakes.

To test the speed of Q&A's database, I ran benchmarks on a file of 500 records with 11 fields. Using nonindexed fields, Q&A was able to sort the file in ascending order in 44.9 seconds, and it found the last record in 19.7 seconds. Q&A lets you create index fields to speed up searches. You can have as many as 115 index fields (or "speedy fields," as the manual calls them). But using a large number of index fields will add to the index file and could become a disadvantage by occupying too much disk space.

The programming statements in forms can calculate field values, look up values in tables, figure dates, or move the cursor on the form. The calculations can include a variety of operators, IF...THEN statements, and other logical constructs. You enter the program statements on a Program Spec version of the form. The program is executed—either manually or automatically—when you add or update a form.

The Mass Update option lets you change information in all forms within a group at one time. You can perform mass updates with direct input of new information or through calculated values. The Utilities disk has options for importing data from PFS:File, IBM Filing Assistant, Lotus 1-2-3, Symphony, DIF, ASCII, dBASE II, and dBASE III files. You can export files in DIF or ASCII formats.

Reports

Producing reports from the database is fairly straightforward. You select the forms and fields you want, choose columns and sorting patterns for them, and decide on printing formats. You can print as many as 50 columns with up to 50 sort levels. Within this range, you can have as many as 16 derived columns and 49 invisible columns. You can store the report formats and have as many as 100 such formats per database. Within a report, calculations can use a variety of operators, including Total, Average, Count, Min, Max, or subcalculation versions of any of these.

The Intelligent Assistant

When you invoke the Intelligent Assistant from the main menu, you get a natural-language interface to the File and Report modules. After you type a request, the IA software tears it apart and tries to analyze it in terms of its built-in 400-word vocabulary, the labels of the particular database, and whatever words you have taught it. When the IA thinks it understands your question or request, it will tell you what it thinks you want done and ask for confirmation.

From the beginning, the IA works great for simple requests. You can watch the program's analysis progress as a highlighting bar forges its way through your request. Requests such as "show everybody who got a bonus" will cause the IA to dredge File and Report to retrieve the right forms and display them on the screen. You can use the IA to add, retrieve, change, or delete forms and to create reports.

A section of the user's manual explains what types of words confuse the IA and how to best talk to it. If the IA tells you that it doesn't know a word, it will give you a chance to explain. If it warns you that its understanding isn't completely clear, it will give you a chance to end the analysis.

To teach the IA, you type new words that can act as synonyms for words the IA already knows. The number of words you can teach it is limited only by disk space. In time, this ability to customize the IA greatly speeds its analysis of complex requests. You will find it responding promptly to requests such as "Give me a list of all the western managers who are making more than \$30,000 but didn't earn a bonus last year." This is exactly what most beginners expect to be able to do with a computer, and it is a massive step forward from the A > prompt. For computer enthusiasts, the IA alone is reason enough to buy Q&A. For business use, a trained IA can insulate a manager from Spec Forms and the like, and it can

make a database less frightening and more likely to be used.

Integration a Key

Q&A offers just about everything you could want in a flat-filer. It is easy to learn because of the clear user's manual and the lucid on-disk tutorial, and it is easy to use because of its standard interfaces and commands and on-line help. Conforming to such standards for the interface while expanding the range of database features behind that interface makes for a program that takes advantage of the user's previous training and yet is capable of handling many tasks.

Making the word processor more than just a notepad places Q&A outside the realm of file managers. For many small businesses, Q&A offers a tightly integrated tool for handling the three major office tasks: letter writing, information organizing, and report generating.

Other programs offer the possibility of customization through macros. Q&A has a fine macro facility, but it goes far beyond that level of customization with the IA. Although it is clumsy and slow to use

at first, as you learn its habits and vocabulary and it learns yours, you'll soon wonder why all other application programs don't have a similar facility.

The two major drawbacks to Q&A are its lack of relational facilities and its voracious memory demands, which preclude use of one or more memory-resident programs on 512K-byte systems. In addition, although hard disks are becoming standard equipment on PCs, quite a few machines still have just two floppy disk drives. The need for disk-swapping, the slow loading of new modules, and the practical exclusion of memory-resident tools may be too much of a sacrifice for many users.

Still, for anyone who needs a file manager, who could benefit from having a word processor right at hand, and who wants the help of an Intelligent Assistant, Q&A is hard to beat. In fact, it is so thorough that people who have a lot of business correspondence to attend to and are only beginning to discover the utility of database managers would do well to consider Q&A as a word processor that has a file manager attached. ■

Lyrix

George R. Allen

Lyrix version 5.0 from The Santa Cruz Operation (SCO) is a word-processing package that you can use on many different classes of computers, from the IBM PC and compatibles to large systems such as the VAX-11/780. You can transfer text files written on the IBM PC to the larger systems as well. Lyrix is designed to operate in a multiuser environment under UNIX- and XENIX-based operating systems for both word-processing and desktop-publishing applications. It does not operate under a DOS environment on PCs. The version for the IBM PC and compatibles sells for \$595; for larger systems, the price of the package varies.

I tested Lyrix on an IBM PC-compatible TeleVideo Model 2605 with 512K bytes of RAM and a 20-megabyte hard disk using SCO XENIX V Complete release 2.1. SCO says you can run Lyrix with a 10-megabyte hard disk, but I would not advise running it with less than a 20-megabyte hard disk.

I compared Lyrix to the UNIX standard vi editor with the associated UNIX text processing programs. The vi editor is the mainstay for word processing in the UNIX environment, even though it is not

a true word processor but a text editor. Lyrix won hands down in this comparison. To test the multiuser capabilities of the software, I connected an ADDS Viewpoint terminal to the serial port on my computer to get two-user operation.

Lyrix takes advantage of the file-security capabilities of the UNIX environment. In this environment, you can restrict word-processing files or documents to specific departments or individuals through the use of log-on passwords and file permissions. You can assign permissions to files, groups of people, or individuals to allow file access as required. You can also set up permissions for read-only, read-write, or nonpermission files.

Lyrix will allow only a single user to update a specific document at any one time. This prevents files from being overwritten and data being lost.

Some Comparisons

The vi editor is commonly used on many UNIX-based systems and is very popular; however, it's not easy to learn, and it lacks full-screen editing, menus, and on-line help. It cannot be easily customized

continued

Lyrix 5.0**Type**

Word processor

Company

The Santa Cruz Operation Inc.
400 Encinal St.
P.O. Box 1900
Santa Cruz, CA 95061
(800) 626-8649

Format

Two or three 5¼-inch disks,
depending on the computer you use

Computer

IBM PC, XT, AT, and compatibles;
requires 180K bytes of memory and 64K
bytes for each additional user (a
minimum of 512K bytes of RAM and a
10-megabyte hard disk are
recommended); also, a variety of
minicomputers from DEC, NCR,
Pyramid, and other companies

Necessary Software

SCO XENIX V operating system or any
XENIX system that runs on an
8088-, 80286-, 80386-, or 68000-
based computer

Language

C

Documentation

270-page user's manual; 140-page
configuration manual; 40-page tutorial;
12-page quick-reference guide

Price

\$595 for the IBM PC, XT, AT, and
compatibles; contact SCO for other
pricing and system requirements

and does not have a mail-merge feature, although it does provide an Undo command and supports underlining, boldfacing, and other text enhancements.

Because vi is a text editor, virtually any word processor will compare favorably to it, and it's no surprise that Lyrix stands out in comparison. Lyrix is suitable for beginners and offers full-screen editing, allowing you to move around the screen by using cursor-control arrows. It provides mail merging, underlining and boldfacing, an Undo command, helpful menus, on-line help, and a what-you-see-is-what-you-get display. You can also customize it more easily than vi.

Lyrix also compares favorably to DOS word processors such as WordStar. It offers all the features of WordStar, including a spelling checker. Lyrix goes further, though, offering additional features that make it more versatile than WordStar and other DOS word processors. For ex-

ample, Lyrix has a flexible customization capability that allows you to set up multiple printers as required; you can set up as many printers as you have parallel or serial ports on your system. You can also set up a given printer in draft or near-letter-quality mode and add print-quality selections to one of the Lyrix menus. I used this capability to allow printing to either my Epson or Toshiba printer in draft or NLQ modes as required.

In conjunction with UNIX, Lyrix enables you to use multiple printers simultaneously. Thus, it is possible on an IBM PC running Lyrix and SCO XENIX to print on several printers at once. I don't recommend this, as it causes the response times to slow down terribly. An IBM PC is just not fast enough to support this type of operation.

Lyrix also lets you add special command sequences to its menus. You can even customize Lyrix to look like WordStar, though this seemed like a lot of work to me; in addition, the Lyrix menus are easier to read and make more sense than WordStar's.

Desktop Publishing

If you were to compare the vi editor to WordStar in a desktop-publishing environment, you would find that WordStar is much easier to use, but vi offers more functionality. The vi editor, for example, offers automatic paragraph numbering, footnotes, headers and footers, justification, and multiple fonts. Math equation-formatting and support for output to phototypesetters are provided by the UNIX text processing programs, such as TROFF, which are normally used with the vi editor. Its table setup is cumbersome, however, and it cannot mix text and graphics.

Lyrix has almost all the capabilities of vi. It does not offer the equation-formatting or phototypesetting output. Like vi, it does not let you mix text and graphics. However, Lyrix makes it easy to set up tables and, in general, is easier to use than either vi or WordStar. Its commands make sense and are easy to remember. For example, `esc t` gets you to the top of your document, `esc f` is used to find a phrase in your document, and so forth.

Lyrix supports a multitude of printers, including Epson, Diablo, NEC, Okidata, and the Hewlett-Packard LaserJet. You can add additional printers by placing data in a configuration file called the Tcap file, which provides special effects such as underlining, boldfacing, and so forth. Good documentation and examples are provided to allow you to configure a special printer to your requirements.

The Lyrix spelling checker finds misspelled words between the current loca-

tion of the cursor and the end of the file, and it suggests possible alternatives. It uses the 80,000-word Merriam-Webster Linguibase dictionary. I wrote this article under Lyrix and used the spelling checker to check the document. Only one or two cases occurred where the spelling checker did not display the proper spelling for me; I was quite impressed with its performance.

SCO XENIX and Lyrix

Some of the performance quirks of UNIX observable on larger UNIX-based systems occurred in exactly the same manner on my computer under SCO XENIX. One particular quirk that will occasionally be annoying to hunt-and-peck typists is that the characters typed on the keyboard do not always immediately appear on the screen. Sometimes there is a delay of up to one second after a character is typed before it is displayed. All characters appear on the screen when you use Lyrix, but, under some conditions, you can enter 10 to 15 characters on the keyboard before seeing them displayed. This occurs frequently on both superminicomputers and personal computers, and it appears to be related to how busy the UNIX system is at a given time. On a PC this will be most noticeable when you send a print file to the print spooler. I found the delay annoying, but it did not interfere with the operation of the system or detract from its usefulness. SCO recommends that a PC be limited to two simultaneous terminals to maintain a reasonable response time. You can install up to eight additional terminals, but actual operation should be limited to two at a time.

SCO has set up Lyrix as a shared program, that is, a single program with separate data areas for each user on the system. This maintains excellent response times for both users. I tested this by having two people type on two terminals simultaneously. Neither person was aware that the other was also using the system. I further tested the system by running Lyrix on one terminal and a large game on the other terminal. There was insufficient memory on my 512K-byte system to hold both programs in their entirety, so SCO XENIX attempted to accommodate both by swapping them back and forth between disk and memory. As a result, the system bogged down and became so sluggish that it was impractical to use. This is not a fault of SCO Lyrix or XENIX, but a condition caused by the limited memory of the IBM PC.

Since SCO XENIX will use only 640K bytes of memory on an IBM PC or compatible, a PC is not a good choice if you plan to run two or more programs on multiple terminals at the same time. If

you expect to run an assortment of programs simultaneously, your best choice would be to use an IBM PC AT or compatible, on which SCO XENIX will support up to 16 megabytes of memory. Consequently, if you install sufficient memory in your PC AT, you should never run into these problems. For example, a colleague who runs SCO XENIX on a PC AT operates in a multiuser environment using different programs on several terminals. He has not experienced any sluggishness on his PC AT and is pleased with the response of the system.

If you currently use PC-DOS or MS-DOS and wish to convert to SCO XENIX for word processing in a multiuser environment, you can transfer files back and forth between DOS and SCO XENIX by using a series of utilities provided with the system. The main utility that I used was doscp, which allows you to copy files from the SCO XENIX portion of your hard disk to and from the DOS portion. This utility may not be of value in all cases; if the files transferred are encoded or are not in ASCII, they may not be intelligible under Lyrix. I used doscp to transfer Lyrix text files for this article to a DOS floppy disk.

Setting Up

The documentation supplied with both SCO XENIX and Lyrix is quite good, and there is an enormous amount of it. This is both a plus and a minus, however. Any information that you need to know is in one of three manuals. Unfortunately, it may take a lot of wading through them to find the information that you need.

The manuals describe in detail how to configure and use SCO XENIX and Lyrix under all conceivable conditions. The setup of SCO XENIX is straightforward and is adequately described in the installation guide supplied with the software. The only problem I encountered was that the instructions did not specifically say to install the printer on the system. When my printer did not work right away, I looked in the manual for printer-installation instructions. These instructions were clear and did not present any problems.

Installation time for XENIX is considerably longer than the installation time for a DOS system. It took me about five hours to install SCO XENIX on my TeleVideo 2605 the first time. This included the time that SCO XENIX needed to format and verify the 20-megabyte hard disk on the computer. While the instructions are straightforward, the installation process will probably be intimidating to a computer neophyte. From a practical standpoint, the installation should be attempted only by someone who is familiar

with computers in general. Prior knowledge of XENIX or UNIX is not required.

Installation of Lyrix is quite simple and hardly bears mentioning. The process took me only about a half hour.

A Good Choice for ATs

I have used SCO XENIX with the vi editor for almost a year and have had no problems. I have also used WordStar and Microsoft Windows Write. However, I now use Lyrix exclusively because of its ease of use and flexibility. In my working environment where my two terminals

both run Lyrix, performance is good using the IBM PC. I strongly recommend, however, that if you consider using Lyrix and SCO XENIX, that you purchase a PC AT-compatible system to avoid the occasional response problems caused by the slower IBM PC. ■

George R. Allen (P.O. Box 583, Binghamton, NY 13902) has been involved with computer systems for the past 23 years. He is now a software design manager for a large industrial firm, where he works with UNIX-based systems.

DATA ACQUISITION: Get system capability at a board-level price. The System 570 is a personal computer based Data Acquisition Workstation with the extensive signal capacity you need: 32 analog inputs (or 16 differential), 2 analog outputs, 16 digital inputs, 16 digital outputs, 16 power control lines. The price is only \$1425, complete with our powerful Soft500 software, an extension of advanced BASIC that provides foreground/background architecture, array and memory management, disk access and storage, and over 45 additional commands.

An expansion slot lets you extend your System 570's capabilities by selecting from an extensive library of optional input/output modules. And you can use the 570 with other data acquisition software such as DADiSP, ASYST™, and Labtech Notebook.

For complete information, a demonstration, or applications assistance, call toll free:

1-800-552-1115

32
2
16
16
+ 16
\$1425



REVIEW FEEDBACK

STELLA

Stephen B. Robinson's review of STELLA (December 1986) is exemplary in its dispassionate discussion of what the program can do, as well as the chief things it cannot do—cut, copy, and paste. But STELLA is such a bright star in the software firmament that one could be forgiven for displaying some passion in response to its appearance. Were I to be banished to a desert island with a solar-powered Macintosh and five programs, STELLA would be one of them.

I have three wishes for future versions of STELLA: to be able to add text to diagrams and graphs, to have a simulation pause at programmed times for entry of data through the keyboard, and to have junction boxes and tanks where the total flow in is automatically equated to the total flow out. In Mr. Robinson's review, an Editor's note referred to a preliminary version of an update that includes a cut-and-paste feature. Let's hope that the other omissions that I have mentioned will also be included.

Don Watson
Melbourne, Victoria,
Australia

QuickBASIC 2.0

I enjoyed reading Dennis Dykstra's review of Microsoft QuickBASIC 2.0 (February). I own and use QuickBASIC 2.0, BASICA, and True BASIC 2.0. QuickBASIC 2.0 is, of course, an enormous improvement over prior Microsoft compiler/interpreter versions of BASIC and includes a major restructuring of the language. My major regret is that QuickBASIC 2.0 was compared only to ZBasic and GW-BASIC in the review.

I urge BYTE to conduct a real apples-to-apples comparison of QuickBASIC 2.0, True

BASIC 2.0, and, perhaps, BetterBASIC. All now have run-time packages that permit the generation of stand-alone .EXE programs. QuickBASIC 2.0 is very good, but, in my opinion, True BASIC 2.0 shines even brighter.

Jerry Davis
Concord, MA

Toshiba T1100 Plus

As an owner and user of a T1100 Plus undergoing the usual second thoughts, I was interested in John D. Unger's article "Four Portable Computers" in the February issue.

Oddly enough, the only problem I have had with my T1100 Plus is in precisely the same area in which I use it most frequently—running Microsoft Word. The integrated keypad design of the T1100 Plus simply will not work with several of the out-line-processing features of Word 3.0. However, that is the only compatibility problem I've run into so far.

I would like to point out that Toshiba's Floppy Link, which allows the T1100 Plus to use a desktop's 5¼-inch drive as its own, works with only a limited number of machines and is guaranteed only for the IBM PC and the Compaq.

Finally, the T1100 Plus comes with MS-DOS 2.11, but not with GW-BASIC; in fact, errata slips in the documentation that came with my unit specifically deleted all references to BASIC.

Richard Brzustowicz Jr.
Seattle, WA ■

REVIEW FEEDBACK is a column of readers' letters. We welcome responses that support or challenge BYTE reviews. Send letters to Review Feedback, BYTE, One Phoenix Mill Lane, Peterborough, NH 03458. Name and address must be on all letters.

*In our April review of dot-matrix printers (see table 1, page 205), the figures for sound levels recorded in the graphics mode were incorrect. The correct figures appear below. Sound level is in dB (0 dB = .0002µbar); * = not available.*

Company	Model	Sound level		
		Draft	NLQ	Graphics
Advanced Matrix Technology	AMT 2002	73	82	*
Alps America	ALQ218	70	70	74
	ALQ324	70	71	72
	P2000	70	67	74
	P2100	65	63	75
Brother International Corp.	2024L	70	73	77
	M-1709	71	68	81
C. Itoh Digital Products Inc.	C-310XP	70	69	74
	C-815 Supra	76	72	82
Canon USA Inc.	A-50	70	71	84
	A-60/G	71	70	79
Citizen America Corp.	120D	71	70	84
	Tribute 224	73	74	*
Dataproducts Corp.	8012	69	67	75
	8070 Plus	73	71	78
Datasouth Computer Corp.	DS 180 Plus	75	*	*
Epson America Inc.	EX-1000	71	70	81
	LQ-2500	72	72	80
Fujitsu America Inc.	DL 2600	70	68	78
	DX 2200	72	71	80
Genicom Corp.	1020	72	71	78
	3210	78	76	86
	3410.02	*	*	*
IBM Corp.	Proprinter XL	75	73	79
Infoscrite Inc.	1100P	77	75	*
	1400	74	72	*
JDL Inc.	JDL-850 EWS	67	65	69
Mannesmann Tally	MT-290	74	72	84
	MT-490	*	*	*
NEC Information Systems	P5XL	69	73	75
Newbury Data Inc.	OSP-3	71	72	84
Nissho Information Systems	NP-2410	72	71	72
	NP-910	72	71	79
Okidata	ML193 Plus	73	71	79
	ML294	72	70	78
Olympia USA Inc.	NP 136	70	69	84
Output Technology Corp.	OT700e	79	79	89
Panasonic Industrial Co.	KXP-1092i	72	73	83
	KXP-1080i	72	73	83
	KXP-1091i	71	69	*
Printronic Inc.	P1013	79	78	83
Seikosha America Inc.	BP-5420 AI	70	70	78
	MP-1300 AI	71	68	78
	SI-80 AI	67	69	73
Star Micronics America Inc.	NB24-15	74	75	83
	NR-15	74	71	83
	NX-15	72	70	82
Tandy Corp./Radio Shack	DMP 130	63	62	65
	DMP 2110	70	74	82
	DMP 430	72	74	83
Texas Instruments Inc.	Omni 880	70	69	77
Toshiba America Inc.	P341e	75	74	*
	P351-2	71	72	85

With all these SoftLogic Solutions, you could run out of problems.

Now there's a whole family of low-cost, easy to use SoftLogic Software for the IBM PC, XT, AT, and compatibles. They'll save you time, aggravation, and lots of money. Got a problem? Check out these SoftLogic Solutions.



Software Carousel™—The easy way to move from one program to another.

Now keep up to ten different programs loaded and ready to run—and switch from one to another in an instant. Plus use all available memory with each and every program. Supports AboveBoard™ and RAMPage™. New Version 2 is even faster and more powerful. \$59.95*

Disk Optimizer™—Speeds up your disk by cleaning up your files.

You may not notice, but your hard disk is getting slower. Because your files keep getting fragmented and scattered on your disk. Disk Optimizer puts back the speed by putting your files back in one piece—where they belong. Now faster, with even more powerful features. \$59.95*

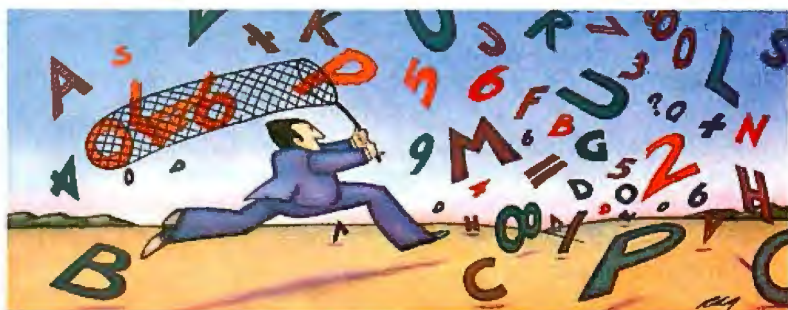

Cubit™—Packs more of your data onto less disk space.

Filling up your hard disk again? Don't run out and get a bigger drive. Get Cubit, and get up to twice the storage capacity from the drive you already have. Cubit compresses and decompresses word processor, spreadsheet, database, all kinds of files—quickly, safely, invisibly. \$49.95*

DoubleDOS™—The multitasking software that takes less of everything.

You can spend more money, load more memory, and read more manuals with systems like TopView™ or Windows™. Or you can get DoubleDOS, the amazing concurrent software system that lets you and your computer each work on different tasks at once. \$49.95*

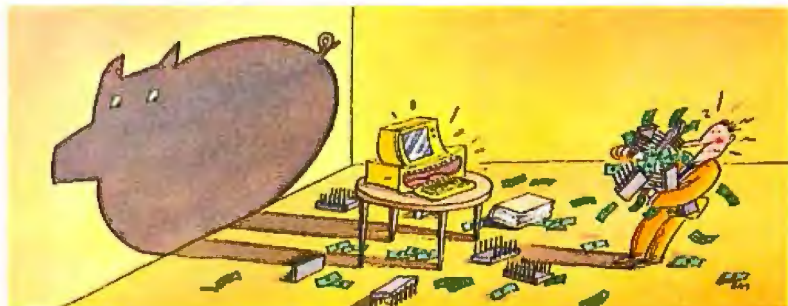

**NOT COPY
PROTECTED!**

SOFTLOGIC SOLUTIONS

SoftLogic Solutions, Inc.
530 Chestnut Street
Manchester, NH 03101

Put your problems behind you! Order today!

Look for SoftLogic products at better computer dealers everywhere. Or order direct from SoftLogic Solutions by calling 800-272-9900 (603-627-9900 in NH).

800-272-9900
(603-627-9900 in NH).

* plus \$5.00 shipping and handling.

Six great reasons to join **BIX** today

- **Over 140 microcomputer-related conferences:**

Join only those subjects that interest you and change selections at any time. Take part when it's convenient for you. Share information, opinions and ideas in focused discussions with other BIX users who share your interests. Easy commands and conference digests help you quickly locate important information.

- **Monthly conference specials:**

BIX specials connect you with invited experts in leading-edge topics—CD-ROM, MIDI, OS-9 and more. They're all part of your BIX membership.

- **Microbytes daily:**

Get up-to-the-minute industry news and new product information by joining Microbytes.

- **Public domain software:**

Yours for the downloading, including programs from BYTE articles and a growing library of PD listings.

- **Electronic mail:**

Exchange private messages with BYTE editors and authors and other BIX users.

- **Vendor support:**

A growing number of microcomputer manufacturers use BIX to answer your questions about their products and how to use them for peak performance.

What BIX Costs. . How You Pay

ONE-TIME REGISTRATION FEE: \$25

Hourly Charges: (Your Time of Access)	Off-Peak 6PM-7AM Weekdays Plus Weekends & Holidays	Peak 7AM-6PM Weekdays
BIX	\$9	\$12
Tymnet*	\$2	\$6
TOTAL	\$11/hr.	\$18/hr.**

* Continental U.S. BIX is accessible via Tymnet from throughout the U.S. at charges much less than regular long distance. Call the BIX helpline number listed below for the Tymnet number near you or Tymnet at 1-800-336-0149

** User is billed for time on system (i.e., 1/2 Hr. Off-Peak w/Tymnet = \$5.50 charge.)

BIX and Tymnet charges billed by Visa or Mastercard only.

BIX HELPLINE

(8:30 AM-11:30 PM Eastern Weekdays)

U.S. (except NH) and Canada—1-800-227-BYTE
Elsewhere (603) 924-7681



We'll
Send
You a

BIX User's Manual and Subscriber Agreement
as Soon as We've Processed Your Registration.

JOIN THE EXCITING WORLD
OF BIX TODAY!

JOIN BIX RIGHT NOW:

Set your computer's telecommunications program for full duplex, 8-bit characters, no parity, 1 stop bit OR 7-bit characters, even parity, 1 stop using 300 or 1200 baud.

Call your local Tymnet* number and respond as follows:

Tymnet Prompt

Garble or "terminal identifier"
login:
BIX Logo—Name:

You Enter

a
bix <CR>
new <CR>

After you register on-line, you're immediately taken to the BIX learn conference and can start using the system right away.

FOREIGN ACCESS:

To access BIX from foreign countries, you must have a packet switching account with your local Postal Telephone & Telegraph (PTT) company. From your PTT enter 310600157878. Then enter bix <CR> and new <CR> at the prompts. Call or write us for PTT contact information.

BIX

ONE PHOENIX MILL LANE
PETERBOROUGH, NH 03458
(603) 924-9281

Electronics FREE. If You Qualify.

- YES**, begin my **FREE** subscription to **Electronics** magazine, if I qualify.
- No, I am not interested in this free offer.

Signature _____ Date _____

Company affiliation and address must be given. Application must be signed and dated.

Name _____ Title _____

Company _____

Div. or Dept. _____

Address _____

City _____ State _____ Zip _____

Check here if you wish publication to be sent to home address

Street _____

City _____ State _____ Zip _____

TO QUALIFY, you must answer all questions. The publisher reserves the right to serve only those individuals who qualify for a free subscription. This application becomes void if improperly completed.

1. The primary end product (or service) at your plant, and the product (or service) that is your own work. (Insert one code for each)

Plant **Own work**

- A. Computers, data processing/peripheral equipment, office/business machines
- B. Communications, data communications, telecommunications equipment
- C. Navigation and guidance, aircraft/missile systems and equipment (oceanography)
- D. Test and measurement equipment
- E. Consumer products (TV, radio, hi-fi, recorders, home computers, appliances)
- Q. Medical systems and equipment
- R. Industrial control systems and equipment
- G. Semiconductor production equipment (component insertion, coil winding, etc.)
- H. Electronic sub-assemblies, components and materials (active and passive components, ICs, discretes, hybrids, power supplies)
- I. Other manufacturers using electronic equipment as part of their manufacturing process (machine tools, chemicals, metals, plastics, pharmaceuticals, etc.)

- J. Government and military
- K. Independent research and development laboratories or consultants
- L. Research and development organizations within an educational institution
- M. Independent software developers
- N. Operators of communications equipment (utilities, railroads, police, airlines, broadcasters, etc.)
- O. Educational: 2-4 year colleges, universities
- P. Other (please describe) _____

2. Your principal job function: (Insert one code only)

- A. Corporate management (owner, partner, president, VP, etc.)
- B. Operating management (general manager, group manager, division head, etc.)
- C. Engineering management (project manager, chief engineer, section head, VP of engineering, VP of research and development, VP of quality control, etc.)
- D. Software engineering
- E. Systems engineering/integration
- F. Quality control engineering (reliability and standards)
- G. Design engineering
- H. Engineering support (lab assistant, etc.)
- I. Test engineering (materials, test, evaluation)
- J. Field service engineering
- K. Research and development (scientist, chemist, physicist, etc.)
- L. Manufacturing and production
- M. Purchasing and procurement
- N. Marketing and sales
- O. Professor/instructor at _____
- P. Senior student at _____
- Q. Graduate student at _____
- Z. Other (please describe) _____

3. Your principal responsibility: (Insert one code only)

- 1. General management
- 2. Engineering management
- 3. Engineering
- 4. Other _____

4. What is your title? (Insert one code only)

Operations Management

- 01. President/Chairman/Owner/Partner
- 02. Vice President
- 03. Vice President of Engineering
- 04. Product Marketing Manager

Engineering Management

- 11. Technical Director
- 12. Chief Engineer
- 13. Principal Engineer
- 14. Research Director
- 15. Section Head
- 16. Project Engineer
- 17. Senior Engineer
- 18. Software Manager
- 19. Senior Test Engineer
- 20. Senior Field Test Engineer
- 21. Manufacturing/Production Manager
- 22. Group Leader
- 23. Department Head
- 24. Other Management (explain) _____

Design or Standards Personnel

- 31. Systems Engineer
- 32. Software Engineer
- 33. Test Engineer
- 34. Field Test Engineer
- 35. Manufacturing Engineer
- 36. Production Engineer
- 37. Engineer
- 38. MTS
- 39. Consultant
- 40. Scientist
- 41. Physicist
- 42. Other Staff (explain) _____



NO POSTAGE
NECESSARY
IF MAILED
IN THE
UNITED STATES



BUSINESS REPLY MAIL

FIRST CLASS PERMIT NO. 42 HIGHTSTOWN, N.J. 08520

POSTAGE WILL BE PAID BY ADDRESSEE

Electronics

McGraw-Hill Publications Company

P.O. Box 641

Hightstown, NJ 08520-0641

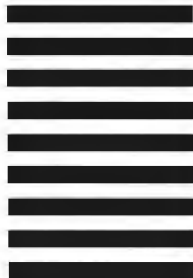



FREE!

Electronics... The Magazine That Gives You Technology With Perspective.

There's simply no other magazine like Electronics! It brings to your desk the comprehensive coverage and perspective you need, no matter what your job or responsibilities are. Electronics provides you with technical information on computers, data processors, peripheral equipment, office and business machines, communications equipment and semiconductors. Information that keeps you abreast of industry breakthroughs, trends and business directions. It gives you the savvy needed to compete.

Each issue focuses in on the meaningful technological developments and concerns driving the electronics industry.

Why Is Electronics Free to Professionals Like You?

By controlling circulation, we make our readership fit our editorial. Editorial for important people, like you, who need the important information only Electronics provides.

And it's yours, FREE...if you qualify. Simply fill out and return the adjacent card. If you qualify, we'll start your subscription with the very next issue of Electronics.



Electronics

**We Must Receive
Your Card By
May 31
1987**

A world of information at your fingertips.

It's as simple as . . .

ABC

A world of information is at your fingertips through Automated Language Processing Systems' newest software product, ABC WORD™. This translator's and writer's assistant program provides access to reference dictionaries (monolingual, bilingual and thesaurus) from within the user's word processor.

ABC WORD can be accessed from a number of popular word processors, including Word Perfect®, WordStar®, VolksWriter, Displaywrite® and Multimate®.

Reference dictionaries provided with ABC WORD are user modifiable, and users can incorporate their own reference materials into separate user dictionaries.

ABC WORD runs on PC-DOS 2.1 or even better on the IBM PC/XT or PC/AT (or 100% compatibles) with at least 512K of memory and one hard disk drive. Both monochrome and color monitors are supported.

IT'S AS SIMPLE AS ABC.

See us at
Booth #3534

 **COMDEX/Spring**

Georgia World Congress Center
Atlanta, Georgia

ABC WORD is a trademark of Automated Language Processing Systems, Inc.; Word Perfect is a trademark of Word Perfect, Inc.; WordStar is a registered trademark of MicroPro International Corporation; DisplayWriter is a registered trademark of IBM Software; Multimate is a registered trademark of Ashton-Tate. IBM PC/XT or PC/AT are registered trademarks of International Business Machines Corp.

**Automated Language
Processing Systems**

U.S. HEADQUARTERS

ALP Systems, Inc.
295 Chipeta Way
P.O. Box 8719
Salt Lake City, Utah 84108
Telephone: 1-800-354-5656
Telephone: 1-801-584-3000
Telex: 453-195 ALPS PRVO
Telefax: 1-801-584-6483

EUROPEAN HEADQUARTERS

ALP Systems, S.A.
Route de Boudry 14
CH-2016
Cortailod/
Neuchâtel
Switzerland
Telephone:
41.38.44.21.11
Telex: 952-751
Telefax:
41.38.42.11.85
Inquiry 14

Kernel

Computing at Chaos Manor:	
Bye-Bye Big Kat.....	261
<i>by Jerry Pournelle</i>	
According to Webster:	
Publish and/or Perish.....	279
<i>by Bruce Webster</i>	
Applications Only:	
Mostly Mac	293
<i>by Ezra Shapiro</i>	
Mathematical Recreations:	
Around and Around	307
<i>by Robert T. Kurosaka</i>	



CONNECT.



OCR SCANNING

Our "SCANNING CONNECTION" system can be used to read your paper documents into a PC. Pictures and graphs can be scanned and saved in various file formats for use by many word processing and desktop publishing systems. Text images can be converted to character text for use with most word processing and typesetting systems. Images can be sent over telephone lines to another PC or a facsimile machine.

We have developed a special controller card for high speed compression of images and for character recognition. Books, magazines, newsprint, reports and typed documents can be read by our OCR software. The software can be trained to recognize almost any font style. System prices including scanner and software start at \$1795.

9-TRACK TAPE

With our "TAPE CONNECTION" system you can read and write most 1/2" 9-Track magnetic tapes using your PC. Tapes can be 800, 1600, or 6250. Our file transfer software can process ANSI labeled tapes from most computer systems including DEC, HP, HONEYWELL, and IBM. Large files from multivolume tape reels can be transferred to a disk at rates up to 5 MB/min. Software is provided to use the system for backup of the hard disk on your PC.

With more than twenty years experience in working with tape drive systems, we can solve most PC tape conversion problems. We can supply more than ten different tape drive models. System prices including tape drive, controller card, and software start at \$3495.

DISKETTE CONVERSION

We specialize in conversion systems and can transport your documents or images to almost any computer, word processing, or typesetting system. With our "DISKETTE CONNECTION" system you can read and write most 8", 5 1/4", or 3 1/2" diskettes using your PC. We support systems from DEC, CPT, WANG, NBI, LANIER, HONEYWELL, and XEROX. We support most IBM systems including 3741, S/36, PC/36, 4300, and Displaywriter.

Since 1981 we have developed hundreds of software programs and designed many specialized diskette hardware products. With thousands of installations worldwide, we are probably the world leader in manufacturing diskette conversion systems. System prices including diskette drive, controller card, and software start at \$1195.



Inquiry 116 for End-Users.
Inquiry 117 for DEALERS ONLY.



Bye-Bye Big Kat

Jerry Pournelle

Big Kat goes off to college, and the flaky Zelda replaces him

I started this on the BART train under the San Francisco Bay. I was trying to write on Zebediah, my Zenith Z-181 portable, but I didn't get very much done.

It wasn't Zeb's fault. He is a bit heavy, and the case is slick enough that it will slip off your lap if you're not careful, but it is possible to hold the machine there; and that bright blue backlit screen is readable in any light conditions I've yet found. In my experience, two full-feature PC-DOS portables are worth considering: the Z-181 and the Toshiba T3100 with its hard disk. The Toshiba isn't a laptop, but the Z-181 is supposed to be. It runs for hours on batteries. The screen is large enough. But I simply couldn't write on that BART train.

The problem wasn't the computer, but the American Tourister case. I found it impossible to leave the machine in the case, and nearly as difficult to take the machine out and close it up. There's almost no way to keep disks in that case once it's been opened: the thing is optimally designed to drip its contents onto the floor. Since the Z-181 runs only a few hours—three to five, depending on how much disk access you do—between charges, I generally want the somewhat heavy and badly designed power supply in the case with the Z-181, and there's no separate compartment for it. The cords very much get in the way.

In fact, there aren't any truly separate compartments for *anything* in that case. There's a flap, but it's made of thin cloth and holds nothing. The result is that the only stiffening is provided by the computer itself, and once you remove that, all the disks, documents, templates for WordPerfect, small tools, cables, and other stuff that you'd like to keep with a full-featured portable are mixed together into a random stew—or else the stuff falls out onto the floor, as it did with me. I actually missed my BART stop because I was trying to retrieve disks that had dripped from the Z-181's case.

Apparently Zenith put all its design skill into the Z-181 itself and ordered the case and power supply as afterthoughts. If the Z-181 sells as well as it ought to, someone will make a fortune selling well-designed cases to carry it in. While they're at it, they might design a lightweight handle to attach to the computer itself.

Communication by Alligator

It's a tendency in modern hotels. The phone system is set up so you don't have to talk to anyone to dial out; just dial 8, or 9, and then the number. The phones are almost all Touch-Tone, too, so it ought to be easy to connect them to modems. It seldom is easy, though, because the telephone instrument is hard-wired into the system. Since nearly all modems now expect you to use a modular plug, this presents a problem if it's midnight in the San Francisco Hilton and you desperately need to log on to BIX.

I was in that situation recently. I thought of two possible solutions. First, I carry a spare telephone cord. The *instrument* was hard-wired, but was the other end at the wall? Alas, that was well behind the bed, and short of moving a massive piece of furniture, I wasn't going to find out. (Incidentally, why are phones always at the bed and never at the worktable, even in hotels that say they cater to business travelers?)

The second solution was given to me by Dr. Robert Bussard, who sent me a modular plug that ends in four color-coded alligator clips. I'd carried it to many places, but I'd never been desperate enough to use it. This time I was.

With a certain amount of trepidation, I took the telephone apart with my Swiss army knife. The cover came off easily

enough, and once inside the job was simple, barring the fact that the phone was now permanently off the hook. The wires from the wall plug terminated just inside the instrument and had the four colors all phone lines seem to have now. Two of them are still called "tip" and "ring," presumably carryover names from the days when phone plugs and jacks were larger. I don't know which is which, or indeed which two of the four lines are significant, so I used the alligator clips to connect similar colors of all four lines from my bit of phone cable and plugged the other end into the line port on the Z-181's modem.

Voilà! Everything worked fine. There was a bit of line noise, and after I was connected to BIX I managed to hang up the phone instrument. I was still connected, and most of the noise went away. As I'd suspected, the telephone instrument was now totally irrelevant.

I don't suppose the Hilton would have approved, but in fact I had no problems, either with BIX or in getting the phone put back together. Let me hasten to add that I don't recommend that you try this.

Communications, Continued

Last month I mentioned the difficulties I had in getting the Z-181 to communicate files to Big Kat, the Kaypro 286i PC AT clone. The Zenith PCXFER program says "use a null modem," but in fact that's an insufficient instruction. What they mean by "null modem" is a cable of considerable complexity. I'll repeat the formula for those who missed last month's issue.

Take a standard 25-pin RS-232C cable and alter. Pin 1 goes straight through. Cross-connect (i.e., swap over) pins 2 and 3. Swap 4 and 5. Cross-connect 6 and

continued

Jerry Pournelle holds a doctorate in psychology and is a science fiction writer who also earns a comfortable living writing about computers present and future.

Even More Power & Flexibility

BRIEF 2.0

BRIEF easily conforms to your editing preferences and style, ensuring you are truly comfortable and productive.

Straight from the box, BRIEF is as much editor as most people will ever need — thanks to features like the real Undo, flexible windowing, and unlimited file size.

But BRIEF's hidden power is in its exclusive macro language. Customize BRIEF to include the commands and features YOU desire. It's fast and easy.

industry press alike unanimously praise BRIEF. "ended." — Jerry Pournelle, Byte 12/86.

Now BRIEF 2.0 adds:

- Setup Program for easy installation and configuration. (Requires no macro knowledge).
- Increased speed for sophisticated operations like Undo and Regular Expression Search.
- All new documentation WITH tutorial on the Macro Language.
 - Command line editing (move cursor, add & delete characters, specify parameters).
 - Expanded Regular Expressions, with matching over line boundaries.
 - More block types, with marking by character, line or column.
 - Reconfigurable indenting for C files (supports most indenting styles).
 - Enhanced large display support, including wider displays.
- Optional borderless windows.

BRIEF (\$195) for 30 days—if not satisfied get a full refund.
If you already own BRIEF, call for update info.

CALL 800-821-2492
In MA 617-659-1571

Solution Systems

335-B Washington St.
Norwell, MA 02061



Basic Features

- Windows
- Multi-level Undo
- Edit many files at once.
- File size limited only by disk space.
- Automatic language sensitive indentation.
- EGA and Hercules Plus 43-line support
- Compile & find errors within BRIEF

And much, much more!

Requires 1 IBM PC, AT or compatible with 192K.

20. Pins 7 and 8 go straight through. Given all that, PCXFER worked fine to transfer files to and from Lucy Van Pelt, our genuine IBM PC; and indeed, it works with any normal PC or XT. The program is a little slow, but it's automatic and understands wild-card instructions.

I couldn't get PCXFER and that cable to work with an AT. It turns out there was a very good reason: 25-pin connectors on AT-style machines, including the Kaypro, are parallel ports. Serial ports on an AT have only 9 pins.

Okay, I should have known that. It's even stated in Kaypro's documents, and now that I'm sensitized I've seen it elsewhere. The fact is, I didn't know.

The IBM PC has two 25-pin ports, one serial, one parallel. The Z-181 has two 25-pin ports (actually three), and one is the serial port. The Kaypro 286i AT has two 25-pin connectors on the back. One is on the Hercules Color Card video board and is clearly labeled parallel. It ran the printer fine. The other is, of course, on the I/O card that also contains a 9-pin port. For not very intelligent reasons, I assumed those were two different serial ports, or possibly two different configurations of the same serial port. The 9-pin port was used to connect the Logitech mouse, and it worked fine. The 25-pin port wouldn't work with PCXFER, even with the snazzy "null-modem" cable I'd made to Zenith's specs.

It never would work, of course, because the 25-pin port is an extra parallel port and can even be connected to another parallel device, provided only that both devices aren't turned on at the same time.

I found this out from BIX correspondents shortly after filing last month's column. It says a lot for the wretched state of "standards" in this industry that so few were surprised by my problems that it took a week before someone noticed I was trying to do the impossible. People expect serial communications problems.

Alas, the Zenith PCXFER documents don't give any clues about cabling to a 9-pin connector. I have a couple of cables that do have a 25-pin port on one end and a 9-pin port on the other, and using those and WireTap (an inexpensive breakout box; see last month's column) I experimented for an hour, but I never did get the Z-181 to talk to the Kaypro or to a Zenith Z-248 AT clone for that matter.

Eventually I ran out of time. I used PCXFER to send my files from the Z-181 into Lucy Van Pelt, then used the CompuPro network to transfer those files to the big CompuPro, and from that to the Kaypro. It meant one more copy command, but nothing else special, so except for

continued

Full color. Half size.

The Hercules® Color Card. Full color. Full power. And just half the size. Yet, it runs all the same graphics and text software that the IBM® Color Graphics Adapter runs—including business and recreational software like Lotus® 1-2-3® and Microsoft® Flight Simulator.

The Hercules Color Card fits in either the long or short slots of your IBM PC, XT and AT, and in most compatibles.

Ask for the Hercules Color Card. Or, if you don't need a parallel port, ask for the Hercules Color Card/NP.

For the name of the dealer nearest you call 1-800-532-0600 Ext. 802 (in Canada 1-800-323-0601 Ext. 802)

Hercules Computer Technology
2550 Ninth Street
Berkeley, California 94710
Ph: (415) 540-6000 Telex: 754063
Trademarks Owners: IBM/IBM Lotus/1-2-3/Amc.
Microsoft/Microsoft: Hercules/Hercules.

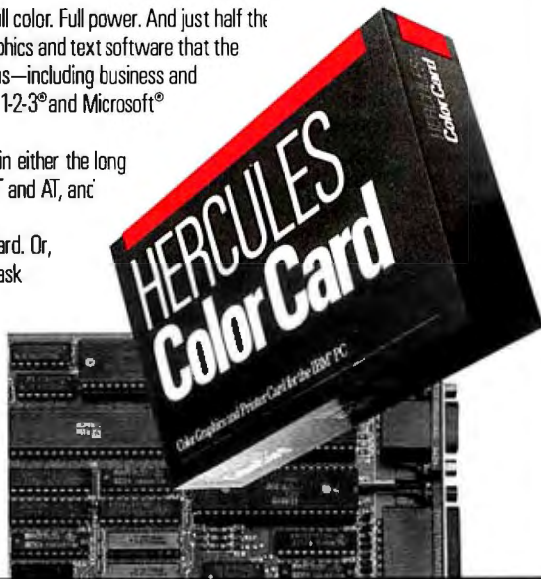

THE PROGRAMMER'S SHOP

helps save time, money and cut frustrations. Compare, evaluate, and find products.

Personal COBOL by MicroFocus -

Develop, test, debug, executive ANSI 74 code. Full-screen editor, syntax checker, Animator, forms/screen generator, help. Compatible with Level II. PC \$ 169

Arity Combination Package PC \$1119
 System - use with C MS \$ 259
 SQL Dev't Package MS \$ 259
 Auto-Intelligence PC \$ 749
 Expertech - Powerful, samples PC \$ 349
 Exsys PC \$ 309
 Runtime System PC \$ 479
 Insight 2+ MS \$ 379
 Intelligence/Compiler PC \$ 749
 Texas Instruments:
 PC Easy PC \$ 435
 Personal Consultant Plus PC \$2589

AI-Lisp

Microsoft MuLisp 85 MS \$ 159
 PC Scheme LISP - by TI PC \$ 85
 TransLISP - learn fast MS Call
 TransLISP PLUS
 Optional Unlimited Runtime Call
 PLUS for MSDOS Call
 Others: IQ LISP (\$155), IQC LISP (\$269)

AI-Prolog

APT - Active Prolog Tutor - build applications interactively PC Call
 ARITY Standard - full, 4 Meg
 Interpreter - debug, C, ASM PC \$ 309
 COMPILER/Interpreter-EXE PC \$ 699
 With Exp Sys, Screen - KIT PC \$119
 Standard Prolog MS \$ 79
 MacProlog Complete MAC \$ 269
 MicroProlog - Professional
 Entry Level MS \$ 85
 MicroProlog Professional
 Compiler/Interpreter MS \$ 439
 MPROLOG P550 PC \$ 175
 Prolog-86 - Learn Fast MS \$ 89
 Prolog-86 Plus - Develop MS \$ 229
 TURBO PROLOG by Borland PC \$ 69

Editors for Programming

BRIEF Programmer's Editor PC Call
 EMACS by UniPress Source: \$929 \$ 299
 Epsilon - like EMACS, full
 C-like language for macros. PC \$ 155
 KEDIT - like XEDIT PC \$ 99
 Lattice Screen Editor - multiwindow, multitasking Amiga \$ 89 MS \$ 109
 Micro Focus Micro/SPF PC \$ 139
 PC/EDT - macros PC \$ 229
 PC/VI - by Custom Software MS \$ 109
 Personal REXX PC \$ 99
 PMATE - power, multitask PC \$ 119
 SPF/PC - fast, virtual memory PC \$ 139
 Vedit MS \$ 107
 Vedit PLUS MS \$ 139

FEATURE

F2C by Solution Systems - Fortran 66 or 77 to C. No max program size \$3000. Pioneer. 1000 line max: \$795

700+ Programmer's Product

The Programmer's Shop carries every programmer's software product for MSDOS, PC DOS, CPM, Macintosh, Atari and Amiga systems. help you choose the best products for you. Most products are in stock, available for quick delivery. We will gladly special order a product for you at no charge — just allow a few extra days for delivery.

Need Cross Compilers, Translators, or the right Fortran compiler? Ask us.

Our Services:

• Programmer's Referral List • Dealers Inquire
 • Compare Products • Newsletter
 • Help find a Publisher • Rush Order
 • Evaluation Literature FREE • Over 700 products
 8S - 7 PM to 7 AM 617-826 • National Accounts Ctr.

AZTEC C86 - Commercial PC \$499
 C86 PLUS - by CI MS Call
 Datalight C - fast compile, good code, 4 models, Lattice compatible, Lib source. Dev's Kit PC \$ 77
 Datalight Optimum - C MS \$ 99
 with Light Tools by Blaise PC \$168
 Lattice C - from Lattice MS \$275
 Mark Williams - w/debugger MS \$369
 Let's C Combo Pack PC \$ 99
 Let's C PC \$ 59
 Microsoft C 4.0- Codeview MS \$275
 Uniware 68000/10/20 Cross
 Compiler MS Call
 Rex - C/86 by Systems &
 Software - standalone ROM MS \$695
 Wizard C MS \$299
 Rom Development Package MS \$259

C Language-Interpreters

C-terp by Gimpel - full K & R MS \$229
 C Trainer - by Catalytix PC \$ 89
 INSTANT C - Source debug, Edit to Run-3 seconds, .OBJs MS \$379
 Interactive C by IMPACC Assoc. PC \$209
 Run/C Professional MS \$159
 Run/C Lite MS \$ 89

C Libraries-General

Blackstar C Function Library PC \$ 79
 C Essentials - 200 functions PC \$ 75
 C Function Library MS \$109
 C Tools Plus (1 & 2) - Blaise PC \$125
 C Utilities by Essential PC \$135
 C Worthy Library - Complete, machine independent MS \$249
 Entelekon C Function Library PC \$119
 Entelekon Superfonts for C PC \$ 45
 Greenleaf Functions-portable, ASM \$139
 LIGHT TOOLS by Blaise PC \$ 69

Atari ST & Amiga

We carry full lines of Manx, Lattice, & Metacomco.

Call for a catalog, literature and solid value

800-421-8006

THE PROGRAMMER'S SHOP™

Your complete source for software, services and answers

5-B Pond Park Road, Hingham, MA 02043

Mass: 800-442-8070 or 617-740-2510 3/87

TurboC by Borland. ANSI

Compiler supports 6 models including tiny and huge, has floating point, interactive editor, Make. Speed development. PC \$ 75

Clipper compiler PC Call
 dBASE II MS \$329
 dBase III Plus PC \$429
 dBASE III LanPack PC \$649
 DBXL Interpreter by Word Tech PC \$139
 FoxBase+ - single user MS \$349
 Quick Silver by Word Tech PC \$499

dBase Tools for C PC \$ 65
 dBrief with Brief PC Call
 DBC ISAM by Lattice MS \$179
 dBx Translator to C+ MS \$319
 dFlow - flowchart, xrcf MS Call
 Documentor - dFlow superset MS Call
 Genifer by Bytel-code generator MS \$299
 QuickCode III Plus MS \$249

Fortran & Supporting

50:More FORTRAN PC \$ 99
 ACS Time Series MS \$399
 Forlib+ by Alpha MS \$ 59
 MS Fortran - 4.0, full '77 MS \$299
 No Limit - Fortran Scientific PC \$115
 PC-Fortran Tools - xrcf, pprint PC \$179
 RM/Fortran MS Call
 Scientific Subroutines - Matrix MS \$139

MultiLanguage Support

BTRIEVE ISAM MS \$199
 BTRIEVE/N-multiuser MS \$465
 Corporate PVCS-source control MS \$359
 Flash-Up Windows PC \$ 79
 GSS Graphics Dev't Toolkit PC \$375
 HALO Graphics PC \$209
 Dev't Package MS \$395
 Informix - by RDS PC \$639
 Informix 4GL-application builder PC \$789
 Informix SQL - ANSI standard PC \$639
 Opt Tech Sort - sort, merge MS \$115
 PANEL MS \$215
 Pfinish - by Phoenix MS \$229
 PolyLibrarian by Polytron MS \$ 79
 PolyBoost - speed I/O, keyboard PC \$ 69
 QMake by Quilt Co. MS \$ 85
 Report Option MS \$119
 Screen Sculptor PC \$ 95
 SRMS - source control MS \$109
 Synergy-create user interfaces MS \$375
 Xtrieve - organize database MS \$199
 ZAP Communications - VT 100 PC \$ 89

FEATURE

Turbo Expert by Thinking Technologies - Menu driven expert system generation package details reasoning, comes with tutorial, manual, demos. "Corporate" supports up to 4000 rules. "Startup" up to 400. Corporate \$359, PC Startup \$129

Note: All prices subject to change without notice. Mention this ad. Some prices are specials. Ask about COD and POs. Formats: 3" laptop now available, plus 200 others. UPS surface shipping add \$3/item.

THE MODEM FOR PEOPLE WHO TAKE THEIR ACT ON THE ROAD.



When you travel with your portable computer, make sure your communications go with you. The WorldPort 1200™ Portable Modem is the only modem you need, whether you travel across the country or around the world.

While most portable computers offer an optional modem of some type, only the WorldPort 1200 gives you all the features required for true portability. Features like battery-powered, Hayes™ Command Set compatibility, Bell and CCITT standards, direct and acoustic cups interface for 300 and 1200 bps, and compact size.

Equally at home on your desktop, the WorldPort 1200 works with virtually any computer with a RS-232C serial port. No more of those dedicated internal modems that can only be used with one computer.

The WorldPort 1200. At only \$199, you can't afford to leave home without it.

For more information or your nearest dealer, contact us today.



**TOUCHBASE
SYSTEMS, INC.**
16 Green Acre Lane
Northport, NY 11768
(516) 261-0423
Telex 6502848020

Hayes is a registered trademark of HayesMicrocomputer Products, Inc.

stringing the network wires it wasn't a lot harder than doing it direct.

I've found another use for the CompuPro network. All my AT machines have 96-tracks-per-inch "quad-density" disk drives. Those drives read normal PC and XT disks fine; but when they write files, the probability that a 48-tpi "normal" PC drive will be able to read them is very low. The network solved the problem nicely: we use it to transfer the file to a PC with 48-tpi drives and let it write the file. Now anything can read it.

Enter Zelda

For more than a year, the main PC-DOS machine at Chaos Manor has been Big Kat. He's been so good, in fact, that I've turned down numerous offers of competing AT machines.

He's still working fine; but eventually it was time for a change, if only because I can't go on writing about the same machine forever. When Zenith asked me to look at the Z-248 AT clone, it wasn't a difficult decision. It's the standard machine used at the service academies, and I'm rather fond of Zenith anyway. Their stuff is reliable, and I like their ROM monitor. It took Zenith a while to get one of the machines to me, and until they did I kept Big Kat on-line; but eventually the Z-248 arrived.

First things first. Get the new machine running. That was no problem. When I turned it on, it said "not a bootable partition." When in doubt, read the instructions, and five minutes later I knew how to boot the machine with its floppies and partition the 30-megabyte hard disk. Another five minutes and the hard disk was formatted and set up with command files to be the boot disk.

There was one potential problem. The Z-248 came with an enhanced graphics adapter color board and Zenith's ZVM-1380 13-inch EGA color monitor. I was a little worried that text on the screen might not be big enough for me to be comfortable with. Also, about once every dozen times when I booted the system, the screen images were broken and fuzzy. The condition corrected itself on rebooting, but it was annoying.

It didn't seem fatal. I put it down to something being jarred in shipping and figured that at worst Zenith would send me a new video board.

Now I was left with the question of what to do with Big Kat, a thoroughly debugged and operational AT clone who has served me well for more than a year. In fact, the decision was simple enough. Frank, my #2 son, is studying business and finance at USC and needs a computer. PCs are fine, but ATs are better; with permission from Kaypro, Big Kat

would become Frank's machine.

Since Big Kat had been the main PC-DOS machine here, he had a lot of files I'd need on the Zenith. On the other hand, I have a lot of programs I wasn't about to send down to USC. In some cases, I legally own only one copy. Most publishers probably wouldn't mind if I lend my son a copy, but I won't do that without permission. Others are pre-release. And, of course, some are games: college students get enough distractions without my furnishing more. I wanted to keep those files for me, but they'd sure have to be removed from Big Kat.

The simple solution would have been to use Fastback: back up all of Big Kat's files, then restore them on the Z-248. I could then go through Big Kat's files and delete as needed. I didn't think of that. I suppose it's partly because Big Kat had a lot of files that ought to have been deleted long ago, and this was a good opportunity to clean things up. Anyway, I used the network.

Networking on My Own

I had an extra CompuPro ARCNET PC board. Since the Zenith was the Z-248, it seemed reasonable to address it as node 48 (Big Kat had already been designated as 28). Of course, that would be hexadecimal 48, since that's how you specify node numbers on the CompuPro network; but I have SideKick, which has a desk accessory calculator that translates hexadecimal to decimal to binary, so surely it should be no problem. I opened the CompuPro ARCNET PC documents with considerable hope.

Hah. Five minutes later I was hopelessly confused. Eventually I called CompuPro and asked for technical support. I got a young chap who seemed to know what he was doing. He chattered gaily about least significant bits and the like and told me how to set the paddles—the individual switches—on SW-2, the eight-paddle DIP switch that tells the CompuPro ARCNET PC board what node it is. I set them and hit Ctrl-Alt-Del.

Nothing happened, of course. You first have to turn off the machine before the ARCNET PC card can read its own switch settings. Try again.

Unfortunately, that didn't work either. Back to phone CompuPro. This time I got Len Ott, CompuPro's very practical software guru. Len's solution was simple: use DEBUG to see what number the ARCNET PC board thought it was reading. A minute later we knew it wasn't reading 48 hexadecimal. Back to the DIP switch and exactly reverse each paddle. Turn off the machine. Fire it up again. Voilà! Everything worked fine.

continued

THE PROGRAMMER'S SHOP

Offers a 31 Day Money Back Guarantee on any product in this ad. Call Today.



S A P I E N S V 8 A VIRTUAL MEMORY MANAGER FOR THE PC

Sapiens V8 is a virtual memory manager for C programmers on the IBM PC. The unique design of the virtual memory paging storage scheme makes it an invaluable tool for C programmers. With an 8 mg. workspace and stack and heap libraries Sapiens V8 solves the problems and hazards of stack and heap overflow.

Sapiens V8 brings the power, speed and complexity of a main-frame virtual memory manager to the PC. Sapiens V8 virtual memory manager emulates a 80386 memory management system and is fully implemented in software. It is not dependent on add-on boards or special chips.

- Provides 8 mgs. virtual memory workspace
- Fast: less than 10% speed overhead
- Advanced software emulation of 64-bit architecture
- Virtual stack and heap: multiple return values, stack frame management. (vmalloc()).

System requirements: Huge model C compiler (Microsoft, Lattice, Aztec). V8 uses 22-128 Kb core. Hard disk recommended.

List: \$300 Ours: \$259

PVCS *The Most Powerful & Flexible Source Code Revision & Version Control System*

The POLYTRON Version Control System (PVCS) allows programmers, project managers, librarians and system administrators to effectively control the proliferation of revisions and versions of source code in software systems and products. PVCS is a superb tool for programmers and programming teams. (A special LAN version is also available.) If you allow simultaneous changes to a module PVCS can merge the changes into a single new revision. If the changes conflict, the user is notified. Powerful capabilities include: Stores and retrieves multiple revisions of text; Maintains a complete history of revisions to act as an "audit trail" to monitor the evolution of a software system; Maintains separate lines of development or "branching"; Provides for levels of security to assure system integrity; Uses an intelligent "difference detection" to minimize the amount of disk space required to store a new version. Requires DOS 2.0 or higher. Compatible with the IBM PC, XT, AT and other MS-DOS PCs.

Personal PVCS

—For single-programmer projects

Sug. Retail Prog. Shop

\$149 \$129

Corporate PVCS

—For larger, multiple-programmer projects

\$395 \$359

Call POLYTRON at (503) 645-1150 for pricing on larger networks



WANT TO ADD

WINDOWS, ICONS, FONTS, FAST GRAPHICS, DIALOG BOXES, PROCESS MANAGEMENT, AND DEVICE INDEPENDENCE

TO YOUR IBM PC PROGRAMS?

If you have ever wished that you could develop stunning Macintosh-like programs on the IBM PC without the overhead of an enormous operating environment like Windows or GEM, then you need the **SYNERGY DEVELOPMENT TOOLKIT**, from Matrix Software.

Using a memory resident runtime module only 20K in size (versus as much as 300K for Windows), you can develop applications with: overlapped and tiled windows; pull-down menus with half intensity options and automatic sizing; fast graphics function calls to draw shapes, lines, boxes, and create intricate fill patterns in both regular and irregular areas; have full device independence (drivers for numerous devices, including CGA, EGA and Hercules are included); sophisticated text input and output, with fonts in different styles and sizes; full keyboard support (your programs won't need a mouse!) and powerful mouse support; and process management calls to efficiently manipulate system resources.

The Toolkit has gateways to support the following languages:

- Turbo Pascal
- Microsoft & Lattice C
- Basic
- IBM/MS Pascal
- Macro Assembler
- dBASE II/III Compilers

In addition, the Toolkit includes a powerful collection of tools including a graphics resource editor for developing your own icons and fonts.

NEW! The Toolkit also includes a free copy of Synergy Layout, a revolutionary software development tool that dramatically increases your productivity by actually generating bug-free source code in Macro, C, and Turbo Pascal.

For further information, contact Matrix Software at [617] 567-0037.

Synergy Desktop

List: \$69.95 Ours: \$63

Development Toolkit

List: \$395 Ours: \$349

HOURS

8:30 A.M. - 8:00 P.M. E.S.T.

800-421-8006

5-B Pond Park Road, Hingham, MA 02043
Mass: 800-442-8070 or 617-740-2510

As with most such problems, what was needed here was *examples*. In this case, it needed some drawings of switch settings and their corresponding numbers, plus a couple of tables. Fortunately, CompuPro has hired an editorial consultant to revise the documents. I have some new data for her attention.

After that the network worked like a charm. Of course, DOS is too stupid to let me use the network in a single operation; that is, you can't, at the Zenith, issue a command that will bring you a file from the Kaypro, nor can you, from the

Kaypro, send a file to the Zenith. Instead, you have to use the Kaypro to send a file to, say, the Golem, my big CompuPro 286/Z80 machine, then go to the Zenith, set up the directory structure you like, and call in the files from the Golem.

To do this, I told both the Kaypro and the Z-248 that they had a local drive called M, which was actually the M-Drive/H (RAM disk) on the Golem. (The network lets you name any drive on any machine any arbitrary thing you like, as long as it isn't something you already have. For example, I could not call a

networked drive C if I already had a hard-wired drive named C attached to that terminal.) This made things go faster.

Then I noticed that my newly transferred files didn't have date and time stamps. It took a second before I realized why. The Golem's M drive is formatted as Concurrent CP/M media, and while DOS files—including command files—are stored intact, and work fine, the date and time stamps were lost on the way through. That problem was cured by using the C logical drive partition on the Golem; C is configured as MS-DOS media.

After that we had no problems. I experimented with PC Sweep, a couple of other shareware file manager programs, and various other stuff, with no surprises. PC Sweep running on the Z-248 is perfectly willing to believe that the M drive is nothing special and will tag files for transfer or deletion; while the Golem is smart enough to accept commands through the network from the Zenith. In a couple of hours, I had reorganized and transferred all my files.

Norton's Wipedisk

Once I'd done all that, there was still a problem. I'd erased files from Big Kat, but it would still be possible for someone down at USC to recover them; and while I trust my son, I didn't want him to have to put unusually severe security restrictions on access to the machine.

One solution might be to use Fastback to record all the data, then format the hard disk. Alas, I have a couple of utility programs that swear they can recover data even from a disk reformatted under DOS, and while I wasn't sending those programs with Frank, I make no doubt there are plenty of USC students who either have them or could write their own. Surely there's a way to permanently erase files.

There are lots of PC-DOS utility programs, some in the public domain, some shareware; so many that it's impossible to keep track of them all. I've found by and large, though, that the latest edition of The Norton Utilities will solve at least 90 percent of the DOS problems I run into. Norton's programs are well documented, both on how to use them and what they do. It seemed reasonable to look into the Norton manual to see if there was help for the current situation.

There was. Norton's Wipedisk doesn't just erase files, it overwrites them. I'd never used it before, so I ran Fastback to get backup copies of all the files we'd just transferred, then invoked Norton's Wipedisk with the /E option, which, according to the manual, "specifies that only the

continued

THE ALTERNATIVE!



EDITOR'S CHOICE

SAM 3001 AT



NOW!
10 MHZ

640K RAM, 6/8 MHZ, 1.2M FDD, F/H Disk Controller, 2 Serial Ports, Hi-Res RGB Board w/PP, 195W Power Unit & Keyboard. Monitor extra. Compatibility Guaranteed. FCC/VDE Certified. U.S. origin.



HiTech
International, Inc.
A KNK COMPANY

Order Desk
(800) 538-8157 National
(800) 672-3470 California
Ask for Dept. 864

1435 McCandless Drive
Milpitas, CA 95035
(408) 263-3300
TLX 501422 HIT

Copenhagen
242 54 10

London
01 640 9130

Nürnberg
0911 333923

Paris
(1) 45974529

SAM 3001 AT is a trademark of HiTech International Inc.



All orders shipped
within 24 hours!

ANSI	
Porodax	\$450.00
AMERICAN SMALL BUSINESS SYSTEMS	
Prodesign I	\$180.00
ASHTON-TATE	
Dbase III+	\$407.00
Framework	410.00
Multimate	248.00
Multimate Advantage	315.00
BORLAND	
Database Tool Box	\$ 39.00
Graphics Toolbox	39.00
Lightning	61.00
Reflex	85.00
Sidekick	48.00
Super Keys	41.00
Turbo Jumbo Pack	175.00
Turbo Pascal (8087 + BCD)	60.00
Turbo Tutor	21.00
BPI	
AR, AP, General Accounting and Payroll	\$175.00 each
Inventory, Job Cost and Church Management	CALL
BREAKTHROUGH	
Timeline	\$ 230.00
Timeline Graphics	95.00
BROWNBAG SOFTWARE	
Homebase	\$ 44.00
PC Outline	64.00
Utilities	93.00
CENTRAL POINT	
Copy II PC	\$ 24.00
Copy II Options Board	80.00
PC Tools	24.00
CHIP SOFT	
TURBO TAX	
Personal Federal	\$ 45.00
Personal State	\$ 28.00
Professional Federal	\$180.00
Professional State	\$120.00
COMPUTER ASSOCIATES (I. U.S.)	
Easy Plus (windowing)	CALL
Easy Systems Acctg. (per module)	FOR
Supercalc IV	PRICES
Super Project Plus	
COSMOS	
Revelation	\$500.00
DAC	
Easy Accounting	\$ 48.00
Easy Payroll	36.00
Payroll Tutor	14.00
Accounting Tutor	14.00
DIGITAL RESEARCH	
Gem Collection	\$ 75.00
Gem Desktop	30.00
Gem Draw Plus	190.00
Gem Graph	148.00
Gem Wordchart	88.00
EXECUTIVE SYSTEMS	
X Tree	\$ 29.00
FIFTH GENERATION	
Fastback	\$ 95.00
FINOT GROUP	
Keep Track Plus	\$ 58.00
FUNK SOFTWARE	
Sideways	\$ 37.00
HARVARD	
Presentation Graphics	\$230.00
Total Project Manager	280.00
HOWARD SOFT	
Tax Preparer	\$199.00
CA Sup.	80.00
IBM	
DisplayWrite IV	\$360.00
DOS 3.1	65.00
DOS 3.2	80.00
JAVELIN	
Javelin	CALL
LATTICE	
C Compiler	\$250.00
Run C	94.00
LEADING EDGE	
Word Processor w/Mail Merge & Spell	80.00

LOTUS CORPORATION	
Lotus 1-2-3	\$305.00
Lotus Report Writer	110.00
Symphony	435.00
Symphony Spell Checker	105.00
Freelance Plus	355.00
Grophwriter	320.00
Hol	109.00
MECA	
Managing Your Money	\$ 114.00
MERIDIAN	
Carbon Copy	\$109.00
(minimum of two pieces)	
MICROGRAPHX	
In-A-Vision	\$275.00
PC Draw	220.00
MICROPRO	
Propak	245.00
WordStar	175.00
WordStar 2000	245.00
WordStar 2000 Plus	290.00
MICROPROSE (strategic games:)	
Crusade in Europe	\$ 25.00
Decision in the Desert	\$ 25.00
F-15 Strike Eagle	22.00
Silent Service	22.00
Solo Flight	22.00
MICRORIM	
R:Base System V	\$365.00
MICROSOFT	
C Compiler (Version 4)	\$265.00
Chart	185.00
Cobal Compiler	415.00
Fortran Compiler	215.00
Macro Assembler	90.00
Multiplan	125.00
Project (Version 3)	265.00
Quick Basic	62.00
Windows	62.00
Word (Version 3.1)	285.00
Flight Simulator	33.00
Learning DOS	32.00
MICROSTUF	
Crosstalk XVI	\$ 99.00
Crosstalk Mk IV	155.00

NASHOBA	
Nutshell	\$105.00
NEW ENGLAND SOFTWARE	
Graph-in-the-Box (Pro)	\$ 55.00
Graph-in-the-Box (Unpro)	85.00
NANTUCKET	
Clipper	\$345.00
PAPERBACK SOFTWARE	
VP-Planner	\$ 55.00
VP-Info	55.00
PAUL MACE SOFTWARE	
Mace Utilities	\$ 52.00
PETER NORTON COMPUTING	
Norton Commander	\$ 39.00
Norton Utilities	52.00
QUAID SOFTWARE	
Copywrite (w/zero disk)	\$ 38.00
ROSESOFT	
Prokey	\$ 75.00
SIMON & SCHUSTER	
Typing Tutor	\$ 32.00
Webster Spell Check	35.00
Webster Thesaurus	45.00
New World Writer	79.00
SOFTLOGIC	
Corousel	\$ 30.00
Cubit	30.00
Disk Optimiser	33.00
Double DOS	30.00
SOFTSTYLE	
Printworks	\$ 38.00
Printworks (loser)	68.00
SOFTWARE GARDENS	
Don Bricklin's Demo Program	\$ 60.00
SOFTWARE GROUP	
Enable	\$335.00
SOFTWARE PUBLISHING	
First Choice	\$ 90.00
Pro Writer	115.00
Pro File	142.00
SOFTWARE RESEARCH TECHNOLOGY	
Smartkey	\$ 36.00
Smartkey w/Smartprint	49.00
SOFTWARE TOOLS	
Viewgen (Version 2)	\$ 95.00

SPRINGBOARD	
Newsroom Pro	79.00
Certificate Maker	36.00
STERLING SOFTWARE	
Intelligent Backup	\$ 80.00
SUMMIT	
Better Basic	\$155.00
SYMANTEC	
Q & A	\$235.00
T/MAKER	
Click Art Personal Publisher	\$115.00
TURNER HALL	
SQZ	\$ 58.00
Note It	58.00
UNISON WORLD	
Art Gallery I	\$ 21.00
Art Gallery II	24.00
PrintMaster	32.00
Newsmaster	55.00
WORDPERFECT CORP.	
WordPerfect	\$215.00
WordPerfect Library	64.00
WORDTECH	
Quicksilver	\$325.00
MS DOS Libraries	52.00
LAN File Server	70.00
DBXL	CALL
XEROX	
Ventura Desktop	\$675.00

HARDWARE

AMDEK	
310A	\$149.00
AST (expansion cards)	
Rampage AT	445.00
Rampage PC	260.00
Six Pack	165.00
C. ITOH (printers)	
C310	CALL
C315	CALL
FUJITSU	
P.C. Half Height Drive	\$ 85.00
HERCULES	
Graphics Plus	185.00
IBM	
ProPrinter	\$420.00
ProPrinter XL	650.00
IMI	
PC Mouse & Dr. Hold II	\$105.00
INTEL	
Above Board AT 128	\$375.00
Above Board PC 64	240.00
Above Board PS 256	340.00
8087 (IBM)	115.00
8087 (8 mhz.)	160.00
80287	185.00
MICROSOFT	
Mouse (serial)	\$127.00
Mouse (bus)	120.00
Mouse II	285.00
NEC	
1401 Multisync Monitor	\$595.00
PARADISE	
EGA Aulo Switch	\$390.00
PLUS	
The Hard Card 20 meg	\$710.00
PRACTICAL PERIPHERALS	
Modem 1200 (Internal)	\$130.00
Modem 1200 (External)	170.00
Multifunction Card	
w/1200 Modem	300.00
Complete System	160.00
SEAGATE	
20 MB. Hard Drive	
w/Wd. Controller	\$445.00
SIGMA DESIGNS	
EGA Card	\$390.00
TOSHIBA	
321	\$465.00
341	750.00
U.S. ROBOTICS	
Direct 1200 (ext.)	\$125.00
Direct 1200 (int)	110.00
Direct 2400 (int)	195.00
CABLES	
6-ft. Modem Cable	\$ 15.00
6-ft. Parallel Printer Cable	15.00
Surge Protectors	24.00

TERMS:

- No surcharge. Visa or Mastercard.
- Add \$2.00 for C.O.D.—All C.O.D. cash or certified check only.
- Prices subject to change without notice.
- Short shipments must be reported to us within 24 hours of receipt.
- Non-defective goods must be returned with seals intact within 10 days of receipt for full refund.
- Shipping costs will not be refunded.
- No returns accepted without RMA #.
- No returns on non-defective hardware.
- Management reserves the right to charge up to 10% restocking fee.
- Shipping charge \$3.00 per item in California; \$4.00 per item elsewhere. This does not apply to bulk orders. Shipping costs for hardware items will be higher.
- Terms extended to Fortune 1,000 companies, government institutions, schools and universities.

INQUIRIES: 818-881-6096 ORDER ONLY: 800-225-8084

6925 Canby Street, Suite #103, Reseda, California 91335

erased or unused data space will be wiped; this saves current data, but wipes erased data."

I am pleased to report that it does just what it says. It's not particularly fast: on a 20-megabyte hard disk about half full, it took most of dinnertime. On the other hand, under the /E option it runs unattended, and when it was finished, I couldn't find a program that would recover any of the wiped data.

I've said this before: if you do much work with DOS, you should have a copy of The Norton Utilities. There may be a

better public domain version of every program in the Norton set, but you'll sure spend a lot of time and effort collecting them all, and even then you'll have to sweat some pretty wretched documents. The Norton Utilities are well worth the price.

Cheetah

The next thing was to install the Cheetah Combo, a no-wait-state memory-expansion board for the PC AT. The Cheetah Combo is faster than the built-in memory on most IBM PC AT machines, which

means that with a lot of ATs it's a good idea to remove memory the machine comes with and let the Cheetah memory replace it. That's easy to do: Cheetah's documents are clear, and they give you a program that shows you just how to set the switches.

The Zenith, however, is faster than most AT clones. It came with 500K bytes of no-wait-state memory. I set the Cheetah Combo switches to tell it that, and instantly I had a 640K-byte system with an unknown amount of expanded memory. Next thing was to tell the Z-248 about its new memory. That turns out to be easy to do, since unlike the Kaypro, the Zenith tells you how much conventional and expanded memory it has. You then have to go into the ROM monitor and change the setup. (I don't know why the machine doesn't just tell itself about the changes.)

The only use that I've found for expanded—as opposed to extended—memory is as RAM disk. Installing that is simple enough. Just use the VDISK.SYS that comes with PC-DOS. In my case, on advice from Cheetah's Gene Sumrall, I put DEVICE = VDISK.SYS 4096 256 256/E into the CONFIG.SYS file. That tells the RAM disk to grab everything it can (up to 4096K bytes), format it into 256K-byte sectors, and leave room for 256 entries in the directory. If I were short of memory, I might decide to leave room for only 128 entries.

Once that's done you have to reboot. The first time I tried it didn't work: I had VDISK.SYS in a subdirectory, and the PC looks for CONFIG.SYS in the root directory before it reads the PATH instructions that can tell it to look at subdirectories. Moving VDISK.SYS to the root directory fixed things, and at the next reboot I had 640K bytes of main memory and a 2.48-megabyte RAM disk labeled drive D.

The Cheetah Combo comes with some interesting software. One program will force your programs to use high memory before low to make efficient use of the superfast Cheetah no-wait memory. Because the Z-248 is already plenty speedy, I didn't bother with that except to test it out. It works, but I saw no real speed improvement. With another machine I probably would have.

Above Disc

RAM disk is useful, but my problem is that I like memory-resident software. That eats memory, and neither expanded memory nor RAM disk is a bit of help. What I need is "extended" or "smart" memory, generally abbreviated as EMS. I called Cheetah to see if they had anything that would help and learned about

continued

When You're Looking for Answers, Come to the Library

10 MHz AT Compatible System

Complete Monographic System with Monitor and Display card

- Mono Monitor
- Hercules compatible card
- 67% faster than IBM AT
- 8/10 MHz switchable
- 512KB memory
- W.D. HD/floppy controller
- 1.2MB TEAC floppy drive
- Fully IBM compatible BIOS
- CMOS clock/calendar
- 200 watt power supply
- AT style keyboard
- Operation Manual
- Set up Utility Software
- SI Rating 10.3

Designed, Manufactured, and serviced in U.S.A.
FCC Class 'B' approved
One Year Limited Warranty

Free Starter's Kit:
• DOS 3.1
• 3 Diskettes
• Diskette case

\$1249

Runs Xenix™ Auto Cad Novell Network

EGA System
with EGA monitor and EGA card
\$1659

Basic System
without Mono monitor and Video card
\$1129

8 MHz Turbo XT System

- Fully IBM compatible
- 8088-2.8 MHz CPU
- 4.77 & 8 MHz keyboard selectable
- 360K floppy drive
- Floppy drive controller
- 256K memory expandable to 640K
- Option Math Co-processor
- 150W power supply
- Keyboard

FCC Class 'B' approved
One Year Warranty

\$399

Seagate 20MB Subsystem

- ST-225 Drive
- Controller
- Cable and hardware
- Software and Manual

20MB ST-4026 \$549
40MB ST-4036 \$599
80MB ST-4051 \$699
80MB ST-4086 \$125

• Cable, rails
• Software and manual

\$365

AT Multifunction **\$175**

- Up to 2MB memory
- Selectable memory addressing
- Serial/Parallel/ Game ports
- Software

Everex Modem **\$128**

- Half-size
- 300/1200 BAUD
- Fully Hayes comp.
- BITCOM communications software
- 2400 BAUD CALL

EGA Card **\$228**

- Fully IBM EGA comp.
- Color/Mono display
- 16 colors from a palette of 64
- 640 x 350 high resolution graphics
- 256K Display memory

Mini I/O Card **\$59**

- Parallel/Serial
- Clock/calendar
- Half-size card
- Cables
- With Game port \$68

Wangtek 60MB Tape Backup

INT **\$727** EXT **\$827**

- Backup 5MB in 1 minute
- Image/file by file
- Mounting hardware
- Software and Tape

Others:

- AT Multifunction \$175
- AT 3MB Memory Expansion card \$150
- AT HD/Floppy controller \$165
- AT HD/Function \$94
- PC Multifunction \$139
- Multifunction/Mono card \$428
- Expansion chassis \$33
- Floppy controller \$229
- EVEREX Edge \$69
- DOS 3.1 \$79
- 150 W power supply \$75
- Keyboard AT/XT CALL
- Mono/Color/EGA monitor \$580
- TEAC 20MB Tape backup \$98
- Hercules compatible

COMPUTER LIBRARY
Sales (415) 659-8784
Tech Support (415) 659-8887
42624 Christy St.
Fremont, CA 94538
Quantity Discounts Available

CAREFUL—YOU'RE ABOUT TO LOSE YOUR AMATEUR STATUS.



Now even novices can make their PC's do things that the experts had to strain at.

By slipping Ability Plus™ or Ability™ into their PC's

With both programs, you get full-featured word processing. Spreadsheets larger than Symphony and the ability to import Lotus 1-2-3 1A files. A forms-oriented database with Ability and a relational database with Ability Plus. Professional business graphics with just a few keystrokes. Menu-driven Migent Pocket Modem™ and Hayes-compatible communications.

Even "slide shows" on your PC!

They both use menus and the same commands in all the applications, so there's no programming.

And they're the only integrated business programs that work with "live" data, not just copies pasted in. So you only have

to enter data once, and changes you make in one application are automatically made for you in *all* your linked applications.

Perfect for those endless daily, weekly and monthly reports.

Ability Plus, our latest addition, adds a spelling checker, system-wide advanced macros, four-quadrant X-Y graphs, EGA support and much more. And it's a fully relational *system* that can look up information for you from any

application. (Enter a name, it gets the phone number; enter a part number, it gets the description; etc.).

With all this, Ability Plus is just \$199 while Ability is budget-priced at \$99 (upgrades available).

If it sounds too good to be true, use the coupon to get your free demo disk.

Or call 800-633-3444 and start doing more and working less today.

Whether you're a computer expert or would just like to be one.

MIGENT™

Free Demos!

Sounds great! Please send the name of your nearest dealer and a demo disk for:

Ability™ Ability Plus™

Name _____
 Address _____
 City _____ State _____ Zip _____
 Phone _____

Send to: Migent, Inc., 865 Tahoe Blvd,
 Call Box 6, Incline Village, Nevada 89450-6062

©Migent, Inc. 1987 Ability, Ability Plus and Pocket Modem are trademarks of Migent, Inc.

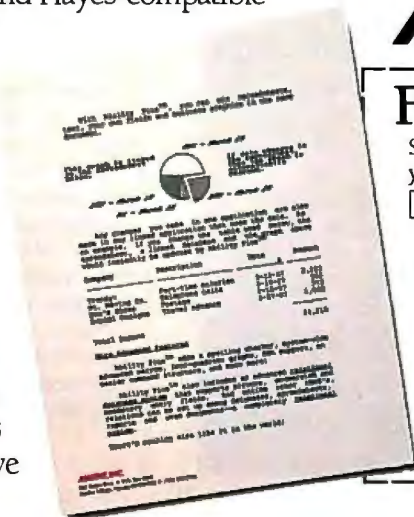

Above Disc virtual memory emulator.

Above Disc is a memory-resident program that uses about 50K bytes of regular memory. It uses that to control a specified portion of your RAM disk and turn that into the equivalent of extended or smart memory. The program swaps in and out of regular memory according to the rules of the EMS standard. In other words, it creates what the big computer people call virtual memory.

Installing Above Disc is simple, provided that you *read the entire manual* before starting. It isn't that long a manual,

so this is no real problem, however there are a number of caveats about Above Disc, and you'd better be aware of them.

Once Above Disc was in place, I booted to see what it would do for Ready!. The result was very nice: Ready! took up 3K bytes of conventional memory and 160K bytes of the expanded memory created by Above Disc. Ready! also worked perfectly.

Unfortunately, Ready! is the only memory-resident program I'm addicted to that can make use of expanded memory. Philippe Kahn tells me he'll have an

EMS version of SideKick Real Soon Now. However, the Above Disc scheme works with DESQview, Lotus 1-2-3, Symphony, Reflex 1.1, and other programs engineered to take advantage of EMS. The instructions explicitly say it will *not* work with Javelin.

Above Disc doesn't have to use RAM disk to do its thing; you can designate part of your hard disk, or even a floppy disk, as "expanded memory," and Above Disc will swap stuff in and out of a reserved area on that disk. Of course it won't be very fast, and if you remove the floppy at some point during the proceedings, you'll really mess things up; but it will work.

The DESQview people, and some others, tell me that Above Disc isn't *really* EMS-standard expanded memory, and I'm sure they're right; but it does quite a lot, and we haven't had any problems with it. The Cheetah Combo and Above Disc make a good combination.

Zelda Goes Mad

I'd had the Z-248 all weekend, and it was giving me no problems, so I sent Big Kat off to USC with Frank. Given the rugged construction of the Kaypro, I wasn't worried about it, and I was right: despite having a bunch of business students banging away on it, Big Kat is working fine.

Alas, that wasn't true of the Z-248. The instant Big Kat left the house, the Z-248 did odd things. First, her screen images began to dissolve, until there were no more than 25 percent of the pixels on the screen. English written in the roman alphabet has a lot of redundancy, so I could just make out words and commands; but it sure wasn't easy.

Resetting the machine would generally cure the screen problem, but it often would introduce a different difficulty: the Above Disc disk-swapping system would load itself and report that all was well, but then Ready!, loading itself on start-up, couldn't find it. Instead, about half the time, Ready! would load itself entirely into conventional memory, as if the Above Disc pseudo-expanded memory weren't there at all.

Then I had real problems getting the machine to work with the OmniTel modem. I've had that modem in Big Kat for two years with no glitch whatsoever, and I refused to believe it had gone sour—and indeed, rebooting would often cure that problem, too. After that I had problems with the ARCNET PC and even with the PATH command.

None of this happened every time, which was annoying. Computers aren't supposed to do things *sometimes*. It was time for some serious diagnostics.

continued

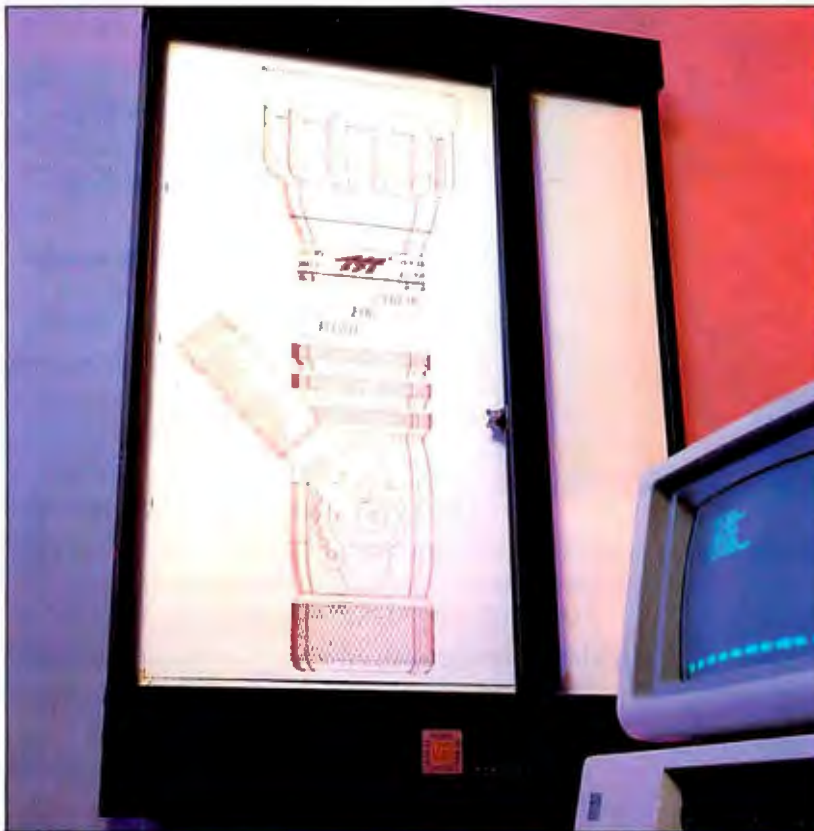

THE MURAL PLOTTER D SIZE PLUS. FLATBED TECHNOLOGY.

\$2495.

We're not going to razzle-dazzle you with a lot of hype about the Mural Plotter. We'll let the facts speak for themselves.

- Plot area 25" x 34"
- Compatible with leading software programs

- Emulates Hewlett-Packard 7475 Plotter
- Compatible with IBM/PC/XT/AT, T.I., NEC, AT&T and more using RS-232-C serial interface
 - Desk top or wall mount
 - Excellent repeatability • 5 ips

Call for the name of your local CAD Dealer!

UI United Innovations • Crossroads Ind. Park • Holyoke MA 01040 • 413-534-4400

Do You Feel Lucky???



Good programming isn't a matter of luck. It requires skill, perseverance and good programming tools. You already have the skill and perseverance; **Janus/Ada** provides the programming tools. Tools you can rely on in any project, in almost any MS DOS environment, with full portability to any other Ada system. With **Janus/Ada**, you get lucky in all the right ways:

- SYSTEM REQUIREMENTS:** Any Intel 86 family processor with 512K RAM, two floppy disk drives or a hard disk and DOS 2.0 or higher.
- COMPILATION SPEEDS:** 8086/6MHZ:300 lines per minute; 80186/8MHZ: 500 lines per minute; 80286/8MHZ: 900 lines per minute (DOS 3.0)
- PRODUCT SUPPORT:** Quarterly newsletters, 24 hour Bulletin Board, and a staff with over 20 man years of actual Ada programming experience.
- APPLICATIONS AND TOOLS:** Assemblers, disassemblers, Ada source code, a Pascal to Ada translator, 8087 support, tutorials and more!
- AFFORDABILITY:** Our **Janus/Ada "C" Pak** is available for \$99.95 and contains the **Janus/Ada** Compiler and Linker, designed specifically for microcomputers and consumer tested since 1981. Our customers can upgrade to our development and embedded systems "paks" with 100% credit for this starter package. Our **Janus/Ada** Extended Tutorial is available for the same low price. We feature commercial and educational "site" licensing for all of our packages.
- ADA STANDARDIZATION:** **Janus/Ada** source code can be ported to any validated Ada system and compiled. We offer a variety of tools and consultations to assist you in this process, if needed.
- JANUS/ADA USERS:** Over 5,000 separate sites use the **Janus/Ada** compiler for training, embedded systems and applications each day. We supply our tools to the U.S. Armed Forces, Fortune 500 companies and over 400 educational institutions, as well as to individuals like you.

We've been making programmers lucky with our tools for over 5 years; isn't it about time you changed your luck? We'll even pay for the call! To place an order or receive our informative brochure, **please call 1-800-722-3248.** It'll make your day!!!

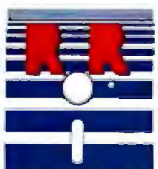

SOFTWARE, INC.

P.O. Box 1512 Madison, Wisconsin 53701
(608) 244-6436 TELEX 4998168

CP/M, CP/M-86, CCP/M-86 are trademarks of Digital Research, Inc.
*ADA is a trademark of the U.S. Department of Defense
MS-DOS is a trademark of Microsoft
© Copyright 1986 RR Software

specialists in state of the art programming

1-800-722-3248

Inquiry 282

First things first. I took out the Cheetah Combo, ARCNET PC, and the OmniTel modem, leaving nothing but the original Zenith boards. That did no good, but then I hadn't expected it to. The machine still did odd things *sometimes*.

When I mentioned these problems on BIX, Barbara Clifford pointed out that the machine clearly should be named Zelda, after F. Scott Fitzgerald's very fast, and somewhat flaky, wife. Phone consultation with Wayne Rash, who did the formal (and very favorable) review of the Z-248 in the December 1986 issue of

BYTE, produced a more technical diagnosis: "It sounds like it's all screwed up."

Waiting for Igor

I called Zenith for help. As luck would have it, the relevant Zenith officials weren't in their offices in Chicago. They were out here; to be exact, in Sante Fe Springs, not more than 20 miles from here. As a result, it took a full day to reach Glen Nelson and explain the problem.

"I don't know if it's the CPU or the

video board or both," I said.

"Sounds like the machine was damaged in transportation," Nelson told me. "That's the identical machine Wayne Rash reviewed, and we tested it before we shipped it to you. Let me send you a new one."

That sounded reasonable, but for a test I asked that they send new CPU and video boards. Incidentally, that's one of Zenith's better features: the CPU and system memory are on cards just like everything else, making both repairs and upgrades much easier.

Glen promised to get the boards sent Federal Express, and I went back to trying to understand an increasingly inarticulate Zelda. She was deteriorating rapidly. Sometimes only 10 percent of the pixels would be displayed on-screen. She'd often lose all her path information. Sometimes she'd be unable to find the modem.

My wife watched over my shoulder during one of Zelda's bad spells. "Give up," she said.

"Good advice, but right now this is the only machine I can use to BIX."

"Good heavens. What will you do?"

"It's not so bad," I said. "They're sending a new brain for transplant."

"And when does Igor arrive?" Roberta asked.

"Tomorrow," I said.

Of course the new brain didn't come the next day, or the day after, so there we were, like Dr. Frankenstein waiting for his crazed assistant to come back with a new brain.

Eventually the boards arrived, with mixed results: the video problems went away, but the Above Disc program didn't consistently work. At that point I went off to a conference.

Zelda Cured

When I got back there was a new Z-248 waiting.

First things first. Boot it up. Partition the hard disk. Format it. Transfer DOS to it. Boot again. Everything worked fine. Time to transfer files.

This time I took the simple way: I used the new Fastback with no copy protection. I copied the floppy disk to my hard disk, then tried to run the program. That didn't work. Even though there's no copy protection, you must use the Install program. Once you've done that you can put the floppy away.

Fastback is quite easy to use, and pretty soon I had all my programs stored on 12 quad-density disks. The next thing was to transfer all those over to the new Zenith Z-248. I had a moment of panic at my first attempt: the Fastback Restore

continued



Perma Power Standby Power System Model SPS-500

Get the smart battery backup from Perma Power

Brainy Standby Power System guards your computer... when the power goes off, and when it comes back on!

Here's the first Standby Battery Backup System that never lets dangerous power line voltage through to your computer. A unique sensor system delays start-up or restart until the power line is absolutely safe. The SPS-500 protects from high line voltages, brownouts, momentary dropouts, spikes and surges, RFI/EMI "noise" as well as loss of power. The smart circuit also senses and warns of overload and surge suppressor or battery failure.

All this protection is completely automatic, maintenance-free, and very fast (3/4 millisecond transfer and 3 1/2 hour maximum recharge). Since this is a Standby Power System, it costs less, is more efficient, smaller, quieter and cooler operating than Uninterruptible Power Systems. And this brain-powered battery backup is only \$799 manufacturer's suggested list price... complete with 2-year warranty.

Perma Power has U.S.-made products for all your PC or mini-computer power protection requirements—Surge Suppressors, Telephone Line Surge Suppressors, Power Commanders®, and Power Conditioners. Available nationwide from computer, electronics and office supply dealers.

Perma Power® Electronics, Inc. 5601 West Howard Avenue Chicago, Illinois 60648 Telephone: (312) 647-9414 Telex: 4948559 PRMPWR

PERMA POWER®

Inquiry 364 for End-Users. Inquiry 365 for DEALERS ONLY.

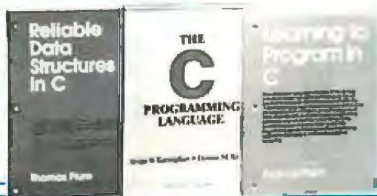

Please accept my application for trial membership and send me the C Programmer's Set (00717) billing me only \$2.95, plus shipping and handling. I agree to purchase at least three additional Selections or Alternates over the next 12 months. Savings range up to 30% and occasionally even more. My membership is cancelable any time after I buy these three additional books. A shipping and handling charge is added to all shipments.

No-Risk Guarantee: If I am not satisfied—for any reason—I may return the C Programmer's Set within 10 days. My membership will be canceled, and I will owe nothing.

Byte 5/87

Name _____

Name of Firm _____
(If you want subscription sent to your office)

Address _____ Apt. _____

City _____

State _____ Zip _____

(Books purchased for professional purposes may be a tax-deductible expense. Offer good in Continental U.S. and Canada only. Prices slightly higher in Canada.)

7-DU2

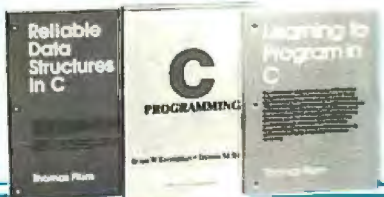

**rogrammer's
for only \$2.95!**

Please accept my application for trial membership and send me the C Programmer's Set (00717) billing me only \$2.95, plus shipping and handling. I agree to purchase at least three additional Selections or Alternates over the next 12 months. Savings range up to 30% and occasionally even more. My membership is cancelable any time after I buy these three additional books. A shipping and handling charge is added to all shipments.

No-Risk Guarantee: If I am not satisfied—for any reason—I may return the C Programmer's Set within 10 days. My membership will be canceled, and I will owe nothing.

Byte 5/87

Name _____

Name of Firm _____
(If you want subscription sent to your office)

Address _____ Apt. _____

City _____

State _____ Zip _____

(Books purchased for professional purposes may be a tax-deductible expense. Offer good in Continental U.S. and Canada only. Prices slightly higher in Canada.)

7-DU2

**10-Day
Free Examination**



BUSINESS REPLY MAIL

FIRST CLASS PERMIT NO. 230 RIVERSIDE, NJ

POSTAGE WILL BE PAID BY ADDRESSEE

NO POSTAGE
NECESSARY
IF MAILED
IN THE
UNITED STATES

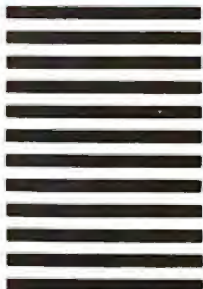

**THE LIBRARY OF COMPUTER
AND INFORMATION SCIENCES**

Riverside, New Jersey 08075-9889



**10-Day
Free Examination**



BUSINESS REPLY MAIL

FIRST CLASS PERMIT NO. 230 RIVERSIDE, NJ

POSTAGE WILL BE PAID BY ADDRESSEE

NO POSTAGE
NECESSARY
IF MAILED
IN THE
UNITED STATES



**THE LIBRARY OF COMPUTER
AND INFORMATION SCIENCES**

Riverside, New Jersey 08075-9889



The "C" Programmer's Set —only \$2.95

when you join the Library of Computer and Information Sciences.
You simply agree to buy 3 more books—at handsome discounts—within the next 12 months.

LEARNING TO PROGRAM IN C 4.5 Switch

It provides a special form of multiple-choice control flow structure in which all the choices are specific, distinctive, viable, or applicable. In the switch statement, it is determined which of the choices is selected, and the corresponding code is executed. The switch statement is particularly useful when the choices are mutually exclusive and the code is relatively simple. For example, the following code snippet illustrates the use of the switch statement to process a menu of choices.

```

switch (choice) {
    case 1:
        /* ... */
        break;
    case 2:
        /* ... */
        break;
    case 3:
        /* ... */
        break;
    default:
        /* ... */
}

```

THE C PROGRAMMING LANGUAGE 3.7 Break

It is a statement that causes the program to terminate the execution of the loop or block. The break statement is used to exit a loop or block of code when a certain condition is met. The following program illustrates the use of the break statement to terminate a loop when a certain condition is met.

```

while (1) {
    /* ... */
    if (condition)
        break;
}

```

RELIABLE DATA STRUCTURES IN C 2.8 Overflow

It is a condition that occurs when a variable is assigned a value that is outside the range of its data type. This can result in unpredictable behavior, such as program crashes or data corruption. The following program illustrates the use of the overflow check to prevent this from happening.

```

if (value > MAX || value < MIN)
    /* ... */
}

```

Learning to Program in C

By *Thomas Plum*. Beginning programmers will quickly learn how to write C programs that are both efficient and portable. More than an instructive manual, the book also gives insight into the underlying processes of the language and highlights its unique aspects. **Publisher's Price: \$25.00.**

The C Programming Language

By *Brian W. Kernighan and Dennis M. Ritchie*. This best-selling tutorial effectively teaches C through practical, hands-on exercises. Its accessible, step-by-step format enables even novice programmers to take advantage of this powerful, highly-efficient language. A handy C reference manual rounds out this information-packed handbook. **Publisher's Price: \$24.95.**

Reliable Data Structures in C

By *Thomas Plum*. This example-filled manual details all the advanced features of C. Coverage includes practical case studies illustrating sophisticated constructs, general-purpose functions and macros, and application-oriented case studies. A series of reliability rules help you write programs that deliver "no surprises." Concepts from the ANSI standardization of C point the way to powerful but portable applications. **Publisher's Price: \$25.00.**

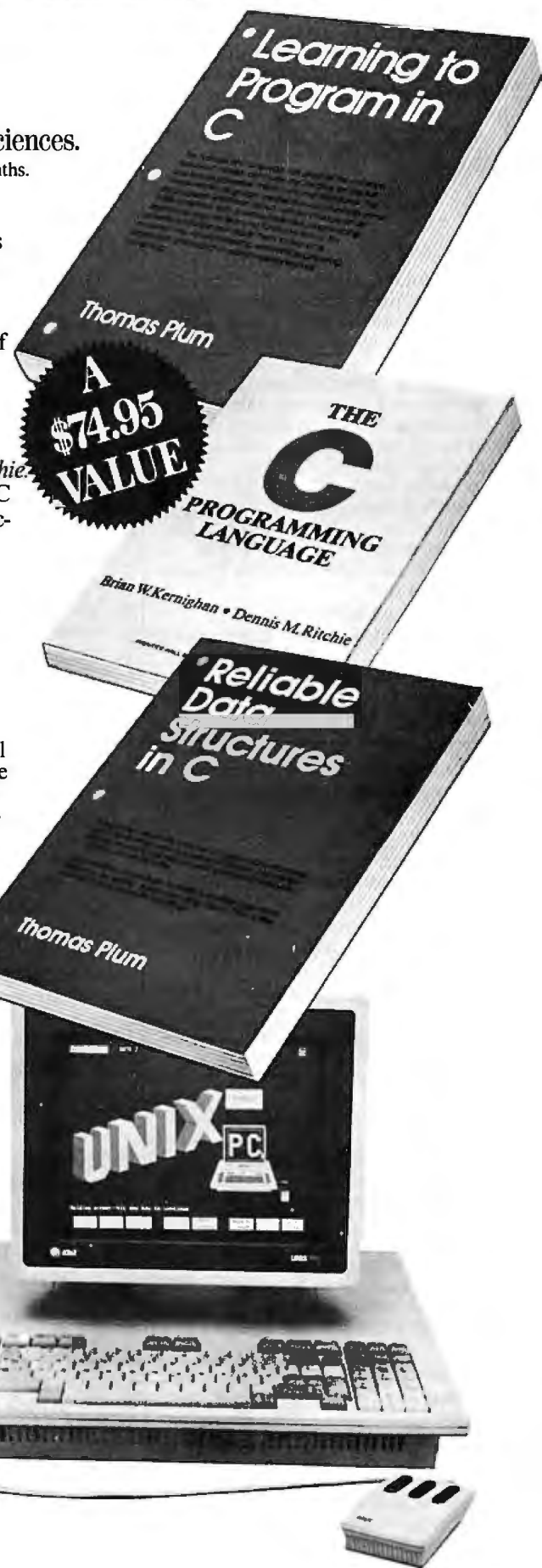

The Library of Computer and Information Sciences is the oldest, largest book club especially designed for computer professionals. In the incredibly fast-moving world of data processing, where up-to-the-moment knowledge is essential, we make it easy to keep totally informed on all areas of the information sciences. What's more, our selections offer you discounts of up to 30% or more off publishers' prices.

4 Good Reasons to Join

- 1. The Finest Books.** Of the hundreds of books submitted to us each year, only the very finest are selected and offered. Moreover, our books are always of equal quality to publishers' editions, never economy editions.
- 2. Big Savings.** In addition to getting the "C" Programmer's Set for only \$2.95 when you join, you keep saving substantially, up to 30% and occasionally even more. (For example, your total savings as a trial member—including this introductory offer—can easily be over 50%. That's like getting every other book free!)
- 3. Bonus Books.** Also, you will immediately become eligible to participate in our Bonus Book Plan, with savings of up to 65% off the publishers' prices.
- 4. Convenient Service.** At 3-4 week intervals (16 times per year), you will receive the Library of Computer and Information Sciences News, describing the Main Selection and Alternate Selections, together with a dated reply card. If you want the Main Selection, do nothing, and it will be sent to you automatically. If you prefer another selection, or no book at all, simply indicate your choice on the card and return it by the date specified. You will have at least 10 days to decide. If, because of late mail delivery of the News, you should receive a book you do not want, we guarantee return postage.

If reply card has been removed, please write to The Library of Computer and Information Sciences, Dept. 7-DU2-00717, Riverside, N.J. 08075 for membership information and an application. **Byte 5/87**

MAC INKER™

MAC INKER™, Automatic Ribbon Re-inker. Re-ink any fabric cartridge or spool for **less than 5 cents.** Over 70,000 in the field and



we support **ALL** printers. Universal Cartridge or Universal Spool **MAC INKER**

\$68.50.

We have cartridges re-inkable in 10 colors. Ask for your printer type or for complete listing. Bottle ink \$3.00/each. Shipping \$3.00.

PROTEUS™, the 'Siamese' Buffer. It is a **Data Switch** with buffer on both ports. Switch manually or via software. Saves time, space and money. Or ask about our **MAC MASTER** line of Universal Buffers and Printer Controllers (serial or parallel up to 1 MEG).



PROTEUS 64 K-199.00

256 K-299.00 Shipping \$4.00.

Of course we have **Data Switches**, serial/parallel, 2 way, 4 way, crossed etc., at most competitive prices (all lines switched).

CABLES priced \$10-30. We carry cables for all common computers and peripherals. Rapid turn-around on custom orders.

MERCURY MODEM. Really 100% Hayes* Compatible. 300/1200 baud, speaker, full status light display and 2 year warranty. **\$149.00**

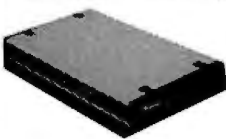

Includes Quick Link Communications Software—fast, quick, easy to learn. **\$29.95** (available for IBM PC or Macintosh)

*Hayes is a trademark of Hayes Microproducts.

MAC THE RIPPER. Our newest, original and welcome printer companion. Pulls off paper perforations and tears the sheets apart. Takes little space and will pay for itself almost immediately in saved time and tedium. Ask for brochure. Introductory Price **\$299.00.** Shipping \$10.00.

Order Toll Free.

Call or write for free brochure.

1-800-547-3303

In Oregon 503-626-2291 (24 hour line)

We are and always will be your

Computer Friends®

14250 N.W. Science Park Drive
Portland, Oregon 97229 Telex 4949559
Dealer inquiries welcome.

The bottom line is that I've been using Zelda for three weeks and the cover hasn't come off again. She's fast and reliable and the nicest AT I've come across.

program has several options on what to do about old files, and I'd chosen the "erase them" route. Since there weren't any files to erase, Fastback wouldn't do anything. Eventually I figured that out and changed options, after which Fastback roared away. In less than half an hour I'd not only transferred all the files, but made a backup copy I could keep.

At that point I had a decision. Zelda II seemed to be working fine. Did I dare trust her? After all, Zenith does make good equipment. Wayne Rash liked the Z-248 best of all the AT machines he tested.

Why not, thought I, and proceeded to install the Cheetah Combo, OmniTel modem, and CompuPro ARCNET PC board. Then I not only put the cover on, I screwed it down before turning it on.

Despite such arrogant temptation of fate, the Zenith came up perfectly. Ready! went into the Above Disc equivalent of EMS. SuperKey and SideKick installed fine. The CompuPro ARCNET PC worked perfectly.

The bottom line is that I've been using Zelda for three weeks and the cover hasn't come off again. She's fast, reliable, and quite the nicest AT I've come across.

EGA

As I mentioned, Zelda came with an EGA board and a Zenith 13-inch EGA color monitor. I had some worries about that: I normally wear bifocal glasses, and I don't care to sit close to a screen and tilt my head, yet if I get far enough away to read through the top part of my glasses, the letters are often too small. I'd solved the problem with Big Kat by having his Hercules board feed into a 19-inch Zenith high-resolution color monitor (which also doubled as my VCR monitor when I felt like watching a movie); but you can't feed an EGA into a CGA monitor. Zelda's EGA board produced sharp and crisp letters, but would they be large enough?

The answer turns out to be "almost."

That is: I've set up Zelda's screen at eye level and about 30 inches from my nose, and I can indeed read what goes up on it. Not as well as I can read Zeke's 15-inch monochrome screen, but in fact well enough that if I didn't have Zeke I'd be willing to use Zelda to write my books. I'm still looking for a good 15-inch EGA monitor, and I think I have a line on one; and for that matter, it can't be long before Zenith produces 15-inch and even larger EGA monitors. I'm now thoroughly convinced that EGA will be the new standard for business use.

Why Use Zeke?

Back in 1977 I looked at all the available computer systems that could be used for business and serious writing. In those days S-100 systems dominated the micro industry, and it wasn't hard to decide what to get. I bought Zeke II, a CompuPro Z80 system. My partner Larry Niven, who knows little about computers and wants to know less, had our consultant Tony Pietsch build him a copy (actually, *two copies*) of what I got.

Neither of us has ever regretted that decision. We have written millions of words, including three best-selling novels, on those computers. They still work, and work well.

Unfortunately, they're not immortal. Tony Pietsch is moving to Santa Barbara. Spare parts are hard to come by.

There are other intimations of mortality. Last week, as is my practice, I packed Zeke—the world's least portable micro—into the trunk of my convertible and headed for a motel, there to get as much done on a novel—*Prince of Mercenaries*, a Falkenberg/CoDominium novel, for those interested—as I could in five days without telephone and mail interruptions. When I got there and set Zeke up, blue smoke poured out of his 8-inch disk-drive enclosure.

It was clearly panic time, but in fact I managed to stay calm. Proceed slowly. Take things apart. Unplug cables. Work logically. After about 10 minutes it was clear: something had happened to the power supply in the disk-drive enclosure. The drives themselves were all right and so was the computer.

A quick call to Priority One established that they had, in stock, 8-inch disk-drive enclosures with power supply at a reasonable price. I drove out, bought one, brought it back to the motel, and re-mounted the drives. Within two hours Zeke was humming along. Incidentally, as far as I can tell, transporting Zeke had caused a nut to work loose from one of the bolts holding the fan, and that nut had shaken into a spot where it could short

continued

The Magic.



The Facts.

The fact is, companies that use POSTSCRIPT® laser printers are creating some very exciting communications. Quite often, the word magic pops up.

Yet behind this exciting development in business communication, you'll find some hard facts worth serious consideration.

Fact. POSTSCRIPT is the page description language chosen by some of the best names in desktop publishing.

Fact. POSTSCRIPT gives you the option of printing from an IBM PC, Macintosh, or mini/mainframe.

Fact. You won't be tied to a single vendor so you can buy the printer that's best for your company's needs.

Fact. Since POSTSCRIPT is device independent, you can design a document, then professionally print it later at a higher resolution.

Fact. You can choose from hundreds of software programs that support POSTSCRIPT.

Fact. POSTSCRIPT lets you combine text, line art, and even digitized photographs on the same page.

Fact. If you don't ask for a printer equipped with POSTSCRIPT, you won't get the magic behind desktop publishing.

Now that you have the facts, just think what your company can do with the magic. For more facts, give us a call at 415-852-0271.



POSTSCRIPT from Adobe.
The magic behind desktop publishing.

The pages above were printed on a POSTSCRIPT equipped printer.
*POSTSCRIPT printers include Agfa Gevaert P400PS, Apollo Domain/Laser 26, Apple LaserWriter/LaserWriter Plus, Dataproducts LZR 2665, Diconix Diji 1/PS, Digital Equipment Corp. PrintServer 40/Script Printer, ITT Gume Script/EN, Laser Connection PS/Jet, Linotype Linotronic 100/Linotronic 300, NEI Model 908, NEC SilentWriter LC-890, QMS-PS 800/800 Plus, QMS-PS 2400, QMS-PS 2700 CK, Sun Microsystems LaserWriter, Texas Instruments Omnii.laser, 2109/Omnii.laser 2115. POSTSCRIPT is a registered trademark of Adobe Systems Incorporated. Other brand names are trademarks or registered trademarks of their respective holders.

something. Anyway, I'd lost little but time, and not a lot of that; but it does give pause to think. Suppose I couldn't find a new enclosure?

A few days later, I was talking with Larry and Marilyn Niven. Marilyn, unlike Larry, does know something about computers. After all, she took a degree in mathematics under Marvin Minsky at MIT. We all agreed that one day soon we'd have to replace our ancient Z80 machines with something else.

Given the way the world is going, that something else will likely be some kind of PC AT compatible with an EGA card. We'll also need a new text editor, one that's as nearly like WRITE as we can find; and that will probably be WordPerfect.

None of this is certain, but we've got WordPerfect 4.2 working with the CompuPro ARCNET PC, something that I couldn't do with 4.1. Now if we can just get oversize EGA monitors.

Still, things change like dreams in this micro world. At CES I was taken upstairs and shown the new Commodore Amiga 2000; the one I saw combined in the same box both a 68020 Amiga and an 8086 PCompatible; and the PC side of the box could take accelerator boards like the Orchid Turbo EGA. Alas, what they later announced as the 2000 wasn't what I saw;

but Commodore potentially has a machine to compete with the Macintosh II if they'll just develop it properly.

Meanwhile, Cheetah has a 386 add-on that will turn a normal AT into about nine virtual machines, neatly solving the problem of what to do about memory-resident programs.

By the time you read this, Apple will have their Mac II, the open Macintosh, and IBM will have a new 386. Microsoft will have Advanced DOS Real Soon Now.

With developments like that going on, why change until you have to?

Winding Down

As usual, I started this column full of good intentions. I spent hours selecting software and covered my desk with really good stuff; and now, before I've got to much of it, I'm out of space.

I do want to say something about Russ Walter's amazing series, *The Secret Guide to Computers*, which is now available in three volumes, \$8 each, from the author. If you need to understand computers and haven't had much luck at it; if you have to teach other people about computers; if you just want to read some good books about computers; then send a check for \$24 to Russ Walter, 22 Ashland St., Somerville, MA 02144. Interested

parties are invited to write for a brochure before ordering. I can't think you won't like the books, and even if you don't, you'll find someone to give them to who will. Highly recommended.

Then there were the MacWorld Exposition and the Seybold Conference on Desktop Communications. Both were worth attending. On the other hand, the most exciting announcement at the Seybold Conference was Appleshare, a very impressive networking program that links Macintoshes; and there's not a lot of point in talking about the Macintosh until Apple releases the open Mac. The delay between my writing this and your seeing it is, due to heroic efforts by the BYTE publishing people, getting shorter, but it's not *that* short.

There are two books of the month: *Flim-Flam* by James Randi (Prometheus Books, 700 East Amherst St., Buffalo, NY 14215) and *On the Frontiers of Science: Strange Machines You Can Build* by G. Harry Stine (Atheneum). James ("the amazing") Randi is a lifelong skeptic who constantly carries a check for \$10,000 that he will pay to anyone who can show him a "paranormal" result he can't explain or duplicate with prestidigitation; while Harry Stine is a rocket engineer who doesn't exactly believe in odd things like dowsing, but who claims to have used such devices with consistent results and will tell you how to make and operate dowsing rods. I've met Randi, and I find his extreme skepticism irritating, while Harry Stine has been a close friend for years. One day I'll build and test some of the machines he describes. Meanwhile, if I had to bet money, I'd bet with Randi, but my heart's with Harry Stine's view.

The game of the month is Strategic Conquest Plus for the Macintosh. It used up far more of my time than I'll admit to *anyone* and is quite simply the best strategic microcomputer war game I've ever encountered. I've managed to win at level 13, but just barely. Now I'm at 14, and in the fight of my life. Highly recommended so long as you understand that it's *really* addicting.

Last-minute report: Big Kat is doing fine at USC. It's a great machine for a student. Now, with any luck, I'll get to that mess of stuff on my desk. ■

Jerry Pournelle welcomes readers' comments and opinions. Send a self-addressed, stamped envelope to Jerry Pournelle, c/o BYTE, One Phoenix Mill Lane, Peterborough, NH 03458. Please put your address on the letter as well as on the envelope. Due to the high volume of letters, Jerry cannot guarantee a personal reply.

Items Discussed

Above Disc \$99.95
Tele-Ware West
909 Electric Ave., Suite 202
Seal Beach, CA 90740
(800) 654-5301

ARCNET PC \$550
CompuPro
26538 Danti Court
Hayward, CA 94545
(415) 786-0909

Cheetah Combo \$395
Cheetah International Inc.
107 Community Blvd., Suite 5
Longview, TX 75602
(800) 243-3824

Fastback \$179
Fifth Generation Systems
909 Electric Ave., Suite 308
Seal Beach, CA 90740
(213) 493-4483

Kaypro 286i PC AT \$2995
Kaypro Corporation
533 Stevens Ave.

Solana Beach, CA 92075
(619) 481-4300

Ready! \$99.95
Living Videotext
2432 Charleston Rd.
Mountain View, CA 94043
(415) 964-6300

Strategic Conquest Plus \$59.95
PBI Software Inc.
1163 Triton Dr.
Foster City, CA 94404
(415) 349-8765

The Norton Utilities 4.0 \$100
Peter Norton Computing
2210 Wilshire Blvd., Suite 186
Santa Monica, CA 90403
(213) 453-2361

Z-248 \$4999
Zenith Data Systems
1000 Milwaukee Ave.
Glenview, IL 60025
(312) 699-4848

THE MAKERS OF VTERM/220 ARE PLEASED TO ANNOUNCE THE FOLLOWING COMPANIES HAVE CHOSEN OUR DEC TERMINAL EMULATION SOFTWARE.



Among our largest customers are ~~General Electric, Westinghouse, Bankers Trust, Inter Development Corp., Sun, and the US Department of Justice.~~

Big institutions can be very close-mouthed about the competitive edge they get from a powerful tool like VTERM/220. So while they'd prefer that we not name names, we can still tell you the reasons why we have more satisfied users than all our competition combined.

First of all, *giant institutions* don't stay giant by being sloppy. They spec things down to a gnat's eyebrow. That's why we're proud to say that VTERM's biggest fans are large corporate, scientific and government installations that perform very serious evaluations of communications software. They give VTERM the highest praise for accuracy of emulation, ease of use, multiplicity of features, speed of execution, and just plain quality.

Just look at VTERM/220's outstanding features:

- Plug compatible VT220 and VT100 video and keyboard emulation with customizable key mappings.
- Powerful file transfer including the most thorough implementation of KERMIT available on the PC, plus XMODEM, and our proprietary protocol VTRANS with complete host-side software for VMS,[™] RSTS/E,[™] RSX11 M/M+ [™] and UNIX.[™]
- Host data capture and conversion to Lotus[®] 1-2-3,[®] Symphony[®] and dBase[®].
- 132-column display via horizontal scrolling or optional video board.
- Scrollback buffer for redisplay of up to 2,000 lines (eighty screens!).
- "Hot Key" toggle between host session and PC DOS.
- Programmable softkeys with script-like capabilities.
- Full support for multinational

and national character sets.

VTERM/220 is not the only thing we have to talk about. There's also our VT100 emulator VTERM III, and our Tektronix[™] 4010/4014 graphics emulator, VTERM/4010. Both of these VTERM's have a lot of the power of VTERM/220, including file transfer.

So if you're looking for terrific terminal emulation programs for your IBM PC or other compatible computers, you and 50,000 other users have found it at Coefficient. We're the leader in DEC Emulation Software. Just ask AT & oops.

Call us today at
212-777-6707 ext. 407.

Coefficient

Coefficient Systems Corporation
611 Broadway, New York, N.Y. 10012



Order Status,
Technical & Other
Info. (602) 246-2222



SPECIAL
WORD PERFECT
\$195

Call for programs
not listed

TOLL-FREE ORDER LINE 1-800-421-3135

FREE SOFTWARE! FREE SOFTWARE! FREE SOFTWARE!

Purchase over \$100 and receive one of these disks absolutely FREE! Purchases over \$250 get two free disks, over \$400 get three, or get all four disks when your purchase is over \$500! 1) **MIXED BAG** — A great assortment of utilities and games all packed on one disk. 2) **PC-WRITE** — Try this famous feature packed word processor. It's a winner! 3) **FONT-SET** — Lets you set popular fonts like bold, underline, etc. on most late model printers from Citizen, Epson, NEC, Okidata, Panasonic, Star, Toshiba, etc. You can even use your printer like a typewriter! 4) **ABC-LIST** — Great mailing list program! Sort on any field, do qualified searches, print reports and mailing labels, and more!

— SOFTWARE —

ACCOUNTING

- BPI AP, AR, PR, GA \$169 ea.
- Cyma Call
- Dac Easy Accounting 39
- Dollars & Sense 94
- Managing Your Money 3.0 108

COMMUNICATION PROGRAMS

- Carbon Copy 115
- Crosstalk 89
- Remote 89
- Smartcom II 83

DATA BASE MANAGERS

- Clipper 380
- Clout 2 Call
- Condor III 310
- Knowledgeman II Call
- Powerbase 2.2 212
- Q&A Call
- Quickcode 138
- Quicksilver 295
- Quickreport 138
- Revelation 469
- R: Base System V 345

EDUCATIONAL

- Flight Simulator 28
- Turbo Tutor II 25
- Typing Tutor III Call

GRAPHICS

- Chartmaster Call
- Energraphics 2.0 269
- In-A-Vision 275
- Microsoft Bus Mouse 106
- Microsoft Chart 164
- Microsoft Serial Mouse 119
- Newsroom 31
- OPTI Mouse W/DR Halo II 106
- Printshop 33
- Signmaster Call

INTEGRATED

- Ability 59
- Enable 355
- Smart Software Call

LANGUAGES

- Lattice C Compiler 242
- Microsoft C Compiler 249
- Microsoft Fortran 4.0 255
- Microsoft Macro Assembler 84
- Microsoft Pascal Compiler 166
- Microsoft Quick Basic 55
- Ryan McFarlan Fortran 305
- Ryan McFarlan Cobol 479
- Turbo Pascal w/8087 + BCD 55

PROJECT MANAGER

- Harvard Total Project 262
- Microsoft Project 219
- Super Project Plus Call
- Timeline 2.0 209

SPREADSHEET

- Microsoft Multiplan 108

- Spreadsheet Auditor 3.0 \$82
- Supercalc 4 Call
- VP Planner 49

UTILITIES

- Copy II PC 19
- Copywrite 39
- Desqview 55
- Double Dos 30
- Fastback 85
- Graph in the Box 55
- Homebase 39
- Microsoft Windows 55
- Norton Utilities 3.1 48
- Prokey 4.0 70
- Sidekick (unprotected) 47
- Sideways 3.1 36

WORD-PROCESSING

- Easy Extra 88
- Microsoft Word 252
- Multimate Advantage Call
- Peachtext 5000 145
- Volkswriter 3 139
- Webster Spellcheck 37
- Word Perfect 195
- Wordstar 162
- Wordstar Propac 233
- Wordstar 2000 233
- Wordstar 2000+ 278

— HARDWARE —

ACCESSORIES

- Copy II PC Board 75
- 150 watt power supply 69
- Mini Micro Parallel Print Buffer 69
- Masterpiece 88
- Masterpiece Plus 113

BOARDS

- AST Advantage Premium 429
- AST Premium Sixpac Call
- AST Sixpac (384K) 199
- Hercules Color Card 145
- Hercules Graphics + 182
- Intel Above Boards Call
- J Laser (Tall Tree) Call
- J Ram 3 (Tall Tree) 159
- J Ram 3 AT (Tall Tree) 199

COMPUTERS

AZ TURBO PC

- IBM Compatible Computer, 4.77 or 7.47 key selectable, keyboard, 640K, dual drive, mono graphics card, 150 watt power supply 719
- or with 20 MB Seagate Hard Drive 1025
- 6 month limited warranty

AZ TURBO AT

- IBM AT Compatible, 512K, 6 & 8 MHZ, keyboard, graphics card, 220 watt power supply, MS/DOS 3.2 GW Basic 1260

AST 286

PREMIUM COMPUTER

- 512K, expandable to 2MB on the system board, RT enhanced style keyboard, parallel, serial and clock, 1.2 MB floppy disk drive, 7 expansion slots, two 32 bit fastram slots, DOS 3.1 & Basic 1 year warranty Call

- Sharp Portable Call

EGA BOARDS

- Everex Enhancer EGA 235
- Paradise Auto Switch 480 EGA Card 379
- Quad EGA Plus 349
- STB EGA Plus Call
- Vega Deluxe Call
- Vega Video 299

EGA MONITORS

- AMDEK 722 455
- NEC Multisync 559
- Packard Bell EGA 450

HARD DRIVES

- AZ 20 MB Hard Card 425
- AZ 30 MB Hard Card Call
- Filecard 20 MB 555
- Maynard 20 MB Hard Card Call
- Plus Hardcard 20MB 665
- Seagate 20 MB Int. w/cont. 355
- Seagate 30 MB Int. w/cont. 399
- Seagate 30 AT Int. 539

INCREDIBLE VALUES

- Nationally advertised boards for IBM PC and most compatibles at give away prices.
- Keyboards (similar to 5151) \$79
- Monochrome Board w/printer port (similar to Hercules Graphics) \$79
- Expansion Board 0 to 576K \$42
- Multifunction Board w/game port (similar to AST six pack) \$79
- Four Drive Floppy Controller \$39
- Color Card w/o printer port \$69
- Color card w/printer port \$79

KEYBOARDS

- Keytronics 5151 \$162
- Keytronics 5153 269

MODEMS

- Everex 300/1200 120
- Hayes 1200 Call
- Hayes 1200B Call
- U.S. Robotics Courier 2400 349
- U.S. Robotics Passwd. 1200 .. 180

MONITORS

- AMDEK 410 Amber 157
- AMDEK 600 339
- Magnovox Color RGB Call
- Multitech Color RGB 299
- Princeton Max 12 159
- Samsung TTL Amber 72
- Samsung TTL Green 70

PRINTERS

- CANON LASER 1939

CITIZEN

- MSP-10 279
- MSP-15 379
- MSP-20 315
- Premiere 35 Daisywheel 459

EPSON - Call on all models

FUJITSU

- DX2100 Parallel Call
- DL2400 Ser/Par Call
- LASER IMAGE 2000 Call

NEC

- NEC P5XLP 1095
- NEC P7 Parallel 619
- NEC 8850 1059
- NEC P6 Parallel 439

OKIDATA - Call on all models

PANASONIC

- 1091-I 259
- 1092-I 329
- 1592 425
- KXP3151 399

STAR MICRONICS

- NP10 Call
- NB15 975
- NX10 232
- SG15 365
- SR15 549

TOSHIBA - Call on all models

RAM

- 64K 150NS (set of 9) 10.50
- 256K 150NS (set of 9) 27
- 256K 120NS (set of 9) Call

TERMS: Shipping on most software is \$5.00. AZ orders +6.7% sales tax. Personal check/company check - allow fourteen (14) days to clear. We accept purchase orders from authorized institutions for 3.5% more than cash price. All returns are subject to our approval. There will be a 20% restock fee. Minimum phone order \$50. All prices are subject to change. Due to copyright laws we cannot take back any open software.

No Charge for Master Card or Visa



We do not guarantee compatibility

TOLL-FREE ORDER LINE 1-800-421-3135
WAREHOUSE DATA PRODUCTS

2701 West Glendale Ave. • Phoenix, AZ 85051

Phone Hours: Monday, Wednesday & Thursday 7 am-9 pm; Tuesday & Friday 7 am-5 pm; Saturday 9 am-5 pm. MST.



Publish and/or Perish

Bruce Webster

It's mid-January as I start this column, and the wind outside is literally howling. A mass of very cold air has come to visit from the north pole; temperatures have plummeted, and gale-force winds out of Provo

Canyon have pushed the windchill factor below zero. This is the first time it has really felt like winter all year. The ski resorts, which had a terrible holiday season, wish that this had hit about a month earlier. Since I don't ski, I don't really care. But on to more important matters.

If there's a theme to this column, it's desktop publishing. It was the dominant theme of the MacWorld Exposition, and some of the products I will look at this month (like the Radius Full Page Display for the Mac) are related to desktop publishing. It doesn't mean that I'm getting away from a technical slant, but during the next few years the personal computer market is going to be heavily influenced by desktop publishing, and those of you looking for new products to develop might well keep that in mind.

Industry Update

Apple announced a new version of the Apple IIe this past week, replacing the old model. The major differences are an expanded keyboard and a platinum case, both of which are designed to bring it into line with the IIGS. The list price is still \$829 for the base unit—that price doesn't include monitor or disk drives—and the IIGS upgrade is still \$495. It's a good move for Apple, but the price is still quite high, considering that \$1095 is now the list price for an Atari 1040ST (1 megabyte of RAM, 68000 microprocessor) with an RGB monitor and a built-in 720K-byte drive.

Speaking of the IIGS, Apple appears to be having a supply problem. While at the MacWorld Exposition, I talked with several companies that also make IIGS products. All these companies indicated that sales of IIGS items were very poor; several estimated the number of IIGS systems shipped to date (early January) at around 20,000. This jibes with reports I've had from some dealers that they didn't get any IIGS systems until just before Christmas. It also explains why Apple turned down my request for a IIGS on editorial loan, even though I explained that a number of firms were willing to send me products once I had a system. For that matter, some firms have already sent me IIGS products, but I have nothing to run them on.

Also on a down note, representatives from some firms that market development software (assemblers, compilers, etc.) for the IIGS mentioned abysmal sales of their products. I don't know if that's because all the IIGS developers are using the versions of Apple Programmer's Workshop (APW) that Apple has sent out or because a lot of firms are waiting to see how many

Serious business at the
Mac _____ *ook*
at desktop publishing

units Apple actually sells and ships.

Atari made a big splash at the Consumer Electronics Show with two sets of announcements. First, the company showed its latest ST machines:

the Mega ST 1, 2, and 4 (the numbers refer to the amount of RAM in megabytes). I didn't attend CES, so I haven't seen the machines in person.

From the press releases I've read, though, it appears that Atari wants to get a bit more upscale and has put out a machine that would actually look decent in a business environment: detached keyboard, system unit upon which you can set your monitor, and so on.

More important, they've designed in an expansion path, using an external bus (like the Amiga). Of course, I thought that the Amiga had pretty much proved that an expansion bus wasn't nearly as nice as a few slots, but the bus still beats the relatively closed architecture of the 520ST and 1040ST. Atari also announced a new line of low-cost MS-DOS (IBM-compatible) machines. That startled me since the MS-DOS market is rather cutthroat right now, but Jack Tramiel has cut throats with the best of them, so maybe I shouldn't be surprised. Look for a full report in an upcoming column once I get my hands on the systems.

Commodore also announced some MS-DOS systems; theirs are more expensive than Atari's, but they're also more expandable. And I understand that Commodore was privately showing some other new machines that may well have been announced by the time this sees print.

IBM has yet to announce anything, though (as in times past) various publications are running lengthy articles on unannounced (and possibly imaginary) systems. Most rumors focus on a new line of machines that are relatively cheap (for IBM) and have some degree of MS-DOS compatibility but that have proprietary silicon and a different expansion bus than the current MS-DOS systems.

I'd be interested in seeing IBM introduce such machines; my personal feeling is that they'd go the way of the IBM PCjr, the IBM Portable (not to be confused with the IBM Convertible), the never-materialized PC II, and the IBM RT series. Speaking of which, is there anyone out there who has actually bought an IBM RT or who works for a company that bought one? I've heard that IBM donated a number of RTs to Carnegie Mellon, but I have yet to hear of a single customer who paid cash for one.

continued

Bruce Webster, a consulting editor for BYTE, can be reached c/o BYTE, P.O. Box 1910, Orem, UT 84057, or on BIX as bwebster.

If you have, please write me a letter or send me a message via BIX, MCI, or CompuServe.

MacWorld Exposition

Suits. Lots of suits. If I had to put my finger on what was distinctive about this year's MacWorld Exposition in San Francisco, it would be the large crowds of serious businessmen (and businesswomen) in suits, filling the Moscone Center during the Thursday and Friday sessions that were supposed to be lightly attended. The Mac, my friends, is finally being taken seriously by the business community. Most significant, though, is that it appears to be the end users, not the data processing managers, who are so treating the Mac. They want powerful spreadsheets, innovative database programs, and high-quality publishing software, and they don't want to go through hours of training to learn how to use them. Also, they don't give a hoot if their machine doesn't have those magic letters "IBM" on it.

MacWorld also showed why the Macintosh is still at the leading edge in desktop publishing. The long drought of word processing software has finally ended (thanks to Apple's halt to bundling MacWrite with each Macintosh). Five different word processors were on display: Microsoft Word 3.0, FullWrite, MindWrite, WordPerfect, and Write Now. On top of that were three different publishing programs—PageMaker 2.0, ReadySetGo 3, and MacPublisher III—each of which is ahead of what's available on any other system (although PageMaker 2.0 is due to be released soon on the IBM PC). It's interesting to see how these two groups of products are converging on one another, each side gaining more and more of the features of the other. Also, Adobe showed its Illustrator program, which lets you quickly and easily create object-based illustrations from digitized images.

Aiding all this were three external screens for the Macintosh. Radius had its FPD (Full Page Display), a 640 by 864 display for \$1995. The FPD is reviewed in detail later in this column. The Big Picture, from E-Machines, offers a 1024 by 808 display for the same price. The final one is the MegaScreen II from MicroGraphic Images. It has the largest display—1024 by 900—and the largest price tag: \$2495 for a basic unit, \$2995 for one with NTSC output as well and options for a 68881 math coprocessor and/or a 20-megabyte hard disk (both at extra cost).

Inexpensive SCSI hard drives for the Mac are also proliferating. The installed base of Macs has grown big enough to drive the prices down, and it seemed as though everyone was showing 40-megabyte hard disks linked with 40-megabyte tape drives (for backup). An era of cheap hard disks for the Mac is dawning. I hope to have hands-on reviews of some of those disks in the near future.

Levco, maker of the Prodigy 4 (it includes a 68020 with a 68881) upgrade, has come out with a lower-cost version. The Prodigy Prime sells for \$1995 and includes a 16-megahertz 68020, 1 megabyte of RAM (using a 32-bit data path), and an SCSI; a 2-megabyte version sells for \$2750. It has sockets for a 68881 math coprocessor and a 68851 memory management

unit; memory expansion is limited primarily by cost and software (the spec sheet gives an upper limit of 32 megabytes). The original Prodigy 4 (sans hard disk) has come down in price itself; you can now get it for "only" \$4995, which buys you a 68020, a 68881, 4 megabytes of RAM (using 1-megabit chips), and an SCSI.

Incidentally, MicroGraphic Images had in its press kit a release touting the compatibility between the MegaScreen II and the Prodigy Prime. In other words, you can hook both up to the same Mac, and it works just fine (or so the press release said). I'd love to get my hands on such a system, but I'm afraid it would spoil me terribly.

Also, Levco may finally have a competitor. MacMemory Inc. was demonstrating its TurboMax upgrade for the Macintosh. The TurboMax has a 16-MHz 68000, 1 1/2 megabytes of RAM, a socket for a 68881, and a "superspeed" SCSI. It's listed at \$1299 and is supposed to be available now. Table 1 shows the timings claimed by MacMemory versus those claimed by Levco. These benchmarks were done using Consulair's 68020 C compiler, with direct access to the 68881 for the Whetstone benchmark on the Prodigy Prime and the TurboMax.

Speaking of Consulair, Bill and Ann Duvall were there, introducing MacC Jr., an \$80 C development system for the Macintosh. I haven't had a chance to test it yet—look for that next month—but it looks like a fairly complete system for a very low price. Those of you thinking of doing C programming on the Mac could do a lot worse than to buy this.

All in all, I had a great time at MacWorld. The show is now larger, more lively, and more interesting than the West Coast Computer Faire. I'm tempted to try to attend the one in Boston this summer; I'll have to see what's happening then.

ReadySetGo 3

I don't talk much about applications in my column, but I wanted to mention this product. It's a member of the latest generation of desktop publishing software for the Mac (along with PageMaker 2.0 and MacPublisher III). For those of you unfamiliar with desktop publishing software, it lets you create your document (no, you don't need a separate word processor), establishing just how each page is laid out. You can easily integrate graphics, move blocks around, and generally do just what you'd want to do to create ready-for-printing documents.

RS3 works well. I used it to lay out my Fritzie Award certificates. I did have to look at the manual once or twice, but beyond that, I was easily able to figure out how it worked. And the resulting certificates looked great when they came out on the LaserWriter.

Be warned, though: Desktop publishing is addictive. Once you've laid out a full-page document, all sorts of ideas start springing up in your head: fliers, posters, newsletters, books. As if I didn't have enough to do.

Desktop Publishing

No, I'm not dredging up the topic again. That's the name of a newsletter: *Desktop Publishing, Bove and Rhodes' Inside Report* (501 Second St., San Francisco, CA 94107, (415) 546-7722). Tony Bove and Cheryl Rhodes originally put out *CP/M User's Guide*, then they started a magazine called *Desktop Publishing*, which PCW Communications acquired and retitled *Publish!*. (Got that straight so far?) Tony and Cheryl have since started one of those high-cost, no-advertising newsletters that industries like ours seem to spawn. It contains all the latest news, gossip, rumors, and conjectures as to just what is happening in the desktop publishing world. It also has comments on new and existing products.

I've looked through all the issues put out so far (publication is monthly, and the newsletter started in September 1986). From

Table 1: Benchmarks from product literature, comparing Levco's Prodigy Prime against MacMemory's TurboMax. The lower time for the Mac Plus/Whetstone benchmark is from MacMemory's literature; the higher is from Levco's.

	Mac Plus	TurboMax	Prodigy Prime
Sieve	3.75 seconds	1.62 seconds	0.66 second
Dhrystone	772/second	1800/second	3246/second
Whetstone	6178/second 7273/second	199,336/second	612,244/second

ACCORDING TO WEBSTER

what I can see, Tony and Cheryl appear to be doing a solid job. Of course, it's flavored with their own opinions and biases, but theirs are worth more than most folks—which is why people subscribe to newsletters like this. The official yearly subscription rate is \$195. However, some recent promotions (like one at MacExpo) have offered a year's subscription for only \$95, with a cancel option after the first issue. If you're interested, you might call to see if such a promotion is in effect.

Radius Full Page Display

As mentioned, three different firms were showing large-screen displays for the Macintosh at MacExpo. One firm, Radius, was kind enough to lend me an FPD (Full Page Display) for a week, along with a Mac that already had the internal hardware hooked up. Within 24 hours, I was hooked.

The Radius FPD consists of two parts: a logic board that fits inside the Macintosh and a high-resolution monochrome CRT inside a beige display case. The logic board has 32K bytes of ROM—to help interface the FPD with the Mac—and 128K bytes of RAM—the actual video display memory. The connection port comes out through the "security port" (located on the back left edge of the Mac), so you don't have to cut any holes in your case. A video cable from the CRT plugs into that port.

The CRT itself sits (usually) to the left of the Macintosh; the two units have a combined footprint 21 inches wide by 12 inches deep. The FPD has its own power supply, and there is a switched outlet in the back of the CRT so that you can plug your Mac into it, plug it into the wall, and turn your entire system on with one switch. The screen is designed to show a full 8½- by 11-inch page at a time. Resolution is 640 pixels per line by 864 lines, with 80 pixels per inch (as opposed to 72 pixels per inch on the Mac's screen). The display is pleasant to look at and doesn't have the flicker that the Macintosh does. Additionally, you can attach adjustable feet onto the bottom of the display so that you can tilt it to suit your fancy.

No special software is needed to use the FPD. Just boot your system as you would normally, and the desktop appears on the large CRT with the menu font automatically resized to 16 points for increased readability. The Mac's screen is still active as well, allowing you to stick windows, desk accessories, and other items over there. A built-in "blinker" program automatically turns both screens off after a certain period of inactivity. All windows that appear have the little "full-size" icon in the upper left corner, allowing you to resize the window to the full FPD display with a single click, and a set of "shortcut" commands let you easily move and resize windows.

You can configure the FDP to suit your preferences. Just keep the mouse button pressed during boot-up, and a control panel appears, allowing you to adjust several parameters, including menu font size (12 or 16 points), arrow cursor size (the regular 16 by 16 or an enlarged 32 by 32), FPD placement (left or right side of the Mac), time delay for the automatic blinker (longer or shorter), relative vertical offset of the FPD and Mac displays (up or down), screen combinations (Mac alone, FPD alone, or both Mac and FPD), and full-size icons on all windows (enable or disable). The settings are saved in the Mac's battery-backed parameter RAM, so that they are "remembered" from session to session.

I ran numerous applications on the Mac/FPD combination—which is what got me hooked. Many applications automatically recognized the larger display area and immediately opened any window to the full size available. That full size can make quite a difference. I used one compiler with the font set to 9-point Monaco; the editing window showed 70 lines of code at a time, as opposed to about 25 lines on a regular Mac screen. I was pleasantly surprised at how much easier it was to modify and debug

continued

HITACHI-TOSHIBA-NEC-FUJITSU-SIEMENS-SAM SINGAPORE WESTERN DIGITAL MICROSCIENCE CDC OKidata INSTANT CREDIT NOW AVAILABLE CALL FOR DETAILS

American Semiconductor

THE BARE XT TURBO SYSTEM
\$399 Looks, tastes and acts like the IBM, AND, it's 100% COMPATIBLE!
 Includes: Disk Drive, Floppy Controller (Dual), Cables, 64K Memory, Turbo, Socketed Mother Board, PALs, Bios, Steel Cabinet and 150 Watt Switchable Power Supply plus AT Style Keyboard

FREE SOFTWARE WITH PURCHASE!
 INCLUDES WIP, SPREADSHEET, FINANCE MANAGER AND COMMUNICATION. \$10 FOR DISKS, LIMITED TIME OFFER!

AT CLONES \$999.00

HAYES COMPATIBLE MODEM 300/1200 INTEXT WITH SOFTWARE \$139.00

Portable Clone \$799.00
 XT Power Supplies (150W) 79.00
 XT/AT Keyboards 69.00

WINCHESTER DRIVE KITS \$159 CALL FOR DETAILS

ALL DRIVE KITS INCLUDE CONTROLLER CARTRIDGE CABLES/MEMORY

Hard Drive Case with 150W Power Supply
 20MB Half Height CC Kit 239.00
 20MB 2 1/2" Stack Mount Kit 279.00
 30MB Half Height PULL Kit 399.00
 30MB Stack Mount Kit 529.00
 30MB Full Height Kit 599.00

Hard Drive Controller AT 159.00
 EGA Cards 499.00
 Floppy Controller w/Cables 28.00

Monitor Boards 599.00
 02830 Floppy Control Drive 79.00

386 MOTHER BOARDS AND UNITS NOW AVAILABLE

PRINTERS
 EPSON, OKIDATA, DIABLO and others
 AS LOW AS \$399.00

EPROM/STATIC RAM
 27512 Serial \$14.75
 27C516 Parallel 3.90
 27C512 Parallel 3.55
 27C512 Parallel 2.65
 27C514 Parallel 3.20
 2764 Serial 2.55
 6284LP-16 Serial 1.60

MONITORS
 Composite Monitor \$ 79.00
 Color Monitors 299.00
 AS LOW AS \$199.00
 High Res Monitors 800.00
 EGA Monitor 625.00
 AS LOW AS

ADD-ON CARDS
 Monochrome Graphics V 41294 from \$ 1.99
 WITH Port Printer \$ 79.00
 Color Graphics Card V 88.00 9087-2 159.00
 Parity Port 29.00 9087-2 159.00
 Mail IO WITH 438.00
 FLOPPY CONTROLLER 99.00
 Mail Function (EPROM Loaded) 8021-9 259.00
 Card 0364K w/Software 99.00

TECHNICAL SUPPORT 813-961-5564
 Import/Export 813-961-9444

TO ORDER TOLL FREE CALL 1-800-237-5758 EXT 112
 COMPLETE SYSTEMS STARTING FOR LESS THAN \$500/MONTH

NORTHEAST REGIONAL SALES OFFICE: 1-301-933-3523
 PRICES SUBJECT TO CHANGE DUE TO AVAILABILITY AND MARKET FLUCTUATIONS
 CALL TODAY FOR ITEMS NOT LISTED AND DEALER PRICING. ADD 3.95% FOR
 Corporate Headquarters: 16520 N. Florida Ave., Lutz, Florida 33549, (813) 961-9444

MICROSCIENCE INFOSCRIBE CDC OKidata HITACHI-TOSHIBA-NEC-FUJITSU-SIEMENS-SAMSUNG-HYUNDAI-MICRON TECHNOLOGY

SUPERIOR PRICE/ PERFORMANCE VERSION

OPC, a leading manufacturer of Computers & Telecommunication equipments in Korea, do our best to meet any customer's needs. We export CRT Display Terminal, Hard Disk Drives, Key-Phone System on an OEM basis.



OPC Oriental Precision Company Ltd.

HEAD OFFICE
 Add: Seoul Office: Geon-Seoul Bldg., 11 12th Fl. 71-2, Nonhyun-dong, Kangnam-gu, Seoul, Korea
 C.P.O. Box 1301 Seoul, Korea. Cable "PRECISION" Seoul TX ORANGE #1737
 Tel: (02) 771-37, 549 3874 (Direct) Fax: (02) 549-7679

SUNNYVALE OFFICE
 ADD: 1056 DUANE AVE SUITE 100
 SUNNYVALE CA 94089 U.S.A.
 TEL: (408) 245-0265
 FAX: (408) 737-2636

TOKYO OFFICE
 ADD: 2ND, FL., SECOND BLDG. 16-11 KIJONJIMA 2ND
 NHOHBASHI CHUOHU TOKYO, JAPAN
 TEL: (03) 681-9217
 FAX: 3-681-9209

AT LAST: Professional Typesetting Capability For PC Users

With **PC T_EX**[™] — the best-selling full implementation of Professor Don Knuth's revolutionary typesetting program T_EX.

FINEST Typeset Quality Printing From:
dot matrix laser phototypesetter

$$\sum_{i=1}^{\infty} \frac{1}{i} \begin{pmatrix} a_{11} & \dots & a_{1n} \\ a_{21} & \dots & a_{2n} \\ \vdots & \ddots & \vdots \\ a_{m1} & \dots & a_{mn} \end{pmatrix} \int_{-\infty}^{\infty} e^{-x^2} dx$$

WIDEST Range Of Output Device Drivers:

- Epson FX, LQ
- Toshiba
- Corona LP-300*
- Screen preview, with EGA or Hercules card
- HP LaserJet*
- Apple LaserWriter
- APS-5 phototypesetter

MOST COMPLETE Product Offering:

PC T_EX (not copy protected) includes the following:

- Our specially written *PC T_EX Manual*, which enables you to start using T_EX right away.
- Custom "macro packages" that provide formats for letters, manuals, technical documents, etc.
- The *L^AT_EX* document preparation system, a full-featured macro package for preparing articles, books, reports, etc., and *L^AT_EX User's Manual*.
- *A_MS-T_EX*, developed by the *Amer. Math. Society* for professional mathematical typesetting.

Site licenses, volume discounts, and interfaces to PC Paintbrush, PC Palette, FancyFont and Fontrix are also available.

PRICED FROM ONLY \$249.00!

(Printer drivers and interfaces additional.)



Laser printer,
fonts & software
from \$2995.00

For IBM PC/XT, AT or compatible, DOS 2.0 or higher, and 512K RAM. Hard disk required for printer drivers and fonts.
*HP LaserJet and Corona require additional interface boards.

For more information call or write:
Personal T_EX, Inc.

12 Madrona Avenue, Mill Valley, CA 94941 (415) 388-8853

This ad, with space for the photograph, produced by PC T_EX. Typeset on the Epson FX80, the Corona LP-300 laser printer, and the Autologic APS-5 phototypesetter.

T_EX is a trademark of the American Mathematical Society. Manufacturers' product names are trademarks of individual manufacturers.

code with the larger display. I had expected some improvement, but not as much as there actually was. Each click on the scroll bar moved me through the program 70 lines at a time, allowing me to quickly scan up and down through my source code.

Similarly, ReadySetGo 3 was a lot easier to use with the FPD. I originally laid out my Fritzie certificates on a regular Mac screen using RSG3; even with the compressed "full-page" display, it took careful use of the ruler margins and not a little trial and error to get everything laid out perfectly. After I got the FPD, I ran RSG3 again and brought up the same document. The entire page was visible on the CRT; precise layout and alignment would have been a cinch. Other applications, like More and MacDraw, felt more powerful and flexible with the larger display.

Most applications I tried worked fine, though there were occasional problems. For example, SuperPaint wouldn't let me open a window and move it all the way over to the Mac's screen; each time I would position it there, the window would snap back onto the large screen. The manual itself lists problems (mostly minor) with MacWrite, MacDraw, Word (version 1.05), Excel (version 1.00), and FullPaint. Also, as you might expect, games had the biggest problems. Several, like Dark Castle, Ferrari Grand Prix, and Balance of Power, just wouldn't run on the system I had (a Mac 512K-E with the FPD display), all failing or freezing at some point. Others would run but had malfunctioning devices (like the compass and Up/Down buttons in Azarok's Tomb).

I do have two major complaints. First, the CRT should have been wider. I can open up a full 8½-by 11-inch page under ReadySetGo 3, but it obscures the tool icons along the left edge of the screen. Similar problems exist with MacDraw and other applications. The designers of the Radius FPD should have anticipated that and increased the width to 720 pixels or so, allowing an icon strip down the left side while preserving the full 8½-by 11-inch document window.

Second, the FPD is just too darned expensive. At \$1995, it's beyond the reach of the average Mac user, and it's substantially narrower than its two major competitors—The Big Picture and MegaScreen II—without being substantially cheaper (the other two are \$1995 and \$2495, respectively). There may be other advantages the Radius FPD has over its competitors (and vice versa), but since I have not tried the other two yet, I can't say what they might be.

Even with those complaints and the occasional software problems (and when have Mac owners not had to wrestle with software incompatibilities of some sort?), the Radius FPD has me sold on large Mac displays. The regular Mac screen now seems very, very small . . . almost depressingly so.

Zen and the Art of the Macintosh

While wandering through MacWorld, I passed a retailing booth where numerous products were being hawked. Sitting quietly before the tables, autographing books, was a tall, thin, graying young man: Michael Green. I picked up a copy of his book, half-amused, half-annoyed at the title. After two minutes of browsing, I bought a copy, had Green sign it, chatted with him for a while, then walked away, tickled with my purchase and contemplating buying a few copies for friends.

Zen and the Art of the Macintosh: Discoveries on the Path to Computer Enlightenment (available at \$16.95 from Running Press Book Publishers, 125 South 22nd St., Philadelphia, PA 19103) is to other computer books what the original Mac was to the rest of the computer industry. It charts Green's discovery of the Mac, his thoughts as to its impact on the human spirit, and his struggles with being seduced by what he terms "the digital undertow." He even talks about how he created the book itself:

continued

Revolution.



Drafix 1 CAD, \$195

Evolution.



Drafix 1 Plus CAD, \$295

Drafix 1 totally changed the image of low priced CAD software.

It proved that you could have extremely sophisticated performance and features demanded by serious CAD users.

Yet still be very easy to learn and use for the novice. All at an amazingly low price.

Now we've done something even more dramatic. We've improved it.

Drafix 1 Plus. A great new package at a great old price. \$295.

Reviewers called Drafix 1 a "breakthrough" in design, speed and ease of use.

Drafix 1 Plus is a breakthrough in value.

Check these exciting new features:

— A pop-up text editor for writing, editing and rearranging even large blocks of copy.

— Function key macros so you can store and customize Drafix commands to your personal workstyle.

— Sophisticated curve-fitting splines and free-form sketching functions to let you draw complex shapes.

Plus we added two more bonuses. A symbol library (an \$80 value) with 450 pre-drawn, time-saving symbols.

And, along with our standard pen-plotter support, our DotPlotter software (worth \$45) that lets you create high resolution plots of any size on your dot matrix printer.

Of course if these are more features than you need there's an equally good choice — Drafix 1.

Drafix 1. Everything you want in CAD software — at \$100 less.

Reviewers called Drafix 1 "the best CAD buy in town" at \$295. We wonder what they'll say for \$100 less.

That's right. The original Drafix is still available at a dramatically reduced price. For just \$195 you can have all of the features and performance that made Drafix 1 "the best CAD buy under \$500."

A powerful CAD tool you'll be using in minutes.

You'll never use an easier menuing system than Drafix. Everything is on display all of the time so there's no searching, backtracking or memorizing.

In just minutes you'll be doing drawings that would take days to learn on most other CAD software.

And you'll find yourself easily using features that are normally found only on software costing more than 10 times as much as Drafix.

Rotating, scaling, stretching and trimming, multiple object snap modes — they're all included along with much, much more.

Drafix is a powerful, full-featured CAD tool. It just doesn't happen to be priced like one.

Order toll free and get our 30-day money back guarantee.

One thing hasn't changed. Our money back guarantee.

Try Drafix 1 or Drafix 1 Plus for 30 days and return it for a full refund if you're not completely satisfied.

With no-risk, high performance and affordable prices, there's just one choice to make.

To buy the package that started the CAD software revolution. Or the one that's continuing it.

Make your toll-free choice today.

Order Now!

Contact your local Drafix dealer or call toll-free.

Use your Visa, MasterCard or American Express

1-800-231-8574

Ext. 150

- Drafix 1 CAD package, now only \$195.00
- Drafix 1 Plus CAD package (includes \$45 DotPlotter and \$80 symbols library) just \$295.00
- Mouse Systems mouse also available (add \$100)
- Ask about our Architectural, Mechanical and Electrical symbol libraries and OTTO, our AutoCAD File Exchange Utility.

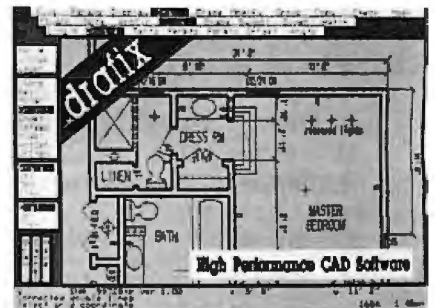

FORESIGHT
Resources Corp.
932 Massachusetts
Lawrence, KS 66044
(913) 841-1121



**350 Plus IC
High Performance
Printed Circuit
Board CAD
for
\$975.00!!**

All the features of Engineering Workstation CAD, on XT or AT Personal Computers—and at an affordable price!

- 1 mil data base, 32" x 32" area, up to 30 layers & 250-350 IC's
- Automatic and Interactive Placement aids, including Dynamic Rubberbanding, Connection Length Measurement, Auto Part Swapping, and other aids
- Interactive Routing on any grid from 1 mil upwards, i.e., 5, 10, 15, 20, 25, 50, etc. Thru, Blind and Buried Vias of Standard and Micro size. Filled tracks and pads at the CRT. Fine Line Design—2 tracks between IC's. Track Segment thickening. Angles at 90, 45 and 1 degree.
- Auto Routing (optional) • Auto Air Gap Checking
- 2-D Documentation capability • TTL/CMOS Library included
- Full SMD and Analog Board design supported
- Post Processing to matrix printer, wet ink plotter and Gerber (optional)
- Our many years of practical board design and CAD experience have created the board designer's *IDEAL* system—NOT a programmer's concept of what the designer needs!!

PADS-PCB \$975.00
Different options available
Demo disk with manual \$50.00

CAD Software, Inc.
P.O. Box 1142, Littleton, MA 01460 (617) 486-9521

hardware, software, and techniques.

Intellectually, the book is stimulating. The title is a serious one, at least as serious as Zen ever is. The book itself, however, does not take itself or its subject too seriously. In it, Green mixes thoughts and ideas about Zen with discoveries about doing art on the Mac. The result provides a look at the Mac, and at computers in general, that is refreshing, enlightening, and entertaining.

Visually, the book is stunning. The emphasis is on design, layout, flow, and images, with text as an important afterthought. I marvel at the amount of time each page must have taken to create and wince when I realize there are more than 230 pages. I wonder if Green winced as he walked around the show and saw the new large screens and software like Adobe Illustrator. Somehow, I doubt it; Green struck me as one who wastes little time regretting what is done.

Yes, you should buy it. It doesn't cost that much (\$16.95), and it's worth it just to see what one person can do with a Macintosh. But it is much more than that. No, I am not a devotee of Zen, but that doesn't lessen the book's worth or impact. I pick it up a few times a day just to browse and find something new each time.

While talking with Green, he mentioned that he was supposed to give a talk later on the future of desktop publishing and that he was gleaning ideas to present. He looked at me, smiled, and said, "What do *you* think is the future of desktop publishing?" I held up his book and answered, "This."

The Macintosh Bible

While we're on the subject of "must buy" books for Macintosh owners, let's look at *The Macintosh Bible* by Dale Coleman and Arthur Naiman (available at \$21 from Goldstein and Blair, P.O. Box 7635, Berkeley, Ca 94707, (415) 524-4000). Simply put, it's a compendium (400+ pages) of all those little bits and pieces of Macintosh lore that you tend to overhear in users group meetings or see posted on computer bulletin boards. For example, did you know that if you hold down the Option key when you launch the Font/DA Mover, it will come up prepared to transfer desk accessories instead of fonts? Did you know that Word supports soft hyphens? Did you know that printing documents that are more than 25 percent solid black can cause the print head on the original Imagewriter to overheat and fail?

Well, I didn't either, and I've owned or been using a Macintosh for nearly three years. A lot of things I didn't know because I just didn't care (such as the nonstandard use of Command-Z in OverVUE). But plenty of them are of great interest to me, and I've already picked up a number of shortcuts and techniques that I wish I had known about long ago.

Most notes in the book fall into eight basic categories, each indicated by an icon in the margin: very hot tips, important warnings, shortcuts, very good features, very bad features, bargains, things to come, and gossip/trivia. Not all items are so classified, but the icons help to flag those things you'll be sure to want to read.

The book itself is organized into four parts. Part I, "Maximizing System Software and Utilities," gives tips, hints, and warnings about the user interface, the operating system, and some of the more common system utilities (Font/DA Mover, Switcher, MiniFinder). Part II, "Maximizing Application Programs," does the same for specific applications, like Word, Helix, MacPaint, Red Ryder, and ReadySetGo. Part III, "Maximizing Hardware," talks mostly about printing, and there mostly about using the LaserWriter. Part IV, "Maximizing Your Purchases," gives suggestions on how to get the most for your money and includes brief reviews of a long list of products. The three appendices are almost worth the price of the book for

continued

Customize Your Keyboard



- Eliminate Confusion
- Reduce Training Time
- Increase Productivity

Need Custom Keytops?
Call us at 602 634-7515

Hooleon CORPORATION
P. O. Box 201, Dept. BY,
Cornville, AZ 86325

KEYTOPS—Kits to support most software, including:

___ PC to 5251 \$21.95	___ DisplayWrite 3 \$21.95
___ PC to 5520 \$29.95	___ WordPerfect 4.1 \$29.95

KEY EXPANDERS Touchdown™ key expanders enlarge small, critical keys (Return, Shift, Backspace, etc.) on the IBM PC and look-alikes to full-size, AT-style keys. Full kit has 12 separate expanders. Mini-Kit: Enter/Ret, both shifts, backspace. All kits support LED where needed. Must specify keyboard.

___ FULL KIT \$21.95
___ MINI KIT \$10.95

Black Gray

Language conversions available! Send me FREE INFORMATION

Spec: _____
Name: _____
Addr: _____
City, St., Zip: _____

VISA
Visa or MC orders: 602 634-7515 Same Day Shipment • U.S. Postage Paid

Inquiry 145 for End-Users.
Inquiry 146 for DEALERS ONLY.

\$595
Suggested Retail
Price

Creating With
Pictures
Just Got Easier!

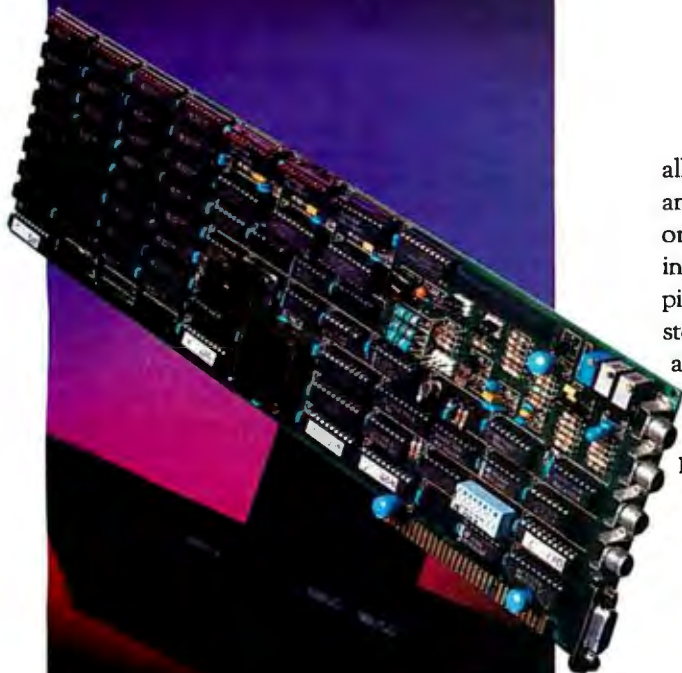

Now Available Professional Image Board

The new Professional Image Board is a PC board which allows an ordinary home video camera (color or black-and-white) to be plugged into an IBM personal computer or IBM compatible. Now, live, fast action scenes can be instantly captured in full color and frozen. The frozen pictures can be computer enhanced feature by feature and stored on a floppy or hard disk. The frozen pictures can also be transmitted to any remote computer in the world via modem. The Professional Image Board also allows you to perform cut and paste operations with most popular software.



Unretouched frozen video image in full color. Captured with ATronics' Professional Image Board.

SPECIFICATIONS

- Resolution 512 x 256 capable of 32K different colors
- Adding text on the captured picture
- Mixing external image with internal image in live mode
- Adapter available for European standard TV
- Works with IBM PC/XT/AT or compatible
- Capture one picture in 1/60 second from standard NTSC signal source (Regular video camera, VCR, etc., or RGB camera)
- Shows picture on analog monitor or TV

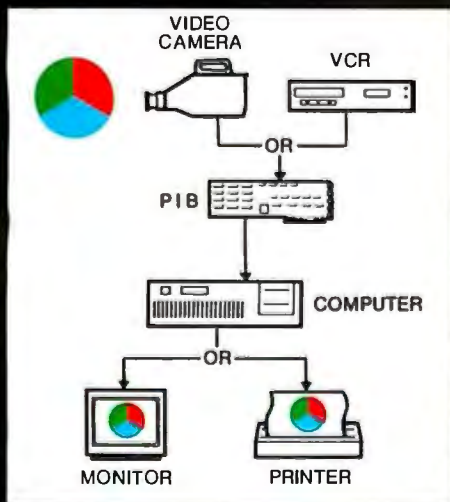

See us at



COMDEX/Spring '87

**BOOTH #3822-
WEST HALL**



**ATronics
International Inc.**

We Deliver Advanced Technology

1830 McCandless Dr. Milpitas CA 95035 USA
(408) 942-3344 TLX: 510-600-6093 FAX: (408) 942-1674

For technical support in Southern California contact:
CNT MARKETING 16580 Harbor Blvd. Ste. J Fountain Valley, CA 92780
(714) 839-3724

PMI INTRODUCES

PERFORMANCE PERIPHERALS

FAST286[®]



80286 COPROCESSOR

ONLY \$295

10 DAY FREE TRIAL

**CONVERT YOUR PC-XT TO PC-AT
POWER AND PERFORMANCE
WITH 80286 COPROCESSING**

- 8MHz Operation
- BUS Independent Operation
- Switch Selectable Mode Between 8088 & 80286
- 8KB of Zero-Wait-State Memory
- Compatible with 8MHz Motherboards
- One Year Warranty

LOTUS EMS COMPATIBLE

FASTCARD[®] with 2 MBYTES



10 DAY FREE TRIAL

ONLY \$295

**THE ONLY EXPANDED MEMORY CARD
WHICH CAN SAVE
A DAY EACH WEEK.**

A major independent testing laboratory benchmarked a PC-XT equipped with FASTCARD and demonstrated a tenfold improvement over a PC-AT on typical disk I/O operations.

- 8 MHz operation
- 2MB of Factory Installed & Tested DRAMS
- Split Memory Fills to 640K, Provides Expanded Memory Over 640K.
- Disk Caching & Print Buffering Software
- Serial, Parallel & Game Ports
- Clock Calendar
- One Year Warranty
- Custom Password Security

LOTUS EMS COMPATIBLE

**BUY BOTH AND SAVE
ORDER FAST286 WITH FASTCARD
FOR ONLY \$495!**

DEALER INQUIRIES WELCOME

FOR ADDITIONAL INFORMATION CONTACT:

PMI PERIPHERAL MARKETING, INC.
7825 E. EVANS RD., BLDG. 500, SCOTTSDALE, AZ 85260
(602) 483-7983

Do I have any complaints about the book? Not really. There's plenty in here that I don't care about, but that's a reflection of how I use the Mac; others may find those sections invaluable.

new Mac owners: a glossary of Mac terms; where to find good information and cheap software; and a list of products and companies.

The book itself—with a copyright date of 1987—is about as up to date as a Mac book can be. For example, it contains a lengthy description of Word 3.0, based on the beta prereleases. The first print run of 500 copies was brought to the MacWorld Exposition and sold out on the first day; the copy I received two weeks later was from the second press run. And the publishers are offering two free upgrades (40-page booklets) to registered owners. There are even spaces inside the front and back covers onto which you paste the update booklets.

Do I have any complaints about the book? Not really. There's plenty of stuff in here that I don't really care about, but that's mostly a reflection of how I use the Mac; I'm sure that other people would find those same sections invaluable. The stuff I do care about is easily worth the price of the book; if I hadn't received a review copy, I would have cheerfully paid money to get it.

I realize I just told you to go out and buy Green's book. Well, buy this one, too; especially if you've just bought a Mac; or even if (like me) you bought one three years ago. If you own a Mac, you should own this book. Trust me, it's worth it.

Product of the Month: Micro Charts

Years ago, while writing a game for the Apple II, I discovered a nifty aid for my 6502 programming: the 6502 Micro Chart, from Micro Logic Corporation in Hackensack, New Jersey. It was an 8½- by 11-inch plastic sheet crammed front and back with 6502 information, including complete instruction set listings, pin-out, memory map, condition code results, unsigned comparisons, and other nice tidbits. In short, it had all the information that you buy 6502 programming texts for but had it all on one handy, nearly indestructible sheet.

Unfortunately, when I left the firm I was working for, I had to leave the sheet behind. And I could never find a place that sold that chart, until I happened to see an ad from Micro Logic, selling the sheets directly. I called them up and talked with James Lewis, the company president. Jim was kind enough to send me a sampling of the 15 different charts his company produces.

Several charts deal with microprocessors: 8048, 6502, 8088/8085, Z80, 8086/8088, and 68000. In almost every case, there is an op-code-to-instruction conversion chart; an alphabetical listing of instructions; a register diagram; a chip pin-out diagram; information on flags; a description of addressing modes; and miscellaneous items, like an ASCII table and a hexadecimal-to-decimal conversion table. The list of items and layouts vary from chip to chip, due to variations in the microprocessors and possibly in the authorship of the cards. Of all the cards, my favorite is the 6502, though that may just be for sentimental purposes. The 68000 chart is the newest; it is also very text-oriented—having few charts, diagrams, or tables—cramping a lot of information into a limited space. I would have preferred to have seen a two-chart set that was easier to use and decode.

continued

Buy the leading \$10,000 desktop slidemaker and get \$4,005 in change!



That's right! PhotoMetric 200PC™, the industry price/performance leader, costs only \$5995. PhotoMetric's proprietary technology gives you more for your money:

- 2000 X 2000 boardroom-quality high resolution slides
- Widest color range — 1000 vivid simultaneous colors for 3-D and other special effects
- On-screen preview to insure perfect slides the first time
- Supported by over 30 PC graphics packages for drawing, charting, mapping, etc....

But don't just take our word for it. PC World says, *"For compatibility with the broadest range of graphics software, for a preview option that comes closest to the final product than any other film recorder, and for professional-quality slides, PhotoMetric 200 is a great buy."*

Why not make your next slide presentation your best with the price/performance leader, PhotoMetric 200.

Find out about it. Call 1-800-556-1234, Ext. 533. In California, call 1-800-441-2345, ext. 533.

General Parametrics Corporation
the makers of VIDEOSHOW™

PhotoMetric is a trademark of General Parametrics Corporation.

SWITCHING POWER SUPPLY

①For PC-AT 220W



③For PC-XT 135W, 155W



②For BABY AT 200W

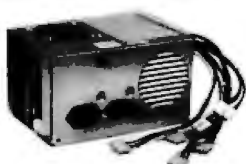

④For TV GAME a.+5V/7A, +12V/1A, -5V/1A
b.+5V/10A, +12V/1A, -5V/1A



CHUNG YU ELECTRONICS CO., LTD.
P.O. BOX 30-535 TAIPEI, TAIWAN, R.O.C.
FAX, 002-886-02-3971968 TLX, 24451 CYELEC
TEL, 002-886-02-3918100, 3414596

There are other programming charts as well. Two deal with BASIC; one is a general introduction, while the other is a detailed command listing for IBM and GW BASIC. The C reference card is an excellent single-card reference for the language and includes lists of commonly used functions and things to remember when programming in C.

The Algorithms card lists a number of handy routines (written in BASIC), including sorting, searching, and a nifty integer square root routine (which I discovered on this same chart years ago and used in the aforementioned game). There's even a UNIX Shell reference card, based on the Bourne shell of UNIX System V (Release 2). Heaven knows I am not a great UNIX fan; this card should make my ever-increasing forays into that world easier to bear.

There are four more Micro Charts, none of which I've actually seen (but which are described on the brochure that accompanied the other cards). One covers 7400-series TTL pin-outs; another describes electronic components (e.g., diodes and transistors). Yet another, which looks intriguing, tells "how to generalize from a small sample," something we all do anyway and could probably use some help with. The last is a reference card for WordStar.

The Micro Charts don't replace a good book on the corresponding subject, but they're a lot easier to use. They're sturdy, too, and completely resistant to soft drinks, coffee, ketchup, grease, and other substances that programmers spill, drip, or smear while nourishing themselves late at night. Best of all, the charts are only \$5.95 each. A minimum order from Micro Logic is two charts, but shipping and postage is only \$1, regardless of the number of charts ordered. They even have a 14-day money-back guarantee.

The Hackers Corner

In the November 1984 BYTE, I wrote an article called "A Go Board for the Macintosh." Go, for those of you unfamiliar with it, is a simple yet deep game that originated in China three or four millennia ago and remains extremely popular in the Far East. Two players alternate placing black and white stones on the intersections of a grid. Players can capture groups of enemy stones—an army—by covering all adjacent empty intersections with their own stones. When the game is over, the player who has the highest total of controlled territory and captured enemy stones wins.

My program, written in MacFORTH, was just what it professed to be: a go board allowing two players to carry on a game. I voiced ambitions of allowing the computer to play against humans, but I never pursued that to any degree. However, I still get letters from people interested in a go-playing program for the Macintosh.

As fate would have it, I ran into such a program right here at Brigham Young University. Jim Logan, who works for the electrical engineering department, has written a go-playing program for the Mac. It's pretty good for a computer program, having placed fifth in the International Computer Go Tournament in Taiwan last November. And, currently at least, the price is right. It's shareware.

Space won't permit an exhaustive description here, but it has an excellent user interface and many, many options, including board size, search depth and width, move-numbering, infinite backtracking, analysis of the board and of individual armies while the game is in progress, and twiddling with the factors used to determine the computer's next move. It plays the best game of go I've seen a computer play so far. I'm rusty enough that it keeps me on my toes; for a novice, it should be a challenging program.

You can get a copy from Jim by sending him a check for \$15 at

continued

AMPRO LITTLE BOARD/PC™
Miniature IBM® PC/XT® Compatible Single Board Computer

SCSI Bus Interface
(HardDisk, etc.)

Mounts on a 5.25" Drive
(5.75" x 8.0" x 1.0")

768k RAM

Floppy Disk Controller

Math Co-Processor

Up to 128k EPROM

Parallel
Printer Port

4 Mode Video
Controller Option
(Monochrome,
Hercules, CGA,
High Resolution
CGA)

2 RS232C Serial
Ports

NEC V40 CPU

Speaker,
Keyboard Ports

Drives, enclosures and
power supplies available

CMOS Surface-
Mount ASIC
Design Requires
Only 3 Watts

PC Bus Connector

Basic configuration includes 256k SIMM RAM, BIOS, floppy controller and 2 serial ports (less SCSI chip) . . . \$495. Fully populated with SCSI, 768k RAM . . . \$CALL.

Little Board/PC Development Kit - Fully populated board, floppy drive, power supply and 2 slot enclosure with cables . . . \$CALL.

For further information and technical assistance on our complete line of microcomputers and accessories, please contact:

DISKS PLUS, INC.
356 Lexington Drive
Buffalo Grove, IL 60089-2312
Telex: 650 249 2139 MCI UW
(312) 537-7888



DISKS PLUS
Microcomputers and Accessories

Send

free catalog

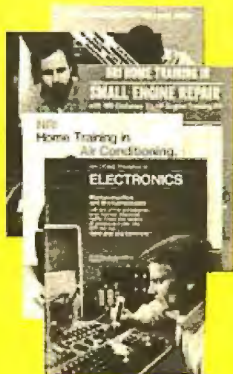

<hr/> <hr/> <hr/> <hr/>

<hr/> <hr/> <hr/> <hr/>



NO POSTAGE
NECESSARY
IF MAILED
IN THE
UNITED STATES

BUSINESS REPLY MAIL

FIRST CLASS MAIL PERMIT NO. 10008 WASHINGTON, D.C.

POSTAGE WILL BE PAID BY ADDRESSEE

NRI Schools

McGraw Hill Continuing
Education Center
3939 Wisconsin Avenue
Washington, D.C. 20077-9265



Train for the Fastest Growing Job Skill in America

Only NRI teaches you to service all computers as you build your own fully IBM-compatible microcomputer

NEW!
Train with the newest Sanyo 880 Series Computer — it's fully IBM-compatible and runs almost twice as fast as the IBM PC!

With computers firmly established in offices—and more and more new applications being developed for every facet of business—the demand for trained computer service technicians surges forward. The Department of Labor estimates that computer service jobs will actually *double* in the next ten years—a faster growth rate than for any other occupation.

Total systems training

No computer stands alone... it's part of a total system. And if you want to learn to service and repair computers, you have to understand computer *systems*. Only NRI includes a powerful computer system as part of your training, centered around the new, fully IBM-compatible Sanyo 880 Series computer.

As part of your training, you'll build this highly rated, 16-bit IBM-compatible computer system. You'll assemble Sanyo's "intelligent" keyboard, install the power supply and disk drive and interface the high-resolution monitor. The 880 Computer has two operating speeds: Standard IBM speed of 4.77 MHz and a remarkable turbo speed of 8 MHz. It's confidence-building, real-world experience that includes training in programming, circuit design and peripheral maintenance.

No experience necessary—NRI builds it in

Even if you've never had any previous training in electronics, you can succeed with NRI training. You'll start with the basics, then rapidly build on them to master such concepts as digital logic, microprocessor design, and computer memory. You'll build and test advanced electronic circuits using the exclusive NRI Discovery Lab®, professional digital multimeter, and logic probe. Like your computer, they're all yours to keep as part of your training. You even get some



Your NRI total systems training includes all of this:
NRI Discovery Lab® to design and modify circuits
• Four-function digital multimeter with walk-you-through instruction on audio tape • Digital logic probe for visual examination of computer circuits
• Sanyo 880 Series Computer with "intelligent" keyboard and 360K double-density, double-sided disk drive • High resolution monochrome monitor • 8K ROM, 256K RAM • Bundled software including GW BASIC, MS DOS, WordStar, CalcStar • Reference manuals, schematics and bite-sized lessons.

of the most popular software, including WordStar, CalcStar, GW Basic and MS DOS.

Send for 100-page free catalog

Send the post-paid reply card today for NRI's 100-page, full-color catalog, with all the facts about at-home computer training. Read detailed descriptions of each lesson, each experiment you perform. See each piece of hands-on equipment you'll work with and keep. And check out NRI training in other high-tech fields such as Robotics, Data Communications, TV/Audio/Video Servicing, and more.

If the card has been used, write to NRI Schools, 3939 Wisconsin Ave., N.W., Washington, D.C. 20016.



NRI is the only technical school that trains you as you assemble a top-brand microcomputer. After building your own logic probe, you'll assemble the "intelligent" keyboard...



... then install the computer power supply, checking all the circuits and connections with NRI's Digital Multimeter. From there, you'll move on to install the disk drive and monitor.

NRI SCHOOLS

McGraw-Hill Continuing Education Center
3939 Wisconsin Avenue, NW
Washington, DC 20016

We'll Give You Tomorrow.



IBM is a Registered Trademark of International Business Machine Corporation.

SOFTWARE SENTINEL™

MUCH MORE THAN JUST PROTECTION

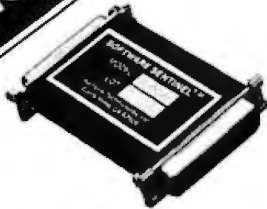

Stop unauthorized use of software...and keep your customers happy at the same time. The no-interference hardware keys from the industry's leading supplier put money in your pocket and save you from angry customer complaints. Our product line includes devices for either parallel or serial port. The latest addition allows you to cover multiple programs with one device and/or customize as needed. Call for new low prices.

SOFTWARE DEVELOPER BENEFITS

- Prohibits unauthorized use of software
- No need for copy protection
- Algorithm technique (never a fixed response)
- Virtually unbreakable
- Higher level language interfaces included
- 100 times faster (1ms) than fixed response devices
- Minimal implementation effort
- Runs under DOS and Xenix, on IBM PC, AT, XT & compatibles

SOFTWARE USER BENEFITS

- Unlimited backup copies
- No floppy required with hard disk
- Pocketsize
- Transparent
- Transportable

EVALUATION KIT AVAILABLE



Telex 386078

17971 SKYPARK CIRCLE SUITE E, IRVINE, CA 92714

(714)261-0228

A MESSAGE TO OUR SUBSCRIBERS

FROM TIME TO TIME WE MAKE THE BYTE subscriber list available to other companies who wish to send our subscribers material about their products. We take great care to screen these companies, choosing only those who are reputable, and whose products, services, or information we feel would be of interest to you. Direct mail is an efficient medium for presenting the latest personal computer goods and services to our subscribers.

Many BYTE subscribers appreciate this controlled use of our mailing list, and look forward to finding information of interest to them in the mail. Used are our subscribers' names and addresses only (no other information we may have is ever given).

While we believe the distribution of this information is of benefit to our subscribers, we firmly respect the wishes of any subscriber who does not want to receive such promotional literature. Should you wish to restrict the use of your name, simply send your request to the following address.

BYTE MAGAZINE

ATTN: SUBSCRIBER SERVICE
P.O. Box 6821
PISCATAWAY, NJ 08854



ACCORDING TO WEBSTER

Items Discussed

Full Page Display \$1995
Radius Inc.
1050 East Duane Ave., Suite F
Sunnyvale, CA 94086
(408) 732-1010

MacC Jr. \$79.95
Consulair Corporation
140 Campo Dr.
Portola Valley, CA 94025
(415) 851-3272

MegaScreen II \$2495-\$2995
MicroGraphic Images
20954 Osborne St.
Canoga Park, CA 91304
(818) 407-0571

Micro Charts \$5.95
Micro Logic Corporation
P.O. Box 174
Hackensack, NJ 07602
(201) 342-6518

Prodigy Prime \$1995 and up
Levco Inc.
6160 Lusk Blvd., Suite C-203
San Diego, CA 92121
(619) 457-2011

The Big Picture \$1995
E-Machines
7945 Southwest Mohawk St.
Tualatin, OR 97062
(503) 692-6656

TurboMax \$1299 and up
MacMemory Inc.
2480 North First St.
San Jose, CA 95131
(408) 922-0140

403 Clyde Building, Brigham Young University, Provo, UT 84602, (801) 378-3617. You can also contact him at loganj-@byuvax.bitnet. He'll send you a disk with his current beta version. He's also selling the source code to an earlier (less intelligent) version. It's on disk and written in Megamax C; you can get that for \$50. Oh, and Jim is looking for a dan-level player who's interested in working with him to make the game play better. You see, there's another international computer go tournament coming up soon.

In the Queue

I'm finishing this column up on a different computer than the one I started with. The column began on my old Compaq portable; it's being finished on an Access 386 system with a 16-MHz 80386 microprocessor, a 30-megabyte hard disk, an enhanced graphics adapter, and (only) 640K bytes of RAM. I could get used to something like this. A full report on this next month, along with a look at some of the MS-DOS software that I haven't been able (or willing) to wring out on my Compaq. Until then, see you on the bit stream. ■

Inquiry 357 for End-Users.
Inquiry 358 for DEALERS ONLY. —

Unlock your desktop with Publisher's Paintbrush.™

See us at Booth 1228, 1229, 1230
COMDEX/Spring '87
 June 1-4, 1987
 Georgia World Congress Center
 Atlanta, GA

Finally, a paint package designed for desktop publishing! When you create or scan a 300 dpi page, you'll get a 64-screen computer image. That's why Publisher's Paintbrush lets you zoom out and work on the big picture. So you get ultra-sharp resolution without ultra-tedious labor.

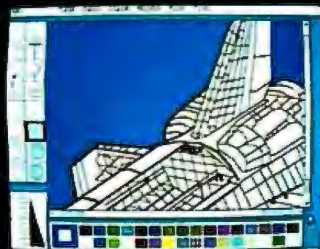

One screen of a 64-screen image.



Shrink down to a manageable size.



Next, cut-and-paste . . .



A few edits later . . . VOILA!

New typography frontiers: continuously adjustable point sizes, text slope, line and character spacing, extended and condensed type, and letter slant.



Easy-to-use menus.



Slant and angle text 1° - 359°.



4- to 250-point type.



Adjustable everything!

Publisher's Paintbrush adapts to most scanners with absolute simplicity. Scan in existing art, logos and diagrams to save many hours of work!

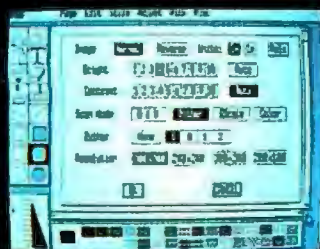

Full use of scanner features.

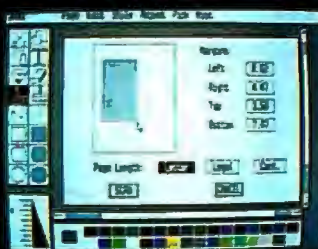

Scan all or part of a page.



Combine art and type . . .



. . . from several sources!

Publisher's Paintbrush is a quantum leap in power beyond our top-selling PC Paintbrush®. In fact, it's the dawn of a new era for desktop publishing. With it, you can produce pictures of super-high resolution (many times sharper than your screen!) and marry them into text pages. With it, you can take full advantage of desktop publishing packages, laser printers and image scanners. Without it, you're stuck with ragged edges and tedious multi-screen editing.

Publisher's Paintbrush supports major-brand image scanners and hundreds of printers and video display boards. And most desktop publishing packages have built-in links to Publisher's Paintbrush.

Say goodbye to the old boundaries. Say "Show me" to your ZSOFT dealer. Or call our corporate offices for more information.

Publisher's Paintbrush is a trademark and PC Paintbrush is a registered trademark of ZSoft Corporation. Dover Clip-Art Series is a registered trademark of Dover Publications, Inc.



1950 Spectrum Circle, Suite A-495, Marietta, Georgia 30067, (404) 980-1950

BOOKMARK™

NEVER LOSE WORK IN PROGRESS AGAIN!



Never Lose Work in Progress Again!

Automatically marks your place so you can resume where you left off.

- BOOKMARK is a memory-resident utility that automatically backs up work in progress to the hard disk at user-definable intervals.
- Work in progress can be resumed within seconds after system crash, power failure, accidental reset or power down.
- Use it like a BOOKMARK for your computer to bring you back where you left off so you can stop wasting time navigating through menus . . . or teaching novices.
- Easy to use. You choose how often work is saved, by number of keystrokes or length of time.
- Operates concurrently and transparently with most software.
- Costly battery backup systems are no longer needed when work in progress is already saved to the point of the previous BOOKMARK placement.
- Password protection is provided as an option to prevent unwanted viewing of resumed work by others.
- Exiting programs can be as simple as placing a BOOKMARK and powering down, reloading as simple as powering up & pressing "y" to resume.

Call or write for the name of the dealer or distributor nearest you.



INTELLISOFT™



INTERNATIONAL

Call Toll Free (800) 544-MARK • In California Call Toll Free (800) 543-MARK
70 Digital Drive • P.O. Box 5055 • Novato, California 94948 • (415) 883-1188

Requirements:

IBM PC/XT/AT or 100% Compatible • 256k to 640k • IBM DOS 2.1 or Higher. 1 Floppy Drive • Hard Disk Drive (10 Megabytes Minimum) • Video Display Adapter IBM (Monochrome, Color, Enhanced Color), Hercules, AST (BOOKMARK occupies an equivalent space on hard disk as in system RAM plus video RAM)

BOOKMARK™ is a trademark of INTELLISOFT International. Copyright © 1986 by INTELLISOFT International. All rights reserved. Patent Pending. IBM PC/XT/AT are registered trademarks of International Business Machines Corporation. Hercules is a trademark of Hercules Computer Technology. AST is registered trademark of AST Research, Inc.



Mostly Mac

Ezra Shapiro

Two laser tools, a phone dialer, an odd spreadsheet, and some grumblings

A year ago I had to beg for Macintosh software; nothing was happening, and I was overloaded with MS-DOS products. Then Apple introduced the Mac Plus, and the MS-DOS world began to freeze waiting for 386 machines, 286 operating systems, and rumored proprietary machines from IBM. The software scene suddenly reversed itself, and today I'm finding a flurry of activity in Macland and the drums in the PC arena. Life is like that, I guess.

Serious Art

A sophisticated art creation program for professional artists and designers who use the Macintosh, **Illustrator** (Adobe, \$495) is far too powerful (and expensive) to be lumped in with the pack of drawing and painting programs that characterize the Mac art category. Let me emphasize the word "professional"—this product is not a toy for casual doodlers. Unfortunately, it is easier to demonstrate the program than it is to describe it, which often turns out to be the case with graphics tools.

In the simplest analysis, you create a line drawing that is stored as PostScript code rather than as a bit map of dots. The lines that make up the drawing can have thickness, or they can merely mark off regions that can be filled with gray tints. Because you're dealing with PostScript, which is device-independent, the output on laser printers or typesetting devices is always crisp, smooth, and clean.

Illustrator gives you two planes of visual information. The top layer is your work area, on which you construct your image. The background layer is a template; you can use it to store a picture from another Mac graphics program or from an optical scanner. Thus, you can create a PostScript document that is essentially a tracing of a bit-map picture. But because PostScript works by defining lines as endpoints plus the straight lines or the Bézier curves that connect them,

working with Illustrator is not as simple as drawing with MacPaint. You place endpoints on your screen, in connect-the-dots style, and Illustrator builds the curves between the endpoints. If you've got that, hang on, because the explanation gets trickier.

Bézier curves are determined by the starting point and two control points that lie on an imaginary line tangent to the curve. With Illustrator, you draw by placing the starting point, keeping the mouse button depressed, then moving the cursor along that tangent line to the control point in the direction the curve is heading. The angle at which the curve leaves the starting point is determined by the tangent line; the size of the curve is determined by the distance of the control points from the starting point. Since most smooth curves have control points equidistant from the starting point, Illustrator places the second control point for you; you can fine-tune the curve by moving either of the two control points.

Drawing with Illustrator is thus a choppy process of making straight lines that define curves. At first this is odd and downright annoying because you feel you're working sidesaddle, but after some practice you get the hang of it, and it becomes second nature. Believe me, it's not as difficult as it sounds.

The more complex your drawing, the more points you have to set, so a detailed illustration entails a lot of work. The art produced by Illustrator is precise and stylized. Illustrator seems best for projects that should look polished and designed rather than loose and spontaneous—corporate logos, posters, technical drawings, borders, art deco images, and so on. You wouldn't want to use it to produce a simulated crayon sketch; I shudder

to think of the amount of labor necessary to create an image with all of the irregularities of freehand art.

You can also use Illustrator to perform one-shot modifications to PostScript typefaces. For example, you could create an elongated gray shadow for a display headline. Illustrator and PostScript together understand how to download a font to the output device and then play with the PostScript outline that defines the letters, but that's beyond my scope here.

Files can be stored in any of three formats. Encapsulated PostScript provides both the code and a bit-map image that can be used by a program (a page layout package, say) that understands the format. Although Illustrator is a Macintosh product, it can generate Encapsulated PostScript in both Macintosh and MS-DOS forms. Or you can save a file as pure ASCII PostScript, which you can then edit, import into an application with a PostScript interface, dump directly to a laser printer, or even send out over an electronic mail service without having to worry about binary file hassles.

Documentation is well written and helpful. Adobe has included a demonstration of the program on videocassette as part of the package, which is a brilliant idea.

This is a very important program, but even a simple drawing can consume a lot of time. I wouldn't suggest Illustrator to anyone who doesn't fully understand its ramifications and isn't willing to dedicate many hours to the product.

Serious Type

While on the subject of Bézier curves, it's time to make a brief nod in the direction

continued

Ezra Shapiro is a consulting editor for BYTE. Contact him at P.O. Box 170040, San Francisco, CA 94117. Because of the volume of mail he receives, Ezra, regretfully, cannot respond to each inquiry.

of **Fontographer** (Altsys, \$395), a typeface design program that works much like Illustrator. There are some differences, though. Fontographer places both control points for you, which you can adjust later, so you don't have to draw those choppy lines. You are, however, still playing connect the dots. Fontographer also differentiates between straight lines and curves (Illustrator defines a straight line as a flat curve, with both control points located on top of the starting point), so you have an additional tool for making straight lines. Fontographer gen-

erates downloadable fonts rather than ASCII PostScript.

The two programs complement each other nicely; reading the documentation for both products gave me a much clearer understanding of PostScript and Bézier curves than I would have had if I had read only one manual. The interface is similar enough so you can move from one program to the other with little disorientation. Both work well with scanned images as templates.

It's a lot of work to create a new alphabet. Jim Von Ehr of Altsys tells me that

many of his customers use the product to create typefaces that contain only a handful of letters, for corporate identification and logos. But some type designers are working with the product, and designing a whole new typeface that looks really good is incredibly rewarding.

Along with Fontographer, you get a special copy of FONTastic, the company's Macintosh font editor, for creating Mac bit-map fonts. Don't assume you can move from the laser font to the bit-map font with no real effort; it takes almost as much work to develop a good bit-map font as it does to produce the downloadable version. You'll spend quite a while tweaking.

I love this program, but I also love type. Whether you need the program for professional uses, or you want to make typeface design a hobby, expect to block out a big chunk of your life for playing with Fontographer. I think it's worth it, and the program is outstanding, but it's not for everyone.

Hot Tip

I don't really appreciate phone dialers—my fingers do the job just fine, thank you—but **Hotline** (General Information, \$39.95) is the Cadillac of the category. It's not the dialing that attracts me; it's the built-in phone directory. Hotline comes with a 2000-entry subset of the company's *National Directory of Addresses and Telephone Numbers*, a mammoth compendium of every useful number you could ever want—some 150,000 of them. While 2000 numbers doesn't seem like a lot (there are several hundred per page in the book your phone company gives you), these numbers are *prime*. (Sorry, I couldn't resist.) Major corporations, government agencies, freight companies, airlines, hotels, publications, computer hardware and software firms . . . the list goes on. Even if you don't use the program to actually dial your telephone, I guarantee you'll use the database within the first day you have the package, if not within the first hour.

As for the program, it's an MS-DOS terminate-and-stay-resident program that allows fast searching of both the *National Directory* and a personal directory of 65,000 of your closest friends. It also keeps track of local time for each of the numbers, and, if you like, Hotline will generate an ASCII log of the calls you make, showing number, company, location, and time. You can cut and paste from the log into your major application. You can look up the area code or country code and local time for more than 3000 cities around the world. The databases can be dumped in standard delimited for-

continued

"If you're an experienced computer user on a tight budget, the QIC 1800 is by far the best value...considering the system's bargain-basement price, I was more than a little surprised, to find the operation manual to be by far the best of the group."

Stan Miastkowski, BYTE, March 1987

(10 MHz) **\$799** Basic Unit



QIC-286-10A Made in USA

With Option \$1125

- Fully IBM AT™ Compatible AMI BIOS
- 80286 CPU, 6/8 MHz
- Six 16-bit and two 8-bit expansion slots
- Clock/Calendar with AA battery backup
- 195 W Power supply
- Complete 200 page easy to follow manual
- FCC Class 'B' approved
- One year warranty



Option: 1.2MB or 360K Floppy Disk Drive
Combined Floppy/Hard Disk controller

ENHANCEMENT PRODUCTS FOR AT

Hard Disk	• Seagate 20MB Half-Height Hard Disk (w/controller)	\$359
	• Seagate 30MB Full-Height Hard Disk—High speed	\$628
	• Seagate 40MB Half-Height Hard disk	\$699
Graphic Card	• Enhanced Graphic Card with 256K RAM	\$215
	• QIC Monographics card (Hercules Comp.)	\$95
Tape Backup	• 60MB Cartridge Tape Back Up (Internal)	\$794
	• 20MB Cassette Tape Back Up (Internal)	\$599
Modem	• Everex 300/1200 Half-Size Modem Card	\$128
	• Everex 1200/2400, Half-Size Modem Card	\$239
Multi-function Card	• AT Multi-function Card 0K (to 1.5MB)	\$179
	• QIC Ram 3000, 0K (expandable to 3MB)	\$155
	• QIC Turbo XT w/256K, 1 Floppy Drive	\$469



QIC RESEARCH
INCORPORATED
753 Ames Avenue
Milpitas, CA 95035

(408) 942-8086 (Sales)

Dealer/Corporate Inquiries Welcome. University P.O.'s are Welcome
FAX No. 408-263-1447 (Tech Support) (408) 942-0856

"WINNING COLOR...AND IT CAME OUT OF A SHARP COPIER."

This is an unretouched copy made by Sharp's new full-color copier.

LeRoy Neiman



FREE! A 20" x 30" poster of LeRoy Neiman's "Winning Color" when you visit an authorized Sharp dealer for a full-color copier demonstration.

Sharp's new full-color business copier, with its advanced technology, makes all others seem obsolete.

It captures all the vibrance of the LeRoy Neiman original. That's winning color—color that's alive.

And it can reproduce your business documents with the same astonishing results. From layouts to computer graphics.

It also enlarges, reduces, copies slides and makes transparencies. All in winning full-color at a surprisingly low price.

See an authorized Sharp dealer for a demonstration. You'll wonder how you ever got along without it.

For more information, call 1-800-BE-SHARP, or mail coupon.



SHARP
FROM SHARP MINDS
COME SHARP PRODUCTS™

BY
Mr. James MacKenzie
General Manager, Copier Division
Sharp Electronics Corp.
Sharp Plaza, Mahwah, N.J. 07430
Please send me more information on Sharp's full-color copier.

NAME _____
TITLE _____ PHONE _____
COMPANY _____
ADDRESS _____
CITY _____ STATE _____ ZIP _____

STOP SOFTWARE PIRACY WITHOUT COPY PROTECTION

Welcome to the world of Copi-Control with Smarti Arti, the first logical strategy in the battle against software copyright infringement. Smarti Arti doesn't prevent the legal creation of archival backups, just the illegal *use* of those backups.

Smarti Arti[™]

Intelligent Software Security



- * Completely invisible and inoffensive to licensed users.
- * Handles hard-disk crashes with ease. No install programs needed.
- * Uses artificial intelligence to detect and deter efforts to steal software.
- * Stops backups from executing unless they're legally authorized to do so.
- * Returns valuable marketing information about the user's computer system.
- * Uses NO key disks, hidden files or other annoying copy-protection games.
- * Allows exact duplicates of original program disks to be made with DOS commands.

If you *hate* copy protection,
You'll *love* Smarti Arti!

For IBM PCs

Secure hard-drive data with ^{For IBM PCs}

The Secret Guard[™] \$79.95

The Secret Guard secures sensitive data on your hard disk by making your computer temporarily "forget" that the hard drive exists! Great for software developers who store classified data on a hard disk. Parents can let their children learn how to use the computer without fear that they'll corrupt the hard drive. No special hardware needed. Keep prying eyes away from your sensitive data with the Secret Guard.

For IBM PCs

Save Money with the Loan Ranger[™]

METHOD	TYPE YEAR	PAYOFF	PMT PERIOD	INT PERIOD	EVALUATION
U.S. RULES	360 DAY	FULL TERM	MONTHLY	MONTHLY	
Annual Interest Rate % :		18.00			
Number of Payments :		48			
Loan Amount :		15000.00			
Period Payment :		431.10			
Last Period Payment :					
Satisfaction Guaranteed !!!					
MAIN MENU	EDIT DATA	DATES	METHOD	PMT PERIOD	
INT PERIOD	TYPE YEAR	PAYOFF	PROCESS DATA	RESTART	EXIT

ALLOWS two loans to be engineered simultaneously.
ACCOMMODATES up to 500 irregular payments.
TEACHES how to avoid banking loopholes and pitfalls.
COMPUTES complex loans that use non-standard structures.

INCLUDES a complete leasing program. Two programs for the price of one!
AUTOMATICALLY evaluates loans from "excellent" to "terrible."
OFFERS defaults and help at any time. Menu-driven. Complex, yet easy to use!

still only
\$99.95!

For IBM PCs

PRIDE SOFTWARE DEVELOPMENT CORPORATION

3575 NW 31st Ave., Oakland Park, FL 33309 / 1-800-635-6366 Dial Tone #360

Pride Software Development

Light Years Ahead

Fla. residents add 5% sales tax. All add \$3 handling. COD add \$2.

IBM is a trademark of International Business Machines Inc.

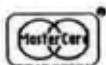

Instead of displaying a grid of cells, Trapeze gives you a blank screen: you create blocks of data where you want them.

mat for editing with a word processor or for incorporation into a spreadsheet or database. You can recompile the directories, so you can edit out the numbers you don't need or add new ones. Oh yes, the program will also dial your modem, whether it's Hayes-compatible or not (if not, you have to feed Hotline the modem's command set). You can assign prefixes and suffixes for long-distance services or private branch exchange systems, differentiate between local and toll calls (prefixed with a 1-) within your area code, turn your keypad into a manual phone dialer, and set up 30 numbers for speed-dialing with your function keys.

For Macintosh users, the 2000-entry subset is being distributed by Living Videotext with its newest version of More. You don't get all the nifty logging and keyboard functions, but More does have point-and-dial capability. I prefer the database as a More outline; it's organized into files grouped by category, rather than the full alphabetical list Hotline uses, and More's expansion/contraction by simple mouse clicks is a convenient way to let your fingers do the walking. I'm thinking of being sneaky and loading the database into Acta so I can pop it up from within other applications. Since I'm not particularly interested in the dialing functions, that should work well for me.

Hotline is inexpensive, slick, and well built. For anyone (like myself) who still scrawls phone numbers on odd scraps of paper, this program might finally be enough incentive to get the numbers into the computer. If I gave out stars, Hotline would get a bunch.

Without a Net

Once you get past the silliness of the user interface, Trapeze (Data Tailor, \$295) is really quite an interesting product for the Macintosh. It's easiest to describe it as an unusual and capable spreadsheet program with powerful output formatting, but that doesn't really cover it. Trapeze is unlike any spreadsheet I've seen.

Rather than presenting you with the familiar grid of cells, Trapeze gives you a blank screen and lets you create blocks of

continued

Inquiry 253 for End-Users.
Inquiry 254 for DEALERS ONLY.

That Was Then And This Is Now.



Introducing WordStar® Professional Release 4.

You remember when we first came out with WordStar. From day one it **became**, as some described it, a classic. Over one and a half million of you snapped it up.

But that was then and this is now.

And now there's a new WordStar. WordStar Professional Release 4 for the IBM PC and compatibles. With the same familiar command sequence and file format you've grown to love. Yet with all the improvements you've been asking for.

You're going to have a field day.

With over 125 new features, it's like a wish list come true.

Imagine, a WordStar Professional with, increased speed, undo, keyboard macros, Word Finder™ Thesaurus, line/box drawing, improved printer support, multi-line headers and footers, and onscreen boldface/underlining.

Catch your breath. We're not done.

There's also 14 function math, sub-directory support, go to page, and an improved spelling correction and Mail-Merge. There's even an optional 40 function key interface. Not to mention over 100 other enhancements.

And it's got people in the know talking.

People like Michael J. Miller of InfoWorld,* who described WordStar Professional Release 4 as "faster than ever" and "good enough to cause a WordStar revival."

There's even more good news. If you already own WordStar or WordStar Professional, \$89 and your present serial number let you update to Release 4. We've even included an order form below. It's our way of introducing a new dedication to our customers. It's our way of saying there's a new MicroPro.

WordStar Professional Release 4.

Let's hear it for new beginnings.

The New
MicroPro.

*February 16, 1987 issue.

ORDER YOUR UPDATE NOW! Complete the information below and, along with your check or money order, mail to: MicroPro, Order Update Department, P.O. Box 7079, San Rafael, CA 94901-0079. Or call us toll free at 800-227-5609 or 800-343-3000 Ext. 655 to order. Allow 3-4 weeks for delivery.

Customer Name _____ Company Name _____

Address _____ Telephone (____) _____

City _____ State _____ Zip _____

Indicate: 5¼ disk format 3½ disk format

WordStar Serial # _____ or include title page of your WordStar Reference Manual.

Release 4 \$89.00

Tax* _____

Shipping/Handling \$5.00 _____

Total _____

*Only states shown require sales tax: CA, GA, IL, MA, NJ, OH, TX, and WA.

data wherever you want them. Each block can contain only one type of item (numbers, formulas, text, imported graphics, or charts).

To build an elementary worksheet—labels on top and left edges, totals on the right and along the bottom, and data cells in the middle—you'd actually have to construct five blocks, one each for the two sets of labels, one each for the totals, and one for the raw data. Blocks can reference each other, but you don't use the traditional row-and-column numbering system; you use names you've given

blocks and constants. So to build your bottom strip of totals, you'd simply enter the formula `sum(blockname, #col)`. This sounds cumbersome if all you want to do is set up a simple table, but if you're looking for fancy reports or self-calculating forms, this works nicely.

You can drop interesting fonts or spiffy graphics all over the place for impressive forms design, and the spreadsheet has one of the longest lists of functions I've ever seen.

I'm tempted to go easy on Trapeze because I really want a program like this to

be part of my day-to-day toolbox and because I think its authors ought to be encouraged to make it a solid piece of software. However, I was not particularly pleased when I worked with it. As long as I did things by the book, I didn't have any problems. But when I intentionally did stupid things, all hell broke loose.

For example, I filled a large block of cells with integers, then (illegally) entered a formula in one cell that summed the block as columns, including itself. That's a classic circular reference, and it should have set off alarms and angry dialog boxes. Once, only once, I got a circular reference error message and blew up the screen display. Another time, I simply got an #NA error constant in a solitary cell; the original grid had vanished. Other times, I got the message but Trapeze proceeded to calculate anyway and collapsed the block to a single row that summed all the valid numbers in the columns I'd entered; I couldn't figure out how to get back to the original grid from that point. The most common response was no message at all, followed by a quick snap down to that single row. Every so often, the display would show a black block, as if a cell were selected, in my starting position, only by then that spot had ceased to be a cell. I honestly tried this lots of times to see if I could get a documentable bug nailed down, but the results were unpredictable. The critical factors seemed to be whether I had linked another block to the first and how many times I'd gone back and forth.

Note that not only was this a finished, shrink-wrapped product, but Data Tailor had even sent me two new program disks that allegedly corrected unspecified bugs. Also note that I don't care if my misadventures were a result of flaws in the software or my unfamiliarity with the product. Programs shouldn't have bugs, and they should also be prepared to deal with idiots at the keyboard.

I'm curious to see if this sort of thing gets fixed and, if so, how the program handles it. If I'm going to trash a worksheet with one rotten formula, I'd at least like a warning and a chance to back out before an automatic recalculation blows away hours of work.

Now, about that interface: Trapeze is a good argument against getting too carried away with the Macintosh icon-and-mouse disease. You can enter a formula by typing in text, which is simple enough, but if you want to take the Macintosh route and do it all with the mouse, here's what you have to do: There's a bar of four cryptic icons in the upper left corner of the screen. To get to the enter formula icon (a box with two parallel lines inside it; an

continued

IMAGINE WHAT YOUR COMPUTER COULD SAY WITH PC DIAL/LOG™



PC DIAL/LOG™ consists of an expansion card, software and a cable that connects a Touch Tone® telephone directly to your computer. When installed the PC Dial/Log™ automatically dials and answers the phone, saves and sends telephone messages and stores and forwards telephone calls.

IT'S SIMPLE, with direct installation and a menu-driven program. These features make PC Dial/Log™ convenient and easy to use.

UNPARALLELED VOICE QUALITY made possible by the Votrax® voice digitization process enables PC Dial/Log™ to deliver the best low-cost voice reproduction.

VOTRAX'S SOFTWARE INTERFACE PROGRAM, THE TODL KIT, created especially for the developer whose application includes PC Dial/Log™, will help save valuable programming time.

- Other Votrax® Products**
- Personal Speech System™,
 - Type-N-Talk™ Stand-Alone Devices
 - IBM, Apple II, Commodore 64 Plug In Board Synthesizers
 - Votrax® Speech Chips

APPLICATIONS including appointment scheduling, telemarketing, marketing surveys, financial updates, inventory status reports, dispatching and order entry are just some of the many ways that PC Dial/Log™ can be used.

WE WELCOME DEALERS AND DISTRIBUTORS to contact Votrax® regarding our complete line of products. Our reputation has been built on quality products and outstanding customer service that are sure to satisfy you.

AN UNBEATABLE PRICE at only \$495*, PC Dial/Log™ is the lowest priced digital board available today. Please contact Votrax® directly for additional information.

* Plus shipping and handling.



VOTRAX/CMC Int'l, Inc.
"Technology That Talks"
 1394 Rankin, Troy, MI 48063
 1-800-521-1350
 In Michigan 313-588-0341
 TWX-8102324140 Votrax-TRMI
 For a voice demonstration call
 313-588-2926

Take the Multi and run.



NEC introduces MultiSpeed™. The world's fastest portable computer. It's designed to make you a runaway success.

MultiSpeed is multi-talented. It's small. Light. And gives you the option of running at a clock speed of either 9.54 or 4.77 MHz.

MultiSpeed can do most anything your desktop PC can. It has the most advanced LCD screen technology. So it's easier to read.

What's more, it's PC compatible and even does windows.

And MultiSpeed is a very smart buy. It comes with a bundle of built-in features that cost a bundle on other portables.

*IBM PC/XT is a registered trademark of International Business Machines Inc.
NEC is a registered trademark of NEC Corporation.

Standard Features	
Clock Speed	9.54/4.77 MHz
Memory	640K bytes
Built-in Software	5 programs
Disk Drives	Dual 720K (3.5")
Screen type	Super-twist LCD
Keybd. Compatibility	IBM PC/XT*
Numeric Keypad	Separate
Weight	11.2 lbs.

In fact, when you discover everything it comes with, you'll be delighted at what it goes for.

So if you're a person who's going places, try the portable that helps you get there ahead of everyone else.

You'll find the new MultiSpeed portable at CompuMat, ComputerLand, Connecting Point and Micro Age. For literature or the location of your nearest dealer call 1-800-447-4700.

If you have any questions or would like technical information call 1-800-NEC-SOFT. Or write NEC Home Electronics, Computer Products Division, 1255 Michael Drive, Wood Dale, IL 60191-1094.

Take the Multi and run. MultiSpeed™

Big Text & Bar Codes



on your Epson, Okidata, IBM Printers

- Labels for shelves, bins, shipping, pallets, inventory
- Text readable at 50 ft. • 13 text sizes up to 1.2" x 1"
- I 2 of 5, UPC/EAN, Code 39, LOGMARS, AIAG
- Flexible label format • Any size label • File input
- Easy • Fast • Reversals • Color options
- Menu driven or user program controlled \$49-\$279

Bar Code Readers for:

- Minis/Micros/CRTs (RS-232) \$399
 IBM PC/XT/AT (acts as 2nd Keyboard) \$385

WORTHINGTON DATA SOLUTIONS

130 Crespi Court, Santa Cruz, CA 95060

408/458-9938

DOUBLE YOUR STORAGE CAPACITY

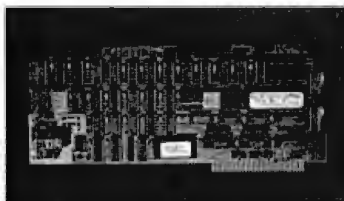

The new PERSTOR 200 Series Advanced RLL Controllers increase the storage capacity of your ST506/412 Winchester

hard disks by 90% or more. They increase the data transfer rate of MFM and RLL drives, oxide and plated media, to 9 and

10 megabits per second. For more information on becoming a dealer or placing an order, call (602) 948-7313, or clip

this ad and send it with your business card to Systems and Software at the address below.

PERSTOR®

Sensible solutions for your hard disk problems.

Systems and Software, Inc.
 7825 East Redfield Road
 Scottsdale, Arizona 85260

*call for specific drives.

Inquiry 314 for End-Users.
 Inquiry 315 for DEALERS ONLY.

equal sign, I guess), you have to move the cursor to the fourth icon and hold the mouse button until you get a drop-down menu of four icons—no words—and select the enter formula icon. Next, you go to the third icon in the bar, which looks like the enter formula icon with a little arrow pointing at the equal sign, and hold down the mouse button. The icon disappears, replaced by a menu that offers you three items: operators, constants, and functions. For good measure, this menu also shows you the names of all the worksheets you have open at the moment, but only when you're entering a formula, which is pretty useless. Select "functions" and keep the mouse button depressed. The cursor changes to a right-pointing arrow, and you slide it to the right and a menu of functions appears—about a zillion of them—in alphabetical order. Slide the mouse down to the one you want. If you let up on the button at the wrong instant, you're doomed. Oof.

Okay, conclusions are mixed. One: This is an innovative product, and I'd love it if it worked for me. As I said, I'm not sure whether the problems are with the software or with me, but either way I'm disappointed. Two: The interface needs rethinking. Three: This is a "love it or hate it" program. If you can make your current spreadsheet jump through hoops, stay with it. Learning Trapeze will be disconcerting, and worthwhile only if you desperately need the formatting power.

Another Approach

On the other hand, if you can get away without all those heavy-duty spreadsheet functions in your forms, I heartily endorse **FileMaker Plus** (Forethought, \$295) for the Macintosh. This is a simple database with great desktop publishing capabilities. You can't do table joins and other tasks normally associated with high-power relational products, but FileMaker Plus is excellent at managing data. Fast searches, computed fields, good summaries, a top-notch layout mode, and scripting ability. I've never had any trouble getting the program to work.

For another \$70, you can pick up a package of FileMaker Plus templates that work with the preprinted business forms from NEBS Computer Forms. Checks, invoices, purchase orders, etc. You even get samples of the forms and an order blank.

I like this product.

Mailbag

I recently received a letter from David Dunham, author of Acta (the Macintosh outliner), taking issue with my brief comments about that program in my February

continued

Now Available!

FIVE NEW MODELS

SHARE PRINTERS AND BUFFER PRINT JOBS WITH ONE VERSATILE UNIT



512K OR ONE MEGABYTE BUFFER KEEPS YOU WORKING INSTEAD OF WAITING

Print Master from BayTech is an intelligent printer controller that connects between your computers and printers. It allows you to share one printer automatically, contend for multiple printers automatically, or switch between several printers by sending a simple code, not by changing cables. Plus, Print Master's generous built-in buffer spools data until your printers can receive it.

Because Print Master is a very flexible device, you can set it up to fit your application, even if your application changes.

YOU SET UP THE IN-OUT PORTS

You configure Print Master's ports for any combination of printers and computers by answering questions from easy-to-follow menus. For example, with the ten port Print Master, nine computers can share one printer, eight computers can share two printers, seven computers can share three printers, and so on, to one computer which can share nine printers. You can also menu-select the disconnect time-out, form feeds, etc. and on serial models, the configuration of individual ports to translate for printers and computers using different configurations.

Since Print Master can accept data faster than your printer (up to 19.2KB serial or 5,000 characters per second parallel), you can send a print job to Print Master's standard 512K buffer and then go on to another project. All users connected to Print Master can send data to this common pool buffer, and they can be doing it simultaneously, even if no printer is available. Data is stored in the buffer until it can

be sent on a first-job-in first-job-out basis to the selected printer. If you need more memory than 512K, Print Master is optionally available with one megabyte buffer.

If several users are sharing one printer, printer sharing via Print Master is completely automatic. There are no codes to send. You simply perform your normal print operation. If you are sharing several identical printers, connection is also

automatic. Again, you perform your normal print operation and are connected to the next available printer on a first-come-first-serve basis. Print Master will send data to all printers simultaneously to keep your printers running at full capacity.

If you are sharing several different printers, such as a laser-jet, a dot matrix and a plotter, and you wish to select a specific printer, you do your normal print routine and also send a printer select code (which you can define yourself) before the first characters of your data. The data is then routed to the selected printer. It's that easy.

PARALLEL, RS-232C OR RS-422A MODELS

706A (6 parallel ports), \$795
706C (6 serial ports), \$795
708C (8 serial ports), \$895
710C (10 serial ports), \$995
706D (4 parallel/2 serial), \$795
708D (6 parallel/2 serial), \$895
706E (4 serial/2 parallel), \$795
708E (6 serial/2 parallel), \$895
710E (8 serial/2 parallel), \$995
708F (4 serial/4 parallel), \$895
710F (6 serial/4 parallel), \$995
All above models have standard 512K buffers.

Additional 500K buffer, \$249
RS422A for distances up to 4,000 feet now available on some models.

WANT DETAILS?

Call or write BayTech at P.O. Box 387, Highway 603, Bay Saint Louis, Mississippi 39520, USA. Telex 910-333-1618. Phone 601-467-8231 or

800-523-2702

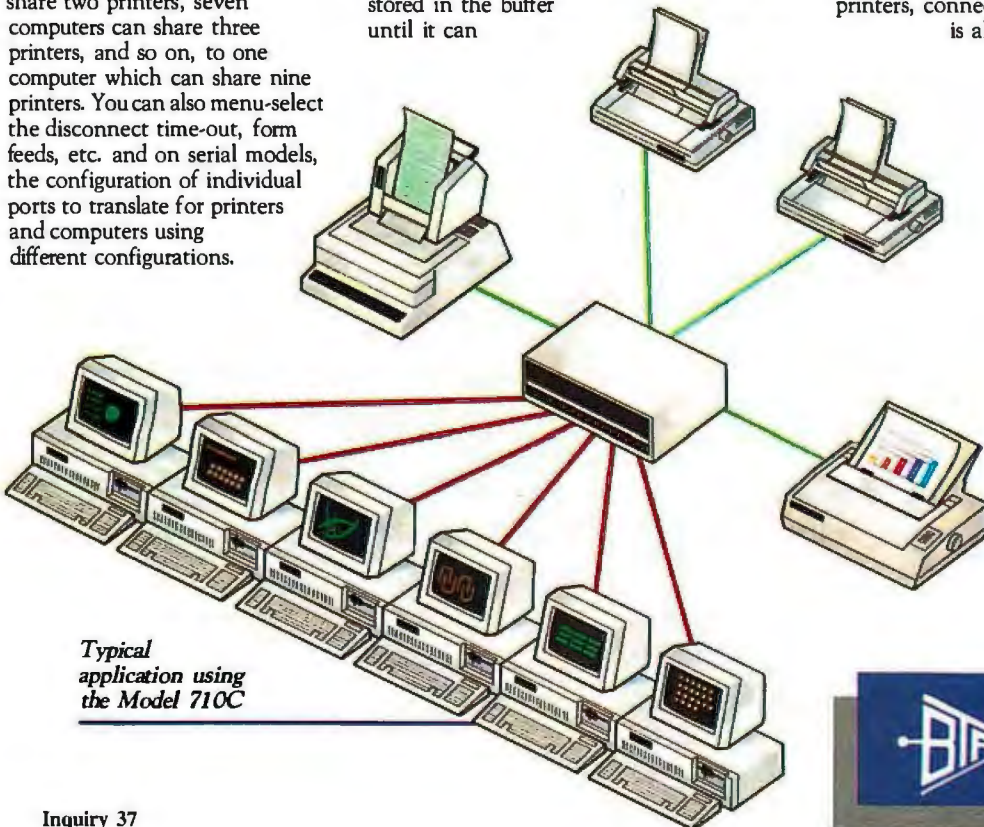

Typical application using the Model 710C



column. After chatting with him on the phone, I realized that some clarification is in order. The subsequent paragraphs start with Mr. Dunham's comments in quotes; my reactions follow.

"Acta is not really to the Mac as Ready! is to MS-DOS. It is not a stripped-down version of a larger program." Well, Acta is a Mac desk accessory, and Ready! is an MS-DOS terminate-and-stay-resident program, so there is a rough equivalence. And I enjoy using Ready!, so I thought the comparison was complimentary. I don't think of Ready!

as a stripped-down version of ThinkTank on the IBM PC; although Ready! lacks a paragraph editor, it has a number of features I'd like to see added to ThinkTank. But whether Ready! is stripped down or fattened up is not really germane to Acta; this is a cheap shot from Mr. Dunham. Both Ready! and Acta are useful tools in their respective environments, and I wouldn't want to be without either.

"This leads me to my second point; [Acta] can be compared with stand-alone programs." True. I yield to Mr. Dunham on this point. Acta is a good program, and

it can be used in any situation where an outliner is helpful.

Mr. Dunham then goes on to say, "... when the article was written, neither ThinkTank [512] nor More had the standard Macintosh Undo." Also true. Acta does have this feature, and it was added to More only with the upgrade to 1.1. However, since More now has an Undo, Mr. Dunham gets points only for being there first.

"Acta lets you paste pictures from the clipboard; ThinkTank pastes only the entire Scrapbook." I wasn't aware of this, and Living Videotext says it isn't true. I'd check ThinkTank if I had it around anywhere, but I've moved on to More.

"Acta allows an arbitrary amount of text in a topic; ThinkTank and More force you to use separate 'windows' if your topic gets too long." I'm assuming that by "topic," Mr. Dunham means "item" or "entry" rather than "file." In that case, he's correct. With Acta, you can type away merrily to your heart's content; the Living Videotext outliners restrict headlines to one line and require you to use a document editor for any sort of long text chunk. So Acta is more "modeless" than ThinkTank and More. But I don't know whether this is better or merely a difference in philosophy. Hitting a carriage return starts a new headline in the Living Videotext products; in Acta, you have to use a command-key combination.

"Admittedly, ThinkTank can do slide shows." Yes, but who cares? The fact that Acta can't do slide shows doesn't strike me as a big failing.

"And [ThinkTank] can print, which the version of Acta you reviewed couldn't (Acta 1.2, a free upgrade, prints to Imagewriter or LaserWriter)." Noted. The ability to print is a major improvement to Acta, which makes it a much better product.

"Another comment was about the lack of formatting. Considering that Acta gives you more flexible formatting than ThinkTank or More (and that Word 3.0 is still nowhere to be seen), I don't think this is a fair comment (even if it is valid for a wish list)." If all he means by "formatting" is "mucking about with type-faces," Mr. Dunham is correct. I have often been annoyed with the blandness of the Living Videotext environment. However, I used the term more broadly, meaning "preparing text for presentation." Since Acta can't do headers, footers, page numbers, tables of contents, and all that sort of stuff, I think it's limited compared to the stand-alone products.

"In any case, there is no standard clipboard data format for text containing sty-

continued



Arity/Prolog. Not for the meek. But Arity/Prolog[®] is for you...if you hunger for the power to create sophisticated programs right on the IBM[®] PC. Everything from weather prediction and process control systems to database design and medical diagnostic software.

It's for you if you're already building programs on the PC and now want to do things you've never done anywhere but on a VAX[™] or mainframe. And it's for you if you've read all about the new programming technologies and are ready to start coding.

Whatever your need, Arity/Prolog offers a total development environment including Arity/SQL and Arity/Expert. It even has an open architecture so you can work with other languages and software packages.

So if you're ready to boldly face the future of programming now, write for more information and an Arity power mask: **Arity**, 30 Domino Dr., Concord, MA 01742. Or call **1-800-PC-Arity** (in MA 617-371-1243).



COMPUTER GRAPHICS THAT JOLT YOUR SENSES AND BRING YOUR IMAGINATION TO LIFE

ACM SIGGRAPH '87



14th Annual Conference
on Computer Graphics
and Interactive Techniques

July 27-31, 1987
Anaheim, California
Anaheim Convention Center

Sponsored by the Association
for Computing Machinery's
Special Interest Group on
Computer Graphics in
cooperation with the IEEE
Technical Committee on
Computer Graphics.

CREDITS

1. "Luxo Jr.," John Lasseter, Bill Reeves,
© 1987 Pixar.
2. "Noh Space II," Takeshi Shibamoto-JVC
Japan © 1987.
3. "Chrysler Lazer," Chrysler Corporation,
Evans & Sutherland, © 1987.



Inquiry 4

Please send a copy of the SIGGRAPH '87 Advance Program to:

NAME _____

COMPANY _____

ADDRESS _____

CITY _____ STATE/COUNTRY _____

ZIP CODE _____ TELEPHONE () _____

Return form to:
SIGGRAPH '87
Conference Management
111 East Wacker Drive, #600
Chicago, IL 60601 USA
(312) 644-6610 D5

Members of ACM SIGGRAPH
will automatically receive
the advance program
in April, and **NEED NOT**
return this coupon.

ATARI PRINCE
Apple II

SUNDAY 10-5 **PROMPT DELIVERY**

COMPUTERS		PRINTERS	
APPLE Macintosh Plus	Call	HP Laser Jet Series II	1699.99
ATARI 520 w/Color Monit.	Call	HP Laser Jet Plus	Call
1040 w/Color Monit.	348.99	HP Laser JET 500	Call
COMPAQ 386	488.99	MODEMS	
40 MB, 1.2 Floppy		Hayes 300	124.99
EPSON EQUIV I	Call	Hayes 1200-B	348.99
256K RAM, 1 Floppy		Hayes 2400	319.99
IBM XT	Call	Hayes 2400-B	539.99
Dual Drive, 256K		U.S. Robotics	99.99
Dual Drive, 20 MB	348.99	1200-B	199.99
IBM AT-339	Call	2400-B	359.99
512K RAM, 30 MB	379.99	EGA CARDS	
PANASONIC		NEC GB-1	319.99
FX-800	Call	Paradise Auto Plus	319.99
256K RAM, 2-360K Dr.	749.99	Quad EGA Pro Sync	319.99
256K RAM, 20MS	948.99	Video 7 Deluxe	319.99
PANASONIC		SPERRY	
FX-800	Call	PC - IT 40 Mega	2399.99
512K RAM, 30 MB	Call	Micro IT	Call

GUARANTEED LOWEST PRICES

COMPUTER: 1-800-874-1235
VIDEO: 1-800-223-6779

S'nW ELECTRONICS & APPLIANCES
633 Bedford Ave. Bklyn, NY 11211

TOLL FREE OUT OF N.Y. IN N.Y. CALL (718) 237-2828

Closed Mon. 4:15-8T to 4:22-8T

HOURS: Mon-Thurs. 9-6
Fri. 9-2, Sat. 10-5, Sun. Closed

C.O.D. Accepted

Credit Card Accounts charged at time of order. Add shipping and handling charges. Price subject to change without notice and responsibility reserved.

Items Discussed

Acta \$59.95
Symmetry Corporation
761 East University Dr.
Mesa, AZ 85203
(602) 844-2199

FileMaker Plus \$295
NEBS Templates \$69.95
Forethought Inc.
250 Sobrante Way
Sunnyvale, CA 94086
(408) 737-7070

Fontographer \$395
Altsys Corporation
720 Avenue F, Suite 108
Plano, TX 75074
(214) 424-4888

Hotline \$39.95
General Information Inc.
401 Park Place, Suite 305
Kirkland, WA 98033
(206) 828-4777

Illustrator \$495
Adobe Systems Inc.
1870 Embarcadero Rd., Suite 100
Palo Alto, CA 94303
(415) 852-0271

More \$295
Living Videotext Inc.
2432 Charleston Rd.
Mountain View, CA 94043
(415) 964-6300

Trapeze \$295
Data Tailor Inc.
1300 South University Dr.
Suite 409
Fort Worth, TX 76107
(800) 443-1022



System

SYSTEM INCLUDES:
MOS sensor based, IBM PC compatible camera with C-Mount lens. High speed controller board. Demonstration software and subroutine library.
Adjustable frame size and resolution to 1024 x 512 pixels using the MOS digital image sensors, IS32A and IS256 OpticRAM™.
Rugged and reliable camera head for industrial environments. The high speed differential driver/receiver camera head measures 4.3"L x 1.5"H x 3"W.

MACHINE VISION APPLICATIONS INCLUDE:
FACTORY INSPECTION PROCESS CONTROL
ROBOTICS MANUFACTURING AUTOMATION
REPROGRAPHICS SIGNATURE VERIFICATION

UNDER \$500 IN OEM QUANTITIES.
Micron Technology, Inc., a world leader in semiconductor development and manufacturing, presents the IDETIX™ Imaging System, a low cost alternative for machine vision applications.
For more information contact:

See us at Comdex
Booth #5307

MICRON TECHNOLOGY, INC.
Systems Group
2805 E. Columbia Road
Boise, Idaho 83706
(208) 386-3800

listic variations, or else Acta would support it." True again; my major gripe is with the Apple operating system. However, this does lend weight to my conclusion that if you want to prepare documents with Acta, you'll probably want to massage them with a word processor.

"The above may merely be differences of opinion." Yes. That's the whole point of this column.

"One correction is not, however. Acta has a retail price of \$59.95, not \$79.95." Whoops. I blew it. Sorry about that. ■

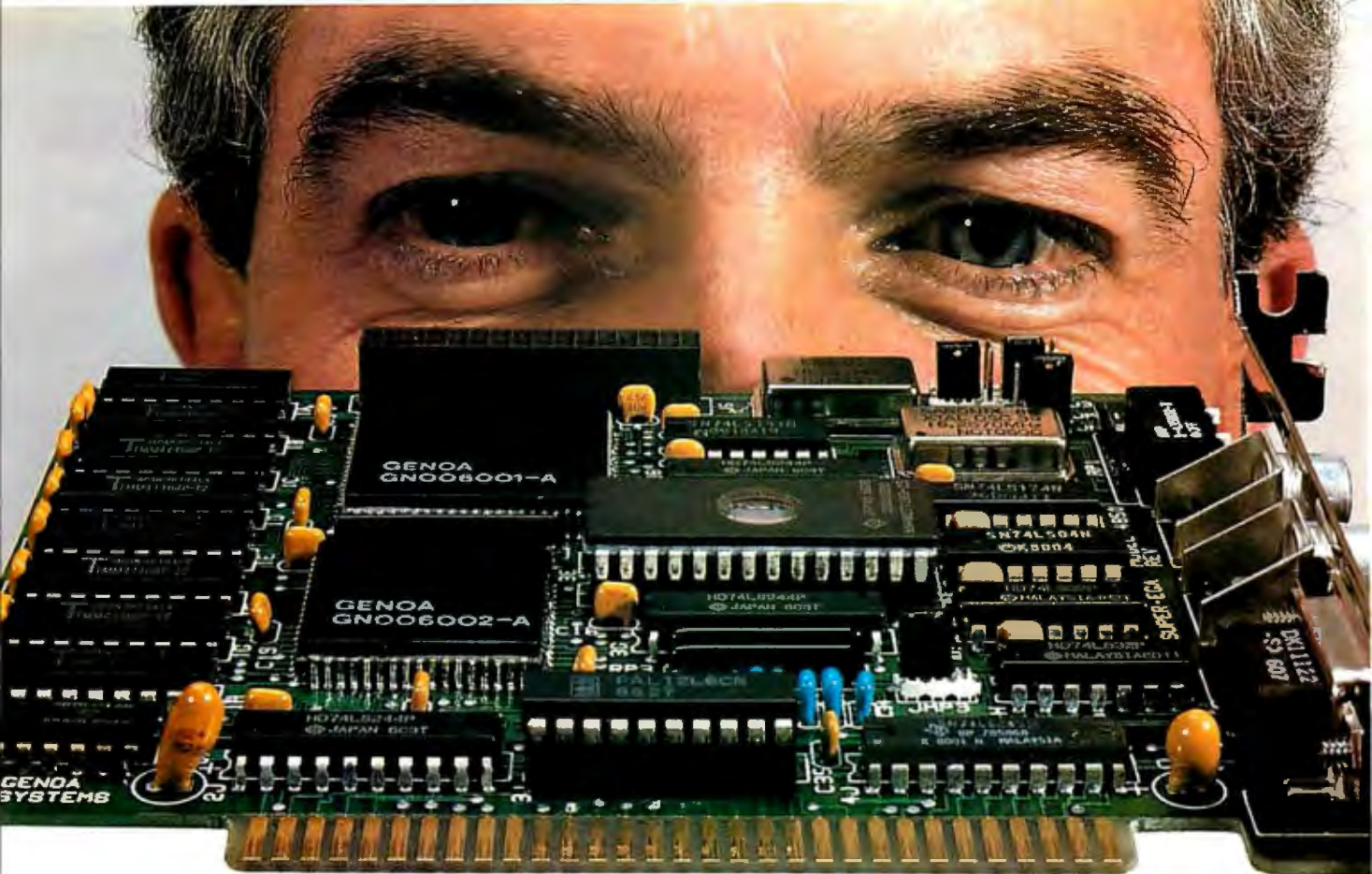

For Real EGA Compatibility, Come to Our Level.

Our Super EGA™ board is compatible all the way down to the chip register level—so compatibility is embedded in the hardware, not in the software like most EGA boards. And these chips are special: they're our own proprietary VLSI design.

- Requires no software emulation.
- 100% compatible with EGA, CGA, MDA, Hercules, TGA (640 x 400) and PGA (640 x 480).

Super Speed

- Genoa's chipset and Super BIOS™ make this one of the fastest graphics cards made.
- Operates with 4.77, 6, 8, 10, 12 or 16 MHz CPUs—with higher speeds on the way.

Super Resolution

- In EGA mode: 132 x 44, 32, 29 and 25.
- Up to 1056 x 352 pixels.
- Supports highest resolution available today (PGA).
- Displays 3270 format (Models 2, 3, 4 and 5).

Super Reliability

- Low-power CMOS VLSI chip set assures long life.

- Our dealers will tell you: our boards are the most reliable on the market!

Super Driver

- Genoa's software driver for Lotus and Symphony spreadsheet applications makes the Super EGA board a clear winner. All 132 columns are displayed on the screen at once.

Super OEMs Wanted

In addition to the ready-to-use half card, Genoa offers the custom board designs and the advanced CMOS VLSI Super EGA chip set to OEMs. Call for details.

For more information on Genoa's Super EGA board, call us at 408-432-9090, or write: Genoa Systems Corporation, 73 E. Trimble Road, San Jose, CA 95131.



Genoa's proprietary VLSI ASIC super graphics chip set gives this half-card incredible speed and compatibility.



Genoa
SYSTEMS CORPORATION
We make PCs better.

Super EGA and Super BIOS are trademarks of Genoa Systems Corporation. Lotus and Symphony are trademarks of Lotus Development Corporation. © 1986 Genoa Systems Corporation FCC Approved

THE START OF SOMETHING BIG.

- Fast plotting minimizes drawing time.
- High quality results through precise and accurate plotting.
- Automatic pen control for proper pen speed and pressure.
- Priced reasonably for all office applications.

● **SYA-350(OPTION)**
DATA BUFFER

● **DPS-20(OPTION)**
ORIGINAL STAND FOR DPX-2200

● **DPS-30(OPTION)**
ORIGINAL STAND FOR DPX-3300

● Plot produced by AUTO CAD™ software (courtesy of Autodesk, Inc.)

**DRAFTING PLOTTER
DPX-3300**
ANSI-D/ISO-A1 SIZE

- MAXIMUM PLOTTING AREA: X AXIS864mm Y AXIS594mm (X AXIS34" Y AXIS23 1/2")
- MAXIMUM PLOTTING SPEED: 450mm/sec. (18"/sec.)
- MECHANICAL RESOLUTION: 0.0125mm/step. (0.00047/step)
- PEN USED: 8 Pens
- INTERFACE: Parallel (Centronics); Serial (RS-232C)

**DRAFTING PLOTTER
DPX-2200**
ANSI-C/ISO-A2 SIZE

- MAXIMUM PLOTTING AREA: X AXIS594mm Y AXIS432mm (X AXIS23 1/2" Y AXIS17")
- MAXIMUM PLOTTING SPEED: 450mm/sec. (18"/sec.)
- MECHANICAL RESOLUTION: 0.0125mm/step. (0.00047/step)
- PEN USED: 8 Pens
- INTERFACE: Parallel (Centronics); Serial (RS-232C)

Roland DG

ROLAND DG CORPORATION

1006-14 Takaoka-cho, Hamamatsu-shi, Shizuoka-ken 433, Japan
Phone: (0534) 36-8700 Fax: (0534) 37-8271 Telex: 4225070 AMDROL J

INTERNATIONAL DISTRIBUTER

U.S.A.:

Roland Corp US
Phone: (213) 685-5141 Telex: 0674489 RCUS LSA

ENGLAND:

Roland (U.K.) Ltd.
Phone: (01) 568 4578 Telex: 934470 ROLAND G

■ If the above doesn't cover your inquiries, please contact Roland DG Corporation, Japan.

306 BYTE • MAY 1987

CANADA:

Roland DG Canada Inc.
Phone: (604) 273-4453 Telex: 4357819 ROL/AMD VCR

SCANDINAVIA:

Roland Scandinavia A/S
Phone: (01) 32 47 22 Telex: 19720 ROLAND DK

AUSTRALIA:

Roland Corporation Australia Pty. Ltd.
Phone: (02) 982 8266 Telex: 27769 ROLAUS AA

NEW ZEALAND:

Roland Corporation (NZ) LTD
Phone: (09) 398-715 Fax: (09) 391-065

BENELUX:

FRANCE:
W. GERMANY:
AUSTRIA:
SWITZERLAND:
Roland DG Europe N. V.
Phone: (014) 58 45 35 Telex: 71046 ROBNL B

Inquiry 280



Around and Around

Robert T. Kurosaka

Exploring the family of curves known as cycloids using computer graphics

If a curve C_1 rolls without slipping along another curve C_2 , any fixed point on C_1 traces a path called a *roulette*. One of the simplest of these is the cycloid, formed when C_1 is a circle and C_2 is a straight line. For every rotation of the circle, a cycloidal arch is formed, as shown in figure 1a.

Galileo is credited with naming this curve. He conjectured that the area under one arch is exactly three times the area of the generating circle. In the early 1630s, Gilles Personne de Roberval proved this to be true.

Another interesting property is that the length of one cycloidal arch is exactly four times the diameter of the generating circle; that is, the length of one arch equals the perimeter of the square circumscribed about the circle. For a thorough treatment of the cycloid, I recommend Martin Gardner's excellent *Sixth Book of Mathematical Games from Scientific American* (W. H. Freeman & Co., 1963).

We can expand the realm of cycloids by moving the point off the circle's circumference. If the point is fixed inside the circle, we get a curtate cycloid; an exterior fixed point results in a prolate cycloid (see figures 1b and 1c).

Rolling a circle inside another circle rather than along a straight line produces a hypocycloid. The number of points, or *cusps*, is determined by the ratio of two circles' radii. A fixed-circle radius that is four times the rolling-circle radius produces an astroid, that is, a hypocycloid of four cusps (see figure 1d). As was the case before, moving the point away from the rolling circle's circumference produces prolate and curtate versions of the hypocycloid.

Now consider a circle rolling around the outside of the fixed circle. The fixed point traces an epicycloid in this case. When both circles have the same radius, the curve is the familiar cardioid—a cycloid that has been bent around another circle (see figure 1e). Curtate and prolate

varieties apply here, as well.

The upside-down, or inverted, cycloid has remarkable properties. Consider two points A and B on a ramp, with A to the side of and slightly above B (see figure 2). A marble released at point A will travel to point B by the force of gravity. The shape of the path between those points determines how long the marble takes to reach B . If you construct ramps of varying shapes and conduct marble races from A to B , you will find that a cycloidal ramp gives the shortest time. This is true even if the marble has to go uphill part of the way to reach B . The inverted cycloid is thus known as a curve of quickest descent, a *brachistochrone*. Johann Bernoulli's proof of this property is found in *What Is Mathematics?* by Richard Courant and Herbert Robbins (Oxford University Press, 1941).

The inverted cycloid is also a curve of equal descent, an *isochrone* or *tautochrone*. A marble will always take the same amount of time to reach the bottom of a cycloidal ramp, regardless of its starting point.

The Dutch physicist Christian Huygens discovered this property in 1673, which led him to study the possibility of developing a perfect pendulum clock. If a pendulum could swing in a cycloidal rather than a circular arc, its period would be constant regardless of the amplitude of the swing. Huygens attempted such a design, using a flexible pendulum arm (string) and a pair of cycloidal "bumpers" flanking the pivot. However, the resulting friction made the clock even more inaccurate than the circular-arc pendulum, so it had to be abandoned.

What about the error of a circular arc? For relatively small amplitudes, the circular arc is sufficiently accurate, due to

the approximation $\sin \theta \approx \theta$ for small θ , measured in radians.

Programming Cycloids

Before the advent of affordable computer graphics, we could only read about these mathe-

matical curves and admire them. Now, with a little programming, we can create curves of our own and experiment with them endlessly.

The programs in this article are all written for an IBM PC with BASIC or GW BASIC. A graphics adapter is also required. However, if your computer has some other version of BASIC with similar graphics capabilities, you shouldn't have much trouble modifying the graphics commands. The remarks in the listings will help in the translation.

The program in listing 1 graphs two complete arches of a cycloid. You specify the location of the fixed point, or pen (as it is referred to in the program), with respect to a circle of radius 1. For example, a pen location of 1.2 places the pen 1.2 units away from the rolling circle's center. However, when the curve is drawn on the screen, these distances are scaled up as large as possible without exceeding the screen size.

The programs in listings 2 and 3 let you explore hypocycloids and epicycloids, respectively. In addition to setting the pen location, you specify the ratio of the fixed circle to the rolling circle. A value of 1 makes the two circles equal; a value less than 1 makes the fixed circle smaller than the rolling circle; and a value greater than 1 makes the fixed circle larger than the rolling circle.

Note that ratios larger than 1 need not be integral. For instance, a ratio of 3.5 is allowed; it produces a curve that closes

continued

Robert T. Kurosaka teaches mathematics in the Massachusetts State College system. He can be reached c/o BYTE, One Phoenix Mill Lane, Peterborough, NH 03458.

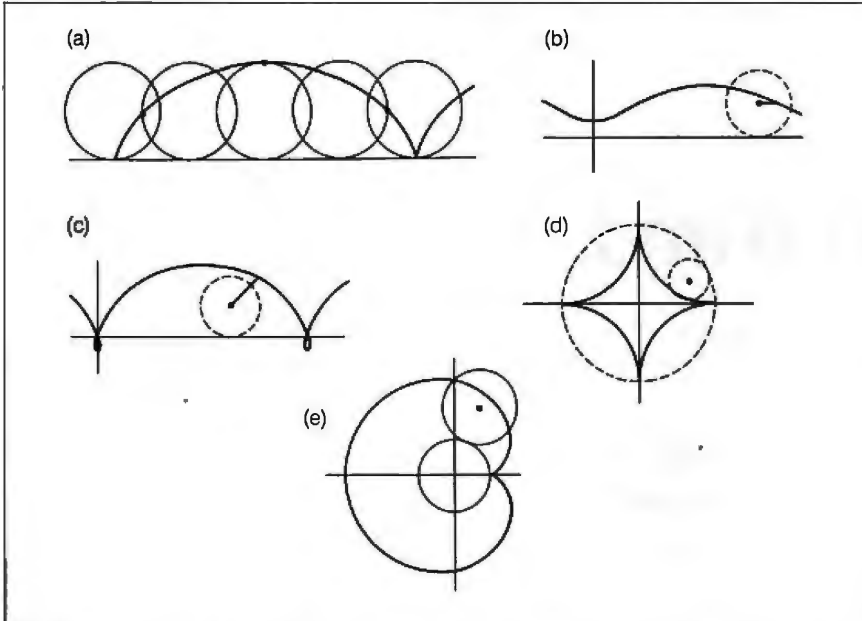

Figure 1: A variety of curves produced by rolling a circle along another curve: (a) simple cycloid; (b) curtate cycloid; (c) prolate cycloid; (d) hypocycloid of four cusps, or astroid; (e) epicycloid of one cusp, or cardioid.

(begins repeating) only after two revolutions and seven cusps. In general, if the decimal ratio is restated as a quotient m/n

in lowest terms, the rolling circle will make n revolutions and produce m cusps. In theory, an irrational number produces

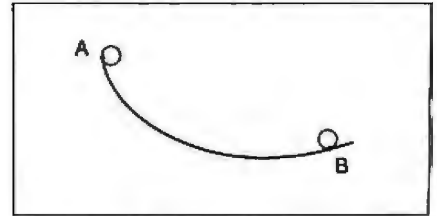

Figure 2: An inverted cycloid defines the path of quickest descent and the path of equal descent.

a curve that never closes. However, because my computer says that $\text{SQR}(2)$ is 1.4142356, I anticipate a curve that closes after some 25 million revolutions with more than 35 million cusps.

In all three listings, the program plots 100 points per revolution. You can increase the number of points for a better-looking curve, but this will slow down the drawing process proportionately.

Any standard calculus text should provide derivations of the equations used in these programs.

Beyond Cycloids

Kenner Industries makes a design toy called Spirograph. The set includes a col-

continued

Meet

power every one-year warranty.

Our PC TECH MPC-286-6/10 MHZ SYSTEM. A multi-tasking/multi-purpose computer system for single users or a multi-user network. Configurations for 8, 16, 24, or 32 users. **Phenomenal single-user price: only \$1749. Non-Xenix version (DOS 3.2) only \$1495. 12 MHZ option available.**

Warranty Service provided by CompuShield. Available anywhere in the USA.

OUR PORTABLE PC TECH P/286 TARGA has 4 graphic modes on the motherboard and a 1.2MB (or 360K) floppy. Fits under an airplane seat, and is 33% faster than the comparable Compaq 286 II. **Our takaway price: only \$2495.**

THE PC TECH X-TURBO runs on a 8088-2 CPU and is fully IBM XT compatible. Has 640K RAM and a 360K floppy. **Only \$795 with a monographic card and PGS MAX-12 monitor.**

Price the comparables and call for detailed specs (408) 435-9550

Or visit our hands-on, full-display showrooms

PC TECH
712 Charcot Avenue, San Jose, CA 95131

C COMPILER



The Powerful Mix
C COMPILER

Harness the Power of the C Language
with this full featured Compiler



MDX
1132 Commerce Drive
Richardson, TX 75081
(214) 783-6001

Only
\$39.95

C for yourself

Get off to a fast start with MIX C. Our comprehensive book and nimble C compiler will have you programming in C before you know it.

Our book is your teacher. You'll start right away, compiling and executing C programs. The tutorial takes you step by step through the C language. You'll learn by example with a book that's chock-full of sample programs. And the programs aren't just fluff. They teach you the important C concepts. An amortization program teaches you how to use pointers to functions. A data base program teaches you how to manage memory dynamically. It's the best hands on training available.

You'll love working with our C compiler. It's half as large, and twice as fast as other C compilers. In fact, it's the only full featured C compiler that can be operated comfortably on floppy disks. And as you would expect, MIX C is easy to use. It produces a complete program listing with compile errors clearly identified and explained. If you've been frustrated by other C compilers, don't throw in the towel until you've tried ours. There's a big difference.

Although it's small, MIX C is not a subset. MIX C supports the full K&R standard, including the extensions that are often omitted in other C compilers. MIX C comes complete with a comprehensive book, a standard library of more than 175 functions, a blazingly fast linker, and tools for optimizing your programs for minimal space or maximum speed. All of this is yours for the incredibly low price of \$39.95. That's little more than the cost of most C books alone. So don't be left behind. Order your copy today and find out why everyone is switching to C.

TO ORDER CALL TOLL FREE: 1-800-523-9520 For technical support and for orders inside Texas please call (214) 783-6001 Or Contact one of our Distributors in Canada: Saraguy 1-800-387-1288 • France: Info/Tech 1-43-44-06-18 • Australia: Techflow 047-586924 • Switzerland: DMB Communication CH-0-523-31817 • England: Analytical 04215-62099.

System Requirements: MSDOS/PCDOS 2.0 or higher; 256K Memory; 1 Disk Drive or CP/M 2.2 or higher (Z80); 55K Memory; 1 Disk Drive (2 recommended) (Ctrace not available for CP/M)

CTRACE DEBUGGER \$39.95

The perfect companion for MIX C is our exciting new C source debugger. Ctrace is unlike any debugger you've ever seen. It brings your programs to life on the screen. You'll see your variable values changing as you watch your C source code executing. The animated trace shows you the flow of execution, statement by statement. It's like watching the bouncing ball as the cursor dances over your C program.

Ctrace is very simple to operate. Commands are executed with a single keystroke. Pop up menus list the command options. Pop up messages alert you when anything important happens. There are 6 windows of information: source, output, variables, watch, memory, and symbols. You can view as many as 4 windows at once. The function keys make it easy to quickly choose among 8 different views.

The combination of Ctrace with MIX C makes C programming a real joy. MIX C provides the power of a compiler while Ctrace provides an execution environment that's more elegant than an interpreter.

SPLIT-SCREEN EDITOR \$29.95

Another great companion to the MIX C compiler is our split-screen editor. It makes writing programs even faster and easier. With the MIX Editor, you can compile, link, and execute your program at the touch of a key. Compiling is fast because the MIX C compiler reads the program directly from memory. Correcting errors is easy because the editor automatically positions the cursor to the first error in the program. The editor is similar to Micropro's WordStar but with additional programming features like split-screen, macros, and much more. Use it for all of your programming needs.

ASM UTILITY \$10.00

Our ASM utility is available if you want to link assembly language functions to your C programs. It works with Microsoft's MASM or M80 assemblers. Call assembly language functions just like C functions. Call C functions from assembly language. Lots of useful assembly language functions are included as examples.

The MIX C Works
Only **\$89.90**

Save \$29.95 on the Works includes Editor, C Compiler, Ctrace, & ASM Utility

Product	Price	Total
Ctrace	(\$39.95)	\$
C Compiler	(\$39.95)	\$
ASM Utility	(\$10.00)	\$
Split-Screen Editor	(\$29.95)	\$
The MIX C Works	(\$89.90)	\$
(Includes all of above)		
Subtotal		\$
Texas Residents Add 7.25% Sales Tax		\$
Add Shipping Charges		\$
In USA: add \$5 per order		
In Canada: add \$10 per order		
Overseas: add \$10 for editor		
add \$20 for compiler		
add \$30 for Works		
Total of Your Order		\$

**30 Day Money Back Guarantee
Not Copy Protected**

Please check method of payment
 Check Money Order MC/VISA
 Card # _____
 Expiration Date _____
 Please give name of computer _____
 Please check operating system
 MSDOS/PCDOS CP/M
 Please check disk size
 5 1/4" 3 1/2" 8"
 Please check disk format if CP/M
 SSDD SDD DSDD
 Your Name _____
 Street _____
 City _____
 State _____ Zip _____
 Telephone (____) _____
 Country _____

MDX Software 1132 Commerce Drive
Richardson, Tx. 75081
(214) 783-6001

Ask about our volume discounts!
Dealer Inquiries Welcome

EMPLOYMENT OPPORTUNITIES

Computer Scientists, Mathematicians, Systems Analysts — Positions in scientific computer software development, systems analysis and flight test data analysis. \$32,567 to \$42,341 depending on qualifications with opportunity for advancement. Knowledge of real-time systems, CDC computers, Gould MPX and Unix operating systems, Fortran language and Ingress DBMS are a plus. Three years minimum experience required. Positions located at the Flight Test Center, Edwards Air Force Base, California. U.S. citizenship necessary. Send resume to D.S. Painter — 6510 ABG/DPCA, Edwards AFB, CA 93523 or call 1-800-221-2343 ext 2876 (inside California) or 1-800-545-0431 ext 2876 (outside California) for more information.

EMPLOYMENT OPPORTUNITIES Section

BYTE will feature a special section for recruitment advertising in future issues.

BYTE is the perfect place to look for those High Technology professionals you need—over 300,000 paid domestic subscribers.

Or, if you're looking for a new position, this is the place to feature a **Position Wanted** ad.

The cost for any display ad in this new **EMPLOYMENT OPPORTUNITIES** section is only \$352.00 per inch. For quotes on all other size ads, or any additional information call our recruitment telephone sales staff at
212/512-2556

Or send in your order to:

**BYTE
Recruitment Advertising
Center
P.O. Box 900
New York, NY 10020**

MATHEMATICAL RECREATIONS

Listing 1: The BASIC program to graph cycloids.

```
100 KEY OFF 'Turn off key labels
110 DEF FNMAX(A,B)=-((A>B)*A-(B>=A)*B 'Maximum of A and B
120 WD=319 'Width of screen
130 HT=199 'Height of screen
140 PI=3.1415926#
150 '
160 'Get parameters
170 SCREEN 0,1: WIDTH 80: CLS
180 PRINT "Draw a cycloid"
190 PRINT "Enter the pen position w.r.t. a circle of
radius 1."
200 PRINT "<1 is inside, =1 is on circle, >1 is outside"
210 INPUT "Pen position (-1 to quit)"; H
220 IF H<0 THEN END
230 '
240 'Distinguish between curtate and prolate cycloids
250 IF H<=1 THEN TN=1: TH=0: GOTO 290 'Curtate
260 TN=SQR(H*H-1): TH=ATN(TN) 'Prolate
270 '
280 'Scale the units
290 A=WD/(4*PI+2*TN-2*TH) 'Radius of circle
300 H=H*A 'Distance of pen from circle's center
310 X0=A*TN-A*TH: Y0=HT-FNMAX(A,H) 'X- and Y-origins
320 '
330 'Set up the screen
340 SCREEN 1,1 '320 x 200 graphics
350 LINE(X0,0)-(X0,HT),2 'X-axis in color 2
360 LINE(0,Y0)-(WD,Y0),2 'Y-axis in color 2
370 CIRCLE(X0,Y0-A),A,3 'Circle at origin (color 3)
380 CIRCLE(X0+2*PI*A,Y0-A),A,3 'Circle at 1 rev.
390 CIRCLE(X0+4*PI*A,Y0-A),A,3 'Circle at 2 rev.
400 PSET(X0,Y0-A),3 'Mark center of each circle
410 PSET(X0+2*PI*A,Y0-A),3
420 PSET(X0+4*PI*A,Y0-A),3
430 '
440 'Graph the cycloid
450 FOR ANG=0 TO 4*PI STEP 2*PI/100 '100 points/arc
460 X=X0+A*ANG-H*SIN(ANG)
470 Y=Y0-A+H*COS(ANG)
480 IF Y<0 OR Y>HT THEN 500
490 PSET(X,Y),1
500 NEXT ANG
510 '
520 IF INKEY$="" THEN 520 'Hold until a key is pressed.
530 GOTO 170
```

Listing 2: The BASIC program to graph hypocycloids.

```
100 KEY OFF
110 WD=319: HT=199
120 X0=WD/2: Y0=HT/2
130 PI=3.1415926#
140 '
150 'Get parameters
160 SCREEN 0,1: WIDTH 80: CLS
170 PRINT "Draw a hypocycloid"
180 INPUT "Ratio of fixed to rolling circle (>= 1)"; R
190 IF R<1 THEN END
200 PRINT "Enter pen position w.r.t. a circle of radius
1."
210 PRINT "<1 is inside, =1 is on circle, >1 is outside"
220 INPUT "Pen position (-1 to quit)"; H
230 IF H<0 THEN END
240 IF H<=1 THEN A=.5*HT: GOTO 260
250 A=.5*R*HT/(R+H-1)
```

continued

Unforgettable.

BOCARAM /AT™

Expand with the powerful new BOCARAM/AT™ and forget about memory problems.

It was only a matter of time before all those IBM PCs, XTs, ATs and compatibles had a memory lapse at 640KB. RAM got crammed with a widening world of multi-tasking, networking and LIM/Expanded Memory Specifications (EMS) software.

The industry once again looked to Boca Research. And for good reason. We've developed a reliable, flexible, cost-efficient solution. It's the BOCARAM/AT, a powerful add-on board which provides conventional, expanded and extended memory all on one board, in one slot. And you can expand the BOCARAM/AT up to a whopping 4MB! Compatible. If you have one of those beefed-up AT/compatibles racing along at 10MHz or better, guess what a "standard" 8MHz board will do? Right—power brakes. Not with BOCARAM/AT. It'll stay right up with your CPU, all the way to 24MHz. So you can keep the speed while using all your software.

Expandable. Available slots for option cards are officially on the endangered species list. So you need to make each one count.

That's why we designed the BOCARAM/AT to take you to 640KB of conventional memory, and then up to 2MB of expanded memory or 4MB of extended memory—all on one card, in one slot! Don't need 4MB just yet? You can start with the basic card, and install additional memory later with standard RAM chips. Just that easy.

Reliable. Like all Boca Research products, the BOCARAM/AT is carefully tested before leaving the factory. Even unpopulated boards are tested with full memory before shipping. We don't expect to see these boards back, but if we do, our liberal 2-year warranty ensures you'll get quick service.

Reliable, compatible, expandable. And a price that lets you restore memory without losing your head. Think you can do all this with anything other than a BOCARAM/AT?

Forget it.

To order your unforgettable BOCARAM/AT, see your dealer or contact us directly.

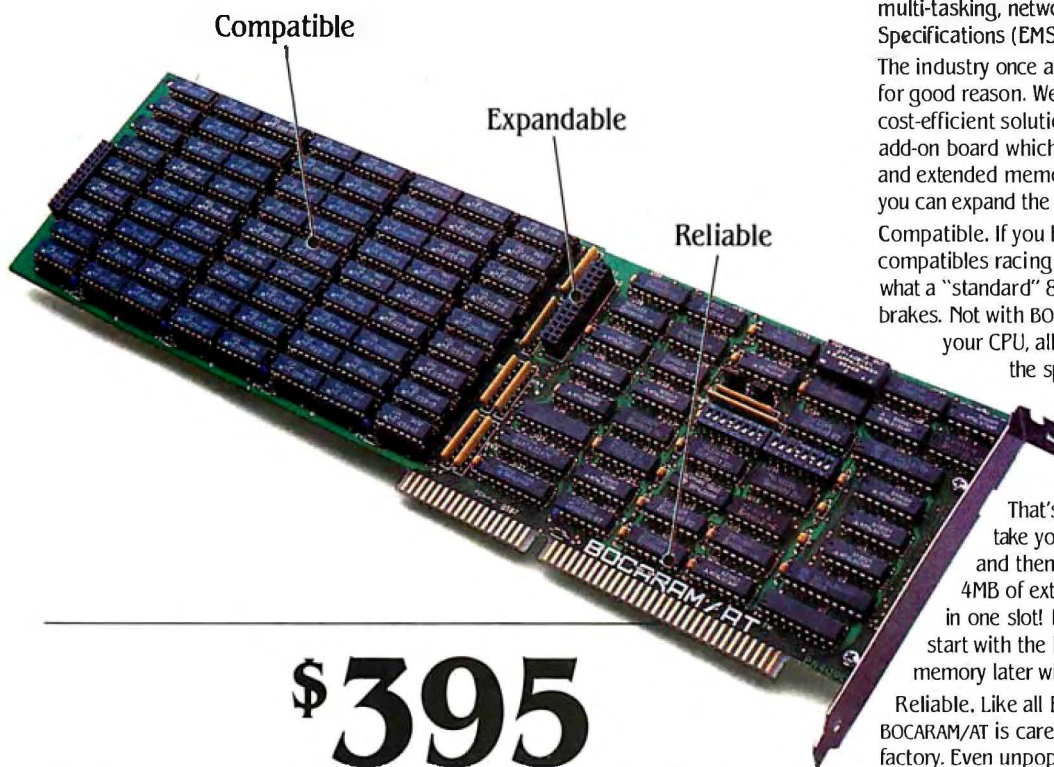

\$395

1MB

\$245

128KB

\$595

2MB

ENCLOSURES & POWER SUPPLIES

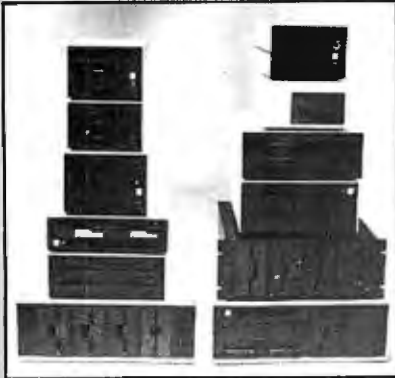

for FLOPPY WINCHESTER TAPE DRIVES

from \$100

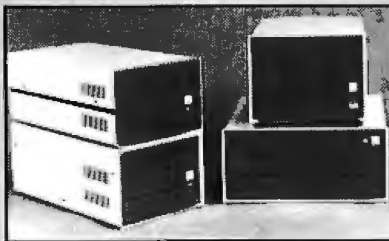

for SINGLE BOARD COMPUTERS

from \$125



for IBM & S-100 SYSTEMS

from \$200

*1 piece; prices lower in quantity.
(Disk drives not included)

Call or write for free catalog

INTEGRAND

RESEARCH CORP.

8620 Roosevelt Ave. • Visalia, CA 93291
209/651-1203
TELEX 5106012830 (INTEGRAND UD)

IBM and Winchester are trademarks of International Business Machines Corporation.

MATHEMATICAL RECREATIONS

```

260 B=A/R
270 H=H*B
280 '
290 'Set up screen
300 SCREEN 1,1: CLS      '320 x 200 graphics
310 LINE(X0,0)-(X0,HT),2 'X-scale, color 2
320 LINE(0,Y0)-(WD,Y0),2 'Y-scale, color 3
330 CIRCLE(X0,Y0),A,3    'Fixed circle, color 3
340 CIRCLE(X0+A-B,Y0),B,3 'Rolling circle, initial pos.
350 '
360 'Hypocycloid
370 ANG=0                'Initial value
380 ANG=ANG+2*PI/100    '100 points per rev.
390 X=X0+(A-B)*COS(ANG)+H*COS(ANG*(A-B)/B)
400 Y=Y0-(A-B)*SIN(ANG)+H*SIN(ANG*(A-B)/B)
410 PSET(X,Y)
420 '
430 'Keep drawing until a key is pressed.
440 IF INKEY$<>" THEN 160 ELSE 380

```

Listing 3: The BASIC program to graph epicycloids.

```

100 KEY OFF
110 WD=319: HT=199
120 X0=WD/2: Y0=HT/2
130 PI=3.1415926#
140 SCREEN 0,1: WIDTH 80: CLS
150 '
160 print "Draw an epicycloid"
170 INPUT "Ratio of fixed to rolling circle ( 0=quit)"; R
180 IF R=0 THEN END
190 PRINT "Enter pen position w.r.t. a circle of radius
1."
200 PRINT "<1 is inside, =1 is on circle, >1 is outside"
210 INPUT "Pen position (<=0 to quit)"; H
220 IF H<=0 THEN END
230 A=.5*R*HT/(R+H+1)
240 B=A/R
250 H=H*B
260 '
270 'Set up screen
280 SCREEN 1,1: CLS      '320 x 200 graphics
290 LINE(X0,0)-(X0,HT),2 'X-scale, color 2
300 LINE(0,Y0)-(WD,Y0),2 'Y-scale, color 3
310 CIRCLE(X0,Y0),A,3    'Fixed circle, color 3
320 CIRCLE(X0+A+B,Y0),B,3 'Rolling circle, initial pos.
330 '
340 'Hypocycloid
350 ANG=0                'Initial value
360 ANG=ANG+2*PI/100    '100 points per rev.
370 X=X0+(A+B)*COS(ANG)-H*COS(ANG*(A+B)/B)
380 Y=Y0-(A+B)*SIN(ANG)+H*SIN(ANG*(A+B)/B)
390 PSET(X,Y),1
400 '
410 'Keep drawing until a key is pressed.
420 IF INKEY$<>" THEN 140 ELSE 360

```

lection of large tracks and smaller wheels that rotate inside the tracks. When a pen is attached to the wheel, it draws an interesting pattern. A cycloid, right? Not always, because some of the tracks and wheels are ovals, rounded triangles, and odd shapes.

It should be possible to use a computer to simulate these beautiful roulettes on a

computer, as long as the track and the wheel can be specified mathematically. I encourage you to explore this problem, but beware: The math required is considerably more advanced than what we've used in this article. (If truth be known, the author hasn't programmed this one yet.)

Your comments are welcome. ■



Problem: Mysterious Data Loss Solution: New Verbatim DataHold Protects when Static Strikes.

Static Danger is Everywhere. Your data is vulnerable to loss from an unseen enemy—static electricity! Even small static charges could cause sudden mysterious data loss from your diskette.

And static lurks everywhere. Just walk across a carpeted floor and you build up a static charge of up to 1,500 volts—enough to ZAP your data.

It's DataHold or Data Loss. DataHold is Verbatim's ingenious diskette liner that disperses damaging static charges instantly. Compare DataLife to other popular brands which retain static charges up to four minutes and your choice should be obvious.

DataHold, available exclusively from Verbatim DataLife, for unsurpassed data protection. After all, it's your choice, DataHold or data loss.



Verbatim[®]
A Kodak Company

When you want to talk computers..

ATARI COMPUTERS

Atari Computers

800 XL 64K Computer.....	\$63.99
65XE 64K Computer.....	94.99
130XE 132K Computer.....	129.00
520ST Monochrome System.....	499.00
520ST Color System.....	749.00



Atari 1040 Color System **\$879**

Includes: 1040ST, 1 mb RAM with 3½" drive built-in, 192K ROM with TOS, Basic, Logo, ST language, power supply and color monitor.

ATARI SOFTWARE

Access	
Leaderboard Golf.....	26.99
Accolade	
Fight Night.....	19.99
Activision	
Music Studio.....	37.99
Antic	
Cad 3-D.....	34.99
Batteries Included	
Paperclip w/SPELLPACK.....	39.99
Degas Elite.....	48.99
Epyx	
World Karate Championship.....	24.99
Infocom	
Zork III.....	29.99
Microprose	
Top Gunner.....	19.99
F-15 Strike Eagle.....	24.99
Origin Systems	
Ultima 4.....	39.99
Paradox	
Wanderer (3-D).....	29.99
Psygnosis	
Deep Space.....	34.99
Timeworks	
Wordwriter ST.....	51.99
VIP	
Professional (GEM).....	144.00

COMMODORE COMPUTERS



Commodore 128 System

Includes: CB128 Computer,
CB1571 Disk Drive,
CB1902 Monitor **\$759**
Commodore-64C 64K Computer 189.00
Commodore-64C Sys. w/1802C.539.00
Commodore-128 128K Computer 259.00
Amiga 1000 Computer.....899.00
Amiga 500.....Call for pricing
Amiga 2000.....and configuration

COMMODORE SOFTWARE

Activision	
Hacker.....	32.99
Broderbund	
The Print Shop.....	29.99
The Toy Shop.....	39.99
Commodore	
Textcraft w/Graphic Craft.....	59.99
Assembler.....	79.99
Enhancer DOS 1.2.....	14.99
Discovery Software	
Marauder Back-up.....	32.99
Electronic Arts	
Deluxe Paint.....	69.99
Deluxe Print.....	74.99
Instant Music.....	34.99
Deluxe Video.....	69.99
Infocom	
Hitchhiker's Guide.....	31.99
Micro Illusions	
Dynamic-Cad.....	349.00
Mindscape	
Halley Project.....	31.99
Deja Vu.....	34.99
Micro Systems	
Analyze Version 2.0.....	119.00
Scribble.....	64.99
On-Line/Comm.....	49.99
Sublogic	
Flight Simulator.....	37.99
V.I.P.	
V.I.P. Professional.....	139.00

MS/DOS SYSTEMS

AT&T 6300.....	from \$1299.00
Compaq.....	from 1699.00
IBM-XT.....	from 1169.00
IBM-AT.....	from 2599.00
Leading Edge.....	from 999.00
NEC Multispeed.....	from 1499.00
Panasonic Business Partner.....	from 799.00
Toshiba 1100 Plus.....	from 1699.00



PC-T00 20 Meg XT-Compatible **\$999**

MULTIFUNCTION CARDS

AST	
Six Pak Plus PC/XT.....	\$169.00
Hercules	
Color Card.....	159.00
Graphics Card Plus.....	209.00
Fifth Generation	
Logical Connection 256K.....	329.00
Quadram	
Expanded Quadboard.....	119.00
Video 7	
EGA Video Deluxe.....	389.00
Zuckerboard	
Color Card w/Parallel.....	89.99

MS/DOS SOFTWARE

Ashton-Tate	
d-Base III +.....	409.00
5th Generation	
Fastback Utility.....	89.99
IMSI	
Optimouse w/Dr. Halo.....	99.99
Lotus	
Lotus 1-2-3.....	329.00
MicroPro	
Professional 4.0 w/GL Demo.....	239.00
Microstuf	
Crosstalk XVI.....	89.99
P.F.S.	
First Choice.....	119.00
Word Perfect Corp.	
Word Perfect 4.2.....	209.00



COMPUTER MAIL ORDER

.....When you want to talk price.

MODEMS

Anchor
6480 C64/128 1200 Baud.....\$119.00
VM520 ST520/1040 1200 Baud.129.00
Atari
SX212 300/1200 (ST).....99.99
Commodore
Amiga 1680-1200 BPS.....169.00
CBM 1670 &C-128).....99.99
Everex
Evercom 1200 Baud Internal....109.00
Hayes
Smartmodem 300 External.....139.00
Smartmodem 1200 External.....389.00
Practical Peripherals
1200 BPS External.....159.00
Quadram
Quadmodem II 1200 Baud.....299.00
Supra
MPP-1064 AD/AA C64.....69.99
1200AT 1200 Baud Atari.....139.00
U.S. Robotics
1200 Baud External.....129.00

DRIVES



Atari 1050 SS/DD (XL/XE) \$139

Atari
AA354 SS/DD Disk (ST).....\$129.00
SHD204 20 Meg Hard Drive (ST)599.00
Allied Technology
Apple Half-Heights.....109.00
Commodore
Amiga 1010 3 1/2".....219.00
Amiga 1020 5 1/4".....189.00
1541C.....179.00
1571.....239.00
CSI
10 mb (64-128).....1099.00
Indus
GT Disk Drive.....179.00
Microbotics
20 mb Hard Drive (Amiga).....1299.00
Racore
PC Jr. Expansion Chassis.....299.00
Seagate
20 MB ST-225 Hard Drive Kit....379.00
Supra
20 Meg Hard Drive (XL/XE).....679.00
20 Meg Hard Drive (ST).....569.00
Xebec
20 mb (Amiga).....899.00

PRINTERS

Atari
1020 XL/XE Plotter.....\$29.99
1025 XL/XE Dot Matrix.....119.00
XDM121 Letter Quality.....209.00
XMM801 XL/XE Dot Matrix.....199.00
XMM804ST Dot Matrix.....189.00
Citizen
MSP-10 160 cps, 80-Column.....299.00
Premier 35 cps Daisywheel.....499.00
C. Itoh
8510-SP 180 cps, 80-Column.....Call
310-SEP Epson/IBM 80-Column.....Call



Epson LX-86 120 cps Dot Matrix \$199

Epson
FX-86E 240 cps, 80-column.....Call
FX-286E 240 cps, 132-column.....Call
EX-800 300 cps, 80-column.....449.00
LQ-800 180 cps, 24-Wire PrintheadCall
Hewlett Packard
Thinkjet.....399.00
Juki
6300 40 cps Daisywheel.....659.00
6100 10 cps Daisywheel.....389.00
5510C Color Dot Matrix.....349.00
NEC
Pinwriter 660 24 Wire.....489.00
Pinwriter 760 24 Wire.....689.00
Okidata
Okimate 20 Color Printer.....129.00
ML-182 120 cps, 80-column.....239.00
ML-192 + 200 cps, 80-column...369.00
Panasonic
KX-1080i 120 cps, 80-column...219.00
KX-1091i 180 cps, 80-column...299.00
KX-1592 180 cps, 132-column...439.00
Star Micronics
NX-10 120 cps, 80-column.....209.00
NX-10C 120 cps, C64 Interface.219.00
NX-15 120 cps, 132-column.....369.00
Toshiba
P321 216cps, 24-Pin Printhead..479.00
P341 216cps, 24-Pin Printhead..589.00

MONITORS



Amdek 410 12" TTL Monitor \$149

Amdek
Video 310A Amber TTL.....\$139.00
Commodore
Commodore 1902.....299.00
Amiga 1080 Hi-Res Color.....269.00
Magnavox
8505 RGB/Composite.....199.00
515 RGB/Composite.....289.00
NEC
12" TTL Green or Amber.....109.00
JC-1401P3A Multi-Sync.....579.00
Princeton Graphics
MAX-12 12" Amber TTL.....169.00
Taxan
Model 124 12" Amber.....119.00
Zenith
ZVM 1220/1230.....(ea.) 99.99

DISKETTES

Maxell
MD1-M SS/DD 5 1/4".....\$9.99
MD2-DM DS/DD 5 1/4".....10.99
MF1-DDM SS/DD 3 1/2".....12.99
MF2-DDM DS/DD 3 1/2".....21.99
Sony
MD1D SS/DD 5 1/4".....8.99
MD2D DS/DD 5 1/4".....10.99
MFD-100 SS/DD 3 1/2".....13.99
MFD-200 DS/DD 3 1/2".....20.99
Hewlett-Packard Calculators
28C Scientific Pro.....199.99
18C Business Consultant.....139.95
12C Slim Financial.....74.99

In the U.S.A. and in Canada

Call toll-free: 1-800-233-8950.

Outside the U.S.A. call 717-327-9575 Telex 5106017898

Educational, Governmental and Corporate Organizations call toll-free 1-800-221-4283

CMO. 477 East Third Street, Dept. A105, Williamsport, PA 17701

ALL MAJOR CREDIT CARDS ACCEPTED.

POLICY: Add 3% (minimum \$7.00) shipping and handling. Larger shipments may require additional charges. Personal and company checks require 3 weeks to clear. For faster delivery use your credit card or send cashier's check or bank money order. Pennsylvania residents add 6% sales tax. All prices are U.S.A. prices and are subject to change and all items are subject to availability. Defective software will be replaced with the same item only. Hardware will be replaced or repaired at our discretion within the terms and limits of the manufacturer's warranty. We cannot guarantee compatibility. All sales are final and returned shipments are subject to a restocking fee.



THE GREAT ESCAPE!

FROM IVORY TOWERS AND
COLD COMPUTER ROOMS TO
THE WARMTH OF YOUR OFFICE.

*Artificial intelligence for business
has arrived in a revolutionary new
product . . . Guru.*

At last, artificial intelligence designed especially for business! Guru brings together expert system capabilities of artificial intelligence, the productivity of familiar business computing tools and the ease of communicating with your computer using menus, commands or plain English. All available in a single, integrated program.

Guru works like human experts, considering uncertainties, reasoning through forward and backward chaining, asking for more information when needed, and explaining its recommendations.

Guru's expert system works hand-in-hand with all the familiar business computing tools like spreadsheets, statistical analysis, business graphics and a programming language, always available for both expert consultation and your everyday business computing needs.

Best of all, you won't need to learn LISP or PROLOG or buy fancy computers . . . Guru runs on your PC and communicates in plain English! Guru is artificial intelligence that means business.

For more information, call or write Micro Data Base Systems, Inc./Marketing & Sales, P.O. Box 248, Lafayette, IN, 47902, 317/463-2581, Telex 209147 ISE UR.

GURU™

ARTIFICIAL INTELLIGENCE THAT MEANS BUSINESS.

CHAOS MANOR MAIL

Conducted by Jerry Pournelle

Computer Tragedies

Dear Jerry,

One of your columns long ago gave me the impression that you were interested in stories of computer programming errors that caused spectacular, or at least serious, failures. Another person who is interested in this is Gerald M. Weinberg (*The Psychology of Computer Programming*, which I highly recommend, and *Introduction to General Systems Thinking*, in which I haven't gotten past page 42). Gerry gave the closing address at the Human Factors in Computer Systems conference in Gaithersburg, Maryland, in March 1982. Unfortunately the talk was not recorded or published, as far as I know.

In the talk, Weinberg said that he was collecting stories of people who were killed or seriously hurt because of programming errors. I don't recall that he had any to tell, but I may be wrong. Apparently the following story didn't meet his criteria:

A boy had been arrested a few months earlier, then gotten out and gone straight. He was stopped for a minor traffic violation, and the police officer radioed in for information. The operator inquired from the central computer system, got the code WC, which meant "Arrest Warrant Cleared," and translated it to the officer as "Warrant Current." The officer, obeying what he thought was good information, pulled the boy in. The boy, in despair at ever getting clear of the system, hanged himself. His parents and the press were highly upset.

I found Gerry Weinberg to be a very interesting and interested person, and I think there could be an interesting tale or two if the two of you were to get together. (If you do, I'd appreciate hearing about it.) His address is RR #2, Lincoln, NE 68520-9417.

Pat McGee
Chimayo, NM

I hadn't heard of this project, but I suspect a great number of BYTE readers will have stories.

In thinking about the incident of the young man who hanged himself, I wonder, on the other hand, how many potential victims have been saved because the police were able to find out that someone picked up on a traffic charge was wanted

for a serious crime or a jail break? Nothing, I fear, is 100 percent safe from tragic consequences.—Jerry

Two-in-One Drive

Dear Jerry,

In a recent column, you expressed surprise that the AT&T PC 6300 Plus thought floppy drive A was both drive A and drive B. This is not unique to this machine. Most (if not all) MS-DOS machines with a single floppy disk drive work this way.

The DISKCOPY command can be used to copy a disk in drive A to another disk, also in drive A. DOS prompts you at appropriate times to place first the source disk, then the target disk, into drive A. However, if you wish to use the COPY command so that only certain files will be transferred, or so you can add files to a disk already in use, trying to COPY from A to A will result in a message telling you that a file cannot be copied to itself. Instead, you must use the COPY command to copy from drive A to drive B (or vice versa). You will be prompted for a disk swap as each file is copied. Granted, this involves a lot of disk swapping if several files are being copied, but it beats not being able to copy them at all, if all you have is a single-floppy machine.

I really enjoy puttering with new software and hardware, so I find the tales of your experiences quite entertaining.

Elizabeth A. Swoope
Baton Rouge, LA

Thanks. I should have figured it out, and of course, not long after I wrote that column, I did. My Zenith Z-248 works the same way: one physical floppy that can be two logical drives.

I'll continue puttering, and thanks for writing.—Jerry

Uncramming RAM

Dear Jerry,

In a recent column, you described a problem with the loading and unloading of RAM-resident programs under MS-DOS, better known as "RAM Cram." I would like to point you in the direction of two products that may solve your problems.

The first is Referee by Persoft, of Madison, Wisconsin. Its advertisement indi-

cates that it selectively loads and unloads RAM-resident programs as you desire for each application program. This one sounds like it does exactly what you want. The price is \$69.95.

The second program is Software Carousel, by SoftLogic Solutions in Manchester, New Hampshire. This package is a TopView-type program that allows up to 10 different tasks to be loaded simultaneously (not multitasking); each task can have its own set of RAM-resident programs loaded. An EMS card or large hard disk is really needed for this one to store the suspended tasks. The price of this package is \$59.95.

You could probably con a copy of each of these products, given your persuasive abilities. I haven't tried them, so I can't attest to their quality. Happy computing.

Gary R. Saake
Aurora, IL

Thanks. Both of these packages look good. I don't see them in the Domesday Book (our log of software that has come in), but I'll have a look.

I'm also looking at Framework and DESQview as possible ways out of the mess. We'll see.—Jerry

Spellbinder

Dear Jerry,

I have a fantastic word processor that I heard of years ago from two old pros who made their living doing technical writing.

The program handles files up to disk size. It is available for CP/M-80, CP/M-86, or MS-DOS, and has a powerful command and macro capability, including global search and replace (which searches an entire file, larger than computer memory, with automatic or optional replace). It has lots of other great features, including proportional printing. And it represents a single system to learn that works on either CP/M or PC-DOS machines.

The program is Spellbinder, produced by Lexisoft, P.O. Box 1950, Davis, CA 95617, (916) 758-3630.

Spellbinder is easy to use. While I never could figure out WordStar, Spellbinder gave me great results from the beginning. I think you'd like it.

Robert A. Darrow
Sunnyvale, CA

continued

I have heard good stuff about Spell-binder. At every computer show, I go to Lexisoft's booth. They take my card and swear they will send me a copy. So far, I have yet to see one.

I can only write about what is here, alas.—Jerry

Modula-2 for the Amiga

Dear Jerry,

Since purchasing my Amiga I have been using Amiga BASIC, but I would like to move up to something with a more structured and powerful high-level lan-

guage. My two choices would seem to be a C compiler or Modula-2.

C language is very "hot" now, especially with the Amiga, since its operating system was written in C. In addition, the examples in the *ROM Kernel Manual* are written in C.

Modula-2 got my attention with a relatively low price and what seems to be an easier-to-decipher code. At present, the Modula-2 compiler from TDI Software of Dallas, Texas, is the only one commercially available for the Amiga. But I hear the TDI Modula-2 compiler has several

deviations from standard Modula-2.

There is another Modula-2 being developed by a student (or students) of Professor Niklaus Wirth in Switzerland. Do you think it might be wise to wait for the new compiler because of the deviations by TDI?

Earl Davis
Marion, OH

TDI Modula-2 works. It has some mis-features, but they keep improving it. I wouldn't wait for ETH (Swiss Federal Institute of Technology) to deliver a commercial product; once they're through, someone else usually has to polish it into something usable.

And I continue to believe that Modula-2 is the right language for a great many jobs.—Jerry

"With Watson, I can make 50 cold calls a day without picking up the phone."

Paul Gilpin
Independent Insurance agent
Burlington, MA

While Paul Gilpin is out servicing clients, his Watson is doing something every agent hates: making cold calls. Watson automatically dials prospects, delivers a high-quality, digitally recorded sales message, and records responses. And impressive sales results. A

multi-purpose voice processing option for IBM PC, XT, AT, and compatibles, Watson has a base price of \$498.

For an ear-opening demo on how Watson can help you manage business communications better, dial 1-800-6-WATSON. In Mass., (617) 651-2186.



Watson

Natural MicroSystems Corporation

Watson is a trademark of Natural MicroSystems Corp. IBM PC, XT and AT are trademarks of International Business Machines Corp.

Can't BIX

Dear Jerry,

Picture a child from a poor family, in front of a toy store. He stands in the snow, looking through the window at all the wonderful things that he wants but can't have. He can only imagine the fun of playing baseball with a real bat, or the sound of the toy train whistle. He is sad.

I, too, am sad. I read the "Best of BIX," and realize how much lies beyond what will fit in the monthly section. I imagine what it would be like to converse electronically or exchange BIX mail with authors and editors of BYTE, perhaps even your esteemed self. I contemplate what I could do with some of the software downloadable from the libraries, and the many other benefits of joining BIX. I have a computer, modem, and Red Ryder, and can write procedure files to skin porcupines. But alas, BIX is out of my reach for the foreseeable future, because I have neither Visa nor MasterCard.

I wonder how many others are in the same position. Because we don't buy with plastic, we don't exist as far as BIX is concerned. There certainly are other services available that make no such requirement; GENie, for example, transfers its payments out of my checking account, and other systems require a deposit. Why couldn't BIX do something similar?

"Since when," you may ask, "is this my problem?" It isn't your *problem*, but computer-assisted conferencing is certainly one of your interests, and since your piece in the December 1986 BYTE described BIX as "the first step into what will be the normal communications pattern of the future," yours was the first name I thought of.

I hope that the "pattern of the future" doesn't exclude us non-Visa-cardholders; after all, the good that a person can derive

continued

TimeWand™ - Gathering Information



The TimeWand



Scan Part Number



Scan Quantity



Transfer Scan Data

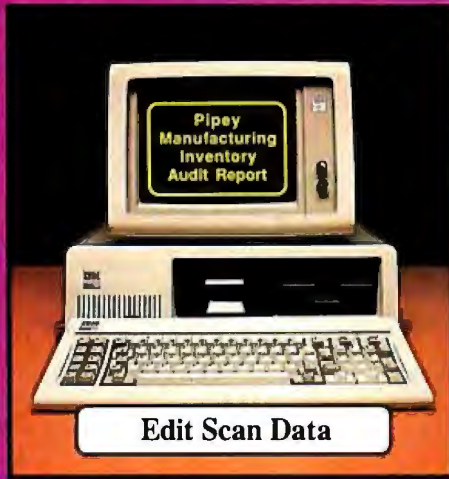

Edit Scan Data

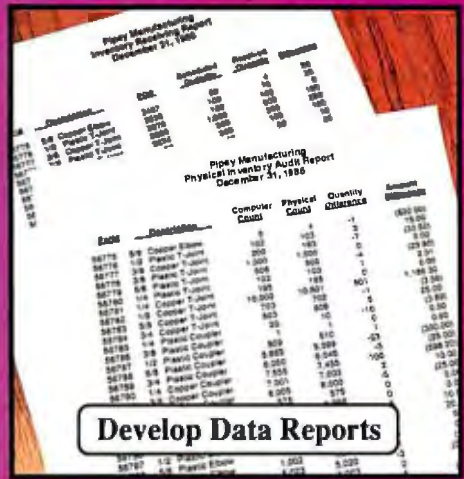

Develop Data Reports

Bar Codes, Computing, and the TimeWand... a Closer Look.

"A successful business runs on accurate, timely information." An obvious statement perhaps, but one that every personal computer user must keep in mind. In order to get the reports we require, we must ensure that the information on which we base our decisions is as up-to-date as possible. This is where a bar code reading system such as the TimeWand can be used to improve efficiency in the office or workshop. The TimeWand provides a convenient way to ensure that your computer has all the facts, all the time.

Let's use inventory control as an example. Once an inventory system is set up on the computer, you are faced with the important task of keeping the inventory up to date. The TimeWand gives you a quick and efficient method of getting information into your computer system. To enter an item into inventory (such as the copper elbows shown above), all you need to do is scan the item, the quantity, and transfer the data to your computer. By using TimeWand, you bypass the time-consuming steps of writing down every transaction, deciphering hand-written notes, typing in each inventory transaction by hand, and searching for transcription errors that might have occurred. The TimeWand is an ideal tool for gathering information for use in your business.

From time-billing to tracking work orders to monitoring security, the TimeWand provides an inexpensive solution for your data collection needs. Call or write Videx today for more information about how the TimeWand can help in your business.

- TimeWand (2K version) - \$198**
- Recharger - \$149**
- TimeWand Communication Software (IBM) - \$299**

Software available for the Macintosh, Apple // family, and Tandy (Model 100 and 200).



1105 N.E. Circle Blvd., Corvallis, OR 97330-4285
503-758-0521

Videx is a registered trademark and TimeWand is a trademark of Videx, Inc.

from, or contribute to, such a forum is not a function of his credit rating. Perhaps you might plead our case with the BIX powers-that-be, or at least pass this letter on to them.

See you on BIX? Someday, I hope.

Lyle D. Gunderson
Pleasant Grove, UT

I believe the BYTE/BIX people are trying to come up with an alternative to MasterCard/Visa for BIX, but it's a problem. How can they check the credit of an applicant? And if asked to prepay, how many applicants will do it?

BIX authorities are looking into bank transfers, and I'll certainly remind them that it's possible.—Jerry

Advertising for Europeans

Dear Jerry,

Small U.S. high-tech companies are not achieving their full market potential in Europe. As an American engineer living in Europe, I'd like to give some often-overlooked facts about commerce here.

1. 800 telephone numbers are *not* accessible outside the U.S. Always include your local number and area code in your advertisements.

2. Always give a full postal address in your ads. This is true even if your ad includes postcard response forms; all too often these disappear or expire before the ad reaches a potential customer. Without an address, written inquiries are nipped in the bud.

3. Accept Visa or equivalent cards as payment. I could write a whole letter about the frustration and cost of transferring funds through "friendly" banks.

4. Respond properly to inquiries. Obviously, to make a sale you must tell the potential buyer about the product. At the minimum, send data sheets and price lists plus shipping costs. Also include information about your other products, even those coming out Real Soon Now. Do it via airmail; regular mail can take three months to arrive.

5. Ship purchases by UPS or DHL. Although such services may not do all they claim to do, especially in a foreign country, they do try harder. Many of today's national postal services are early retirement homes.

6. Package your product to withstand a herd of stampeding elephants. A *Fragile* sticker won't work as a shock absorber.

7. Put several copies of shipping documents in an envelope on the outside of the

package. Customs officers need to know the package's contents and its value. Otherwise, they can't deliver it.

8. Tax structures vary a great deal. Itemize and specify a value for each type of product. For example, books, software, and hardware all have different import duties here in Norway. Splitting the total may save the customer some money.

9. We use 220-VAC 50-Hz power here. (The Japanese are responsive to this fact, even if you're not.) Design with a selectable power transformer and a three-prong removable power cord, so we can put on the right power cord to match the wall sockets here.

10. Local representatives can be invaluable—but not if they can't carry on a technical conversation about your product, and not if they're tripling your prices. Choose judiciously.

Bob Clarke
Larvik, Norway

Thanks for the tips. Maybe someone is reading this.—Jerry

Couch Computing

Dear Jerry,

I've followed with interest your search for the perfect writing system. I'm a writer of software and prose myself, and I have a system that may appeal to you.

A couple of years ago I was thinking how nice it would be to be able to write without leaving my comfy spot on the couch. I figured what I'd need would be a remote control keyboard and a large remote control TV set/RGB monitor. I found both, a Cherry keyboard and a Mitsubishi TV/monitor.

The keyboard isn't my favorite, but I haven't seen another I can use from five feet away. Better hurry if you want one—I believe I recently saw them being dumped for \$69 in the back of BYTE.

Mark McWiggins
Seattle, WA

Sounds interesting. Actually, though, I have about 10 feet of cable on my wonderful (but no longer obtainable) Archive keyboard that works with Zeke II, the ancient CompuPro Z80 I do most of my writing on. I presume I could curl up on a couch with it, since my 15-inch Hitachi monitor is plenty big enough to see from a goodly distance.

Somehow, though, I've never been tempted. I learned to type sitting reasonably erect, and since I type all day I think I'd have real back problems if I didn't.

Incidentally, my Archive keyboard has Hall-effect keys. They are nearly indestructible, and the action is wonderful. Alas, I think no one makes a keyboard with Hall-effect any longer.—Jerry ■

2400 bps Modem PRICE BREAKTHROUGH

AMAZING NEW PRICE!

\$**175***

*While supply lasts. Freight and tax extra.
Offer Expires June 15, 1987

- Half card size
- AT compatible
- Runs most communication packages
- V.22 bis compatible
- 212A and 103 compatible
- 30-day money back guarantee

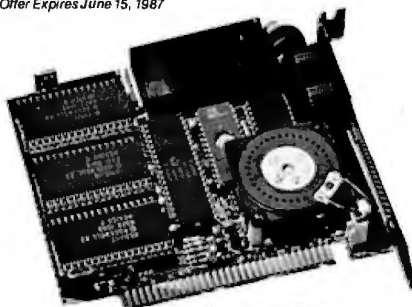

800 835-9009 IN CA
558-5741 OUTSIDE CA

SC
Sunnyvale
Communications
Company

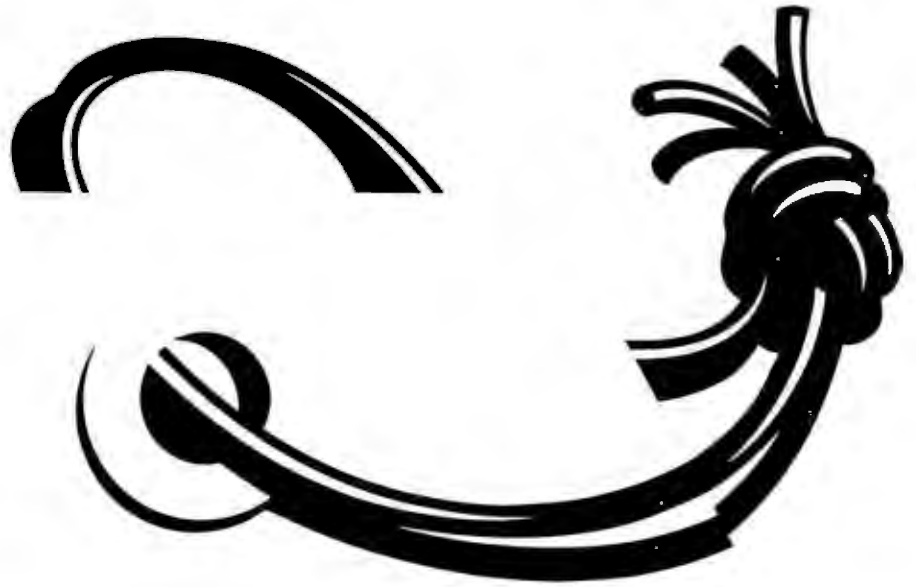

In a world
of compatibility,
we want to illustrate
one small difference.

Price could make a world of difference when you select your compatible PC.

From the \$1195 PCX-2 to the \$3695 286-based PCA-70 with 70MB of hard disk storage, each of Tandon's nine compatibles delivers the same features and high performance as PCs costing up to 40% more. Not only are Tandons the lowest priced compatibles, they're brought to you by a trusted manufacturer with more than 10 years of experience in the high technology industry.

Tandon Personal Computers. Call toll-free for the dealer nearest you: 1-800-338-4555. In California: 1-800-237-1735. Because if it's all the same to you, our price isn't.

Tandon
Price. Selection. Quality.

Inquiry 319





BYTE reader... Power User...

Meet Bill Sundberg, Senior Systems Analyst. He is a **"Power User"** of computers at work and at home. Bill is on the leading edge of computer technology. Before leaving his office tonight, he will issue a proposal to buy \$638,400 worth of micro hardware and peripherals.

Bill is a pro. He stays current with new developments in the micro industry by reading BYTE, the magazine for the **"Power Reader."** BYTE readers have tremendous clout due to their broad-based technical expertise. About 90% of BYTE subscribers buy or influence their company's purchases of software, hardware and peripherals.





Power Buyer.

During the next 12 months, the average BYTE subscriber's company plans to buy micro-related purchases worth over \$474,000, *plus* an additional \$145,000 in software. On his recommendation! It's a fact, the BYTE reader is *the* "Power Buyer."

In terms of buying influence, our "Bill Sundberg" typifies the average BYTE reader with a technical job title, according to the 1986

Hardware Purchasing Influence Study and the *1987 Software Purchasing Influence Study*. Results of these research studies are available from your BYTE Advertising Sales Consultant.

Are you putting the "Power of BYTE" to work for your micro products? *To find out how...call your BYTE Advertising Sales Consultant today.*

BYTE means business.

BYTE

THE SMALL SYSTEMS JOURNAL

One Phoenix Mill Lane
Peterborough, NH 03458
(603) 924-9281

MAY 1987 • BYTE 323

Announcing BYTE's New Subscriber Benefits Program

Your BYTE subscription brings you a complete menu of the latest in microcomputer technology every 30 days. The kind of broad-based objective coverage you read in every issue. *In addition*, your subscription carries a wealth of other benefits. Check the check list:

BONUSES

- ✓ **Annual Separate Issues:** In addition to BYTE's 12 monthly issues, subscribers also receive our annual IBM PC issue free of charge, as well as any other annual issues BYTE may produce.
- ✓ **BYTE Deck:** Subscribers receive five BYTE postcard deck mailings each year—a direct response system for you to obtain information on advertised products through return mail.
- ✓ **Reader Service:** For information on products advertised in BYTE, circle the numbers on the Reader Service card enclosed in each issue that correspond to the numbers for the advertisers you select. Drop it in the mail and we'll get your inquiries to the advertisers.
- ✓ **TIPS:** BYTE's Telephone Inquiry System is available to subscribers who need *fast response*. After obtaining your Subscriber I.D. Card, dial TIPS and enter your inquiries. You'll save as much as ten days over the response to Reader Service cards.
- ✓ **BYTE's BOMB:** BYTE's Ongoing Monitor Box is your



direct line to the editor's desk. Each month, you can rate the articles via the Reader Service card. Your feedback helps us keep up to date on your information needs.

- ✓ **Subscription Service:** If you have a problem with, or a question about, your subscription, you may phone us during regular business hours (Eastern time) at our toll-free number: 1-800-423-8912 (in N.J., 201-981-1963). You can also use Subscription Service to obtain back issues and editorial indexes.

PAID SERVICES

- ✓ **BIX:** BYTE's Information Exchange puts you on-line 24 hours a day with your peers via computer conferencing and electronic mail. All you need to sign up is a microcomputer, a modem, and telecomm software. For further information and cost call 1-800-227-BYTE.

- ✓ **Program Listings:** Listings of programs that accompany BYTE articles are now available on BIX, on disks or in quarterly printed supplements (see reply cards in this issue for cost information), or call 1-800-258-5485.

- ✓ **Microform:** BYTE is available in microform from University Microfilm International in the U.S. and Europe. See Contents page for cost information.

DISCOUNTS

- ✓ 13 issues instead of 12 if you send payment with subscription order.
- ✓ One-year subscription at \$22 (50% off cover price).
- ✓ Two-year subscription at \$40.
- ✓ Three-year subscription at \$58.
- ✓ One-year group subscription for ten or more at \$18.50 each. (Call or write for details.)

TOLL-FREE NUMBERS FOR YOUR CONVENIENCE:

Subscriptions & Back Issues:

1-800-423-8912 (in N.J., 201-981-1963)

BIX: 1-800-227-BYTE

Program Listings Orders:
1-800-258-5485

*And... welcome to
BYTE country!*

BYTE
THE SMALL SYSTEMS JOURNAL



BYTE LISTINGS YOUR WAY!

It's easy. Now there are three ways to get source-code listings that go with BYTE articles—on disk, in print or on line.

LISTINGS ON DISK

BYTE listings on disk are right for you if you want to compile or run programs quickly. Disks are now available by annual subscription as well as individual orders. BYTE offers listings in 11 popular disk formats.

LISTINGS IN PRINT

This print supplement contains source-code listings described in the issues of BYTE.

LISTINGS FROM BIX

(BYTE Information Exchange) By joining BIX, you can download BYTE source-code listings at standard BIX rates. See BIX informational ad listed in Reader Service index in this issue.



FOR DIRECT ORDERING CALL TOLL FREE: 800-258-5485

Call: M-F, 8:30 a.m. to 4:30 p.m. Eastern Time

(603-924-9281 for New Hampshire residents)

For credit card orders only.

ON DISK

Please send me single disks in the format checked for the following 1987 issues:

- | | |
|-----------------------------------|---------------------------------------|
| <input type="checkbox"/> January | <input type="checkbox"/> August |
| <input type="checkbox"/> February | <input type="checkbox"/> September |
| <input type="checkbox"/> March | <input type="checkbox"/> October |
| <input type="checkbox"/> April | <input type="checkbox"/> November |
| <input type="checkbox"/> May | <input type="checkbox"/> December |
| <input type="checkbox"/> June | <input type="checkbox"/> IBM PC Issue |
| <input type="checkbox"/> July | |

Disks of listings for December 1985 and all 1986 issues are available at the prices stated at the right. Please mark the appropriate format and note the issue date below.

Month _____

Year _____

	IN USA:		OUTSIDE USA:	
	Single Month (one disk)	Annual Subscription (13 disks)	Single Month (one disk)	Annual Subscription (13 disks)
5 1/4 inch: <input type="checkbox"/> IBM PC <input type="checkbox"/> Apple II <input type="checkbox"/> Kaypro 2 CP/M <input type="checkbox"/> Tandy Mod 4 <input type="checkbox"/> MS-DOS 8 Sector <input type="checkbox"/> TI Professional	<input type="checkbox"/> \$8.95	<input type="checkbox"/> \$69.95 (Save \$46.40)	<input type="checkbox"/> \$10.95	<input type="checkbox"/> \$89.95 (Save \$52.40)
3 1/2 inch: <input type="checkbox"/> Apple Macintosh <input type="checkbox"/> Atari ST <input type="checkbox"/> Amiga <input type="checkbox"/> HP 150	<input type="checkbox"/> \$9.95	<input type="checkbox"/> \$79.95 (Save \$49.40)	<input type="checkbox"/> \$11.95	<input type="checkbox"/> \$99.95 (Save \$55.40)
8 inch: <input type="checkbox"/> CP/M	<input type="checkbox"/> \$9.95	<input type="checkbox"/> \$79.95 (Save \$49.40)	<input type="checkbox"/> \$11.95	<input type="checkbox"/> \$99.95 (Save \$55.40)

IN PRINT

1987 Annual Supplement Subscription Rates

IN USA:
only \$18.00
(Save \$9.80)

OUTSIDE USA:
only \$21.00
(Save \$10.80)

1987 Supplement Issues

IN USA:

- January through March 1987 for only \$6.95.
- April through June 1987 for only \$6.95.
- July through September 1987 for only \$6.95.
- October through December 1987 for only \$6.95.

OUTSIDE USA:

- January through March 1987 for only \$7.95.
- April through June 1987 for only \$7.95.
- June through September 1987 for only \$7.95.
- October through December 1987 for only \$7.95.

1986 Supplement Issues

IN USA:

- January through June 1986 for only \$8.95.
- July through September 1986 for only \$6.95.
- October through December 1986 for only \$6.95.
- 1986 Annual Subscription for only \$18.00 (Save \$4.85).

OUTSIDE USA:

- January through June for only \$9.95.
- June through September for only \$7.95.
- October through December for only \$7.95.
- 1986 Annual Subscription for only \$21.00 (Save \$4.85).

COMBINED DISK AND PRINT SUBSCRIPTION

Bundled together, giving you the convenience of disk-based source-code plus the ease of reference of print.

	IN USA: Annual Subscription (13 disks & 4 Issues)	OUTSIDE USA: Annual Subscription (13 disks & 4 Issues)
5 1/4 inch: <input type="checkbox"/> IBM PC <input type="checkbox"/> Apple II <input type="checkbox"/> Kaypro 2 CP/M <input type="checkbox"/> Tandy Mod 4 <input type="checkbox"/> MS-DOS 8 Sector <input type="checkbox"/> TI Professional	<input type="checkbox"/> \$84.95 (Save \$59.20)	<input type="checkbox"/> \$104.95 (Save \$69.20)
3 1/2 inch: <input type="checkbox"/> Apple Macintosh <input type="checkbox"/> Atari ST <input type="checkbox"/> Amiga <input type="checkbox"/> HP 150	<input type="checkbox"/> \$94.95 (Save \$62.20)	<input type="checkbox"/> \$114.95 (Save \$72.20)
8 inch: <input type="checkbox"/> CP/M	<input type="checkbox"/> \$94.95 (Save \$62.20)	<input type="checkbox"/> \$114.95 (Save \$72.20)

MAY 1987

Name _____

Address _____

City _____ State _____ Zip _____

County or Parish _____ Country _____

Credit Card # _____

Exp. Date _____ Signature _____ Date _____

- Check enclosed
- MasterCard
- VISA
- U.S. Funds enclosed (If ordering from outside the U.S. please remit in U.S. funds drawn on a U.S. bank. Thank you.)

Please allow 4-8 weeks for delivery.



OLD
ERE



NO POSTAGE
NECESSARY
IF MAILED
IN THE
UNITED STATES

BUSINESS REPLY MAIL
FIRST CLASS MAIL PERMIT NO. 10 PETERBOROUGH, NH

POSTAGE WILL BE PAID BY ADDRESSEE

BYTE Listings

One Phoenix Mill Lane
Peterborough, NH 03458-9990

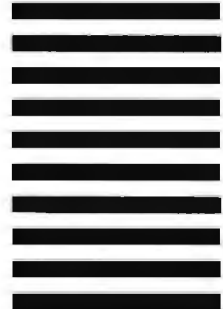

OLD
ERE

The Best of BIX is a quick look at just a few of the thousands of messages that are posted on BIX each month. This month, you'll find excerpts from the Amiga, Atari, IBM PC, and Macintosh conferences. If you'd like information on joining BIX, see the advertisement on page 256.

AMIGA

This month's Amiga section includes three threads. We start off with a thread on installing an 80-track drive on an Amiga, forge on to the problems of a BIXer with a flaky system, and finish up with a thorough look at the ins and outs of the Amiga's Auto-Configuration RAM.

INSTALLING AN 80-TRACK DRIVE

amiga/hardware #1052, from nhimes (Nard Himes), Mon Feb 9 22:43:15 1987.

I have been attempting to interface Teac FD-55 and FD-96 drives to an Amiga using a latch circuit. The problem is that the Amiga will not recognize the drive. I believe the problem centers around the RDY line and ID mode, since the latch circuit works with another 5 1/4-inch drive. Can the interface be modified to cause the drive to Auto Configure or can the mount command be used to make the computer recognize the drive?

amiga/hardware #1053, from grr (George Robbins, Commodore Business Machines), Mon Feb 9 22:52:22 1987. A comment to message 1052.

What (if any) kind of icon do you get for the drive?

amiga/hardware #1054, from afinkel (Andy Finkel, Commodore Business Machines), Mon Feb 9 22:56:34 1987. A comment to message 1052.

Have you made an entry in the mountlist for it? And what happens when you mount it? (That is, what does the info command tell you, what does the assign command tell you, what does Workbench think when you put a disk in? (Bad?))

amiga/hardware #1055, from jdow (Joanne Dow), Mon Feb 9 23:00:33 1987. A comment to message 1054.

He seems to be talking about a 96-tpi 5 1/4-inch drive. If so, he should be very sure it will handle a 3-millisecond stepping pulse period. Then consult message 445 here for the tracing of the Amiga 3 1/2-inch drive applique schematic. Those things will work very well indeed.

amiga/hardware #1056, from jdow, Mon Feb 9 23:02:51 1987. A comment to message 1055.

In fact, to further answer, I run four drives here, two are the Amiga internal and one is an external 3 1/2-inch. The other two are Mitsubishi 96-tpi drives with spare gates hacked into the drives to look like the schematic shown. I did have to add a drive-door-open switch, though, to make things like me. (Diskchange seems entirely TOO kludgey.)

amiga/hardware #1057, from grr, Mon Feb 9 23:08:08 1987. A comment to message 1055.

Hope he's got the pins numbered correctly. A nonresponsive drive should give a df1:bad-type icon. Screwing up the serial configuration code yields no drive, lots of confusion, and I don't know what else.

A FLAKY SYSTEM

amiga/hardware #1067, from s.choi (Seokrim Choi), Wed Feb 11 21:34:22 1987.

My Amiga is not stable. When I turn it on and put the Workbench disk in, sometimes the computer goes down as soon as the disk drive light goes off. Also, when I open the clock window as a background job and use a communications program, the computer crashes, but not every time. Most of the time it works very well.

I sent the unit to the dealer, and they said they couldn't find fault and my Amiga worked very well on their desk. They sent it back to me and when I turned it on again, it crashed.

I checked my power line, monitor, and mouse. I didn't open the unit, since my warranty would become void. So I need your advice. What is the problem with this little monster?

amiga/hardware #1068, from jdow, Wed Feb 11 21:38:35 1987. A comment to message 1067.

Have you recopied the Kickstart and Workbench disks you use from your masters? There may be some files mashed in there. Also, be sure you initialize the WB disk with the 1.2 Initialize, if you are running 1.2. Anyway, you MIGHT have a subtly munged file somewhere. (If you are running any of the beta 1.2s, all bets are off.)

Another problem might be thermal. Is your work area noticeably warmer or colder than the store's? And did the store check with YOUR disks?

amiga/hardware #1069, from s.choi, Wed Feb 11 23:33:30 1987. A comment to message 1068.

I have checked my disks. That was my first action. I visited my Amiga dealer and got a new copy of WB and Kickstart. But I still have the same problem. My WB and Kickstart version are 1.1. I don't have 1.2.

My room is, of course, warmer than the store. But the Amiga works very well in that temperature most of the time. When my computer goes down, generally it goes to Guru Meditation. But sometimes it just does nothing. I have 512K of memory and one disk drive.

amiga/hardware #1070, from jdow, Thu Feb 12 11:33:09 1987. A comment to message 1069.

Hm, it sounds a bit like a weak memory chip. If you are coming up with a virgin start-up sequence (or at least no more modified than to kill the last line - the "endcli >nil:" one).

Try to make note whether or not the problem is worse with the temperature higher. It may be a temperature-related problem. Finding that kind of problem may be most difficult. If you turn your thermostat up and that day have more problems than the next day with the window open a crack, then you have a good

continued

start on describing a temperature problem to the store. Then they should be able to play with a heat gun or hair dryer to duplicate the problem. (That is, if they are reasonably hardware-savvy there. Good repair people are more than a tad hard to find. I wish you were out here and had bought it from KJ. They have a very good policy on warranty repair at the mere hint of problems. That must have some relationship to how well they are doing selling these newfangled mouse-driven computers that sport actual colors on the screen.)

amiga/hardware #1091, from s.choi, Fri Feb 13 22:49:31 1987.
A comment to message 1070.

I've tested my computer for two days. I found that the crash has something to do with the temperature. I've heard about this kind of problem but never thought I would encounter it. (Anything can happen in New York!)

amiga/hardware #1073, from chuckr (Charles Robey), Thu Feb 12 20:08:27 1987.

Oh, yeah, one last thing for s.choi. I have also heard of weird problems like that when one lives too close to an AM/FM/TV transmitter.

amiga/hardware #1086, from jdow, Fri Feb 13 04:22:28 1987. A comment to message 1073.

If that is the case, I'd strongly suspect that movement of the mouse cord would affect things greatly.

amiga/hardware #1087, from chuckr, Fri Feb 13 18:53:26 1987. A comment to message 1086.

One way to beat it is to put your system on a hellacious ground plane, like a piece of grounded aluminum foil (the way I finally stopped my old PET from blowing up). The mouse line may or may not act as an antenna, depending on the impedance design, I think. RF never was my big bag; I like digital signal processing and digital messing around and communications.

amiga/hardware #1092, from jdow, Fri Feb 13 23:43:02 1987. A comment to message 1087.

Dunno about susceptibility, but the mouse leads radiate like crazy. They even interfere with 2-meter ham equipment. (I'm a ham radio operator as well as all this silliness.)

amiga/hardware #1099, from chuckr, Sat Feb 14 14:03:43 1987. A comment to message 1092.

That's interesting. I would have thought that while the mouse line could pick up signals, it would not be likely to radiate them. I have taken a quick look at the signals on the mouse line; they look like they are all DC. Don't understand that one. Is it a problem?

amiga/hardware #1108, from jdow, Sat Feb 14 21:45:22 1987. A comment to message 1099.

Not much. It is barely noticeable if I have my 2-meter rig's squelch set down very low or if signals are weak. At lower frequencies it might be, but I haven't tried. (And this is with the antenna uncomfortably close to the computer.)

AUTO-CONFIGURATION RAM

amiga/hardware #1125, from steveth (Steve Thomas), Tue Feb 17 21:48:47 1987.

I know that RAM placed at \$C00000 will AutoConfig under V1.2, as I've got 512K in that range now. What I'm wondering is, aside from the 4K where the custom chips are, of course, how much of that 2-megabyte space will AutoConfig? Is it limited to 1Mb, 1.5Mb, 1.75Mb, 1.996Mb? I'm thinking of cramming a bunch of RAM into that space, and if I can get 2Mb (minus the last 4K), that's what I'll go for.

amiga/hardware #1126, from grr, Tue Feb 17 23:34:12 1987. A comment to message 1125.

Basically, up to 1.5Mb in 64K increments (may not be 100% exact, but that's the idea).

amiga/hardware #1128, from steveth, Wed Feb 18 02:34:26 1987. A comment to message 1126.

Okay, 1.5Mb sounds good to me. A couple more questions, if you don't mind:

continued

AC/FORTRAN™ **AMIGA**

Mainframe quality, full feature **ANSI FORTRAN 77** compiler includes **Debugger**, Linker, Library Manager, Runtime Library, **IEEE** math, and **C** interface. Supports **Complex numbers**, **Virtual arrays**, **Overlays** and **Dynamic Linking**. Not copy protected. Available now \$295. Turbo Amiga version also available.

AC/BASIC™

From the authors of **Microsoft BASIC** compiler for Macintosh, comes **AC/BASIC** for the Amiga. Companion compiler to the **Amiga BASIC** interpreter: has more features and includes a **Debugger**, includes **BLOCK IF**, **CASE** statement, and **STATIC** keyword extensions and executes up to **50x** faster. **AC/BASIC** is the new **BASIC** reference for **MC68000** based personal computers. Not copy protected. \$295.

Telephone orders welcome

abssoft

Scientific, Engineering Software
4268 N. Woodward, Royal Oak, MI 48072 (313) 549-7111
Amiga trademark of Commodore Amiga
Microsoft trademark of Microsoft Corp

Inquiry 3

DATA ACQUISITION TO GO
INTERFACE FOR ANY COMPUTER

FREE IBM SOFTWARE



Connects via RS-232. Fully IBM compatible. Built-in BASIC. Stand alone capability. Expandable. Battery Option. Basic system: 16 ch. 12 bit A/D, 2 ch. D/A, 32 bit Digital I/O. Expansion boards available. Direct Bus units for many computers.

(201) 299-1615
P.O. Box 246, Morris Plains, NJ 07950

ELEXOR

Inquiry 103

HACKERS BEWARE!

PC Security and Management

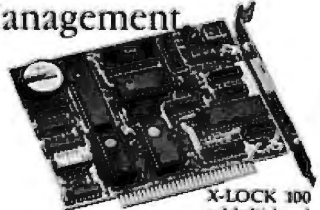

X-LOCK 100
• Multi-level access restriction
• File Protection
• File Encryption
• Complete Usage Reports
• Physical Locking
only \$495 ea.

ELECTRONICS, INC.
2137 Flintstone Dr. • Tucker, GA 30084
404-491-8044

Inquiry 27

QSP SUPER MICRO 286 AT™



- Runs all major software including Novell Network, Microsoft Word, Lotus 1-2-3, Dbase III plus, Flight Simulator, Auto cad, Microport Unix C etc.
- Norton Utility rating at 9.2
- 1 Year limited warranty
- Extended warranty available
- Quantity discounts available

- ZERO WAIT STATE
- 1 MB high speed (120NS) DRam on board
- 6/8 MHz (10 MHz opt.)
- Licensed Phoenix BIOS
- Built-in 2 serials & 1 parallel port
- Reset button & turbo mode LED
- Hold up to 5 1/2 ht drives
- Clock/calendar w/battery backup & rechargeable AA battery set mounted
- 200 Watt power supply
- Setup software
- Hard cover User's Manual

***** ALL FOLLOWING MODELS WITH AN IBM® COMPATIBLE ENHANCED KEYBOARD *****
 ** OTHER CONFIGURATION CALL FOR PRICES.

MODEL 1	\$1345.00	MODEL 2	\$1449.00	MODEL 3	\$1944.00	MODEL 4	\$2049.00
Above configuration + - 1.2 MB floppy drive - WD H/F disk controller		MODEL 1 + - Hercules compatible monographic w/printer port - Mono monitor		MODEL 1 + - EGA card (16 colors, 640 x 350 Res.) - EGA monitor		MODEL 2 + - Seagate 30MB high speed hard disk (39MS)	

QSP EGA CARD \$199

- On Board 256K display memory
- Compatible with IBM EGA, CGA, MDA
- 16 Colors, 640 x 350 res.
- Runs all software supporting IBM EGA card



CASPER EGA MONITOR \$420
 BUY BOTH FOR ONLY \$599

QSP TURBO XT™ \$389

- 4.77/8 MHz KB switchable
- 256K on board expandable to 640K
- 360K Floppy drive
- 150 Watt power supply
- Slide in case and AT style keyboard
- Legal ERSO BIOS
- Runs all major software



PLEASE CALL FOR PRICES
 ON OTHER CONFIGURATIONS

MODEMS: - Hayes compatible

- Internal 300/1200 BAUD w/Bitcom software, 1/2 size \$99
- Internal 2400 Baud \$235
- External 300/1200 BAUD \$99



DRIVES:

- 30MB Seagate ST 238 w/controller \$475
- 20MB Seagate full ht for AT \$495
- 30MB Seagate full ht for AT \$615
- 40MB Seagate full ht for AT \$679
- 20MB Seagate 1/2ht w/controller \$375
- 360K Teac floppy drive \$79
- 1.2 MB Teac floppy drive \$125
- 20MB cassette back up \$550
- 60MB streaming tape back up \$725

MONITORS:

- Casper 12" mono w/swivel base \$89
- Tatung 12" mono (IBM quality) \$99
- RGB color monitor \$285

SPECIALS:

- Mini I/O for XT/AT \$59
- Floppy Controller 2/4 dr. \$29/34
- 150 watt power supply 110/220v \$49
- 200 watt power supply 110/220v \$95
- XT slide-in case w/speaker \$38
- AT slide-in case \$85
- PC DOS 3.2 \$80
- MS DOS 3.2 + GW BASIC \$80
- Monographic card w/printer port \$55
- Monographic w/printer port-132 columns\$99
- Memory Expansion card (to 576K) WOK\$129
- Logimouse w/software \$89

NEW PRODUCTS!!

SPEED CARD 286 Change Your PC/XT to an AT™!

- 80286/8088 Microprocessor switch selectable (80287 opt.)
- 8K cache memory • Half size
- 7.5 times faster than PC/XT
- 8 MHz clock speed



SUNTEK MONOPAK XT/AT™ \$105



- Hercules compatible
 - Monographics + mini I/O all in one slot
- SUNTEK 3MB DOALL MULTIFUNCTION CARD FOR AT/XT\$210
- Lotus/Intel/Microsoft EMS
 - Parallel, Serial, Game Ports
 - Clock Calendar (XT)

ARCLAN-Local and Area Network Controller Board. \$275

- Based on Datapoint's ARCNET Modified Token Passing Protocol
- Fully NOVELL, VIANET software compatible
- 2.5 megabit data transfer rate
- Up to 255 nodes per network
- 4 mile maximum node separation



SUNTEK MEMOPLUS XT/AT™ WITH DR \$99/109 WITH 2MB \$289/299



- 2MB (120NS 256K DRam) Lotus/Intel/Microsoft EMS
- Compatible w/3.2 version
- Software includes EMS driver, RDISK, Spool utilities



SALES: (408) 435-8222
 Technical Support (415) 657-1410, 780 Montague Expy. Ste. 207 San Jose, CA 95131

OFFICE HOURS:
 M-F - 8:00-5:00 PM
 SAT - 9:00-5:00 PM

No Surcharge for MasterCard or VISA. Fortune 1000 Purchase Order Mailing Order and Corporate Inquiries Welcome. All Intel, IBM and Hercules are a registered trademark of their respective companies. PC AT PC XT PC AT 286 are trademarks of IBM Corporation.

First, I assume that the RAM is checked for by writing to those locations and reading back to verify. Is the original data replaced (i.e., does it do a read before the first write and, if RAM exists, replace the data)? I'm wondering about recoverable RAM disks surviving the AutoConfig. Second, what is the "legality" of using this address space for RAM? If I build myself a 1.5-Mb card to sit on the expansion bus, am I going to run into any problems down the road with someone else's product wanting this address space? How about my RAM getting along with Auto-Configured RAM and other devices?

Oh, why does 1.2 AutoConfig this space? Was it really intended for RAM?

amiga/hardware #1129, from grr, Wed Feb 18 02:52:27 1987. A comment to message 1128.

Actually, it works the other way - it starts at C0 and scans upwards until it sniffs at something that looks like the Amiga custom-chip registers.

One word every 64K or so will get popped, so unless your RRD expects this, you're out of luck.

The exact intent of this RAM allocation is no longer clear. It does provide a non-Auto-Config expansion, so perhaps the original allocation predates a final Auto-Config proposal.

The rub is that it overlays the area allocated to the custom-chip registers. The worst case timings involved give no slack for decoding and asserting OVR to inhibit the custom-chip cycles. Boards with built-in expansion RAM decode the C0-D8 space explicitly and are spared this problem.

The Auto-Config stuff is really not that complicated; you might want to consider it, rather than making something potentially flakey.

amiga/hardware #1132, from jsan (Jez San), Wed Feb 18 07:51:44 1987. A comment to message 1129.

Rather than losing one word every 64K, why not save the word that was there before you test that it's valid RAM, and then restore its contents so the RRDs don't get choked!

amiga/hardware #1134, from jdow, Wed Feb 18 13:25:18 1987. A comment to message 1132.

Because someone didn't think of that at the time the "memory test" was designed. That's a real bummer.

amiga/hardware #1130, from jdow, Wed Feb 18 04:07:23 1987. A comment to message 1128.

Like OOPS! That is a possible BAD issue on RRDs. I may have to limit allocations to below that.

amiga/hardware #1131, from grr, Wed Feb 18 05:05:48 1987. A comment to message 1130.

Also, AmigaDOS will load itself up there instead of chewing up chip memory.

amiga/hardware #1133, from ainkel, Wed Feb 18 10:04:55 1987. A comment to message 1131.

With the current V1.2 Kickstart, one word in each 64K gets trashed if it's RAM. This will mess up an RRD. Except for ExecBase, I think (using the normal Amiga memory-allocation stuff) that memory will be used after any other fast RAM. Perry's RRD does something like allocate from the top, right? So, if he stays out of C00000, all will be well, as the test for Auto-

Config memory is nondestructive. An RRD that allocates from the bottom will tend to work anyway if you have Auto-Config fast RAM as well as C00000 RAM (you'd have to have a really large RAM disk to make it fail, anyway). Yes, it would have been nice if the C00000 memory check was nondestructive. Maybe next revision.

amiga/hardware #1135, from jdow, Wed Feb 18 13:29:32 1987. A comment to message 1133.

Er, how would you propose to allocate from the bottom without risking having the boot procedures clobber it? That sounds like a VERY risky proposition. It really sounds like the best bet is to limit the allocation algorithm to allocating from the top of the original 8-meg expansion area down. I had mine intentionally planned to limit itself to within the 24-bit standard Amiga address area because I don't want to use up a resource like 32-bit-wide turbo RAM with a RAM disk. I can easily change the test constant. I'm glad, though, that I was warned.

amiga/hardware #1136, from steveth, Wed Feb 18 22:20:45 1987. A comment to message 1133.

Wait a sec. I think that all of this RAM trashing doesn't make any difference, unless I'm mistaken. I assume that the routine that checks for extra chip RAM (\$080000-\$1FFFFFF) is the same one that checks for fast RAM (\$C00000-\$D7FFFF). Now, if this is true, then data will not be stomped. The reasoning behind this assumption is that one of the ways to fix the 512K internal modification that is located at \$080000 is to keep the RAM from being enabled until after the location has been checked for RAM. This is accomplished by monitoring the LED of DFO: . The circuit watches for a prolonged period of the LED being turned on, such as during the loading of Kickstart. After the LED goes out, the next time it comes on triggers the circuit to turn on the RAM, and the circuit locks in that mode until power-down. Finally, to the point: The circuit does not reengage on a warm boot (it wouldn't work anyway, as Kickstart isn't reloaded), and the system doesn't configure the RAM as chip RAM again. This seems to indicate that the testing for these RAM areas is NOT done on a warm boot! It would be done if you changed operating systems, as with the ChangeKick program, but I don't think anybody expects an RRD to survive THAT.

This is all coming off the top of my head, but it makes sense, doesn't it?

amiga/hardware #1137, from grr, Wed Feb 18 23:09:04 1987. A comment to message 1136.

The routine that checks for C0 RAM is specific to that purpose. It will mash a word in each increment. I think this will only happen when you reset the machine, but I'm not sure.

amiga/hardware #1140, from perry (Perry Kivolowitz), Fri Feb 20 16:43:03 1987. A comment to message 1136.

The recoverable RAM disk has been known to survive ChangeKick.

ATARI ST

The trials and tribulations of creating a program that writes IBM PC-compatible text files on a floppy disk starts out this month's Atari section. Next is a discussion of a strange bug in an early version of ST BASIC. Then, there's a thread in which BIXen discuss whether it's better to leave hard disks going all the time or to turn them off.

continued

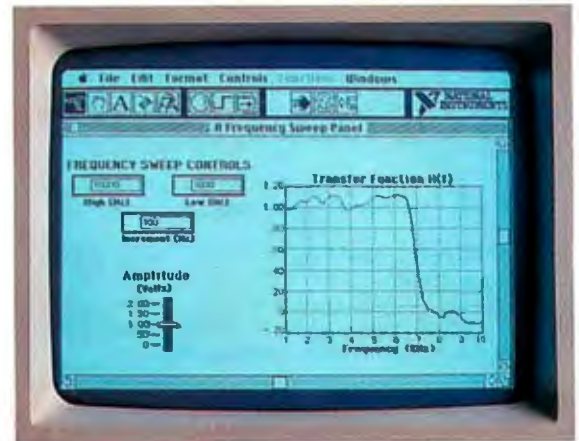
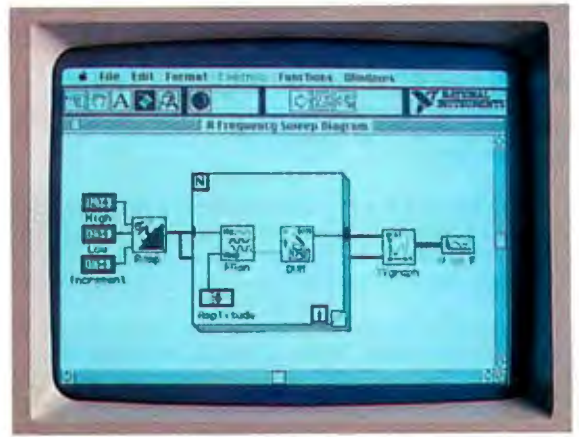

YOU CAN WRESTLE WITH A FEW THOUSAND LINES OF CODE TO PROGRAM YOUR EXPERIMENTS.

Developing scientific experiments takes creativity. Writing code to run them takes sweat. At least it used to. But no longer. Because we've just solved the scientific and engineering programming problem.

OR YOU CAN USE LabVIEW.

Picture the perfect programming language. Imagine software where diagrams are really executable programs.

Imagine running experiments and simulations through front panels that look and act just like instruments. On screen!

Imagine reusable software modules that can control your instruments, *in any application*. Programs for data acquisition, data reduction, signal processing, analysis, conversion, and display.

Imagine a programming environment so powerful that productivity is measured in **hours** instead of days.

The Macintosh made it possible. LabVIEW made it happen. Automated testing, measurement, and simulation has never been easier or faster.

Call for details. 800/531-4742.

DESKTOP ENGINEERING HAS ARRIVED.



12109 Technology Blvd.
Austin, TX 78727
800/531-4742 512/250-9119

CREATING IBM PC-COMPATIBLE TEXT FILES

atari.st/questions #868, from mhadley (Michael Hadley), Sun Feb 1 05:22:20 1987.

Question: I am new here and I'm trying to write a fairly simple program, a short routine in assembler that allows me to use a 5 1/4-inch disk drive with a 6-millisecond step rate to create IBM text files. I am using a 1040ST and an M.C.C. Macro Assembler.

I know I need to be in the supervisor mode to write to the protected memory (to change Seekrate (\$0440) or to insert the routine into the VBL queue (\$04CE++), but when I use any of the routines in GEM, BIOS, or the XBIOS, I get bombs. The locations in protected memory remain unaffected in spite of all my efforts to change them.

Here are a few questions for discussion:

- 1) What am I missing in all this information? This problem really has me bugged because I cannot get into the supervisor mode, no matter what I have tried so far.
- 2) Is there a SURE way to get into the supervisor mode (and out as well) that is not documented (apparently in error)?
- 3) Has someone already hacked this problem and is the solution available to us mortals?

atari.st/questions #869, from tskinner (Thomas Skinner), Sun Feb 1 14:30:00 1987. A comment to message 868.

I have used the GEMDOS Super function 0x20 with no problems. Are you using this or the BIOS call? It is difficult to know what

you are doing wrong without seeing your code. The GEMDOS call is a bit tricky to use so read about it carefully. How many bombs are you getting? That tells you what the exception was.

atari.st/questions #870, from jittsler (Jim Tittsler, Atari Corp.), Sun Feb 1 16:50:55 1987. A comment to message 868.

It should also be pointed out that just changing Seekrate (\$0440) is NOT enough to change the CURRENT floppy seek rate.

David Small suggested one way of changing the seek rate in atari.st/questions #767, but you should be aware that since he is using undocumented variables there is an EXCELLENT chance that this scheme will not work with future versions of TOS.

atari.st/questions #872, from dsmall (David Small), Mon Feb 2 22:27:08 1987. A comment to message 870.

"Using undocumented variables" is really an apt way to describe my life history. . . .heh.

Try setting \$A08.W and \$A0C.W to \$00 from \$03; that will slow down the seek rate. Basically, the seek rate in lowmemory is ignored after a disk is initialized (at system start-up).

While this may seem to be dodging the question, those two locations are not in protected RAM; hence, no problems.

PROBLEMS WITH EARLY BASICS

atari.st/questions #877, from dbetz (David Betz, BIX), 708 chars, Thu Feb 5 10:23:20 1987.

continued

NEW RELEASE

3 MEGA BYTE AT-286 SYSTEM

W/"PARADISE" COMPATIBLE EGA CARD

NEW RELEASE

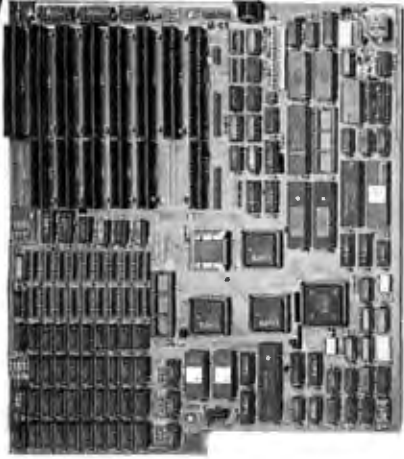

← TURBO AT-286 w/3MF Motherboard

- 80286 CPU
- 6, 8, 10 MHz (0 Wait State)
- Phoenix BIOS
- On Board Rechargeable Battery
- On Board Serial/Parallel/Game Port
- 3MB Memory Capacity On Board
- 80287 Socket Ready
- Chip Technology VLSI Chip Set

TURBO AT-286 System →

- 80286 CPU
- Phoenix BIOS
- 640K On Board Up To 3 MB
- Slide in Case w/220W Power Supply
- 6/8, 6/10 Dual Speed (0 Wait State) (Keyboard Selectable)
- 1.2 MB or 360K Floppy Drive
- Western Digital WA-2 Controller
- AT Type Keyboard
- Hardware Reset Ready
- Serial/Parallel/Game Port



WAYTRON INT'L, INC.
 (Manufactured for WiseTEK)
 513 Valley Way
 Milpitas, CA 95035
 TEL: (408) 263-1237
 FAX: (408) 263-1870

We also have TURBO XT (4 LAYER), MINI AT (XT Size)
**Distributors, Dealers, Education,
 Corporation, VAR, OEM Welcome**

AT and XT are the registered trademark of International Business Machines.

MICRONIC INT'L CORP.
 108 E. 16th Street
 New York, NY 10003
 TEL: (212) 529-4699
 FAX: (212) 529-9926

SPRING COMDEX BOOTH #4925

THE ULTIMATE REFERENCE FOR THE ULTIMATE SPREADSHEET

- Provides 892 pages of detailed Lotus® 1-2-3® information packed into one handy desktop reference.

- Covers every command, function, and procedure for 1-2-3® Release 1A and Release 2.

- ▶ Includes special coupons offering substantial savings on many popular add-on products, including Reflex™, Sideways,™ and Note-It.™



NEW from Osborne/McGraw-Hill

1-2-3®: THE COMPLETE REFERENCE

BY MARY CAMPBELL

Columnist for IBM® PC Update, Absolute Reference, and CPA Journal

Here's an essential reference for both 1-2-3 beginners and seasoned pros!

All 1-2-3 commands, functions, and procedures are thoroughly explained and demonstrated in "real-world" business applications. You'll learn practical techniques as well as time-saving 1-2-3® tricks.

And you can quickly pinpoint the answers you need because this book is clearly organized by task. *1-2-3®: The Complete Reference* has all the details on:

- Printing
- Macros
- Graphics
- Data Management
- Extending 1-2-3 with Report Writer™ and other software
- And much, much more.

1-2-3®: The Complete Reference... Undoubtedly indispensable for 1-2-3 computing.

\$22.95, A Quality Paperback, ISBN # 0-07-881005-1, 892 Pages

Other titles in *The Complete Reference* series include:

- dBASE III PLUS™: The Complete Reference
- DOS: The Complete Reference
- C: The Complete Reference

AVAILABLE at bookstores and computers stores EVERYWHERE.

Or Call Osborne/McGraw-Hill Toll-Free at 800-227-0900. In California Call 800-772-2531.

(Available in Canada through McGraw-Hill Ryerson, Ltd., Scarborough, Ontario, Phone: 416-293-1911.)



Osborne McGraw-Hill
2600 Tenth Street, Berkeley, CA 94710

Eric Jensen, the guy who wrote the BYTE review of the 520ST, gave me a call the other day and reported a rather strange problem that someone reported to him. It seems that there are some *very* strange bugs in ST BASIC. His example was this:

```
x=18.89
```

He said (and I didn't verify this because I don't use BASIC myself) that this resulted in a strange error message having nothing to do with the assignment statement itself, something like "unimplemented function." He further said that multiples of the magic value on the right (18.89) would cause similar but different strange error messages. Can anyone else verify this problem and is there a solution?

atari.st/questions #878, from jimomura (Jim Omura), Thu Feb 5 10:38:46 1987. A comment to message 877.

I've confirmed that x=18.89 yields the error report. Where x=18.89, you can use x=x/100 and have 18.89 properly stored. Interesting though.

atari.st/questions #926, from neilharris (Neil Harris, Atari Corp.), Sat Feb 21 12:00:31 1987. A comment to message 877.

The numeric accuracy of the original ST BASIC leaves something to be desired. The new version, written to our spec by Metacomco, is one bug away from release, and performs much better this way.

atari.st/questions #931, from dbetz, Sat Feb 21 12:07:50 1987. A comment to message 926.

This wasn't really a problem with numeric accuracy. The messages indicated that BASIC got *very* confused while doing a simple assignment. Will the new version fix these problems also?

atari.st/questions #932, from neilharris, Sat Feb 21 12:14:31 1987. A comment to message 931.

Well, I just tried x=18.89 in the new BASIC and it works fine.

atari.st/questions #933, from dbetz, Sat Feb 21 12:18:44 1987. A comment to message 932.

Thanks for checking it out, Neil. I'll pass the information on to Eric Jensen.

atari.st/questions #936, from sprung (Ron Sprunger), Sun Feb 22 00:21:21 1987. A comment to message 926.

Neil, have you tested the new BASIC from a shell? The old one didn't close its windows, so was unusable from a shell.

atari.st/questions #938, from neilharris, Sun Feb 22 01:25:37 1987. A comment to message 936.

I don't use a shell as a rule. But I do have the Mark Williams shell on the disk. Will check it out.

```
(. . . he quickly exits Flash, executes MSH, and runs
BASIC. . . )
```

Everything worked fine, more or less. A bit sloppy-looking, there was an extra cursor when I ran BASIC, and some garbage left in the background, and when I quit BASIC I had a bunch of green on top of the screen, but it did work OK. Is that what you needed to know?

atari.st/questions #944, from sprung, Sun Feb 22 18:02:26 1987. A comment to message 938.

Actually, what matters is whether it works from the shell several times in succession, without the desktop being visited in the meantime. The desktop has some means of reclaiming windows, which I for one have been unable to duplicate. I can run BASIC or Logo or 1stWord from my shell once, but if I try to enter them a second time, that's all she wrote.

atari.st/questions #946, from neilharris, Sun Feb 22 19:46:48 1987. A comment to message 944.

I did go back and forth to BASIC from the shell several times. No problem.

HARD DISK TIPS

atari.st/questions #892, from jimomura, Fri Feb 13 22:06:39 1987.

What's the current wisdom in hard disk usage? If I use a computer often during the day and daily, is it better to park the head sometimes (say for breaks of 4 hours or longer) or is it better to keep it going? What's the point at which shutting down is better (or is it always better)?

atari.st/questions #895, from mlavelle (Mark Lavelle), Sat Feb 14 02:40:44 1987. A comment to message 894.

Parking certainly can't hurt (especially if you live in earthquake country), except to slow down your first access after the park. Shutting down is a tougher call. Mechanically speaking, it might be better sometimes, but the chips don't live as long if they get cycled a lot. Of course, the chips don't like line spikes either.

atari.st/questions #898, from jimomura, Sat Feb 14 10:04:33 1987. A comment to message 895.

I should also ask how bad it is to power down the drive without parking. That happened the other day due to a power failure.

Traditionally, the argument against stopping a hard disk at all is that head-crashing usually occurs on powering up. I've heard that a lot has been done about this, but I haven't followed the technology closely. I know that in some large commercial-quality disks, sufficient energy is stored to park the head on any unconventional power-down. I don't know if this is on all disks or just some. I presume that those disks automatically park. I guess I can presume that these disks don't (or you wouldn't need a "parkhead" utility). Leaving a disk running, of course, wears down the bearings in the drives and in time will wear down the capacitors in the power supply.

Also, is there any automatic head-cleaning system in these sealed drives to take off particle build-up that results from head crashes?

atari.st/questions #899, from heller (Robert Heller), Sat Feb 14 12:41:35 1987. A comment to message 898.

I know that *old* (open pack and cart) drives have a spring or magnetic arrangement, which retracks the heads on power- or spin-down. I think that the newer/larger hard disks have some similar hack.

Head crashes with Winchester drives: Usually the head/media section is a total loss. Could be rebuilt (i.e., at a factory), but usually those parts are junked. On *little* 5 1/4-inch jobs, it usually means replacing the whole drive. With bigger

continued

EGAWONDER™

Any Software. Any Monitor. Any Time.



Any Software on
an EGA Monitor



Any Software on a
TTL Monochrome Monitor



Any Software on an RGB
Color Monitor³
(or Composite, IBM Portable)

Upgrade to EGA without an EGA Monitor

The unique ATI EGA WONDER allows upgrade to the new EGA graphics standard without the purchase of an expensive EGA monitor. EGA WONDER runs EGA, CGA, MDA, Hercules and 132 column software on EGA Color, RGB Color, TTL Monochrome and Composite monitors. Extremely flexible, EGA WONDER maintains downward compatibility to both existing software and existing monitors. On the internal monitor of a Compaq PC Portable, EGA WONDER displays EGA, CGA, MDA and Hercules software via an optional expansion module.¹ For EGA monitor users, the ATI EGA WONDER improves the display of CGA software by producing high resolution 8x14 text and double scanned graphics. Old CGA software

is now displayed with EGA quality. Completely compatible to IBM's EGA, ATI's EGA WONDER performs smooth scrolling, pixel panning and windowing. No memory modules are required because 256K of video memory is a standard feature. EGA WONDER is the only card able to display EGA software on the internal monitor of both the IBM PC Portable and the Compaq PC Portable. EGA WONDER provides an NTSC Composite signal for interface to a Polaroid Palette.

SoftSense Automatic Mode Switching

User friendly and easy to use, the ATI EGA WONDER has built-in SoftSense Automatic Mode Switching. It is actually able to sense and automatically switch between EGA and CGA color modes or between EGA, MDA and Hercules monochrome modes. The ATI EGA WONDER is compatible at the hardware level to the IBM Enhanced Graphics Adapter, the IBM Color/Graphics Adapter, the IBM Monochrome Display Adapter and the Hercules Graphics Card to minimize software incompatibilities.

EGA WONDER is now available from all major computer stores, call us today at (416) 477-8804 for more information.

\$399
Suggested
list price

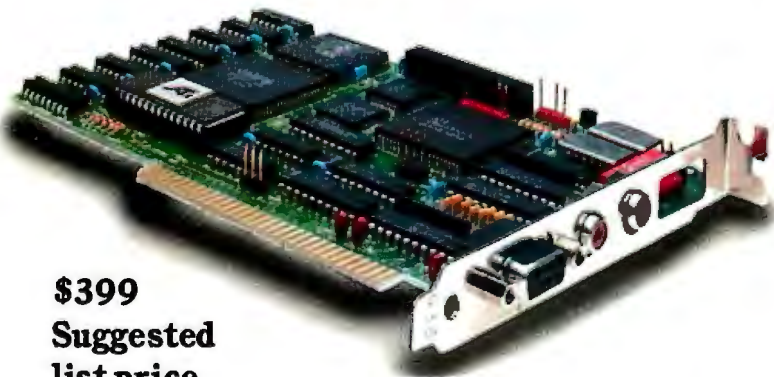

Trademarks IBM PC Portable—EGA—CGA—MDA—International Business Machines—Compaq—Compaq Computer Corporation—Hercules—Hercules Computer Technology—Polaroid Palette—Polaroid Corporation. Graphics courtesy Rix Softworks Inc.

1. Any Software, Any Monitor, Any Time applies to IBM graphics, standards, monitors, software.
2. Optional Compaq Expansion Module, (available for internal portable dual-mode monitor no 132 Columns) Suggested list price \$99.
3. EGA, MDA, Hercules software displayed via interlacing. Flickering effect of interlacing reduced with purchase of anti-glare screen filter.

Inquiry 31



Technology you can Trust.

ATI Technologies Inc., 450 Esna Park Dr.,
Markham, Ontario, Canada L3R 1H5. TLX. 06-966640.

Increase Your Profit Margin!

TAIWAN

LOW PRICE!
HIGH QUALITY!

MANUFACTURER DIRECT

BABY 286 TURBO™ SYSTEM
SUPERCHARGED SPEED - 12 MHz AT™
— The fastest IBM™ AT™ Compatible —

FEATURES:

- Intel 80286-8/80286-10 microprocessor
- 6/8 or 6/12 MHz switchable clock speed
- Expandable to 1MB on board
- Chips & Technology VLSI chipset
- CMOS memory to maintain system configuration
- Legal BIOS with set up software
- Clock/calendar with battery back up
- 8 I/O slot - 6 w/62 - & 36-pin card-edge connectors - 2 w/only 62-pin card-edge connectors
- UL approved 180W power supply (220V-110V)
- XT size case w/keylock protection, reset switch & LED's for Turbo, hard drive, power on/off
- Enhanced keyboard w/separate cursor, keypad and cross top function keys
- 20% smaller than IBM AT system



**BABY 286
MOTHER BOARD
6/12 MHz**

Mega 4000 TURBO™ SYSTEM

— IBM PC/XT™ Compatible —
RUN 3 TIMES FASTER
"FCC CLASS B APPROVED"

FEATURES:

- 8088-2 microprocessor w/8087 coprocessor optional
- Keyboard selectable 4.77-8 MHz Turbo speed
- 4 layer mother board, expandable to 640K
- Legal BIOS
- 150W power supply
- AT™ style case w/keylock protection, reset switch, LED's for Turbo, hard drive, power on/off
- AT™ style keyboard



FCC APPROVED ADD-ONS

- DISK I/O CARD
- TURBO MONO. GRAPHICS PRINTER CARD
- ENHANCED GRAPHICS ADAPTOR
- AT SERIAL/PARALLEL GAME ADAPTOR
- COLOR GRAPHICS CARD

180W/200W POWER SUPPLY

- For XT™ and AT™
- UL Approved
- 4 Drive Plugs
- Same Dimension as XT™ Power Supply
- +12V 8A - 12V 0.5A
- +5V 20A - 5V 0.5A



Infotronics Corp.

ORDER HOTLINE: 011-886-2-9189798 (8 Lines)
FAX: 011-866-2-9176201, TLX: 29718 HUA SUI CO

FACTORY & OFFICE ADDRESS:
3F NO. 4, Alley 1, Lane Sze Wei, Chung Cheng Rd.
Shin Tien, Taipei 23136, Taiwan, R.O.C.

MAILING ADDRESS:
PO BOX 10102 Shin Tien, Taipei 23102, Taiwan, ROC
CONTACT OUR U.S. SHOW ROOM
TEL: (714) 895-3900, FAX: (724) 897-9173, TLX: 3720117
FOR INFORMATION & QUOTATION

• BEST OF BIX • **BIX** • BEST OF BIX • BEST

Winchesters (like DEC RA81s) you have to replace the main inner unit (sort of like a rebuild on-site).

Power cycling probably does at least as much harm as continuous running. The chips don't like the power coming and going and the drive motor has to work harder getting the disk up to speed vs. bearing wear, etc. Six of one, half a dozen of the other. I have not noticed severe problems with not parking the heads on little hard disks. It is only a problem if you plan to move the machine around. I always park the heads when I shut down my system. Of course, power failures cause it to be shut down without parking the heads.

atari.st/questions #904, from jtittsler, Sun Feb 15 17:38:15 1987. A comment to message 898.

The only time I park the heads of my hard disk drives is when I am planning on moving them somewhere (and I confess if it is just office-to-office, I don't even bother there). They seem to be pretty rugged.

As for cycling the power, I would guess that it could be a wash. I have one that gets cycled with the business day, and one at home that is on all the time for amateur radio purposes and haven't (yet) noticed any difference in this small sample size. I think most drive manufacturers do put some specification on spindle hours, so if you aren't using it, you might as well turn it off.

atari.st/questions #907, from jim_kent (Jim Kent), Mon Feb 16 02:03:03 1987. A comment to message 904.

Besides, if it's in the bedroom, the fan will keep you up all night.

atari.st/questions #905, from sprung, Sun Feb 15 23:09:14 1987. A comment to message 898.

I've got a dozen or so different hard drives, from 5 to 400 megabytes, most of which run 24 hours a day, 365 days a year. In the last five years, I've had zero disk failures. Because of having to move it around a lot, I parked my Supra 20 for the ST every day for about four months and packed it back and forth in a backpack. Likewise no problems. My brother swears it's better for the electronics to leave them running, so that's generally what I do. In my office at home, leaving three or four computers and drives and printers running all the time makes a lot of heat, so lately I've taken to shutting them down selectively. Hard to see that it makes much difference. I would sure never shut one down for a few hours - more like a few weeks.

IBM PC and Compatibles

We continue this month's Best of BIX with two threads from the IBM PC section. The first investigates the possible causes of a vexing intermittent error message in the system of Doug Webster, BIX's director of business and marketing. The final thread is a very long one that'll tell you everything you need to know about the index holes on floppy disks. This thread evolves into a discussion of where to get basic information on computer systems.

POSSIBLE CAUSES FOR PARITY ERRORS

ibm.pc/hardware #2288, from dweb (Doug Webster, BIX), Tue Feb 10 17:23:56 1987.

I've twice had something occur recently and can't figure out

where it is coming from. I've got a PC with an internal hard disk and an add-on board that brings internal memory to 640K. Straight memory; no other razzmatazz on that board.

On at least two occasions, I've had XyWrite loaded up (no text file loaded, just Xy), and looked up to find the screen suddenly blank and a message reading Parity Check 1 in very large letters at the top of the screen. The ruler bar for XyWrite was gone and the screen was blank other than this message. I've had it happen on another occasion with a Parity Check 2 message.

I don't know what is generating the message. The system is locked at that point and good old Ctl-Alt-Del won't work. I have to power down and reboot. Then things work fine again. Anybody have any ideas? Is a chip going bad on the memory board?

ibm.pc/hardware #2290, from kquirk (Kent Quirk), Tue Feb 10 17:28:59 1987. A comment to message 2288.

Sounds to me like you've got a failing (not failed) memory chip. That's in the IBM BIOS, and it happens whenever the system detects a parity error. A couple of suggestions:

1) Do you have the switches set so that you don't do a memory test every time you boot up? Or so that you have more memory than the switches know about?

2) Run the diagnostics; let the system beat on the memory for a while. I mean the disk-based diagnostics. If you get a failure, that'll tell you which chip to replace. If you don't get a failure, well, back up a lot.

ibm.pc/hardware #2292, from dweb, Tue Feb 10 17:36:19 1987. A comment to message 2290.

One, the system is doing a memory test each cold boot-up because it pauses for a fair spell after power-on before booting in DOS from the hard disk. There are no indications of problems at that point. The switches were set per installation instructions to alert the PC to the memory now on-board. From installation until recently there had been no problems.

ibm.pc/hardware #2293, from kquirk, Tue Feb 10 17:43:12 1987. A comment to message 2292.

I still think that you should just run the diagnostics for a while. If it's a temperature-related problem, then you might be happy for a bit before failing, and power-up self-tests won't catch it. Also, it sounds intermittent.

I had a problem like this once, ran the diagnostics overnight, and woke up to find an error message on the printer. I replaced that chip, and it never happened again. Now that I think about it, I think I only removed it and reinserted it. Try that.

ibm.pc/hardware #2297, from cdanderson (C. David Anderson), Tue Feb 10 20:46:40 1987. A comment to message 2292.

You might also try pushing the memory chips into their sockets - sometimes they work out a bit over time (especially if you don't leave your machine on all the time) and, I think, this tends to make the connections flakey. Or, even take them completely out and replace them.

continued

CMOS Little Board™/PC

Ideally suited for embedded microcomputer applications where IBM® PC software and bus compatibility are required and low power, small size, and high reliability are critical.

- File servers
- Diskless workstations
- Portable instruments
- Remote data logging
- Protocol conversion
- Point-of-sale terminals
- Telecommunications
- Industrial process control
- Distributed processing
- Harsh environments

BOOTS PC-DOS/MS DOS

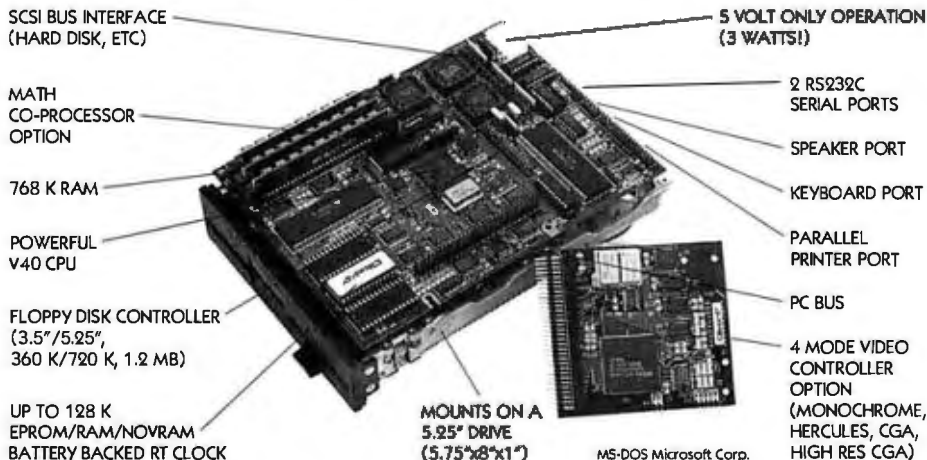

67 East Evelyn Avenue • Post Office Box 390427, Mountain View, CA 94039 • (415) 962-0230 • TLX 4940302

Distributors • **Argentina:** Factorial, S.A. 41-0018 • **Australia:** Current Solutions (03) 277-5959 • **Belgium:** Centre Electronique Lempereur (041) 23-45-41 • **Brazil:** Computadores Compuleader (41) 262-4866 • **Canada:** Tri-M (604) 438-0028 • **Denmark:** Danbit (03) 66 20 20 • **Finland:** Symmetric OY 358-0-585-322 • **France:** Egal Plus (1) 4502-1800 • **Germany, West:** IST-Elektronik Vertriebes GmbH 089-611-6151 • **Israel:** Alpha Terminals, Ltd. (03) 49-16-95 • **Spain:** Hardware & Software 204-2099 • **Sweden:** AB Akta (08) 54-20-20 • **UK:** Ambar Systems Ltd. 0296 43551 • **USA:** Contact Ampro

ibm.pc/hardware #2295, from skluger (Sigi Kluger), Tue Feb 10 19:02:07 1987. A comment to message 2288.

Bus contention. Your add-on board could be violating memory-access specs and overlapping with a main-memory access. I'm sure there are other possibilities, too. . .

ibm.pc/hardware #2304, from dweb, Wed Feb 11 08:36:11 1987. A comment to message 2295.

I doubt that, because I've had the extra memory in place for several months and have been using this XyWrite package even longer. I have only recently had the troubles described.

ibm.pc/hardware #2296, from brewster (Brewster McPherson), Tue Feb 10 19:56:03 1987. A comment to message 2288.

What else do you have hooked into the same power circuit? I've had an experience with Parity Check 1 before and tracked it down to a power problem. Where the IBM PC was stationed there was a photocopier on the same circuit as well as one of those library gizmos that lets you take a book out, as well as some other assorted stuff. Whenever the photocopier went on, the machine would drop out with a Parity Check 1. We eventually solved the problem by putting a surge sentry/line filter unit on the line, and it worked beautifully after that.

DISK INDEX HOLES

ibm.pc/drives #963, from hans (Hans Bottjer), Thu Jan 29 16:52:23 1987.

Somebody asked me what the little hole next to the central hub on a disk is for. I told him it was the index hole, but I'm not sure what it's used for other than giving the disk drive itself an idea where on the disk the heads were. We cut another hole, just opposite the original one and the disk was "Not Ready. . . ," etc. I covered the original hole and the disk worked fine. What does that hole do?

ibm.pc/drives #964, from bbrown (Bob Brown), Thu Jan 29 18:26:05 1987. A comment to message 963.

A light and photo detector are on either side of the hole. When the photo detector sees the light, sector 0 is just coming under the heads. That's how the drive and controller know where sector 0 is. They find the rest by counting from the first one.

ibm.pc/drives #965, from mhaas (Mark Haas), Thu Jan 29 19:40:28 1987. A comment to message 964.

Just to amplify a bit, the single index hole is found on what are called "soft-sectored" disks. As Bob points out, it is sensed by an optical sensor, which in turn signals the computer that sector 0 is about under the read/write head of the drive. Each sector is defined on the disk by certain data bytes written to the disk during formatting, and once the first sector (0) is located by the index hole, the rest are counted off.

There is also such a thing as "hard-sectored" disks where you would see a bunch of holes around the hub. In this case, each one marks the start of a new sector.

ibm.pc/drives #966, from bbrown, Thu Jan 29 21:44:36 1987. A comment to message 965.

I started to include "hard-sectored" in my message, but I realized that I haven't a clue how the controller figures out *which* hard sector is 0. That has to be, er, hard.

ibm.pc/drives #967, from skluger, Thu Jan 29 21:54:12 1987. A comment to message 966.

A hard-sectored disk has $n + 1$ holes, the sector 0 hole being halfway between two index holes. I was using 10- and 16-sector disks on North Star and Vector equipment.

ibm.pc/drives #971, from mhaas, Fri Jan 30 02:28:27 1987. A comment to message 967.

Thanks, Sigi. I'll be able to sleep tonight. :-)

ibm.pc/drives #970, from mhaas, Fri Jan 30 02:26:25 1987. A comment to message 966.

>haven't a clue how the controller figures out *which* hard sector is 0.

Neither do I, but I managed to write around that point. :-)

ibm.pc/drives #973, from hans, Fri Jan 30 09:39:07 1987. A comment to message 966.

More of a comment on 964, but to keep the stream going. . .

Why did the disk work when I cut a new hole in the disk? It wasn't even near sector 0, but the disk still read and wrote information off the disk properly. I know the disk needs some kind of reference point, but I don't think the disk should still work with a "bogus" hole in it.

Somethin' just ain't workin' right here.

ibm.pc/drives #974, from dmick (Dan Mick), Fri Jan 30 19:52:10 1987. A comment to message 973.

Did you cut a new hole in the brown oxide-covered disk or the sleeve? If the former, I'd say you were lucky. If the latter, the sensor wouldn't be looking at the right spot to be confused by the new hole. But perhaps the disk stopped on sector 0 (I've seen 'em do that) and it was the right hole, or the first hole it encountered was the right hole. Tricky business, anyway.

Could be that it must be at a certain place compared to the sync marks, too, and that any "fake" hole indications won't screw it up. Bet if you reformatted it'd be unusable.

ibm.pc/drives #984, from hans, Mon Feb 2 09:25:57 1987. A comment to message 974.

Well, I cut the new hole in the disk itself, using the hole on the sleeve as a guide. I then covered up the old one with a piece of a write-protect tab.

Worst thing is, I *did* try and reformat it and it still works (although I don't plan on using it for much all the same).

ibm.pc/drives #985, from mhaas, Mon Feb 2 12:21:02 1987. A comment to message 984.

Oh. If you covered up the old hole, so there was still only one hole, then that explains why it still works. If you kept both holes, it should get the computer confused.

ibm.pc/drives #986, from hans, Mon Feb 2 14:30:44 1987. A comment to message 985.

Ah, but doesn't the hole tell the drive where sector 0 is? Unless the sectors go out from the inside of the disk, that hole should be in sector 4 or something. It did get messed up with both holes open.

continued

Increase your knowledge about all aspects of computers

An absolutely no-risk guarantee.

Select 5 Books for only \$3⁹⁵

More programs, projects, and ways to use your micro.
Keep well-informed about the latest books available—and get the *original publishers' editions* at a discount of up to 50% off the publisher's price!



2798 \$26.95

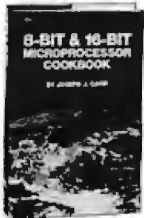

1643 \$19.95



2736 \$25.00



1894 \$22.95



2754 \$28.95
Counts as 2



1852 \$21.95

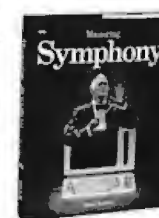

1948 \$22.95



2850 \$25.95



1899 \$24.95



2687 \$26.95



2685 \$27.50
Counts as 2



1990 \$24.95

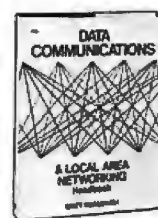

2603 \$25.00

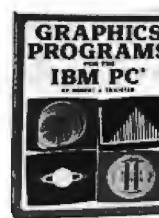

1556P \$15.50



2843 \$28.95
Counts as 2



2872 \$19.95



2620 \$25.95

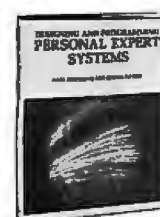

2692 \$27.95
Counts as 2



2748 \$21.95



1939P \$17.95



2710 \$27.95



2615 \$21.95

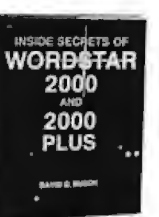

1993 \$21.95



2690 \$24.95

(Publishers' Prices Shown)



2650 \$21.95

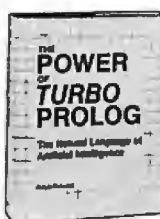

2782 \$22.95



1976P \$17.95



2600 \$28.95
Counts as 2



2757 \$24.95



2855 \$24.95

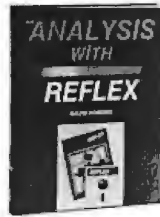

2749 \$22.95

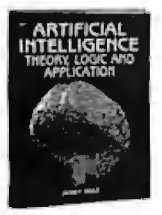

2671 \$18.95



2771 \$25.95



2749 \$22.95



The Computer Book Club®

P.O. Box 80, Blue Ridge Summit, PA 17214

Please accept my membership in The Computer Book Club® and send the 5 volumes circled below, billing me \$3.95 plus shipping and handling charges. If not satisfied, I may return the books within ten days without obligation and have my membership canceled. I agree to purchase at least 3 books at regular Club prices (plus shipping/handling) during the next 12 months, and may resign any time thereafter.

1556P 1643 1852 1894 1899 1939P 1948 1976P 1990 1993 2600
2603 2615 2620 2650 2671 2685 2687 2690 2692 2710 2712 2736
2748 2749 2754 2757 2771 2782 2798 2843 2850 2855 2872

Name _____

Address _____

City _____

State/Zip _____ Phone _____

Valid for new members only. Foreign applicants will receive special ordering instructions. Canada must remit in U.S. currency. This order subject to acceptance by The Computer Book Club® BY-587

© 1987 The Computer Book Club®, Blue Ridge Summit, PA 17214
All books are hardcover editions unless numbers are followed by a P for paperback.

I should mention that reformatting gave me some bad sectors on the disk.

ibm.pc/drives #987, from drifkind (David Rifkind), Mon Feb 2 15:09:04 1987. A comment to message 986.

The index hole has two functions. When formatting, it tells the drive where to start the track. When reading and writing, it is used to detect missing sectors. If the drive sees the index hole twice without finding the sector it's trying to read/write, it reports an error. The drive doesn't care about where the start of the track is when read/writing, just about whether the sector you're looking for is there or not.

DOS does not give up so easily, though. If an error is reported while it's trying to read or write the disk, it will try again several times. With an extra index hole, finding the sector before seeing two index marks go by depends on just where the disk is in its rotation when the operation begins, so chances are that one of those retries will succeed. A note to programmers: INT 13h does not do those retries, but INT 25h and 26h do. If you're trying to imitate DOS's disk access, use those services or you might end up reporting errors on a disk that DOS thinks is just fine.

ibm.pc/drives #988, from dweb, Mon Feb 2 16:57:55 1987. A comment to message 985.

However, let us suppose that he formatted the disk using the original disk with its original reference hole and then recorded some files on it. If he then put a new hole on the disk and covered the old one, wouldn't he find it impossible to locate those files again, since the files would then be offset from a newly created reference point and the drive wouldn't know where things started? If he reformatted everything after creating the new hole and covering the old one, then the format would correctly reference only the one hole, from wherever it started things on the disk.

ibm.pc/drives #989, from geary (Michael Geary), Mon Feb 2 23:14:06 1987. A comment to message 988.

No, once the disk is formatted, the sectors are self-identifying. As David said, the drive just cares that it finds the sector it wants sometime before it sees the index hole twice. It doesn't care where the sector is in relation to the index hole.

ibm.pc/drives #990, from hans, Tue Feb 3 15:45:12 1987. A comment to message 989.

Ah HAH! That sounds like a very reasonable explanation. I think this got into a little bit more detail than my friend expected, but *I* still appreciate the effort.

ibm.pc/drives #978, from drifkind, Sat Jan 31 14:40:05 1987. A comment to message 973.

MS-DOS retries failed-disk operations, usually four or five times. Depending on the location of your "extra" index hole, I would expect the low-level operation to fail about one time out of four. Depending on timing, you might never see an error message, but disk operations are probably quite a bit slower on that disk. If you use INT 13h to access the disk, you'll see a lot more failures.

ibm.pc/drives #968, from nickbaran (Nick Baran), Thu Jan 29 23:33:57 1987. A comment to message 964.

Just curious, but where did you learn that? Are there books available that describe disk drive technology?

ibm.pc/drives #969, from bbrown, Thu Jan 29 23:39:16 1987. A comment to message 968.

Beats me! But I have a long white beard and can describe the inner workings of pre-WWII biquinary relay calculators. I suspect that any of the "This is a Computer" books will do. If you have specific questions, ask in the appropriate topic on BIX.

ibm.pc/drives #980, from nickbaran, Sun Feb 1 01:21:30 1987. A comment to message 969.

No need to get sarcastic. Most "This is a Computer" books do not describe how photo detectors on floppy disks work. I was hoping you might know of some more in-depth texts on how both floppy and hard disk drives are designed and engineered.

ibm.pc/drives #981, from bbrown, Sun Feb 1 11:29:20 1987. A comment to message 980.

Sometimes it's easy to forget that a statement that might sound perfectly reasonable with tone-of-voice and body language clues could be offensive in cold print. I am sorry to have offended; I didn't mean to.

What I was trying to say is that how the index hole works is a bit of knowledge I "picked up along the way," rather than something I learned formally. It may be that I extrapolated that fact from having worked with removable disk packs, which have an analogous "index notch" on the bottom platter. I really *don't* know how I know that. (Ummm, and we really *were* discussing biquinary relay computers in another conference, but that degenerated into a discussion of where quinine comes from. :-)) I am surprised to hear that introductory books don't explain the hardware in enough detail to cover index holes. In the next several weeks I'm going to have to go through several such books to prepare a bibliography. Maybe I can find one that has enough depth. Alternatively, I see from your resume that you have considerable writing experience. Maybe there's a market for a "second level" of computer information books.

ibm.pc/drives #982, from nickbaran, Sun Feb 1 14:28:16 1987. A comment to message 981.

I guess the reason I raised the question of in-depth books to begin with is that there are obviously many technically proficient computer users who have a lot of questions and doubts concerning the inner workings of disk drives, as shown by the activity in this conference. Disk drives are clearly fairly complicated mechanisms and from an engineering point of view, there are a lot of technical details that are not covered in popular introductory computer books. There are many books on the inner workings of internal combustion engines, for example, but I haven't seen such books on magnetic storage media in general.

In any case, sorry about the misunderstanding above. As you say, it's easy to misinterpret the written word.

ibm.pc/drives #994, from gingle (George Ingle), Wed Feb 4 01:36:54 1987. A comment to message 982.

Alas, with thousands of dollars of computer equipment and software, the act of human communication is still imprecise.

You're right about the current level of books available for, shall we call them, the second generation of users? The first generation being the people who designed and built the forerunners of the systems we are using today. The second generation is now using these systems, without having been intimately involved with their design and construction. I believe this is why so many computer-related publishers have

continued

HIGH-TECH POWER



Following the successful introduction of our Baby AT motherboard, we are pleased to announce a range of AT and XT support products.

A One Year Warranty is standard with all of Turn-Point's products.

Available factory direct only from Turn-Point America, we offer these outstanding products.

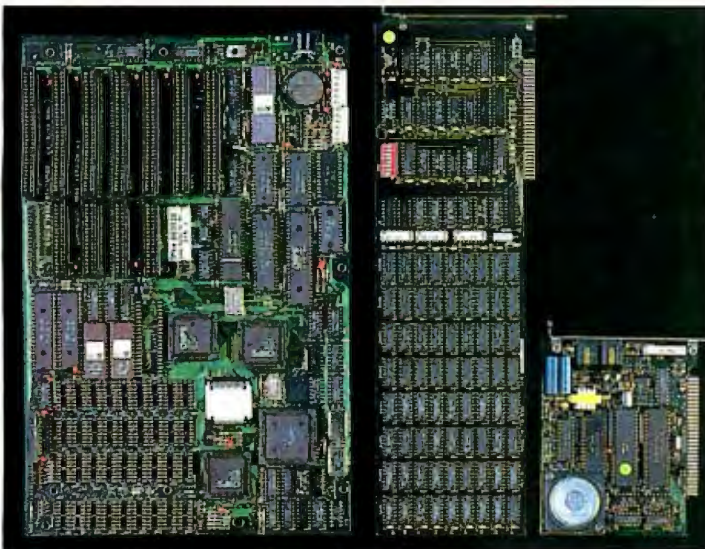

Baby AT Motherboard now only \$465.00

- 100% IBM AT compatible
- 10 Mhz with Zero wait states
- XT size board and mounting holes
- Serial port on board
- Setup programs included

Ram-Master Extended Memory Board w/ OK \$95.00

- Up to 2 Mb of expansion memory
- Full Lotus/Intel compatibility
- User configurable as conventional memory, extended memory, or both
- Software included supports 8 Mb

Mighty-Mo 1200 Baud Internal Modem \$79.00

- Full Bell and CCITT compatibility
- 100% Hayes command set compatible
- Line quality monitoring and equalization
- Adaptive dialing
- Local/Remote loop tests and self test

NEW PRODUCTS AT PRESS TIME!

- 10 Mhz 286 Accelerator Board \$295.00
- 3.5 Mb AT Multifunction Board w/up to 4 serial ports \$175.00
- Multi I/O w/up to 4 serial ports, clock, 1.2 MB floppy controller, and more \$130.00

VISA and MasterCard accepted | 1-800-247-6413

Inquiry 330



Turn-Point America

P.O. Box 71016
150 N. Center St., Suite 224
Reno, NV 89570
Tel: (702) 786-4484
Telex: 650 308 4898 MCI
Fax: (702) 826-6741

TRADEMARKS and REGISTERED TRADEMARKS: IBM AT — International Business Machines Corporation.

folded over the last few years. The majority of new computer users did not want (or did not have the background necessary) to understand the actual electronics and mechanics of the computers they were using. The best place in the world to get information on disk drives is a technician's service manual.

I think that this why so many computer books were written at the "This is a Computer" level of information.

ibm.pc/drives #983, from petewhite (Peter White), Sun Feb 1 21:10:40 1987. A comment to message 982.

From "Understanding Digital Computers," a Radio Shack Publication (62-2027):
 "Incidentally, did you notice the three holes in the envelope of the floppy? The center hole, obviously, is for the motor drive mechanism. The rounded rectangular hole permits the recording head to make direct contact with the surface of the floppy. The small round hole permits the drive system to identify various data locations on the disk by one or more holes around its surface. It's called the 'sector hole.'

"Let's discuss the sector hole, since it's very important. Information on each of the data tracks around the surface of the disk can be stored in one or more locations called 'sectors.' There are two ways of dividing a disk into sectors. 'Soft-sectored' disks have only one sector hole. A computer program (software) is required to divide the disk into sectors and, while this provides considerable design flexibility, the program can be difficult to design and use."

"'Hard-sectored' floppies have 32 or more sector holes, and this permits a data track to be divided into 32, 16, 8, 4, 2, or 1 sectors. Electronic control circuits built into the drive system take care of the 'housekeeping' chores necessary to store and retrieve data in various sectors. Most commercial floppy systems use the hard-sector approach."

Yes, an old book - but one of the best ever found to help explain just about anything in basic digital computers. In fact, it explains hexadecimal arithmetic so well it has helped several who COULDN'T understand hex at all.

Stay tuned, folks, next week it's "Learn about binary logic, how it works, and how to use it."

ibm.pc/drives #995, from gingle (George Ingle), Wed Feb 4 01:38:38 1987. A comment to message 983.

Is this going to be one of those "on again/off again" things?

ibm.pc/drives #996, from dmick, Wed Feb 4 01:40:33 1987. A comment to message 983.

Does it explain how to *spell* "hexadecimal" as well, Pete? <grin>

ibm.pc/drives #1012, from johnf (John Fistere), Thu Feb 12 02:03:12 1987. A comment to message 983.

Does it explain why a "2s complement" is so named? I've heard a few theories, but none that wrap it all up.

ibm.pc/drives #1024, from alf (Eric Klien), Mon Feb 16 20:43:56 1987. A comment to message 1012.

A 2s complement is a 1s complement plus 1. $1 + 1 = 2$, so it's called a 2s complement.
 the "This is the keyboard" level of information.

MACINTOSH

This month's Macintosh section has two threads. The first, long though it is, is a prime example of the type of discussions that evolve on BIX. It covers the potential advantages, disadvantages, and stumbling blocks of converting an IBM PC program written in C to the Mac. If you're wondering about getting started in Mac programming, read this thread. Then there's a short thread on font-spacing problems in MacWrite.

GETTING INTO MAC SOFTWARE DEVELOPMENT

macintosh/softw.devlpmt #810, from lee.richardson \ (Lee Richardson), Sat Feb 14 22:49:25 1987

A couple of questions about Mac software development:

First, I have an application, written in C for the IBM PC, that takes up about 50K after it's compiled. I want to port it over to the Mac using a reasonable amount of the Mac goodies (windows, menus, etc). I know C, and have been using Mac programs for over a year, but have never done any C programming on it. How much time should I allow for learning all the Mac's idiosyncrasies? Any rules of thumb for conversion time after that? I'm looking for ballpark figures.

Second, an obvious question to go along with that: What are some good references for learning the Mac? Is LightspeedC the C of choice right now? Thanks!

macintosh/softw.devlpmt #811, from lloeb (Larry Loeb), Sun Feb 15 09:24:07 1987. A comment to message 810.

Geek, that's a hard one. You should read Apple's "Inside Macintosh," of course. That alone can take a good month (part-time). Some C compilers will default a stdio to a default window so you can program the Mac like a glass TTY. But that method doesn't avail you of all the Mac's features (which I'll assume is why you want to port it). My gut feeling is that the average newcomer to Mac programming will take three months to become barely proficient (I have no data to back that up, just a feeling).

And yes, LightspeedC is a very good environment and cheap to buy.

macintosh/softw.devlpmt #812, from nwallach (Naor Wallach), Sun Feb 15 16:33:50 1987. A comment to message 810.

Plan to devote a LOT of time. The Mac is not the simplest of computers to write for. Good references are Apple's own "Inside Macintosh," which is currently sold as a four-volume set. LightspeedC is probably one of the better C compilers out there. Current version is 2.0. Good luck!

macintosh/softw.devlpmt #813, from lee.richardson \ , Sun Feb 15 17:59:03 1987 A comment to message 812.

Thanks. That's about what I had figured. This would be a contract job and I was wondering how long it would be before I could put any billable hours into it. Was hoping there was something to go along with "Inside Macintosh." I have heard that it can be fairly dense in a lot of places.

macintosh/softw.devlpmt #822, from nwallach, Mon Feb 16 18:03:43 1987. A comment to message 813.

Another source of info that might be less dense is "Macintosh Revealed: Programming the Macintosh Toolbox" by Steve Chernicoff. It doesn't cover everything you will need to know, but it will be easier to start with.

continued

Charles Humphrey
Computer & Software News
11/24/86

"COMDEX...
reflects the
industry. And
right now that
image is one
of growing
strength and
momentum."

"There was a
level of electricity
running through
the show, stimu-
lated by a wave
of new products,
that I haven't
felt for several
years."

William Zochman
MICRO MARKETWORLD
11/24/86

ONLY ONE SHOW REFLECTS THE SUCCESS OF COMDEX/Fall '86. COMDEX/Spring '87.

We're proud COMDEX/Fall was recognized as the platform for the industry resurgence of 1986. But we're not sitting on our kudos.

We're making sure COMDEX/Spring '87 accelerates the COMDEX/Fall '86 momentum. With an exhibit force of late-breaking advancements and fast selling products and services that are helping the industry turn over a new leaf—and help you turn bigger profits than ever. From the latest in micro-to-mainframe links. CAD/CAM and desktop publishing hardware and software to CD-ROM, peripherals and add-ons, the exhibit floor showcases everything you need to make your sales shine.

And we probe beneath the surface to make sure you know what the big sellers are and how to sell them. The COMDEX Conference helps you spear the biggest selling fish with special full-day conferences on micro-communications and desktop publishing. Offers you unique insights through sessions presented by the Software Publishers Association and ADAPSO. And schools you in everything from the right software to sell to new opportunities in office telecommunications.

Fill out and send in the coupon below for full attendee information, including special

attendee travel and hotel arrangements. Because it's no longer time to reflect on success—it's time to act on it.

COMDEX/Spring '87 REFLECTS SUCCESS!

Send me complete attendee information.

Name _____

Title _____

Company _____

Address _____

City _____

State _____ Zip _____

Return to: COMDEX/Spring '87
Registration Department
300 First Avenue
Needham, MA 02194

BT/M87

COMDEX/Spring '87

June 1-4, 1987 • Georgia World Congress Center • Atlanta, Georgia

Produced by

THE INTERFACE GROUP, Inc.®

300 First Avenue, Needham, MA 02194

© 1987, The Interface Group, Inc.

Another good reference is "Programming the Mac in C" by Cummings and Pollack, which seems to apply very well to your request. It was written with another compiler in mind, but you shouldn't have much trouble converting. Good luck.

macintosh/softw.devlpmt #823, from cccrawfor (Chris Crawford), Mon Feb 16 21:10:00 1987. A comment to message 813.

I very much like Scott Knaster's book "How to Write Software for the Macintosh." It goes a long way towards demystifying the Mac. "Inside Macintosh" is a good reference, but it's murder on somebody just learning the Mac. Scott's book is nowhere near so intimidating, much more fun, and covers all you need to get rolling.

macintosh/softw.devlpmt #826, from lee.richardson \ , Tue Feb 17 02:26:30 1987 A comment to message 823.

That's the kind of book I had in mind. The classic comment I've heard about "Inside Macintosh" is that to understand any one section you have to understand all the other sections first.

macintosh/softw.devlpmt #814, from ericz (Eric Zocher), Sun Feb 15 19:43:52 1987. A comment to message 810.

I agree with what's been said so far. Another book that might prove useful is "Using the Macintosh Toolbox with C" by Huxham, Burnard, and Takatsuka, published by Sybex. The code in it is written in Consulair C, but that isn't a problem since the LightspeedC manual has an excellent section on the differences between LS and the other Mac Cs.

Another thing that could prove valuable, especially if you're doing commercial work, is the "Macintosh Technical Notes" series, available from APDA.

macintosh/softw.devlpmt #817, from lee.richardson \ , Mon Feb 16 02:17:50 1987 A comment to message 814.

I'll check out both the Sybex book and the Technical Notes. I figure the more stuff I read, the better chance I have of understanding what's going on. Is there an address for APDA on the board?

Just to get some idea of directions maybe NOT to go in, would MacApp or the Macintosh Programmers Workbench be worthwhile to investigate? It looked like using MacApp would imply learning object-oriented programming (another level of complexity I don't need right now), and that MPW hasn't been released for general use.

macintosh/softw.devlpmt #819, from kschmucker (Kurt Schmucker), Mon Feb 16 10:10:16 1987 A comment to message 817.

I have a radical suggestion for you: Use MacApp to port your application to the Macintosh. MacApp packages much of the Mac's mysteries for you in easily used objects. Problems like printing, window management, desk-accessory compatibility, etc., just vanish with MacApp, since it takes care of all these for you.

There ARE two problems, however. The first is that MacApp is currently only callable from Object Pascal and Object Assembler. The shell of your Mac application will have to be in Pascal. However, you can still call the C routines that you will port over from the PC. To the extent that your PC application is well-modularized (user-interface stuff separated from the fundamental computations that form the basis of the application), this is usually not too difficult.

The second problem is that you must learn a little bit about object-oriented programming. Luckily, this is not too hard and there is a great book: "Object-Oriented Programming for the

Macintosh." (Sorry guys, I just COULDN'T help it!!). Don't let the fact that I wrote the book sway you one way or the other.

Final note: Both MPW and MacApp ARE available in final form from APDA. Even if you don't decide to look into MacApp at this time, get MPW. The development system of choice, especially if you come from a UNIX background.

macintosh/softw.devlpmt #820, from tom__thompson (Tom Thompson, BYTE), Mon Feb 16 15:13:28 1987 A comment to message 819.

Best bet is to get hold of the SKEL package, which has a basic Mac application skeleton in C. This shows you how to set up event handlers, summon up dialog boxes, and call DAs. I even think it's on BIX somewhere (Larry?). I've used this to build a Mac application in short order but, then, I've been steeping myself with Mac mysteries via "Inside Macintosh" for about a year. You'll need to learn and understand resources before you get too far. Latch onto the Resource Compiler version 2.0 (most C compilers provide it, so it's not a problem) and ResEdit (some compilers provide this also, some don't). You can find out *a lot* by poking around within an application with ResEdit. Just make sure you're working on a COPY of a program; ResEdit can really munge things in a hurry.

I recommend LightspeedC; it's a solid product, and quick. It fits on my Fat Mac and two external disk drives at home. They also provide the resource compiler and ResEdit.

macintosh/softw.devlpmt #825, from lee.richardson \ , Tue Feb 17 02:24:28 1987 A comment to message 819.

OK, using MacApp sounds like one reasonable direction to go in. However, where do you think the trade-off lies between learning object-oriented programming versus not having to learn quite so many Mac details? I know nice, normal Pascal pretty well, but am somewhat intimidated by having to learn the Mac AND a different programming philosophy.

In a different direction, does using MacApp cause any performance degradation in your resulting programs? Don't you also have to have at least a Mac Plus to use it?

macintosh/softw.devlpmt #828, from kschmucker, Tue Feb 17 07:07:37 1987 A comment to message 825.

Replies to your MacApp questions:

1. MacApp currently requires at least 1 megabyte of RAM for development, though applications developed with MacApp can run on 128K machines.

2. Performance degradation: Basically, no. This is one of the most common misconceptions of object-oriented programming. Demos I have given of MacApp applications at MacWorld shows and other places typically convince people that this is not the case. (Of course, if you are one of those people for whom tightly hand-coded assembly language is BARELY fast enough, then you may feel otherwise. . . .)

3. Where does the learning trade-off occur? This is a hard question. In my opinion, if you learn QuickDraw and a handful of file-system calls (FSOpen, etc.), you can get your MacApp application off the ground and a long way toward completion. (The best book for this is "Macintosh Revealed" by Chernicoff). Will you want to eventually learn about resources, dialogs, and bunches of other stuff? Sure, but the operative word here is "eventually." Will you ever have to learn about the Window or event managers? Probably not, unless your application is most unusual. MacApp handles all this for you.

continued

WHEN YOU'VE TRIED THEM ALL *the choice is easy!*

Just ask one of GTCO's customers, Dave Smalley owner of SeCAD, a systems integration company located in Miami, FL.

"SeCAD has been selling turnkey CAD systems for 3½ years, and we switched to GTCO tablets a little over 2 years ago. We've tried most of the other popular brands, but we haven't found any that match GTCO's price/performance ratio. Here are some of the reasons why I recommend GTCO's DIGI-PADS:



Dave Smalley, SeCAD, Miami, FL.

1. "I don't want to assume the risk of having a tablet I sell damage my customer's data file. Floppy disks are safe when placed on GTCO tablets.
2. "Other tablets cause flickering and washed out colors when they're used near high resolution displays. That never happens with DIGI-PADS.
3. "Customers can choose a wide range of input accessories from a pen/stylus to a 16-button cursor.
4. "GTCO's cursor switches have excellent tactile feedback, with no 'bounce.' Users never have to redo a command because the button did a 'double pick.'
5. "DIGI-PADS can be used for more than just screen pointing and tablet menuing. I have many customers who need to trace an existing drawing into their CAD system, so a DIGI-PAD's high degree of accuracy is a prime consideration.
6. "All DIGI-PADS have the same features and performance. I can demo an 11"x11" DIGI-PAD and know that any other size will work in my customer's system. Since DIGI-PADS are available in sizes up to 42"x60", there's one to match every user's needs. And the L Series DIGI-PADS are really economical when a large tablet is needed.
7. "DIGI-PADS can digitize through non-metallic materials up to 1" in thickness, without compromising the standard 0.001" resolution. Some of my customers digitize directly through their engineering logs. I couldn't have sold other tablets to them.
8. "While visiting GTCO's headquarters I realized why DIGI-PADS have such high reliability: GTCO has developed a superior technology and manufactures DIGI-PADS in its own highly automated factory.

"I can promote GTCO tablets without hesitation because they are designed for the serious professional who demands superior performance."



GTCO Corporation

A Graphics Technology Company

7125 Riverwood Drive, Columbia, MD 21046

Phone: 301/381-6888 • Telex: 898471 • Fax: 301/290-9065

DIGI-PAD is a registered trademark of GTCO Corporation.



GTCO

DIGI-PAD

Don't let buzzwords like "object-orientation" scare you. OOP is really a comprehensive embodiment of all the proven topics in software engineering (data abstraction, modularity, top-down design) with a couple of new ideas thrown in (inheritance and dynamic binding). OOP just gives you language support for the things you are probably doing now on your own.

Consider the following analogy: If someone held your feet to a fire, could you code a recursive algorithm in FORTRAN? Sure you could. It would be messy maintaining your own stacks, popping and pushing for routine invocation, but you could do it. Should you? Of course not. Such a task is only worthy of a student. A real pro, if a recursive algorithm was the best solution, would choose a modern language like C, Pascal, or Ada, since they support recursion. Similarly, OOP and object-oriented languages give you language support for the kinds of things that help you manage your application in the large: modularity, complexity control, flexibility.

(In case you can't tell, I'm a totally committed object-oriented evangelist!! I will get down from the pulpit now.)

macintosh/softw.devlpmt #830, from lee.richardson \ , Thu Feb 19 00:44.:16 1987 A comment to message 828.

Thanks for the answers about MacApp - that's just what I wanted. I was at a fairly good-sized bookstore yesterday and couldn't find any reference to MacApp at all (too soon?), so this gives me a better idea of what it is. I did pick up the first volume of "Macintosh Revealed."

I've got a little more info about this possible programming project, and it turns out that there are 60,000 lines of C in the original PC-DOS version of the program (I'm wondering how accurate that is, but that's what I was told). It seems that a program of that size would start to benefit from modularity, complexity control, flexibility, et al, so it may make sense to go the MacApp route. I really have no objections to learning OOP, since it seems like a direction programming is heading in anyway; I just don't want to overload my learning capacity.

Actually, this whole project is beginning to sound unrealistic. The person who owns the program wants a mostly working version in 2-3 months. Completely overlooking any Mac learning time involved, it seems that 2-3 months would be just about enough time to get a solid idea of what those 60K lines were doing to start with, with another 3-6 months to get something decent running on the Mac. One of us is being pretty unrealistic, and I hope it turns out to be him.

macintosh/softw.devlpmt #831, from kschmucker, Thu Feb 19 08:05:14 1987 A comment to message 830.

Most B. Daltons carry "Object-Oriented Programming for the Macintosh" (Hayden/Sams is the publisher). It came out last summer, so it is not too early. As you can probably guess, I look for it in every bookstore I go in. My hit rate of late as been close to 100%.

However, if you are having trouble, call the publisher directly to order: 1-800-428-SAMS. Have your MC or Visa number handy.

macintosh/softw.devlpmt #832, from tom__thompson, Thu Feb 19 09:16:26 .1987 A comment to message 830.

60K lines? Hope a lot of that's comments. It would definitely help. If there's no comments at all, I'd toss the thing.

macintosh/softw.devlpmt #824, from ccawfor, Mon Feb 16 21:16:24 1987. A comment to message 817.

I've been using MPW now for two months, and I am very pleased with it. The environment is solid, can be used in numbskull

fashion (a great feature for me), and has lots of room for growth. I started off using only its most rudimentary features and was very pleased with it. As time has passed and my confidence has grown, I have started to play with some of the snazzier features, but there's so much in there that I'm sure I'll still be improving my use of it years from now. The Pascal compiler is good, bug-free, and quite fast enough (beats the hell out of Lisa Pascal running out of a Profile), especially when you use the \$LOAD directive. The MAKE facility is *extremely* useful, but takes a while to figure out. You THINK that you're writing a slightly intelligent programmed EXEC file, but in truth you're doing something very different, and until you get the feel of MAKE, it will drive you nuts. Once you get over that problem, MAKE is wonderful.

So I'm very happy with MPW.

macintosh/softw.devlpmt #827, from lee.richardson \ , Tue Feb 17 02:27:28 1987 A comment to message 824.

So it looks like my first step here is to chase down APDA and see what they have to say about both MPW and MacApp, and then go from there. That's certainly enough to get me started.

macintosh/softw.devlpmt #818, from frankb (Frank Boosman), Mon Feb 16 02:23:59 1987. A comment to message 814.

Don't forget probably the best third-party book on programming the Macintosh, "How to Write Software on the Macintosh," by Scott Knaster. It contains an excellent section on debugging your program, which is probably what you'll spend most of your time doing.

FONT SPACING IN MACWRITE

macintosh/software #724, from lgeoffrion (Lee Geoffrion), Sun Feb 1 19:55:37 1987.

I ran into a strange problem with MacWrite 4.5 that maybe someone out there can clarify.

A colleague had written his dissertation using MacWrite the in Times font (12 point). Rough drafts were done on an Imagewriter. Since theses have severe format restrictions, considerable time was spent laying out 400 pages of manuscript.

When he went to print the final draft on a LaserWriter, all lines ran about 3/8 inch longer than the Imagewriter, even though there were no additional characters in each line. More importantly, the final output did not match the displayed rulers.

I thought it might be a spacing difference between the Imagewriter and the LaserWriter. We tested it by converting part of the thesis to Microsoft Word. In Word, the screen line lengths and LaserWriter line lengths agreed perfectly. Thus, the problem seems to reside in how MacWrite calculates character spacings.

Is this just a feature (bug) of MacWrite, or have we done something very wrong?

macintosh/software #732, from pbrewer (Phillip Brewer), Tue Feb 3 20:00:29 1987. A comment to message 724.

I've seen this problem discussed on other nets. The solution is to put a LaserWriter driver on the system disk, go into Chose Printer and select the LaserWriter as the printer, and then go into the Page Set-up dialog and click OK. This will tell the text editor that you will really be printing on a LaserWriter and it will adjust the line lengths accordingly. This works even if you don't have a LaserWriter hooked up. ■

The BCC52 packs an entire development and acquisition system into a single dose.

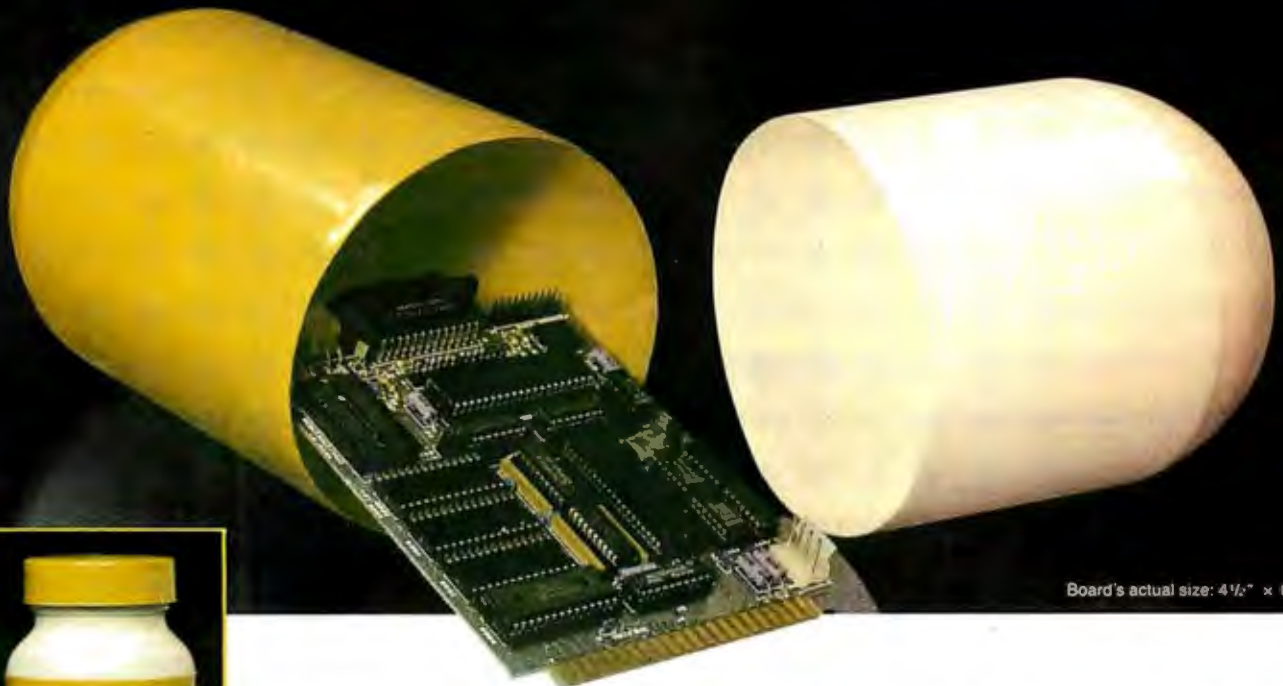

Board's actual size: 4 1/2" x 6 1/2"



Indications for use:

When a single controller board or a complete development and acquisition system is needed.

Active Ingredients:

Intel 8052 8-bit processor, 8K floating point ROM resident control BASIC, 3 on-board parallel I/O ports,

Serial terminal port (auto baud rate select), Serial printer port, Socketed for 48K bytes RAM and EPROM, 2 interrupts, Expandable to 64K bytes each of data and program memory, On-board intelligent 2764/27128 EPROM programmer.

Dosage: Take either a single board or an entire system to provide control relief.

CAUTION:

This product has proven to be habit forming.

*Now available without prescription
from Micromint for only*

\$149*

* 100 quantity OEM price

CALL TOLL FREE

1-800-635-3355

In Connecticut call: 1 871-6170

Micromint, Inc.

4 Park Street, Vernon, Connecticut 06066

TELEX: 643331



THE BUYER'S MART

A Directory of Products and Services

THE BUYER'S MART is a monthly advertising section which enables readers to easily locate suppliers by product category. As a unique feature, each BUYER'S MART ad includes a Reader Service number to assist interested readers in requesting information from participating advertisers.

RATES: 1x—\$475 3x—\$450 6x—\$425 12x—\$375
Prepayment must accompany each insertion. VISA/MC Accepted.

AD FORMAT: Each ad will be designed and typeset by BYTE. Advertisers must

furnish typewritten copy. Ads can include headline (23 characters maximum), descriptive text (250 characters maximum), plus company name, address and telephone number. Do not send logos or camera-ready artwork.

DEADLINE: Ad copy is due 2 months prior to issue date. For example: October issue closes on August 1. Send your copy and payment to THE BUYER'S MART, BYTE magazine, 70 Main Street, Peterborough, NH 03458. For more information call Mark Stone at BYTE 603-924-3754.

ACCESSORIES

Self-Inking Printer Ribbon

For users of Okidata and other open spool ribbon printers. Controlled Printout Devices are a new kind of printing ribbon that re-ink themselves, and will last 15 times longer than the ribbon you are now using. For further information please call or write.

CONTROLLED PRINTOUT DEVICES, INC.
POB 869, Baldwin Rd., Arden, NC 28704
(704) 684-9044

Inquiry 650.

ACCESSORIES

FREE CATALOG

Thousands of parts and new surplus electronic parts at super low prices. FAST ORDER PROCESSING AND SHIPPING (95% of all orders shipped within 48 hours).

CALL OR WRITE FOR A FREE CATALOG...

ALL ELECTRONICS CORPORATION
POB 20406, Los Angeles, CA 90006-0406
1-800-826-5432

Inquiry 656.

BAR CODE

BAR CODE READERS

Bar Code Reader for IBM PC/AT, attaches as 2nd keyboard, reads bar codes as keyed data, no slot required, **\$385**. Also RS-232 reader for multi-user PC, other micros, CRTs **\$399**. Rugged metal pen and case, auto-discrimination UPC/EAN, 2 of 5 Code 3 of 9 etc. 30 day \$ guarantee.

Worthington Data Solutions
130 Crespi Court, Santa Cruz, CA 95060
(408) 458-9938
See our ad page 300

COMPUTER PROTECTION

- UPS • LINE CONDITIONERS • ISOLATORS
- MODEM PROTECTORS
- AC POWER INTERRUPTERS
- HUNDREDS OF HINTS & PRODUCTS —

FREE CATALOG 1-800-225-4876

ELECTRONIC SPECIALISTS, INC.
171 So. Main St., POB 389, Natick, Mass 01760
1-800-225-4876

Inquiry 651.

INTERFACES and CABLES!

For most major computers and printers
TecTrans

Wolfgang Guertzen
6925 Rosemead Blvd. #24, San Gabriel, CA 91775
(818) 285-3121 or (818) 799-4570

Inquiry 657.

PRINT LABELS READABLE AT 50 FT.

Print Labels with Large Text and/or bar codes on PC with Epson/Okidata/IBM ptrs. Text to 1" x 1" reads at 50 ft. Bar codes 39, 2of5, UPC/EAN, MSI, DOD-LOGMARS, AIAG. Flexible format/size, Color, Reversals. Menu driven \$49-\$299, or print from ANY program (BASIC, dBASE, Lotus, Wdstr) \$179-\$239.

Worthington Data Solutions
130 Crespi Court, Santa Cruz, CA 95060
(408) 458-9938
See our ad page 300

ARTIFICIAL INTELLIGENCE

Prolog Source Code in C

Complete source code for a Prolog interpreter. Standard syntax and library functions. Compatible with major C compilers and machine models (PC and others). Includes 130 pages printed manual. \$49.95 (+ \$8 out-side U.S.)

A. I. Coder
P.O. Box 2295, Darien, IL 60559
(312) 789-2314

Inquiry 658.

BAR CODE & MAG STRIPE FOR PCs

Model MR-23B short card for PC/XT/AT and compatibles. Works with all software, in any slot. U.S.A. made, nationwide support, money back guarantee. Price \$375 with bar code wand, \$475 with mag stripe reader. Part of full line of bar code products, including external units and non contact scanners.

BARCODE INDUSTRIES, INC.
17 Barstow Road, Great Neck, NY 11021
(516) 466-5770 Ext. 130
Telex 506144, Fax (516) 466-5266

Inquiry 653.

BAR CODE

DATA INPUT DEVICES

Bar Code & Magnetic Stripe Readers for microcomputers & terminals, including IBM, DEC, AT&T, CT, Wyse, Wang. All readers connect on the keyboard cable & are transparent to all software. Low cost bar code print programs & magnetic encoders are also available.

TPS Electronics
4047 Transport, Palo Alto, CA 94303
415-856-6833 Telex 371-9097 TPS PLA

Inquiry 659.

BUSINESS OPPORTUNITIES

EATEN ANY GOOD CHIPS LATELY?

We eat, drink, and sleep hardware and love describing the results. We're looking for others who have built unique projects and can write articles about them. If you've got a great project ready for a chapter in our book, write us now. We're already in the business and we pay top dollar!

Microservices

67 Scott Drive, South Windsor, CT 06074

Inquiry 664.

COMMUNICATIONS

MULTI-USER BBS (FOR IBM PC AT)

TEAMate — a mainframe quality BBS. A mini CompuServe. Full screen cursor-controlled interface, topic outline structure, public and private topics, audit trails, xmodem, integrated mail, content retrieval and more. MS-DOS, XENIX and UNIX versions.

MMB Development Corporation
1021 No. Sepulveda Blvd., Suite K, Manhattan Beach, CA 90266
(213) 545-1455

Inquiry 665.

RIBBONS

OVER 300 AVAILABLE

	BLACK	COLORS
APPLE IMAGEWRITER	2.35	2.75
DIABLO HT 2 m/s	2.40	n/a
EPSON MX-RX 70/80	2.45	2.95
OKIDATA 80-82-92	.95	1.25

DAYTON COMPUTER SUPPLY

1-800-331-6841 (In OH 1-513-275-1247)
MC/VISA/AMEX

Inquiry 653.

... SOFTWARE PUBLISHING ...

GDS offers a wide variety of services that will help get your software to the market. Address your needs with GDS.

- IBM style cloth/vinyl 3-ring binders/slips
- Labels, sleeves, disk pages, bulk diskettes
- Disk duplication with 100% verification
- Shrink wrapping and product assembly
- Quick turn-around.

A well packaged product can make the difference in making a sale. Call us now! VISA/MC
GLENCO DEVELOPMENT SYSTEMS(312) 392-2492
3920 Ridge Ave., Arlington Hts., IL 60004

Inquiry 654.

BAR CODE MADE EASY

PERCON® E-Z-READER® keyboard interfaces and multi-user RS-232 models make it easy to add bar code to virtually any computer/terminal WITHOUT SOFTWARE MODIFICATION. Immediate shipping, two year warranty. Bar code printing software available. Call for details on fast, accurate, easy data entry. Substantial reseller discounts.

PERCON®
2190 W. 11th St., Eugene, OR 97402
(503) 344-1189

THE BUYER'S MART

COMMUNICATIONS

EasyComm™

Easy to use general purpose communications program for PC-PC-Data Base phone line communications. "Better than Crosstalk at 1/4 the price!" say EasyComm users. Send and receive files in "batches," by XMODEM, XON-XOFF TEXT, 1200 or 300 baud, even unattended. STATUS displayed at all times, context-sensitive "help," much more.

SPECIAL \$49 + \$2 SH
CalSOFT (805) 497-8054 VISA, MC
2899 Agoura Rd., Suite 143, Westlake Village, CA 91361

Inquiry 665.

COMPUTER DIGITIZERS

VIDEO IMAGE PROCESSING

- STORE VIDEO PICTURES ON DISK
 - CAPTURE & PRINT REAL-WORLD IMAGES
 - Custom Applications Include:
 - Video Databases
 - Desktop Publishing
 - PC Based Video Telephones
 - Color/B&W T-Shirt Systems
 - Digitizers (Computer Eye, Chorus, etc.)
 - Video Toolkits for DBASE III, LOTUS 123, etc.
- See HAL SYSTEMS below.

Inquiry 666.

HAL SYSTEMS

Image Processing Specialists

674 Route 202-206N
Bridgewater, NJ 08807

1-800-227-0158

(in NJ 201-218-1818)

201-469-0049 (24 hr. BBS/Modem)

"A picture is worth a thousand words"

Inquiry 666.

COMPUTER INSURANCE

COMPUTER INSURANCE

Call toll free for information and immediate coverage

- BUSINESS COMPUTERS
- HOME COMPUTERS
- COMPUTERS OVERSEAS
- COMPUTERS YOU LEASE
- COMPUTERS YOU LEASE TO OTHERS

SAFWARE,

The Insurance Agency Inc.

1-800-848-3469 IN OHIO (614) 262-0559

Inquiry 667.

CROSS ASSEMBLERS

ASSEMBLERS & TRANSLATORS

Over 20 high quality, full function, fast relocatable and absolute macro assemblers are available immediately. Source language translators help you change microcomputers. Call for info about MS/DOS, CPM80, ISIS versions.

RELMS™

P.O. Box 6719
San Jose, California 95150
(408) 265-5411
TWX 910-379-0614

Inquiry 668.

DATA/DISK CONVERSION

INTERCHANGE HEWLETT PACKARD FILES ON IBM PC

IBM PC to HP File Copy allows IBM PC's and compatibles to read and write files written by Hewlett Packard Series 70, 80, 200, 300, 1000, 9000 computers. Call for data sheets, config diagram, pricing. Oswego Software Inc. specializes in HP disk file copying, program translators.

Oswego Software Inc.

507 North Adams Street, Oswego, Illinois 60543 USA
(312) 554-3567 TELEX 858757

Inquiry 669.

DATA/DISK CONVERSION

CONVERSION SERVICES

Convert any 9 track magnetic tape to or from over 800 formats including 3 1/2", 5 1/4", 8" disk formats & word processors. Disk to disk conversions also available. Call for more info. Introducing OCR Scanning Services.

Pivar Computing Services, Inc.

165 Arlington Hgts. Rd., Dept. #B
Buffalo Grove, IL 60089 (312) 459-6010

Inquiry 670.

Disk/Disk • Tape/Disk • OCR

Over 1,000 formats! 3 1/2", 5 1/4", or 8 inch disks; 9 track mag tape; 10 MB Bernoulli cartridge. Data base and word processor translation. Specialists in Government Sensitive Data. Call for free consultation.

Computer Conversions, Inc.

We take the hassle out of data conversion...
9580 Black Mttn. Rd., Ste J, San Diego, CA 92126
(619) 693-1697

Inquiry 671.

DISK/DISK or TAPE/DISK CONVERSIONS — AUTOMATICALLY

Bought a new computer? Convert your data in just 1-2 days. SAVE TIME - SAVE MONEY!
DISK/DISK or TAPE/DISK Conversions start as low as \$14.00 for IBM, CP/M, MS-DOS, UNIX, XENIX & most other systems. (Apple, Macintosh, Commodore conversions start at \$25.00). Call or write today for a cost saving quotation to fill your disk-to-disk or tape-to-disk data conversion needs.

CREATIVE DATA SERVICES

1210 W. Latimer Ave., Campbell, CA 95008
(408) 866-6080

Inquiry 672.

DISK AND TAPE CONVERSIONS

High quality conversion services for Dedicated Word Processors, Mini and Microcomputers. Over 600 3 1/2", 5 1/4", and 8" formats. Also 800-1800BPI tape. Included: Wang, NBI, CPT, DEC, Vydec, Lanier, OS/6, Xerox, IBM Sys/34/36/38/5520, Mac, Victor, TRS, Apple, NSTAR, IBM PC/AT, HP, and most of the other microcomputers. We can convert directly into word processing software such as: DWS, WP, MSWORD, WS, Samna, MM, PFS, and many others.

DATA FORMATS, INC. (408) 972-1830

Inquiry 673.

DEMOS/TUTORIALS

INSTANT REPLAY II

Build Demos, Tutorials, Prototypes, Presentations, Music, Timed Keyboard Macros, and Menu Systems. Includes Screen Maker, Keystroke/Time Editor, Program Memorizer, and Animator. Rec'd Great Reviews! Simply the BEST! Not copy protected. No royalties. 60 day satisfaction money back guar. IBM and Compatib. \$149.95 US/Chk/Cr. Crd. Demo Diskette \$3.00

NOSTRADAMUS, INC.

3191 South Valley Street (ste 252)
Salt Lake City, Utah 84109 (801) 487-9662

Inquiry 674.

DESKTOP PUBLISHING

RED PENCIL

The only PC markup and correction program for document editing/review cycles. Make editing marks and comments, set text, all on-screen. Automatic update. Save on typesetting, proofreading. Requires IBM PC 128K, CGA, composite or RGB monitor, 2 drives. \$199.

Capsule Codeworks

9024 132nd Place SE, Renton, WA 98056
(206) 235-7099

Inquiry 675.

DOCUMENTATION

COMPUTER ASSEMBLY MANUALS

BIG BLUE SEED for IBM™ BUILDERS: Parts list, placement diagrams, instructions for assembling 75 bare cards. Now includes 640K, Turbo & AT MthBds. \$17.95.
APPLE™ BUILDERS NEED APPLE SEED: Instructions for assembling 85 Apple-compatible bare cards including the popular 6502 II+ and IIe MthBds. \$14.95.
Both for \$30. Bare cards available. Check/MO/ISA/MC.

NuScope Associates™, Dept B

P.O. Box 790 • Lewiston New York • 14092
*A Division of Kosmic MicroTech Inc.

Inquiry 676.

DOCUMENTATION

When they ask about your manual... Do you politely change the subject? No more! Give them documentation you can be proud of, at a cost you can afford. Fixed price contract, professional quality, quick turnaround.

Call today for a free estimate.

DOCUMENTATION-BY-MAIL

20370 SW 84 Avenue • Miami, FL 33189
(305) 253-2317

Inquiry 677.

DUPLICATION SERVICES

SOFTWARE DUPLICATION

- One Stop Shopping • Technical Support
- Custom Packaging • Drop Shipping
- Copy Protection • Fast Turn-around
- Competitive Pricing

SATISFACTION GUARANTEED

800-222-0490 NJ 201-462-7628

MEGAsoft

P.O. Box 710, Freehold, NJ 07728

Inquiry 678.

BLANKET SERVICES

Diskette duplication • Packaging • Stocking/Drop shipping • 48 hour delivery • SUPERLoK copy protection • No mastering fee • No charge for standard labels •

Star-Byte, Inc.

713 W. Main St., Lansdale, PA 19446

215-368-1200

800-243-1515

Inquiry 679.

EDUCATION

COMPUTER FACT BOOK

- LEARN about Computers the Easy way.
- Written in Clear, Easy to understand English.
- Facts, Short Cuts, a Wealth of information. Hundreds of ways to improve your skills.
- When You Need reliable Information Fast turn to the COMPUTER FACT BOOK

for FREE Information write to:

COMPUTER & ARTS Publications

5580 La Jolla Blvd., Suite 472-G
La Jolla, CA 92037

Inquiry 680.

HARDWARE

HAVE YOU BUILT A CIARCIA DESIGN?

Designer kits at experimenter prices:

- Serial EPROM Programmer, BYTE Oct '86, \$89
- BASIC-52 Computer, BYTE Aug '85, \$169
- Serial Video Digitizer, BYTE June '87, \$99
- Grayscale Video Display, BYTE May '87, \$99
- Trainable IR Controller, BYTE Mar '87, \$54

More Kits available

Call CCI

4 Park Street, Suite 12, Vernon, CT 06066

(203) 875-2751

Inquiry 681.

THE BUYER'S MART

HARDWARE

68000/68020 SUPERMICROS
68000 from \$1495 68020 from \$2195
 Up to 30 Serial Ports, 14.5 Mbyte RAM, Hard & Floppy Drives w/DMA, Real-Time Clock with Battery backup. Price includes Software: OS9/68000 or OS9/68020 Op Sys Basic09, C Compiler, Word Processor, Spreadsheet, Disk Backup & Communications Programs and much more.
Frank Hogg Laboratory
 770 James St., Syracuse, NY 13203
315/474-7856 Telex 646740

SAVE Direct Manufacturer/XT/AT Compatible Wholesaler
 XT Clone Bare Bone (case, 150WPS, 40K) \$295
 XT Complete System (above + (2) Fujitsu Drives) \$695
 Hires Monitor, Mono Graphic Card, Keyboard, 2pp. (sp. RTC) \$195
 AT Clone Bare Bone (case, 200WPS, 512K, Phoenix Bios, 60286 @10 Mhz) \$695
 AT Complete System (above + 1.2MB, F/D Controller, Hires Monitor, Mono Graphic Card, Keyboard, 2pp, 1sp, RTC) \$1195
Dealer Inquiries Invited Complete Computer Accessories/Peripherals
DAR HAN CORP. Visa/MC/AE Accepted
 908 E. Main St. Alhambra, CA 91801
(818) 570-0396 or 284-2142
 G/Net Advanced Netware Available

Inquiry 683.

EPROM/EEPROM PROG. \$250
 Programs 2716-27512, 25xx and 68764/66 eeproms via RS-232. Also 874x macros and 28xxA & 528xx EEPROMs. Automatic baud rate select, built in help menus, no personality modules!
16 BIT I/O MODULE \$75
 Low cost control via RS-232. Expands to 512!
INTELLITRONICS
 P.O. Box 3263, Tustin, CA 92680
(714) 669-0614

Inquiry 684

INDUSTRIAL STRENGTH COMPUTER
 Has optimum features for monitor + control applications 16 Chan A/D*8 Opto INs*8 Hi/D/AE OUTs*48 Prog I/O Lines 3 RS232/422 Ports*4 Timers*Watch-dog*90K Memory*5.25x8.0 Options: Resident FORTH 79 OS with Target Compiler Editor, Assembler, and Auto Load/Start; 5 MHz 8085 4 Chan D/A*Battery Backed Clock/ RAM*Networking. E-PAC 1000 \$299. E-PAC 2000 \$399.
EMAC INC.
 PO Box 2042, Carbondale IL 62902
(818) 529-4525

Inquiry 685.

XPNDR2 PROJECT CARDS
 FOR THE COLOR COMPUTER DISK SYSTEM
 The 6809E signals are brought out to pins on a 40-pin wirewrap connector; on top the disk controller mounts vertically. 4.3X7.2" drilled for ICs; 5V and GND buses; all the right stuff. Includes App Notes. Cardguide available. Free Brochure.
ROBOTIC MICROSYSTEMS
 BOX 30807, SEATTLE, WA 98103
(206) 782-6809

Inquiry 686.

68020 COMPUTERS
 Up to 14.5 Mbyte RAM, 256K ROM, 30 users, DMA floppy and SASI (SCSI), calendar/clock w/bat. backup, timer, real time multi-tasking, multi-user op. sys., basic, assembler, screen editors, spreadsheet. Fits PC type cabinet. Mem. Prot. option, more.
 From \$2195.00.
 Other 68XXX computer systems from \$995.00.
AAA Chicago Computer Center
 120 Chestnut Lane - Wheeling, IL 60090
(312) 459-0450

Inquiry 687.

HARDWARE

CHIP CHECKER

• 74/54 TTL + CMOS + 8000 National + Signetics + 14/4000 CMOS + 14-24 Pin Chips + 9000 TTL + .3" + .6" IC widths
 Tests/Identifies over 650 digital chips with ANY type of output in seconds. Software updates will be offered as new chips become available. IBM compatible version \$259. C128 + C64 version \$159.

DUNE SYSTEMS

2603 Willa Dr., St. Joseph, MI 49085
(616) 983-2352

Inquiry 688.

8051 DESIGN KIT

Design with today's most popular 1-chip processor. Use a friendly monitor with single step, breakpoint and auto. View full register and SFR data reports at each break. 32 I/O pins including the serial port, interrupts, port 1, etc. also a 8044 version. - unpopulated printed circuit board - \$35 2764 monitor program EPROM for above \$25 - MS-DOS v 2.1 disk with monitor listing & hex file 8051 ver. \$25, 8044 ver. \$75 printed listing of monitor program \$15 all prices in US\$ write for info.

DEDICATED COMPUTER SYSTEMS
 site 15, box 11, RR2, Windsor Jct., NS, Canada B0N2V0
(902) 861-4755

Inquiry 689.

NEW/USED APPLES & STUFF

MACINTOSH \$900. + up
 Imagewriters 1 \$275
 Apple II+ & IIE — Call
 Macintosh Motherboards \$150 & up
 We buy, sell, & horsetrade — Apple, IBM.

SHREVE SYSTEMS

845 Lark Ave., Shreveport, LA 71105
318-865-6743 4-9 p.m. C.S.T. VISA/MC

Inquiry 690.

MEMORY CHIPS

41256-150ns	2.15	8087-8mhz	135.00
41256-120ns	2.40	80287-6mhz	175.00
4164-150ns	.85	2764	2.45
NEC V-20.8mhz	8.50	27256	3.45

SPECIAL

Speed up kit turns 4.7mhz XT up to 8mhz 35.00
 Includes, V-20, hardware, reset and speed switch.

WOOD & ASSOC.

fax (512) 331-9437 phone (512) 331-4865
 call for volume pricing or unlisted items. subject to change.

Inquiry 691.

MEGABYTES OF MEMORY

Lowest Prices Guaranteed in US. Dealer Inq. Invited
 Extended Memory Boards

TALLTREE SYSTEMS — JRAM BOARDS

JRAM 2	\$134	OPEN 7
JRAM 3 Aboveboard	183	DAYS A WEEK
JRAM AT	183	M-F 9-8
JRAM AT Aboveboard	239	S-S 9-6
JDISKETTE	135	VISA, MC, AE, CHOICE
JLASER I	275	703-847-4740
JMODULES	CALL	800-642-2395

Information and Technology Services, Inc.

Inquiry 692.

HARDWARE/ADD-ONS

PC I/O BOARDS

- Four Port RS-232 w/software \$349.00
- RS-422/485 Serial \$149.00
- RS-232/422 with 24 Parallel I/O \$199.00
- RS-422 Synchronous \$299.00
- EPROM/IRAM \$199.00
- A/D & Digital I/O \$299.00

Call About Custom Designed Boards
Sealevel Systems Inc.
 P.O. Box 1808, Easley, SC 29641
(803) 855-1581

Inquiry 693.

HARDWARE/ADD-ONS

DOUBLE!

Double your hard disk storage capacity with a PERSTOR 200 Series Controller. Advanced RLL encoding is used to increase data transfer rate to 9 or 10 mbits/sec. The PERSTOR 200 Series Controller works with most ST506/412 drives. Call for more info.

Systems and Software, Inc.

7825 East Redfield Road, Scottsdale, Arizona 85260
(602) 948-7313

Inquiry 694.

NEW VOICE SYNTHESIZERS!

"The Parrot" for IBM/Compatibles. It learns your words and never forgets. \$129.95. "Super Talker" for Commodore 64/128. \$79.95. "Super Talk" for Adam. \$99.95. All hardware includes software. Adam programs too! Order now or SASE for free catalog. Specify computer(s).

THE TALKING PEOPLE

19332 Carnania Lane, Huntington Beach, CA 92646
(714) 968-8355 Dealer inquiries invited.

Inquiry 695.

APPLE COMPATIBLE PRODUCTS!

16e RAM/80 Column Boards, 64K \$39. 256K \$109. 512K \$139. 1.0MEG \$238. 256K-1.0MEG includes XME PLUSWORKS S/wr. II+ 80 Col Bd \$49. 16e Keypad w/16 Keys \$39. II+/e Cooling Fan w/surge protect \$29.95. Add \$3 Shipping. Write for complete list.

NEXO DISTRIBUTION

914 East 8th St., Ste. 109, National City, CA 92050
(619) 474-3328

Inquiry 696.

ATTN: IBM PC/XT/AT OWNERS

TOSHIBA 86 MEGABYTE HARD DRIVE
 22 MS AVERAGE ACCESS TIME

Special \$1,095 includes T disk software industry standard size mounting and interface. TOSHIBA EXTERNAL 3 1/2" DRIVE SUB-SYSTEM * PERFECT FOR IBM PC/XT/AT \$279.

Call GSK Enterprises

(206) 820-1815 or (800) 527-5677
 12514 130th Lane N.E., Kirkland, WA 98034

Inquiry 697.

HARDWARE/COPROCESSOR

Z80™ / HD64180/CP/M™ CO-PROCESSORS

Plug-in co-processors for PC, PC/AT.
Blue Thunder Z80 co-processors
 6-mhz \$249.95 10-mhz \$399.95
 12.5-mhz \$599.95

HD64180 co-processors \$295 and up
 All co-processors with CP/M emulator. Software only emulator ZSIM only \$99.95.

Z-WORLD 408-980-1678
 2065 Martin Ave. #110, Santa Clara, CA 95050
 See Ad Page 194.

Inquiry 699.

5 MIPS PC POWER!

Turn your PC into a Mini!

The PC4000 coprocessor/memory card plugs into PC, XT, AT. Uses high speed Novix CPU. Executes Forth in silicon—no assembler. 100+ times faster than PC. Runs Sieve in .05 seconds. Runs in parallel with PC. Shares up to 512K on-card memory. Forth software included. C available.

Silicon Composers

210 California Ave., Suite I, Palo Alto, CA 94306
(415) 322-8763

Inquiry 699.

THE BUYER'S MART

HARDWARE/GRAPHICS

HOUSTON INSTRUMENTS PLOTTERS

Houston DMP-40/41&42: A/B/C/D size \$966/\$2577
 Ioline LP3700 A/E size, 1 per \$3317

DIGITIZERS

Summagraphics MM1201, pow, cable \$374
 GTCO MD7-1212 complete \$516
 Hitachi HDG-1111C Tiger II w/stylus \$646

GRAPHICS BOARD/MONITOR COMBOS

Orchid TurboEGA & NEC Multisync \$1099
 Artist 1 & Mitsubishi 19" monitor (C6922LPAG) \$3588
 Large corp. & institutional PO's accepted O.A.C.

ARDEN SYSTEMS, INC. (213) 479-6707 ext. 29
 12335 Santa Monica Bl. #240, Los Angeles, CA 90025

Inquiry 700.

HARDWARE/PERIPHERALS

LOAD CELL INPUT & CONTROL

Local/remote control of plant processes via multi-drop bus from single serial port; compatible with all computers. Basic software included.

- Load cell input • 8 channel AC output •
- 24 channels AC/DC input/output •
- Count up/down/metered pump control •

SCALE-TRON INC.

P.O. Box 424, Lachine, Quebec, H8S 4C2 Canada
(514) 634-7083

Inquiry 701.

MORE THAN A MIDI INTERFACE

• Use MIDI software for scoring, sequencing, interactive music training, etc. *with your own musical instrument* or MIDI input • Drive MIDI synthesizers, effects, recorders, drum machines etc. from any acoustic instrument. Avail. for Commodore 64, Apple II, Mac, Atari, Amiga, & more. \$189.00 U.S. (plus \$10.00 S&H) • Money Back Guarantee Payment by money order, VISA or Mastercard.

PITCHRIDER™ by IVL

IVL Technologies Ltd.
 3318 Oak St., Victoria, B.C. Canada, V8X 1R2
(604) 383-4320

Inquiry 702.

HRDWRE/POWER PROTECT.

POWERLINE GREMLINS?? POWER FAILURES??

The MEIRICK STANDBY POWER SYSTEM is the TOTAL SOLUTION to your powerline problems.
 400 watt system - \$449;
 800 watt system - \$795

MEIRICK Inc., POWER SYSTEMS DIV.
 Box 298, Frisco, CO 80443 303-668-3251

LAPTOP COMPUTERS

\$699 COMPLETE LAPTOP SYSTEM

Choose the new 24K Tandy 102 or 64K NEC 6300 laptop computers & combine it with our 3 1/4" disk drive, Sardine word processor and Random House dictionary (on a ROM chip) and even a carrying bag—all for just \$699—and less than 6 pounds! Add our IBM or Macintosh disk connection software for only \$49. Other accessories include a 2 lb. printer for \$99 or a 1200 baud 6 oz. battery-operated modem (Hayes compatible) for only \$179. FREE laptop catalog.

Traveling Software, Inc.

19310 North Creek Parkway, Bothell WA 98011
1-800-343-8080 (206) 483-8088

Inquiry 704.

PROGRAMMERS TOOLS

FREE PRICE GUIDE

Call or write for our FREE comprehensive price guide containing hundreds of languages, utilities and books specifically for IBM personal computers and compatibles. We're the world's leading independent dealer of programmer's development tools because we provide sound advice, low discount prices, fast delivery, FREE shipping and no hidden charges

Programmer's Connection 800-336-1166 USA
 216-877-3781 OH & AK (Collect)
 138 Sunnyside St. 800-225-1166 Canada
 Hartsville, OH 44632 9102406879 Telex

Inquiry 705.

PROGRAMMER'S TOOLS

Modula-2

REPertoire, the original M2 toolkit, has more than maturity, sophistication, and an enormous following. Priced at \$89 with full source, it's the largest collection of tools for any language. Period. May we send you a free copy of its 320p manual on a demo disk to prove it?

PMI 4536 SE 50th, Portland, OR 97206
(503) 777-8844; BIX: pmi

Inquiry 706.

HYPER C COMPILERS/TOOLS

Apple II ProDos Professional compiler, CDOS compiler, ProDos entry level compiler, 65C02 Assembly Language Dev. System, Macintosh compiler, full source code for both Apple II and Macintosh programming tools.

For further information/catalog contact:

WSM GROUP, INC. (602) 298-7910
 P.O. Box 32005, TUCSON, AZ 85751

Inquiry 707.

DO YOU WANT TO REACH QUALIFIED BUYERS?
 All you need to do is send us typewritten copy and we will set the ad for you.

Call us **NOW** at
603-924-3754
 to reserve your space.

Inquiry 707.

PUBLIC DOMAIN

RENT SOFTWARE \$1/DISK

Rent Public Domain and User Supported Software for \$1 per diskful or we'll copy. IBM, Apple, C-64, Sanyo 550 and Mac. Sampler \$5. VISA/MC. 24hr. info/order line. (619) 941-3244 or send #10 SASE (specify computer) Money Back Guarantee!

FutureSystems

Box 3040 (T), Vista, CA 92083
 office: 10-6 PST Mon.-Sat. (619) 941-9761

Inquiry 709.

PUBLIC DOMAIN SOFTWARE

Over 3000 disks covering PC/MS-Dos, CP/M, Macintosh, Atari and Amiga. Priced from \$6/disk by mail or download by modem from our 19 remote systems. (300-9600 baud, 600+ Megabytes online) for flat annual charge of \$50 (US). Fast service, shipped around the world. Call or circle inquiry #710 for our FREE 40 page minicatalog of highlights.

CANADA REMOTESYSTEMS LIMITED
 (1-800-387-1901) (1-416-231-2383)

Inquiry 710.

THE BEST OF THE BEST!

Public Domain & User Supported Software for IBM PC or compatible. Word Processing, Database, Spreadsheets, Utilities, Games, Accounting, etcl 60 disk package \$205.00, or rent 2 wks. \$75.00. Info & Super Sampler Disk \$6.50, Deluxe Word Processor \$6.50, both \$12.00. MCM/ISA

BLUE CIRCLE GROUP, INC.

5253 Chicago Ave. S., Minneapolis, MN 55417
(612) 823-4111

Inquiry 711.

PUBLICATIONS

At Last a Computer Blue Book

This publication is the only recognized guide to microcomputer hardware, peripherals, and software values, both new and used. For Subscription information call:

National Association of Computer Dealers

14925 Memorial Drive Building A
 Houston, Texas 77079
(713) 496-3283

Inquiry 712.

SALES/MARKETING TOOLS

Telemarketing Software \$95

TeleMAGIC is the #1 package for people who do business by phone. Super fast auto dialer, instant retrieval by several keys. Huge notepad. Makes "quickie" lists, reports, labels, letters. Utterly simple to use. Incredibly powerful. No copy protection. Interface with YOUR word processor. One billion records. DOS windows. Import-export/mailmerge. 30 day money back guarantee. Corporate license available. Network option. Now used by AT&T, GE, Bell, Sears, hundreds of others. VISA, M/C, A.X., C.O.D.

Remote Control

1320 Ocean Ave., Suite E, Del Mar, CA 92014
800-992-9952 In Cal. 800-992-5228

Inquiry 713.

SALES MAGIC

Software solutions for better selling from
MARKET POWER INC.
 computer innovations

We are proud to have helped these companies: Navistar, Westinghouse, Kodak, Chemical Bank, Chrysler, Canadian National Hotels, and more...

Whether you are a company or an individual, we can help you. Call or write. **(916) 432-1200**

101 Providence Mine Rd., Suite 106 A FREE
 Nevada City • California 95959 DEMO DISK

Inquiry 714.

SOFTWARE/ACCOUNTING

MONEYCOUNTS® Ver 3.9 \$12

CPA designed Money Management & Accounting system for Home & Business. Checking & credit card Mgt. Smart account balancer, budgeting, financial statements, graphics, financial data base, inquiry reports, on-line help, color, pop-up calculator, tutorial, handles up to 999 accts/24,000 entries per year, much more. OK to copy. Call or Send \$12 +\$3 S&H. Check/VISA/MC. IBM or compatibles.

PARSONS TECHNOLOGY

6925 Surrey Dr. NE, Dept. B., Cedar Rapids, IA 52402
Toll free 800-223-6925 or (319) 373-0224

Inquiry 715.

TIME & BILLING

400 clients/20 partners/80 job & 40 out of pocket categories/20 areas of practice/fixd fee or hourly/more! Prints billing/statements/aged rec's/more! Free phone support. \$149 (VISA/MC/AMEX). MS-DOS/CPM-80. Other original software.

FREE catalogue.

MICRO-ART PROGRAMMERS

614 Alameda Padre Serra, Santa Barbara, CA 93103
(805) 962-0922 (24 hours)

Inquiry 716.

dbASE BUSINESS TOOLS

- General Ledger
- Purch Ord/Inventory
- Accounts Recvbl.
- Accounts Payable
- Order Entry
- Job Costing
- Sales Analysis
- Job Estimating

\$99 EA. + s&h w/dBASE 2, 3 or 3+ SOURCE CODE

dATAMAR SYSTEMS™ Cr. Crd/Chk/COD
 6809-B Convooy Court
 San Diego, CA 92111 **(619) 278-8222**

Inquiry 717.

THE BUYER'S MART

SOFTWARE/A.I.

NEW INTEGRATED ENVIRONMENT AI FOR THE IBM PC

TOPSI IS A FULL VERSION OF OPSS WHICH RUNS UNDER MS-DOS, UNIX OR CP/M. A FAST, EFFICIENT EXPERT SYSTEM DEVELOPMENT TOOL.
PROTOTYPING: \$125 PRODUCTION: \$250
PROFESSIONAL: \$375 SHIPPING, ADD \$5

DYNAMIC MASTER SYSTEMS
POB 566456, Atlanta, GA 30356

(404) 565-0771 Telex #282923

Inquiry 718.

SOFTWARE/BASIC

OPEN SYSTEMS/BBx BASIC "Development Environment"

A Window overlay Environment with programmed function keys to provide the following features: **ONLINE HELP** Interface - contextual and indexed - Quick ERROR Help key. **ASCII/BBX ASCII PROGRAM CONVERTER** - use your own text editor. **DOS Interface**. **WORKSPACE** Status, and much more.
Demo Disk: \$10 U.S. (refundable on package purchase)
Package: \$250 U.S. Money Orders only, payable to:

Marshall H. Goodman Software Ltd.
c/o CIC Computer Information Centre
571 Adelaide Street East, Toronto Ontario, Canada M5A 1N8
(416) 947-9466

Inquiry 719.

COMPILED BASIC TOOLS

We now carry a complete line of libraries and tools for Compiled BASIC in addition to our FINALLY! series. Get our catalog of top brand products for Compiled BASIC, by calling 1-800-423-3400 (9:00 AM to 8:00 PM EST)

KOMPUTERWERK, INC.

851 Parkview Blvd., Pittsburgh, PA 15215
PA & AK call (412) 782-0384

Inquiry 720.

SOFTWARE/BUSINESS.

CASH PLUS

A complete set of programs to help small business people track sales and receivables efficiently. Reports include: Aged Receivables, Statements, Cash Due today or future date, Sales by category, customer, YTD, custom labels, and much more. Add on modules available.

Demos \$10.95 Full System \$89.95

SRI CORP.

P.O. Box 70012, Houston, TX 77270
(713) 864-5285 (800) 334-4704

Inquiry 721.

Service Plus Inventory II

Inventory location & control for warehouse & distribution centers. Fast, comprehensive & guaranteed to increase productivity. Handles 1000s of product codes (SKUs) each having as many locations as needed. Many reports including full activity by product codes, pick sheets by FIFO, lot #, serial #, or expir. dates. Demos available \$19.95 Full system \$695.00 Add'l modules available. Requires Harddisk IBM XT, AT or compatible multiuser or single user available.

SRI CORP.

P.O. Box 70012, Houston, TX 77270
(713) 864-5285 (800) 334-4704

Inquiry 722.

Service Plus—Delivery Rating

Complete set of programs for delivery services. Rates bill using your rates, zones, wt. breaks, etc. from simple rating to multiple zones, types. Reports include invoicing, driver pay, sales by customer/tonnage reports, aged receivables, statements, custom labels and more.
Demos \$19.95 Full System \$495.00

SRI CORP.

P.O. Box 70012, Houston, TX 77270
(713) 864-5285 (800) 334-4704

Inquiry 723.

SOFTWARE/BUSINESS

ARTlease System

Lease management software for cycling paintings, objet d'art, etc. Includes inventory management, exchange scheduling, batched billing, cash flow projections, aging, P & L statements and more. Real time access for fast customer service. Runs on MS-DOS, 520K RAM, Monochrome Monitor \$395.00

WindhamWoods Publishing

P.O. Box 314, Windham, NH 03087
(603) 893-2667 VISA/MC (800) 537-5002

Inquiry 724.

MILP88-MIXED INTEGER LP

A general-purpose system for solving mixed integer linear programs with up to 65 integers. 255 constraints 1255 variables. Solves problems by applying the branch and bound method. Menu-driven with many useful features similar to LP88. Req. IBM PC, 192K, \$99 with 8087 support, user's guide. VISA/MC.

EASTERN SOFTWARE PRODUCTS, INC.

POB 15328, Alexandria, VA 22309
(703) 549-5469

Inquiry 725.

dFELLER Inventory

Business inventory programs written in modifiable dBASE source code.

dFELLER Inventory \$150.00

Requires dBASE II or III, PC-DOS/CPM

dFELLER Plus \$200.00

with History and Purchase Orders

Requires dBASE III or dBASE III Plus (For Stockrooms)

Feller Associates

550 CR PPA, Route 3, Ishpeming, MI 49849
(906) 486-6024

Inquiry 726.

DATA FORM

CREATE your own form for DATA ENTRY

GREAT FOR custom sales and purchase orders, bank loan packages, ledgers, etc. This product mixes dataentry formats with numeric verification, word processing with/without line limits, tables, defaults, calculations.

COMPOSE DATA SERVICES

P.O. Box 247, Midway City, CA 92655
PC/compatibles Send 39.95 + 3.00 s&h + 6% CA tax

Inquiry 727.

DATA ENTRY SYSTEM

Heads-down data entry with two-pass verification for the PC/XT/AT & compatibles. Loaded with features like: Auto dup & skip, verify bypass, range checks, & table lookups. Fully menu driven only \$395. Call for free 30 day trial period.

COMPUTER KEYES

21929 Makah Rd., Woodway, WA 98020
(206) 776-6443

Inquiry 729.

THE EXECUTIVE™ VERSION 2.4

Organize yourself! The Executive integrates a customizable rolodex with activities by name, auto-dialing, calculator, calendar with alarm & word processing with inside calculations. Mail merge your rolodex entries. 140 p. user manual. 30 day guarantee. \$79

EXECUTIVE MASTERY SOFTWARE

P.O. Box 578-C, Concord, CA. 94520
orders
(415) 680-0202 (800) 682-2860

SOFTWARE/BUSINESS

LINEAR PROGRAMMING

MATRIX CALCULATOR does Linear Programming, Matrix Operations, System of Eqns, Statistics, Multiin Regression, Diff Eqns, and more. Need 8087. Comes w/Free DISKUTIL software. \$59.95 (\$120 w/Turbo Pascal source and Turbo-Linker software).

SoftTech Inc.

14640 LaBelle, Oak Park, MI 48237
1-313-544-8544

Inquiry 730.

PC-Write™ Shareware Ver. 2.71

Fast, full featured word processor/text editor for IBM PC. With spell check, screen clip, mailmerge, split screen, ASCII files, macros. Easy to use. Supports 400 printers - LaserJet+ and PostScript. Software, User Guide, and Tutorial on 2 disks for \$16. Try it, then register with us for only \$89 and get User Manual, 1 year tele-support, newsletter and 2 upgrades. 90-day guarantee. VISA/MC.

Quicksort(206) 282-0452 CALL TODAY!

219 First N., #224J, Seattle, WA 98109

Inquiry 731.

SOFTWARE/CHURCH

Church Package

Parishioner Time, Talent and Treasure System program is written in modifiable dBASE source code.

- Contributions • Disbursements • Ledger
- Names with mailing labels
- Personal information database.

Requires dBASE II or III. PC-DOS/CPM-80 \$200.

Feller Associates

550 CR PPA, Route 3, Ishpeming, MI 49849
(906) 486-6024

Inquiry 732.

ROMAR CHURCH SYSTEMS™

Membership-61 fields plus alternate address, labels, letters, reports any field(s). Offering-256 funds; optional pledge, statements, post to 255/year. Finance-G/L with budget; up to 500 sub-totals & 99 depts. month & YTD reports anytime for any month. Size 2000 people/floppy, 25000/10 meg. Ad too short! Write!

Romar Church Systems, Attn: BMB

P.O. Box 4211, Elkhart, IN 46514

(219) 262-2188

Inquiry 733.

PowerChurch Plus™

Fast, friendly, reliable church administration system. Full fund accounting, mailing lists, membership, contributions, attendance, word processing, accts. payable, payroll, multi-user support, and much more - all for \$495 complete. Demo version, \$10

F1 SOFTWARE

P.O. Box 3096, Beverly Hills, CA 90212
(213) 854-0865

Inquiry 734.

SFTWR/COMMUNICATIONS

VT100 \$89 VT220 \$139

Complete Terminal Emulation

For your PC, XT, AT, 3270PC & PCjr DOS key, Soft-keys, Macros, Scripts, 2-way File transfer: ASCII & KERMIT. Efficient. Rates to 38400, Compact.

Optional 4010/14 Graphics
Call for free info package.

General Micro Systems

Box 5330, Hopkins, MN 55343
(801) 649-0778

Inquiry 735.

THE BUYER'S MART

SOFTWARE/EDUCATION

THE GMAT COURSE (PC/XT/AT)

Covers every type of exam question with instant feedback, solutions, timed tests, personalized score analyses, math and grammar reviews. All material is on the screen. Designed by MBA's, the program has improved students' scores by as much as 250 pts. Includes 5 disks + manual. \$99.95

COMWELL SYSTEMS, INC.
P.O. Box 41852, Phoenix, AZ 85080
(Info & orders) (602) 869-0412
(orders only) (800) 342-1950 Ext. 63

Inquiry 736.

SOFTWARE/ENGINEERING

Affordable Engineering Software

CALL OR WRITE FOR FREE CATALOG
Circuit Analysis • Root Locus • Thermal Analysis • Plotter Drivers • Graphics • Signal Processing • Filter Design • Report Proofreader • Transfer Function Analysis • PC/MSDOS • Macintosh • CP/M. VISA/MC.

BV Engineering • (714) 781-0252
2200 Business Way Suite 207, Riverside, CA 92501

Inquiry 737.

ENGINEER'S AIDE

Integrated Process Engineering Software

- Pipeline/Ductwork Sizing
- Office/Control Valve Sizing
- Pump/Fan/Compr. Sizing
- Project Financial Analysis
- Heat Exchanger Sizing
- Conversions/Specifications

Pull-down menus, pop-up help, money back guarantee. All for \$395 (IBM & Macintosh).

Engineering Programming Concepts
P.O. Box 925, Camarillo, CA 93011,
1-800-367-3585 (805-484-5381, CA)

Inquiry 738.

SIMULATION WITH GPSS/PC™

GPSS/PC™ is an IBM personal computer implementation of the popular mainframe simulation language GPSS. Graphics, animation and an extremely interactive environment allow a totally new view of your simulations. Simulate complex real-world systems with the most interactive and visual yet economical simulation software.

MINUTEMAN Software

P.O. Box 1717Y, Slow, Massachusetts, U.S.A.
(617) 897-5662 ext. 540 (800) 223-1430 ext. 540

Inquiry 739.

HI-RES GRAPHS & STATS

Join scientific, educational, research & engineering institutions across the country analysing data provided by user-friendly packages:

ENGINEERING TOOL KIT **STATS TOOL KIT**
PROCESS CONTROL CHART TOOL KIT
BIOMEDICAL RESEARCH CHART TOOL KIT
IBM/Macintosh \$99-\$129 ea.

SOF-WARE TOOLS
P.O. BOX 8751, BOISE, IDAHO 83707
(208) 343-1437

Inquiry 740.

ELECTRONIC CIRCUIT ANALYSIS

ECA-2 is a PC based high performance analog circuit simulator w/AC, DC, Transient, Fourier, Worst Case and Monte-Carlo analysis is ECA-2 will handle circuits of approx. 500 nodes and 2500 components. In addition to value and tolerance, the component parameters include Bandwidth, Temperature Coefficient, Delay, Phase Angle and continuous or piecewise non-linearities. Includes component sweeping for optimization. Demo disk available. ECA-2 \$675. One year update service \$120.

TATUM LABS

1478 Mark Twain Ct., Ann Arbor, MI 48103
(313) 663-8810

Inquiry 741.

SOFTWARE/GENERAL

SongWright III

Music Processor for IBM Compatibles
Prints quality lead sheets, songs, scores with text and symbols, multiple staves; transposes to any key; plays tunes. Screen graphics editor; IBM/Epson/Star printers. Send \$49.95, \$2 s&h or write for free sample output.

SongWright Software

Route 1, Box 83, Lovettsville, VA 22080
(703) 822-9068

Inquiry 742.

SMALL BUSINESS & HOME

Loans/Sav'g/Calculator/Cost Schedule/Help Access List & Search. Files: Create, Read, Add Data-Charge Accts. Budget. Inventory, Tally, Auto Phone, Payroll. Invoice Sales/Ser./Paymts/Rtns. Check/Bank Strms. Text-File. Sorts. Instrs. List Code-Basic. IBM & Compatible. 256K. Add'l. . APTS Rental File + \$5.
\$39.95 + \$5 S/H COD/M.O./Csh-Chk.

CALC-DATA, INC. 800-247-7893
305-456-0417
460 Tamarind Dr., Hallandale, Fla. 33009

Inquiry 743.

CONTROL YOUR PROJECT!

Describe the work, **MicroGANTT®** project management system calculates the schedule and budget. Optimize the schedule and resource loading interactively. Customize the reports, including Gantt Chart and Network Diagram. Buy only the modules you need. MS-DOS, PC-DOS & CP/M-80. Free catalog.

Earth Data Corporation

P.O. Box 13168, Richmond, VA 23225
(804) 231-0300

Inquiry 744.

PC HYPER-CALCULATOR

Pop-up MS-DOS programmable scientific calculator emulates HP-11C. Hex/oct/bin arithmetic, two-way data transfer, program & data disk storage, HELP, alpha prompts, 100 registers, 1000 program steps. Free 8087 version, utility programs. \$39.95 + \$1 s&h.

SUNDERLAND SOFTWARE ASSOCIATES

P.O. BOX 7000-64
REDONDO BEACH, CA 90277

CALL TOLL FREE 800-628-2828 ext. 502

Inquiry 745.

GREAT SOFTWARE, CHEAP!

Absolutely smashing User Supported Software \$4.95 per disk. PC-Outline, AutoMenu, PC-Key Draw, PC-DeskTeam, PC-Write 2.7, Poster-Banner, DOSamatic, utilities galore, games, much more! Money-back guarantee. IBM PC, PC Jr, or compatibles. FREE CATALOG.

SHAREWARE EXPRESS

31877Del Obispo, Suite 102M, San Juan Capistrano, CA 92675

Inquiry 746.

SOFTWARE/GRAPHICS

FORTRAN PROGRAMMER?

Now you can call 2-D and 3-D graphics routines within your FORTRAN program.

GRAFMATIC: 75 callable routines for screen output. \$135.
PLOTMATIC: Pen plotter driver. \$135.
For the IBM PC, XT, AT and compatibles. We support a variety of compilers, graphics boards and plotters.

MICROCOMPATIBLES

301 Prelude Drive, Dept. B
Silver Spring, MD 20901
(301) 593-0683

Inquiry 747.

SOFTWARE/GRAPHICS

LAND SURVEYS

L-PLOT...A Metes & Bounds program to plot/print plats of Any scale— Any description— use Any measurement! Calc. areas, error of closure, plots multi tracts. IBM/compat with monographics, CGA or EGA capability. \$190. 30-day FREE trial. Visa/MC/chk.

LAN/SCAN, INC.

P.O. Box 8863, Abilene, TX 79608
(214) 824-6419

Inquiry 748.

FORTRAN GRAPHICS LIBRARY

MicroGlyph/SciPlot™ provides (MS/IBM PRO/F77L) FORTRAN graphics on any IBM PC/XT/AT. Features lin/log axes, labels, Hershey fonts, hi res plots on (IBM/Epson/Apple Laser-Writer) printers, or graphics on (IBM Color/EGA/Hercules/Mono/TecmarGM) displays. \$89.95 plus \$3.00 shipping.

MicroGlyph Systems

P.O. Box 474, Lexington, MA 02173

Inquiry 749.

GRAPHICS PRINTER SUPPORT

AT LAST! Use the **PrintKey** to make quality scaled B&W or color reproductions of your display on any dot matrix, inkjet, or laser printer. **GRAFPLUS** supports all versions of PC or MS-DOS with IBM (incl. EGA), Tecmar, and Hercules graphics boards. \$49.95.

Jewell Technologies, Inc.

4302 SW Alaska St., Suite 207, Seattle, WA 98116
(206) 937-1081

Inquiry 750.

If You Could See In 4D

You'd get six viewing axes instead of three, and familiar 3D objects would wrap or skew. Now you can see this with 4D Graphics Lab. Tired of flatland? Head for higher ground as you explore the fourth dimension by computer. Rotate 4D and 3D objects in real time or slowly define new objects too. Order today for \$44.44 plus \$4 S&H. CA add 2.89 tax.

For Compaq, IBM PC, compatibles CGA or 256K EGA

4D GRAPHICS LAB

Suite 537, 12021 Wilshire Blvd., Los Angeles, CA 90025

(213) 479-4792

Inquiry 751.

SOFTWARE INVENTORY

SUPER RETAILER™ Is HERE!

Find out why over 500 purchases a second are made on the finest point of sale program. Ultra-flexibility-cash, returns, credit, debts . . . Control your bus. Keep track of your money. Inventory module - \$99. Become a Super Dealer. Modules for acting integrate automatically. 60 Day Money Back Guarantee. VISA/MC. IBM & comps.

PMC

100 East 2nd Street, Mineola, NY 11501
800-DIAL-PMC in NY 516-294-1400

Inquiry 752.

SOFTWARE/LABELING

LARGE TEXT—LABELS and FORMS

Print big text labels readable at 50 ft. Uses IBM PC with Epson/Ok/IBM printer. 13 Text sizes to 1.2"x1.0". Color, Reversals, Bar Codes, File Input, Any Size, Flexible Format. Easy Menu Driven - \$279. Also from dBASE, Basic, Wdstr, Lotus, ANY program—\$239. Fast, Easy, 30 day \$ Back Guarantee.

Worthington Data Solutions

130 Crespi Court, Santa Cruz, CA 95060
(408) 458-9938

THE BUYER'S MART

SOFTWARE/LANGUAGES

SCREEN PROGRAM GENERATOR

SPG I creates BASIC program code quickly and easily. Design your screen directly and SPG I will generate the BASIC program code to handle the display and input of data. Controls use of color, editing, graphics, cursor movement and function keys. Generated code easy to modify / merge / compile. IBM PC & compatibles 128K.

\$49.95 + \$3 S&H (CA + tax)

Treebeard Software

5901 Warner Avenue, Suite 428, Huntington Beach, CA 92649
(714) 840-6939

Inquiry 754.

CBTREE FOR C PROGRAMMERS

B-tree ISAM driver written completely in 'C' to K & R standards. Supports multiple keys, variable key lengths, fixed or variable length data records. Easy to use sample programs and quality documentation. Fast, Flexible, Efficient. Source code and no royalties for only \$99 plus shipping.

PEACOCK SYSTEMS, INC.

2108-C Gallows Rd., Vienna, VA 22180
(703) 847-1743

Inquiry 755.

Minnesota SNOBOL4 Language

Powerful string & data handling facilities. Interpreter compatible with mainframe SNOBOL4. 32K strings, 32 bit integers. 8087 for float & large memory model. Sample pgms include ELIZA. For > 128K IBM PC & DOS or equivalent. Definitive "green" book by Griswold et al available.

Guide + 5 1/4" SSD diskette \$44.95
Guide + diskette + "green" book \$59.95
"Green" book only \$26.95

Postpaid in USA. In NY add tax. VISA/MC (914) 271-5855
BERSTIS INTERNATIONAL
POB 441, Millwood, NY 10546

Inquiry 788.

SOFTWARE/SCIENTIFIC

SCI-GRAF and SCI-CALC

SCI-GRAF produces huge hi-res graphs thru easy menus or linkable C libraries. Supports log scales, error bars, screen and printer output.

SCI-CALC is a pop-up calculator with complete expression editing, scientific, statistical, and logic functions.

Prices start at \$79.95.

Microcomputer Systems Consultants

32 West Anapamu, Suite 190, Santa Barbara, CA 93101
(805) 963-3412

Inquiry 756.

forMath® text-formatter

- Equations, matrices, ratios, integrals, diagrams
- Macros, fonts, Greek/math symbols
- Hyphenation, sectn/eqnl/ref numbering
- Indexes, table of contents, footnotes
- Dot-matrix, daisywheel, laser printers, all monitors

\$400. \$50 for demo

SHANTHA SOFTWARE INC.

50 West 97th St. Room 11N, New York City 10025
(212) 222-SNIP
Touchtone toll free: 950-1088-wait-FORMATH

Inquiry 757.

FREE SCIENCE/ENGINEERING MAGAZINE

Circle below for FREE sample of *Personal Engineering & Instrumentation News*. Monthly magazine gives News, Reviews and Applications Tips for the Areas of Analog and Digital Instrumentation, Design Automation and Data Acq & Control. Subscriptions: \$30/yr (\$60 outside US)

Personal Engineering & Instrumentation News

28 Rice St., Newton Center, MA 02159
(617) 969-7274

Inquiry 758.

SOFTWARE/SCIENTIFIC

SUBROUTINE LIBRARY

Scientific Subroutines for technical programming in Fortran, Pascal, Modular 2 and C. Source and Object code for a variety of compilers. Quality software at affordable prices.

ALPHA Applied Research

2355 McLean Blvd., Eugene OR 97405
(503) 485-6841

Inquiry 760.

DATA ACQUISITION AND ANALYSIS ON PC'S

• MEASURE for Data Acquisition directly to Lotus 123 • FOURIER PERSECTIVE II advanced Digital Signal Analysis • LOTUS MANUSCRIPT Technical Document Preparation System. Combines Text and Graphics. • PRIME FACTOR FFT Subroutine Library. Call from Turbo Pascal, C, Fortran, Basic. Up to 85,520 Data Points. 2D available. • T-R90 PASCAL from Borland. • TELEVISION for Image Communications. • 8087 Coprocessors, all analogies. • DASH-16 A/D Converter Board from Metrabyte.

FREE Customer Service — Satisfaction GUARANTEED

ALLIGATOR TECHNOLOGIES

P.O. Box 11386, Costa Mesa, CA 92627
(714) 722-1842

Inquiry 761.

CROSS ASSEMBLERS for VAX VMS and PC/MS DOS

Relocatable Macro Cross Assemblers, Linkers, Librarians
Targeted to almost all Microprocessors

ENERTEC, INC.

BOX 1312, Lansdale, PA 19446

215-362-0966 MC/VISA

Inquiry 762.

POP UP SCI CALCULATOR

COMPLEX is everything sci. calculator can hope for plus complex algebra, integer & bit manipulation, Boolean Logic, Polynom. eqn., FFT, graphics, curve fitting, and an extensible language. Comes with free DISKUTIL software. \$59.95 (\$120 w/Turbo Pascal source and Turbo-Linker software).

SoftTech Inc.

14640 LaBelle, Oak Park, MI 48237
1-313-544-8544

Inquiry 763.

ORDINARY/PARTIAL DIFFERENTIAL EQN SOLVER

FOR THE IBM PC & COMPATIBLES

MICROCOMPATIBLES INC.

301 Prelude Dr., Silver Spring, MD 20901
(301) 593-0683

Inquiry 764.

PlotIt® Interactive Graphics & Statistics

Create scientific, analytical and business graphs the way you want.
• 35 graph types including 3-dimensional.
• 50 statistical functions supplied.
• Can display standard error bars on graphs.
PC version \$550. Mainframe versions also.

In United States:

In Europe:

Gracon Services, Inc.

4632 Okemos Rd.
Okemos, MI 48864
(517) 349-4900

ICS

Kronberger Strasse 27
D-6000 Frankfurt 1, FRG
(069) 724-0827
Telex: 4 189688 ics d

Inquiry 765.

SOFTWARE/SCIENTIFIC

KALMAN FILTERING

PC $\sqrt{}$ filter/smoothen. Covariance and regression analyses, error budgets, unlimited data set size + much more. Executable \$250. Source code available.

Bierman & Associates

4419 Coldwater Cyn Suite J, Studio City, CA 91604
(818) 761-7082

Inquiry 766.

MAGPLOT MAGNETIC SOFTWARE

See Magnetic Fields with your PC and MAGPLOT. MAGPLOT Scientific Software uses AI to compute and plot the Magnetic Fields generated by currents near magnetic material. Great Visual Tool for Engineers and Educators. MS-DOS or PC-DOS with a Dot Matrix Printer.

Send \$20.00 for Manual and Demo-Disk. For more information Write or Call 818-708-9815

SALTEK SERVICES

POST OFFICE BOX 7847 Van Nuys, CA 91409

Inquiry 767.

SOFTWARE/SORT

OPT-TECH SORT/MERGE

Extremely fast Sort/Merge/Select utility. Run as an MS-DOS command or CALL as a subroutine. Supports most languages and filetypes including Btrieve and dBASE. Unlimited filesizes, multiple keys and much more! MS-DOS \$149. XENIX \$249.

(702) 588-3737

Opt-Tech Data Processing

P.O. Box 678 - Zephyr Cove, NV 89448

Inquiry 768.

SOFTWARE/TOOLS

SCREEN MASTER

For business professionals, programmers and home users

Create demos, prototypes, tutorials, w/384 color combinations & animation. Capture screens from programs. Design menus instantly. Enhance high level languages w/23 utilities. Run-time module for distribution. Simple enough for anyone - complex enough for any job.

GENESIS DATA SYSTEMS

5403 Jonestown Road, Harrisburg, PA 17112
(717) 652-1200

Inquiry 769.

LET'S TALK PHONETICS

When files are crowded with names, what a relief to locate individuals by phonetic. Added to your code, PHONKEY converts names to 16 bit phonetic keys for you to store. Compare them with that of target name, et voila! \$69.95 + s/h. See our ad in Byte-Bits section.

SYBIS INC.

1600 St. Martin Blvd. E., Tower A, Suite 610,
Laval, Quebec, Canada H7G 4R8
(514) 662-2227

Inquiry 770.

STATIONERY

Deluxe PC Stationery

Letterheads in continuous forms w/invisible perforated edges plus matching window or regular envelopes in watermarked quality Classic Laid paper. Numerous colors of ink & paper available utilizing many standard formats & type styles or supply your own, all at very low prices & fast delivery. Call for free samples, prices & info, or write:

PerFORMS Press

8456 Lofton, Cordova, Tenn 38018

(800) 624-2961 (Tenn: 901-756-7010)

Inquiry 771.

THE BUYER'S MART

STATISTICS

P-STAT®

Full mainframe package for PC/XT/AT & compatibles. Statistics, data & file management, data display, report writing and survey analysis all in one. 4GL programming language, online HELP & EDITOR, command or menu driven. \$95 demo and sitelicense available. Standard PC package \$695.

P-STAT, Inc. (609) 924-9100
471 Wall Street, P.O. Box AH, Princeton, NJ 08542
Telex: 486452

Inquiry 772.

StatPac Gold™

StatPac Gold is the high-powered statistics and forecasting package that delivers! And we're ready to prove it. Fast, flexible, easy to use and dependable. Time-tested and loaded with features. You be the judge. Get the facts! Call for your FREE brochure.

1-800-328-4907

Walonick Associates, Inc.

6500 Nicollet Ave. S., Minneapolis, MN 55423
(612) 866-9022

Inquiry 773.

PC SCA STATISTICAL SYSTEM (IBM PC or compatible)

Developed under the advisory direction of world renown statisticians, PC SCA is the *only* statistical software encompassing forecasting, time series analysis, quality control and improvement, and general statistical analysis. Prices range from \$195 to \$695 (depending on capabilities).

Scientific Computing Associates

Lincoln Center, Suite 106; 4513 Lincoln Ave.
Lisle, Illinois 60532 (312)-960-1698

Inquiry 774.

NUMBER CRUNCHER STAT SYS

Menu-driven. Multiple & stepwise regression, ANOVA, time series, discriminant cluster and factor analysis, principal components, scatter plots, histograms, t-tests, contingency tables, non-parametrics. Import export data. Spreadsheet, sort, join, merge. \$79. IBM PC/Macintosh. Quantity discount.

NCSS-B

865 East 400 North, Kaysville, UT 84037
801-546-0445

Inquiry 775.

PRO ☆ CAST

FORECAST SALES, INVENTORIES, etc.

Complete time series analysis — trend, seasonality, exponential smoothing, Box Jenkins, and more. Great graphics! Exchange data with other programs. \$150. 30-day m/b guarantee. Demo \$10. IBM-PC or compatible.

FLEMING SOFTWARE

P.O. Box 528 • Oakton, VA 22124 • (703) 591-6451

Inquiry 776.

STATISTICS CATALOG!

If you need statistics for IBM PC or Apple II, call us and let our technical advisors help you find the statistics programs you need. Write or call now to get a FREE catalog of statistics and quality control software.

HUMAN SYSTEMS DYNAMICS

9010 Reseda Blvd., Ste. 222
Northridge, CA 91324

(800) 451-3030 (818) 993-8536 (CA)

Inquiry 777.

STATISTICS

STATISTIX™

\$75 - Satisfaction guaranteed

A comprehensive, powerful, yet easy-to-use statistical analysis system for IBM PC/XT/AT's, Apple II's, and MS-DOS machines. Clear 200p manual. Write for information.

NH ANALYTICAL SOFTWARE

801 West Iowa Ave., St. Paul, MN 55117
(612) 488-4436

Inquiry 778.

SAS®-like Power on a 256K PC

BASSBase runs many SAS programs on a 256K 2 floppy PC. **BASSStat** adds an expanded stat pack. **BASSView** gives a true windowing environment. Cks/MC/Visa. SAS a SAS Institute TM. **BASSBase**-\$95 If ordered by 6/30/87 **BASSBase/BASSView**-\$149 **BASSBase/BASSStat**-\$159 **BASSBase/Stat/View**-\$199

BASS Institute Inc.

P.O. Box 349, Chapel Hill, NC 27514
919-489-0729 BB: 919-489-9665(N,8,1)

Inquiry 778.

RATS! Version 2.0

RATS, the best selling Econometric software package, now includes daily and weekly data, a new easier to use 500 page manual, and many advanced features. Use RATS for time-series and cross-section regression, including OLS, ARIMA, VAR, logit, and probit. IBM PC or compatible. \$200. MC/VISA. Call for brochure.

VAR Econometrics, Inc.

P.O. Box 1818, Evanston, IL 60204-1818
(312) 864-1910

Inquiry 780.

UTILITIES

EditingTools 2.1

You certainly don't need another PC text editor. Yet **ET** can serve you better if the one you use now is a line, single file, or split-screen editor; or is too slow, big, and clumsy; or has no DOS shell and limits file sizes to 64K or less. \$35 + \$4 s/h. Demo \$5.

Jou Laboratories

P.O. Box 460969, Garland, TX 75046
214-495-8862 BIX: jou

Inquiry 781.

HANDS OFF™ PC SECURITY

- Locks Hard Disk. - Restricts Floppy Use.
- Protects Subdirectories.
- Normal Use of DOS Commands and Application Software.
- IBM PC, XT, AT and True Compatibles.
- DOS V2.0 and Higher. Hard Disk System.
- Keep Other Peoples HANDS OFF Your System

- \$89.95 VISA/MC

SYSTEM CONSULTING, INC.

314 Canterbury Dr., Pittsburgh, PA 15238
(412) 963-1624

Inquiry 782.

Recover deleted files fast!

Disk Explorer now includes automatic file recovery. You type in the deleted file's name, Disk Explorer finds and restores it. Disk Explorer also shows what's really on disk; view, change or create formats, change a file's status, change data in any sector. MS-DOS \$75 U.S. Check/Credit card welcome.

QUAID SOFTWARE LIMITED

45 Charles St. E. 3rd Fl.
Toronto, Ontario, Canada M4Y 1S2
(416) 961-8243

Inquiry 783.

UTILITIES

Protect your hard disk data!

Second Chance protects hard disk data files by making fast reliable backups. Second Chance is from Quaid Software, the makers of CopyWrite, so you can count on the same reliability speed and ease of operation you're used to with CopyWrite. MS-DOS \$75 U.S. Check/Credit card.

QUAID SOFTWARE LIMITED

45 Charles St. E. 3rd Fl.
Toronto, Ontario, Canada M4Y 1S2
(416) 961-8243

Inquiry 784.

AT'S DON'T NEED 360KB DRIVES

The 1.2mb drive has long been known to READ but NOT reliably WRITE on 360KB floppies. With "CPYAT2PC"™ 1.2mb drives CAN reliably WRITE 360KB floppies saving a slot for a second hard disk or backup tape. "CPYAT2PC" (Not Copy Protected) offers the preferable SOFTWARE SOLUTION. ONLY \$79 + \$4 S/H VISA/MC/OD UPS B/R

MICROBRIDGE COMPUTERS

655 Skyway, San Carlos, CA 94070
Order toll free 1-800-621-0851 x777
415-593-9777 (CA) 212-334-1858 (NY)
TELEX EZLNK 62873089 Dealer inquiries invited

Inquiry 785.

CONCURRENT DOS BACKUP

BackPack™ runs like BACKUP/RESTORE and supports DOS and CP/M media as well as users. Backs up and restores up to 1000K/min. on an AT and 360K/min. on an XT. Supports release 4.1. Also available on CP/M-80 and CP/M plus. \$150.

Bright Light, Inc.

520 Fellowship Rd. #C301, Mt. Laurel, NJ 08054
(609) 778-0772

Inquiry 786.

SOURCE CODE LIBRARIAN & REVISION CONTROL SYSTEM

TLIB™ keeps ALL versions of your program in ONE compact library file, even with hundreds of revisions.

- 5 times faster than SCCS
- LAN compatible
- Free public domain MAKE (with source) by L. Dyer

MS/PC-DOS 2.x & 3.x. \$99.95 + \$3 S&H. VISA/MC

BURTON SYSTEMS SOFTWARE

POB 4156, Cary, NC 27511
(919) 469-3068

Inquiry 787.

PADLOCK/PADLOCK II DISKS

PADLOCK furnishes the user with a method for providing protection against unauthorized duplication from DOS commands \$99. PADLOCK II disks come preformatted with finger-print and serialization. PADLOCK II disks offer superior protection. Ask about our HARD DISK protection with uninstall capability. MC/VISA.

GLENCO ENGINEERING

3920 Ridge Ave., Arlington Hts., IL 60004
(312) 392-2492

Inquiry 788.

TEXT SCANNING UTILITY

Stand-alone assembly language utility for word processing users. This high-speed full-screen text reviewer can scan through text forwards and backwards on a line or page basis, search for unlimited items, and print out text. Review whole documents in seconds. Handles text files from Wordstar and most other word processors. The following automated computer coursework is also available based on the above high-speed text scanning utility. • Using computers in the church • Computer basics for churches. We also have the Bible Name Game with 18 different 20-question games. For IBM PC, XT, AT and compatibles. All items are \$9.95 each plus \$2 p/h per order.

Hoffman Associates (609) 795-9467
5 Sussex Ave., Cherry Hill, NJ 08003

Inquiry 789.

THE BUYER'S MART

UTILITIES

STILL RIVER SHELL

Visual shell for PC/MS-DOS. Point & Shoot Power. V1.33. Only \$9 for shareware diskette. \$35 manual & diskette. MC/Visa accepted.

Bob Howard

PO Box 57, Still River, MA 01467
617-456-3699

Inquiry 790.

UTILITIES

PAL FOR SIDEKICK!

Personal Appointment Locator automatically shows coming appointments, searches your file, maintains to-do list, automatically repeats appointments, examines multiple files. Resident alarm too! Only \$49.95. Cheap at twice the price!

PAL SOFTWARE

Ste. 12B 110 Green St., New York, NY 10012
212-334-9172 1-800-541-0900
(In CA.) 1-800-334-3030

Inquiry 792.

WORD PROCESSING

HEBREW / GREEK / ARABIC

Russian and European Languages. Full featured, multi-language word processor supports on-screen foreign characters with no hardware modifications. \$350 (dot matrix) or \$500 (laser) + \$5 s/h. Or send \$15 + \$4 s/h for demo. Req. 512K/graphics

Gamma Productions, Inc.

710 Wilshire Blvd., Suite 609, Santa Monica CA 90401
(213) 394-8622

Inquiry 794.

FILE GENIE™

File Genie™ is a file conversion system which gives you the necessary tools to easily analyse and convert any file to a new structure. Ideal for re-structuring unusable data or word processing files. Search and replace in multiple files using "wild card" file descriptions. MS/PC-DOS. \$69.95 M/C VISA

TEAM AUSTIN, INC.

6809 Conroy Ct., San Diego, CA 92111
USA 800-822-0852 (In CA) 800-822-0853

Inquiry 791.

PRINTER! CACHE! RAMDISK!

PRINT-matic (\$16) sends predefined control codes to any printer from within applications AND allows you to change fonts while printing. WARP-TEN (\$16) is a programmable disk cache that speeds up your PC disk accesses. RAMbak (\$16) automates the saving of new or changed RAM disk files to floppy disks and/or hard disk subdirectories. PC, XT, AT, compatibles with 256K DOS 2.0+ (MN Res. + 6%). NCP

Software Brewing Company

P.O. Box 12094, St. Paul, MN 55112
612-636-2727 Visa/MC/CHK

Inquiry 793.

¿Escribe en español?

Then you need Escribén® 2.0, the Spanish-language spelling checker.

- 300,000 words, expandable
- Knows Spanish grammar
- RAM-resident or stand-alone
- Handles documents of any length
- Versions for WP, MM, and WS-ASCII
- 129.95 VISA/MC/AMEX

1-800-221-7418

IBERSOFT INC.

P.O. Box 3455, Trenton, NJ 08619
(609) 890-1496 Telex 6502635518

Inquiry 795.

Advertise your computer products for as little as **\$375** in THE BUYER'S MART
For more information call
Mark Stone at BYTE **603-924-3754**

TRI STATE COMPUTER

160 BROADWAY, NEW YORK, NY 10038

(Bet. Maiden Lane and Liberty St.)

(212) 349-3134 • Open weekdays 9-6, Sunday 10-4

CALL TOLL FREE ORDERS ONLY 1-800-221-1926

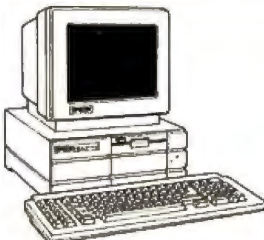

IBM AT 30 MB Hard Drive
256K 1.2 Drive Seagate 4038
IBM AT Keyboard\$2849.95
IBM XT 256K-1-360K Drive
Enhanced Keyboard\$349.95
As Above with 20 MB ..\$1299.95
AT&T 6300
640K-1360K Drives, monitor
with Keyboard\$1199.95
As Above with 20 MB ..\$1599.95
LEADING EDGE Model D
Original 30 MB System
w/monitor\$1795.95
LEADING EDGE
Dual Floppy\$1199.95
PANASONIC BUSINESS
PARTNER XT FX 600
256K expandable to 640K
1-360K Drive, 20 MB HD \$999.95

PLUS 20MB
Hard Card\$549.95

TOSHIBA T3100
in stock\$2749.95
TOSHIBA T1100 Plus with
640K NEW SCREEN\$1449.95
BROOKLYN BRIDGE\$99.95
ZENITH Z 181
in stock\$1699.95
NEC multi-speed
Laptop\$1349.95

EPSON EQUITY I
256K 1-360K drive, with monitor
& video card, DOS & BASIC,
parallel & serial ports\$749.95
1-360K, 1-20 MB
Hard Drive\$1049.95
EPSON EQUITY II
640K/300K Drive
20 MB Hard Drive
w/mono-monitor\$1449.95
w/color monitor\$1649.95

FACSIMILE FAX MACHINE
Canon FAX Phone #10\$1144.99
XEROX Model #7010\$1799.99

PRINTERS

IBM Pro Printer XL\$509.95
IBM Pro Printer\$339.95
New Epson LX 86\$179.95
Epson FX 86E\$329.95
Epson FX 286E\$464.95
Epson LQ 800\$419.95
Epson EX 800\$389.95
Epson EX 1000\$509.95
Epson LQ 2500\$959.95
Panasonic KXP 1080i\$174.95
Panasonic KXP 1091\$224.95
Panasonic KXP 1092i\$259.95
Panasonic KXP 1592\$379.95
Panasonic KXP 1595\$449.95
Panasonic KXP 3131\$229.95
Panasonic KXP 3151\$359.95
OKI ML 192\$274.95
OKI ML 192 Plus\$315.95
OKI ML 292e\$359.95
OKI ML 293e\$484.95
OKI ML 193 Plus\$479.95
Toshiba P321 P/S\$389.95
NEC P6\$389.95
Toshiba P34E\$629.95

Toshiba 351 Model 2\$799.95
NEC F7\$539.95
Silver Reed EXP 800\$619.95

LASERS

NEW HP Laser Jet,
Series II\$1695.95
HP Laser Jet 500 Plus\$3179.95

SOFTWARE

Bank Street Writer\$49.95
Dac Easy Accounting\$47.95
D Base 3 Plus\$369.95
Fast Back\$89.95
Flight Simulator\$32.95
Framework II\$369.99
Lotus 123 version 2.01\$289.99
Managing Your Money 3.0\$104.95
Word Perfect 4.2\$67.95
Microsoft Windows\$259.95
Microsoft Word\$259.95
Multimate 3.3\$199.95
Multimate Advantage\$239.95
Word Perfect 4.2\$189.95
Word Perfect Library\$49.95
R Base Systems 5\$329.95
Inset II\$59.95

MC & VISA ACCEPTED
NO ADDITIONAL CHARGE

Software Carousel\$34.95
Print Shop\$39.95
Sideways\$39.95
Turbo Lightning\$59.95
Reflex\$99.95
Carbon Copy\$119.95
Superkey\$39.95
Prolog\$67.95
Laser-Income Tax\$49.95
Travelling Sidekick\$42.95
Think Tank\$99.95

MACINTOSH SOFTWARE
AVAILABLE

IBM AT 339 compatible
10MHz 12 Drive 640K
20MB Drive\$1349.95

MODEMS
Everex 1200B\$99.99
Everex 2400B\$179.99
1200 External\$129.99
2400 External\$299.99



All items subject to availability and price changes. Mail and phone orders C.O.D., MC and VISA, S&H extra. Not responsible for typographical errors. All systems fully tested and installed by Tri State Computer. Printer price w/purchase of cable only.

Special to BYTE readers — Full Size Printer Stand \$12.95

PC Network / THE NATION'S LARGEST COMPUTER PRODUCTS MAIL ORDER COMPANY!

THE™ EGA CARD

100% IBM™ EGA/CGA/MGA compatible. Perfect for high resolution graphics, printer port w/256K standard.

Wholesale Price **\$165⁰⁰*** (356) Shipping

THE™ MULTI 384

100% AST™ compatible. Capable of 0-384K additional memory, w/R232 ser/par/game port, clock/calendar. w/OK

Wholesale Price **\$67⁰⁰*** (250) Shipping

THE™ 2MB RAM CARD

Meets Lotus™/Microsoft™/Intel™ specs. RAMdisk, print spooler, software included. w/OK.

Wholesale Price **\$99⁰⁰*** (250) Shipping

THE™ MULTI I/O

100% AST™ I/O compatible w/serial, parallel and game ports standard, second serial port optional.

Wholesale Price **\$60⁰⁰*** (250) Shipping

THE™ PC Starter System

A Complete System, Everything You Need to Start Computing



"THE™ PC+ is well built and has enough company support behind it to make it a very attractive alternative to higher priced competition."

"THE's™ bottom line? The PC+ is a highly compatible clone worthy of consideration..."

PC WORLD

"...the unit quickly became the preferred computer in our office, which has several name brands as possible alternatives..."

Computer Dealer



"...Computer Magazine Reader PoU..."



Computer: THE™ PC+ 256K w/Mono Graphics Adapter on Printer Port

Monitor: High Res (1100 Li) Amber TTL

Printer: Name Brand w/Graphics and Letter Quality Modes

Software: MS-DOS 3.2, GW Basic, Word Processor, Spreadsheet, Database, and Communications

Accessories: 10 Diskettes and Necessary Cables

\$828⁷⁰* (Shipping \$18.00)
CERTIFIED™
100% IBM™ PC
COMPATIBLE

THE™ PC Base System

256K upgradeable to 640K RAM w/360K Disk Drive, Turbo Speed, AT Style Keyboard

CERTIFIED™
100% IBM™ PC
COMPATIBLE **\$444⁰⁰*** (Shipping \$9.50)

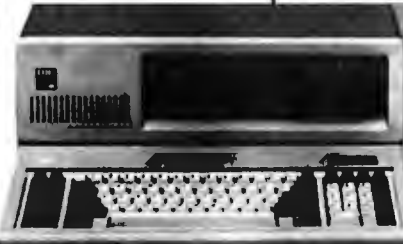

* MEMBERS PAY WHOLESALE + 8% OR LESS AND GET 14-30 DAY SOFTWARE RENTALS AND CATALOG

THE™ BEST BUYS in Modems

100% Hayes Compatible

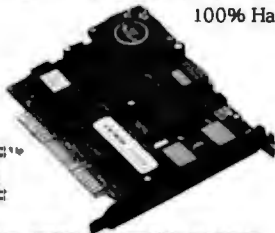

THE™ 1200 COMM INTERNAL

Features auto answer, dial/re-dial, built-in speaker w/volume control and FREE software.

Wholesale Price **\$88⁰⁰*** (250) Shipping

THE™ 2400 COMM INTERNAL

Wholesale Price **\$197⁰⁰*** (4 26) Shipping

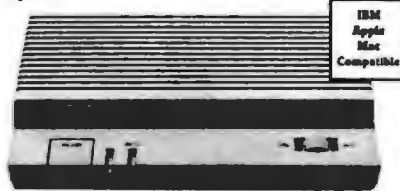

THE™ 1200 COMM EXTERNAL

With the same features as the internal modems these are perfect add-ons for IBM, Apple and other systems.

Wholesale Price **\$119⁰⁰*** (257) Shipping

THE™ 2400 COMM EXTERNAL

Wholesale Price **\$220⁰⁰*** (4 75) Shipping

THE™ Disk Storage Units

20MB Hard Disk Subsystem

1/2 Height Hard Disk w/controller card, cables and manual.



Wholesale Price **\$330⁰⁰*** (7 50) Shipping

THE™ 20MB Hard Disk on a Card

3.5" 20MB Hard Disk and Controller on a single card.



Wholesale Price **\$375⁰⁰*** (8 10) Shipping

MON.-FRI. 8am-7pm (CST) SAT. 9am-5pm
PERSONAL COMPUTER NETWORK
320 West Ohio Street, Chicago, Illinois 60610-9934

PC Network Members pay just 8% above the wholesale price, plus shipping. All prices reflect a 3% cash discount. Minimum shipping \$2.50 per order. International orders, call, for shipping & handling charges. Money orders, personal and company checks please allow 10 working days to clear. All prices subject to change without notice. Products subject to availability.

(800) 621-SAVE

(For Orders, Membership and Advice!) In Illinois (312) 280-0002
For Customer Service & Order Status: (312) 280-1567

Validation # B357



1 YEAR WARRANTY on PARTS and LABOR
45 DAY MONEY BACK GUARANTEE

PC Network

THE NATION'S LARGEST COMPUTER PRODUCTS MAIL ORDER COMPANY

PAY WHOLESALE SOFTWARE AND GET

The World's #Supplier of Everything for the Program Developer

Arty Expert System Development Package	\$235.00*	Central Point Copy II PC	\$20.00*	Microsoft Cobol Tools	\$186.66*	Ryan McFarland Cobol 8X Runtime	\$189.00*
Arty File Interchange Toolkit	37.00*	Compuview Vedit	95.00*	Microsoft Basic Interpreter for Xenix	193.80*	Ryan McFarland Cobol Network Full System Ver 2.1	799.00*
Arty Prolog Compiler and Interpreter	650.00*	Compuview Vedit + w/windowing capabilities	145.00*	Microsoft Basic Compiler	219.30*	Ryan McFarland Cobol Network Runtime Ver 2.1	338.00*
Arty Prolog Interpreter	275.00*	Fifth Generation Fastback w/50 DS/DD Diskettes	85.00*	Microsoft C Compiler	244.00*	Softcraft Xtrieve Ver. 3.0	175.00*
Arty SQL Development Package	235.00*	Human Edge Software Expert Edge	374.25*	Microsoft Cobol Compiler	386.58*	Softcraft Xtrieve	156.00*
Arty Screen Design Toolkit	37.00*	Lattice C-Compiler 3.1	250.00*	Microsoft Fortran Compiler Xenix	319.26*	Softcraft Rtrieve	106.00*
Arty Standard Prolog	70.00*	Lattice C-Sprite Debugger	115.00*	Microsoft Fortran Compiler PC	263.92*	Softcraft Rtrieve Network Version	249.00*
Blaise Asynch Manager for C or Pascal	115.00*	Lattice C-Food Smorgasbord	82.00*	Microsoft MULISP, MUMATH or MUSIMP	183.60*	Softcraft Xtrieve or Btrieve, Network Version	418.00*
Blaise C Tools/Tools 2 Combo Pack or CTools Plus	115.00*	Lattice Sidetalk	79.00*	Microsoft Macro Assembler 4.0	86.39*	Softlogic Solutions Disk Optimizer Double DOS, Cubit	28.00*
Blaise C Tools or Pascal Tools	85.00*	Lattice DBC-III Library	137.00*	Microsoft Pascal Compiler for Xenix	400.25*	Software Channels Alice	59.00*
Blaise C Tools 2 or Pascal Tools 2	65.00*	Lattice RPG-III Compiler	410.00*	Microsoft Pascal Compiler for PC	158.10*	Software Gardens Dan Bricklin's Demo Program	55.00*
Blaise Exec Programmer Chainer	65.00*	LogiTech LogiMouse +	89.00*	Microsoft Sort Facility	117.00*	STSC APL+Plus/PC System	370.00*
Blaise Pascal Tools/Tools 2 Combo	115.00*	LogiTech LogiMouse + w/PC Paint	117.00*	Microsoft Programmer's Tool Kit for Windows	295.00*	STSC Statgraphics	520.00*
Blaise Runoff	35.00*	LogiTech LogiMouse + w/Generic CAD	139.00*	MLI Disk Mechanic	40.00*	STSC Pocket APL	69.00*
Blaise Turbo Asynch + or Power Tools +	65.00*	LogiTech LogiMouse + w/Reflex	145.00*	Morgan Computer Professional Basic	70.00*	Summit Software Better Basic	119.40*
Blaise View Manager w/Source for C or Pascal	185.00*	LogiTech LogiMouse + w/Generic CAD & PC Paint	158.00*	Morgan Computer Trace 86	77.50*	Summit Software 8087 Math Module	59.00*
Borland Reflex, Turbo C or Turbo Basic	54.00*	LogiTech Modula-2/86 Compiler	55.00*	Peter Norton Norton Utilities 4.0	45.00*	Summit Software Runtime System	150.00*
Borland Reflex and Workshop Bundle	80.00*	LogiTech Modula-2/86 Compiler w/8087	85.00*	Peter Norton Norton Utilities Advanced Edition	70.75*	True Basic Algebra, Trig, Pre-Calculus & Calculus	27.00*
Borland Reflex Workshop	38.00*	LogiTech Modula-2 Runtime Debugger	142.00*	Peter Norton Norton Commander	33.00*	True Basic Async Com Lib or Btrieve Interf ace Lib	27.00*
Borland Turbo Database or Editor Toolbox	36.50*	LogiTech Modula-2 Source Package	48.42*	Phoenix PFinish, PFix 86 Plus, or PForce	210.00*	True Basic Developer's Toolkit or Chippendale	27.00*
Borland Turbo Gameworks or Graphix Toolbox	38.00*	LogiTech Modula-2 Translator, Utilities Pkg or Window	79.00*	Phoenix PLink-86 Plus	299.00*	True Basic DEXNET Math, Form Lib or Probability	27.00*
Borland Turbo Lighting	52.00*	Micro Focus CoGraphics	199.00*	Phoenix PMate or PTE/C	119.00*	True Basic Hercules Graphics Support Lib	27.00*
Borland Turbo Pascal w/8087 & BCD Support or Prolog	53.00*	Micro Focus CoMath	150.00*	Phoenix Pre-C	160.00*	True Basic PC Basic Converter Library	27.00*
Borland Turbo Tutor	21.25*	Micro Focus CoMath	199.00*	Phoenix PForce for Lattice C or Microsoft C	210.00*	True Basic Sorting Searching or String Lib	27.00*
Borland Word Wizard	38.00*	Micro Focus Forms-2	245.00*	Ryan McFarland Fortran 77 Compiler	327.00*	Wordtech True Basic	89.94*
Borland Word Wizard and Turbo Lightning Bundle	81.00*	Micro Focus Micro/SPF	140.00*	Ryan McFarland Cobol Full Development	520.00*	Wordtech Systems Hot C Compiler	59.00*
Bourbaki, Inc. 1 DIR +	42.50*	Micro Focus Multiter Runtime for PC Net	400.00*	Ryan McFarland Cobol Runtime	150.00*	Wordtech Systems DBXL	80.00*

MICROSOFT. WORD 3.1



Latest Version, Now Includes Spell Checker and Thesaurus

\$233.50*
(Shipping \$5.04)

MICROSOFT. WINDOWS



Work on Several Projects at Once, Easily Move and Consolidate Info

\$54.00*
(Shipping \$2.50)

MICROSOFT. QUICK BASIC



Compiler Compatible w/BASICA Programs & Runs Them 10X Faster

\$54.00*
(Shipping \$2.50)

America's Favorite Business Software
For the IBM and Compatibles



Lotus 1-2-3

Lotus Spreadsheet

\$285.00*
(Shipping \$6.16)

DBase III

Ashton-Tate Database

\$375.00*
(Shipping \$8.10)

Word Perfect

Satellite Software Word Processor

\$185.00*
(Shipping \$4.00)

ORCHID



286E

w/1MB of RAM, Expandable to 2 Socketed for 80287, PC/XT/AT Compatible, 2.5 Times AT Speed!

\$650.00*
(Shipping \$14.04)

AST



Advantage

128K, 1.5MB 1 Ser/1 Par Port Optional, Game and Second Serial Port

\$325.00*
(Shipping \$7.02)

PARADISE



Autoswitch EGA

\$336.00*
(Shipping \$7.26)

Modular Graphics Card **\$219.00***
(Shipping \$4.73)

THE™ Amber Monitor



Features dual mode operation (both TTL or RGB connection) as well as 1200 line resolution.

\$85.00*
(Shipping \$2.50)

DISKETTES

Guaranteed for Life!
Brand Name Diskettes available in boxes of 10 or bulk packs of 50

5 1/4" DS/DD **\$7.95***
Box of 10
3 1/2" SS/DD **\$12.50***
Box of 10
Free Flip & file Case

HEWLETT PACKARD

NEW!



Laser Jet Series II

8 Pages per minute, more resident fonts than the LaserPlus, smaller, lighter and quieter too!

CALL

OKIDATA



Laserline 6

6 Pages per minute, 300 dots per inch, 15 fonts (Requires Identity)

\$1380.75*
(Shipping \$29.82)

EPSON



FX286E

132 CPS Letter Quality Mode, 200 CPS Draft Quality Mode

\$479.00*
(Shipping \$10.33)

BEST BUYS in Chips

64K Memory Upgrade Kits (9 Chips)

\$775*

256K Dynamic RAM Chips
128K AT Mother Board Chips
Intel 8087 8Mhz Co-Processor
Intel 80287 8Mhz Co-Processor

Intel 8087 Math Co-Processor

\$105.00*

ea. \$2.90*
ea. 3.90*
155.00*
235.00*

ALL CHIPS ARE GUARANTEED FOR LIFE

+8% OR LESS FOR HARDWARE AND 14-30 DAY SOFTWARE RENTALS!!! Inquiry 237

**THE™ BEST "AT" CLONE IN THE BUSINESS
POWER, PRICE, PERFORMANCE**

**THE™ 286/10 ⚡
Model I Base System**

With 1.2MB Floppy Drive,
Floppy/Hard Disk Controller

\$915⁰⁰*
(Shipping \$19.77)

**THE™ 286/10 ⚡
Model II Base System**

1.2MB Floppy Drive
Floppy Hard Disk/Controller
42MB 28MS Hard Drive

\$1,495⁰⁰*
(Shipping \$32.29)



**THE™ 286/10 ⚡
Base System
Norton Index SI 10.3**

Speed: 6 or 10 Mhz, Keyboard
or Toggle Switch Selectable

Memory: 512K Standard
Expandable up to 1MB
on Mainboard

**Phoenix BIOS
84 Key "AT" Keyboard
200 Watt Power Supply
Full Size "AT" Case**



Other Configurations Available

\$690⁰⁰*
(Shipping \$14.91)

Hard Disk D

30MB Internal
Hard Disk

\$445⁰⁰*
(Shipping \$9.62)

71MB Internal
Hard Disk, 28MS

\$799⁰⁰*
(Shipping \$17.26)

80MB Internal
Hard Disk, 28MS

\$899⁰⁰*
(Shipping \$19.42)

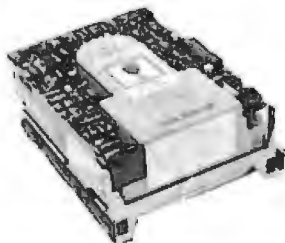

42i

28MS **\$550⁰⁰***
(Shipping)



\$445⁰⁰*
(Shipping \$9.62)

HX-12
Color RGB

\$369⁰⁰*
(Shipping \$7.50)

MAX-12E
TTL/RGB

\$138⁰⁰*
(Shipping \$2.50)



\$489⁰⁰
(Shipping \$10.76)

12" Amber TTL **\$85⁰⁰***
(Shipping \$2.00)

13" RGB Color **\$275⁰⁰***
(Shipping \$3.99)

14" EGA w/
Tilt Swivel **\$435⁰⁰***
(Shipping \$9.50)



MULTISYNC
13" High Res
(800 x 560), RGB Monitor
w/Cables

\$530⁰⁰
(Shipping \$11.45)

SEE WHY OVER 250,000 HAVE JOINED, MAKING US THE NATION'S #1 SOURCE FOR EVERYTHING IN COMPUTING

- Wholesale + 8% Pricing
- 10 Day Returns On Hardware
- Free Technical Support
- Periodic Catalog Updates
- 24 Hour Bulletin Board
- 1000 + Software Title Rental Library

PC Network

320 West Ohio Street
Chicago, IL 60610-9934

(800) 621-SAVE

Validation Code B357

Our knowledgeable sales consultants
are on duty:

Mon.-Fri. Sat.
8am-7pm (CST) 9am-5pm

In Illinois Call (312) 280-0002

Customer Service and Order Status (312) 280-1567

Mon.-Fri. 8am-4:30pm

CALL TOLL FREE (800) 621-SAVE

In Illinois Call
(312) 280-0002

YES! Please enroll me as a member in the PC NETWORK™ and send my catalog featuring thousands of computer products, all at just 8% above DEALER WHOLESALER PRICES. I will also receive "THE PRINTOUT", a special periodic update on merchandise at prices BELOW even those in my wholesale catalog and all the other exclusive, money saving services available to Members. I am under no obligation to buy anything. My complete satisfaction guaranteed.

Please (✓) all boxes that apply:

- Basic Membership 1 Year 2 Year • Special V.I.P. Membership 1 Year 2 Year
- With 14 Days Rental \$8 \$15 With 30 Days Rental \$15 \$25
- Business Software Rental Library \$25 add'l. per yr. BOTH Business and Game
- Games Software Rental Library \$10 add'l. per yr. Software Rental Libraries \$30 add'l. per year

Bill My Credit Card: VISA MasterCard American Express Validation # **357**

Account Number:

Exp. Date: mon. yr.

Check or Money Order Enclosed for \$ _____

Name _____

Address _____ Apt. No. _____

City _____ State _____ Zip _____

Telephone: () _____

My Computer(s) is: IBM IBM XT IBM AT Apple II Macintosh Other _____

Signature _____

(Signature required to validate membership)

Copyright © 1986, PC NETWORK, INC

RENT BEFORE YOU BUY—Members are eligible to join the NETWORK'S Business and Game Software Rental Libraries and evaluate products for a full 14 Days (Regular Membership) or 30 Days (VIP Membership) to see if they meet their needs. The Network's rental charges are far less than other software rental services—just 20% OF THE MEMBER WHOLESALER PRICE! Rental titles are available in IBM, Apple and Mac.

The best diskettes at the best prices!

Don't waste your money on inferior products!

SuperStar™ diskettes are:

HIGH CLIP (65%+)...not ANSI (40%)!

American made...not cheap imports!

Backed by a real LIFETIME WARRANTY!

Yes, you can buy a cheaper diskette...but that's exactly what you'll be getting!

5.25" DISKETTES:

SSDD	.38 ea.
DSD	.38 ea.
SSDD-96TPI	.48 ea.
DSD-96TPI	.59 ea.
DSD-HD	1.16 ea.

3.5" DISKETTES:

SSDD	1.15 ea.
DSD	1.33 ea.

Order in multiples of 50 only. \$35.00 min.

1-800-621-6827

(In Illinois, 1-312-256-7140)

VISA/MASTERCARD ACCEPTED.

Dealer and Int'l Inquiries Welcome

DISK WORLD!, Inc.

629 Green Bay Rd., Wilmette, IL 60091

Inquiry 94

NEW!



SafeSkin™
KEYBOARD PROTECTOR

Remains in place during keyboard use. Prevents damage from liquid spills, dust, ashes, etc. Fits like a second skin, excellent feel. Available for: IBM-PC, AT, Apple (all), Compaq, Model 100, NEC 8201, C64, Zenith 150, DEC, Kaypro, KB5151, AT&T 6300, WYSE 50 and many others. Send \$29.95, check, M.O., Visa & MC include exp. date. Specify computer type. Dealer inquiries invited. Free brochure avail.

Merritt Computer Products, Inc.
4561 S. Westmoreland, Dallas, Texas 75237
(214) 339-0753

Inquiry 195



Sure it's insured?

SAFEWARE® Insurance provides full replacement of hardware, media and purchased software. As little as \$39/yr. covers:

- Fire • Theft • Power Surges
- Earthquake • Water Damage • Auto Accident

For information or immediate coverage call:

1-800-848-3469

In Ohio call 1-614-262-0559

SAFEWARE

SAFEWARE, The Insurance Agency Inc.

Inquiry 283

Serial Parallel



Convert What You Have To What You Want!

- RS232 Serial
- 8 Baud Rates
- Latched Outputs
- Centronics Parallel
- Handshake Signals
- Compact 3 1/2" x 4 1/2" x 1 1/2"

No longer will your peripheral choices be limited by the type of port you have available! Our new High Performance 700 Series Converters provide the missing link. Based on the latest in CMOS technology, these units feature full baud rate selection to 19.2K, with handshake signals to maximize transfer efficiency. Detailed documentation allows simplified installation. Order the Model 770 (SerPar) or Model 775 (ParSer) Today!

Buffer Products
Coming Soon!

ParSer
Model 775

only \$89.95

Computer Option \$10.00
CA Residents 8% tax
UPS Shipping \$3.00

3754C Johnson Dr.
Fruit Office Box 3777
Vermont, California 92606

CALL (805) 658-7466 or 658-7467

For FAST Delivery

Inquiry 322

9 TRACK TAPE SUBSYSTEMS
IBM FORMAT COMPATIBLE
PC/XT/AT to MAINFRAME
TAPE DATA EXCHANGE

- Read/Write data files to or from any computer on universally standard tape. Process archive files.
- Streaming and Start/Stop Systems.
- For all IBM compatibles.
- 800 NRZI, 1600/3200 PE, 6250 GCR.
- Fast, reliable read-after-write hard disk backup.
- Data Transfer Rate: 1 to 4 MByte/minute.
- Record Translation: EBCDIC/ASCII Conversion.
- Total system, all software & hardware supplied.
- Best installation and Software Support.

9Track Magnetic Tape System experience since 1971. We have supported hundreds of satisfied customer installations.

Write for complete information to:
Contech Computer Corporation
P.O. Box 153, Tarzana, CA 91356
Or call: (818) 343-6505

CONTECH

21000 Devonshire Avenue Suite 110
Chatsworth, CA 91311

Inquiry 75

ENCLOSURE POWER



* Floppy's, Hard Disk, Optical Disk, Tape Drive, or any Combination

* Custom Design with Injection Molding Front

* Superb Quality and Pricing

* Prompt Delivery

JMR ELECTRONICS, INC.
The Power Source Behind The Drive

18559 1/2 Parthenia Street, Northridge, California 91324

Outside CA (800) 635-5555
CA (818) 993-4801

Inquiry 165

Tune-up your hard disk!

Vopt™
DISK ORGANIZER

FAST — EFFICIENT

Vopt organizes your hard disk into contiguous files for fast, efficient, time-saving use! Initial organization averages under 5 minutes; daily runs average under 1 minute!

CONVENIENT

Run it from your autoexec.bat file!

SAFE

Vopt's contiguous files are easier to recover if accidentally deleted! Vopt's speed allows files to be moved one-at-a-time, rather than taking chances on disk reliability. Detects and maps bad sectors.

GOLDEN BOW SYSTEMS

\$49.95

Add \$3 for S&H
California Residents
add 6% Sales Tax



2870 Fifth Avenue
Suite 201

San Diego, CA 92103

619/298-9349

Inquiry 132

PC Compatible CASH DRAWERS

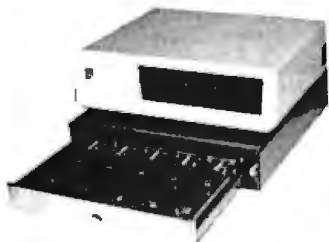

M-S CASH DRAWER

10711 Flower St., Stanton, CA 90680

(800) 544-1749

In California call:

(714) 821-1133

Inquiry 212

PC SOFTWARE

Public Domain & User Supported

- PC-Stock (Stock Trend Analysis) **\$6.00 Ea.**
- DiskTool (Disk modification utility)
- PC-Tickle (Disk calendar reminder)
- PC-Write 2.7 (Word processor with spell checker)
- Imageprint (Better quality from Epson/Okidata printers)
- Landing Party (Adventure with your favorite characters)
- PC-Accounting (2 disks-single entry accounting)
- Hem Radio #1 (RTTY/CW/ASCII. Sail location, and more)
- FT-ETC Genealogy (Produces several types of charts)
- Symphony WKS #1 (Bank, Insurance, & Medical Applic.)
- 123 Macros (A lot of 123 macros!)
- PC-Prompt (Memory resident DOS help utility)
- Mr Bill (2 disks-Professional Time Billing)
- Label Master Mail List Management System
- Misc. Games (Quarterback, Babies, Flightmare, Soviet & More!)

Try a Six-Pac

any six disks only \$29.95
(all orders add \$3.00 shipping & handling)
(credit card orders welcome, \$10.00 min. please)
Call or write for FREE catalog.

The above programs were written for the IBM-PC & PC-jr. will run on some compatibles. Be certain of compatibility before ordering.

Soft/Plus Research
759 S. State St., Ste. 109

Ukiah, CA 95482

(707) 462-3118

(800) 843-3882



Inquiry 302

Compu\$ave

Call Toll Free: 1-800-624-8949

BOARDS

ATI EGA Wonder	255	PC Serial Port	35
AST Rampage AT CALL		Prograppler	72
Chaufeur HT	185	Taxan Gold	299
NEC GB-1	329	Video 7 EGA	189
Paradise 480	372	Vega Deluxe	312
Genoa Super EGA	CALL	Verticom H16B	1525
Alloy Or Advanced Digital Slave Boards	SAVE		
Artist 1: 1024 x 768 (Interlaced)	1395		
ATI Graphics Solution	172		
Hercules Color Card	141		
Tecmar EGA Master 800	395		
Aristocad/Genoa/Number 9/Orchid	CALL		
Quadram/Sigma/STB/Vermont/Vutek	CALL		

MONITORS

Mitsubishi 6922	2125	Amdek 410	152
NEC Multisynch	545	Goldstar TTL	79
Taxan Multivision	549	IC 19" EGA	1399
Taxan 840	815	Magnavox RGB	299
Thomson 450A	165	PGS LM300	495
Wyse 700 W/Card	699	Zenith 1220	99
Microvitek 941 CN Monitor 20" PGA	1545		
Sigma Laserview 15" 1200 x 1664	1419		
Aydin/Casper Hitachi Sperry/Teco	CALL		

IMAGE SCANNERS

Datacopy Jetreader	1025
Datacopy Model 730	1395
PGS LS-300 With PC Paint & Adapter	729
PGS LS-300 With OCR Soft. & Adapter	995

COMPUTERS

AT&T 6300/1 Dr	1245	AST Model 80	1545
Sharp PC7000	945	AST Model 90	1929
Sharp PC7100	1899	AST Model 120	2299
Zenith 181	CALL	AST Model 140	2685
Cordata PC: Portable/ 2 Drives	895		
Cordata CS4200: 640K/ 1 Drive	1329		
Packard Bell AT: 640K / 30M Drive	1945		
Packard Bell AT: 640K/44M Drive	2125		
Panasonic Business Partner: 2 Drives	849		
Panasonic Business Partner: 20M Drive	1149		
Panasonic Bus. Partner 286: 1 Drive	1429		
Panasonic Bus. Partner 286: 30M Drive	2039		
Sperry IT: 1M/ 44M Drive	2799		
Toshiba 1100 + & 3100 Portables	CALL		
Wyse 286: 6&10 MHz/ 1.2M Drive	1595		
Wyse 286: 6&10 MHz/ 20M Drive	1995		
Wyse 286: 6&10 MHz/ 40M Drive	2395		
Wyse + Turbo: 640K/ 2 Drives	1019		
Wyse + Turbo: 640K/ 20M Drive	1465		
Altos/Corvus/ITT NEC/Televideo Others	CALL		

TERMINALS

Adds 10 10	299	Altos III	559
Freedom I Turbo	429	Ampex 232	485
IBM 3164 Color	895	Wyse 30	285
Kimtron KT7	412	Wyse 50	359
Televideo 905	285	Wyse 60	485
Televideo 955	395	Wyse 856	425
Hazeltine/Liberty Link/Dume/Zenith	CALL		

PLOTTERS

Houston 51 52MP	3695	Houston 41 42	2325
Houston PC595	499	Houston 51 52	3295
Houston PC695	569	Houston 56A	4195
Calcomp 1041GT	5295	Ioline 4000	4245
Hewlett-P.7475	1495	Roland 800	CALL
Cal. Plotmaster	4145	Roland 880	879
Enter SP1000	3095	Roland 980	1159
Gould-Taxan Other Brands & Models	CALL		

DIGITIZERS

Calcomp 44 x60	4995	GTCC: All	CALL
Hitachi 11 x 11	575	Kurta Penmouse	185
Hitachi 15 x 15	1195	Kurta 8.5 x 11	299
Houston TG1011	499	Kurta 12 x 17	699
Houston TG1017	595	Kurta 36 x 48	3595
Houston TG8036	2845	Summa 12 - 12	375
MS BUS Mouse	109	Summa 12 x 18	659
Mouse Systems PC Mouse / Serial	118		
Many Other Models and Mice	CALL		

MODEMS

Prometheus 2400G	249	Hayes 1200	348
Ven-Tel 2400 i	295	Hayes 1200B	309
Ven-Tel 2400 +	372	Hayes 2400	559
Zoom 1200ST	189	Hayes 2400B	479
Anchor Volksmodem 12/ External & PC	115		
Anchor Lighting 2400 External	295		
Practical 1200: Half-Card	125		
Racal-Vadic 1200 VP	235		
US Robotics Courier 2400 E	389		
Codex/Novation Rixon UDS Other Models	CALL		

PRINTERS

Alps ALQ-218	425	Alps ALQ-324	699
Citizen Premier 35	442	Citizen 1200	168
Citizen MSP15	355	Citizen MSP20	305
Citizen MSP25	455	Diconix 150	319
Citizen Tribute	639	Fujitsu 2600	1025
Panasonic 1080i	188	NEC P660	425
Panasonic 1091i	244	NEC CP660	525
Panasonic 1092i	318	NEC P760	595
Panasonic 1592	384	NEC CP760	689
Panasonic 1595	462	NEC P9XL	1195
Toshiba 352 II	955	Okidata: All	CALL
Data So./Diablo/Juki/Star/Televideo T1	CALL	Buffers Cables Sheet Feeders	LOW PRICES
Stands Switch Boxes Tractors	LOW PRICES		

LASER PRINTER HEADQUARTERS

Data Prod 1230	2599	AST Turbo	3295
Genicom 5010	2365	Canon LBP-A1	1935
Oki. Laserline 6	1425	CIE LIPS-10	2345
T1 Omni 2115	5895	NCR Laser	1925
Toshiba Page 12	2495	Dume Laser	2195

DISK DRIVES

Priam 130M Drive	2395	Apple Drives	112
Scribe 30M Card	475	Miniscribe 40M	599
Seagate 20M Kit	338	Miniscribe 80M	899
Seagate 30M Kit	389	Seagate 40M	599
Toshiba 3.5" Kit	115	Seagate 80M	945
Plus Development Harcard 20	599		
Alloy Fujitsu I OMEGA Maxtor Maynard	CALL		
Mountain Rodime Tallgrass Teac Tecmar	CALL		

**HOURS: MON-FRI 7AM-6PM / SAT 9AM-2PM
IN ARIZONA CALL (602) 437-4855**

Compu\$ave: 4207 S. 37th St., Phoenix, AZ 85040/Prices Reflect Cash Discounts And Are Subject To Change Without Notice. Major Credit Cards And Selected PO's Are Accepted. We Cannot Guarantee Compatibility. Compu\$ave Is A Division Of Adlanko Corporation.



Brice Rambaum

To Explore, Enjoy, and Protect

You and I share a great love of this earth.

The ocean's pounding surf, Spring covering the earth with that season's newness, a bird's song reaching out. . . and we are moved.

We enjoy the earth's beauty, its grandeur. The endless sweep of colors, and sounds, and everywhere, the excitement of life.

And we of the Sierra Club join together to protect the earth.

We invite you to join with us. To explore, to enjoy. To protect this wondrous earth. For all of us. . . forever.

For membership information, write Sierra Club, 530 Bush Street, San Francisco, CA 94108, (415) 981-8634.



Sierra Club

8051 PASCAL CROSS COMPILER

For MS-DOS Computers

SCIENTIFIC ENGINEERING LABORATORIES
104 Charles Street, Suite 143
Boston, MA 02114 Tel 617 262 3903

Inquiry 285

MAXELL BULK DISKS

5 1/4" DS/DD **59¢**

3 1/2" DS/DD **1.29**

5 1/4" DS/HD **1.59**

Price based on quantity of 300
includes sleeves, labels and tabs.

800-222-0490
In NJ 201-462-7628

• 24 Hour Shipment •

MEGASoft

P.O. Box 710, Freehold, NJ 07728
Full service duplication facility

Inquiry 193

Incredible!
64K Printer Buffer
with cable
\$69 Plus \$3 shipping & handling

30-day
money back
guarantee
plus 1-year
warranty



Works with any standard Centronics parallel interface • Reset button • Multiple copy repeat function • Auto diagnostics • Self-test

Order by Check/MO or VISA/MC/AX
Call Toll Free
USA: 800-533-8049
CA: 800-624-5628
330 Central Avenue • Fillmore, CA 93015

Inquiry 54



SPECIALISTS

We provide computer products for the QNX user. All products sold by us have been tested in our offices and will work with QNX in both multi-user and network mode.

- All of Quantum's fine products \$call
- SOFTWARE -----
- T&T: IS screen/menu devlopment pkg \$ 295
- IS with source \$ 595
- T&T Teach Authoring & Course Dev \$ 295
- Btree balanced tree file mgr \$ 250
- Sculptor 4gl Database by mpd \$ 995
- ZIM dba: Ultimate flexibility \$1195
- WPro Word Processing \$ 149
- YAS Spread Sheet \$ 214
- DASNET Wide Area Network nodes \$ 40
- HARDWARE -----
- ARCNET bds for QNX network \$call
- Iomega Bernoulli Box w/ driver \$call
- QNXT terminals: Klatron RT-7 PC \$ 695
- Keynote PC \$ 750
- RS232 multi-port serial boards \$ 395

Consultants available. Call us.



Ask about our specials!

T&T Computer Products
Post Office Box 33213
Tulsa, Oklahoma 74153
(918) 663-1879
QNX is a registered mark of Quantum

Inquiry 325

Get into Animation
Desktop Publishing
Video Production
NOW!

ATTN: TARGA USERS

Find out about
the many options that
will turn your TARGA board
into a more powerful system.

Benefit from the largest and most knowledgeable TARGA System Integrators. Get the **Crayon 2.5D** Animation Program that uses TIPS (No Additional paint program to buy or learn).

Turn your PC into a powerful video system: Paint Box, Rotoscoper, Animator, Titrer, Character Generator or Desktop Publisher. Call: JANE JENKINS today!

Crayon Graphics Center
756 N. La Cienega Blvd., L.A., CA 90069
(213) 657-2322 Fax (213) 657-5658

Inquiry 77

EPROM PROGRAMMER \$349

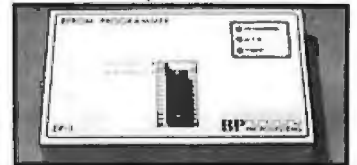

The EP-1 is a great value, here's why:

- IBM PC Software included or RS-232 to any computer
- ASCII Command driven operation. All intelligence in unit
- Reads, Programs. Copies over 160 types from 2716 to 27512
- Optional Intel microcontroller programming head
- Menu-driven Chip Selection, No Personality Modules
- Fast, Slow, Quick-Pulse Programming Algorithms
- Intel (8080 & 8086), Motorola, Tekhex, Straight Hex Files
- Splits Files by Base Address and Odd/Even (16 bit systems)
- Gold Textool ZIF IC socket
- Generate & Set Checksums
- Over-Current Protection
- 8 Baud Rates 300 to 38,400
- Full One-Year Warranty
- U V Erasers from \$34.95
- Same Day Shipping

BP MICROSYSTEMS

10681 Haddington, #190 / Houston, TX 77043
(713) 461-9430 (800) 225-2102

Inquiry 45

PC/XT USERS!

- COGTREE Utilities by
 Cogitate \$129.95
- LYNC by Norton-Lamber \$199.95
- DATAFLEX by Data Access...Varies
- RMICOBOL by Ryan/
 McFarlandVaries
- Universe by Omnitrend....\$ 98.50
- Blue MacI by Cogitate\$599.00
- CadPower+ by Trilex\$995.00
- Softext Teaching Aids.....\$ 95.00
- PrintSet by Cogitate.....\$ 79.95
- CogITAPE by Cogitate.....CALL!!
- Anti-Static Products.....Varies
- Uninterruptible Power
 Backups.....Varies
- TeleVideo Software.....CALL!!

COGTATE

'A Higher Form of Software'
24000 Telegraph Road
Southfield, MI 48034
(313) 352-2345/Telex 386581

VISA/MASTERCARD ACCEPTED
Dealer Inquiries Welcomed

Inquiry 61

IBM PC/VT220

- EM220** \$169
- VT220, VT102 emulation
 - File Transfer
 - 132 Column modes
 - Color Support
 - Hot Key

TEK 4010/4014

- EM4010** \$249
- Tektronix 4010 emulation
 - VT220, VT102 emulation
 - Picture files
 - High resolution hardcopy
 - Supports IBM, IBM Enhanced, Hercules, Techar and AT&T.



DCS
3775 Iris Ave., Suite 1B
Boulder, CO 80301
(303) 447-9251

Trademarks: VT101 Digital Equipment, IBM PC, XT IBM Corp.

Inquiry 97

Let's talk PHONETICS

Is it **Laurie** or **'Lawry**
or **Lowery** or **Lowry** or...

How does it spell exactly?
it **NO longer matters with**
PHONKEY

- Compact, easy to use phonetic coding module. Efficient even with files of 250,000 names.
- A call to PHONKEY analyses person's names and returns a 16 bit code that you store as a phonetic key to retrieve your data. At query time, compute the target name code, then retrieve all data with the same code. Easy enough?
- Interfaces with most MS-DOS programming languages (BASIC, FORTRAN, Pascal, Asm).
- Comes with a 1,300 names file and programs to test the accuracy of the algorithm.
- Create your own files and see the results.

\$69.95 Add \$5 for shipping and handling
VISA/MC/COD accepted

30 day money-back guarantee. NOT copy protected

SYBIS INC.

1600 St-Martin Blvd E, Tower A, Suite 610
Laval, Quebec, Canada H7C 4R8 (514) 662-2227

Inquiry 312

BATTERY BACK-UP

Uninterruptible Power Supply



UPS-400

Great new power supplies to keep things going when the going gets tough. Automatic switch-over, internal battery and will run up to 250(400) watts for 10-15 min while you back-up. The UPS-250 can connect to a +12V car or boat battery for use as a 110VAC source continuously (150Watts cont.). The units have 85% efficiency, 5Ms switchover, light and buzzer alarm, 2 AC out lets, and full transient filtering.

- * Bare IBM PCB's
- * XT-AT Proto boards
- * XT-AT Extender
- * XT-AT Floppy Case

UPS-250
\$239.95

UPS-400
\$379.95

Dealer prices available

- * XT-AT Pwr Supplies
- * ATTAK-286, 4Layer
- * 10-12M Turbo AT
- * ASK FOR FLYER
- * EPROM PRGRMR

KEYTRONICS INT. INT

COMPUTER PARTS GALORE INC

56 HARVESTER AVE., BATAVIA NY 14020
TOLL FREE 800-431-9008, NY 716-343-6133

Anywhere in Canada 1-800-387-1385

FIND THE WIDEST RANGE OF DP WORKSTATIONS, ACCESSORIES & SUPPLIES IN THIS FREE GLOBAL GUIDE



←

...all at HUGE SAVINGS!

The GLOBAL GUIDE offers more variety than any office equipment, computer or software dealer; plus, toll-free order convenience. Use The Reader Service Number or dial 1-800-8-GLOBAL (That's 1-800-845-6225).

GLOBAL

COMPUTER SUPPLIES

45 South Service Road, Plainview, NY 11803

Inquiry 70

9-TRACK MAG. TAPE SUBSYSTEM FOR THE IBM PC/XT/AT AND...



For information interchange, back-up and archival storage, IBEX offers a 9-track, IBM format-compatible 1/2" magnetic tape subsystem for the IBM PC, featuring:

- IBM format 1600, 3200 and 800 cpl.
- Software for PC-DOS, MS-DOS.
- Also for DEC, VAX, VME, S-100, RS-232, IEEE 488.



IBEX COMPUTER CORP.
20741 Naranja St.
Covina, CA 91311
(818) 709-8100
TWX 910-493-2071

Write, please for information

Inquiry 148



6805/6305 SINGLE CHIP MICROCOMPUTER DEVELOPMENT SYSTEMS

Two systems allow the IBM PC/XT/AT to be used as a complete development system for the MOTOROLA 6805 series single chip microcomputers. Model MCPM-1 supports the MC68705P3, P5, U3, U5, R3, & R5 chips. Model MCPM-2 supports the MC1468705F2 & G2 cmos versions. Both systems are priced at \$495 and include a cross assembler program, a Simulator/Debugger program and a programming circuit board with driver software. A system is also available for the HITACHI 63705 ZTAT micro.

THE ENGINEERS COLLABORATIVE

P.O. Box 53, West Glover, VT 05875
(802) 525-3458

Inquiry 105

Inquiry 131

Printer (Data) Switch \$39/up

Dealer Price available



- Metal case
- Fully shielded
- Push button (2 layer PC board or rotary switch)
- Beige color
- 1 year warranty

CABLE (Lifetime warranty) \$9/up

- UL approved, molded, double shielded, beige color
- D type connector with thumb screw (screwless)

<p>Switch box</p> <p>2 way switch \$39/\$45</p> <p>2 way cross \$55/\$69</p> <p>4 way switch \$55/\$69</p> <p>Power center/DB 25 switch/swivel base \$89</p>	<p>Cable</p> <p>Printer cable 6'/9"/12' \$9/\$12/\$15</p> <p>Modem cable 3'/6' \$7/\$9</p> <p>Centronic cable 6'/10' \$12/\$15</p>
---	---

Serial cable, Drive cable & extension cable available

RS232 Miniature \$6/up
RS232 Break-out box \$59

JACO Computer Products
Tel: (408) 746-2000

989 E. California Ave.
Sunnyvale, CA 94086

Inquiry 158



REAL WORLD I/O

Affordable Access To The Real World For PC/XT/ATs

AD500 • 8-channel, 12-bit Analog Input Board
Software programmable gains of 1, 10, 100. Utilizes a highly stable A/D converter. Excellent accuracy and high noise immunity. 7 digital I/O lines. Ideal for lab/industrial automation. \$239

AD100 • Single channel version of AD500 with 10 digital I/O lines. Same programmable gain and high noise immunity. Useful for transducers, ATE, education. \$149

DG24 • Digital I/O board with 24 TTL I/O lines configurable in software. 8255 PPI based. \$95

XB40 • Extender board and cable for above boards. Includes easy connect terminal strip and prototype area. \$49

Software examples in Pascal, BASIC, Forth and Assembly.
Complete documentation and money back guarantee.

Real Time Devices, Inc.
 1930 PARK FOREST AVENUE
PO. BOX 906
STATE COLLEGE, PENNSYLVANIA 16804
(814) 234-8087

Inquiry 278

Best Prices
Best Service

HARDWARE

PANASONIC, TOSHIBA, AST, ATARI, COMPATIBLE COMPUTERS. CALL

MODEMS, BOARDS, DRIVES

Lotus Signal 429	Captain 384K 159
Evercom 1200 105	Advantage Premium 439
Evercom 2400 229	SixPakPlus 384K 209
Hayes Modems CALL	SixPak Premium 299
Practical Modem 1200 135	Intel Above Board PC 225
US Robotics 2400 189	Above Board AT 355
Genoa Spectrum Plus 249	Talltree J-Ram 3 189
Hercules Graphics + 179	Mach 10 w/Mouse 369
EGA Wonder 269	Seagate 20MB Kit 369
Everex EGA Enhancer 205	Seagate 30MB Kit 399
NEC GB-1 399	Seagate ST4038 569
Tecmar EGA Master 275	Filecard 20MB 569
Video 7 Vega Deluxe 359	Hardcard 20MB 665
384K RAM Card 85	Drivecard 30MB 649

OTHER HARDWARE

EPSON-All Models BEST	Sweet 1600 749
LX/FX/EX/LQ PRICES	Roland DRY-880 Plotter 899
Citizen Premiere 35 469	Houston Inst Plotters CALL
Tribute 224 659	Amdek 410G 159
Overture 110 769	Amdek 1280 w/card 749
Okidata Laserline 6 CALL	NEC 1401 Multi-Sync 569
Panasonic 10911 279	Quimox DM14 139
Panasonic 10921 359	SonyKV1311 RGB/TV CALL
Panasonic P3131 269	Sony 1302 Multi-Scan CALL
Summasketch 1201 379	Samsung TTL 85
Tiger Tablet II 619	Taxon 760 569

SOFTWARE

— SPREADSHEETS — — ACCOUNTING —

Framework II CALL	Acct Partner Plus 399
Latus/Symphony CALL	BPI Gen. Acct. 159
HAL 107	Complete Bus Actng 159
Open Access II 305	DAC EZ Accounting 44
Ability 61	OpenSystemsV3/Mod 449
Mosaic Twin 55	Real World CALL
PFS: Pro Plan 139	
Silk 83	

WORD PROCESSING

Manuscript 349
Microsoft Word 3 269
dBase III Plus CALL
Multimate Advantage 269
Genier 215
Word Perfect 209
Javelin 135
PFS: First Choice 102
Rapid File 255
PFS: Pro Write 115
Paradox 419
Wordstar Pro 249
R Base System V 359
Reflex 83

— DATABASE — — UTILITIES —

Revelation 519	Microsoft C 269
PFS: Pro File 139	Quick Basic 60
Q & A 219	Turbo Pascal 59
	Turbo C 59

— GRAPHICS —

Click Art Pers Publisher 79	Desqview 59
Harvard Pro Publisher 399	Windows 59
Page Perfect 395	DS Backup + 42
Ventura 599	Carbon Copy 117
First Impression 389	Mace Utilities 59
EGA Paint 47	Melro 63
Fantasy 43	Norton Utilities 55
Freelance Plus 339	Pap-Up Desktop 43
Harvard Prod Graphics 229	Disk Optimizer 32
Generic Cod 69	Xtree 31
ProDesign II 169	Statgraphics 449
Show Partner 48	Total Project Manager II 309
Dr. Hoto 11 w/Mouse 105	What's Best CALL

800-662-2686

orders only
for Ca. Orders, Tech Support 415-668-9350
Call or Write for Free Catalog

PAYMENT: No Fee For Visa, MasterCard, Cashier's Checks, Personal Checks with 2 week hold, Qualified P.O.'s CA orders add sales tax.
SHIPPING: UPS ground-2% of order, \$5 min. UPS Blue-3% of order, \$7 min. Printers, Monitors, Computers — Call for charges.
All Products New with full warranties.
Price & availability subject to change without notice.



584 CASTRO ST., SUITE 487 SAN FRANCISCO, CA 94114
a division of MCSS, Inc. Computer & Software specialists since 1981

Inquiry 36

S-100™

"THE PC PEOPLE"

10th Anniversary Specials

P C COMPATIBLE SYSTEMS

BBC

"FCC" APPROVED &
ONE YEAR LIMITED WARRANTY

BASIC CONFIGURATION: 10 MHz V20 CPU, Runs 3.3 Norton, 640KRAM, 8slots, 150W P/S, 360K Floppy, Mono/Graphics/Printer Board, "AT-Style" Case and Keyboard.....\$500
 360K HH Floppy Drive.....\$ 89
 Color/Graphics/Printer Card.....\$ 60
 DISK I/O 2 Floppy, S & P, G, Clk Ctrl.....\$ 80
 SAMSUNG 12" Amber Monitor.....\$ 85
 TATUNG MM-1422A 14" Dual Freq Green/Amb..\$139
 TATUNG EGA Monitor and Controller.....\$695

cordata

PC-400/20 with 20 Mb H.D. Drive.....\$1,195
 ATD-8-Q 8 MHz 80286, 640K, S,P, 1.2 Floppy \$1,495
 ATP-8-Q Portable Version of ATD-8-Q.....\$1,595

TATUNG

80286-10MHz 640KRAM, 1.2 Mb Floppy, 20 Mb Hard Drive, 210W P/S, S & P Ports, Mono Monitor, MS-DOS 3.2, GW-BASIC, Diagnostics.....\$2,195
 Same as Above with 13" Color Monitor and 5 Text Colors.....\$2,395
 Same as Above with 80 Mb Hard Drive.....\$2,995

WYSE

WYPC-286 10 MHz, 640K, S, P, 1.2 Floppy.....\$1,769
 WYPC-286-85 with 96Mb 28 mSEC Hard Disk \$2,899

NETWORKING

CONSULTATION AND
INTEGRATION QUESTIONS??

CALL OUR EXPERT SALES & TECH STAFFS!!
NOVELL ADVANCED NETWARE STARTER
KITS AND SERVERS.....CALL

6-User Network Special --- \$177/Mo.*

AST PREMIUM/286 Model 140 Server with 3G-Plus EGA Video Card, 44 Mb 28mSEC Hard Disk and 1.2 Mb Floppy Drives, 1Mb EEMS Memory, S & P Ports, Mono Monitor.
 NOVELLADV. NETWARE86 V2.0A 8-User UC.
 6 WD STARLAN Cards and Cables.
 5 B.B.C. WORK STATIONS "FCC" Approved with 4.77/8MHz 8088 CPU, 640K RAM, Mono/Graphic/Printer Controller & Monitor, "AT-Style" Keyboard, 360Kb Floppy Drive.
 RETAIL.....\$10,695 NOW ONLY....\$ 7,379

**Inter-Continental
Micro**

MS-CPS-PC PC/XT/AT SLAVE CPU CARD and Graphics Terminal with Software to Install in Novell Environment.....\$1,095
 MS-1000 Runs PC-DOS Card Terminal & S/ware.....\$795
 MS-CPS-PC Card, Terminal, Novell Install Disk \$1,495

ARCNET COMPATIBLE 1/2 CARD.....\$295
 8-PORT Active Hub.....\$449
 4-PORT Active Hub PC/Card.....\$225
 4-PORT Passive Hub.....\$ 49
 6-PAK Premium/256K While They Last and Going Up!.....\$199
 RAMPAGE-256.....\$275
 RAMPAGE-AT.....\$395
 RAMVantage 512K-2Mb.....\$259
 ADVANTAGE.....\$329
 3G-PLUS 256K, HGC, CGA, EGA.....\$335

**AST
RESEARCH INC.**



XEROX VENTURA WITH THE PURCHASE
OF AST PREMIUM PUBLISHER
TO INCLUDE:

AST PREMIUM/286 - 140 SYSTEM with 28 mSEC 44Mb Hard Disk & 1.2Mb Floppy Drives, Professional Keyboard, 3G-Plus EGA, 1.2 Mb EEMS Memory, S&P Ports, 6-8-10 MHZ "0" Wait States Running 11.5 Sys Info DOS 3.1, GW-BASIC, Mouse and 14" Soft White Monitor
 AST TURBOLASER (Ricoh Engine) Full Page Graphics in Less than 2 Minutes with Blacker Text and Sharper Images.
 AST TURBOSCAN Scanner with EYESTAR Software
 INTRODUCTORY OFFER.....\$ CALL

* 1 to 5 year leases available with purchase option to qualified businesses.

LASER PRINTERS

OKIDATA LASERLINE 6
 Ricoh Engine, 6 Pages per min.
 128K RAM (expands to 512K)
 Perfect for Text Intensive
 Applications.....\$1,699



H. P. LASERJET Plus Series 2.....\$ 2,149
 PCPI LASER IMAGE 2000 - Ricoh Engine, 8 Pages per min, 1.5 Mb RAM, 300x300DPI (full page)\$2,859
 XEROX 4045 LASER 512K RAM S & P Interface, 10 pages per min.....\$ 3,695
 AST TURBOLASER Ricoh Engine, 10 pages per min, 300x300 DPI, Great for Graphics.....\$ 3,495

POWER SYSTEMS & ACCESSORIES

P-15 MONITOR BASE with 5 A/C Plugs Noise & Surge and Modem Protected, Disk Storage.....\$ 75
 POWERSAVERS mfg by TOPAZ - UPS, True Sine Wave, 400, 800, 1000W Models.....FROM.....\$495

MONITORS & TERMINALS

**TATUNG® ONE YEAR WARRANTY AND
30 DAY D.O.A. SWAP-OUT!**

CM-1365 RGB 13" 5-Color Text---QTY 5.....\$319
 CM-1380F EGA 13" 640x350 G/A Switch.....\$439
 SUPREME EGA 256KEGA,HGC,CGA,MDA,132 \$229
 MM-1222A Green/Amber Hi-Res Mono TTL.....\$ 95
 MM-1422 Dual Frequency 14" Green/Amb.....\$139
 NEC MULTISYNC Monitor.....\$CALL
 SAMSUNG EGA Tilt 'n' Swivel, 14" Monitor.....\$349
 SAMSUNG 12" TTL Tilt 'n' Swivel.....\$ 85

LINK

MC-3 AT-K.B. Green/Amber/White Screens.....\$399
 PC-TERM GRAPHICS AT-K.B. Grn/Amb Monitor \$489
 220 DEC Emulation.....\$475

WYSE 30.....\$325
 WYSE50.....\$389
 WYSE60.....\$469

PRINTERS & BUFFERS

brother

HR-20 20 CPS Daisy Wheel-Auto Load.....\$315
 M-1109 100/25 CPS P & S with Tractor.....\$189
 M-1509 180/45 CPS P & S with Tractor.....\$343
 M-1709 240/50 CPS P & S with Tractor, FX-286 and IBM ProPrinter Compatible with "Paper Park" allows simultaneous loading of continuous form and cut sheet paper and auto loads.....\$444
 XEROX/DIABLO 635 with I/F.....\$775
 MSP-10.....\$299 MSP-15.....\$399
 MSP-20.....\$339 MSP-25.....\$499
 120D.....\$189 PREMIERE 35.....\$495
 CORDATA LP-300 Laser Printer.....\$2,249
 AST TURBOLASER (Ricoh based).....\$ 3,495
 OTC OT700E 200 Lines/minute.....\$1,395
 OTC OT850XL 240 Lines/minute.....\$CALL
 HANZON BUFFER 64-256K, S-S, S-P, P-P, P-S.....\$219

**houston
instrument**

DMP 56A.....NEW!.....\$CALL
 SCANCAD.....NEW!.....\$CALL

SCIENTIFIC SOLUTIONS

IEEE 488.....\$239 IEEE 488 S/W.....\$ 85
 DADIO BOARD.....\$239
 LAB MASTER.....FROM.....\$649

S-100 BUS PRODUCTS

CPRO RAM-16 64K Static for 80286 CPU.....\$ 99
 BRACKETS for CompuPro Drive Cabinet.....\$ 25
 COMPUPRO RAM 22-256K Static.....\$388
 COMPUPRO INTERFACER-3 8-Serial Ports.....\$388
 INTERCONTINENTAL MICRO SYSTEMS
 MS-1000 Runs PC-DOS Programs Includes Graphics Terminal and Software.....\$995

DRIVES

20Mb PC SUBSYSTEM ST-225 & WD CTRL.....\$349
 SMS SIGEN 160 Internal 60Mb Tape System...\$695
 I/R IN 20Mb Tape Internal.....\$469
 SEAGATE ST-251 HH.....\$639
 SEAGATE ST-4051 FH.....\$609
 QUANTUM Q540 43 Mb FH.....\$719
 MICROPOLIS 1325 85 Mb 28 mSEC.....\$ 1,139
 MAXTOR XT-1140 140 Mb 28 mSEC.....\$ 2,499
 MAXTOR XT-2190 190 Mb 28 mSEC.....\$ 2,769
 HANZON BUFFER 64-256K, S-S, S-P, P-P, P-S...\$219
 SEAGATE ST-4096 28mSEC 96Mb.....\$989
 MITSUBISHI 2896 HH 8".....\$425
 MITSUBISHI MF501 48TPI..\$ 89 /MF504 96TPI..\$115
 TEAC FD-55-BV 48TPI FLPY DRV.....\$ 89
 FUJITSU 5.25" HH 48 TPI FLPY DRV.....\$ 85

ProModem 1200B with Mirror Software.....\$119
 ProModem 1200.....\$209 ProModem 1200G.....\$169
 CTS 2424 ADH ASYNCH/SYNCH (Hayes).....\$269
 CTS 2424 AMH Class4 MNP Error Correct.....\$349
 CTS HALF-PAK 24 1/2 Card.....\$219
 U. S. ROBOTICS COURIER 2400.....\$335
 U. S. ROBOTICS 212A "Hayes compatible".....\$195

800-528-3138 Orders Only 602-991-7870 Customer Service

S-100 DIV./696 CORP. 14455 NORTH 79TH ST. SCOTTSDALE AZ 85260 TELEX 9103806778 SONEHUND

Advertised prices are cash prepaid only. For qualified payment terms calculate additional charges in the following way: P.O.'s and AM Express - .85, MC/VISA + .97, C.O.D.'s + .99 (\$5 min. fee)
 APO's accepted. Shipping \$4 1-5 lbs. for Arizona residents only. All returns subject to restocking fee or credit towards future purchase. All prices and availability subject to change without notice.

RS-422/232 CURRENT LOOP

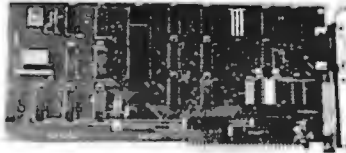

DS-225

- Single channel async communication board for IBM PC/XT/AT
- Software selectable to be RS/422/485, 232 or Current Loop
- Selectable Address & Interrupt

Q **QUA TECH, INC.**

478 E. Exchange St. Akron, OH 44304
(216) 434-3154 TLX: 5101012726

Inquiry 263

IEEE-488



MXI-100

- GPIB controller board for IBM PC/XT/AT
- Control up to 14 Devices
- User friendly Software Commands
- DMA Transfer to 200k byte/sec.

Q **QUA TECH, INC.**

478 E. Exchange St. Akron, OH 44304
(216) 434-3154 TLX: 5101012726

Inquiry 264

WAVEFORM SYNTHESIZER

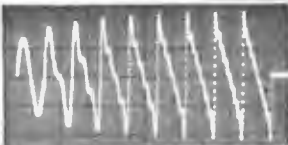

- For IBM-PC/XT/AT and compatibles
- Generates user-definable signal
- Up to 2000 points per envelope

Q **QUA TECH, INC.**

478 E. Exchange St. Akron OH 44304
(216) 434-3154 TLX: 5101012726

Inquiry 265

MODULAR DATA ACQUISITION



- For IBM & Compatibles
- Flexible and Inexpensive
- Money Back Guarantee
- Free Technical Support

Q **QUA TECH, INC.**

478 E. Exchange St. Akron OH 44304
(216) 434-3154 TLX: 5101012726

Inquiry 267

RS-422

Communications Board

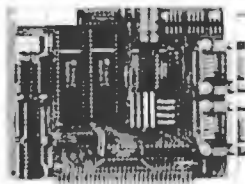

- For IBM-PC/AT/XT and compatibles
- Dual RS-422/RS-485 interface
- Differential drivers to 4000 ft.

Q **QUA TECH, INC.**

478 E. Exchange St. Akron OH 44304
(216) 434-3154 TLX: 5101012726

Inquiry 268

DISKETTES

5 1/4" PC-Pack

100% Tested & Certified Error Free, at "Minimum 55% Clipping Level or Higher." "Lifetime Warranty." Poly-Bagged in Fifty & Made in the U.S.A. With Tabs, Labels & Tyvek Sleeves

Double Side-Double Den.
(100) .39¢ each
(250) .34¢ each
(1000+) (500) .31¢ each

Shipping Charges Vary With Quantity Call

Delaware 1-800-451-1849
PO BOX 10241 WASHINGTON, DC 20050
Oklahoma 1-800-654-4058
PO BOX 1674, BETHANY, OK 73008
Nevada 1-800-621-6221
PO BOX 12396 LAS VEGAS, NV 89112

Nashua™

5 1/4" DOUBLE SIDE, DOUBLE DEN. 50 PER BOX MIN. 10 BOX
5 BOX 5.95

5 1/4" HIGH DENSITY Packed 10 Per Box
2 box 14.95 5 box 13.95 10 box 13.50

Nashua Packed 10 Per Box
3 1/2" SINGLE SIDE 2 Box 12.50 5 Box 11.50 10 Box 10.95
3 1/2" DOUBLE SIDE 14.95 14.50 13.95

Delaware 1-800-451-1849
PO BOX 10241 WASHINGTON, DC 20050
Oklahoma 1-800-654-4058
PO BOX 1674, BETHANY, OK 73008
Nevada 1-800-621-6221
PO BOX 12396 LAS VEGAS, NV 89112

maxell® FLOPPY DISKS

5 1/4" 5 Box 10 Box
S-Side 7.95 min 7.60 7.30
D-Den. 3bx
D-Side 9.95 min 9.30 8.75
D-Den. 3bx
HIGH DENSITY 17.95 17.00 16.60

S-SIDE 2 Box 15.95 D-SIDE 2 Box 19.95
96TPI

3 1/2" S-Side 10.80 (3 1/2") 3 1/2" D-Side 15.95

S-Side 19.95 (8") D-Side 21.95
D-Den.

Delaware 1-800-451-1849
PO BOX 10241 WASHINGTON, DC 20050
Oklahoma 1-800-654-4058
PO BOX 1674, BETHANY, OK 73008
Nevada 1-800-621-6221
PO BOX 12396 LAS VEGAS, NV 89112

A MONEY-SAVING OFFER ON BUSINESS FORMS FROM THE MOORE CATALOG

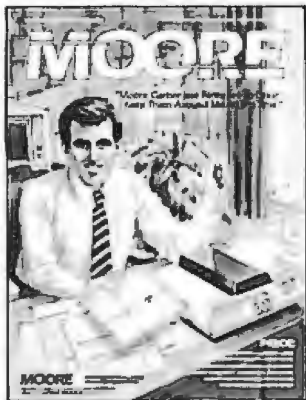

We've manufactured forms for over 100 years. In fact, Moore has developed most of the innovations in the forms industry.

All our multi-part forms use Moore carbonless Clean Print® paper. It gives a bold, black image for better photocopies without messy carbons.

Choose from 5 imprint ink colors to match or contrast our attractive 2-color continuous business accounting forms.

Our forms are guaranteed compatible with BPI, Open Systems, DAC, Real World and more. If you like, we'll add one of 24 logos to your imprint FREE.

This money-saving offer expires August 31, 1987.

For your free catalog call 1 800 323-6230 ext. 767 or fill in coupon below and mail today.

Name _____
 Title _____
 Company _____
 Address _____
 City _____ State _____ Zip _____
 Phone (____) _____

MOORE®
 BUSINESS PRODUCTS CATALOG DIVISION
 P.O. Box 20
 Wheeling, IL 60090

181G21

ICs PROMPT DELIVERY!!!
 SAME DAY SHIPPING (USUALLY)
 QUANTITY ONE PRICES SHOWN for MAR. 22, 1987

OUTSIDE OKLAHOMA NO SALES TAX

DYNAMIC RAM		
1Mbit	100Kx1	100 ns \$30.00
51258	*256Kx1	100 ns 6.95
4464	64Kx4	150 ns 3.24
41256	256Kx1	100 ns 3.25
41256	256Kx1	120 ns 2.59
41256	256Kx1	150 ns 2.39
4164	64Kx1	150 ns 1.30
EPROM		
27612	64Kx8	200 ns \$11.75
27C256	32Kx8	250 ns 4.95
27256	32Kx8	250 ns 4.75
27128	16Kx8	250 ns 3.50
27C64	8Kx8	150 ns 4.85
2764	8Kx8	250 ns 3.25
STATIC RAM		
62256	32Kx8	120 ns \$12.95
6264LP-15	8Kx8	150 ns 2.95

640K MOTHERBOARD UPGRADE... Zenith 150, IBM PC/XT, Compaq Portable & Plus, hp Vectra

8087 5 MHz \$11.500
 80287-8 8MHz \$24.000

OPEN 6 1/2 DAYS, 7 AM-10 PM SHIP VIA FED-EX ON SAT.
 SUNDAYS & HOLIDAYS SHIPMENT OR DELIVERY VIA U.S. EXPRESS MAIL

SAT DELIVERY INCLUDED ON FED-EX ORDERS RECEIVED BY 7:30 AM \$4.49 Fr. P-ONE \$13.29

MasterCard/VISA or UPS CASH COD
Factory New, Prime Parts MICROPROCESSORS UNLIMITED, INC.
 24100 S. Pecos Ave. (918) 267-4961
 BEESDE OK 74421
 No minimum order. Please note the prices are subject to change. Shipping & insurance extra. A up to \$1 for packing materials. Orders received by 9 PM CST are usually delivered the next morning, via Federal Express Standard air. \$4.00 on guaranteed next day Priority One - \$13.00. All prices guaranteed.

Inquiry 202

SAVE MONEY EPROM PROGRAMMER

APROTEK 1000 ONLY
\$265.00
 COMPLETE WITH PERSONALITY MODULE

117 AC POWER-RS-232 CONNECT
 -6 BAUD RATES - HANDSHAKE TO HOST
ALLOWS READ, WRITE, VERIFY & COPY

Comes complete with IBM-PC, Apple, or CPM (Specify Computer) Driver Program on Disc.

Programs the following 5 Volt 24 or 28 pin devices: 2716 series through 27612, 25xx series, 68764 plus others. Please Specify Personality Module desired with order. Additional Personality Modules only \$15.00 ea. Full 1 year warranty.

TO ORDER: CALL 1-800/962-5800 OR WRITE APROTEK
 1071 A AVENIDA ACASO Add
 CAMARILLO, CA 93010 \$4.00 Shipping USA
 Info (805) 987 2454 VISA or MC Add 3%
 We Accept Govt., School & Large Corp. P.O.s

Inquiry 28

Cable & Accessory Source
DATA SWITCHES

Serial A/B 90160 **\$27.00**
 Parallel A/B 90170 **\$29.00**

Solid Oak Computer Platform . 90190 **\$33.00**

Basic Turbo System case, PS, T. Motor w/256K 98999 **\$263.00**

COMPUTER TO PRINTER

6' Cable 90230 **\$4.99**
 10' Cable 96110 **\$8.99**

COMPUTER TO MODEM

6' Cable 90250 **\$4.99**
 10' Cable 96140 **\$6.99**

Surge Protector ^{Outlet} switched 90140 **\$9.95**

MOUNTAIN PRODUCTS

20 meg drive card for XT or AT 99620 **\$529.00**
 30 meg drive card for XT or AT 99600 **\$619.00**
 1 YEAR WARRANTY ON ALL MOUNTAIN PRODUCTS

Free Catalog With Hundreds of Items
The Wholesale Outlet
 1 Interstate Ave., Dept. BY, Albany, N.Y. 12205
 TO ORDER CALL **518-458-7883**
 MC/VISA OR COD CASH
 All orders shipped FOB Albany • Prices subject to change

Inquiry 346

controls up to 4 motors from any CRT, terminal or computer

CENTROID

STEPPING MOTOR CONTROLLER
 Microstepping & Circular Moves

Now With **CENTROID**

• RS232 interface • Accel/Decel

BASIC Version \$985
 16K BASIC, Battery Backup . . . \$1335
 CNC Version \$1950
 Stepping Motor Tips Cookbook . . . \$8

CALL OR WRITE
CENTROID (814) 237-4535
 Box 739, State College, PA 16804

Inquiry 55

ENHANCED VT220 \$150

Zygom by KEA SYSTEMS

The most complete VT220 emulation available for your PC/XT/AT or compatible.

- HIGH PERFORMANCE to 38.4K BAUD
- TRUE DOUBLE HIGH/DOUBLE WIDE
- TRUE 132 COLUMN MODE ON MOST EGA'S
- COLOR EXTENSIONS/DOWNLOADABLE FONTS
- SOFTKEY/MACROS, DOS ACCESS
- XMODEM/KERMIT FILE TRANSFERS plus many more extensions!

ZSTEMpc™-VT220 Emulator **\$150**
 EGAmate™ option for true EGA 132 column **\$39**
 ZSTEMpc™ - 4014 option **\$99**
 ZSTEMpc™ - VT100 Emulator **\$99**

KEA Systems Ltd.
 #412 - 2150 West Broadway
 Vancouver, B.C. Canada V6K 4L9
 Support (604) 732-7411
 TELEX 04-352848 VCR
 Order Toll Free (800) 663-8702
 30 day money back guarantee. MC/VISA

Inquiry 356

TERMINAL EMULATIONS

NEW SOFTERM PC, RELEASE THE LEADER IN EXACT TERMINAL EMULATIONS

* OVER 30 EMULATIONS

- KEYBOARD MACROS
- VIRTUAL DISK CAPABLE
- KEYBOARD TRANSLATE
- CAPTURE FILES TO DISK OR PRINT
- FILE TRANSFERS WITH 7 PROTOCOLS (I.E. KERMIT-SERVER, HAYES, XMODEM, ETC.)
- CONCURRENT AND BACKGROUND COMMUNICATIONS AND MORE!!!

A COMPLETE EMULATION & COMMUNICATION PACKAGE

SOFTRONICS
 800/225-8590
 CALL FOR INFORMATION
 (303)593-9540

Inquiry 300



LINDE BASIC SYSTEM

- PC/XT Compatible
- 640K on Board
- 2 DS/DD Floppy Drives
- Floppy Disk Controller
- Slide-in Case w/Speaker
- Mono Graphic Card w/Printer Port or Color Graphic Card
- 150W Power Sypply
- AT Style Keyboard
- 1 Year Limited Warranty
- FCC Approved

\$585.
Call for
Quantity
Discount

OPTION:

- 4.77 MHZ/8 MHZ Turbo Board
- Muliti Display Color Monitor
- TTL Monochrome Monitor
- 20MB Hard Disk/Controller
- Mouse w/Software
- Hayes Compatible Internal Modem
- Disk I/O Card
- EGA Card & Monitor
- Printer & Cable
- Joystick
- MS DOS 3.2 w/GW Basic

Ask for our
AT-286 System

(213) 327-6431

113 E. Savarona Way, Carson, CA 90746



NEW LOWER PRICES

SIBEC II



- 8052AH BASIC V1.1 CPU
- iSBX* expansion connectors
- Prototyping area
- Five 8 bit input/output ports
- PROM programmer
- Expansion connectors

CALL TODAY 603/469-3232
\$228 (100+ \$159)

Binary Technology, Inc.
MAIN ST., P.O. BOX 67 • MERIDEN, NH 03770
603/469-3232

*iSBX is a trademark of the Intel Corporation

Powerful Spreadsheet Meets Full-Featured Word Processor

BOXCALC 1000 is a combination spreadsheet/word processing program that lets you mix figures with text easily in the same document. All on one disk!

Stop fighting fixed rows and columns. **BOXCALC 1000** lets you put text and calculation boxes anywhere you wish.

Simple or complex box formulas with full replication and conditional processing help make your calculations easy, yet powerful. And you get word processing with fast insert-delete, word-wrap, search & replace, block moves, and much more.

For IBM PC/XT/AT or compat. 256K. With detailed manual and easy-start instructions for \$139. Send orders (VISA, MC, Check) or info requests to: Cotton Software, Inc., 2325 Anderson Rd., Suite 364, Covington, Ky. 41017. Or call (506) 727-1600.

Inquiry 76

Get the whole story on graphics terminal emulation.



To find out more about software that lets your PC emulate **TEKTRONIX™ 4105/6/7/9** and **DEC VT100™** terminals, call or write:

GRAFPPOINT
4340 Stevens Creeks Blvd., Suite 280,
San Jose, CA 95129 (408) 249-7951

! not only a printer buffer !

THIS IS THE MOST SOPHISTICATED
DCB **PRINTER BUFFER - MULTIPLEXOR - SWITCH**

WITH TWO SEPARATE INPUTS (SERIAL AND PARALLEL) AND TWO SEPARATE OUTPUTS (SERIAL AND PARALLEL) CAN BE USED LIKE STANDARD BUFFER. WITH ANY INPUT TO ANY OUTPUT BUT ALSO YOU CAN CONNECT 2 COMPUTERS TO 1 PRINTER, OR 1 COMPUTER TO 2 PRINTERS, OR 2 COMPUTERS AND 2 PRINTERS AND MORE - 1 COMPUTER TO 3 PRINTERS OR 3 COMPUTERS TO 1 PRINTER.

HIGH CAPACITY - 64 KB TO 256 KB AND - 256 KB TO 1 MB (MODELS A AND B) PAUSE, COPY AND RESET FUNCTIONS. SERIAL PORTS WITH 7 OR 8 BITS WORD LENGTH, 1 OR 2 STOP BIT, PARITY, XON/XOFF, DTR, RTS

DCB-A-64K \$ 195 DCB-B-256K \$ 255 (*)

(*) Power supply and parallel cables are included

ALSO, WE HAVE THE MOST COMPLETE DATA CONVERTER UNIT. CONVERTS RS232 SERIAL TO CENTRONICS PARALLEL OR VICE VERSA, JUST BY MOVING JUMPERS BAUD RATE AND PROTOCOL FULLY PROGRAMMABLE FROM 30 TO 19200 BAUDS INCLUDES DTR, RTS, XON/XOFF, PARITY, etc

DCU \$ 80 (**)

(**) Power supply and cables NOT included

serial ↔ parallel
bi-directional converter

INTECTRA Inc.-Dept.232
2629 TERMINAL BLVD
MOUNTAIN VIEW-CA-94043
(415) 967-8818 TX 345545

Inquiry 135

16-BIT RESOLUTION ANALOG-TO-DIGITAL CONVERTER

12,000 SAMPLES/SEC
for IBM PC, XT & AT
SINGLE PIECE PRICE
\$475

We manufacture a broad line of data acquisition and control hardware and software for Apple and IBM computers.

Call for quotes on custom hardware or complete systems.

LAWSON LABS, INC.
5700 RAIBE ROAD
COLUMBIA FALLS, MT 59912
406-387-5355

Flow Charting II+

The New Plus
for Fast
Flowcharting



FLOW CHARTING
is new! It's now
Flow Charting II+, with more speed + more functions + more printing options;

- 10 text fonts; 26 shapes; • Line mode can stop at a shape; • Backspace key can erase a line to its origin; • Free text entry anywhere, or select auto-centering; • Vertical or horizontal printing; one chart or multiple charts.

Used by Fairchild, Bechtel and more than 500 other major corporations. Edit quickly and accurately — even major edits — with Flow Charting II+, the Specialist.

See your retail store or call:
PATTON & PATTON
Software Corporation
800/672-3470, ext. 897 California
800/538-8157, ext. 897 National
408/629-5044 International

The Amazing A-BUS

NEW

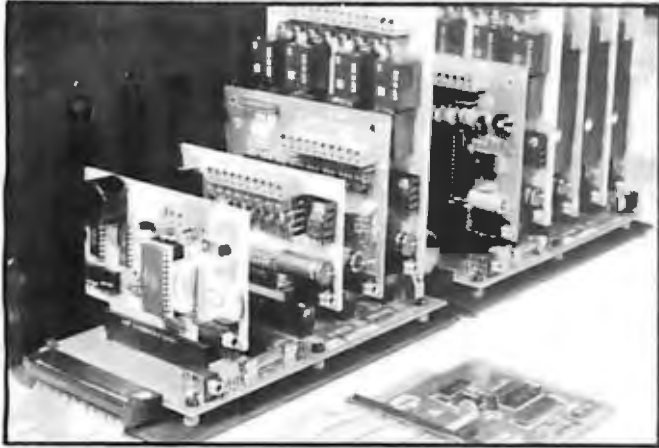

An A-BUS system with two Motherboards
A-BUS adapter (IBM) in foreground

Plug into the future

With the A-BUS you can plug your PC (IBM, Apple, TRS-80) into a future of exciting new applications in the fields of control, monitoring, automation, sensing, robotics, etc.

Alpha's modular A-BUS offers a proven method to build your "custom" system today. Tomorrow, when you are ready to take another step, you will be able to add more functions. This is ideal for first time experimenting and teaching.

A-BUS control can be entirely done in simple BASIC or Pascal, and no knowledge of electronics is required!

An A-BUS system consists of the A-BUS adapter plugged into your computer and a cable to connect the Adapter to 1 or 2 A-BUS cards. The same cable will also fit an A-BUS Motherboard for expansion up to 25 cards in any combination.

The A-BUS is backed by Alpha's continuing support (our 11th year, 50000 customers in over 60 countries).

The complete set of A-BUS User's Manuals is available for \$10.

About the A-BUS:

- All the A-BUS cards are very easy to use with any language that can read or write to a Port or Memory. In BASIC, use INP and OUT (or PEEK and POKE with Apples and Tandy Color Computers)
- They are all compatible with each other. You can mix and match up to 25 cards to fit your application. Card addresses are easily set with jumpers.
- A-BUS cards are shipped with power supplies (except PD-123) and detailed manuals (including schematics and programming examples).

Relay Card

RE-140: \$129

Includes eight industrial relays. (3 amp contacts. SPST) individually controlled and latched. 8 LED's show status. Easy to use (OUT or POKE in BASIC). Card address is jumper selectable.

Reed Relay Card

RE-156: \$99

Same features as above, but uses 8 Reed Relays to switch low level signals (20mA max). Use as a channel selector, solid state relay driver, etc.

Analog Input Card

AD-142: \$129

Eight analog inputs. 0 to +5V range can be expanded to 100V by adding a resistor. 8 bit resolution (20mV). Conversion time 120us. Perfect to measure voltage, temperature, light levels, pressure, etc. Very easy to use.

12 Bit A/D Converter

AN-146: \$139

This analog to digital converter is accurate to .025%. Input range is -4V to +4V. Resolution: 1 millivolt. The on board amplifier boosts signals up to 50 times to read microvolts. Conversion time is 130ms. Ideal for thermocouple, strain gauge, etc. 1 channel. (Expand to 8 channels using the RE-156 card).

Digital Input Card

IN-141: \$59

The eight inputs are optically isolated, so it's safe and easy to connect any "on/off" devices, such as switches, thermostats, alarm loops, etc. to your computer. To read the eight inputs, simply use BASIC INP (or PEEK).

24 Line TTL I/O

DG-148: \$65

Connect 24 input or output signals (switches or any TTL device) to your computer. The card can be set for: input, latched output, strobed output, strobed input, and/or bidirectional strobed I/O. Uses the 8255A chip.

Clock with Alarm

CL-144: \$89

Powerful clock/calendar with: battery backup for Time, Date and Alarm setting (time and date); built in alarm relay, led and buzzer; timing to 1/100 second. Easy to use decimal format. Lithium battery included.

Touch Tone® Decoder

PH-145: \$79

Each tone is converted into a number which is stored on the board. Simply read the number with INP or POKE. Use for remote control projects, etc.

A-BUS Prototyping Card

PR-152: \$15

3½ by 4½ in. with power and ground bus. Fits up to 10 I.C.s

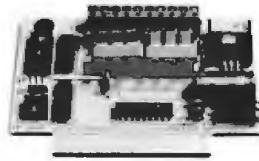

Smart Stepper Controller sc-149: \$299

World's finest stepper controller. On board microprocessor controls 4 motors simultaneously. Incredibly, it accepts plain English commands like "Move arm 10.2 inches left". Many complex sequences can be defined as "macros" and stored in the on board memory. For each axis, you can control: coordinate (relative or absolute), ramping, speed, step type (half, full, wave), scale factor, units, holding power, etc. Many inputs: 8 limit & "wait until" switches, panic button, etc. On the fly reporting of position, speed, etc. On board drivers (350mA) for small steppers (MO-103) Send for SC-149 flyer.

Remote Control Keypad Option RC-121: \$49

To control the 4 motors directly, and "teach" sequences of motions.

Power Driver Board Option PD-123: \$89

Boost controller drive to 5 amps per phase. For two motors (eight drivers).

Breakout Board Option BB-122: \$19

For easy connection of 2 motors. 3 ft. cable ends with screw terminal board.

Stepper Motor Driver ST-143: \$79

Stepper motors are the ultimate in motion control. The special package (below) includes everything you need to get familiar with them. Each card drives two stepper motors (12V, bidirectional, 4 phase, 350mA per phase). **Special Package: 2 motors (MO-103) + ST-143: PA-181: \$99**

Stepper Motors MO-103: \$15 or 4 for \$39

Pancake type, 2¼" dia, ¼" shaft, 7.5"/step, 4 phase bidirectional, 300 step/sec, 12V, 36 ohm, bipolar, 5 oz-in torque, same as Airpax K82701-P2.

Current Developments

Intelligent Voice Synthesizer, 14 Bit Analog to Digital converter, 4 Channel Digital to Analog converter, Counter Timer, Voice Recognition.

A-BUS Adapters for:

IBM PC, XT, AT and compatibles. Uses one short slot.	AR-133...\$69
Tandy 1000, 1000 EX& SX, 1200, 3000. Uses one short slot.	AR-133...\$69
Apple II, II+, IIe. Uses any slot.	AR-134...\$49
TRS-80 Model 102, 200 Plugs into 40 pin "system bus"	AR-136...\$69
Model 100. Uses 40 pin socket. (Socket is duplicated on adapter).	AR-135...\$69
TRS-80 Mod 3, 4, 4 D. Fits 50 pin bus. (With harddisk, use Y-cable)	AR-132...\$49
TRS-80 Model 4 P. Includes extra cable. (50 pin bus is recessed).	AR-137...\$62
TRS-80 Model 1. Plugs into 40 pin I/O bus on KB or E/I.	AR-131...\$39
Color Computers (Tandy). Fits ROM slot. Multipak, or Y-cable.	AR-138...\$49

A-BUS Cable (3 ft, 50 cond.) CA-163: \$24

Connects the A-BUS adapter to one A-BUS card or to first Motherboard.

Special cable for two A-BUS cards: CA-162: \$34

A-BUS Motherboard MB-120: \$99

Each Motherboard holds five A-BUS cards. A sixth connector allows a second Motherboard to be added to the first (with connecting cable CA-161: \$12). Up to five Motherboards can be joined this way to a single A-BUS adapter. Sturdy aluminum frame and card guides included.

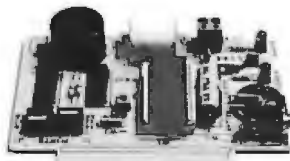

CL-144

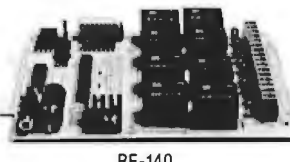

RE-140

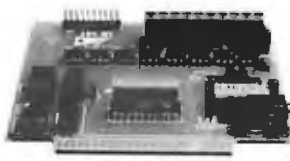

IN-141

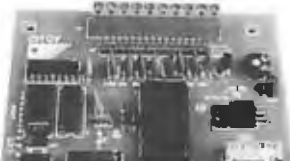

AD-142

Add \$3.00 per order for shipping. Visa, MC, checks, M.O. welcome. CT & NY residents add sales tax. C.O.D. add \$3.00 extra. Canada: shipping is \$5 Overseas add 10%



ALPHA Products

242-B West Avenue, Darien, CT 06820

Technical info: (203) 656-1806
Orders only: 800 221-0916
Except in CT
Connecticut orders: (203) 348-9436
All lines open weekdays 9 to 5 Eastern time

DISK-KING®

DEALER/OEM's WELCOME!

WHY RISK THE UNKNOWN... when you can get premium quality disks from the Leader and inventor of magnetic media...for less!

- * 100% tested & certified at 65% or higher clipping level*
- * 10 mil sturdy jacket * LIFETIME WARRANTY *

3M/BASF	
5.25" Diskettes:	Color Disk No-Logo
DS-DD-48 TPI49.....38
DS-DD-RH-48 TPI52
DS-HD-96 TPI for AT1.39.....1.05

3.5" Diskettes:	
DS-135 TPI1.49.....1.20

All 5.25" diskettes are supplied with Tyvek® sleeves, color-coded ID labels, w/p tabs. Pre-packaged in plastic library case for \$1.50 extra per box. Color Disk in 14+ different colors to choose from or Rainbow assortment. Private labeling & Software duplication services available. Made in the USA.



FREE SCOTCH!!	
SS-DD-RH	*bonus product & rebate inside while supplies last.
.69*5.25"/148 TPI-10/bx.89
1.093.50"/135 TPI-10/bx.1.69
DS-HD-96 TPI for the "AT"-10/bx.1.79
DC-100012.25 DC-300XL/P18.75
DC-200016.80 DC-600A20.65
3M Blackwatch® Tape 2400" w/seal from11.95
	min. 10 reels
3M Headcleaning Kit for 5.25"5.99

BASF Color-Coded Modular Flexy Files a \$19.95 value!

5.25" DS-DD SB-10/BX73
5.25" DS-DD in *Minidex/6079
5.25" DS-HD for the "AT" SB1.49
3.50" DS-135 SB-10/BX1.49
3.50" DS-135 in *Microdex/251.69
5.25" DS/DD 96 TPI SB-10/BX1.89
8.00" DS/DD x 1024 SB-10 BX1.89
BASF Computer Tapes-2400" w/seal fr.10.95
BASF 3480 Chrome Tape cartridge from11.95

Nashua DISKETTES DISK PACKS

5.25" DS-DD	4416-XX F/L67.
10/bx	4417-XX F/L108.
5.25" DS-HD	4420-Phnx/NCR90.
10/bx	4441-XX T/L70.
3.50" DS-HD	4442-24/48T/L108.
10/bx	4438 Sig 200 MB365.
5.25" DS-DD96TPI	4439-2 200 MB385.
10/bx	4464-1 80 MB195.
	4473 300 MB465.

RIBBONS STORAGE

Epson MX/RX/FX 70/80/852.59	3M Discover 506.99
Epson MX/RX/FX 100/1853.49	3M D/Defender 070 w/key13.95
Epson LQ10003.99	3M Data Defender 05013.95
Epson LQ15004.59	Amaray Media Mate 508.90
Okidata Twin Spool1.09	Amaray Micro Mate 38.70
Okidata 182/192/1933.99	Plastic Library Case1.50
Apple Imagewriter2.75	Micro Disk Minder 368.70
IBM Proprinter2.99		
Brother HR 15/25 M/S3.99		
Panasonic KXP4.99		
NEC 3500 M/S3.99		

ACCESSORIES \$900 1000
 Tyvek® envelopes.....055 039
 Color-Coded ID label.....035 019

TERMS: Minimum order \$35.00 or case lot. Qty. less than case lot add 10%. VISA, Mastercard, AMEX, COD, Prepaid 2% cash discount. PO's on net 30 basis from recognized institutions & corporations. No sales tax outside Utah. SHIPPING: \$4.00/100 or fewer disks. APO/FPO: AK, HI, PR & CN \$9.00/100 or fewer disks for air-freight plus insurance. Reduced shipping charges on larger quantities. Overseas order, please call for exact freight charges & terms.

TELEX — 9102404712
 Toll-Free Order Line: 1-800-523-9681
 Inquiries Line: 1-801-942-2273

DISK-COTECH

DISCO TECHNOLOGIES, INC.

2034 E. 7000 So. Salt Lake City, Utah 84121
 Hours: 8 AM-6PM (Min. Time) Half day Saturday

INTELLIGENT GRAPHICS

The ultimate graphics solution for the programmers (IBM/MS Fortran, Profort, Quick Basic, Pascal, and Assembly).

- Fastest wireframe drawing in two and three dimensions.
- Rotate 3D objects at any angle.
- Animation in 3D by screen paging or image buffering.
- Fancy custom color palettes and pattern.
- Store and display screen windows.
- Superior graphics text facility, rotation and scaling.
- Sound, keyboard support, screen dump.
- Exploit the EGA/Hercules to its fullest speed and potential.

These well-structured machine-language routines are outstanding and efficient tools to teach your PC new visions.

Available for IBM-PC/Compatible.
 CGA version CGS3 \$40
 EGA/Hercules version EGGS3 \$65
 Driver version for Turbo Pascal, BASICA LITE3 \$70
 3D Object Construction software with Fortran source INTEGRA \$40

Detailed manual and advanced tutorials are provided. Get our breathtaking 3D demo for \$5 (applied toward purchase).

Please add \$3 S/H
 Texas residents please add 7.25% tax.
 Filtrix Research, Inc. (713) 556-5747
 P.O. Box 820425 Houston, Texas 77282 MC/VISA/CHECK/MO

Inquiry 115

Addmaster Specialty Printer

Forty-Column Alphanumeric Printer ideal for applications such as security systems, fire alarm systems, point-of-sale, data logging and others.



- RS232 interface.
- Prints 40 characters alphanumeric.
- 5 x 7 Dot-Matrix.
- Compact 10-1/2" x 10" footprint.
- 120 VAC 60 Hz.
- Single or Two-ply 3875 in paper.
- Validation slot for multi-part forms.
- 80 cps speed (2 lps)
- 8K buffer (additional RAM optional).

ADDMASTER CORPORATION
 2000 S. MYRTLE, MONROVIA, CA 91016-7116
 (818) 358-2395 TELEX 674770

Inquiry 6

Universal Graphics Tools Turbo Pascal / Logitech Modula 2 (EGA, Hercules, CGA, printers, plotters...) No Royalties

The TurboHalo™ Universal Graphics Tools (Quinn-Curtis Model # IPC-T-005) are comprehensive set of over 230 high performance graphics procedures and functions which work with over 41 of the most popular graphics display adapters, dot matrix printers, laser printers, plotters, digitizing tablets and mice. \$130.00 Save Time

- Flexible Fonts** Spend time on your application, not on the specifics of a particular CRT device, printer or plotter. Bit-mapped and stroke fonts can be arbitrarily scaled for height and width. A font designer/editor is also included.
- Graphs** Powerful charting procedures will automatically scale, draw axes, and plot linear, semi-log and log line, bar, scatter and group graphs. Written in Turbo Pascal and Modula 2, with source.
- 3-D Graphics** Sophisticated graphics procedures will scale, translate, rotate and calculate perspective transforms for 2-D and 3-D images. Written in Turbo Pascal and Modula 2, with source.

To Order: Call (617) 444-7721 or write Quinn-Curtis, 49 Highland Ave., Needham, MA 02194. Mastercard, Visa, Company PO's, Personal checks and COD orders accepted. Add \$7 for shipping outside of North America.

TurboHalo is a trademark of Media Cybernetics and IMSI.

Inquiry 273

DYNAMIC RAMS

1Mbit	100ns	\$22.00
41256	100ns	\$ 3.60
41256	120ns	\$ 2.50
✓41256	150ns	\$ 2.20
4464	150ns	\$ 3.25
✓4164	150ns	\$ 1.00

PROCESSORS		E PROMS	
8087-2	8MHz \$443.00	27512	250ns \$ 8.95
8087	5MHz \$109.00	27C256	250ns \$ 5.00
80287-6	6MHz \$176.00	27256	250ns \$ 4.75
80287-8	8MHz \$265.00	27128	250ns \$ 3.60
V-20	8MHz \$ 12.75	27C64	250ns \$ 4.50
V-30	8MHz \$ 94.00	2764	250ns \$ 3.25
SIATIC RAMS		2732A	250ns \$ 4.25
6264LF-15	150ns \$ 2.95	8000 J	(Parts in stock)

I.C. EXPRESS

15358 Valley Blvd., City of Industry, CA 91746
 Phone 818-369-2688 (Mon-Fri 8-5)

ORDER TOLL FREE
 (800) 892-8889 • (800) 882-8181

CALL FOR CURRENT PRICES & VOLUME DISCOUNTS.
 Prices shown for Cash • MasterCard/VISA add 3% more
 Prices are subject to change without minimum order \$1000
 California residents must add 6.3% sales tax
 Shipping & handling: UPS Ground \$5.00 UPS Air \$7.00 (under 1 lb.)
 ALL MERCHANDISE IS 100% GUARANTEED.

Inquiry 149

SOFTWARE DUPLICATION SERVICES



- World's Largest Duplicator
- Highest Quality
- One Day Turnaround on All Orders
- Attractive Cost Savings
- Xidex/Dysan Media
- One-Stop Shopping
- Copy Protections for all Formats
- Professional Engineering Staff
- Local Sales Support
- Division of XIDEX Corp.

CALL
 1-800-247-3968

Inquiry 354

MICROSTAR LABORATORIES DATA ACQUISITION PROCESSORS

New DAP 1200 Series
 FAST INTELLIGENT BOARDS
 for the IBM PC/XT/AT

- Up to 150,000 sample/second
- 80186 Coprocessor-realtime processing
- On board computations—incl. FFT
- Direct access to Lotus 1-2-3

INTRODUCTORY PRICE*

From \$1,276 for both hardware and software



Call or write for details:
 2863 152nd Avenue N.E.
 Redmond, Washington 98052
 (206) 881-4286 TLX 51060133473

*on prepaid, credit card and COD orders

Inquiry 206

FOLKS DOWN IN TEXAS DON'T LIKE PAYIN' BIG BUCKS ESPECIALLY FOR IBM-PC SOFTWARE SO WE SELL IT FOR ONLY \$6.00!

OVER 600 DISKS FULL OF IBM-PC COMPATIBLE PUBLIC DOMAIN AND USER SUPPORTED SOFTWARE.

APPLICATIONS

- GENEALOGY ON DISPLAY (#90)
- GENEALOGY - FT (#240) From Pine Cone software.
- LABELMAKER (#146) Our favorite label file and maker. Menu driven.
- FAMILY HISTORY (#361) Family history, ancestor and descendant charts. Sample programs.
- FORM LETTERS (#388) LOTS of samples of the most commonly used business letters. Modify!
- PC-SPRINT (#507) Detailed instruction on how to double your computer's speed for less than \$50.00.
- MSDOS-CPM/80 INTERFACE (#561) CPM lovers! This program allows you to transfer information between and emulate CPM and MSDOS.
- NAME GRAM/BREAK DOWN/FOREWARD (#477) Discover the words inherent in your phone number, do great anagrams.
- THE WORLD DIGITIZED (#494, 495, 496) A cartographer's dream. Locate and display over 100,000 locations.
- 100 LETTERS (#300) Most commonly used by letters, and business applications at your fingertips.

COMMUNICATIONS

- QMODEM (#310) Without a doubt the fastest and best communications software you can buy at any price.
- PC-TALK (#16) The classic "Freeware" communication program.
- RBBS (#212) Become a SYSOP and start a bulletin board.
- FIDO NET (#333) Bulletin Board System. Perhaps the easiest to run.
- PROCOMM (#499) Communication software that makes a hacker's dream come true.

DATABASE

- VCR DBASE (#493) Keep track of those favorite VCR tapes that you never can seem to find when you want them.

DATABASE PROGRAMS

- PC-FILE (#5) Perhaps the granddaddy of user supported database programs from Jim Button.
- NEWBASE (#238) Menu driven database for the beginner.
- PC-DBMS (#383) A relational database management system that provides on-line help and screen editing functions.
- CREATOR (#339) Create, report and sort makes this a super database management system.
- MAIL MASTER (#481) Easily sort, index, and list your multiple mailing data bases.

EDUCATION

- EQUATOR (#249) A teaching tool for math, science and finance.
- PC-TUTORIAL (#403) A first course in computer usage covering various aspects of MS-DOS. Good!
- PC-PROFESSOR (#105) Learn Basic the easy way. One of the best tutorials on BASIC.
- PC-DOS HELP (#254) Type "help" for the DOS command you forgot.
- PC PROMPT (#558) Fascinating on line memory resident DOS helper that also supports BASICA, ED-LIN, DEBUG, and TURBO PASCAL.
- PC-SPRINT (#507) Tutorial on how to triple your PC's speed.

FINANCIAL

- PC-CHECK MANAGER (#275) Keeps multiple checkbooks in balance.
- TAX FILE DBS (#295) Tax record keeping system that saves you money on April 15.
- PORTSWORTH PACKAGE (#101) Evaluates your ever-changing stock portfolios.
- PC-GENERAL LEDGER (#237) An exceptional accounting system. Used by some CPAs.
- LOAN AMORTIZATION (#399) For output to screen or printer. Lots of on-line help.
- MR. BILL (#469, 470) Prepare invoices, client report, audit trail, etc.
- (3) ANALYTIC CALC (#430-432) 3 disk set. Complete spreadsheet, database, graphics, word processor - fassst!
- (2) PC ACCOUNTING SYSTEM (#559, 560) General purpose ledger system that includes payroll, depreciation, accounts receivable/payable, inventory, processing 1099's and a good general ledger.
- PC-PAYROLL (#565) Handle all payroll problems with this complete menu-driven payroll system. Includes taxes, reports, forms, etc.
- (2) SALESEYE (#501, 502) Never let another prospect or lead get away! Prints memos and letters as well.

GAMES

- TOP GAMES (#274) The most requested arcade type games.
- ARCADE GAMES (#293) Another goodie bag of top arcade games.
- PC JR GAMES (#354) Games that will work only on PC JR. Combat, Dungeons and Dragons, Global Thermonuclear War.
- MISC GAMES (#390) Good selection of educational, adventure, and arcade games.
- PINBALL RALLY (#557) You asked for it! Here are three pinball games that vary in complexity, PINBALL, RAIN, TWILZON2.
- DND (#567) Dungeons and Dragons, this uses text characters instead of graphics.
- REFLEX PDINT (#487) Self styled action game similar to ROBOTECH cartoon series.

GRAPHICS

- PC-KEY DRAW (#344-345) A small CAD system. Lots of demonstration files.
- PC-PICTURE GRAPHICS (#136) Drawing package allows you to zoom, color, and store pictures.
- PC-GRAPH (#418) Allows user to create graphics from PC—File report files.
- PRESENT (#471) Professional slide shows are a snap with the advanced graphic features of this program. Includes a screen "capture".

LANGUAGE

- CHASM (#10) Cheap assembler with tutorial.
- XLISP (#148) Lisp language interpreter.
- PROLOG & UNIFORTH (#417) Complete with editor and documentation.
- ESIE (#398) Build and generate an expert system in a flash.
- P-BASIC (#381) BASICA work-a-like for clones, etc.
- TINY PASCAL COMPILER BUILDER (#540) Learn to create your own Pascal Compiler and language compiler/includes tutorial.

- SCREENCODE (#503) Build your screen applications and watch SCREENCODE generate the code for DBASE II and III, BASIC, and more.
- VISIBLE PASCAL COMPILER (#510) Watch your program step through its routines as you learn to program it in PASCAL.
- EXTENDED BATCH LANGUAGE (#124) Makes the PC do menial tasks you never thought possible.

MATH AND STATISTICS

- EPISTAT (#88) Statistical analysis of small to medium-sized data samples.
- STAT-TOOLS (#509) (1 of 2) Do single size experiments, studentized ranges, calculate the size of specific sample sizes.
- STAT-TOOLS (#509) (2 of 2) Do calculations that require the entry of original observations, exact randomization tests, mean squares, etc.

MUSIC

- PC-MUSICIAN (#127) Compose music on your PC, save and play again.
- PIANO MAN (#279) Play your keyboard like a piano.

PRINTER UTILITIES

- SIDEWAYS (#265, 411) Print text sideways on an Epson printer.
- SETPRTR (#79) Sets up Epson print from a menu.
- PRINTER UTILITIES (#411) Smorgasboard of utilities and tools.
- EPSON PRINTER UTILITIES (#326) Spool, set up routines all designed for Epson codes.
- BANNER (#386) Make long banners with large letters. Includes MS-FORTRAN source codes.
- WSMX80 (#526) Allows Word Star to print more ways than you imagined on an Epson/Compatible printer. Useful for mathematical and scientific notation.

SPREADSHEET TEMPLATES

- PC-CALC (#199) Fabulous 123 work-a-like from the author of PC-File.
- (2) LOTUS 1-2-3 TEMPLATES AND MACRDS (#406, 414) Why spend hours writing your macros when these are ready made? Modify them yourself.

TEXT PROCESSING TOOLS

- WORDSTAR AIDS (#375) Collection of the most useful utilities for the Wordstar user.
- PC OUTLINE (#414) Create and collapse and outline. Great for plans, essays, etc.
- PC-STYLE (#505) Better than your high school English teacher! Analyzes your writing ability.
- POLYGLOT & LETTERFALL (#542) Two educational programs to match sentences, words, and definitions, Q&A's. Typing tutor is great!
- SIDE WRITER (#523) Print your text files sideways. Allows the 132 column barrier to be broken. Great for large spread sheets.

UTILITIES

- GINACO (#66) Polished routines written in basic for any beginner or expert. We love it!
- ULTRA-UTILITIES (#133, 245) Recover lost files, modify sectors, etc. Like Nortons.

- SYSMENU (#250) Build a menu driven menu system. Excellent for hard disks.
- PC-DESKMATES (#405) Better than Sidekick and all of the rest of the memory resident desktop utilities.
- ALIGN (#217) Disk Alignment tool. Needs Cats Eye.
- TOP UTILITIES (#273) All of the most requested utilities on one disk.
- UNPROTECT (#414) Various routines to disconnect protection schemes.
- PATCHES (#376) Make back up copies of some of the most popular commercial programs with this collection.
- DOSMATIC (#498) Fabulous task-switching and menuing utility that allows several programs to run at once.
- PC-TOOLS (#538) Lots of useful utilities with both EXE and "C" source code. BROWSE, DUMP, MERGE, WORD COUNT, ROFF, GREP, etc.
- DBS-KAT (#537) Diskette cataloging system for archival purposes. Database can hold up to 9,999 diskettes and 16,000,000 files.
- STILL RIVER SHELL (#481) An enhancement of the PC-DOS working environment. Faster and uses Key Commands.
- PC-PROMPT (#558) The on-line mode makes this memory resident utility tops. Great for beginners and advanced users alike.

WORD PROCESSING

- PC-WRITE (2) (#78) A & B Our most popular full featured word processor that is actually faster than Wordstar. Now with spelling checker.
- DICTIONARY (#152) Dictionary type spelling checker.
- PC TYPE (#455) Jim Button's contribution to a full fledged word processor.
- (2) NEW YORK WORD (#528, 529) Powerful word processor that creates keystroke macros, split screen editing, mail merge and more. Watch out Micro-Soft.



Please
Enclose
Check
With
Order

No COD's or Purchase Orders • U.S. Funds Only
Foreign Orders add \$5.00 to all Shipping/Handling
We Warranty All Disks Against Defects In Duplication

SHIP TO: _____

CHARGE MY:

MASTERCARD VISA

CARD NO. _____

EXPIRATION DATE _____

SIGNATURE _____

TOTAL # _____ x \$6 = _____

DISK DIRECTORY _____ x \$6 = _____

(Explanation of all files & programs)

OTHER _____

SUBTOTAL _____

TEXAS RESIDENTS ADD 6 1/2% TAX _____

SHIPPING AND HANDLING _____

(1 @ \$1.00 and 50¢ for each additional disk)

LONE STAR
SOFTWARE

2100 Hwy. 360, Suite 1204, Grand Prairie, Texas 75050, (214) 647-1010 ©1987 LONE STAR SOFTWARE, INC.

Motion Control & Data Acquisition



on your IBM PC or Apple II and all compatibles

Smart 2 Axis Motion Controller: For many types of motors & encoders. New I.C. (from HP) allows changes & monitoring on the fly. Optically isolated. w/SOFTWARE \$400.

Four Axis Stepper Driver: With SOFTWARE & motor for instant automation. \$95.

Fast A/D Board: With programmed gain, 650 KHz, 4 in puts, \$220. Complete Scope hardware & SOFTWARE \$500. Also: 12 Bit A/D, Relay Driver, Real Time Clock. Circuit developers Project Book \$25.

How do you do it? Use our Local Applications Bus, LAB 40. One host adapter (\$150) supports up to 8 boards, like those above, on a 50 ft. ribbon cable.

Please call (415) 755-1978 for free literature.

Computer Continuum

75 Southgate Ave., Suite 6
Daly City, CA 94015 (415) 755-1978

Electronic Data Translation Services

Use your data among mainframes, minis, micros, dedicated word processors, and typesetters!

We offer translation of the logical elements of data in addition to conversion of physical parameters, NOT just dumping or ASCII transfer from one medium into another. For example:

- Translation of the control characters and formatting features of stand-alone or microcomputer-based word processors.
- Database restructuring—Even from your word processors' File and List Managers.
- Spreadsheet translations—formatting, cell referencing codes, and formulas.
- State and federal compliances—Magnetic media and file-structure conversions.

ADAPSD member

CompuData Translators, Inc. 6565 Sunset Blvd.
Suite 301, Hollywood, CA 90028 (213) 462-6222

IC TESTER \$259⁰⁰



AUTOMATICALLY IDENTIFIES AND TESTS HUNDREDS OF COMMON TTL & CMOS CHIPS

30 day money back guarantee

PRECISION MOTION

2545-F 237th Street
Torrance, CA 90505
(213) 539-8612

Inquiry 63

Inquiry 252

SCR

The Smart Cash Register

- Cash Register/Point of Sale/Inventory
- 100% dBASE III data files
- Import into 1-2-3, Accounting, and most other programs
- Interface to Bar Code, Receipt Printer, Cash Drawer, Register

WE CARRY ALL HARDWARE, TOO!!!

ORDER NOW

(915) 837-7180

**SCR — Box 714
Alpine, TX 79831**

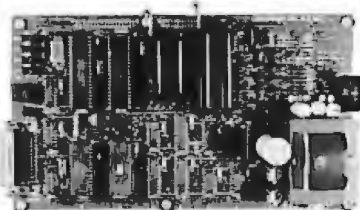

UNIVERSAL EPROM PROGRAMMER KIT FROM \$99!!

- On board power supply, 110/220 VAC;
- Menu selection; No personality modules;
- Built in monitor for easy I/O debugging;
- User friendly softw; Full tech. support
- Detailed 50 page manual with schematics;
- Quick pulse algorithm: 27256 under 60 sec
- All 24/28 pins to 27011 & CMOS E2EPROMS
- Micros: 8741, 2, 4, 8, 9, 52, 9761 & CMOS
- Auto baud RS232 to 19.2k; Free PC drivers
- Offset/split Hex, Binary, Intel & Motorola 8, 16 & 32 bit files; Cased 1409C-34 599!

B&C Microsystems

6322 Mojave Dr., San Jose, CA 95120
• Ph (408) 997-7685 Tx 4995363 Visa & MC

Inquiry 49

8051 8048

SIMULATORS - CROSS ASSEMBLERS - PROGRAMMERS - SIM51 and SIM48 Software Simulators run on IBM-PC, CP/M-80, MS-DOS. Designed for validation & debugging application software. Simulation includes all on chip functions plus expansion chips. \$250, one year FREE updates. Formats: PC-DOS 2.x DSSD, CP/M-80 8" SSSD, many 5 1/4" formats. Cross Assemblers and EPROM pgms also available. Logical Systems Corp. 6184 Teall Station, Syr., NY 13217. (315) 478-0722.

Logical Systems

Inquiry 180

DiskMASTER[®]

The Ultimate Diskette Value ...



Discover the Difference ...

2 FOR 1 LIFETIME WARRANTY

- Performance exceeds ANSI specifications by 62.5%
- Each diskette 100% tested and certified error free
- 65% clipping level • Over 10 million passes per track
- Reinforced Hubs (DS-DD only) • Tyvek sleeves
- W/P tabs and ID labels

.49

Made in U.S.A.

1.09

5 1/4" - 48 TPI DS-DD

DS-HD 96 TPI IBM-AT Compatible

**Simply top Brand-Name Quality
Call For Best Prices**

BULK 32¢ + 6¢ FOR TYVEK

**TECH
Nashua**

3M

1-800-233-2477 1-801-561-0092
199 Cottage Ave., Sandy, Utah 84070



BATTERY POWERED!

FEATURES—2.2lbs., 11" x 4 1/4" x 1 1/4", MX80 compatible, built-in self test, 5x7 dot character with descenders, bold, underline, expanded, or condensed (40/80/160 chars. per line, 40 chars./sec., 8 1/2" paper, 512 byte buffer, excellent users manual, Centronics standard parallel interface.

SUPER RELIABLE and care-free because it uses thermal paper, no ribbons, and no ink cartridges to replace or worry about.

PRINTER INCLUDES—a 20' roll of paper, 4-C batteries, cable, 30-day money-back satisfaction guarantee, and a 6-month warranty.

ONLY \$99 (Free shipping in cont. U.S.)

CALL TOLL FREE 1-800-732-5012

Calif: 805-987-4788 Canada: 604-856-8858

PURPLE COMPUTING

VISA/MC & AMER. EXP.

420 Constitution Ave., Camarillo, CA 93010

Inquiry 259

TURBO 10MHz 1MB AT/XT



OPEN 7 DAYS

TURBO AT \$1,400

\$1,950/w SEAGATE — 4039 30MB

HI-RES 30MB MONITOR • INTEL 80286 5/10 MHz • ONE MB 120Ks RAM ON BOARD • PROGENIE 2D BIOS • Hercules EMULATION GRAPHICS CARD • PARALLEL SERIAL PORTS • OPERATES MS-DOS, PS-DOS, XENIX, UNIX, LW BASIC • 8 SLOTS • VMD CONTROLLER 280/2HD • ENHANCED KEYBOARD • LEDs • 200 WATTS POWER • 12 MB TEAC FLOPPY • ON BOARD CLOCK/CALENDAR • HARDWARE RESET • 80287 SOCKET • OPTIONAL 640K COLOR • OPTIONAL 10' WAITSTATE OR 12 MHz • FULLY SET UP/TESTED • MANUALS • ONE YEAR PARTS/LABOR

TURBO XT \$750

\$1100/w SEAGATE 20 MB & ONE FLOPPY

HI-RES AMBER MONITOR • INTEL 80286 2 OR MED V-20 RUNNING 10MHz 33% FASTER THAN IBM PC • 500K ON BOARD • FULLY COMPATIBLE BIOS • Hercules EMULATION GRAPHICS CARD • PARALLEL PORT • OPERATES MS-DOS, PS-DOS, LW BASIC • 8 SLOTS • DISK 1/2 CARD 2 HD CONTROLLER 2 SERIAL 2HD OPTL PARALLEL GAME CLOCK/CALENDAR BATTERY RAM DISK PSPOOL • AT KEYBOARD • LEDs • 150 WYS • TWO 360K FUJITSU DRIVES • 80287 SOCKET • MANUALS • FULLY SET UP/TESTED • ONE YEAR PARTS/LABOR

PORTABLE XT/AT SYSTEMS ALSO AVAILABLE

PCPRO SYSTEMS, INC.
800-451-5279

135 W. 26TH ST. 8TH FL.
NEW YORK, NEW YORK 10001
(212) 627-4485

9832 E. FLOWER ST.
BELLFLOWER, CA 90706
(714) 923-5052

Inquiry 238

Inquiry 66

DATAFLEX™

- Multi-user Database!
 - Powerful!
 - Multiple Operating System Compatibility!
 - Attractive Dealer Pricing!
 - Full Dealer Support!
- Dataflex is a trademark of Data Access
Dealer Inquiries Invited

COGITATE

24000 Telegraph Road
Southfield, Michigan 48034 USA
(313) 352-2345

Inquiry 62

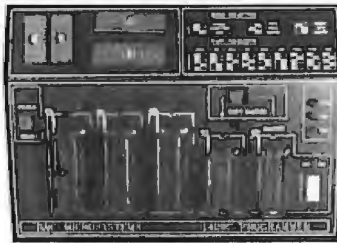

UNIVERSAL EPROM PROGRAMMER \$599!!

- Built in timer erase optn; foam pad area
- Menu selection; No modules or adapters
- User friendly softw; Complete help menu
- Direct tech. support; Full 1 yr. warranty
- Stand alone duplication & verify;
- Quick pulse algorithm: 27256 under 60 sec
- All 24/28 pins to 27011 & CMOS E(E)PROMS
- Micros: 8741, 2, 4, 8, 9, 51, 52, 55, 9761 & CMOS
- Auto baud RS232 to 19.2k; Free PC drivers
- Offset/split Hex, Binary, Intel & Motorola
- 8, 16 & 32 bit files; Kits from \$99!

B&C Microsystems

6322 Mojave Dr., San Jose, CA 95120
• Ph (408) 997-7685 Tx 4995363 Visa & MC

Inquiry 50

IEEE 488 (GPIB/HPIB)

- Controllers
- Buffers
- Converters
- Extenders
- Interface Boards

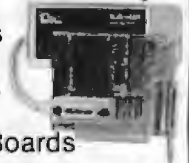

for PCs, Macintosh, HP plotters, instruments, printers, etc.

Call or send for your **FREE Technical Guide**

IOtech (216) 439-4091

23400 Aurora Road
Cleveland, Ohio 44146

Inquiry 157

DOUBLE THE OPTION CAPACITY OF YOUR IBM PERSONAL COMPUTER

PC-XTRA

- DIRECT EXTENSION OF IBM PC BUS
- NO SOFTWARE CHANGES
- NO HARDWARE MODIFICATION
- STYLING CONSISTENT WITH IBM

Add all those special options that you've been wanting without worrying about filling your plug-in and back panel space

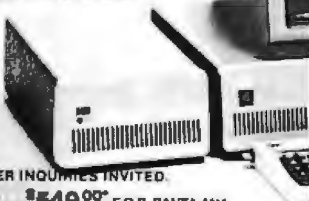

DEALER INQUIRIES INVITED.

\$549.00* F.O.B. SANTA ANA
CALIFORNIA RESIDENTS ADD 6% SALES TAX
P C HORIZONS, INC.
1701 E. Edinger, Ste. A6, Santa Ana, CA 92705
(714) 953-5396

Inquiry 235

Quelo® 68000 Software Development Tools

Quelo Assembler Packages are Motorola compatible. Each package includes a macro assembler, linker/locator, object librarian, utilities for producing ROMable code, extensive indexed typeset manuals and produces S-record, Intel hex, extended TEK hex, UNIX COFF and symbol cross references. Portable source written in "C" is available. It has been ported to a variety of mainframes and minis including VAX.

68020 Assembler Package

For CP/M-86, -68K and MS/PC-DOS \$ 750

68000/68010 Assembler Package

For CP/M-80, -86, -68K and MS/PC-DOS \$ 595

68000 "C" Cross Compiler

For MS/PC-DOS by Lattice, Inc.
With Quelo 68000/68010 Assembler Package \$1095
With Quelo 68020 Assembler Package \$1250

Call Patrick Adams today:

Quelo, Inc.
2464 33rd W, Suite #173
Seattle, WA USA 98199
Phone 206/285-2528
Telex 910-333-8171

COD, Visa, MasterCard

Trademarks: CP/M, Digital Research; MS, Microsoft Corporation; Quelo, Quelo, Inc.

Inquiry 271

A MUST for Computers

VIZIFLEX SEELS

The Ideal Keyboard Cover!

Protect your computer and eliminate downtime caused by liquid spills, contaminants, environmental hazards, etc. with VIZIFLEX SEELS - the only keyboard cover that:

- Remains securely in-place during the operation of the keyboard and will not interfere with computer performance in any way.
- Is designed to "form-fit" to the exact contours of the keyboard to provide superior tactile sensitivity & feel for individual keys.
- Consists of Ultraflex™ material, a transparent, flexible "film" which allows all "markings" to be clearly visible.

VIZIFLEX SEELS are the only keyboard covers for your computer!

VIZIFLEX SEELS, INC.
16 E. Lafayette St., Hackensack, NJ 07601 (201) 487-8380

Inquiry 341

P-tral BASIC to Pascal \$179 TRANSLATOR

Translate your BASIC source programs to Pascal source. P-tral, now available for the IBM PC and compatibles, will translate MS-BASIC/BASICA to Turbo Pascal (Req Dos 2.0 or later w/ANSI.SYS).

Also available for the Apple II series (incl. IIGS) and converts Applesoft to Apple Pascal.

(212) 206-6490 / 924-0576
WOODCHUCK INDUSTRIES
340 WEST 17TH STREET (#2B)
NEW YORK, NY 10011

Inquiry 351

PC + MIDI = MUSIC

It's a simple equation. To plug your PC or PC-compatible into the modern world of music-making, use the complete line of MIDI software and hardware from VOYETRA TECHNOLOGIES.

- SEQUENCER PLUS: 65-track total MIDI recorder/editor.
- CONVERSION PLUS: file converter for music notation programs.
- PATCH MASTER: network organizer and sound librarian.
- OP-4001: PC/MIDI interface card.

"I've never seen a more powerful, easy-to-use music and recording system... bug-free."

(PC COMPANION)

For more information contact VOYETRA TECHNOLOGIES, Dept. PC, 426 Mt. Pleasant Avenue, Mamaroneck NY 10543, or call (914) 698-3377.

Inquiry 343

Computer Valley

1290 Oakmead Parkway • Suite 111 • Sunnyvale, California 94086

800-225-8216 (ORDERS ONLY) 408-739-3400 (CA Residents-Information)

MANAGED BY ENGINEERS FROM SILICON VALLEY

PACT-386-16 (16 mhz 80386 cpu pc)

IDEAL FOR CAD/CAE/CAM/CAT Workstations

\$3,950

- Standard 2 MB Memory Expandable to 16 MB
- On Board 2 Serial 1 Parallel Ports
- Supports RAM-BIOS
- On Board Socket for 80287
- Zero Wait State Optional
- Two 32 Bit, Four 16 Bit, Two 8 Bit Bus
- 101 Keys Enhanced Keyboard
- FORTRON® 230 Watt Power Supply UL/CSA Listed
- 5 Drives Capacity Heavy Duty Cabinet
- 1.2 MB TEAC Floppy Drive
- Western Digital Controller
- 40 MB High Speed Hard Drive
- DOS 3.2/GW Basic

PACT-286-8

(8 mhz Zero Wait State)

\$1,125

- IBM AT Compatible
- 6/8 mhz 0 Wait State, Norton S/I 9.2
- 512K Installed, Expandable to 1 MB On Board Memory
- 1.2 MB Floppy Drive
- Floppy and Hard Disk Drives Controller
- 230 Watt (max.) UL/CSA Listed Power Supply
- Maxi Switch Keyboard
- Optional 2 Serial and 1 Parallel Port
- DOS 3.2 GW Basic
- Clock/Calendar with Battery Back Up
- Optional Math Co-Processor 80287-8
- Optional 5 Half-Height Drives Capacity Chassis
- One Year Warranty



PACT-286-10

(10 mhz One Wait State)

\$1,195

*Same features as PACT-286-8 with 10 mhz clock speed, with 640K memory installed.

PACT-286-12

\$1,650

- IBM PC AT Compatible
- 6/12 mhz Dual Clock Speed
- 640K Expandable to 1 MB On Board Memory
- 1.2 MB Floppy Drive
- Floppy/Hard Disk Drive Controller
- Maxi-Switch AT Keyboard
- 230 W (max.) UL/CSA Listed Power Supply
- DOS 3.2, GW Basic
- One Year Warranty

UPGRADE OPTIONS

(Discount Price for the Purchase With System Only)

- Hercules® compatible monographic card w/printer port . . . \$ 65.00
- Monochrome monitor . . . \$ 85.00
- 20MB hard disk drive kit . . . \$359.00
- 360K floppy drive . . . \$ 85.00
- XT serial/parallel/clock/game port (for PC XT only) . . . \$ 55.00
- 8087-2 (8 mhz) . . . \$159.00
- 80287-8 . . . \$235.00
- 80287-10 . . . \$295.00
- 20MB hard disk drive only . . . \$295.00
- 30MB hard disk drive only . . . \$585.00
- 20MB tape back-up kit (teal) . . . \$485.00
- EGA card & EGA monitor . . . \$590.00
- Enhanced keyboard . . . \$ 75.00

BEST SELLING PC ADD-ON'S AND PERIPHERALS

VIDEO ADAPTORS

- Monographics, Hercules Compatible . . . \$ 79.00
- Colorgraphics Adaptor . . . \$ 79.00
- EGA Card, IBM Compatible . . . \$ 199.00
- HEGA Card, IBM, Hercules Compatible . . . \$ 219.00

MULTIFUNCTION MEMORY EXPANSION BOARD (OK Installed)

- 640K Memory Exp. Card (XT) . . . \$ 59.00
- 2MB Memory Exp. Card (XT, EMS) . . . \$ 129.00
- 640K Multifunction Card (XT) . . . \$ 129.00
- 3MB Memory Exp. Card (AT) . . . \$ 155.00
- 2 MB Multifunction Card (AT) . . . \$ 175.00

I/O BOARD

- XT - I/O w/Floppy Controller . . . \$ 95.00
- AT - I/O w/Floppy Controller . . . \$ 95.00

PRINTERS

- PANASONIC DOT MATRIX
- KX-P10801 120 cps, NLQ . . . \$ 209.00
- KX-10911 160 cps, 32 cps NLQ . . . \$ 269.00
- KX-1092 180 cps/33 cps NLQ . . . \$ 345.00
- KX-1592 180 cps/38 cps NLQ . . . \$ 449.00
- KX-1595 240 cps/51 cps NLQ . . . \$ 559.00
- KX-P3131 17 cps Daisywheel . . . \$ 295.00
- KX-P3151 22 cps LQ Parallel Printer . . . \$ 449.00
- C. ITOH
- Riteman Blue Plus, 140 cps . . . \$ 179.00
- Riteman 15, 160 cps, 15" Wide Carriage . . . \$ 419.00
- TTX PRESS 80, Thermo Printer . . . \$ 89.00

MONITORS

- MONOCHROME TTL
- Casper w/Swivel Base, Amber . . . \$ 99.00
- Tatung . . . \$ 129.00
- Samsung Amber . . . \$ 99.00
- COLOR, RGB
- Tatung-1360f . . . \$ 335.00
- Bright-up . . . \$ 310.00
- EGA
- Tatung-1380F . . . \$ 449.00
- Casper . . . \$ 429.00
- Taxon - S.V. 760 . . . \$ 469.00
- NEC Multisync . . . \$ 619.00

DISK DRIVES

- FLOPPY DRIVES
- Teac FD-55BV, 360K Floppy . . . \$ 92.00
- Teac FD-55GFV, 1.2MB Floppy . . . \$ 129.00
- Chino 1.2MB Floppy . . . \$ 119.00
- HARD DRIVE, SEAGATE
- ST-225 w/controller & cable . . . \$ 369.00
- ST-4026 Drive Only . . . \$ 519.00
- ST-4038 Drive Only . . . \$ 619.00
- ST-4051 Drive Only . . . \$ 699.00
- ST-4096 Drive Only . . . \$1,290.00

TAPE BACK-UP DRIVE

- Teac 20MB Internal . . . \$ 499.00
- Teac 20MB External . . . \$ 599.00
- Teac 45MB Internal . . . \$ 629.00
- Teac 45MB External . . . \$ 739.00

MODEMS

- 1200 Baud Internal . . . \$ 109.00
- 2400 Baud Internal . . . \$ 239.00
- 1200 Baud External . . . \$ 149.00
- 2400 Baud External . . . \$ 349.00

DOS 3.20 W/G. W. BASIC . . . \$ 85.00

MATH CO-PROCESSOR

- 8087 (5 mhz) . . . \$ 105.00
- 8087-2 (8 mhz) . . . \$ 152.00
- 80287-6 (6 mhz) . . . \$ 174.00
- 80287-8 (8 mhz) . . . \$ 245.00
- 80287-10 (10 mhz) . . . \$ 295.00

- Prices subject to change without notice.
- Hercules is a trademark of Hercules Computer Technology.
- IBM XT, AT is a trademark of International Business Machines.

TERMS:

- Shipping and handling charge starting from minimum \$6.00 each shipment.
- 15% restocking charge is required for non-authorized return merchandise.

There's a Killer in Your Office! STATIC

It's true. Only power line problems kill more computers than static. Simply walking across a carpeted floor can generate potentials exceeding 30,000 Volts! All our static products include 10" grounding strap and drain away any built up charge in less than 0.05 seconds.

Clear plastic chair mat—45" x 53" with lip. .145" thick mat looks and feels like ordinary chair mat but is molded with special conductive fibers. Has spikes that hold mat firmly in place on carpet.

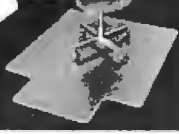

\$109

Black plastic chair mat—Same size and features as clear mat.

\$89

Beige table top mat—

24" x 26" soft PVC mat fits under both XT & AT size computers & keyboards.

\$32

Beige keyboard mat—

10" x 18" soft PVC mat fits under keyboard. Touch mat first before computer.

\$18

Ask us about anti-static spray, carpet, & tile.

SIERRA COMPUTER CONTROL
430 STOKER, SUITE 104, RENO, NV 89503
702-322-6455

Mastercard & Visa accepted

6809 Single Board Computer

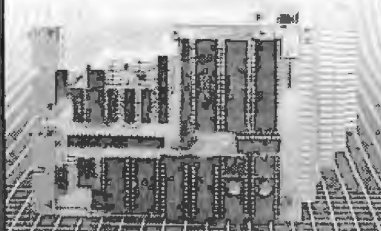

6809 MPU; 2 serial ports; 4 parallel ports
RAM, EPROM; real-time clock; watchdog timer, 44-pin 4.5" x 6.5" PCB
EXPANSION MODULES: RAM, EPROM, CMOS RAM/battery, analog I/O, serial I/O, parallel I/O, counter/timer, IEEE-488, EPROM programmer, floppy disks, cassette, breadboard, keyboard/display.



Wintek Corp.
1801 South Street
Lafayette, IN 47904
317-742-4428

Inquiry 348

PUBLIC DOMAIN SOFTWARE

Thousands of useful programs available for most computers from user group libraries.

User Group Libraries	Rent	Buy
IBM PC Blue 220 Disks	\$230	\$450
Capitol-IBM 45 Disks	50	105
Sanyo UG MSDOS 80 Disks	85	225
Amiga 50 Disks	65	200
Atari ST 55 Disks	75	220
Macintosh 85 Disks	90	255
CP M UG 92 Disks	45	249
SIG M UG 270 Disks	175	330
CBM 64 Gold 50 Disks	105	150
Apple DOS 120 Disks	130	200

MASTER CARD • VISA • DINERS

Rental is for 7 days with 3 days grace for return. Use credit card, no deposit! Call for free catalog or send Disk for free Directory of programs. Specify Computer!

24 HR
RECORDING
(702)
794-3660

PUBLIC DOMAIN SOFTWARE

INTEREST GROUP INC.

2400 Santa Rita

Las Vegas, Nevada 89109

702 732-0169

800 527-3744

BBS
NUMBER
(702)
794-3665

Inquiry 260

Inquiry 292

Why waste time?

ACCELERATE with VCACHE™

HARD DISK ACCELERATOR

- Caching eliminates repetitive disk accesses
- Use up to 15 Mb of extended/expanded or 500 Kb of standard memory

DISKETTE ACCELERATOR

SCREEN ACCELERATOR

FAST — FRIENDLY — SAFE

VCACHE

GOLDEN BOW SYSTEMS

\$49.95

Add \$3 for shipping/handling
California residents add 6% sales tax



2870 Fifth Avenue

Suite 201

San Diego, CA 92103

619/298-9349

Inquiry 133

SHARE SERIAL PRINTER or MODEM between TWO COMPUTERS!

"Printer Data Splitter"

Model 232PDS \$44.95

"Modem Data Splitter"

Model 232MDS \$44.95

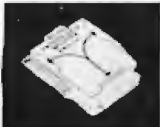

Now two computers can share one modem or one serial printer, and both can be connected at the same time. Self-powered from RS-232C port; may be left permanently installed.

SAME-DAY SHIPMENT! MONEY-BACK GUARANTEE!

Order Direct from Manufacturer TODAY and SAVE!

Request your FREE B & B ELECTRONICS Catalog of RS-232C Interface and monitoring equipment.

*Terms: Visa, MC, cash orders postpaid; P.O. s from qualified rated firms accepted. IL residents add 6% sales tax.

B & B electronics
MANUFACTURING COMPANY

ORDER TODAY!

1502E Boyce Memorial Drive • P.O. Box 1008
Ottawa, IL 61350 • Phone: 815-434-0846

Inquiry 48

MOTION CONTROL DREAM

\$75 per axis

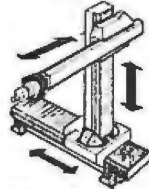

4 AXIS VERY SMART STEPPER CONTROLLER

- 49 high level commands in plain English.
- Macros. Battery backup for memory.
- Learn mode with optional "Teach Pendant"
- 4 axis simultaneous control. You select the ramps, units, speeds, drive types...
- Input for Limit Switches, Panic button, etc.
- On board multitasking compiler.
- Works with any computer with a Centronics port or with the Alpha Products A-BUS system

See page 367 for details of the SC-149

ALPHA Products

Inquiry 16

DATA SWITCHES



- High quality rotary switch
- Gold plated contacts
- All pins switched
- Fully shielded metal case
- Anti-skid feet
- Female connectors
- Ninety day warranty

RS232 TYPE (25 PIN)

#38610 TWO POSITION 27.95
#38615 FOUR POSITION 39.95
#38650 X-TYPE 43.95

CENTRONICS TYPE (36 PIN)

#38640 TWO POSITION 28.95
#38695 FOUR POSITION 42.95
#38655 X-TYPE 45.95

AUTO SWITCH

#38710 FOUR POSITION 148.50
#38760 EIGHT POSITION 198.85

WE ALSO CARRY CABLES, PRINT BUFFERS & MANY OTHER ACCESSORIES

Please call or write for our free catalog

DALCO ELECTRONICS
(513) 435-1058

P.O. BOX 494
FRANKLIN, OH 45005

MC/VISA Accepted
Mail Orders Please
Add \$3.00 For Shipping

Inquiry 83

M2HD

• 5 1/4"

M2D 2S2D 48TPI
\$8.25/Box of 10

THE NO RISK DISK

• 3.5"

MF2DD 2S/135TPI
\$16.10/Box of 10

Data-Case Special Sale
Get one box of M2D and a Data-case for 70 diskettes for \$14.95

Enter TDK Dash for Cash Sweepstakes
No purchase Necessary

Caribbean Micro Corp.
9411 Fontainebleau Blvd.
Box 205
Miami, Florida 33172
(305) 221-1007

Send check or call for C.O.D.

Shipping & Handling \$3.00 for every 100 diskettes.
C.O.D. add \$2.00

Inquiry 53

PRINTER SHARING

HERE IS THE ECONOMIC AND THE BEST SOLUTION

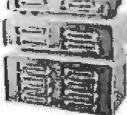

- Completely automatic operation
- Eliminates the need for manual switching or cable swapping
- May be used for other peripherals (i.e. plotters)
- Compatible with all computers using a standard CENTRONICS output
- Identifies active computer
- Totally transparent to the user

- Adjustable time-out delay from 1 to 25 seconds between two printings
 - Form feed may be inserted (or not) between two successive requests
 - Port number associated with requesting computer may be printed or not
 - 8 kbyte standard buffer
 - 32 kbyte optional buffer
 - 280-A processor
 - Six models to choose from:
- PMS 606: 2 computers to one printer/
8 kbyte buffer \$173.00
- PMS 607: PMS 606 with 32 kbyte buffer \$234.00
- PMS 610: 4 computers to one printer/
8 kbyte buffer \$354.00
- PMS 611: PMS 610 with 32 kbytebuffer \$354.00
- PMS 615: 8 computers to one printer/
8 kbytebuffer \$441.00
- PMS 616: PMS 615 with 32 kbyte buffer \$502.00

We are also manufacturing a full line of STD BUS and educational products.

DISTRIBUTORS WANTED 1-800-361-2572
Protoc Micro Systems Inc. 8080A, Tione Canada Hwy. St. Laurent, Q.C. H4S 1M5
Tel. (514) 336-9555 Fax: 0525134/PROTEC

Inquiry 258

PC COMPATIBLE

AT COMPATIBLE



Turbo Speed

CAT[™] 640 BASE SYSTEM

- 256K (Optional 640K)
- 150 watt pwr. supply
- AT Style Keyboard
- 4.77 or 8MHz Clock Speed
- 24 Hr Burn In
- 1,360K 1/2 HT Drive

\$39800

The CAT[™] 640 is compatible with all software written for the IBM[™] PC. It also runs your software twice as fast as the IBM[™] PC. It runs at 8 megahertz clock rate. More power for expansion. The 150 w. power supply has 8 expansion slots. The keyboard is an 'AT' style standard. The motherboard is 640K.



10MHZ

CAT[™] 286 BASE SYSTEM

- 512K Ram (1024K Optional)
- 195 watt Pwr. Supply
- AT Style Keyboard
- 10MHz Clock Speed.

\$77800

1 Year Warranty

THE CAT[™] 286 is a 'AT' compatible system, running all software written for the IBM[™] AT. The CAT[™] 286 runs at an impressive but not expensive 10MHz.

OPTION A	OPTION B	OPTION C	OPTION A	OPTION B	OPTION C
Base System plus: Monochrome Graphics Card Monochrome Graphics Monitor Parallel Port	Base System plus: Color Graphics Card Color RGB Monitor Parallel Port	Base System plus: Mono. Graph. Card Monochrome Graphics Monitor Parallel Port 20 Meg Hard Drive	1.2 Meg Floppy Mono. Graph. Card Monochrome Graphics Monitor Parallel Port 20Meg 40Meg	1.2 Meg Floppy: Color Graphics Card Color Graphics Monitor Parallel Port 20Meg 40Meg	1.2 Meg Floppy: EGA Interface Card EGA Hi Res Monitor Parallel Port 20Meg 40Meg
\$54700	\$73800	\$82900	149900 179900	168700 193200	194300 216300

EXCESS INVENTORY REDUCED TO OUR COST (Limited to Stock On Hand)

Seagate HARD DRIVE • ST 225—20 Meg • With Controller • 6 Month Warranty \$33800	SEVEREX MODEM • 1200 Baud • Software Included • Hayes AT Compatible \$8800	intel CO PROCESSOR • 8 MHz • For 80286 Systems • 80287-8 \$23900	SAMSUNG EGA MONITOR • 14 Inch • 640 x 350 RGB-EGA-16 Colors \$36800
IBM XT • 256K Exp to 512K • 1,360K Floppy • 90 Day Warranty \$103900	SAMSUNG MEMORY UPGRADES • 9-41256K • 150 NS • 1 Year Warranty \$1900 64K Sets — \$800	CITIZEN PRINTER • 120D-120cps w/NLQ • Hi Res Graphics • 80 Col \$18800	Tandon HARDWARE • 1/2 HT • 10 Megabytes • w/Controller \$21900
IRWIN BACKUP • 10 Meg Backup • w/Software • w/Cartridge \$28800	DOS 3.1 • w/Manuals • Factory Sealed \$3400	Seagate 30 Meg HARD DRIVE • ST238-30Meg • RLL Controller \$39800	ATASI HARDWARE • 39.5 Meg Formatted • 28 MS • Same as Miniscribe \$47900

ALL TRADEMARKS ARE REGISTERED WITH THEIR RESPECTIVE COMPANIES.

WE ALSO HAVE AVAILABLE

ALLOY AMDEK AST RESEARCH INC. ATi brother. (2) COMPARE ADDRESS CANON CDC G adaptec COMPAG COMREX Diablo
EPSON Hayes HERCULES' UTKI MAGNAVOX Microsoft MITSUBISHI ELECTRONICS NEC i-MEGA ORCHID Panasonic. PRINCETON PIA/ALUPLUS
Qume RODIME SANYO SHARP Shugart SPERRY STAR STE. TAXAN TEGAR TeleVideo THOMSON TOSHIBA
WESTERN DIGITAL Robotics ZENITH

CALL 800-654-7762 FOR QUOTES

NO SURCHARGE

800-654-7762

702-294-0204

Retail & Mail Order Address:
1000 Nevada Hwy., Unit 101
Boulder City, NV 89005



TERMS:

MC • VISA • Wire Transfer
C.O.D. • Cashiers Check • A.E. add 4%
Purchase Orders • Money Orders
Personal Checks



SHIPPING:

UPS • US Mail • Federal Express

Subscription Problems?



We want to help!

If you have a problem with your **BYTE** subscription, write us with the details. We'll do our best to set it right. But we **must** have the name, address, and zip of the subscription (new and old address, if it's a change of address). If the problem involves a payment, be sure to include copies of the credit card statement, or front and back of cancelled checks. Include a "business hours" phone number if possible.

BYTE
Subscriber Service
P.O. Box 6821
Piscataway, NJ 08854

300, 1200, 2400 baud
U.S. Made 2 Yr. Guar. **\$177**

WHILE SUPPLY LASTS
(805) 656-3741
The On-Line Store

ROSE DATA SWITCHES



COMPATIBLE with all computers. Businesses, Schools, Homes
WE ALSO OFFER:
Data Buffers, Line Drivers, Modems, Protocol Converters, Parallel - Serial Converters, Cables, Computers, Printers, Disk Drives, and more.

AUTOMATIC - CARETAKER is ideal for a business or school to share a printer or modem among many computers. Operation is fully automatic with no software required.
Parallel or Serial 4 channels - \$295 8 channels - \$395
MANUAL - HARDSWITCH is operated with the flip of a switch. 2:2 and 2:4 models allow simultaneous communication.
Serial 1:2 - \$59 1:4 - \$ 99 2:2 - \$109 2:4 - \$169
Parallel 1:2 - \$79 1:4 - \$139 2:2 - \$119 2:4 - \$199
LED and spike protection on serial models add \$20.

CODE ACTIVATED - PORTER connects one computer to multiple peripherals. A software code selects the peripheral.
Parallel or Serial 4 channels - \$295 8 channels - \$395
Buffer option 64K - \$100 256K - \$250

REMOTE - TELEPATH connects multiple computers to multiple peripherals. A selector at each computer or terminal chooses up to 4 peripherals and displays busy status.
4:4 - \$495 4:8 - \$795 selector - \$39.

Give a Rose to your computer

ROSE ELECTRONICS (713) 933-7673
P.O. BOX 742571 MC & VISA Accepted
HOUSTON, TX 77274 Dealer Inquiries Invited
CALL US FOR ALL YOUR INTERFACING NEEDS

Inquiry 281

100Mhz Logic Analyzer Card

For PC/XT, PC/AT Monochrome & Color Card Systems **\$1199**

- 24 Channels at 25Khz - 25 Mhz
- 6 Channels at 100 Mhz
- Internal Clock up to 100Mhz
- External Clock up to 25Mhz
- Threshold Voltage TTL, ECL, or variable from -10 to +10v
- All New Version 2.0 Software
- Available as separate card or as complete portable PC System.



PAL/EPROM Programmer Card
For PC/XT/AT Systems



\$399

- Programs 20 and 24 Pin MMI, NS, TI PALS
- Programs Eproms from 2716 to 27512 and 27512A
- Software Functions Include: Read, Write, Verify, Protect, Edit, Print, and File Save and Load of Program.
- All Software Included

CALL NOW FOR ORDERS AND TECHNICAL INFORMATION (201) 994-6669
Link Computer Graphics, Inc. 4 Sparrow Dr., Livingston, NJ 07039

Turn Your IBM PC Or Compatible Into A

Hi-Res Video Character Generator

Video Overlay Board
\$1,695 or \$89/mo.
(Includes Software)

Video Technologies

The Company That Makes Professional Video Production Affordable
Video Technologies
412 Wharf St. • Lake St. Louis, MO 63367 • 314-625-2404

ON!

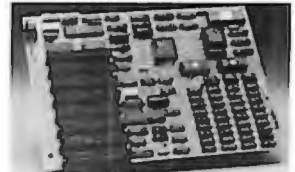

BULLET-286 System Board

- CPU & Disk I/O FASTER Than 8 MHz "AT"
- High-Speed 80286 Processor
- Socket for 80287 Math Co-Processor
- Sockets for 1 MByte ZERO Wait-State RAM
- Includes ROM-Based DISK CACHING Software
- BIOS & Expansion Bus Compatibility GUARANTEED
- PC & XT Models Available
- Optional "386 Performance" Boards Available
- 30 Day MONEY BACK Guarantee
- TWO YEAR Warranty

SDP, Inc.
310 Spring Lake Hills Drive
Altamonte Springs, FL 32714
Phone: 305-788-3666
Fax: 305-774-6590

Qty. 5 Price

Advertise your computer products through **BYTE BITS** (2" x 3" ads)

For more information call Dan Harper at 603-924-6830

BYTE
70 Main St.
Peterborough, NH 03458

California Digital

17700 Figueroa Street • Carson, California 90248



FOUR PEN COLOR PLOTTER **\$159**

The manufacturer has asked us not to publish their name. But this four color plotter was produced by one of the World's largest makers of computers. The 410 color plotter will connect to the serial port of virtually any micro-computer. Simple ASCII commands direct one of the four color pens to draw circles, arcs or ellipses on paper or transparency material up to 11 by 17 inches. The plotter is capable of producing the full upper and lower case alphabet along with seven international character sets. Text can be printed horizontal, vertical or diagonal in sizes from 1/16 to 6 inches. Enlargements or reductions are achieved through elaborate firmware. Pen travel is four inches per second with .004" pen resolution. Standard pens are available in an assortment of 32 different colors and widths. The ideal plotter for architecture, CAD engineering or graphic design. **A1595** it was a great buy, at **\$159 its a steal**. Support packages for specific computers available. Manual only \$15 refundable upon purchase of plotter.

OTHER PLOTTERS AVAILABLE:
Hewlett Packard • Houston Instruments • Roland Sweet P • CalComp... please call for prices.



\$2495
\$759

80 Character Daisy Wheel Printer

These Fujitsu Daisy Max 830 were manufactured for Motorola's Computer Division. The purchase order was canceled and Fujitsu was forced to liquidate these 80 character per second daisy wheel printers at "fire sale" prices.

Features: bullet proof construction, serial RS-232 interface, Diablo 630 wheels and commands, programmable line spacing in increments of 1/96" and column spacing of 1/120". The printer is also capable of underscoring, bold overprint, shadow print, centers and justifies along with vector plotting.

Factory suggested price of the Daisy Max 830 was \$2495, while supplies last California Digital is offering this liquidated special at only \$759. Also available: tractor and sheet feeders.



COLOR GRAPHICS TERMINAL
\$3985
\$659

The Lear Siegler 7107 color graphics terminal is both DEC (VT-100 / VT-51) and Tektronix (4010/4014) compatible. The terminal offers a palette of 4,096 colors with a resolution of 640 by 480 pixels on a 13 inch non-glare color screen. Horizontal pan and image zoom, to 16 times original size, are standard features of this color graphics terminal. The 7107 is the ideal terminal for CAD/CAM applications.

NOW YOUR COMPUTER CAN READ!

Omni-Reader... the first optical character reader designed and priced for the small computer **\$179**

COPY:
 -Manuscripts -Contracts -Articles
 -Forms -Invoices

APPLICATIONS:
 -Mailing Lists -Editing -Data Base Management -Transferring information between incompatible systems

Use a standard RS-232 serial port hookup to interface easily with your computer.

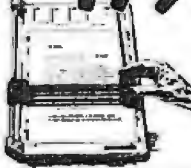
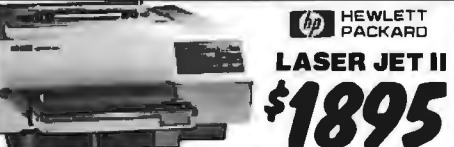
hp HEWLETT PACKARD LASER JET II
\$1895

Now from Hewlett Packard the LaserJet Series II. More features than the LaserJet but at a much lower price. Standard on the Series II is 512 K/byte memory expandable to 4 Megabytes, both serial and parallel ports. List price \$2495 California Digital price \$1895. Memory upgrade, type fonts and toner cartridges available.

Other Laser Printers available:
Texas Instruments • Okidata • Apple • Ricoh Qume • AST Research • QMS • Xerox • Canon Quadram • Centronics • CIE C.Itoh • DataProducts



\$35

We have them again... The Remex 480 was a sell out two years ago but we located an additional 10,000 units and are offering these 2/3 height IBM/PC compatible 360K/Byte drives at only \$35 each at quantity two.

\$85

The Mitsubishi 4851 was probably the best 360 K/Byte drive ever produced. The production cost was too high and Mitsubishi discontinued the product. Quantity two \$85 each.

\$115

The Panasonic 475 is jumper selectable between 96 TPI format and 1.2 Megabyte as used in the IBM AT computer. Suggested price of the 475 is \$199 but California Digital located a computer manufacturer that had to liquidate stock making available 1000 of these choice drives. Quantity two \$115 each.

	One	Two	Ten
REMEK 480 3/4 height for PC	39	35	call
MITSUBISHI 4851 360K/Byte	89	85	82
MITSUBISHI 4853 96 TPI.	99	95	92
MITSUBISHI new 501 half ht.	129	119	109
MITSUBISHI 504A AT comp.	169	159	155
TEAC FD55BV half height	109	99	89
TEAC FD55FV 96 TPI, half ht.	119	109	105
TEAC FD55GF for IBM AT	169	159	155
PANASONIC 455 Half Height	109	99	89
PANASONIC 475 1.2 Meg./96	119	115	109
Switching power supply			49
Dual enclosure for 5 1/4" drives			39



SONY \$139

The Sony 53W is a 3 1/2 inch double sided double density disk drive. The drive can be connected to your existing floppy controller but will require MS/DOS 3.2 to properly operate in the PC and compatibles. The 53W is similar to the drive being used in the PC portable.



Bernoulli Box
 was \$3540 now only **\$1595**

The Bernoulli Box by Iomega, features 10 and 20 megabyte removable cartridges, and delivers reliability, expandability, transportability, security and speed in one versatile subsystem. It lets you transfer megabytes of information safely and swiftly for primary or backup storage. Or combine several software programs onto a single cartridge for easy switching from one to another.

Reliable... The Box has incredible resistance to shock and vibration completely eliminating the possibility of head crash.

Expandable... grow at your own pace by adding inexpensive cartridges. When security is essential, don't lock up your system... just lock up the cartridges.

The Bernoulli Box delivers performance that often exceeds the best of hard disk speed and the convenience of floppy disks. At these prices don't be caught wishing you had one after a loss of irreplaceable data.

	List	Our Price
10 + 10 Meg. A2210H	\$3450	1595
20 + 20 Meg. A2220H	4540	2095
Bootable Controller	255	189
10 Meg. Cartridge	79	49
20 Meg. Cartridge	99	65



Smarteam 2400 Baud \$289

The Smarteam 2400 offers all the features of the Hayes Smart Modem 2400 for a fraction of the price. Now is your opportunity to purchase a 2400 baud modem for only \$289.

Also available: The Smarteam 1200 at only \$139

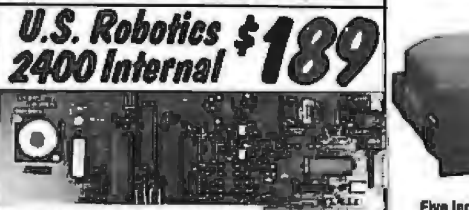

U.S. Robotics 2400 Internal \$189



\$99

This 300/1200 baud modem matches design specs of Bell 212A and for all practical purpose those of the Hayes Smart Modem. The Avatec brings you reliable data transmission for only \$99.

OTHER MODEMS AVAILABLE:
 Hayes • Universal Data • Fujitsu Prometheus • Anchor • US Robotics



21 Megabyte Gold Card \$479

Also available 31 Megabytes at only \$559.

The fastest, lowest powered, longest warranted, most durable, highest capacity, most reliable, lowest priced HARD-DISK-ON-A-CARD available in the world today.

• 55ms Access Time • Fragment Avoidance • Automatic Head Unloading • Protects Heads and Media • 2K Sector Buffer • Increases System Throughput • High Reliability, 20,000 hr. MTBF No on-site service • 15.5 WATT Power Consumption • Lowest Available • 2 Year Warranty Longest Available



Seagate 30 MEGABYTE WINCHESTER HARD DISK KIT \$459



Five Inch Winchester Disk Drives

	each	two+
SEAGATE 225 20 Meg. 1/2 Hl.	319	299
SEAGATE 238 30 Meg. RLL	369	359
SEAGATE 4026 26 M. 35ms.	659	629
SEAGATE 4051 51 M. 35ms.	769	739
FUJITSU 2242 55 M. 35ms.	1399	1329
FUJITSU 2243 85 M. 35ms.	1895	1819
RODIME RO-202E 27 Meg.	859	829
RODIME RO-203E 40 Meg.	895	859
RODIME RO-204E 53 Meg.	995	959
CONTROL DATA 94155-86 M	1829	1779
MAXTOR XT1140 140 Meg.	2595	2529
TOSHIBA MK5670 M. 30ms.	1789	1729
TANDON 502 10 Meg.	419	379

TOLL FREE ORDER LINE
(800) 421-5041
TECHNICAL & CALIFORNIA
(213) 217-0500

Shipping: First five pounds \$3.00, each additional pound \$.50. Foreign orders: 10% shipping, excess will be refunded. California residents add 6 1/2% sales tax. • COD's discouraged. Open accounts extended to state supported educational institutions and companies with a strong "Dun & Bradstreet" rating.



TeleFax
(213) 217-1951

TIMELINE INC.

20 MILLION I.C.'S IN STOCK!
Minimum I.C. Order: \$200.00

Continental U.S.A. Order Desk	Inside California	L.A. & Technical Info	OEM INQUIRIES WELCOME
(800) 872-8878	(800) 223-9977	(213) 217-8912	

THE BEST COLOR GRAPHICS BUY OF THE CENTURY!

\$699.00

BOARD FEATURES: • Multiple Modes:

CGA: 320 x 200 - ENHANCED TO 640x400

EGA: 640 x 350 - ENHANCED TO 640x400

- **PGA RESOLUTION: 640x480** USING MICROSOFT WINDOWS, LOTUS, AUTOCAD, P CAD, ETC.
- HERCULES: 720x350
- AUTOSWITCH
- PARALLEL PRINTER PORT

MONITOR FEATURES:

- 13" DIAGONAL VIEWING AREA/NON-GLARE SCREEN
- MATRIX PITCH: 0.31mm/BLACK MATRIX
- ADDRESSABILITY: 640 HORIZONTAL x 480 VERTICAL
- PGA COMPATIBLE- OPERATES WITH SEPERATE RED, GREEN & BLUE ANALOG SIGNALS AND CAN SUPPORT AN INFINITE NUMBER OF COLORS.

INCLUDES:
EGA CARD, MONITOR, CABLES & SOFTWARE



Call for Dealer Prices (10 or more)

If this monitor looks familiar, you have probably discovered one of the reasons why this is the best deal of the century. This incredibly built display was manufactured by the most prestigious company in the industry. Along with Classic Technology's™ new EGA adapter using Paradise's™ single chip (PEGA II)™ combined with Paradise's™ BIOS, we are able to bring to market the most spectacular EGA package in the industry.

Imagine your CGA Software running at better than EGA Resolution

IBM COMPATIBLE FLOPPY DISK DRIVES

YOUR CHOICE

DS/DD
360 K
5 1/4" 1/2 HEIGHT

QUME TRACK 142
BELT DRIVE
\$65.00

MITSUBISHI 4851
DIRECT DRIVE
\$89.00 (2 to 10 - \$79.00)

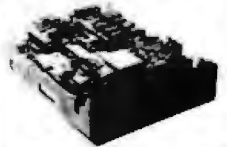

ASTECH 65 WATT SWITCHING POWER SUPPLY

Dual Input voltage 115/230 VAC - Overvoltage protection - Short circuit protection - Dual Isolated +12V - Built-in EMI filter - Very compact size - UL/CSA/VDE approved - 100% thermal cycle & burn-in - High efficiency - Vacuum impregnated transformers - Convection cooling - Open PCB "L" bracket or boxed construction. Condition: No.2

OUTPUTS: +5V DC @ 6.0A +5V DC @ 6.0A (with two +12V outputs in parallel)
 Conditions: +12V DC @ 1.5A +12V DC (with two +12V outputs in parallel) @ No.1
 +12V DC @ 2.1A @ 3.5A (5.0A surge)
 -12V DC @ 0.25A -12V DC @ 0.25A

Dimensions:
8.0" - Length
4.4" - Width
2.4" - Height

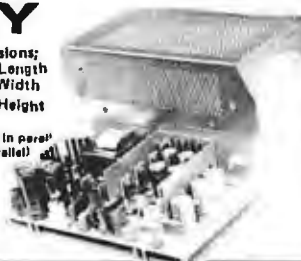

MODEL No. AC9335-01 **\$29.95**

Macintosh Plus 20Mb Winchester DISK SUBSYSTEM

FEATURES:

- (A) 3.5" Hard disk drive with integrated SCSI controller (formats to 20.6 Mb)
- (B) Power Supply
- (C) Low noise cooling fan
- (D) Two SCSI ports (allows up to 7 units to be daisy-chained providing up to 144 Mb of storage.)

WOW!

\$599.00

1490 W. ARTESIA BLVD., GARDENA, CA. 90247
 Continental U.S.A. Inside California L.A. Area & Technical Info.
 (800) 872-8878 (800) 223-9977 (213) 217-8912

Minimum Order: \$25.00. Shipping & handling charges via UPS Ground: \$.50c/lb. UPS Air: \$1.00/lb. Minimum Charge: \$4.00. We accept cashiers checks, MC or VISA. No personal check COD's. Items reflect 5% cash or check discount. California residents add 6 1/2% sales tax. We are not responsible for typographical errors. All merchandise subject to prior sale. Phone orders welcome. Foreign Orders require special handling. Prices subject to change without notice. 15% Restocking fee for returned orders



Inquiry 324



ACP Has It All!!

CLOSEOUTS! SUPPLY LIMITED!

SHARP PC5000 Laptop	\$199.00
3M DC100A Data Cartridge	12.85
3M DC300A Data Cartridge	14.85
256K Intelligent Buffer	189.00
Quadboard II w/64K	89.95
Rixon 1200 Baud Modem (Int.)	88.00
STB R10 w/64K	89.95
STB Super Res 400 Color	249.95
Orchid PC Turbo 186 w/128K	99.00
Orchid PC NET Blossom w/64K	195.00
Q&A IBM Software/New Vers.	249.00
6 Slot IBM Expansion Box	149.95
MacLion Database (400K) Mac	11.88
Data Products 8050C	
Color Printer (OEM)	595.00
AST I/O Plus/XT	59.95
Persyst SB-III Multi-I/O	119.95
Persyst EG-8 EGA Card	169.95
Persyst Mono or Color Combo	99.95
Bernoulli Dual 20Mb (refurb)	1499.00

WHILE STOCK LASTS!

IF YOU DON'T SEE WHAT
YOU NEED...CALL US!!!

IBM® COMPATIBLE CARDS

Largest Selection!!!

A210 Color/Printer/Graphics	\$ 69.00
A240 Mono/Printer/Graphics	79.00
A250 Mono/Printer/Graphics/132 col.	59.00
A261 Mono/Graphics/Printer-Short Card	69.00
A271 EGA/256K RAM-Short Card	169.00
A272 EGA Genoa Compatible	269.00
A320 384 Multifunction Card-OK RAM	69.95
A340 Multifunction/Floppy	89.95
A350 640K RAM Card-OK RAM	59.00
A410 Floppy Card-2 Drives	29.00
A410 Floppy Card-4 Drives	39.00
A510 Parallel/Serial/Optional Serial	59.95
A520 Parallel Card	35.00
A530 Serial Card	49.00
A610 AT 2Mb Multi-function-OK	89.95
A620 AT 3Mb RAM Card	89.95
A630 AT Parallel/Serial/Optional Serial	59.00
A640 AT Floppy/Hard Controller	199.00
A650 AT I/O Card-Ser/Par/Cik	55.00
A950 AT Motherboard-OK	399.00
A960 XT Motherboard-OK	99.00
A970 XT Turbo Motherboard-OK	119.00
A980 AT Mini Motherboard	399.00

AST	
AT Advantage/6MHz/1.5Mb	\$489.00
AT Advantage/6MHz/3 Mb	699.00
Rampage AT/6MHz w/OK	299.00
Rampage AT/6MHz w/512K	359.00
Rampage AT/6MHz w/2Mb	549.00
Preview I/O 6MHz XT/AT	189.00
AST-3G PLUS "EGA"	188.00
Sixpack Premium w/256K	299.00
Sixpack Premium EGA	599.00
Sixpack PLUS/OK	169.00
SPECIAL! SPECIAL! SPECIAL! SPECIAL!	
Knight Security Software	149.00
COMBO PLUS/64K	69.00
5251/11	579.00
5251/12	499.00
5251/11 Plus	849.00

COMPUTERS	
Zenith Z-148 Bundle	\$949.00
Zenith Z-181 Laptop	1749.00
Zenith Z-158 XT Bundle	1499.00
Advanced 286 6/10 MHz AT	1288.00
AST Premium AT	CALL
AST Turbo Laser	3995.00
DCA	

HARDWARE

HAYES (2 Yr. Warranty)	
1200RS-232 External	\$366.00
1200B w/SMARTCOM I (INT.)	344.00
2400 RS-232 External	509.00
2400 w/SMARTCOM II (INT.)	499.00
Migent Pocket Modem	149.00
Capetronic Wall Mount 1200	119.00
Cross Talk XVI	149.00
Hayes Compatible (Ext.)	98.00
Hayes Compatible (Int.) 1200B	98.00
Hayes Compatible (Ext.) 2400B	239.00

HERCULES

Hercules Color Card	\$188.00
NEW! NEW! NEW! NEW! NEW!	
Hercules Plus Graphics	239.00

INTEL (5 yr. Warranty)

Above Board PC/XT 64K	CALL
Above Board AT 128K	CALL
Inboard 386/AT	1488.00

KEYTRONICS

5150 Keyboard	\$159.95
5151 Deluxe Keyboard	189.95
5153 Deluxe Keyboardw/Touchpad	285.95
PC Jr. Numeric Keypad	29.95

Advanced Keyboards

ACP 5150 Keyboard	58.95
ACP 5151 Deluxe Keyboard	79.95
ACP 5160 AT/XT Keyboard	88.95
ACP 5152 XT/AT Keyboard	79.95

MEMORY

64K (9) 150ns	\$ 9.95
64K (9) 120ns	11.95
256K (9) 150ns	28.95
256K (9) 120ns	32.95
256K (9) 100ns	39.95
1Mb Chip 100ns	Ea. 33.95

CO-PROCESSOR

8087	\$105.00
8087-2	145.00
80287-6	165.00
80287-8	280.00
80287-10	449.00
V20-8MHz	9.95

MICROSOFT

Microsoft Mouse	\$139.00
Microsoft Bus Version	155.00

MOUSE SYSTEMS

(3 Yr. Warranty)	
PC Mouse w/Print Plus	\$138.00
PC Mouse w/Ready & Print	140.00
ACP Mouse w/Keyboard	SALE! 99.00

QUADRAM

Silver Quadboard PC/XT	\$129.95
Liberty PC/XT OK	169.00
Liberty 2 Mb	408.00
Quadprint PC/XT Accelerator	199.95
Quad EMS I/O + 256K	339.00

PRINTERS

BROTHER	
M2024L (24 Pin)	Sale \$899.00
M1109 100CPS	189.00
M1409 45 cps NLQ	359.00
M1509 45 cps NLQ	489.00
M1709 50 cps NLQ	589.00

EPSON (3 Yr. Warranty)

EX 800 250 cps/50 cps NLQ	\$ 499.00
EX 1000 Wide Carriage	879.00
FX86E 160 cps NLQ	388.00
FX286E 160 cps Wide	529.00

TOSHIBA

P321 "3 in 1" 24 Pin LQ Printer	\$479.00
P341E 24 Pin/216 cps	659.00
P351-C Color	1195.00
P351 Model 2	1075.00
T1100 & T3100	CALL

LIMITED SPECIAL!

8 PEN PLOTTER	
Roiland's DXY-800 Flatbed X-Y Plotter.	
Including Parallel/Serial Interface.	
IBM Compatible	NOW ONLY \$499.00
DXY 101 Pen Plotter	299.00

EGA SPECIALS

• EGA Monitor	
• plus Upgrade Card	\$519.
• NEC Multisync	\$749

SUPER AT VALUE

SHOWN WITH
OPTIONAL
MONITOR AND
SECOND
DISK DRIVE

100% SATISFACTION GUARANTEED!

MONITORS

Amdek 310A TTL	\$155.00
NEC Multisync	599.00
Princeton MAX-12 TTL	179.00
Samsung TTL IBM Green/Amber	88.00
TECO CGA Monitor	299.00
TECO EGA Monitor	399.00

TAXAN

760 EGA Monitor 14"	\$550.00
660 EGA Monitor 12"	540.00
560 EGA Card w/Autoswitching	299.00

SPECIAL! SPECIAL! SPECIAL! SPECIAL!

560 EGA Plus	
EGA Monitor 660 or 760	749.00

MORE EGA...

Advanced EGA/256K/Short Card	\$169.00
ATI EGA Wonder	289.00
Genoa EGA	319.00
Paradise Autoswitch	349.00
Quad EGA Plus/Quadram	299.00
RIX EGA Paint	59.00

PGA SPECIALS

IBM Professional, Limited Quantity IBM PGA Card, Regular \$2995.00	SALE \$995.00
--	---------------

HARD DISC CARDS

Filecard 20 Western Digital	\$479.00
Filecard 30 Western Digital	588.00
10 Mb Drive only	149.00
21 Mb XT Subsystem WD	388.00
21 Mb XT Subsystem CMI/Tandon	368.00
21Mb XT Subsystem Seagate ST225	386.00
30 Mb XT Subsystem Seagate ST238	499.00
30 Mb AT Drive (40MS.) ST4038	469.00
40 Mb AT Drive (40MS.) NEC 5046	599.00

CALL FOR HIGHER STORAGE DRIVES!

3-1/2" DRIVES HARD DISKS

10 Mb 3-1/2" Drive/Rodine equiv.	\$188.00
20 Mb 3-1/2" LaFine LT200	299.00
30 Mb 3-1/2" LaFine LT300	359.00

BEST BACK-UP!

Use the same back-up device we use at ACP	
AlphaMicro VCR Backup Card	\$399.00
AlphaMicro VCR	899.00

DISK DRIVES

ACP IBM Drives DS	\$ 69.95
Toshiba FD04403 3-1/2" w/Kit	129.00
Toshiba ND040 PC/XT 360K	95.00
Toshiba ND04E-G AT 360K	105.00
Toshiba ND08DE-G 1.2Mb	129.00
TEAC FD-55B	99.00

DISKETTES (BOX OF 10)

DS/DD for PC/XT (40tpi)	
• ACP Generic	\$ 8.00
• Verbatim Datalife	14.95
• Maxell MD-2	14.95
• Fuji	14.95
DX/Hi-Density for AT (96tpi)	
• Verbatim	28.95
• Maxell	28.95
• Fuji	28.95
SS/DD for Apple II/etc.	
• Verbatim/Maxell/Fuji	12.95
• Macintosh/IBM Conv. 3-1/2"	
• Maxell MF-2DD	28.95
• Fuji MF-2DD (135tpi)	28.95

MORE ACCESSORIES...

Flip-Soft (holds up to 75 disks)	14.00
ACP 5-1/4" Disk Holder	9.00
ACP 3-1/2" Disk Holder	12.00
Head Cleaner 5-1/4" or 8"	9.00

SUPER SALE! \$1166.

"...retail value
over \$2995! You get...

SHARP "AT" Model 7501K...

- (made by the same Mfg. as Epson Equity III)
- 80286 6/8 MHz Switchable
 - 512K RAM Expandable to 640K
 - Hard Disk Controller • 84 key AT Keyboard
 - 1.2Mb Floppy w/Controller • 8 I/O Slots
 - Serial and Parallel Ports
 - MS-DOS 3.1 & GW Basic included FREE

PLUS SPECIAL OFFER...

AST "ADVANTAGE AT" w/3Mb ONLY \$599.00
...List \$1745.00

That's right...get a 3Mb factory populated
AST Advantage card plus serial/parallel
I/O, tested! — With purchase ONLY \$599

PLUS...

FREE Software including SIDEKICK®
DESQVIEW® and SUPERPAK®

FACTORY WARRANTY INCLUDED

SUPER VALUE! \$588.

Advanced PC/XT

...over 4000 Satisfied Customers!

- Manufactured by Toshiba. This is the finest IBM compatible manufactured today...we can prove it!
- FCC/UP Approved
 - (1) 360K Floppy
 - Serial/Parallel/LCD
 - Mouse & Keyboard
 - RGB Color Graphics
 - 256K easily expandable to 640K
 - 10Mb Hard Disk/Add \$300
 - 20Mb/Add \$401.

BARE BONES PRICE!!! \$299

Advanced 8 MHz XT Turbo

- Zinc-lined FCC Case
- 150W Power Supply
- XT/AT Deluxe Keyboard
- Phoenix BIOS
- Runs all Major software written for IBM

90 DAY WARRANTY

Advanced Computer Products Inc.

TOLL FREE

800-854-8230

CA Residents 714-558-8813

Retail: 1310 B E. Edinger, Santa Ana, CA

CORPORATE BUYERS - CALL
GILLES, PHIL, MIKE or DAVE

NEC V20 & V30 CHIPS

Replace the 8086 or 8088 in Your IBM-PC and Increase Its Speed by Up to 40%!

Part No.	Price
UPD70108-5 (5MHz) V20 Chip	\$ 9.95
UPD70108-8 (8MHz) V20 Chip	\$ 11.95
UPD70116-8 (8MHz) V30 Chip	\$ 14.95
UPD70116-10 (10MHz) V30 Chip	\$ 34.95

7400

Part No.	1-9	10+	Part No.	1-9	10+
7400	.29	.19	7485	.65	.55
7402	.29	.19	7486	.45	.35
7404	.35	.25	7489	2.05	1.95
7405	.39	.29	7490	.49	.39
7406	.39	.29	7493	.45	.35
7407	.39	.29	74121	.45	.35
7408	.35	.25	74123	.59	.49
7410	.35	.25	74125	.59	.45
7414	.39	.29	74126	.65	.55
7416	.45	.35	74143	4.05	3.95
7417	.45	.35	74150	1.35	1.25
7420	.35	.25	74154	1.35	1.25
7430	.35	.25	74158	1.59	1.49
7432	.39	.29	74173	.85	.75
7438	.39	.29	74174	.85	.75
7442	.39	.29	74175	.65	.55
7445	.79	.69	74176	.99	.89
7446	.89	.79	74181	1.95	1.85
7447	.89	.79	74189	2.05	1.95
7448	2.05	1.95	74193	.79	.69
7472	.75	.65	74198	1.85	1.75
7473	.45	.35	74221	.89	.79
7474	.45	.35	74273	2.05	1.95
7475	.49	.39	74365	.69	.59
7476	.45	.35	74367	.69	.59

74LS

74LS00	.29	.19	74LS165	.75	.65
74LS02	.29	.19	74LS166	.99	.89
74LS04	.35	.25	74LS173	.59	.49
74LS06	.35	.25	74LS174	.49	.39
74LS08	1.09	.99	74LS175	.49	.39
74LS07	1.09	.99	74LS189	4.59	4.49
74LS08	.29	.19	74LS191	.59	.49
74LS10	.29	.19	74LS193	.79	.69
74LS14	.49	.39	74LS221	.69	.59
74LS27	.35	.25	74LS240	.79	.69
74LS30	.29	.19	74LS243	.79	.69
74LS32	.35	.25	74LS244	.79	.69
74LS42	.49	.39	74LS245	.89	.79
74LS47	.99	.89	74LS259	.99	.89
74LS73	.39	.29	74LS273	.89	.79
74LS74	.35	.25	74LS279	.49	.39
74LS75	.49	.39	74LS322	4.05	3.95
74LS76	.55	.45	74LS365	.49	.39
74LS85	.59	.49	74LS366	.49	.39
74LS86	.35	.25	74LS367	.49	.39
74LS90	.49	.39	74LS368	.49	.39
74LS93	.49	.39	74LS373	.79	.69
74LS123	.59	.49	74LS374	.79	.69
74LS125	.49	.39	74LS393	.89	.79
74LS138	.49	.39	74LS590	6.05	5.95
74LS139	.49	.39	74LS624	2.05	1.95
74LS154	1.09	.99	74LS629	2.29	2.19
74LS157	.45	.35	74LS640	1.09	.99
74LS158	.45	.35	74LS645	1.09	.99
74LS163	.49	.39	74LS670	1.09	.99
74LS164	.59	.49	74LS688	2.05	1.95

74S/PROMS*

74S00	.29	74S188	1.29
74S04	.35	74S189	1.69
74S08	.35	74S196	2.49
74S10	.29	74S240	1.49
74S32	.35	74S244	1.49
74S74	.49	74S253	1.49
74S85	1.79	74S283	1.49
74S86	.35	74S288	1.49
74S124	2.95	74S373	1.49
74S174	.79	74S374	1.49
74S175	.79	74S472	2.95

74F

74F00	.39	74F139	.89
74F04	.39	74F157	.95
74F08	.39	74F183	3.95
74F10	.39	74F199	1.39
74F32	.39	74F244	1.39
74F74	.49	74F253	.99
74F86	.59	74F373	1.39
74F138	.89	74F374	1.39

CD - CMOS

CD4001	.19	CD4076	.65
CD4008	.89	CD4081	.25
CD4011	.49	CD4082	.25
CD4013	.29	CD4093	.35
CD4016	.29	CD4094	.89
CD4017	.55	CD40103	2.49
CD4018	.59	CD40107	.69
CD4020	.59	CD40109	1.49
CD4024	.49	CD451	.69
CD4027	.35	CD4510	.69
CD4030	.29	CD4520	.75
CD4040	.65	CD4522	.79
CD4049	.29	CD4538	.79
CD4050	.59	CD4539	.89
CD4051	.59	CD4543	.79
CD4052	.59	CD4553	4.95
CD4053	.59	CD4555	.79
CD4059	3.95	CD4566	2.49
CD4063	1.95	CD4572 (MC14572)	.39
CD4066	.69	CD4582	.39
CD4069	.39	CD4583	.39
CD4070	.25	CD4585	.89
CD4071	.25	MC14411P	8.95
CD4072	.25	MC14490P	4.49

COMMODORE CHIPS

Part No.	Price	Part No.	Price	Part No.	Price
WD1770 Disk Cont.	19.95	6551 ACIA	3.29	8722 MMU	9.95
SI-3052P 5V Positive Voltage Reg. 2A	5.95	6560 VIC	10.95	*25104-04 Kernal ROM	10.95
6502 MPU w/int. Clock	2.25	6567 VIC	14.95	318018-03 Basic ROM-C128	15.95
6504A CPU	1.95	6569 VIC PAL	14.95	318019-03 Basic ROM-C128	15.95
6507 CPU	4.95	6572 VIC PAL-N	14.95	318020-04 Kernal ROM-C128	15.95
6510 CPU	9.95	6581 SD	14.95	325302-01 64K ROM for 154015-11 Drive	15.95
6520 PIA	1.75	8360 Text Editing	10.95	*325572-01 Logic Array	24.95
6522 VIA	2.95	8501 MPU	10.95	*825100PLA (90614-01)	13.95
6525 TPL	7.95	8502 MPU	7.95	901225-01 BASIC ROM	11.95
6526 CIA	14.95	8563 CRT Contr.	15.95	901226-01 BASIC ROM	11.95
6529 SPI	4.95	8564 VIC	15.95	901227-03 Kernal ROM	11.95
6532 128KRAM/IO, Tim/Ar	6.49	8566 VIC PAL	29.95	901229-05 Upgrade ROM (For 1541 Disk Drive)	15.95
6545-1 CRT	2.49	8701 Clock Chip	9.95	*No specs. available	
		*8721 PLA	14.95	(For 82S100PLA = U17 (C-64))	

MICROPROCESSOR COMPONENTS

MISCELLANEOUS CHIPS		6500/6800/68000 Cont.		8000 SERIES Cont.	
Part No.	Price	Part No.	Price	Part No.	Price
D765AC	4.49	6840	3.95	8228	2.49
WD1770	19.95	6843	2.95	8237-5	4.95
2661-3	5.95	6845	2.95	8243	2.25
WD9216	9.95	6850	1.49	8250A	5.49
Z80, Z80A, Z80B SERIES		6852	3.95	8250B (For IBM)	6.95
Z80	1.25	6855	8.95	8251A	1.75
Z80-CTC	1.79	MC68000L8	11.95	8253-5	1.95
Z80-DART	4.95	MC68000L10	19.95	8254	2.95
Z80-PIO	1.79	8001	2.95	8255A-5	1.69
Z80A	1.35	80C31BH	14.95	8257-5	2.49
Z80A-CTC	1.49	8035	1.49	8259-5	1.95
Z80A-DART	4.49	8073	29.95	8271A	4.49
Z80A-PIO	1.49	8080A	2.49	8272-5	2.95
Z80A-SIO/O	4.95	8085A	2.29	8741	10.95
Z80B	2.95	8086	6.95	8748	7.95
Z80B-CTC	3.49	8086-2	8.95	8749	39.95
Z80B-PIO	4.29	8087 (6MHz)	125.00	8751	39.95
6500/6800/68000 SER.		8087-2 (8MHz)	159.95	8755	14.95
6502	2.25	8088	4.49		
6502C (CMOS)	8.95	8088-2	8.95		
6520	1.75	8116	4.95		
6522	2.95	8155	1.95		
6532	6.49	8155-2	2.49		
6561	3.29	8156	2.49		
6800	1.75	8202	9.95		
6802	3.49	8203	14.95		
6810	1.25	8212	1.25		
6821	1.29	8224	2.49		

DYNAMIC RAMS

Part No.	Function	Price
4116-15	16,384 x 1 (150ns)	.89
4128-20 (Piggyback)	131,072 x 1 (200ns)	4.49
4164-120	65,536 x 1 (120ns)	1.75
4164-150	65,536 x 1 (150ns)	1.15
4164-200	65,536 x 1 (200ns)	.95
TMS4416-12	16,384 x 4 (120ns)	4.25
8118	16,384 x 1 (120ns)	.69
41256-120	262,144 x 1 (120ns)	3.95
41256-150	262,144 x 1 (150ns)	2.75
50464-15	65,536 x 4 (150ns) (4464) (41464)	4.95
51100P-10	1,048,576 x 1 (100ns) 1 Meg.	39.95
514256P-10	262,144 x 4 (100ns) 1 Meg.	44.95

STATIC RAMS

Part No.	Function	Price
2016-12	2048 x 8 (120ns)	1.69
2102-2L	1024 x 1 (450ns) Low Power (91 L02)	1.95
2114N	1024 x 4 (450ns)	.99
2114N-2	1024 x 4 (200ns)	1.05
2114N-2L	1024 x 4 (200ns) Low Power	1.49
21C14	1024 x 4 (200ns) (CMOS)	.49
2149	1024 x 4 (45ns)	4.95
5101	256 x 4 (450ns) CMOS	1.95
6116LP-2	2048 x 8 (120ns) Low Power CMOS	2.95
6116LP-3	2048 x 8 (150ns) CMOS	3.95
6116LP-3	2048 x 8 (150ns) Low Power	1.95
6264LP-15	8192 x 8 (120ns) Low Power CMOS	4.25
6264LP-15	8192 x 8 (150ns) CMOS	3.59
6264LP-15	8192 x 8 (150ns) Low Power CMOS	3.75
6514	1024 x 4 (350ns) CMOS (UPD444C)	4.49
43256-15L	32,768 x 8 (150ns) Low Power	24.95

PROMS/EPROMS

Part No.	Function	Price
1702A	256 x 8 (1µs)	6.95
TMS2516	2048 x 8 (450ns) 25V	4.95
TMS2532	4096 x 8 (450ns) 25V	5.95
TMS2564	8192 x 8 (450ns) 25V	8.95
2708	1024 x 8 (450ns)	4.95
TMS2716	2048 x 8 (450ns) 3 voltage	9.95
2712	2048 x 8 (450ns)	3.75
2716-1	2048 x 8 (350ns) 25V	4.95
27C16	2048 x 8 (450ns) 25V (CMOS)	6.49
2732	4096 x 8 (450ns)	3.95
2732A-20	4096 x 8 (200ns) 21V	4.25
2732A-25	4096 x 8 (250ns) 21V	3.95
2732A-35	4096 x 8 (350ns) 21V	3.75
27C32	4096 x 8 (450ns) 25V (CMOS)	6.49
2764-20	8192 x 8 (200ns) 21V	4.25
2764-25	8192 x 8 (250ns) 21V	3.75
2764A-25	8192 x 8 (250ns) 12.5V	4.25
2764-45	8192 x 8 (450ns) 21V	3.49
27C64	8192 x 8 (450ns) 21V (CMOS)	5.49
27128-15	16,384 x 8 (150ns) 128K 21V	6.49
27128-20	16,384 x 8 (200ns) 128K 21V	4.95
27128-25	16,384 x 8 (250ns) 128K 21V	4.25
27128-35	16,384 x 8 (350ns) 12.5V	4.95
27C128-25	16,384 x 8 (250ns) 21V (CMOS)	5.95
27256-20	32,768 x 8 (200ns) 256K (12.5V)	6.95
27256-25	32,768 x 8 (250ns) 256K (12.5V)	5.95
27C256-25	32,768 x 8 (250ns) 512K (CMOS) (12.5V)	8.95
27512-25	65,536 x 8 (250ns) 512K (12.5V)	13.95
6876	8192 x 8 (450ns) 25V	15.95
68766	8192 x 8 (450ns) 25V	16.95
74S387	256 x 4 PROM O.C.	1.29
74S471	256 x 4 PROM TS.	4.95
N825123	32 x 8 PROM TS.	2.49

SATELLITE TV DESCRAMBLER CHIP

The MM5321 is a TV camera sync generator designed to supply the basic sync functions for either color or monochrome 525 line/60Hz interfaced and camera video recorder applications. COLOR BURST GATE & SYNC ALL STABLE COLOR OPERATION

Worldwide • Since 1974

• QUALITY COMPONENTS • COMPETITIVE PRICING
• PROMPT DELIVERY

Mail Order Electronics • Worldwide
Jameco
ELECTRONICS

COMMODORE® COMPATIBLE ACCESSORIES

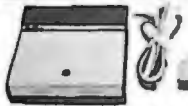

HESWARE 300 Baud Modem For VIC-20 and C-64

• Connects directly to User Port • Manual Answer/Dial • Function keys defined for convenience
• Includes Midwest Micro Associates communication software.

CM-1 (For VIC-20 and C-64) ~~\$34.95~~ **\$24.95**

External Power Supply
CPS-10 (For C-64) **\$39.95**

Parallel Printer Interface
2K Buffer, Expandable to 10K!
MW-350 (For VIC-20, C-64 & C-128) . . . **\$54.95**

TRS-80/TANDY® COMPATIBLE ACCESSORIES

E-X-P-A-N-D TRS-80 MEMORY
All kits come complete with documentation

TRS-80 MODEL 4, 4P, & 4D 64K/128K EXPANSION
TRS-64K-2 **\$7.95**
Expands Model 4 from 16K-64K or Model 4 (Gate Array Version), 4P and 4D from 64K-128K

TRS-64K-2PAL **\$14.95**
Expands Model 4 (Non-Gate Array Version) from 64K to 128K

TRS-80 MODEL 100 8K EXPANSION
M1008K **\$19.95 ea. or 3 for \$54.95**

ZUCKERBOARD

TANDY 1000 Expansion Memory Half Card
Expand the memory of your Tandy 1000 (128K Version) to as much as 640K. Also includes DMA controller chip.

TAN-EM256K Includes 256K RAM **\$ 99.95**
TAN-EM512K Includes 512K RAM **\$119.95**

Options for TAN-EM256K/512K
TAN-C Plug-in Clock option chip (only) **\$39.95**
TAN-D RAM Disk Printer Spooler Software (only) **\$39.95**

NEW! Expansion Memory NEW! Half Card for TANDY 1000SX

TSX256K Includes 256K RAM . . . **\$119.95**

TANDY 1000 Multifunction Board with Clock Calendar

Expand the memory on your Tandy 1000 (128K Version) to as much as 640K. Complete with an RS232 port, clock/calendar, RAM Disk Printer Spooler and on-board DMA controller chip.

MTAN-256K Includes 256K RAM **\$179.95**
MTAN-512K Includes 512K RAM **\$199.95**

NEW! Multifunction NEW! Board for TANDY 1000SX

M256K Includes 256K RAM **\$189.95**

UV-EPROM ERASER



Erases all EPROMs. Erases up to 8 chips within 21 minutes (1 chip in 15 minutes). Maintains constant exposure distance of 1". Special conductive foam liner eliminates static build-up. Built-in safety lock to prevent UV exposure. Compact-9.00" x 3.70" W x 2.60" H. Complete with holding tray for 8 chips.

DE-4 UV-EPROM Eraser. **\$69.95**

UVS-11EL Replacement Bulb. **\$19.95**

NCF-2 Cond. Foam 12x24x1/4" Hard Blk. \$ 8.95

NOW YOU CAN BUILD AN IBM PC/XT COMPATIBLE!



IBM Compatible Kit

IBM-64K(2) 64K RAM Chips (18) . . \$ 99.90
KB83 83-Key Keyboard \$ 29.95
IBM-FCC Floppy Controller Card \$ 34.95
IBM-Case Case \$ 39.95
IBM-MCC Monochrome Card . . \$ 59.95
IBM-PS Power Supply \$ 69.95
FD55B Disk Drive \$109.95
IBM-MON Monochrome Monitor \$ 99.95
IBM-MB Motherboard \$109.95

FREE! QUICKSOFT PC WRITE WORD PROCESSING SOFTWARE INCLUDED!

Weight: 48 lbs. **Regular List \$574.50**

IBM-Special (Includes 9 items above) . . . \$499.95



IBM Special No. 2

Includes IBM AT style keyboard with tactile touch (KB5160, see below) and all the above items (except KB83) **Regular List \$604.50**

Weight: 48 lbs. **\$529.95**

ADDITIONAL ADD-ONS AVAILABLE!

IBM-KB 83-Key Keyboard **\$ 59.95**
IBM-ENH Enhanced Keyboard **\$ 79.95**
IBM-ICB Integrated Color Board w/Printer Port **\$ 99.95**
IBM-EGA Enhanced Graphics 256K RAM . . . **\$249.95** **\$229.95**
IBM-20MBK 20MB Hard Disk Drive, Controller & Cable . . . **\$429.95**
IMFC Multifunction 0-384K RAM (without RAM) . . . **\$109.95**
EM-100 Expansion Memory Half Card (without RAM) . . **\$ 59.95**
RS232HC RS232 Serial Half Card **\$ 29.95**
TTX-1410 14" RGB Color Monitor **\$299.95** **\$289.95**
PM1200B-2 1200/300 Baud Half Card Modem without software . . **\$129.95**
PM1200B-2S 1200/300 Baud Half Card Modem with Mirror Software . . **\$159.95**

IBM is a registered trademark of IBM Computers

NEW PRODUCTS!

Turbo 4.77/8MHz Motherboard

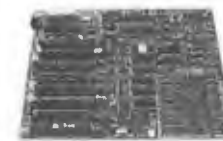

IBM PC/XT Compatible

• 75% faster than the IBM PC while in the turbo mode • Turbo Mode selectable through either software or hardware
• Expandable to 640K (comes w/zero-K)
• DTK/ERSO BIOS included

TURBO NEW! \$129.95

IBM PC/XT/AT Compatible Keyboard

NEW! AT Style Layout

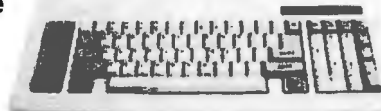

• Tactile touch keyswitches • AT style layout • Switch selectable between PC/XT or AT • Illuminated Caps Lock, Num Lock and Scroll Lock indicators • Low profile design • 8 1/2' foot cord • Manual included

KB5160 \$59.95

ZUCKERBOARD Monochrome Graphics Half Card

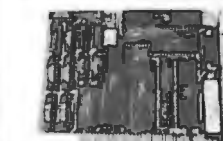

with Printer Port for IBM PC/XT/AT and Compatible Computers

• Full Hercules™ compatibility • Printer port adapter • High resolution graphics 720 x 348 pixels • Diagnostics program included • Fast refresh rate • 2-yr. warranty • Manual included

MG201 . . . NEW! . . . \$89.95

APPLE COMPATIBLE ACCESSORIES

Jameco Parallel Printer Card for Apple II, II+ and IIe



• Intelligent interface to most dot matrix graphics printers
• Centronics standard
• Advanced text printing

JE880 Parallel Printer Card **\$49.95**
JE883 64K Buffer for JE880 ~~\$69.95~~ **\$59.95**
JE8803 JE880 and JE883 ~~\$109.90~~ **\$99.95**

Jameco Extended 80-Column Card for Apple IIe



• 80 Col./64K RAM • Doubles amount of data your Apple IIe can display as well as its memory capacity • Ideal for word processing • Complete with instructions

JE864 \$59.95

Additional Apple Compatible Products Available

Jameco JE310 Fiber Optics Experimenter Kit

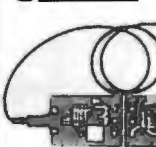

NEW! Educational device gives students and engineers hands-on experience with fiber optic technology
• Step by step instructions • Includes transmitter & receiver circuits boards, as well as all nec. IC's, cables & connectors

JE310 Fiber Optic Kit \$19.95

Jameco JE450 Solderless Proto-Type Builder

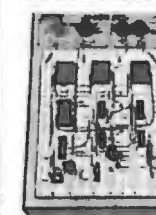

• Provides user with quick and efficient system for breadboarding electronic circuits • Components & wire leads can be quickly inserted and removed without soldering or de-soldering • 3 regulated power supplies: 5V @ 1A, +5V to +15V @ .5A, -5V to -15V @ .5A • Power: 120VAC, 60Hz fused

NEW! **JE450 Solderless Proto-Type Builder . . . \$119.95**

IBM Compatible! DISK DRIVES



Documentation Included

FD55B Teac 5 1/4" DS 1/2-H (IBM PC/XT) . . . **\$109.95**
JU-455 Panasonic 5 1/4" DS 1/2-H (IBM PC/XT) **\$109.95**
JU-475 Panasonic 5 1/4" DS 1/2-H (IBM AT) . . **\$119.95**

DATA BOOKS

30003 National Linear Data Book (82) **\$14.95**
30009 Intersil Data Book (86) **\$ 9.95**
30013 Zilog Data Book (85) **\$14.95**
30032 National Linear Supplement (84) **\$ 6.95**
210830 Intel Memory Handbook (87) **\$17.95**
230843 Intel Microsystem Hndbk. Set (87) . . . **\$24.95**

MUFFIN/Sprite-STYLE FANS



MUF60 **\$9.95**
Torin Industries (4.68" sq. 60 cfm)
SU2A1 **\$8.95**
EG&G Rotron (3.125" square, 20 cfm)

\$20 Minimum Order - U.S. Funds Only
Shipping: Add 5% plus \$1.50 Insurance

California Residents: Add 6%, 6 1/2% or 7% Sales Tax
We reserve the right to substitute IC manufacturers.

Data Sheets - 50¢ each
Prices Subject to Change

Send \$1.00 Postage for a
FREE Seasonal Flyer
FAX 415-592-2503
5/87



Send \$1.00 Postage for a
FREE 1987 CATALOG
Telex: 176043

1355 SHOREWAY ROAD, BELMONT, CA 94002 • PHONE ORDERS WELCOME 415-592-8097 ©1987 Jameco Electronics

JADE COMPUTER

Continental U.S.
(800) 421-5500

Inside California
(800) 262-1710

Technical Support
(213) 973-7707



IBM COMPATIBLE TURBO SYSTEMS

XT TURBO

- 640K of RAM
- 7 MHz Turbo Mode
- 360K Disk Drive
- Deluxe Keyboard
- 8 Expansion Slots

\$568

286 TURBO

- 640K of RAM (1 MB Motherboard)
- 8 MHz 80286
- 1.2 MB Disk Drive
- AT-Style Keyboard/Case
- 8 Expansion Slots

\$1198

12 MHz 286

- 1 MB of RAM
- 12 MHz 80286
- 1.2 MB Disk Drive
- AT Style Keyboard
- 8 Expansion Slots

\$1988

18 MHz 386

- 512K of RAM
- 18 MHz 80386
- 1.2 MB Disk Drive
- AT Style Keyboard
- 8 Expansion Slots

\$3988

CALL FOR SPECIAL PRICES ON SYSTEM PACKAGES

EPSON DAISYWHEEL

\$169

LIST PRICE \$299

Adjustable Tractor \$29

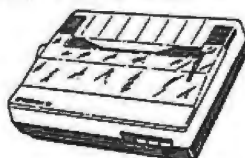

Epson DX-10, Diablo, Compatible, Letter Quality Printer

IBM PC-XT

\$1089

640K, Two 360K Drives

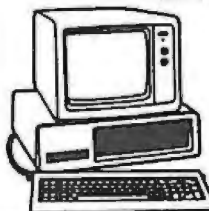

10 MB add \$190 20 MB add \$340 30 MB add \$398

NO-SLOT CLOCK

Real time clock/calendar for your IBM PC-XT, Clone or Apple II+, IIe or IIc.

\$49



- Uses No Slot
- 20 Year Battery
- Includes Software

Plug-in Clock Board for PC...\$49

3 1/2" DISK DRIVE

FOR YOUR PC/XT/AT

720K Disk Drive for Mass Storage or for Down Loading to your Lap-Top Computer. Requires DOS 3.20

\$149

ROLAND DXY-800 8 PEN PLOTTER

- Serial and Parallel
- A and B size Plots up to 17" x 11"
- AUTOCAD compatibility
- 1% accuracy, .1mm step & .3mm Repete

\$499

ROLAND DXY-880...\$895

DISK DRIVE FOR YOUR APPLE

AS LOW AS **\$119**



- 20 MB hard disk\$799
- IIc 1/2 high disk drive\$119
- IIe 1/2 high disk drive\$119
- IIe, II+ disk drive\$129
- IIe 64K, 80 column card\$49
- II+ 80 column card\$119
- Grappler printer card\$89
- II+ 16K RAM card\$39
- 1 MB RAM card w/OK.....\$129
- II+, IIe printer card & cable.....\$49
- II+, IIe cooling fan.....\$59

1200 BAUD MODEM

- Internal 1200 baud card with software\$99
- External 1200 baud\$119
- Internal 2400 Baud card with software\$299
- Hayes 1200B internal card w/o software.....\$329
- Hayes 1200B internal card w/Smartcom II\$359
- Hayes Smartmodem 1200\$389

\$99



Hayes 2400B internal card w/Smartcom II\$549
Hayes Smartmodem 2400\$589

MICROSOFT MS-DOS 3.20

Including GW-BASIC Supports 3 1/2" Drive

\$88

Hard Disk Drive

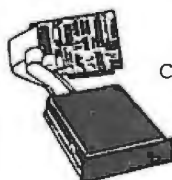

Hard Disk, Controller (PC) and Cables

\$199

- 10 MB Internal Kit.....\$199
- 20 MB Internal Kit.....\$369
- 30 MB Internal Kit.....\$398
- 30 Megabyte AT Kit.....\$499
- 40 Megabyte AT Kit.....\$699

MicroSpeed Fast 88 7 MHz Turbo Card For Your Turbo \$99

EPSON PLOTTER

FOUR PEN/FOUR COLOR

\$198

LIST PRICE \$599

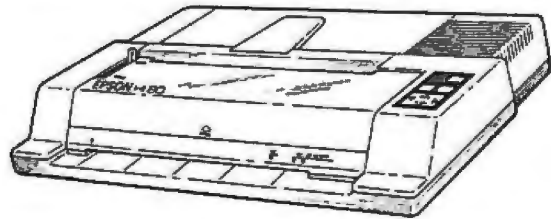

- 4 waterbase pens _____ \$5
- 4 oil base pens _____ \$5
- 100 sheets coated paper _____ \$5
- 10 sheets overhead transparency film _____ \$6
- Top rated business graphics software package for PC _____ \$29
- Parallel PC cable _____ \$19



"The Epson HI-80 is the final choice. It makes a name for itself at the low end of the price scale (\$599) and the top end of the performance scale."

PC MAGAZINE

- Fast - 9 inch per second
- Accurate - .1 mm step size
- Four Pen/Four Color
- Automatic Pen Capping
- Standard Parallel Interfacing
- Accepts Paper or Transparencies
- One Year Epson Warranty

EPSON PRINTER

\$199

LIST PRICE \$299

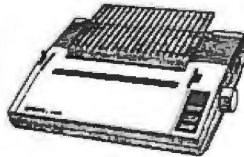

TRACTOR OR SHEET FEEDER \$29

LX-86, FX-86e/286e, EX-800/1000, LQ-800/1000/2600
IN STOCK, CALL FOR LOW LOW PRICES

360K DISK DRIVE

Built By Alpine Electronics to IBM Specifications, same as Qume 142

\$65

LIST PRICE \$199

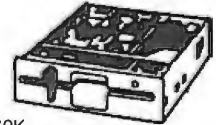

10-99 \$62⁵⁰ 100+ \$59⁹⁰

- 360K
- 48 TPI
- Double-sided
- Double density
- Half Height

HI-RES RGB MONITOR

\$289

LIST PRICE \$699

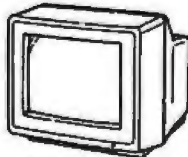

- 640 x 240 Non-glare Tube
- 16 color, .39 mm Dot Pitch
- Includes Free Cable

Manufactured by Hitachi, Samsung or Casper

HARD DISK ON A CARD

21 MB CARD

\$398

- 21.3 MB Formatted
- Lowpower

30 MB CARD

\$498

- Head Park Zone
- Plated Media
- Light 2.4 Lbs.

EGA PACKAGE

\$569

LIST PRICE \$998

- Dual Mode Monitor
- Non-glare .31 mm Dot Pitch
- 640 x 350, 640 x 200

Hi-res EGA video card...\$199
Hi-res EGA monitor...\$399

- EGA, CGA, MDA & HGA
- 100% IBM Compatible
- 256K of Video RAM

OPTI-MOUSE

The Best Mouse For Your PC!

\$99

LIST PRICE \$220

DR. HALO II

The #1 Ranked Free-Hand Graphics Software Package

\$9

With Purchase of Optimouse

ISO-BAR

Industrial quality surge suppression circuitry & built-in noise filter

- 6 socket, 1 filter ISO-BAR _____ \$44
- 4 socket, 2 filter ISO-BAR _____ \$59
- 8 socket, 4 filter ISO-BAR _____ \$69
- 200W standby power supply _____ \$269
- 450W standby power supply _____ \$399
- 675W standby power supply _____ \$599
- 1000W standby power supply _____ \$899

Multifunction Boards

- 384K Seven Pak w/OK _____ \$89
- 384K Seven Pak w/384K _____ \$139
- AST Six Pak Plus 64K _____ \$159
- AST Six Pak Plus 384K _____ \$229
- Magic I/O par, serial, clock _____ \$69
- Magic I/O parallel, serial _____ \$68
- 576K Half Card w/OK _____ \$59
- 576K Half Card w/576K _____ \$229

Monochrome & Color Monitors

- Jade Flat Screen green _____ \$99
- Jade Flat Screen amber _____ \$99
- Amdek 410
amber, green or white _____ \$179
- PGS MAX 12e amber _____ \$159
- NEC Multi-Sync 800 x 560 _____ \$599
- PGS HX-12 640 x 240 _____ \$439
- PGS HX-12e 640 x 350 _____ \$529

PC or AT Video Boards

- Hercules Color Graphics _____ \$159
- Jade Color Graphics _____ \$89
- Hercules Mono Graphics Plus _____ \$199
- Jade Monochrome Graphics _____ \$99
- Paradise AutoSwitch EGA _____ \$359
- Video 7 Vega EGA _____ \$299
- Jade EGA Plus _____ \$199

JADE COMPUTER

4901 W. Rosecrans Ave. Box 5046
Hawthorne, CA 90251-5046



Prices at our six store locations will be higher.
We accept cash, checks, credit cards or purchase orders from qualified firms and institutions. Minimum prepaid order \$15.00.

PLACE ORDERS TOLL FREE!

Continental U.S.A. (800)421-5500

Inside California (800)262-1710

Ca. & Tx. residents add sales tax. Prices & availability subject to change without notice. Shipping & handling charges via UPS Ground 50¢/lb. UPS Air \$1.00/lb. Minimum charge \$3.00.

1200B MODEM \$99.95 FOR IBM W/ SOFTWARE 2400B MODEM \$199.95

STATIC RAMS

2101	256x4	(450ns)	1.95
5101	256x4	(450ns)(CMOS)	3.95
2102L-4	1024x1	(450ns)(LP)	.99
2112	256x4	(450ns)	2.99
2114	1024x4	(450ns)	.99
2114L-4	1024x4	(450ns)(LP)	1.09
2114L-2	1024x4	(200ns)(LP)	1.49
2114L-15	1024x4	(150ns)(LP)	1.95
TMS4044-4	4096x1	(450ns)	1.95
TMM2016-150	2048x8	(150ns)	1.49
TMM2016-100	2048x8	(100ns)	1.95
HM6116-4	2048x8	(200ns)(CMOS)	1.89
HM6116-3	2048x8	(150ns)(CMOS)	1.95
HM6116L-4	2048x8	(200ns)(CMOS)(LP)	1.95
HM6116L-3	2048x8	(150ns)(CMOS)(LP)	2.05
HM6116L-2	2048x8	(120ns)(CMOS)(LP)	2.95
HM6264P-15	8192x8	(150ns)(CMOS)	3.89
HM6264LP-15	8192x8	(150ns)(CMOS)(LP)	3.95
HM6264LP-12	8192x8	(120ns)(CMOS)(LP)	4.49

LP-Low Power

DYNAMIC RAMS

4116-250	16384x1	(250ns)	.49
4116-200	16384x1	(200ns)	.89
4116-150	16384x1	(150ns)	.99
4116-120	16384x1	(120ns)	1.49
MK4332	32768x1	(200ns)	6.95
4164-200	65536x1	(200ns)(5v)	1.19
4164-150	65536x1	(150ns)(5v)	1.29
4164-120	65536x1	(120ns)(5v)	1.95
MCM6665	65536x1	(200ns)(5v)	1.95
TMS4164	65536x1	(150ns)(5v)	1.95
4164-REFRESH	65536x1	(150ns)(5v)(REFRESH)	2.95
TMS4416	16384x4	(150ns)(5v)	4.95
41128-150	131072x1	(150ns)(5v)	5.95
TMS4464-15	65536x4	(150ns)(5v)	6.95
41256-200	262144x1	(200ns)(5v)	2.95
41256-150	262144x1	(150ns)(5v)	2.95

5v=Single 5 Volt Supply

REFRESH-Pin 1 Refresh

★ ★ ★ ★ HIGH-TECH ★ ★ ★ ★

NEC V20 UPD70108 \$11.95

REPLACES 8086 TO SPEED UP IBM PC 10-40%

★ HIGH-SPEED ADDRESS CALCULATION IN HARDWARE

★ PIN COMPATIBLE WITH 8088

★ SUPERSET OF 8088 INSTRUCTION SET

★ LOW POWER CMOS

8MHZ V20 UPD70108-8 \$13.95

8MHZ V30 UPD70116-8 \$19.95

★ ★ ★ ★ SPOTLIGHT ★ ★ ★ ★

ORDER TOLL FREE 800-538-5000



EPROMS

2708	1024x8	(450ns)	4.95
2716	2048x8	(450ns)(5V)	3.49
2716-1	2048x8	(350ns)(5V)	3.95
TMS2532	4096x8	(450ns)(5V)	5.95
2732	4096x8	(450ns)(5V)	3.95
2732A	4096x8	(250ns)(5V)(21V PGM)	3.95
2732A-2	4096x8	(200ns)(5V)(21V PGM)	4.25
27C64	8192x8	(450ns)(5V)(CMOS)	5.95
2764	8192x8	(250ns)(5V)	3.49
2764-250	8192x8	(250ns)(5V)	3.95
2764-200	8192x8	(200ns)(5V)	4.25
MCM68766	8192x8	(350ns)(5V)(24 PIN)	17.95
27128	16384x8	(250ns)(5V)	4.25
27C256	32768x8	(250ns)(5V)(CMOS)	10.95
27256	32768x8	(250ns)(5V)	7.49

5V=Single 5 Volt Supply 21V PGM=Program at 21 Volts

SPECTRONICS CORPORATION EPROM ERASERS



Model	Timer	Capacity Chip	Intensity (uW/Cm ²)	Unit Price
PE-14	NO	9	8,000	\$83.00
PE-14T	YES	9	8,000	\$119.00
PE-24T	YES	12	9,600	\$175.00

8000

8035	1.49
8039	1.95
8080	2.95
8085	2.49
8087-2	169.95
8087	123.00
8088	5.95
8088-2	9.49
8155	2.49
8155-2	3.95
8748	7.95
8755	14.95
80286	129.95
80287	199.95

CRT CONTROLLERS

6845	4.95
68845	8.95
6847	11.95
HD46505SP	6.95
MC1372	2.95
8275	26.95
7220	19.95
CRT5027	12.95
CRT5037	9.95
TMS9918A	19.95

6500

6502	2.69
65C02(CMOS)	12.95
6507	9.95
6520	1.95
6522	4.95
6526	26.95
6532	6.95
6545	6.95
6551	19.95
6581	34.95

CRYSTALS

32.768 KHz	.95
1.0 MHz	2.95
1.8432	2.95
2.0	1.95
2.097152	1.95
2.4576	1.95
3.2768	1.95
3.579545	1.95
4.0	1.95
4.032	1.95
5.0	1.95
5.0688	1.95
6.0	1.95
6.144	1.95
6.5536	1.95
8.0	1.95
10.0	1.95
10.738635	1.95
12.0	1.95
14.31818	1.95
15.0	1.95
16.0	1.95
17.430	1.95
18.0	1.95
18.432	1.95
20.0	1.95
22.1184	1.95
24.0	1.95
32.0	1.95

2.0 MHZ

6502A	2.95
6520A	2.95
6522A	5.95
6532A	11.95
6545A	7.95
6551A	6.95

3.0 MHZ

6502B	6.95
-------	------

8800

6800	1.95
6802	4.95
6803	9.95
6809	5.95
6809E	5.95
6810	1.95
6820	2.95
6821	1.95
6840	6.95
6843	19.95
6844	12.95
6845	4.95
6847	11.95
6850	1.95
6883	22.95

CRYSTAL OSCILLATORS

1.0MHZ	5.95
1.8432	5.95
2.0	5.95
2.4576	5.95
2.0	4.95
4.0	4.95
5.0688	4.95
6.0	4.95
6.144	4.95
8.0	4.95
10.0	4.95
12.0	4.95
12.480	4.95
15.0	4.95
16.0	4.95
18.432	4.95
20.0	4.95
24.0	4.95

MISC.

TMS99531	9.95
TMS99532	19.95
ULN2003	7.95
3242	7.95
3341	4.95
MC3470	1.95
MC3480	2.95
MC3487	2.95
11C50	19.95
2513-001 LP	8.95
AY5-2376	11.95
AY5-3600 PRO	11.95

8200

8203	24.99
8205	3.49
8212	1.49
8216	1.49
8224	2.25
8237	4.98
8237-5	5.49
8260	8.95
8261	1.89
8251A	1.89
8253	1.89
8253-5	1.89
8255	1.89
8255-5	1.89
8259	1.96
8259-5	2.29
8272	4.95
8279	2.49
8279-5	2.95
8282	2.95
8284	2.86
8286	3.96
8288	4.96

DISK CONTROLLERS

1771	4.95
1791	9.95
1793	9.95
1795	12.95
1797	12.95
2793	19.95
2793	19.95
2797	29.95
6843	19.95
8272	4.95
UPD765	4.95
MB8876	12.95
MB8877	12.95
1691	6.95
2143	6.95

BIT RATE GENERATORS

MC14411	9.95
BR1941	4.95
4702	9.95
COM8116	8.95
MMS307	4.95

Z-80

Z80-CPU 25 MHZ 1.89	
4.0 MHZ	
Z80A-CPU	1.79
Z80A-CTC	1.89
Z80A-DART	5.95
Z80A-DMA	5.95
Z80A-PIO	1.89
Z80A-SIO/0	5.95
Z80A-SIO/1	5.95
Z80A-SIO/2	5.95

UARTS

AY5-1013	3.99
AY3-1015	4.95
TR1802	3.95
2651	4.95
IM6402	6.95
IM6403	9.95
IN58250	6.95

SOUND CHIPS

76477	5.95
76489	8.95
891-263	39.95
AY3-8910	12.95
AY3-8912	12.95
SP1000	39.00

CLOCK CIRCUITS

MMS369	1.95
MMS369-EST	1.95
MMS5167	12.95
MMS5174	11.95
MMS5832	2.95

Visit our retail store located at 1256 S. Bascom Ave. in San Jose, (408) 947-8881

JDR Microdevices

110 Knowles Drive, Los Gatos, CA 95030
Toll Free 800-538-5000 • (408) 866-6200
FAX (408) 378-8927 • Telex 171-110

PLEASE USE YOUR CUSTOMER NUMBER WHEN ORDERING

TERMS: Minimum order \$10.00. For shipping and handling include \$2.50 for UPS Ground and \$1.50 for UPS Air. Orders over 1 lb and foreign orders may require additional shipping charges - please contact our sales department for the amount. CA residents must include applicable sales tax. All merchandise is warranted for 90 days unless otherwise stated. Prices are subject to change without notice. We are not responsible for typographical errors. We reserve the right to limit quantities, and to substitute manufacturer. All merchandise subject to prior sale.

COPYRIGHT 1987 JDR MICRODEVICES

Inquiry 162

THE JDR MICRODEVICES LOGO IS A REGISTERED TRADEMARK OF JDR MICRODEVICES. JDR INSTRUMENTS AND JDR MICRODEVICES ARE TRADEMARKS OF JDR MICRODEVICES L. IBM IS A TRADEMARK OF INTERNATIONAL BUSINESS MACHINES. APPLE IS A TRADEMARK OF APPLE COMPUTER.

EGA CARD AND MONITOR NOW ONLY \$569!

CMOS			
4001	.19	14419	4.95
4011	.19	14433	14.95
4012	.25	4503	.69
4013	.35	4511	.69
4015	.29	4516	.79
4016	.29	4518	.85
4017	.49	4522	.79
4018	.69	4526	.79
4020	.59	4527	1.95
4021	.69	4528	.79
4024	.49	4529	2.95
4025	.25	4532	1.95
4027	.39	4538	.95
4028	.65	4541	1.29
4035	.69	4553	5.79
4040	.69	4585	.75
4041	.75	4702	12.95
4042	.59	74C00	.29
4043	.85	74C14	.59
4044	.69	74C74	.59
4045	1.98	74C83	1.95
4046	.69	74C85	1.49
4047	.69	74C95	.99
4049	.29	74C150	5.75
4050	.29	74C151	2.25
4051	.69	74C161	.99
4052	.69	74C163	.99
4053	.69	74C164	1.39
4056	2.19	74C192	1.49
4060	.69	74C193	1.49
4066	.29	74C221	2.49
4069	.19	74C240	1.89
4076	.59	74C244	1.89
4077	.29	74C374	1.99
4081	.22	74C905	10.95
4085	.79	74C911	8.95
4086	.89	74C917	12.95
4093	.49	74C922	4.49
4094	2.49	74C923	4.95
14411	9.95	74C926	7.95
14412	6.95	80C97	.95

7400/8000			
7400	.19	74147	2.49
7402	.19	74148	1.20
7404	.19	74150	1.35
7406	.29	74151	.55
7407	.29	74153	.55
7408	.24	74154	1.49
7410	.19	74155	.75
7411	.25	74157	.55
7414	.49	74159	1.65
7416	.25	74161	.69
7417	.25	74163	.69
7420	.19	74164	.85
7423	.29	74165	.85
7430	.19	74166	1.00
7432	.29	74175	.89
7438	.29	74177	.75
7442	.49	74178	1.15
7445	.69	74181	2.25
7447	.89	74182	.75
7470	.35	74184	2.00
7473	.34	74191	1.15
7474	.33	74192	.79
7475	.45	74194	.85
7476	.35	74196	.79
7483	.50	74197	.75
7485	.59	74199	1.35
7486	.35	74221	1.35
7489	2.15	74246	1.35
7490	.39	74247	1.25
7492	.50	74248	1.85
7493	.35	74249	1.95
7495	.55	74251	.75
7497	.275	74265	1.35
74100	2.29	74273	1.95
74121	.29	74278	1.35
74123	.49	74367	.65
74125	.45	74368	.65
74141	.65	9368	3.95
74143	5.95	9602	1.50
74144	2.95	9637	2.95
74145	.60	96502	1.95

74500			
74500	.29	745163	1.29
74502	.29	745168	3.95
74503	.29	745174	.79
74504	.29	745175	.79
74505	.29	745183	1.95
74508	.35	745189	1.95
74510	.29	745195	1.49
74515	.49	745196	2.49
74530	.29	745197	2.95
74532	.35	745226	3.99
74537	.69	745240	1.49
74538	.69	745241	1.49
74574	.49	745244	1.49
74585	.95	745257	.79
74586	.35	745253	.79
745112	.50	745258	.95
745124	2.75	745280	1.95
745138	.79	745287	1.69
745140	.55	745288	1.69
745151	.79	745299	2.95
745153	.79	745373	1.89
745157	.79	745374	1.69
745158	.95	745471	4.95
745161	1.29	745571	2.95

VOLTAGE REGULATORS			
TO-220 CASE			
7805T	.49	7905T	.59
7808T	.49	7908T	.59
7812T	.49	7912T	.59
7815T	.49	7915T	.59
TO-3 CASE			
7805K	1.59	7905K	1.69
7812K	1.39	7912K	1.49
TO-93 CASE			
78L05	.49	79L05	.69
78L12	.49	79L12	1.49
OTHER VOLTAGE REGS			
LM323K	5V 3A	TO-3	4.79
LM338K	Adj. 5A	TO-3	6.95
78H12K	12V 5A	TO-3	8.95

LINEAR			
TL066	.99	LM733	.98
TL071	.69	LM741	.29
TL072	1.09	LM747	.69
TL074	1.95	LM748	.59
TL081	.59	MC1330	1.69
TL082	.99	MC1350	1.19
TL084	1.49	MC1372	6.95
LM301	.34	LM1414	1.59
LM309K	1.25	LM1458	.49
LM311	.59	LM1488	.49
LM311H	.89	LM1489	.49
LM317K	3.49	LM1496	.85
LM317T	.95	LM1812	8.25
LM318	1.49	LM1889	1.95
LM319	1.25	ULN2003	.79
LM320	***7800	XR2206	3.95
LM322	1.95	XR2211	2.95
LM323K	4.79	XR2240	1.95
LM324	.49	MPQ2907	1.95
LM331	3.95	LM2917	1.95
LM334	1.19	CA3046	.89
LM335	1.79	CA3081	.99
LM336	1.75	CA3082	.99
LM337K	3.55	CA3086	.89
LM338K	6.95	CA3089	1.95
LM339	.59	CA310E	.99
LM340	***7800	CA3146	1.29
LM350T	4.60	CA3160	1.19
LF353	.59	MC3470	1.95
LF356	.99	MC3480	8.95
LF357	.99	MC3487	2.95
LM358	.59	LM3900	.49
LM360	.89	LM3909	.98
LM363	1.95	LM3911	2.25
LM386	.89	LM3914	2.39
LM393	.45	MC4024	3.49
LM394H	5.95	MC4044	3.99
TL494	4.20	RC4136	1.25
TL497	3.25	RC4558	.69
NE555	.29	LM13600	1.49
NE556	.49	75107	1.49
NE558	1.29	75110	1.95
NE564	1.95	75150	1.95
LM565	.95	75154	1.95
LM566	1.49	75188	1.25
LM567	.79	75189	1.25
NE570	2.95	75451	.39
NE590	2.50	75452	.39
NE592	.98	75453	.39
LM710	.75	75477	1.29
LM723	.49	75492	.79
H-T0-5 CAN, K-T0-3, T-T0-220			

DATA ACQ INTERFACE			
ADC0800	15.55	8T26	1.29
ADC0804	3.49	8T28	1.29
ADC0809	4.49	8T95	.89
ADC0816	14.95	8T95	.89
ADC0817	9.95	8T97	.59
ADC0831	8.95	8T98	.89
DAC0800	4.49	DM8131	2.95
DAC0806	1.95	DP8304	2.29
DAC0808	2.95	DS8833	2.25
DAC1020	8.25	DS8835	1.95
DAC1022	5.95	DS8836	.99
MC1408L	2.95	DS8837	1.65

IC SOCKETS			
8 PIN ST	1-99	100+	
14 PIN ST	.11	.10	
16 PIN ST	.11	.09	
16 PIN ST	.12	.10	
18 PIN ST	.15	.13	
20 PIN ST	.18	.15	
22 PIN ST	.15	.12	
24 PIN ST	.20	.15	
28 PIN ST	.22	.15	
40 PIN ST	.30	.22	
64 PIN ST	1.95	1.49	
ST-SOLDER TAIL			
8 PIN WW	.59	.69	
14 PIN WW	.69	.52	
16 PIN WW	.69	.58	
18 PIN WW	.99	.90	
20 PIN WW	1.09	.98	
22 PIN WW	1.39	1.28	
24 PIN WW	1.49	1.35	
28 PIN WW	1.69	1.49	
40 PIN WW	1.99	1.80	
WW-WIREWRAP			
16 PIN ZIF	4.95	CALL	
24 PIN ZIF	5.95	CALL	
28 PIN ZIF	6.95	CALL	
40 PIN ZIF	8.95	CALL	
ZIF-TEXT TOOL			
(ZERO INSERTION FORCE)			

EDGE CARD CONNECTORS			
100 PIN ST	S-100	.125	3.95
100 PIN WW	S-100	.125	4.95
62 PIN ST	IBM PC	.100	1.95
50 PIN ST	APPLE	.100	2.95
44 PIN ST	STD	.156	1.95
44 PIN WW	STD	.156	4.95

36 PIN CENTRONICS			
MALE			
IDCEN36	RIBBON CABLE		6.95
CEN36	SOLDER CUP		4.95
FEMALE			
IDCEN36/F	RIBBON CABLE		7.95
CEN36/C	RT ANGLE PC MOUNT		4.95

INTERSIL			
ICL7106		9.95	
ICL7107		12.95	
ICL7600		2.95	
ICL8038		4.95	
ICM7207A		5.95	
ICM7208		18.95	

DIP CONNECTORS											
DESCRIPTION	ORDER BY	CONTACTS									
		8	14	16	18	20	22	24	28	40	
HIGH RELIABILITY TOOLED ST IC SOCKETS	AUGATxxST	.62	.79	.89	1.09	1.29	1.39	1.49	1.69	2.49	
HIGH RELIABILITY TOOLED WW IC SOCKETS	AUGATxxWW	1.30	1.80	2.10	2.40	2.50	2.90	3.15	3.70	5.40	
COMPONENT CARRIES (DIP HEADERS)	ICCxx	.49	.59	.69	.99	.99	.99	.99	1.09	1.49	
RIBBON CABLE DIP PLUGS (IDC)	IOPxx	---	.95	.95	---	---	---	---	1.75	---	2.95

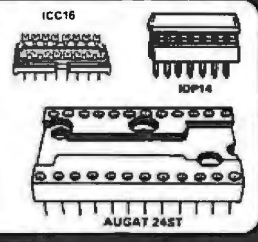

FOR ORDERING INSTRUCTIONS SEE D-SUBMINIATURE BELOW

DIODES/OPTO/TRANSISTORS			
1N751	.25	4N26	.89
1N759	.25	4N27	.89
1N4148	25/1.00	4N28	.89
1N4004	10/1.00	4N33	.89
1N6402	.25	4N37	1.18
KBPG2	.55	MCT-2	.59
KB58A	.95	MCT-6	1.29
MDA990-2	.35	TIL-111	2.25
N2222	.25	2N3906	.10
PN2222	.10	2N4401	.25
2N2905	.25	2N4402	.25
2N2907	.25	2N4403	.25
2N3055	.79	2N6045	1.75
2N3904	.10	TIP31	.49

D-SUBMINIATURE										
DESCRIPTION	ORDER BY	CONTACTS								
		9	15	19	25	37	50			
SOLDER CUP	MALE	DBxxP	.82	.90	1.25	1.25	1.80	3.48		
	FEMALE	DBxxS	.95	1.15	1.50	1.50	2.35	4.32		
RIGHT ANGLE PC SOLDER	MALE	DBxxPR	1.20	1.49	---	---	1.95	2.65	---	---
	FEMALE	DBxxSR	1.25	1.55	---	---	2.00	2.79	---	---
WIRE WRAP	MALE	DBxxPWW	1.69	2.56	---	---	3.89	5.60	---	---
	FEMALE	DBxxSww	2.76	4.27	---	---	6.84	9.95	---	---
IDC RIBBON CABLE	MALE	IDBxxP	2.70	2.95	---	---	3.98	5.70	---	---
	FEMALE	IDBxxS	2.92	3.20	---	---	4.33	6.76	---	---
HOODS	METAL	MHOODxx	1.25	1.25	1.30	1.30	---	---	---	---
	GREY	HOODxx	.65	.65	---	---	.65	.75	.95	---

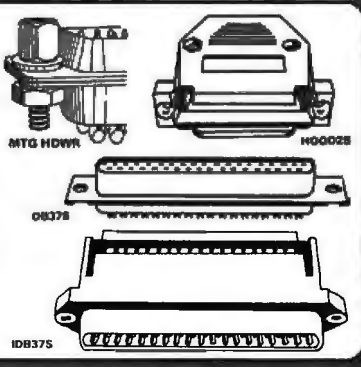

ORDERING INSTRUCTIONS: INSERT THE NUMBER OF CONTACTS IN THE POSITION MARKED "x" OF THE "ORDER BY" PART NUMBER LISTED. EXAMPLE: A 15 PIN RIGHT ANGLE MALE PC SOLDER WOULD BE DB15PR.

1200B MODEM \$99.95

FOR IBM W/
SOFTWARE

2400B MODEM \$199.95

BARGAIN HUNTERS CORNER

KEY TRONIC™ \$49.95

- 5150 STYLE OEM KEYBOARD**
 * IMPROVED KEYBOARD LAYOUT
 * 83 KEYS, FULLY IBM COMPATIBLE
 * LED INDICATORS FOR CAPS & NUMBER LOCK

NEW! TOSHIBA 3 1/2" FDD KIT

- 360K, DOUBLE SIDED/DOUBLE DENSITY**
 * MOUNTING HARDWARE FOR 5 1/4" SLOT
 * FACEPLATES FOR BOTH AT & XT MACHINES

\$149.95

SPECIALS ENDS 6/30/87

PAGE WIRE WRAP WIRE PRECUT ASSORTMENT IN ASSORTED COLORS \$27.50

- 100ea: 5.5", 6.0", 6.5", 7.0"
 250ea: 2.5", 4.5", 5.0"
 500ea: 3.0", 3.5", 4.0"

SPOOLS

- 100 feet \$4.30 250 feet \$7.25
 500 feet \$13.25 1000 feet \$21.95

Please specify color:
 Blue, Black, Yellow or Red

EXTENDER CARDS

- IBM-PC \$29.95
 IBM-AT \$39.95

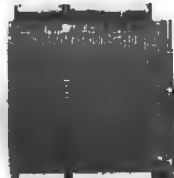

WIRE WRAP PROTOTYPE CARDS FR-4 EPOXY GLASS LAMINATE WITH GOLD-PLATED EDGE-CARD FINGERS



IBM-PR2

IBM

BOTH CARDS HAVE SILK SCREENED LEGENDS AND INCLUDES MOUNTING BRACKET

- IBM-PR1 WITH +5V AND GROUND PLANE . . . \$27.95
 IBM-PR2 AS ABOVE WITH DECODING LAYOUT \$29.95

S-100

- P100-1 BARE - NO FOIL PADS . . . \$15.15
 P100-2 HORIZONTAL BUS . . . \$21.80
 P100-3 VERTICAL BUS . . . \$21.80
 P100-4 SINGLE FOIL PADS PER HOLE . . . \$22.75

APPLE

- P500-1 BARE - NO FOIL PADS . . . \$15.15
 P500-3 HORIZONTAL BUS . . . \$22.75
 P500-4 SINGLE FOIL PADS PER HOLE . . . \$21.80
 7060-45 FOR APPLE IIe AUX SLOT . . . \$30.00

SOCKET-WRAP I.D.™

- SLIPS OVER WIRE WRAP PINS
 • IDENTIFIES PIN NUMBERS ON WRAP SIDE OF BOARD

CAN WRITE ON PLASTIC, SUCH AS IC #

PINS	PART#	PCK. OF	PRICE
8	IDWRAP 08	10	1.95
14	IDWRAP 14	10	1.95
16	IDWRAP 16	10	1.95
18	IDWRAP 18	5	1.95
20	IDWRAP 20	5	1.95
22	IDWRAP 22	5	1.95
24	IDWRAP 24	5	1.95
28	IDWRAP 28	5	1.95
40	IDWRAP 40	5	1.95

PLEASE ORDER BY NUMBER OF PACKAGES (PCK. OF)

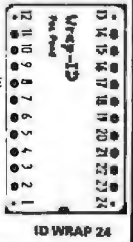

FRAME STYLE TRANSFORMERS

12.6V AC CT	2 AMP	5.95
12.6V AC CT	4 AMP	7.95
12.6V AC CT	8 AMP	10.95
25.2V AC CT	2 AMP	7.95

25 PIN D-SUB BENDER CHANGERS \$7.95



SWITCHING POWER SUPPLIES

PS-IBM \$89.95

- FOR IBM PC-XT COMPATIBLE
 • 135 WATTS
 • +5V @ 15A, +12V @ 4.2A
 • -5V @ .5A, -12V @ .5A
 • ONE YEAR WARRANTY



PS-IBM-150 \$79.95

- FOR IBM PC-XT COMPATIBLE
 • 150 WATTS
 • +12V @ 5.2A, +5V @ 16A
 • -12V @ .5A, -5V @ .5A
 • ONE YEAR WARRANTY



PS-130 \$99.95

- 130 WATTS
 • SWITCH ON REAR
 • FOR USE IN OTHER IBM TYPE MACHINES
 • 90 DAY WARRANTY



PS-A \$49.95

- USE TO POWER APPLE TYPE SYSTEMS, 79.5 WATTS
 • +5V @ 7A, +12V @ 3A
 • -5V @ .5A, -12V @ .5A
 • APPLE POWER CONNECTOR



PS-1558 \$34.95

- 75 WATTS, UL APPROVED
 • +5V @ 7A, +12V @ 3A
 • -12V @ 250ma, -5V @ 300ma



BOOKS BY STEVE CIARCIA

- BUILD YOUR OWN 280 COMPUTER \$19.95
 CIRCUIT CELLAR VOL 1 \$17.95
 CIRCUIT CELLAR VOL 2 \$18.95
 CIRCUIT CELLAR VOL 3 \$18.95
 CIRCUIT CELLAR VOL 4 \$18.95
 CIRCUIT CELLAR VOL 5 \$19.95

MUFFIN FANS

- 3.15" SQ. 14.95 3.63" SQ. 14.95
 3.18" SQUARE 16.95
6' LINE CORDS
 2 conductor .39 3 conductor .99
 3 conductor w/female socket 1.49

EMI FILTER \$4.95

WISH SOLDERLESS BREADBOARDS

PART NUMBER	DIMENSIONS	DISTRIBUTION STRIP(S)	TIE POINTS	TERMINAL STRIP(S)	TIE POINTS	BINDING POSTS	PRICE
WBU-D	.38 x 6.50"	1	100	---	---	---	2.95
WBU-T	1.38 x 6.50"	---	---	1	630	---	6.95
WBU-204-3	3.94 x 8.45"	1	100	2	1260	2	17.95
WBU-204	5.13 x 8.45"	4	400	2	1260	3	24.95
WBU-206	6.89 x 9.06"	5	500	3	1690	4	29.95
WBU-208	8.25 x 9.45"	7	700	4	2520	4	39.95



LITHIUM BATTERY AS USED IN CLOCK CIRCUITS

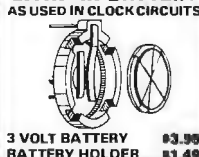

3 VOLT BATTERY \$3.95
 BATTERY HOLDER \$1.49

2 VOLUME SET IC MASTER THE INDUSTRY STANDARD \$129.95

Visit our retail store located at 1256 S. Bascom Ave. in San Jose, (408) 947-8881

JDR Microdevices
 110 Knowles Drive, Los Gatos, CA 95030
 Toll Free 800-538-5000 • (408) 866-6200
 FAX (408) 378-8927 • Telex 171-110

PLEASE USE YOUR CUSTOMER NUMBER WHEN ORDERING
 TERMS: Minimum order \$10.00. For shipping and handling include \$2.50 for UPS Ground and \$3.50 for UPS Air. Orders over 1 lb. and foreign orders may require additional shipping charges - please contact our sales department for the amount. CA residents must include applicable sales tax. All merchandise is warranted for 90 days unless otherwise stated. Prices are subject to change without notice. We are not responsible for typographical errors. We reserve the right to limit quantities and to substitute manufacturer. All merchandise subject to prior sale.

COPYRIGHT 1987 JDR MICRODEVICES

Inquiry 163

THE JDR MICRODEVICES LOGO IS A REGISTERED TRADEMARK OF JDR MICRODEVICES. JDR INSTRUMENTS AND JDR MICRODEVICES ARE TRADEMARKS OF JDR MICRODEVICES. IBM IS A TRADEMARK OF INTERNATIONAL BUSINESS MACHINES. APPLE IS A TRADEMARK OF APPLE COMPUTER.

EGA CARD AND MONITOR NOW ONLY \$569!

DISK DRIVES FOR APPLE COMPUTERS

AP-150
\$89.95



- 1/2 HT. DIRECT DRIVE
- 100% APPLE COMPATIBLE
- SIX MONTH WARRANTY

AP-135
\$129.95



- FULL HT SHUGART MECHANISM
- DIRECT REPLACEMENT FOR APPLE DISK II
- SIX MONTH WARRANTY

DOUBLE SIDED!

MAC535
\$249.95

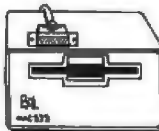

- 3.5" ADD-ON DISK DRIVE
- 100% MACINTOSH COMPATIBLE
- DOUBLE SIDED 800K BYTE STORAGE
- HIGH RELIABILITY DRIVE
- HAS AUTO-EJECT MECHANISM
- FULL ONE YEAR WARRANTY

AD-3C
\$139.95

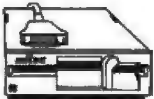

- 100% APPLE IIc COMPATIBLE
- READY TO PLUG IN, W/ SHIELDED CABLE & MOLDED 15 PIN CONNECTOR
- FAST, RELIABLE SLIMLINE DIRECT DRIVE
- SIX MONTH WARRANTY

DISK DRIVE ACCESSORIES

- FDD CONTROLLER CARD **\$49.95**
- IIc ADAPTOR CABLE **\$19.95**
- ADAPTS STANDARD APPLE DRIVES FOR USE WITH APPLE IIc

KB-1000 **\$79.95**

CASE WITH KEYBOARD FOR APPLE TYPE MOTHERBOARD

- USER DEFINED FUNCTION KEYS
- NUMERIC KEYPAD W/ CURSOR CONTROL
- CAPS LOCK
- AUTO-REPEAT



KEYBOARD-AP **\$49.95**

- REPLACEMENT FOR APPLE II KEYBOARD
- CAPS LOCK KEY, AUTO-REPEAT
- ONE KEY ENTRY OF BASIC OR CP/M COMMANDS

JOYSTICK CB-10 **\$19.95**

- SET X-Y AXIS FOR AUTO CENTER OR FREE MOVEMENT
- FIRE BUTTON FOR USE WITH GAME SOFTWARE
- ATTRACTIVE, SOLID, PLASTIC CASE
- INCLUDES ADAPTOR CABLE FOR IBM, APPLE II, IIc, IIx, ATARI & VIC 20/64



POWER STRIP **\$12.95**

- UL APPROVED
- 15A CIRCUIT BREAKER

GRT MONITORS FOR ALL APPLICATIONS



CASPER EGA MONITOR

- EGA & CGA COMPATIBLE
- SCANNING FREQUENCIES: 15.75 / 21.85 KHz
- RES: 640 x 200 / 350
- .31mm DOT PITCH, 25 MHz
- 16 COLORS OUT OF 64
- 14", BLACK MATRIX SCREEN

\$399.95



CASPER RGB MONITOR

- COLOR/GREEN/AMBER SWITCH ON REAR
- DIGITAL RGB-IBM COMPATIBLE
- 14" NON-GLARE SCREEN
- RESOLUTION: 640H x 240V
- .39mm DOT PITCH
- CABLE FOR IBM PC INCLUDED

\$299.95



SAMSUNG MONOCHROME

- IBM COMPATIBLE TTL INPUT
- 12" NON-GLARE AMBER, LOW DISTORTION SCREEN
- RESOLUTION: 720H x 350V
- ATTRACTIVE CASE WITH SWIVEL BASE
- ONE YEAR WARRANTY

\$119.95



FORTRONICS MONOCHROME

- IBM COMPATIBLE TTL INPUT
- 12" NON-GLARE SCREEN
- VERY HIGH RESOLUTION: 1100 LINES (CENTER)
- 25 MHz BANDWIDTH
- CABLE FOR IBM PC INCLUDED
- AMBER OR GREEN AVAILABLE

\$99.95

TILT & SWIVEL MONITOR STAND **\$12.95**

WITH POWER CENTER **\$39.95**

APPLE COMPATIBLE INTERFACE CARDS



EPROM PROGRAMMER

- DUPLICATE OR BURN ANY 27xx SERIES EPROM (2716 TO 27128)
- MENU-DRIVEN SOFTWARE
- HIGH SPEED WRITE ALGORITHM

RP-525 **\$59.95**



16K RAMCARD

- FULL 2 YEAR WARRANTY
- EXPAND YOUR 48K MACHINE TO A FULL 64K OF MEMORY
- CAN BE USED IN PLACE OF THE APPLE LANGUAGE CARD

RAM-CARD **\$39.95**



IC TEST CARD

- QUICKLY TESTS MANY COMMON ICs
- DISPLAYS PASS OR FAIL
- TEST 4000 & 74HC SERIES CMOS, 7400, 74LS, 74L, 74H & 74S

IC-TESTER **\$129.95**

MOLDED INTERFACE CABLES

6 FOOT, 100% SHIELDED, MEETS FCC



- IBM PARALLEL PRINTER CABLE **9.95**
- CENTRONICS (MALE TO FEMALE) **15.95**
- CENTRONICS (MALE TO MALE) **14.95**
- MODEM CABLE (FOR IBM) **7.95**
- RS232 SERIAL (MALE TO FEMALE) **9.95**
- RS232 SERIAL (MALE TO MALE) **9.95**
- KEYBOARD EXTENDER (COILED) **7.95**
- APPLE II JOYSTICK EXTENDER **4.95**

SWITCH BOXES

ALL LINES SWITCHED, GOLD PLATED CONNECTORS, QUALITY SWITCHES

2 WAY **\$39.95**

- CONNECTS 2 PRINTERS TO 1 COMPUTER OR VICE VERSA

AB-P (CENTRONICS PARALLEL)
AB-S (RS232 SERIAL)

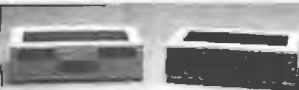

3 WAY **\$99.95**

- CONNECTS 3 PRINTERS TO 1 COMPUTER OR VICE VERSA

SWITCH-3P (CENTRONICS PARALLEL)
SWITCH-3S (RS232 SERIAL)



300B MODEM **\$49.95**

FOR APPLE OR IBM

- INCLUDES ASCII PRO-EZ SOFTWARE
- FCC APPROVED
- BELL SYSTEMS 103 COMPATIBLE
- INCLUDES AC ADAPTOR
- AUTO-DIAL
- DIRECT CONNECT CABLE FOR APPLE IIc **\$14.95**

G. ITOH RITEMAN II PRINTER



- 160 CPS DRAFT, 32 CPS NLQ
- 9 x 3 DOT MATRIX
- SUPPORTS EPSON/IBM GRAPHICS
- FRICTION AND PIN FEEDS
- VARIABLE LINE SPACING AND PITCH

\$219.95

- IBM PRINTER CABLE **\$9.95**
- REPLACEMENT RIBBON CARTRIDGE **\$7.95**

NASHUA DISKETTES

NASHUA DISKETTES WERE JUDGED TO HAVE THE HIGHEST POLISH AND RECORDED AMPLITUDE OF ANY DISKETTES TESTED (COMPARING FLOPPY DISKS, BYTE 9/84)

- N-MD2D** DS/DD 5 1/4" SOFT **\$9.90**
- N-MD2F** DS/QUAD 5 1/4" SOFT **\$19.95**
- N-MD2H** DS/HD 5 1/4" FOR AT **\$24.95**
- N-FD1** SS/DD 8" SOFT **\$27.95**
- N-FD2D** DS/DO 8" SOFT **\$34.95**

BULK DISKETTE SALE

5 1/4" SOFT SECTOR, DS/DD W/TYVEC SLEEVES & HUB RINGS

\$9.90 **69c ea** **59c ea**

BOX OF 10 BULK QTY 50 BULK QTY 250

DISKETTE FILES

- 5 1/4" DISKFILE HOLDS 70 **\$8.95**
- 3 1/2" DISKFILE HOLDS 40 **\$8.95**



Seagate

5 1/4" HARD DISK DRIVES

- ST-225 HALF HT 20MB 65ms **\$275**
- ST-238 HALF HT 30MB 65ms (RL) **\$299**
- ST-251 HALF HT 40MB 40ms **\$599**
- ST-277 HALF HT 60MB 40ms (RL) **CALL**
- ST-4038 FULL HT 30MB 40ms **\$559**
- ST-4096 FULL HT 80MB 28ms **\$1195**

1/2 HEIGHT FLOPPY DISK DRIVES

- 5 1/4" TEAC FD-55B DS/DD **\$109.95**
- 5 1/4" TEAC FD-55F OS/QUAD **\$124.95**
- 5 1/4" TEAC FD-55GFV DS/HD **\$154.95**
- 5 1/4" MITSUBISHI DS/HD **\$129.95**
- 3 1/2" TOSHIBA KIT DS/DD **\$149.95**

KIT INCLUDES MOUNTING HARDWARE TO FIT 5 1/4" & FACEPLATES FOR AT & XT

DISK DRIVE ACCESSORIES

- TEAC SPECIFICATION MANUAL **\$5.00**
- TEAC MAINTENANCE MANUAL **\$25.00**
- 1/2 HT MNTG HARDWARE FOR IBM **\$2.95**
- MOUNTING RAILS FOR IBM AT **\$4.95**
- 1/2" POWER CABLE FOR 5 1/4" FDDs **\$2.95**
- 5 1/4" FDD POWER CONNECTORS **\$1.19**

DISK DRIVE ENCLOSURES WITH POWER SUPPLIES

- CAB-28V5** DUAL SLIMLINE 5 1/4" **\$49.95**
- CAB-1FH5** FULL HT 5 1/4" **\$69.95**
- CAB-23V8** DUAL SLIMLINE 8" **\$209.95**
- CAB-2FH8** DUAL FULL HT 8" **\$219.95**

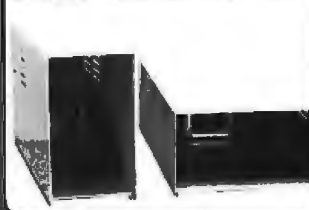

BUILD STEVE CIARCIA'S INTELLIGENT EPROM PROGRAMMER

AS SEEN IN BYTE, OCT. 86

- STAND-ALONE OR RS-232 SERIAL OPERATION
- MENU SELECTABLE EPROM TYPES—NO CONFIGURATION JUMPERS
- PROGRAMS ALL 5V 27XXX EPROMS FROM 2716 TO 27512
- READ, COPY OR VERIFY EPROM
- UPLOAD/DOWNLOAD INTEL HEX FILES
- PROGRAMMER DRIVER USER MODIFIABLE

ONLY \$199

KIT INCLUDES PCB AND ALL COMPONENTS EXCEPT CASE & POWER SUPPLY

EGA CARD AND MONITOR NOW ONLY \$569!

QUALITY IBM COMPATIBLE MOTHERBOARDS

FROM MODULAR CIRCUIT TECHNOLOGY

TURBO 4.77 / 0 MHZ \$129.95

JDR PART #: MCT-TURBO

- 4.77 OR 8 MHZ OPERATION WITH 8088-2 & OPTIONAL 8087-2 CO-PROCESSOR
- DYNAMICALLY ADJUSTS SPEED DURING DISKETTE OPERATION FOR MAXIMUM THROUGHPUT AND RELIABILITY
- CHOICE OF NORMAL / TURBO MODE OR SOFTWARE SELECT PROCESSOR SPEED

STANDARD 4.77 MHZ \$109.95

JDR PART #: MCT-XTMB

- 8088 CPU, OPTIONAL 8087 CO-PROCESSOR
- 8 EXPANSION SLOTS
- EXPANDABLE TO 640K ON-BOARD MEMORY (0K RAM INSTALLED)
- ALLIGs SOCKETED-HIGHEST QUALITY PCB
- ACCEPTS 2764 OR 27128 ROMS

BOTH WITH FREE MCT BIOS!

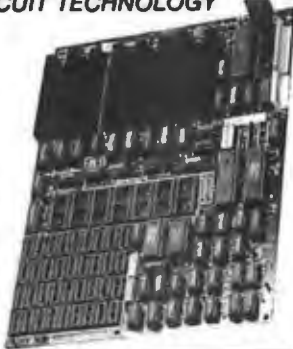

EASYDATA MODEMS

All models feature auto-dial/answer/redial on busy, Hayes compatible, power up self test, touchtone or pulse dialing, built-in speaker, PC Talk III Communications software, Bell Systems 103 & 212A full or half duplex and more.

INTERNAL

EASYDATA-12H \$99.95
1200 BUAD HALF CARD

EASYDATA-12B \$119.95
1200 BUAD 10" CARD

EASYDATA-24B \$199.95
2400 BUAD FULL CARD

EXTERNAL

NO SOFTWARE INCLUDED

EASYDATA-12D \$119.95
1200 BUAD

EASYDATA-24D \$219.95
2400 BUAD

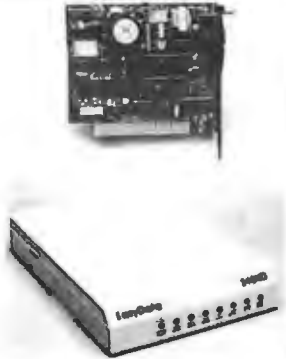

FARADAY FDD CONTROLLER

JDR PART #: FAR-FDD

- SUPPORTS UP TO 4 INTERNALLY MOUNTED FDDs
- IBM COMPATIBLE, INTERFACES TO 360K OR 720K USING DOS 3.20
- INCLUDES CABLE FOR 2 DISK DRIVES

\$24.95

IBM COMPATIBLE FLOPPY DISK DRIVE

JDR PART #: FDD-360

- GOOD QUALITY DRIVES BY MAJOR MANUFACTURERS SUCH AS QUME, TANDON & CDC
- 5 1/4" HALF HEIGHT
- 360K STORAGE CAPACITY
- DS/DD
- 48 TPI

\$69.95

IBM STYLE COMPUTER CASE

AN ATTRACTIVE STEEL CASE WITH A HINGED LID. FITS THE POPULAR PC/XT COMPATIBLE MOTHERBOARDS

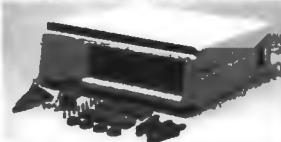

- SWITCH CUT-OUT ON SIDE FOR PC/XT STYLE POWER SUPPLY
- CUT-OUT FOR 8 EXPANSION SLOTS
- ALL HARDWARE INCLUDED

\$34.95

SLIDE TYPE CASE \$39.95

BUILD YOUR OWN 256K XT COMPATIBLE SYSTEM

- | | |
|-------------------------|----------|
| XT MOTHERBOARD | \$109.95 |
| PRO-BIOS (A \$20 VALUE) | FREE! |
| 256K RAM | \$26.95 |
| 130 WATT POWER SUPPLY | \$89.95 |
| FLIP-TOP CASE | \$34.95 |
| KEY TRONIC™ KEYBOARD | \$49.95 |
| 360K DRIVE | \$69.95 |
| FARADAY CONTROLLER | \$24.95 |
| MONOCHROME ADAPTOR | \$49.95 |
| FORTRONICS MONITOR | \$99.95 |

TOTAL: \$536.15

DISPLAY CARDS

FROM MODULAR CIRCUIT TECHNOLOGY

MCT-EGA

\$179.95

100% IBM COMPATIBLE, PASSES IBM EGA DIAGNOSTICS

- COMPATIBLE WITH IBM MEGA, COLOR GRAPHICS AND MONOCHROME ADAPTORS
- TRIPLE SCANNING FREQUENCY FOR DISPLAY ON EGA, STANDARD RGB OR HIGH RESOLUTION MONOCHROME MONITOR
- FULL 256K OF VIDEO RAM ALLOWS 640 x 350 PIXELS IN 16 OF 64 COLORS
- LIGHT PEN INTERFACE



MCT-CG

\$49.95

COMPATIBLE WITH IBM COLOR GRAPHICS STANDARD

- SHORT SLOT CARD USES VLSI CHIPS TO INSURE RELIABILITY
- SUPPORTS RGB, COMPOSITE MONOCHROME & COLOR AND AN RF MODULATOR OUTPUT
- 320 x 200 COLOR GRAPHICS MODE
- 640 x 200 MONOCHROME GRAPHICS MODE
- LIGHT PEN INTERFACE



MCT-MGP

\$59.95

COMPATIBLE WITH IBM MONOCHROME AND HERCULES GRAPHICS STANDARDS

- SHORT SLOT CARD USES VLSI CHIPS TO INSURE RELIABILITY
- PARALLEL PRINTER PORT, CONFIGURABLE AS LPT1 OR LPT2
- 720 x 348 GRAPHICS MODE
- LOTUS COMPATIBLE
- CAN RUN WITH COLOR GRAPHICS CARD IN THE SAME SYSTEM



MCT-MG

\$79.95

COMPATIBLE WITH IBM MONOCHROME AND HERCULES GRAPHICS STANDARDS

- SERIAL PORT OPTION
- PARALLEL PRINTER PORT
- 720 x 348 GRAPHICS MODE
- 80 x 25 TEXT MODE
- LOTUS COMPATIBLE
- SELECTABLE TO RUN ALONG WITH COLOR GRAPHICS CARD IN THE SAME SYSTEM



MQ-SERIAL OPTIONAL SERIAL PORT \$19.95

MCT-MONO

\$49.95

ANOTHER FANTASTIC VALUE FROM JDR!

- IBM COMPATIBLE TTL INPUT
 - 720 x 348 PIXEL DISPLAY
- PLEASE NOTE: THIS CARD WILL NOT RUN LOTUS GRAPHICS AND DOES NOT INCLUDE A PARALLEL PORT



IBM COMPATIBLE KEYBOARDS

MCT-5150 \$59.95

- "5150" STYLE KEYBOARD
- FULLY IBM COMPATIBLE
- LED STATUS INDICATORS FOR CAPS & NUMBER LOCK
- LARGE, EASY TO REACH SHIFT & RETURN KEYS
- 83 KEY TYPEWRITER LAYOUT



MCT-5151 \$79.95

- REPLACEMENT FOR KEY TRONIC™ KB-5151 KEYBOARD
- SEPARATE CURSOR & NUMERIC KEYPAD
- CAPS LOCK & NUMBER LOCK INDICATORS
- IMPROVED KEYBOARD LAYOUT



MCT-5060 \$59.95

- IBM AT STYLE LAYOUT
- SOFTWARE AUTONSENSE FOR XT OR AT COMPATIBLES
- EXTRA LARGE SHIFT & RETURN KEYS
- LED INDICATORS FOR SCROLL, CAPS & NUMBER LOCK
- AUTO REPEAT FEATURE



MCT-5339 \$89.95

- IBM ENHANCED STYLE LAYOUT
- SOFTWARE AUTONSENSE FOR XT OR AT COMPATIBLES
- 12 FUNCTION KEYS
- EXTRA LARGE SHIFT & RETURN KEYS
- LED INDICATORS FOR SCROLL, CAPS & NUMBER LOCK
- AUTO REPEAT FEATURE
- SEPARATE CURSOR PAD

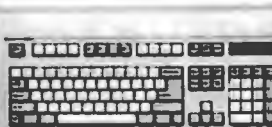

EPROM PROGRAMMERS

FROM MODULAR CIRCUIT TECHNOLOGY

MCT-EPROM

\$129.95

PROGRAMS 27xx AND 27xxx SERIES EPROMS UP TO 27512

- SUPPORTS VARIOUS MANUFACTURERS FORMATS WITH 12.5, 21 AND 25 VOLT PROGRAMMING
- MENU-DRIVEN SOFTWARE ALLOWS EASY MANIPULATION OF DATA FILES
- SPLIT OR COMBINE THE CONTENTS OF SEVERAL EPROMS OF DIFFERENT SIZES
- READ, WRITE, COPY, ERASE CHECK AND VERIFY WITH EASY ONE KEY SELECTION
- INCLUDES SOFTWARE FOR STANDARD HEX AND INTEL HEX FORMATS



4 GANG PROGRAMMER \$189.95

10 GANG PROGRAMMER \$299.95



MCT PRODUCTS CARRY A ONE YEAR WARRANTY

INQUIRY 164 COPYRIGHT 1987 JDR MICRODEVICES

1200B MODEM \$99⁹⁵ FOR IBM W/
SOFTWARE

2400B MODEM \$199⁹⁵

MULTIFUNCTION CARDS

FROM MODULAR CIRCUIT TECHNOLOGY

MCT-MF \$79.95

ALL THE FEATURES OF AST'S SIX PACK PLUS AT HALF THE PRICE!

- 0-348K DYNAMIC RAM USING 4164s
- INCLUDES SERIAL PORT, PARALLEL PRINTER PORT, GAME CONTROLLER PORT AND CLOCK/CALENDAR
- SOFTWARE FOR A RAMDISK, PRINT SPOOLER AND CLOCK/CALENDAR



MCT-ATMF \$139.95

ADDS UP TO 3 MB OF 1 BIT RAM TO THE AT

- USER EXPANDABLE TO 1.5 MB OF ON-BOARD MEMORY (NO MEMORY INSTALLED)
- FLEXIBLE ADDRESS CONFIGURATION
- INCLUDES SERIAL PORT, PARALLEL PORT AND CLOCK/CALENDAR
- OPTIONAL PIGGYBACK BOARD PERMITS EXPANSION TO 3 MB



ATMF-SERIAL 2nd SERIAL PORT \$24⁹⁵
MCT-ATMF-MC \$29⁹⁵
PIGGYBACK BOARD (ZERO K INSTALLED)

MCT-MIO \$79.95

A PERFECT COMPANION FOR OUR MOTHERBOARD

- 2 DRIVE FLOPPY DISK CONTROLLER
- INCLUDES SERIAL PORT, PARALLEL PORT, GAME PORT AND CLOCK/CALENDAR WITH BATTERY BACK-UP
- SOFTWARE FOR A RAMDISK, PRINT SPOOLER AND CLOCK/CALENDAR



MIO-SERIAL 2nd SERIAL PORT \$15⁹⁵

MCT-IO \$59.95

USE WITH MCT-FH FOR A MINIMUM OF SLOTS USED

- SERIAL PORT ADDRESSABLE AS COM1, COM2, COM3 OR COM4
- PARALLEL PRINTER PORT ADDRESSABLE AS LPT1 OR LPT2 (K378 OR X278)
- GAME PORT AND CLOCK/CALENDAR WITH A BATTERY BACK-UP



IO-SERIAL 2nd SERIAL PORT \$15⁹⁵

MCT-ATIO \$59.95

USE WITH MCT-ATFH FOR A MINIMUM OF SLOTS USED

- SERIAL PORT ADDRESSABLE AS COM1, COM2, COM3 OR COM4
- PARALLEL PRINTER PORT ADDRESSABLE AS LPTA OR LPTB (K378 OR X278)
- GAME PORT
- USES 16450 SERIAL SUPPORT CHIPS FOR HIGH SPEED OPERATION IN AN AT



ATIO-SERIAL 2nd SERIAL PORT \$24⁹⁵

RAM CARDS

FROM MODULAR CIRCUIT TECHNOLOGY

MCT-RAM \$69.95

A CONTIGUOUS MEMORY SOLUTION FOR YOUR SHORT OR REGULAR SLOT

- SHORT SLOT, LOW POWER PC COMPATIBLE DESIGN
- CAN OFFER UP TO 576K OF ADDITIONAL MEMORY
- USER SELECTABLE CONFIGURATION AMOUNTS OF 192, 384, 512, 256 & 576K, USING COMBINATIONS OF 64 & 256K RAM

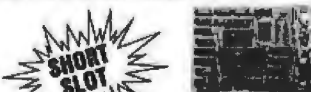

MCT-ATRAM \$149.95

A POWER USER'S DREAM, 4MB OF MEMORY FOR THE AT

- USER EXPANDABLE TO 2MB OF ON-BOARD MEMORY
- USES FULL 16 BIT PARITY CHECKED MEMORY, 64K OR 256K DYNAMIC RAM
- FLEXIBLE STARTING ADDRESS, ROUND OUT CONVENTIONAL MEMORY TO 640K & ADD EXTENDED MEMORY ABOVE 1MB



MCT-ATRAM-MC \$39⁹⁵
2MB PIGGYBACK BOARD (ZERO K INSTALLED)

MCT-EMS \$129.95

2MB OF LOTUS/INTEL/MICROSOFT COMPATIBLE MEMORY FOR THE XT

- CONFORMS TO LOTUS/INTEL EMS
- USER EXPANDABLE TO 2 MB
- USES 64K OR 256K DYNAMIC RAM (NO MEMORY INSTALLED)
- USE AS EXPANDED OR CONVENTIONAL MEMORY, RAMDISK OR SPOOLER
- SOFTWARE INCLUDES EMS DEVICE DRIVERS, PRINT SPOOLER AND RAMDISK



MCT-ATEMS AT VERSION OF THE MCT-EMS \$139⁹⁵

Seagate

HARD DISK SYSTEMS
20 MB 30 MB
\$339 \$399

Systems include half height hard disk drive, hard disk drive controller, cables and instructions. Drives are pre-tested and warranted for one year.

Seagate 40 MB AT DRIVE
FAST 40ms ACCESS TIME



\$599

DISK CONTROLLER CARDS

FROM MODULAR CIRCUIT TECHNOLOGY

MCT-FDC \$34.95

QUALITY DESIGN OFFERS 4 FLOPPY CONTROL IN A SINGLE SLOT

- INTERFACES UP TO 4 FDDs TO AN IBM PC OR COMPATIBLE
- INCLUDES CABLING FOR 2 INTERNAL DRIVES
- USES STANDARD DB37 CONNECTOR FOR EXTERNAL DRIVES
- SUPPORTS BOTH DS/DD AND DS/QD WHEN USED W/ DOS 3.2 OR JFORMAT

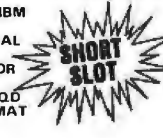

MCT-HDC \$89.95

HARD DISK CONTROL FOR WHAT OTHERS CHARGE FOR FLOPPY CONTROL

- IBM XT COMPATIBLE CONTROLLER
- SUPPORTS 16 DRIVE SIZES INCLUDING 5, 10, 20, 30 & 40MB
- OPTIONS INCLUDE THE ABILITY TO DIVIDE 1 LARGE DRIVE INTO 2 SMALLER, LOGICAL DRIVES
- INCLUDES CABLING FOR 1 INTERNAL DRIVE



MCT-RLI \$119.95

GET UP TO 50% MORE STORAGE SPACE ON YOUR HARD DISK

- INCREASES THE CAPACITY OF PLATED MEDIA DRIVES BY 50%
- RLL 2,7 ENCODING FOR MORE RELIABLE STORAGE
- TRANSFER RATE IS ALSO 50% FASTER: 750K/sec vs 500K/sec
- USE WITH ST-238 DRIVE TO ACHIEVE 30+ MB IN A HALF HEIGHT SLOT



NEW!

MCT-FH \$139.95

STARVED FOR SLOTS? SATISFY IT WITH THIS TIMELY DESIGN

- INTERFACES UP TO 2 FDDs & 2 HDDs
- CABLING FOR 2 FDDs & 1 HDD
- FLOPPY INTERFACE SUPPORTS BOTH DS/DD & DS/QD WHEN USED WITH DOS 3.2 OR JFORMAT
- ALL POPULAR HDD SIZES ARE SUPPORTED, INCLUDING 5, 10, 20, 30 & 40MB
- CAN DIVIDE 1 LARGE DRIVE INTO 2 SMALLER, LOGICAL DRIVES



MCT-ATFH \$169.95

FLOPPY AND HARD DISK CONTROL IN A TRUE AT DESIGN

- AT COMPATIBLE, CONTROL UP TO 2 360K/720K OR 1.2MB FDDs AS WELL AS 2 HDDs USING THE AT STANDARD CONTROL TABLES
- SUPPORTS AT STYLE FRONT PANEL LED TO INDICATE HD ACTIVITY
- 16 BIT BUSS PROVIDES RAPID DATA TRANSFERS
- FULLY SUPPORTED BY AT BIOS



BOMB

YOU CHOOSE THE BEST ARTICLE EACH MONTH

BYTE's ongoing monitor box (BOMB) lets you rate each article you've read in BYTE as excellent, good, fair, or poor. Each month, you can mail in the BOMB card found at the back of the issue. We tally your votes, total the points, tell you who won, and award the two top-rated nonstaff authors

\$100 and \$50, respectively. An additional \$50 award for quality goes to the nonstaff author with the best average score (total points divided by the number of voters). If you prefer, you can use BIX as your method of voting. We welcome your participation.

ARTICLE#	PAGE	ARTICLE	AUTHOR(S)
1	9	Microbytes	staff
2	29	What's New.....	staff
3	52	Ask BYTE/Circuit Cellar Feedback	Ciarcia
4	67	Book Reviews.....	Bobinsky, West, Walker, Grehan
5	85	The Tandon PAC 286.....	Vose, Erickson, Weston
6	95	Ciarcia's Circuit Cellar: Build a Gray-Scale Video Digitizer, Part 1: Display/Receiver.....	Ciarcia
7	108	Programming Project: Pull-Down Menus in C.....	Pinson
8	113	Build BERT, the Basic Educa- tional Robot Trainer, Part 2...	Brown
9	125	An Adventure Authoring System	Betz
10	135	Interactive Fiction as Literature	Buckles
11	149	The Desktop-Publishing Phenomenon	Seybold

ARTICLE#	PAGE	ARTICLE	AUTHOR(S)
12	159	Make My Page!.....	Holmes
13	171	Designing a Raster-Image Processor	Barrett, Reistroffer
14	185	Programming in PostScript...	Pelli
15	209	High-Speed Internal Modems...	Satchell
16	221	Compaq's New Carryon.....	Unger
17	229	The Commodore 64C.....	Mayer
18	237	SCSI Hard Disk Drives for the Macintosh	Crawford, White
19	241	BASIC Compilers for the Macintosh.....	Norman
20	249	Q&A 2.0.....	Robinson
21	251	Lyrix	Allen
22	261	Computing at Chaos Manor: Bye-Bye Big Kat	Pournelle
23	279	According to Webster: Publish and/or Perish.....	Webster
24	293	Applications Only: Mostly Mac.....	Shapiro
25	307	Mathematical Recreations: Around and Around.....	Kurosaka
26	325	Best of BIX.....	BIXen

BOMB RESULTS

Top billing for February goes to What's New, written by BYTE staffers. This is followed by Jerry Pournelle's Computing at Chaos Manor column, entitled "A Confederation of Hackers." In third place is Steve Ciarcia's Circuit Cellar project, "Build an Infrared Remote Controller." In fourth and the winner of \$100 is John Unger for his

review of "Four Portable Computers." Rene Stolk and George Ettershank will split the \$50 second-place prize for their Programming Insight: "Calculating the Area of an Irregular Shape." Winner of the \$50 award for quality goes to Dennis Dykstra for his review of "Microsoft QuickBASIC 2.0." Congratulations everyone.

COMING UP IN BYTE

Features:

A special advance look at a major new software development. We also have articles on Conrec, which is a contouring subroutine; storing maps on CD-ROMs; and Karmarkar's algorithm.

Theme:

Computer-aided design will include the following topics: data structures of CAD, shareware CAD, computer-aided routing of PC boards, the IEGS data interchange format, and silicon compilers.

Circuit Cellar:

Part 2 of Steve Ciarcia's video digitizer.

Programming Insights:

Articles on complex math in Pascal and a polynomial curve fitter in BASIC.

Reviews:

Two 12-MHz IBM PC AT compatibles, the IBM PC XT 286, the Amiga Turbo Chassis, a group review of Mice, three C interpreters for the IBM PC, Microsoft's Windows, Smalltalk/V, Turbo Prolog and Chalcedony Prolog, an expert system tool called Acquaint, and a filer called Zoomracks.

Kernel:

Jerry Pournelle's Chaos Manor, According to Webster, Dick Pountain's new Algorithms column, and Ezra Shapiro's Applications Only.

EDITORIAL INDEX BY COMPANY

Index of companies covered in articles, columns, or news stories in this issue.
Each reference is to the first page of the article or section in which the company name appears.

COMPANY	PAGE	COMPANY	PAGE	COMPANY	PAGE
ADAPTAPAK	29	FIFTH GENERATION SYSTEMS	261	OMNITEL	209
ADDISON-WESLEY	29, 159, 185, 241	FORETHOUGHT	29, 293	OUTPUT TECHNOLOGY	29
ADOBE SYSTEMS	9, 149, 171, 185, 293	FTL SYSTEMS	159	PARKER BROTHERS	9
AGFA GEVAERT	185	FUJI	9	PBI SOFTWARE	261
ALDUS	29, 149, 159	G.O.GRAPHICS	159	PC DISCOUNT	29
ALEXANDRIA INSTITUTE	9	GENERAL COMPUTER	237	PEAK SYSTEMS	237
ALLIED LINOTYPE	149	GENERAL INFORMATION	293	PERIPHERAL LAND	237
ALPHATYPE	159	GENERIC SOFTWARE	29	PERSONAL TEX	159
ALTSYS	293	GRAPHIC PRESENTATION CHARTS	185	PETER NORTON COMPUTING	261
AMERICAN MICRO TECHNOLOGY	29	GRID SYSTEMS	29	PROAPP	237
AMGRAF	159	HANZON DATA	185	PROSOFT	159
ANCHOR AUTOMATION	209	HAYES MICROCOMPUTER PRODUCTS	209	PS PUBLISHING	159
ANDERSON JACOBSON	209	HEWLETT-PACKARD	29, 171	PTERODACTYL SOFTWARE	241
APOLLO	185	IBM	9, 29, 85, 149, 159, 171	QMS	185
APPLE COMPUTER	9, 149, 171, 185, 237, 241	IMAGEN	171	RADIUS	279
ASHLEY HOUSE	185	INSIGNIA SOLUTIONS	29	RELAX TECHNOLOGY	237
ASHTON-TATE	9	INTEL	85	SCENIC SOFT	159
ASYMETRIX	9	INTERLEAF	171	SEAGATE	9
AVATAR TECHNOLOGIES	29	ITEK GRAPHIX	159	SOFTWARE CHANNELS	159
AVYX	29	ITT QUME	185	SOFTWARE PUBLISHING	159
AWARD SOFTWARE	159	KAYPRO	261	SPRINGER-VERLAG	67
AXONIX	29	KENNER INDUSTRIES	307	STUDIO SOFTWARE	159
BESTINFO	159	KNOWLEDGE ENGINEERING	185	STYLEWARE	29
BIZCOMP	29	KODAK	9	SUN MICROSYSTEMS	185
BORLAND INTERNATIONAL	9	LASER CONNECTION	185	SUPER MAC TECHNOLOGY	237
BOSTON PUBLISHING SYSTEMS	159	LATTICE	109	SYMANTEC	9, 249
BRAINPOWER	29	LEADING EDGE HARDWARE PRODUCTS	29	SYMMETRY	293
BUTTON WARE	29	LETRASET USA	159	SYNERGETICS	185
CAMBRIDGE UNIVERSITY	185	LEVCO	279	SYSTEMS AND SOFTWARE	29
CANON	171	LEXISOFT	159	SYSTEMS RESEARCH	29
CE SOFTWARE	185	LINOTYPE	185	TANDON	85
CENTRAM SYSTEMS WEST	185	LIVING VIDEOTEXT	261, 293	TANDY	29, 85
CERMETEK MICROELECTRONICS	209	LNEC INFORMATION SYSTEMS	29	TANGENT TECHNOLOGIES	185
CHEETAH INTERNATIONAL	261	MACMEMORY	279	TARGET SOFTWARE	29
CLEMSON UNIVERSITY	9	MACUSER PUBLICATIONS	67	TELE-WARE WEST	261
COMMODORE BUSINESS MACHINES	29, 229	MAGNA COMPUTER SYSTEMS	159	TELEBIT	209
COMPAQ COMPUTER	29, 221	MAXTOR	9	TELEROBOTICS INTERNATIONAL	9
COMPUGRAPHIC	159	MAYNARD ELECTRONICS	9	TELESIS DISTRIBUTING	9
COMPUPRO	261	MEGAHAUS	159	TEXAS INSTRUMENTS	185
COMPUTER SHOPPER	185	MICRO CONTROL SYSTEMS	29	THE 'PUTER GROUP	159
COMPUTER SYSTEM ASSOCIATES	29	MICRO LOGIC	279	3M	185
CONSULAIR	279	MICROGRAPHIC IMAGES	279	TMS	9
CREATIVE DIGITAL	209	MICRORIM	29	TYPESETTING NETWORK	159
CRICKET SOFTWARE	185	MICROSOFT	9, 159	TYX	159
CTS FABRI-TEK	209	MICROSOFT PRESS	67	UNISOFT	29
CURTIS MANUFACTURING	29	MIGENT	29	US ROBOTICS	209
CYBERRESEARCH	159	MINISCRIBE	9	VEN-TEL	209
DATA TAILOR	293	MIRROR TECHNOLOGIES	237	VERBATIM	9
DATA TRANSFORMS	159	MOLECULAR DESIGN	29	VERSACAD	29
DATALIGHT	29	MONOLITHIC SYSTEMS	29	VISUAL COMMUNICATIONS NETWORK	29
DATALIGHT	29	MOTOROLA	9, 149, 171	WEST END FILM	159
DATAPRODUCTS	185	MOUSE SYSTEMS	29	WESTERN COMPUTER	237
DICONIX	185	NBI	185	WHITE SCIENCES	159
DIGITAL COMMUNICATIONS ASSOC	209	NEC	185	WORDPERFECT	159
DIGITAL EQUIPMENT	185	NEC HOME ELECTRONICS (U.S.A.)	29	XEROX	149, 159, 171
DIGITAL PRESS	67	NETWORK TECHNOLOGY	159	XYQUEST	159
E. ARTHUR BROWN	29	NEW AMERICAN PAGEPLANNER	159	ZEDCOR	241
E-MACHINES	279	NEW ENGLAND SOFTWARE	29	ZENITH DATA SYSTEMS	261
EXPERTELLIGENCE	9	NEWBURY DATA	9		
EXPERTWARE	9	NRG ELECTRONICS	29		
FACIT	185				
FASTCOMM DATA	209				

BACK ISSUES FOR SALE

	1985	1986	1987
Jan.	\$4.25		\$4.25
Feb.	\$4.25	\$4.25	\$4.25
March	\$4.25	\$4.25	\$4.25
April	\$4.25		\$4.25
May	\$4.25		
June	\$4.25	\$4.25	
July		\$4.25	
Aug.	\$4.25	\$4.25	
Sept.	\$4.25	\$4.25	
Oct.	\$4.25	\$4.25	
Nov.	\$4.25	\$4.25	
Dec.	\$4.25	\$4.25	

SPECIAL ISSUES and INDEX

BYTE '83-'84 INDEX	\$1.75
BYTE 1985 INDEX	\$2.00
1984 SPECIAL GUIDE TO IBM PCs (VOL. 9, No. 9)	\$4.75
1985 INSIDE THE IBM PCs (VOL. 10, No. 11)	\$4.75

Circle and send requests with payments to:

BYTE Back Issues
P.O. Box 328
Hancock, NH 03449

Check enclosed *Payments from foreign countries must be made in US funds payable at a US bank.*

VISA MasterCard

CARD # _____ EXP. DATE _____

SIGNATURE _____

The above prices include postage in the US. Please add \$.50 per copy for Canada and Mexico; and \$2.00 per copy to foreign countries (surface delivery). Please allow 4 weeks for domestic delivery and 12 weeks for foreign delivery.

NAME _____

ADDRESS _____

CITY _____ STATE _____ ZIP _____

BYTE ADVERTISING SALES STAFF:

Dennis J. Riley, Advertising Sales Manager, One Phoenix Mill Lane, Peterborough, NH 03458, tel. (603) 924-9281

NEW ENGLAND
 ME, NH, VT, MA, RI,
 ONTARIO, CANADA & EASTERN CANADA
 Paul McPherson Jr. (617) 262-1160
 McGraw-Hill Publications
 575 Boylston Street
 Boston, MA 02116

ATLANTIC
 NY, NYC, CT, NJ (NORTH)
 Leah G. Rabinowitz (212) 512-2096
 McGraw-Hill Publications
 1221 Avenue of the Americas—
 39th Floor
 New York, NY 10020

Dick McGurk (203) 968-7111
 McGraw-Hill Publications
 Building A—3rd Floor
 777 Long Ridge Road
 Stamford, CT 06902

EAST
 PA, KY, OH, NJ (SOUTH),
 MD, VA, W.VA, DE, D.C.
 Daniel Ferro (215) 496-3833
 McGraw-Hill Publications
 Three Parkway
 Philadelphia, PA 19102

**NORTHEAST MAIL ORDER
 AND RETAIL ACCOUNTS**
 Bill Watson (603) 924-7255
 One Phoenix Mill Lane
 Peterborough, NH 03458

SOUTHEAST
 NC, SC, GA, FL, AL, TN
 Carolyn F. Lovett (404) 252-0626
 McGraw-Hill Publications
 4170 Ashford-Dunwoody Road
 Suite 420
 Atlanta, GA 30319

MIDWEST
 IL, MO, KS, IA, ND, SD, MN, WI,
 NB, IN, MI, MS
 Bob Denmead (312) 751-3740
 McGraw-Hill Publications
 Blair Building
 645 North Michigan Ave.
 Chicago, IL 60611

SOUTHWEST, ROCKY MOUNTAIN
 UT, CO, WY, OK, TX, AR, LA
 (214) 458-2400
 McGraw-Hill Publications
 Prestonwood Tower—Suite 907
 5151 Beltline
 Dallas, TX 75240

SOUTH PACIFIC
 SOUTHERN CA, AZ, NM, LAS VEGAS
 Jack Anderson (714) 557-6292
 McGraw-Hill Publications
 3001 Red Hill Ave.
 Building #1—Suite 222
 Costa Mesa, CA 92626

(213) 480-5243, 487-1160
 McGraw-Hill Publications
 3333 Wilshire Boulevard #407
 Los Angeles, CA 90010

NORTH PACIFIC
 HI, WA, OR, ID, MT, NORTHERN CA,
 NV (except LAS VEGAS), W. CANADA
 Mike Kisseberth (415) 362-4600
 McGraw-Hill Publications
 425 Battery Street
 San Francisco, CA 94111

Bill McAfee (415) 349-4100
 McGraw-Hill Publications
 951 Mariner's Island Blvd.—3rd Floor
 San Mateo, CA 94404

**WEST COAST MAIL ORDER
 AND RETAIL ACCOUNTS**
 Tom Harvey (805) 964-8577
 3463 State Street—Suite 256
 Santa Barbara, CA 93105

The Buyer's Mart
 (603) 924-3754
 Mary Ann Goulding (603) 924-9281
 BYTE Publications
 One Phoenix Mill Lane
 Peterborough, NH 03458

BYTE BITS (2x3)
 Dan Harper (603) 924-6830
 BYTE Publications
 One Phoenix Mill Lane
 Peterborough, NH 03458

**Post Card Mailings
 National**
 Ed Ware (603) 924-6166
 BYTE Publications
 One Phoenix Mill Lane
 Peterborough, NH 03458

International Advertising Sales Staff:

Mr. Hans Csokor
 Publimedia
 Reinsnerstrasse 61
 A-1037 Vienna, Austria
 222 75 76 84

Mrs. Gurit Gepner
 McGraw-Hill Publishing Co.
 PO Box 2156
 Bat Yam, 59121 Israel
 3 866 561 321 39

Mr. Fritz Krusebecker
 McGraw-Hill Publishing Co.
 Liebigstrasse 19
 D-6000 Frankfurt/Main 1
 West Germany
 69 72 01 81

Mrs. Maria Sarmiento
 Pedro Teixeira 8, Off. 320
 Iberia Mart I
 Madrid 4, Spain
 1 45 52 891

Mr. Andrew Karnig
 Andrew Karnig & Associates
 Finnbodavagen
 S-131 31 Nacka, Sweden
 8-44 0005

Mr. Alain Faure
 McGraw-Hill Publishing Co.
 128 Faubourg Saint Honore
 75008 Paris
 France
 (1) 42-89-03-81

Mr. Arthur Scheffer
 McGraw-Hill Publishing Co.
 34 Dover St.
 London W1X 3RA
 England 01 493 1451

Manuela Capuano
 McGraw-Hill Publishing Co.
 Via Flavio Baracchini 1
 20123 Milan, Italy
 02 86 90 617

Seavex Ltd.
 400 Orchard Road, #10-01
 Singapore 0923
 Republic of Singapore
 Tel: 734-9790
 Telex: RS35539 SEAVEX

Seavex Ltd.
 503 Wilson House
 19-27 Wyndham St.
 Central, Hong Kong
 Tel: 5-260145
 Telex: 60904 SEVEX HX

Hiro Morita
 McGraw-Hill Publishing Co.
 Overseas Corp.
 Room 1528
 Kasumigaseki Bldg.
 3-2-5 Kasumigaseki,
 Chiyoda-Ku
 Tokyo 100, Japan
 3 581 9811

Mr. Ernest McGrady
 Empresa Internacional de
 Comunicacoes Ltda.
 Rua da Consolacao, 222
 Conjunto 103
 01302 Sao Paulo, S.P., Brasil
 Tel: (11) 259-3811
 Telex: (100) 32122 EMBN

READER SERVICE

To get further information on the products advertised in BYTE, fill out the reader service card by circling the numbers on the card that correspond to the inquiry number listed with the advertiser. This index is provided as an additional service by the publisher, who assumes no liability for errors or omissions.

* Correspond directly with company

Alphabetical Index to Advertisers

Inquiry No.	Page No.	Inquiry No.	Page No.	Inquiry No.	Page No.	Inquiry No.	Page No.
3 ABSOFT	326	72 COMPUTER WAREHOUSE	248	154 INTELICOM	82	229 ORIENTAL PRECISION CO.	281
4 ACM SIGGRAPH '87	303	73 COMPUTER WAREHOUSE	248	155 INTELISOFT	292	230 ORION INSTRUMENTS	236
6 ADDMASTER CORP.	368	75 CONTECH COMPUTER CORP.	358	156 INTERFACE GROUP	341	231 OSBORNE MCGRAW-HILL	331
2 ADOBE	275	76 COTTON SOFTWARE	366	157 IO TECH.	372	232 PATTON & PATTON	366
7 ADVANCED COMP. PROD.	379	77 CRAYON GRAPHICS CENTER	360	158 JACO ENTERPRISES	361	234 PC AMERICAN MARKETING	203
8 ADVANCED DIGITAL	28	78 CSS LABS	158	159 JADE COMPUTER	382,383	235 PC HORIZONS	372
9 ADVANCED DIGITAL	28	79 CSS LABS	158	160 JAMECO ELECTRONICS	380,381	236 PC NETWORK	355
11 AHEAD SYSTEMS INC.	72	80 CUESTA SYSTEMS	246	161 JDR INSTRUMENTS	181	237 PC NETWORK	356,357
12 AHEAD SYSTEMS INC.	72	82 CUSTOM SOFTWARE SYSTEMS 70		162 JDR MICRODEVICES	384,385	238 PC PRO SYSTEMS INC.	370
14 ALP SYSTEMS INC.	258	* DAK INDUSTRIES INC.	120,121	163 JDR MICRODEVICES	386,387	240 PC TECH	78
15 ALPHA PRODUCTS	367	* DAK INDUSTRIES INC.	122,123	164 JDR MICRODEVICES	388,389	241 PC'S LIMITED	234,235
16 ALPHA PRODUCTS CO.	374	83 DALCO ELECTRONICS	374	165 JMR ELECTRONICS	358	242 PECAN SOFTWARE SYSTEMS	119
17 ALPS AMERICA	64	85 DATA SPEC	192,193	222 JUKO ELECTRONICS	228	243 PENGUIN COMPUTER TECHN.	308
18 ALPS AMERICA	65	86 DATA SPEC	192,193	166 KADAK PRODUCTS LTD.	78	244 PERMA POWER ELECTRONICS272	
19 ALSYS LTD.	175	87 DATA TRANSLATION	69	167 KAYPRO CORPORATION	151	245 PERMA POWER ELECTRONICS272	
20 AMDEK CORP.	37	88 DATADESK INTERNATIONAL	189	168 KAYPRO CORPORATION	151	246 PERSOFT INC.	8
* AMERICAN DESIGN COMPNTS.	371	89 DATADESK INTERNATIONAL	189	356 KEA SYSTEMS LTD.	364	245 PERSOFT INC.	8
368 AMERICAN RESEARCH CORP.	233	97 DCS	360	169 KEITHLY/DAC	253	247 PERSONAL COMP. SUPPORT GRP245	
369 AMERICAN RESEARCH CORP.	233	90 DICONIX	66	171 LAHEY COMPUTER SYSTEMS	130	248 PERSONAL TEX	282
22 AMERICAN SEMICONDUCTOR	281	91 DIGITAL I	60	172 LATTICE INC.	138	249 PETER NORTON	143
23 AMERICAN SMALL BUSINESS	73	92 DIGITAL	84	173 LAWSON LABS	366	250 PMI	286
24 AMERICAN SOFTWARE HOUSE267		93 DISCOTECH	368	174 LIFEBOAT ASS	204	251 PMI	286
25 AMPRO COMPUTERS INC.	335	94 DISK WORLD INC.	358	176 LINDE TECH.	366	252 PRECISION MOTION	370
27 AO ELECTRONICS	326	95 DISKETTE CONNEC	363	177 LINK COMPUTER GRAPHICS	376	253 PRIDE SOFTWARE DEV.	296
28 APROTEK	364	66 DISKMASTER	370	178 LOGICAL DEVICES	166	254 PRIDE SOFTWARE DEV.	296
29 ARITY CORPORATION	302	96 DISKS PLUS	288	179 LOGICAL DEVICES	166	255 PRINCETON GRAPHIC SYSTEMS 208	
370 ASHTON-TATE	226,227	* DOW JONES NEWS RETRIEVAL 75		180 LOGICAL SYSTEMS	370	175 PROGRAMMER'S PARADISE	168,169
* AST RESEARCH	14,15	99 DRESSSELHAUS COMP. PROD.	48	400 LOGICSOFT	240A-F	256 PROGRAMMER'S SHOP	263
31 ATI TECHNOLOGII	333	101 ECOSOFT	55	182 LOGITECH	45	257 PROGRAMMER'S SHOP	265
32 ATRON CORP.	61	* EDWARDS AIR FORCE BASE	310	183 LOGITECH	47	258 PROTEC MICRO SYSTEMS	374
33 ATRONICS	285	* ELECTRONICS MAGAZINE	257	184 LONE STAR SOFTWARE	369	259 PURPLE COMPUTING	370
34 AVOCET SYSTEMS INC.	197	103 ELEXOR INC.	326	* LOTUS DEVELOPMENT	131	260 P.D. SIG	374
35 BARRINGTON SYSTEMS	33	104 ELLIS COMPUTING INC.	225	* MACMILLAN BOOK CLUBS	273	261 QIC RESEARCH	294
36 BAY EXPRESS	361	105 ENGINEERS COLLABORATIVE	361	186 MANX SOFTWARE SYS.	133	262 QSP	327
37 BAY TECHNICAL ASSOC.	301	114 EPOTEK CORP.	76	187 MANX SOFTWARE SYS.	195	263 QUA TECH	363
* BEST WESTERN	154	107 EVEREX SYSTEMS	25	188 MARK WILLIAMS CO.	77	264 QUA TECH	363
* BINARY TECHNOLOGIES	366	108 EVEREX SYSTEMS	25	189 MARK WILLIAMS CO.	77	265 QUA TECH	363
40 BIT SOFTWARE	68	109 EVEREX SYSTEMS	26,27	190 MATHSOFT INC.	31	266 QUA TECH	363
41 BOCA RESEARCH INC.	311	110 EVEREX SYSTEMS	26,27	* MAXELL DATA PRODUCTS	7	267 QUA TECH	363
43 BORLAND INT'L	CII,1	115 FILTREX RESEARCH INC.	368	* MCGRAW-HILL NRI SCHOOLS	289	268 QUA TECH	363
44 BORLAND INT'L	CII,1	116 FLAGSTAFF ENGINEERING	260	192 MEGAD COMPUTER CORP.	375	269 QUADRAM SOFTWARE	179
45 BP MICROSYSTEMS	360	117 FLAGSTAFF ENGINEERING	260	193 MEGASOFT	360	270 QUANTUM SOFTWARE	111
* BUYER'S MART	346-354	118 FOCUS ELECTRONICS	154	194 MEGATEL COMPUTER TECH.	76	271 QUELO INC.	372
* BYTE BACK ISSUES	392	119 FORESIGHT RESOURCES	283	195 MERRITT COMP. PRODUCTS	358	272 QUICKSOFT	89
* BYTE BITS	376	120 FORESIGHT RESOURCES	283	196 MICROCOM SYSTEMS	54	273 QUINN-CURTIS	368
* BYTE CIRCULATION	324	121 FORTRON CORPORATION	215	197 MICRO DATA BASE SYSTEMS INC.	316	274 RADIO SHACK	CIV
450 BYTE INFO EXCHANGE (BIX)	256	122 FORTRON CORPORATION	215	198 MICRO DISPLAY SYSTEMS	59	275 RADIO SHACK	127
* BYTE MARKETING	322,323	123 FOX SOFTWARE	22	199 MICROGRAFX	39	* RAIMA CORP.	20
* BYTE SUB. MESSAGE	290	124 GALACTICOMM INC.	164	* MICROMINIT	345	277 RAINBOW TECHNOLOGIES	290
* BYTE SUB. SERVICE	376	127 GENERAL PARAMETRICS	287	200 MICRON TECHNOLOGY	304	278 REAL TIME DEVICES INC.	361
47 BYTE CORPORATION	24	128 GENERAL PARAMETRICS	287	201 MICROPRO INT'L	297	279 REVOLUTION SOFTWARE INC.	58
48 B&B ELECTRONICS	374	129 GENICOM	155	202 MICROPROCESSORS UNLTD.	364	280 ROLAND DG	306
49 B&C MICROSYSTEMS	370	130 GENOA SYSTEMS CORP.	305	203 MICROSOFT CORP.	216,217	281 ROSE ELECTRONICS	376
50 B&C MICROSYSTEMS	372	131 GLOBAL COMPUTER SUPPLIES361		204 MICROSOFT CORP.	218,219	282 RR SOFTWARE	271
51 CAD SOFTWARE	284	* GOLD HILL COMPUTERS	80,81	* MICROSOFT CORP.	53	283 SAFEWARE	358
* CALIFORNIA DIGITAL	377	132 GOLDEN BOW SYSTEMS	358	* MICROSOFT CORP.	199	284 SBT CORPORATION	124
52 CAPITAL EQUIPMENT	62	133 GOLDEN BOW SYSTEMS	374	* MICROSOFT CORP.	112A-D	285 SCIENTIFIC ENGR. LABS	360
53 CARIBBEAN MICRO	374	135 GRAFFPOINT	366	206 MICROSTAR LABS	368	286 SCR CORPORATION	370
54 CENTRAL COMPUTER PRODS.360		136 GTCO CORP.	343	207 MICROWAY	94	374 SDP INC.	376
55 CENTROID CORP.	364	137 GTEK INC.	112	208 MIGENT SOFTWARE INC.	182,183	287 SEAGATE TECHNOLOGY	136,137
58 CHUNG YU	288	* HARMONY COMPUTERS	60	209 MIGENT SOFTWARE INC.	269	288 SEAGATE TECHNOLOGY	136,137
59 CITIZEN AME!	23	138 HAYES MICROCOMPUTER	107	210 MIX SOFTWARE	309	* SHARP	295
* CLEO SOFTW	184	139 HERCULES COMPUTER TECH.40,41		211 MONEYSWORTH	56,57	292 SIERRA COMPUTER CONTROL374	
60 CLUB AT	91	140 HERCULES COMPUTER TECH.40,41		375 MOORE BUSINESS FORMS	364	293 SILICON SPECIALITIES	71
371 COEFFICIE!	277	141 HERCULES COMPUTER TECH.262		212 M-S CORPORATION	358	294 SILICON SPECIALITIES	71
61 COGITATE	360	142 HERCULES COMPUTER TECH.262		213 NANTUCKET	35	295 SOFTCRAFT INC.	247
62 COGITATE	372	143 HEWLETT-PACKARD	206	214 NANTUCKET	35	296 SOFTCRAFT INC.	247
* COMPAQ COMPUTER CORP.144,145		144 HITECH INT'L INC.	266	215 NATIONAL INSTRUMENTS	329	297 SOFTLONE DISTI	232
63 COMPUTADATA TRANSLATORS	370	145 HOOLEON COMPANY	284	217 NATURAL MICROSYSTEMS CORP.318		298 SOFTLINE CORP.	93
* COMPUPRO	196	146 HOOLEON COMPANY	284	218 NEC HOME ELECTRONICS	139	299 SOFTLOGIC SOLU	255
64 COMPUSAVE	359	147 HOUSTON INSTRUMENTS	63	219 NEC HOME ELECTRONICS	141	300 SOFTRONICS	364
65 COMPUSERVE	220	148 IBEX COMP. CORP.	361	220 NEC HOME ELECTRONICS	299	366 SOFTWARE LINK	21
67 COMPUTER BOOK CLUB	337	149 IC EXPRESS	368	221 NEC INFORMATION SYS.	CIII	367 SOFTWARE LINK	21
* COMPUTER CONTINUUM	370	372 INFOTRONICS	334	223 NEWBURY DATA INC.	129	302 SOFT/PLUS RESEARCH	358
68 COMPUTER FRIENDS	274	373 INFOTRONICS	334	224 NICOLET	62	303 SOLUTION SYSTEMS	262
185 COMPUTER LIBRARY	268	* INTECTRA INC.	366	226 NORTHGATE COMPUTER SYS. 174		304 SOPHISTICATED SOFTWARE	72
69 COMPUTER MAIL ORDER	314,315	151 INTEGRAND RESEARCH CORP.312		* ON-LINE STORE	376	305 SOURCE ELECTRONICS	74
70 COMPUTER PARTS GALORE	361	152 INTEL CORP.	156,157	362 ORCHID TECHNOLOGY	43	306 SOURCE ELECTRONICS	74
71 COMPUTER VALLEY	373	153 INTELICOM	82	363 ORCHID TECHNOLOGY	43	307 SCS!	170

READER SERVICE

To get further information on the products advertised in BYTE, fill out the reader service card by circling the numbers on the card that correspond to the inquiry number listed with the advertiser. This index is provided as an additional service by the publisher, who assumes no liability for errors or omissions.

* Correspond directly with company

Index to Advertisers by Product Category

Inquiry No.	Page No.	Inquiry No.	Page No.	Inquiry No.	Page No.	Inquiry No.	Page No.
HARDWARE		INSTRUMENTATION		MODEMS/MULTIPLEXORS		SYSTEMS	
ADD INS		MASS STORAGE		MONITORS		TERMINALS	
11 AHEAD SYSTEMS INC.	72	75 CONTECH COMPUTER CORP.	358	20 AMDEK CORP.	37	114 EPOTEK CORP.	76
12 AHEAD SYSTEMS INC.	72	116 FLAGSTAFF ENGINEERING	260	198 MICRO DISPLAY SYSTEMS	59	340 VIDEX	319
15 ALPHA PRODUCTS	367	117 FLAGSTAFF ENGINEE	260	219 NEC HOME ELECTRONICS	141	353 WYSE TECHNOLOGY	146
27 AO ELECTRONICS	326	148 IBEX COMP. CORP.	361	255 PRINCETON GRAPHIC SYSTEMS	208		
* AST RESEARCH	14,15	* MAXELL DATA PRODUCTS	7	321 TEKTRONIX INC.	48A-D		
31 ATI TECHNOLOGIES INC.	333	287 SEAGATE TECHNOLOGY ..	136,137	NETWORK HARDWARE			
33 ATRONICS	285	288 SEAGATE TECHNOLOGY ..	136,137	37 BAY TECHNICAL ASSOC.	301	SOFTWARE	
41 BOCA RESEARCH INC.	311	323 TIGERTRONICS	74	* COMPUPRO	196	APPLE 2/MAC UTILITIES	
77 CRAYON GRAPHICS CENTER	360	337 VERBATIM CORP.	313	124 GALACTICOMM INC.	164	351 WOODCHUCK INDUSTRIES	
105 ENGINEERS COLLABORATIVE	361	MISCELLANEOUS		153 INTELICOM	82	ATARI/AMIGA APPLICATIONS—	
109 EVEREX SYSTEMS	26,27	16 ALPHA PRODUCTS CO.	374	154 INTELICOM	82	Scientific/Technical	
110 EVEREX SYSTEMS	26,27	32 ATRON CORP.	61	PRINTERS/PLOTTERS			
122 FORTRON CORPORATION	215	* BINARY TECHNOLOGIES	366	6 ADDMASTER CORP.	368	215 NATIONAL INSTRUMENTS	
121 FORTRON CORPORATION	215	48 B & B ELECTRONICS	374	18 ALPS AMERICA	65		
130 GENOA SYSTEMS CORP.	305	55 CENTROID CORP.	364	17 ALPS AMERICA	64		
139 HERCULES COMPUTER TECH.	40,41	58 CHUNG YU	288	54 CENTRAL COMPUT	360		
140 HERCULES COMPUTER TECH.	40,41	80 CUESTA SYSTEMS	246	59 CITIZEN AMERICA	23		
141 HERCULES COMPUTER TECH.	262	* DAK INDUSTRIES INC.	122,123	90 DICONIX	66		
142 HERCULES COMPUTER TECH.	262	83 DALCO ELECTRONICS	374	99 DRESSELHA	18		
152 INTEL CORP.	156,157	85 DATA SPEC	192,193	129 GENICOM	155		
157 IO TECH	372	86 DATA SPEC	192,193	143 HEWLETT-PACKARD	206		
222 JUKO ELECTRONICS	228	88 DATADESK INTERNATIONAL	189	147 HOUSTON INSTRUMENTS	63		
177 LINK COMPUTER GRAPHICS	376	89 DATADESK INTERNATIONAL	189	221 NEC INFORMATION SYS.	CIII		
218 NEC HOME ELECTRONICS	139	146 HOOLEON COMPANY	284	223 NEWBURY DATA INC.	129		
362 ORCHID TECHNOLOGY	43	151 HOOLEON COMPANY	284	259 PURPLE COMPUTING	370		
363 ORCHID TECHNOLOGY	43	155 INTEGRAND RESEARCH CORP.	312	269 QUADRAM SOFTWARE	179		
240 PC TECH	78	158 JACO ENTERPRISES	361	274 RADIO SHACK	CIV		
247 PERSONAL COMP. SUPPORT GRP.	245	165 JMR ELECTRONICS	358	280 ROLAND DG	306		
251 PMI	286	183 LOGITECH	47	331 UNITED INNOVATIONS	270		
250 PMI	286	195 MERRITT COMP. PRODUCTS	358				
263 QUA TECH	363	200 MICRON TECHNOLOGY	304				
264 QUA TECH	363	212 M-S CORPORATION	358				
314 SYSTEMS AND SOFTWARE INC.	300	235 PC HORIZONS	372				
315 SYSTEMS AND SOFTWARE INC.	300	365 PERMA POWER ELECTRONICS	272				
321 TEKTRONIX INC.	48A-D	364 PERMA POWER ELECTRONICS	272				
330 TURNPOINT AMERICA	339	258 PROTEC MICRO SYSTEMS ..	374				
339 VIDEO TECHNOLOGIES	376	277 RAINBOW TECHNOLOGIES ..	290				
343 VOYETRA TECHNOLOGIES	372	281 ROSE ELECTRONICS	376				
359 Z-WORLD	194						
HARDWARE PROGRAMMERS							
28 APROTEK	364						
45 BP MICROSYSTEMS	360						
47 BYTEK CORPORATION	24						
50 B & C MICROSYSTEMS	370						
49 B & C MICROSYSTEMS	372						
137 GTEK INC.	112						
178 LOGICAL DEVICES	166						
179 LOGICAL DEVICES	166						
224 NICOLET	62						

Continued

READER SERVICE

Inquiry No. Page No.
**IBM/MS-DOS APPLICATIONS—
 Business/Office**

35 BARRINGTON SYSTEMS	33
62 COGITATE	372
76 COTTON SOFTWARE	366
123 FOX SOFTWARE	22
197 MICRO DATA BASE SYSTEMS INC.	316
209 MIGENT SOFTWARE INC.	269
214 NANTUCKET	35
213 NANTUCKET	35
232 PATTON & PATTON	366
242 PECAN SOFTWARE SYSTEMS	119
254 PRIDE SOFTWARE DEV.	296
253 PRIDE SOFTWARE DEV.	296
* RAIMA CORP.	20
284 SBT CORPORATION	124
286 SCR CORPORATION	370

**IBM/MS-DOS APPLICATIONS
 Miscellaneous**

270 QUANTUM SOFTWARE	111
----------------------	-----

**IBM/MS-DOS APPLICATIONS
 Scientific/Technical**

370 ASHTON-TATE	226,227
87 DATA TRANSLATION	69
190 MATHSOFT INC.	31
248 PERSONAL TEX	282
309 SPECTRUM SOFTWARE	177

**IBM/MS-DOS APPLICATIONS
 Word Processing**

14 ALP SYSTEMS INC.	258
201 MICROPRO INT'L.	297
272 QUICKSOFT	89

IBM/MS-DOS—CAD

23 AMERICAN SMALL BUSINESS	73
51 CAD SOFTWARE	284
120 FORESIGHT RESOURCES	283
119 FORESIGHT RESOURCES	283
136 GTCO CORP.	343
199 MICROGRAFX	39
349 WINTEK CORP.	5

IBM/MS-DOS—Communications

40 BIT SOFTWARE	68
* CLEO SOFTWARE	184
371 COEFFICIENT SYSTEMS	277
97 DCS	360
135 GRAFFPOINT	366
356 KEA SYSTEMS LTD.	364
217 NATURAL MICROSYSTEMS CORP.	318
245 PERSOFT INC.	8
246 PERSOFT INC.	8
297 SOFTKLONE DISTRIBUTING	232
300 SOFTRONICS	364
342 VOTRAX	298

IBM/MS-DOS—Graphics

115 FILTRES RESEARCH INC.	368
273 QUINN-CURTIS	368
321 TEKTRONIX INC.	48A-D

IBM/MS-DOS—LAN

8 ADVANCED DIGITAL	28
9 ADVANCED DIGITAL	28
101 ECOSOFT	55
366 SOFTWARE LINK	21
367 SOFTWARE LINK	21

IBM/MS-DOS—Languages

3 ABSOFT	326
19 ALSYS LTD.	175
29 ARITY CORPORATION	302
43 BORLAND INT'L.	CII,1
44 BORLAND INT'L.	CII,1
92 DIGITAL INC.	84
104 ELLIS COMPUTING INC.	225
* GOLD HILL COMPUTERS	80,81
171 LAHEY COMPUTER SYSTEMS	130
172 LATTICE INC.	138
174 LIFEBOAT ASSOC.	204
182 LOGITECH	45
187 MANX SOFTWARE SYS.	195
188 MARK WILLIAMS CO.	17
203 MICROSOFT CORP.	216,217
204 MICROSOFT CORP.	218,219
* MICROSOFT CORP.	112A-D
282 RR SOFTWARE	271
310 STSC INC.	152,153

IBM/MS-DOS—Utilities

34 AVOCET SYSTEMS INC.	197
82 CUSTOM SOFTWARE SYSTEMS	70
91 DIGITAL PRODUCTS	60
132 GOLDEN BOW SYSTEMS	358
133 GOLDEN BOW SYSTEMS	374
155 INTELISOFT	292
180 LOGICAL SYSTEMS	370
189 MARK WILLIAMS CO.	77
* MICROSOFT CORP.	199
210 MIX SOFTWARE	309
249 PETER NORTON	143
279 REVOLUTION SOFTWARE INC.	58
285 SCIENTIFIC ENGR. LABS	360
299 SOFTLOGIC SOLUTIONS	255
303 SOLUTION SYSTEMS	262
304 SOPHISTICATED SOFTWARE	72
312 SYBIS	360
329 TURBOPOWER SOFTWARE	167
351 WOODCHUCK INDUSTRIES	72

OTHER—Languages

186 MANX SOFTWARE SYS.	133
------------------------	-----

OTHER—Utilities

166 KADAK PRODUCTS LTD.	78
271 QUELO INC.	372
332 UNIVERSAL CROSS-ASSEMBLERS	372

Inquiry No. Page No.
MAIL ORDER/RETAIL

7 ADVANCED COMP. PROD.	379
* AMERICAN DESIGN COMPNTS.	371
24 AMERICAN SOFTWARE HOUSE	267
36 BAY EXPRESS	361
* CALIFORNIA DIGITAL	377
53 CARIBBEAN MICRO	374
61 COGITATE	360
64 COMPUSAVE	359
68 COMPUTER FRIENDS	274
185 COMPUTER LIBRARY	268
69 COMPUTER MAIL ORDER	314,315
70 COMPUTER PARTS GALORE	361
72 COMPUTER WAREHOUSE	248
73 COMPUTER WAREHOUSE	248
93 DISCOTECH	368
94 DISK WORLD!INC.	358
95 DISKETTE CONNECTION	363
66 DISKMASTER	370
96 DISKS PLUS	288
118 FOCUS ELECTRONICS	154
131 GLOBAL COMPUTER SUPPLIES	361
* HARMONY COMPUTERS	60
149 IC EXPRESS	368
372 INFOTRONICS	334
373 INFOTRONICS	334
159 JADE COMPUTER	382,383
160 JAMECO ELECTRONICS	380,381
162 JDR MICRODEVICES	384,385
163 JDR MICRODEVICES	386,387
164 JDR MICRODEVICES	388,389
400 LOGICSOFT	240A-F
184 LONE STAR SOFTWARE	369
192 MEAD COMPUTER CORP.	375
193 MEGASOFT	360
196 MICRO COM SYSTEMS	54
202 MICROPROCESSORS UNLTD.	364
207 MICROWAY	94
211 MONEYSWORTH	56,57
* ON-LINE STORE	376
234 PC AMERICAN MARKETING	203
236 PC NETWORK	355
237 PC NETWORK	356,357
175 PROGRAMMER'S PARADISE	168,169
256 PROGRAMMER'S SHOP	263
257 PROGRAMMER'S SHOP	265
260 P.D. SIG.	374
262 QSP	327
293 SILICON SPECIALITIES	71
294 SILICON SPECIALITIES	71
298 SOFTLINE CORP.	93
302 SOFTPLUS RESEARCH	358
307 S C S I	170
308 S C S I	170
316 S'NW ELECTR. & APPL.	304
317 S-100 DIV.696 CORP.	362
318 S-100 DIV.696 CORP.	362
325 T & T COMPUTER PRODUCTS	360
324 TIMELINE	378
328 TRI-STATE COMPUTER	354

Inquiry No. Page No.
 344 WAREHOUSE DATA 278
 346 WHOLESALE OUTLET 364

DESKTOP PUBLISHING

2 ADOBE	275
* DAK INDUSTRIES INC.	120,121
127 GENERAL PARAMETRICS	287
128 GENERAL PARAMETRICS	287
* LOTUS DEVELOPMENT	131
295 SOFTCRAFT INC.	247
296 SOFTCRAFT INC.	247
355 XEROX CORP.	50,51
357 Z-SOFT CORPORATION	291
358 Z-SOFT CORPORATION	291

EDUCATIONAL/ INSTRUCTIONAL

4 ACM SIGGRAPH '87	303
* BYTE BACK ISSUES	392
* BYTE CIRCULATION	324
450 BYTE INFO EXCHANGE (BIX)	256
* BYTE MARKETING	322,323
65 COMPUSERVE	220
* COMPUTER BOOK CLUB	337
* DOW JONES NEWS RETRIEVAL	75
* ELECTRONICS MAGAZINE	257
156 INTERFACE GROUP	341
* MACMILLAN BOOK CLUBS	273
* MCGRAW-HILL NRI SCHOOLS	289
* MICROSOFT CORP.	53
231 OSBORNE MCGRAW-HILL	331
360 UPTIME	19

MISCELLANEOUS

* BEST WESTERN	154
63 COMPUTATA TRANSLATORS	370
375 MOORE BUSINESS FORMS	364
283 SAFEWARE	358
* SHARP	295
* TINNEY, ROBERT GRAPHICS	365
354 XEMAG	368

RECRUITMENT

* EDWARDS AIR FORCE BASE	310
--------------------------	-----

* Correspond directly with company.

BYTE READER SERVICE CARD

MAY 1987
475RSU



To receive further information on the products advertised in BYTE, complete the questionnaire and circle the appropriate numbers of the advertisers you select from the list. Add a first-class stamp to the card, then drop it in the mail. Not only do you gain information, but our advertisers are encouraged to use the marketplace provided by BYTE. This helps us bring you a bigger BYTE. The index is provided as an additional service by the publisher, who assumes no liability for errors or omissions.

Name _____
 Title _____
 Company _____
 Address _____
 City _____
 State _____ Zip _____
 Telephone _____

Fill out this coupon carefully. PLEASE PRINT. Requests cannot be honored unless the zip code is included. This card is valid for 6 months from cover date.

1	23	45	67	89	111	133	155	177	199	221	243	265	287	309	331	353	375	397	419	441	463	485	507	529	551	573	595	617	639	661	683	705	727	749	771	793
2	24	46	68	90	112	134	156	178	200	222	244	266	288	310	332	354	376	398	420	442	464	486	508	530	552	574	596	618	640	662	684	706	728	750	772	794
3	25	47	69	91	113	135	157	179	201	223	245	267	289	311	333	355	377	399	421	443	465	487	509	531	553	575	597	619	641	663	685	707	729	751	773	795
4	26	48	70	92	114	136	158	180	202	224	246	268	290	312	334	356	378	400	422	444	466	488	510	532	554	576	598	620	642	664	686	708	730	752	774	796
5	27	49	71	93	115	137	159	181	203	225	247	269	291	313	335	357	379	401	423	445	467	489	511	533	555	577	599	621	643	665	687	709	731	753	775	797
6	28	50	72	94	116	138	160	182	204	226	248	270	292	314	336	358	380	402	424	446	468	490	512	534	556	578	600	622	644	666	688	710	732	754	776	798
7	29	51	73	95	117	139	161	183	205	227	249	271	293	315	337	359	381	403	425	447	469	491	513	535	557	579	601	623	645	667	689	711	733	755	777	799
8	30	52	74	96	118	140	162	184	206	228	250	272	294	316	338	360	382	404	426	448	470	492	514	536	558	580	602	624	646	668	690	712	734	756	778	800
9	31	53	75	97	119	141	163	185	207	229	251	273	295	317	339	361	383	405	427	449	471	493	515	537	559	581	603	625	647	669	691	713	735	757	779	801
10	32	54	76	98	120	142	164	186	208	230	252	274	296	318	340	362	384	406	428	450	472	494	516	538	560	582	604	626	648	670	692	714	736	758	780	802
11	33	55	77	99	121	143	165	187	209	231	253	275	297	319	341	363	385	407	429	451	473	495	517	539	561	583	605	627	649	671	693	715	737	759	781	803
12	34	56	78	100	122	144	166	188	210	232	254	276	298	320	342	364	386	408	430	452	474	496	518	540	562	584	606	628	650	672	694	716	738	760	782	804
13	35	57	79	101	123	145	167	189	211	233	255	277	299	321	343	365	387	409	431	453	475	497	519	541	563	585	607	629	651	673	695	717	739	761	783	805
14	36	58	80	102	124	146	168	190	212	234	256	278	300	322	344	366	388	410	432	454	476	498	520	542	564	586	608	630	652	674	696	718	740	762	784	806
15	37	59	81	103	125	147	169	191	213	235	257	279	301	323	345	367	389	411	433	455	477	499	521	543	565	587	609	631	653	675	697	719	741	763	785	807
16	38	60	82	104	126	148	170	192	214	236	258	280	302	324	346	368	390	412	434	456	478	500	522	544	566	588	610	632	654	676	698	720	742	764	786	808
17	39	61	83	105	127	149	171	193	215	237	259	281	303	325	347	369	391	413	435	457	479	501	523	545	567	589	611	633	655	677	699	721	743	765	787	809
18	40	62	84	106	128	150	172	194	216	238	260	282	304	326	348	370	392	414	436	458	480	502	524	546	568	590	612	634	656	678	700	722	744	766	788	810
19	41	63	85	107	129	151	173	195	217	239	261	283	305	327	349	371	393	415	437	459	481	503	525	547	569	591	613	635	657	679	701	723	745	767	789	811
20	42	64	86	108	130	152	174	196	218	240	262	284	306	328	350	372	394	416	438	460	482	504	526	548	570	592	614	636	658	680	702	724	746	768	790	812
21	43	65	87	109	131	153	175	197	219	241	263	285	307	329	351	373	395	417	439	461	483	505	527	549	571	593	615	637	659	681	703	725	747	769	791	813
22	44	66	88	110	132	154	176	198	220	242	264	286	308	330	352	374	396	418	440	462	484	506	528	550	572	594	616	638	660	682	704	726	748	770	792	814

A. What is your principal occupation? (Please check one only.)

Business Owner
 Manager/Administrator
 Professional (law, medicine, architecture, etc.)
 Computer Programmer/Analyst
 DP/MIS
 Engineer
 Scientist
 Educator/Student
 Other (please specify)

B. How many people does your company employ?

1-49
 50-999
 1,000 or more

C. Information requested for:

Business use
 Personal use
 Both

D. Do you plan to purchase items inquired about within:

Next 3 months?
 Next 6 months?
 Next 12 months?

E. Please check the statement that best describes your involvement in your company's purchasing decisions. (Check all that apply.)

I determine the need
 I evaluate products/systems
 I select/recommend the vendor
 I approve/authorize the purchase

BYTE'S ongoing monitor box (BOMB) lets you rate each article you've read in BYTE as excellent, good, fair, or poor. Each month, you can mail in the BOMB card found at the back of each issue. We tally your votes, total the points, tell you who won, and award the two top-rated nonstaff authors \$100 and \$50, respectively. An additional \$50 award for quality goes to the nonstaff author with the best average score (total points divided by the number of voters). If you prefer, you can use BIX as your method of voting. We welcome your participation.

Article No.*	1	2	3	4	5	6	7	8	9	10	11	12	13	14	15	16	17	18	19	20	21	22	23	24	25
Excellent	1	5	9	13	17	21	25	29	33	37	41	45	49	53	57	61	65	69	73	77	81	85	89	93	97
Good	2	6	10	14	18	22	26	30	34	38	42	46	50	54	58	62	66	70	74	78	82	86	90	94	98
Fair	3	7	11	15	19	23	27	31	35	39	43	47	51	55	59	63	67	71	75	79	83	87	91	95	99
Poor	4	8	12	16	20	24	28	32	36	40	44	48	52	56	60	64	68	72	76	80	84	88	92	96	100

Article No.*	26	27	28	29	30	31	32	33	34	35	36	37	38	39	40	41	42	43	44	45	46	47	48	49	50
Excellent	101	105	109	113	117	121	125	129	133	137	141	145	149	153	157	161	165	169	173	177	181	185	189	193	197
Good	102	106	110	114	118	122	126	130	134	138	142	146	150	154	158	162	166	170	174	178	182	186	190	194	198
Fair	103	107	111	115	119	123	127	131	135	139	143	147	151	155	159	163	167	171	175	179	183	187	191	195	199
Poor	104	108	112	116	120	124	128	132	136	140	144	148	152	156	160	164	168	172	176	180	184	188	192	196	200

* To determine this month's Article No., see BOMB as listed in Table of Contents under Departments.

BYTE READER SERVICE CARD

MAY 1987
475RSU



To receive further information on the products advertised in BYTE, complete the questionnaire and circle the appropriate numbers of the advertisers you select from the list. Add a first-class stamp to the card, then drop it in the mail. Not only do you gain information, but our advertisers are encouraged to use the marketplace provided by BYTE. This helps us bring you a bigger BYTE. The index is provided as an additional service by the publisher, who assumes no liability for errors or omissions.

Name _____
 Title _____
 Company _____
 Address _____
 City _____
 State _____ Zip _____
 Telephone _____

Fill out this coupon carefully. PLEASE PRINT. Requests cannot be honored unless the zip code is included. This card is valid for 6 months from cover date.

1	23	45	67	89	111	133	155	177	199	221	243	265	287	309	331	353	375	397	419	441	463	485	507	529	551	573	595	617	639	661	683	705	727	749	771	793
2	24	46	68	90	112	134	156	178	200	222	244	266	288	310	332	354	376	398	420	442	464	486	508	530	552	574	596	618	640	662	684	706	728	750	772	794
3	25	47	69	91	113	135	157	179	201	223	245	267	289	311	333	355	377	399	421	443	465	487	509	531	553	575	597	619	641	663	685	707	729	751	773	795
4	26	48	70	92	114	136	158	180	202	224	246	268	290	312	334	356	378	400	422	444	466	488	510	532	554	576	598	620	642	664	686	708	730	752	774	796
5	27	49	71	93	115	137	159	181	203	225	247	269	291	313	335	357	379	401	423	445	467	489	511	533	555	577	599	621	643	665	687	709	731	753	775	797
6	28	50	72	94	116	138	160	182	204	226	248	270	292	314	336	358	380	402	424	446	468	490	512	534	556	578	600	622	644	666	688	710	732	754	776	798
7	29	51	73	95	117	139	161	183	205	227	249	271	293	315	337	359	381	403	425	447	469	491	513	535	557	579	601	623	645	667	689	711	733	755	777	799
8	30	52																																		

PLACE
POSTAGE
HERE

BYTE

READER SERVICE
PO Box 298
Dalton, MA 01227-0298
USA

PLACE
POSTAGE
HERE

BYTE

READER SERVICE
PO Box 298
Dalton, MA 01227-0298
USA

OUR NEW PINWRITER XL SERIES BOLDLY GOES WHERE NO OTHER MATRIX PRINTERS HAVE GONE BEFORE.

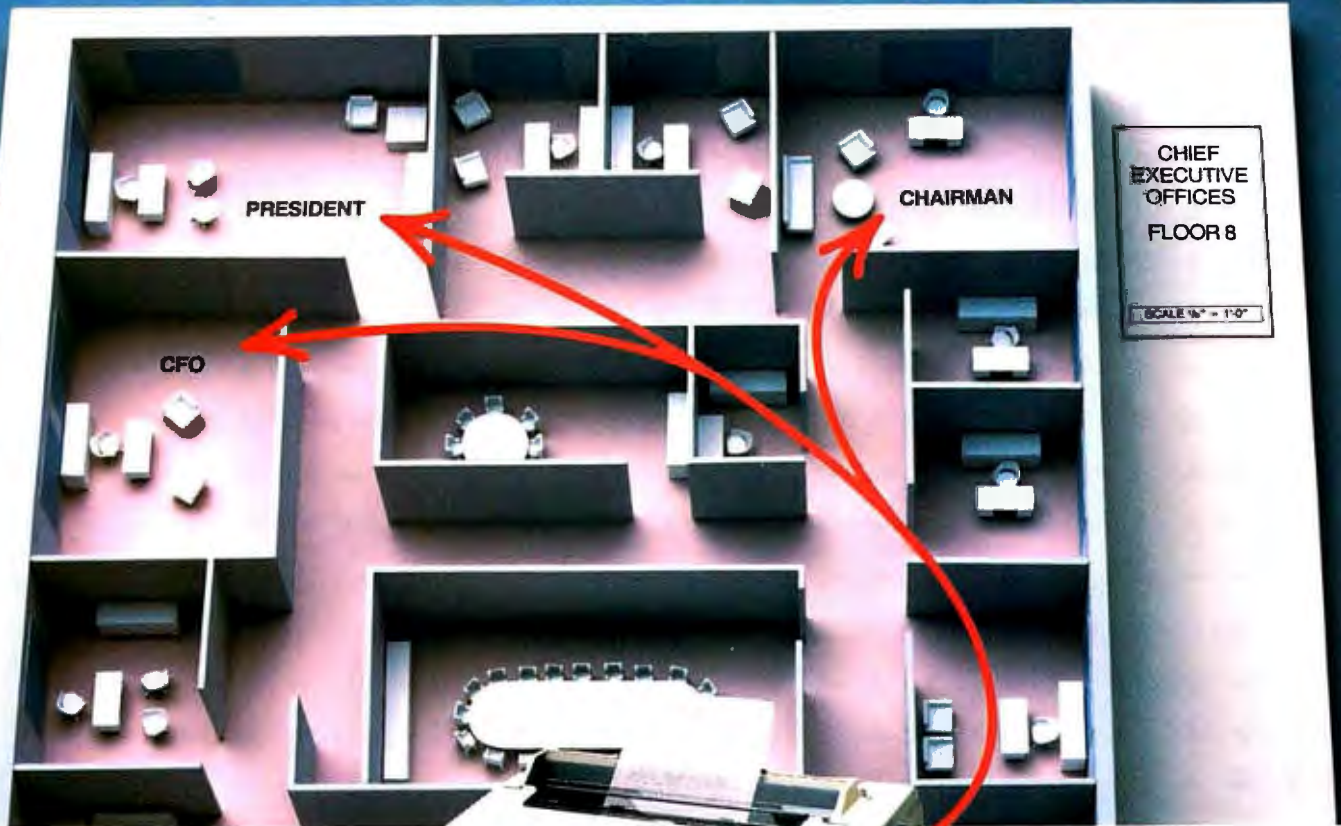

The executive suite. Until now, dot matrix printers just weren't welcome there.

They were too noisy, for one thing. But even more important, they couldn't deliver the quality top executives demand.

But now there's the XL series from NEC. Our Pinwriter® XL series printers have multistrike film ribbons that produce true letter-quality documents—the

kind any executive would be proud to sign. They print in 8 different colors—on paper or transparencies—to make charts, graphs and executive presentations more impressive. And they're the quietest matrix printers you've never heard.

They're also fast. Take our new Pinwriter P9XL, for example. It's over 30% faster than most other printers in its price range, with nearly twice as much memory to handle the



really big jobs—including payroll, invoices, continuous forms, and multi-page reports.

Executives will also be pleased to learn that the Pinwriter XL printers, like all NEC printers, are built to run an average of 5 years before they might need a repair. In fact, they have the highest reliability ratings in the industry.

So make an executive decision. Call 1-800-343-4418 (in MA 617-264-8635) and ask for the name of the NEC dealer nearest you. Or write to NEC Information Systems, Dept. 1610, 1414 Massachusetts Ave., Boxborough, MA 01719.

NEC PRINTERS. THEY ONLY STOP WHEN YOU WANT THEM TO.

Dear Stockholder:

Actual print sample from a Pinwriter P9XL printer.

Next to your computer,



nothing beats a Tandy® printer



IBM® PC compatible

For the best value and selection in top-quality printers, shop your local Radio Shack Computer Center. We've got what you need, whatever your printing requirements.

Versatile business printer

The DMP 2200 (26-1279, \$1695) provides dot-matrix printing at up to 380 characters per second. Efficient, fast printing means no long delays for reports—and that saves your business money. Supports elongated, double-high, bold, underline, super/subscripts, italics, double strike and bit-image graphics.

Customized type styles

Use the Font Editing Packages (sold separately) to load different type styles for print quality that rivals a daisy wheel. In the draft mode, the DMP 2110 (26-2810, \$1295) prints up to 240 characters per second. Includes data-processing, word-processing and graphics modes.

Low-cost business printer

The DMP 430 (26-1277, \$699) features an 18-wire print head and allows a choice of micro, italic and double-high fonts, as well as bit-image graphics. Prints up to 180 characters per second.

Letter-quality daisy-wheel printers

Give your correspondence, reports and memos that clean, crisp "electric-typewriter look." The DWP 520 daisy-wheel printer (26-2800, \$995) produces up to 500 words per minute and supports bold-face, strike-through, double-underline, super and subscripts.

And for letter-quality printing under \$400, the DWP 230 (26-2812, \$399.95) is the clear choice. Prints up to 200 words per minute.

Stop by your local Radio Shack and see our complete selection of printers and accessories today.

TANDY COMPUTERS: In Business . . . for Business™

Prices apply at Radio Shack Computer Centers and participating stores and dealers. IBM/Registered TM International Business Machines Corp.

Radio Shack®

COMPUTER CENTERS

A DIVISION OF TANDY CORPORATION

Inquiry 274