

BYTE

THE SMALL SYSTEMS JOURNAL®

JUNE 1987 VOL.12, NO.6

\$3.50 IN UNITED STATES
\$4.50 IN CANADA / £1.75 IN U.K.
A MCGRAW-HILL PUBLICATION
0360-5280

THEME

Computer-Aided Design



MODEL 80

MODEL 30

MODEL 60

MODEL 50

**The IBM Personal System/2
Microsoft's New DOS**



Eureka: The Solver™

Anyone and everyone who routinely works with equations needs Eureka: The Solver

It solves the most complex equations in seconds. Whether you're a scientist, engineer, financial analyst, student, teacher, or some other professional, you need Eureka: The Solver!

Any problem that can be expressed as a linear or non-linear equation can be solved with Eureka. Algebra, Trigonometry and Calculus problems are a snap.

Eureka: The Solver also handles maximization and minimization problems, does plot functions, generates reports, and saves you an incredible amount of time.

$X + \exp(X) = 10$ solved instantly instead of eventually!

Imagine you have to "solve for X," where $X + \exp(X) = 10$, and you don't have Eureka: The Solver. What you do have is a problem, because it's going to take a lot of time guessing at "X." Maybe your guesses get closer and closer to the right answer, but it's also getting closer and closer to midnight and you're doing it the hard way.

With Eureka: The Solver, there's no guessing, no dancing in the dark—you get the right answer, right now. (PS: $X = 2.0705799$, and Eureka solved that one in .4 of a second!)

How to use Eureka: The Solver

It's easy.

1. Enter your equation into the full-screen editor
2. Select the "Solve" command
3. Look at the answer
4. You're done

You can then tell Eureka to

- Evaluate your solution
- Plot a graph
- Generate a report, then send the output to your printer, disk file or screen
- Or all of the above

Eureka: The Solver includes

- ☑ A full-screen editor
- ☑ Pull-down menus
- ☑ Context-sensitive Help
- ☑ On-screen calculator
- ☑ Automatic 8087 math co-processor chip support
- ☑ Powerful financial functions
- ☑ Built-in and user-defined math and financial functions
- ☑ Ability to generate reports complete with plots and lists
- ☑ Polynomial finder
- ☑ Inequality solutions

*Introductory price—good through July 1, 1987

Some of Eureka's key features

You can key in:

- ☑ A formula or formulas
- ☑ A series of equations—and solve for all variables
- ☑ Constraints (like X has to be $<$ or $=$ 2)
- ☑ A function to plot
- ☑ Unit conversions
- ☑ Maximization and minimization problems
- ☑ Interest Rate/Present Value calculations
- ☑ Variables we call "What happens?," like "What happens if I change this variable to 21 and that variable to 27?"

All this power for only \$99.95!

Equation-solving used to be a mainframe problem, but we've solved that problem.

Eureka: The Solver is all you need—and it's yours for only \$99.95!

That kind of savings you can calculate with your fingers!

System requirements

IBM PC, AT, XT, Portable, 3270 or true compatibles. PC-DOS (MS-DOS) 2.0 and later. 384K.

Only \$99.95!*



BORLAND
INTERNATIONAL

Vive la différence

4585 SCOTTS VALLEY DRIVE
SCOTTS VALLEY, CA 95066
(408) 438-8400 TELEX: 172373
GF15

For the dealer nearest you or to order by phone call

(800)255-8008

in CA (800) 742-1133 in Canada (800) 237-1136

Turbo Prolog™

“ If you're at all interested in artificial intelligence, databases, expert systems, or new ways of thinking about programming, by all means plunk down your \$100 and buy a copy of Turbo Prolog. **Bruce Webster, BYTE 9/86** ”

Only
\$99.95!



Turbo Prolog, the natural language of Artificial Intelligence, is the most popular AI package in the world with more than 100,000 users. It's the 5th-generation computer programming language that brings supercomputer power to your IBM PC and compatibles. You can join the AI revolution with Turbo Prolog for only \$99.95. Step-by-step tutorials, demo programs and source code included.

New! Turbo Prolog Toolbox

Our new Turbo Prolog Toolbox™ enhances Turbo Prolog—with more than 80 tools and over 8,000 lines of source code that can easily be incorporated into your programs. It includes about 40 example programs that show you how to use and incorporate your new tools.

New Turbo Prolog Toolbox features include:

- Business graphic generation
- Complete communications package
- File transfers from Reflex, dBASE III, 1-2-3, Symphony
- A unique parser generator
- Sophisticated user-interface design tools

System requirements

Turbo Prolog: IBM PC, XT, AT or true compatibles. PC-DOS (MS-DOS) 2.0 or later. 384K. Turbo Prolog Toolbox requires Turbo Prolog 1.10 or higher. Dual-floppy disk drive or hard disk. 512K.

It's the complete developer's toolbox and a major addition to Turbo Prolog. You get a wide variety of menus—pull-down, pop-up, line, tree and box—so you can choose the one that suits your application best. You'll quickly and easily learn how to produce graphics; set up communications with remote devices; read information from Reflex,™ dBASE III,™ Lotus 1-2-3™ and Symphony™ files; generate parsers and design user interfaces. All of this for only \$99.95.

Only
\$99.95!



MACINTOSH
VERSION ALSO
AVAILABLE

Turbo Pascal®

The power and high performance of Turbo Pascal is already in the hands of more than half-a-million people. The technically superior Turbo Pascal is the *de facto* worldwide standard and the clear leader.

The Turbo Pascal family includes:

- Turbo Pascal® 3.0
- Turbo Tutor® 2.0
- Turbo Database Toolbox®
- Turbo Editor Toolbox®
- Turbo Graphix Toolbox®
- Turbo GameWorks®
- Turbo Pascal Numerical Methods Toolbox™



Turbo Pascal, the worldwide standard in high-speed compilers, and family.

“ The language deal of the century. **Jeff Duntemann, PC Magazine** ”

New! Turbo Pascal Numerical Methods Toolbox

Only
\$99.95!



What our new Numerical Methods Toolbox will do for you now:

- Find solutions to equations
- Interpolations
- Calculus: numerical derivatives and integrals
- Differential equations
- Matrix operations: inversions, determinants and eigenvalues
- Least squares approximations
- Fourier transforms

As well as a free demo FFT program, you also get Least Squares Fit in 5 different forms:

1. Power
2. Exponential
3. Logarithm
4. 5-term Fourier
5. 5-term Polynomial

They're all ready to compile and run.

All this for only \$99.95!

System requirements

IBM PC, XT, AT or true compatibles. PC-DOS (MS-DOS) 2.0 or later. Turbo Pascal 2.0 or later. Graphics module requires graphics monitor with IBM CGA, IBM EGA, or Hercules compatible adapter card, and requires Turbo Graphix Toolbox. 8087 or 80287 numeric co-processor not required, but recommended for optimal performance. 256K.

Turbo Pascal 3.0.

Includes 8087 & BCD features for 16-bit MS-DOS and CP/M-86 systems. CP/M-80 version minimum memory: 48K; 8087 and BCD features not available. 128K.



Turbo Basic[®]

NOW SHIPPING!

Introducing Turbo Basic, the high-speed BASIC you'd expect from Borland!

It's the BASIC compiler you've been waiting for. And it's so fast that you'll never have to wait again.

Turbo Basic is a complete development environment; it includes a lightning-fast compiler, an interactive editor, and a trace debugging system.

Because Turbo Basic is compatible with BASICA, chances are that you already know how to use Turbo Basic.

With Turbo Basic your only speed is "Full Speed Ahead"!

You probably already know us for both Turbo Pascal[®] and Turbo Prolog.[™] Well, we've done it again!

We created Turbo Basic, because BASIC doesn't have to be slow.

In fact, building fast compilers is a Borland specialty; both our Turbo Pascal and our Turbo Prolog outperform all their rivals by factors, and with Turbo Basic, we're proud to introduce the first high-speed BASIC compiler for the IBM[®]PC. If BASIC taught you how to walk, Turbo Basic will teach you how to run!

Turbo Basic ends the basic confusion

There's now one standard: Turbo Basic.

It's fast, BASICA-compatible, and because Turbo Basic is a Borland product, the price is right, the quality is there, and the power is at your fingertips. You see, Turbo Basic's part of the fast-growing Borland family of programming languages—we call it the "Turbo Family." Hundreds of thousands of users are already using Borland's languages, so you can't go wrong. So join a whole new generation of smart IBM PC users—get your copy of Turbo Basic today. You get an easy-to-read 300+ page manual, two disks, and a free MicroCalc spreadsheet—and an instant start in the fast new world of Turbo Basic. All of this for only \$99.95—Order your copy of Turbo Basic today!

Free spreadsheet included, complete with source code!

Yes, we've included MicroCalc, our sample spreadsheet, complete with source code, so that you can get started right away with a "real program." You can compile and run it "as is," or modify it.

A technical look at Turbo Basic

- ✓ Full recursion supported
- ✓ Standard IEEE floating-point format
- ✓ Floating-point support, with full 8087 (math co-processor) integration. Software emulation if no 8087 present
- ✓ Program size limited only by available memory (no 64K limitation)
- ✓ EGA and CGA support
- ✓ Access to local, static, and global variables
- ✓ Full integration of the compiler, editor, and executable program, with separate windows for editing, messages, tracing, and execution
- ✓ Compile, run-time, and I/O errors place you in the source code where error occurred
- ✓ New long integer (32-bit) data type
- ✓ Full 80-bit precision
- ✓ Pull-down menus
- ✓ Full window management

System requirements

IBM PC, XT, AT and true compatibles, PC-DOS (MS-DOS) 2.0 or later. One floppy drive, 256K.

The Critics' Choice

“ Borland has succeeded in stretching the language without weighing us down with unnecessary details . . . Turbo Basic is the answer to my wish for a simple yet blindingly fast recreational utility language . . . The one language you can't forget how to use, Turbo Basic is a computer language for the missus, the masters, the masses, and me.

Steve Gibson, InfoWorld

Borland's Turbo Basic has advantages over the Microsoft product, including support of the high-speed 8087 math chip.

John C. Dvorak ♪ ♪

Only \$99.95!



NEW

Turbo C[®]

Turbo C: The fastest, most efficient and easy-to-use C compiler at any price

Compilation speed is more than 7000 lines a minute, which makes anything less than Turbo C an exercise in slow motion. Expect what only Borland delivers: Quality, Speed, Power and Price.

Turbo C: The C compiler for amateurs and professionals

If you're just beginning and you've "kinda wanted to learn C," now's your chance to do it the easy way. Like Turbo Pascal, Turbo C's got everything to get you going.

If you're already programming in C, switching to Turbo C will considerably increase your productivity and help make your programs both smaller and faster. Actually, writing in Turbo C is a highly productive and effective method—and we speak from experience. Eureka: The Solver and our new generation of software have been developed using Turbo C.

Turbo C: a complete interactive development environment

Free MicroCalc spreadsheet with source code

Like Turbo Pascal and Turbo Prolog, Turbo C comes

with an interactive editor that will show you syntax errors right in your source code. Developing, debugging, and running a Turbo C program is a snap.

Turbo C: The C compiler everybody's been waiting for. Everybody but the competition

Borland's "Quality, Speed, Power and Price" commitment isn't idle corporate chatter. The \$99.95 price tag on Turbo C isn't a "typo," it's real. So if you'd like to learn C in a hurry, pick up the phone. If you're already using C, switch to Turbo C and see the difference for yourself.

System requirements

IBM PC, XT, AT and true compatibles. PC-DOS (MS-DOS) 2.0 or later. One floppy drive. 320K

Technical Specifications

- ☑ **Compiler:** One-pass compiler generating linkable object modules and inline assembler. Included is Borland's high performance "Turbo Linker." The object module is compatible with the PC-DOS linker. Supports tiny, small, compact, medium, large, and huge memory model libraries. Can mix models with near and far pointers. Includes floating point emulator (utilizes 8087/80287 if installed).
- ☑ **Interactive Editor:** The system includes a powerful, interactive full-screen text editor. If the compiler detects an error, the editor automatically positions the cursor appropriately in the source code.
- ☑ **Development Environment:** A powerful "Make" is included so that managing Turbo C program development is highly efficient. Also includes pull-down menus and windows.
- ☑ **Links with relocatable object modules** created using Borland's Turbo Prolog into a single program.
- ☑ **ANSI C compatible.**
- ☑ **Start-up routine source code included.**
- ☑ **Both command line and integrated environment versions included.**

*Introductory price—good through July 1, 1987

Sieve benchmark (25 iterations)

	Turbo C	Microsoft [®] C	Lattice C
Compile time	3.89	16.37	13.90
Compile and link time	9.94	29.06	27.79
Execution time	5.77	9.51	13.79
Object code size	274	297	301
Price	\$99.95	\$450.00	\$500.00

Benchmark run on a 6 Mhz IBM AT using Turbo C version 1.0 and the Turbo Linker version 1.0; Microsoft C version 4.0 and the MS overlay linker version 3.51; Lattice C version 3.1 and the MS object linker version 3.05.

All Borland products are trademarks or registered trademarks of Borland International, Inc. or Borland Analytica, Inc. Other brand and product names are trademarks or registered trademarks of their respective holders. Copyright 1987 Borland International BI-1103A

Only \$99.95!*

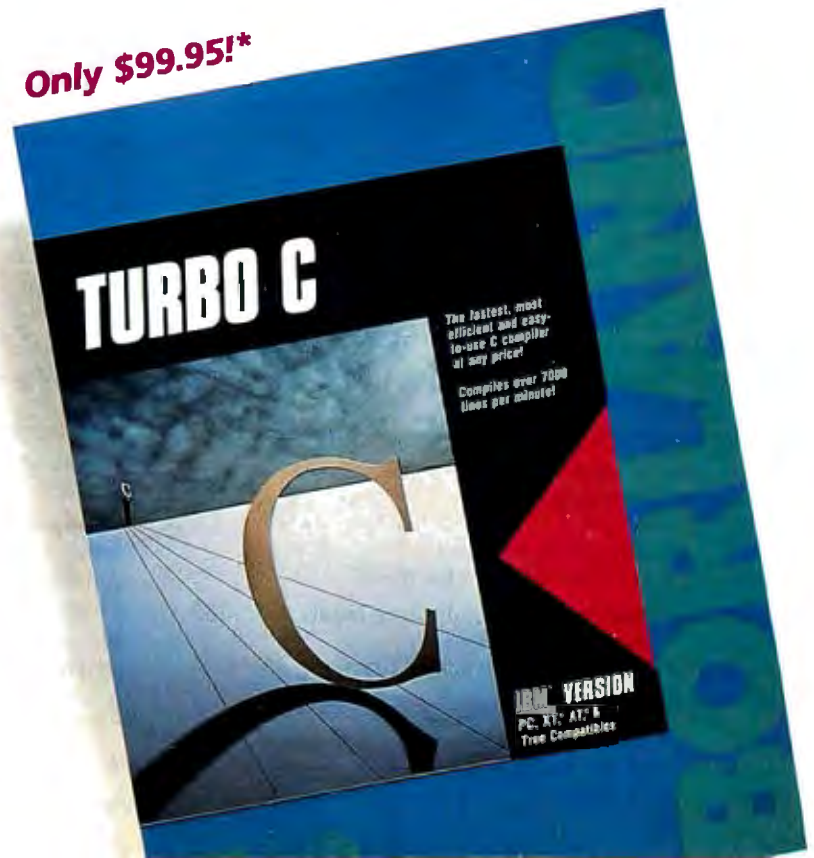

For the dealer nearest you, or to order by phone
call (800) 255-8008
 CA (800) 742-1133
 Canada (800) 237-1136

Inquiry 373 for End-Users.
 Inquiry 374 for DEALERS ONLY.



Features/99

Contents

FEATURES

- First Impressions:
The IBM PS/2 Computers** 100
by the BYTE Editorial Staff
The Personal System/2—including a 32/16-bit bus, new operating systems, and new graphics systems—redefines IBM's microcomputer standards.



**The PS/2 Model 80:
IBM's first 80386-based computer.**

- Product Description:
Microsoft's New DOS** 116
by Eva White and Richard Grehan
With OS/2, Microsoft makes a break for the future while remaining true to the past.
- Ciarcia's Circuit Cellar:
Build a Gray-Scale Video Digitizer, Part 2** 129
by Steve Ciarcia
An imaging system with remarkable features for the price.
- Programming Project:
A Contouring Subroutine** 143
by Paul D. Bourke
Use this BASIC program to represent any three-dimensional surface on a flat plane.
- Programming Insight: Polynomial Curve Fitter** 155
by William G. Hood
This BASIC program finds a polynomial function to fit a set of data points.

- 68000 Machines: Atari 520ST Projects** 161
by Tim G. Hunkler
An interface board for the Atari ST cartridge port.

THEME: Computer-Aided Design

- Introduction** 173
- Data Structures in CAD Software** 177
by Larry Pfortmiller
A description of image types and their computer representation.
- The CADcompiler** 187
by Arthur W. Crooke
A logic design tool with a twist.
- Computer-Aided Routing of Printed Circuit Boards** 199
by Stephen E. Belter
An examination of Lee's Algorithm and possible improvements.
- IGES** 209
by Ralph J. Mayer
One answer to the problems of CAD database exchange.
- CAD for Building Chips** 217
by Steve Trimberger and Jim Rowson
Silicon compilers and the automated building of VLSI circuits.

REVIEWS

- Reviewer's Notebook** 227
by Cathryn Baskin
- Beyond Turbo** 229
by Wayne Rash Jr.
Two 12-MHz machines from PC's Limited and Wells American.
- Turbo-Amiga** 235
by Warren Block
An Amiga peripheral that's more like a high-performance clone.
- Pick of the Litter** 238
by William H. Murray and Chris H. Pappas
An overview of eight computer mice.

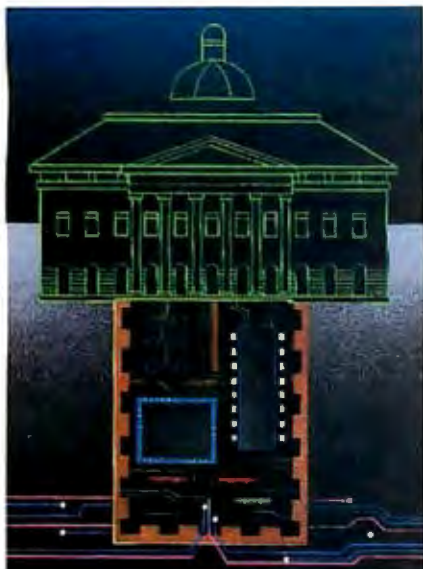

Themes/173

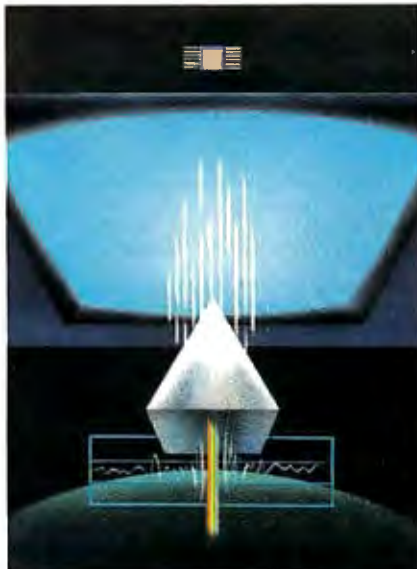

Reviews/225



Kernel/279

Four C Language Interpreters	245
<i>by John Unger</i>	
Run/C, Run/C Professional, C-terp, and Instant-C.	
Microsoft Windows Software Development Kit	250
<i>by David and Lee Hart</i>	
Pull-down menus, multitasking, device independence, and more.	
Smalltalk/V Release 1.2	256
<i>by Mat Davis</i>	
Inexpensive object-oriented programming for the IBM PC and compatibles.	
Acquaint	265
<i>by Ernest R. Tello</i>	
A frame-based, knowledge-development system and expert-system tool.	
Zoomracks II	272
<i>by Tyler Sperry</i>	
This text-database manager features a unique visual interface.	

KERNEL

Computing at Chaos Manor:	
Puttering with Yin and Yang	281
<i>by Jerry Pournelle</i>	
Short-shrift time prompts a look at several products.	
According to Webster: Processor Wars	297
<i>by Bruce Webster</i>	
Bruce considers the new Macs, the Access 386, and Professional Pascal.	
Focus on Algorithms: Run-Length Encoding	317
<i>by Dick Pountain</i>	
This column premieres with a look at the simplest algorithm for compressing data.	
Applications Only: AI, AI, Oh!	321
<i>by Ezra Shapiro</i>	
VP-Expert is an inexpensive expert-system program that actually works.	

DEPARTMENTS

Editorial: Liberation and Fragmentation	6	Circuit Cellar Feedback	74
Letters and Review Feedback	16	Book Reviews	81
Chaos Manor Mail	32	BOMB and Coming Up in BYTE	378
Microbytes	37	Editorial Index by company	379
What's New	45	Reader Service	381
Events and Clubs	65		
Ask Byte	68		

BEST OF BIX

Macintosh	325	Amiga	334
Atari ST	332		

LISTINGS

From BIX	337
From BYTEnet	(617) 861-9764
On Disk or in print	see card before 321



BYTE (ISSN 0360-5280) is published monthly with additional issues in June and October by McGraw-Hill Inc. Founder: James H. McGraw (1860-1948). Executive, editorial, circulation, and advertising offices: One Phoenix Mill Lane, Peterborough, NH 03458, phone (603) 924-9281. Office hours: Monday through Thursday 8:30 AM—4:30 PM, Friday 8:30 AM—1:00 PM, Eastern Time. Address subscriptions to BYTE Subscriptions, P.O. Box 590, Martinsville, NJ 08836. Postmaster: send address changes. USPS Form 3579, undeliverable copies, and fulfillment questions to BYTE Subscriptions, P.O. Box 596, Martinsville, NJ 08836. Second-class postage paid at Peterborough, NH 03458 and additional mailing offices. Postage paid at Winnipeg, Manitoba. Registration number 9321. Subscriptions are \$22 for one year \$40 for two years, and \$58 for three years in the U.S. and its possessions. In Canada and Mexico, \$25 for one year, \$45 for two years, \$65 for three years. \$69 for one year air delivery to Europe. 31,000 yen for one year air delivery to Japan, 15,600 yen for one year surface delivery to Japan, \$37 surface delivery elsewhere. Air delivery to selected areas at additional rates upon request. Single copy price is \$3.50 in the U.S. and its possessions, \$4.25 in Canada and Mexico, \$4.50 in Europe, and \$5 elsewhere. Foreign subscriptions and sales should be remitted in U.S. funds drawn on a U.S. bank. Please allow six to eight weeks for delivery of first issue. Printed in the United States of America.

Address editorial correspondence to: Editor, BYTE, One Phoenix Mill Lane, Peterborough, NH 03458. Unacceptable manuscripts will be returned if accompanied by sufficient postage. Note responsible for lost manuscripts or photos. Opinions expressed by the authors are not necessarily those of BYTE.

Copyright © 1987 by McGraw-Hill Inc. All rights reserved. Trademark registered in the United States Patent and Trademark Office. Where necessary, permission is granted by the copyright owner for libraries and others registered with the Copyright Clearance Center (CCC) to photocopy any article herein for the flat fee of \$1.50 per copy of the article or any part thereof. Correspondence and payment should be sent directly to the CCC, 29 Congress St., Salem, MA 01970. Specify ISSN 0360-5280/83, \$1.50. Copying done for other than personal or internal reference use without the permission of McGraw-Hill Inc. is prohibited. Requests for special permission or bulk orders should be addressed to the publisher. BYTE is available in microform from University Microfilms International, 300 North Zeeb Rd., Dept. PR, Ann Arbor, MI 48106 or 18 Bedford Row, Dept. PR, London WC1R 4EJ, England.

Subscription questions or problems should be addressed to: BYTE Subscriber Service, P.O. Box 328, Hancock, NH 03449

EXECUTIVE EDITOR, BYTE
Frederic S. Langa

ASSISTANT MANAGING EDITOR

Glenn Hartwig

CONSULTING EDITORS

Steve Ciarcia
Jerry Pournelle
Ezra Shapiro
Bruce Webster

SENIOR TECHNICAL EDITORS

Cathryn Baskin, Reviews
G. Michael Vose, Themes
Gregg Williams, Features

TECHNICAL EDITORS

Dennis Allen
Richard Grehan
Ken Sheldon
George A. Stewart
Jane Morrill Tazelaar
Tom Thompson
Charles D. Weston
Eva White
Stanley Wszola

ASSOCIATE TECHNICAL EDITORS

Curtis Franklin Jr.
Margaret Cook Gurney, Book Reviews

COPY EDITORS

Lauren Stickler, Copy Administrator
Judy Connors-Tenny
Jeff Edmonds
Nancy Hayes
Cathy Kingery
Margaret A. Richard
Warren Williamson

ASSISTANTS

Peggy Dunham, Office Manager
Martha Hicks
L. Ryan McCombs
June N. Sheldon

NEWS AND TECHNOLOGY

Gene Smarte, Bureau Chief, Costa Mesa
Jonathan Erickson, Senior Technical Editor,
San Francisco
Rich Malloy, Senior Technical Editor, New York
Cindy Kiddoo, Editorial Assistant, San Francisco

ASSOCIATE NEWS EDITORS

Nicholas Baran, Microbytes
Dennis Barker, Microbytes
Anne Fischer Lent, What's New
Stan Miastkowski, What's New, Best of BIX

CONTRIBUTING EDITORS

Jonathan Amsterdam, programming projects
Mark Dahmke, video, operating systems
Mark Haas, at large
Rik Jadrnicek, CAD, graphics, spreadsheets
Robert T. Kurosaka, mathematical recreations
Alastair J. W. Mayer, software
Alan R. Miller, languages and engineering
Dick Pountain, U.K.
Roger Powell, computers and music
Phillip Robinson, semiconductors
Jon Shiell, high-performance systems

ART

Nancy Rice, Art Director
Joseph A. Gallagher, Assistant Art Director
Jan Muller, Art Assistant
Alan Easton, Drafting

PRODUCTION

David R. Anderson, Production Director
Denise Chartrand
Michael J. Lonsky
Virginia Reardon

TYPOGRAPHY

Sherry McCarthy, Chief Typographer
Selinda Chiquoine
Donna Sweeney

EXECUTIVE EDITOR, BIX
George Bond

SENIOR EDITOR

David Betz

ASSOCIATE EDITORS

Tony Lockwood
Donna Osgood, San Francisco

MICROBYTES DAILY

Dennis Barker, Coordinator, Peterborough
Gene Smarte, Bureau Chief, Costa Mesa
Nicholas Baran, San Francisco
Rick Cook, Phoenix

Jonathan Erickson, San Francisco

Martha Hicks, Peterborough

Anne Fischer Lent, Peterborough

Larry Loeb, Wallingford, CT

Rich Malloy, New York

Brock N. Meeks, La Mesa, CA

Jeff Merron, Peterborough

Stan Miastkowski, Peterborough

Lynne Nadeau, Peterborough

Wayne Rash, Washington, DC

William Webb, Peterborough

GROUP MODERATORS

David Allen, Applications

Frank Boosman, Artificial Intelligence

Leroy Casterline, Other

Marc Greenfield, Programming Languages

Jim Howard, Graphics

Gary Kendall, Operating Systems

Steve Krenek, Computers

Brock N. Meeks, Telecommunications

Barry Nance, New Technology

Donald Osgood, Computers

Sue Rosenberg, Other

Jon Swanson, Chips

BUSINESS AND MARKETING

Doug Webster, Director (603-924-9027)

Patricia Bausum, Secretary

Denise A. Greene, Customer Service

Brian Warnock, Customer Service

Tammy Burgess, Customer Credit and Billing

TECHNOLOGY

Clayton Lisle, Director, Business Systems Technology, MHIS

Bill Garrison, Business Systems Analyst

Jack Reilly, Business Systems Analyst

ADVERTISING SALES

Dennis J. Riley, Director of Sales and Marketing
Sandra Foster, Administrative Assistant

ADVERTISING/PRODUCTION (603-924-6448)

Lisa Wozmak, Supervisor
Lyda Clark, Senior Account Coordinator
Marion Carlson
Virginia Carpenter
Karen Cilley
Brian Higgins
Wai Chiu Li, Quality Control Manager
Julie Murphree, Advertising/Production
Coordinator

MARKETING COMMUNICATIONS

Horace T. Howland, Director (603-924-3424)
Vicki Reynolds, Promotion Manager
Lisa Jo Steiner, Marketing Assistant
Stephanie Warnesky, Marketing Art Director
Sharon Price, Associate Art Director
Julie Perron, Market Research Analyst
Cynthia Damato Sands, Reader Service
Coordinator

TELEMARKETING

L. Bradley Browne, Director
Susan Boyd, Administrative Assistant

PLANNING AND RESEARCH

Michele Perron, Director
Faith Kluntz, Copyrights Coordinator

FINANCIAL SERVICES

Philip L. Penny, Director of Finance and Services
Kenneth A. King, Business Manager
Christine Lee, Assistant
Linda Short, D/P Manager
Marilyn Haigh
Diane Henry
Vern Rockwell
Lisa Teates
JoAnn Walter

PUBLISHER'S ASSISTANT

Beverly Jackson

CIRCULATION (800-423-8912)

Dan McLaughlin, Director
James Bingham, Single-Copy Sales Manager
Vicki Weston, Assistant Manager
Claudette Carswell, Distribution Coordinator
Karen Desroches, Direct Accounts
Louise Menegus, Back Issues

PERSONNEL

Cheryl Hurd, Office Manager
Patricia Burke, Personnel Coordinator

BUILDING SERVICES/TRAFFIC

Anthony Bennett, Building Services Manager
Mark Monkton, Assistant
Agnes E. Perry, Traffic Assistant

RECEPTIONIST

Donna Healy



Officers of McGraw-Hill Information Systems Company: President: Richard B. Miller. Executive Vice Presidents: Frederick P. Jannott, Construction Information Group; Russell C. White, Computers and Communications Information Group; J. Thomas Ryan, Marketing and International. Senior Vice Presidents-Publishers: Laurence Altman, Electronics; Harry L. Brown, BYTE; David J. McGrath, Engineering News-Record. Group Vice Presidents: Frank A. Shinal, Dodge; Peter B. McCuen, Communications Information. Vice Presidents: Robert D. Daleo, Controller; Fred Q. Jensen, Planning and Development; Michael J. Koeller, Human Resources; Talat M. Sadiq, Systems Planning and Technology.

Officers of McGraw-Hill, Inc.: Harold W. McGraw, Jr., Chairman; Joseph L. Dionne, President and Chief Executive Officer; Robert N. Landes, Executive Vice President and Secretary; Walter D. Serwatka, Executive Vice President and Chief Financial Officer; Shel F. Asen, Senior Vice President, Manufacturing; Robert J. Bahash, Senior Vice President, Finance and Manufacturing; Ralph R. Schulz, Senior Vice President, Editorial; George R. Elsinger, Vice President, Circulation; Ralph J. Webb, Vice President and Treasurer.

BYTE, BITE, and The Small Systems Journal are registered trademarks of McGraw-Hill Inc.

EDITORIAL AND BUSINESS OFFICE:

One Phoenix Mill Lane, Peterborough, New Hampshire 03458, (603) 924-9281.

West Coast Offices: 425 Batte y St., San Francisco, CA 94111, (415) 954-9718; 3001 Red Hill Ave., Building #1, Suite 222, Costa Mesa, CA 92626, (714) 557-6292. **New York Editorial Office:** 1221 Avenue of the Americas, New York, NY 10020, (212) 512-3175.

BYTenet: (617) 861-9764 (set modem at 8-1-N or 7-1-E; 300 or 1200 baud).

smARTWORK® Keeps Getting Smarter



Smarter Artwork

Three years ago, Wintek engineers created smARTWORK to reduce the time and tedium of laying out their own printed-circuit boards. Thousands of engineers have since discovered the ease of use and sophistication that makes smARTWORK the most popular PCB CAD software available. And thanks to them, smARTWORK keeps getting better.



smARTWORK transforms your IBM PC into a PCB CAD system

Interactive routing, continual design-rule checking, pad shaving, and production-quality 2X artwork have always been a part of smARTWORK. And now that many customer suggestions have become a part of the software, smARTWORK is an even better value. *That's why we offer it with a thirty-day money-back no-nonsense guarantee.*



Using an Epson or IBM dot-matrix printer, you can create 2X artwork and 1X or 2X checkplots in a fraction of the time hand-taping requires

New smARTWORK Features

- Silkscreen layer for component placement and identification
- Text capabilities for all three layers
- Selectable trace widths and pad shapes and sizes
- User-definable library
- Ground planes created with a single command
- Solder-mask and padmaster plots generated automatically
- Quick printer 2X checkplots
- Additional drivers for printers and plotters
 - Optional drill-tape and Gerber photoplotter utilities
 - AutoCAD® .DXF file output
 - Completely updated manual
 - 800 number for free technical assistance

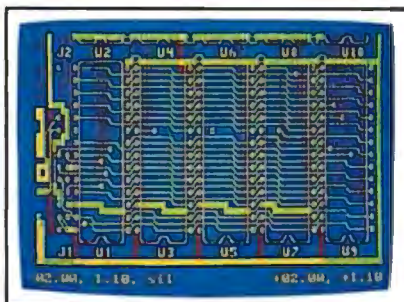

2" by 4" section of a 10" by 16" double-sided board with silkscreen layer

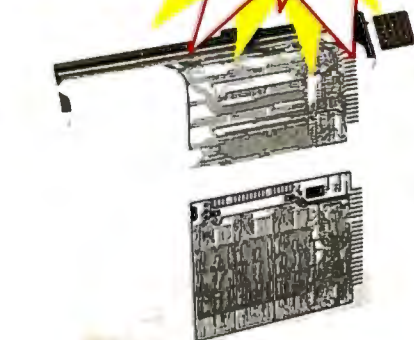

Camera-ready 2X artwork from an HI or HP pen plotter

The Smart Buy. Guaranteed.

Still priced at \$895, smARTWORK is proven, convenient, and fast. Our money-back guarantee lets you try smARTWORK for 30 days at absolutely no risk. Call toll free (800) 742-6809 today and put smARTWORK to work for you tomorrow. That's smart work.

System Requirements

- IBM PC, PC XT, or PC AT with 384K RAM, and DOS V2.0 or later
- IBM Color/Graphics Adapter with RGB color or B&W monitor
- IBM Graphics Printer or Epson FX/MX/RX-series printer, and/or
- Houston Instrument DMP-40, 41, 42, 51, 52, or Hewlett-Packard 7470, 7475, 7550, 7580, 7585, 7586 pen plotter
- Optional Microsoft Mouse

Wintek Corporation
1801 South St.
Lafayette, IN 47904
Telephone: (800) 742-6809
In Indiana: (317) 742-8428
Telex: 70-9079 WINTEK CORP UD



"smARTWORK", "Wintek", and the Wintek logo are registered trademarks of Wintek Corporation. "AutoCAD" is a registered trademark of Autodesk, Inc.

Current Versions	
HWIRE	V1.0r2
smARTWORK	V1.3r0

EDITORIAL

Liberation and Fragmentation

IBM's long-awaited new Personal System/2 computers have at last arrived, and with them the promise of OS/2, the operating system jointly developed by Microsoft and IBM. Our rush article about the new IBM systems appears in this issue on page 100. Rick Grehan and Eva White offer a more detailed overview of OS/2 in this issue on page 116. Rather than repeating the particulars of the IBM announcements here, I will describe some salient points and look at the effects of IBM's and other recent announcements on the industry and the user community.

Contrary to many predictions, IBM did introduce an 80386 machine, the Model 80, and it will be available in July 1987 rather than in 1988. Furthermore, the Model 80 has a new high-performance 32-bit bus called Micro Channel. Its slots can handle both memory and I/O, and its design includes support for multiple processors. The Model 80 gives IBM an outstanding foundation for its personal computers for the next 5 to 10 years. Models 50 and 60, which are 10-megahertz 80286 machines with a 16-bit Micro Channel that is a subset of the 32-bit bus, join the Model 80 in having the new VGA 640 by 480 graphics as standard equipment. Models 50, 60, and 80 all have convenient high-capacity 1.44-megabyte microfloppies as standard equipment. These three models together define the new hardware standard.

The wonderful news about systems software is the announcement of OS/2, which finally will liberate users and developers from the 640K-byte memory-addressing limitation that has deprived IBM-compatible computing of goodies like the graphical user interfaces on the Macintosh, the Atari ST, and the Amiga. OS/2 will give software developers 16 megabytes of 64K-byte segments—not the ideal linear address space, but a big improvement. The IBM world should now have the means to support a graphical user interface.

But there is also some bad news regarding new systems software. Microsoft had been preparing us to accept the late arrival of OS/2, but it comes as a shock that the new Presentation Manager will not be available with the standard release of OS/2 in early 1988. While developers will get OS/2 kits in August, the kit won't

include support for the Presentation Manager until late this year.

Together with Apple's announcement of the Macintosh II and SE, the IBM announcement reshapes the marketplace. Both Apple and IBM now offer users and software developers outstanding foundation machines for the years ahead. The Macintosh II uses the 68020, and the Personal System/2 Model 80 uses the 80386, which can address memory as a large linear space. That feature of the 80386 offers real liberation from the memory management constraints of previous Intel processors. Apple's Macintosh II uses the standard 32-bit NuBus, while IBM's Model 80 uses the 32-bit Micro Channel.

Four Major Fragments, with More Possible

Where does all this leave us? For software developers and users alike, the personal computer market has now split into four major fragments: MS-DOS, OS/2, Macintosh, and Unix. And further fragmentation is possible. MS-DOS dominates now, but it will be supplanted in the long term. OS/2 is the obvious new target for major development projects—but work can't start on anything that uses the Presentation Manager until late 1987. Since the Presentation Manager is to be the standard user interface for OS/2, applications software for OS/2 will be very late.

Today—and for at least the next year—both Macintosh and Unix will have much larger installed bases than OS/2. The installed base of Macintoshes has been growing rapidly since the introduction of the Macintosh Plus, with the SE and the Macintosh II sure to increase the pace of growth. And the Macintosh systems software, including the graphical user interface, is not only well defined but also friendly and familiar. There is a rich collection of applications software that exploits the Macintosh user interface. For those who must run PC applications, there is an XT card for the Macintosh SE and an AT card for the Macintosh II. Indeed, a Macintosh II with the AST 80286 card costs less than a Personal System/2 Model 80 with floating-point processor and comparable mass storage and display. Apple continues to work on a multitasking version of the Macintosh operating system. Apple's challenge is to introduce multitasking before the arrival

of OS/2, which also provides multitasking.

The installed base of Unix has also grown, although more gradually than that of the Macintosh, and may now be sufficient to drive the development of an attractive assortment of applications software. Consider this also: Unix will run on the IBM Personal System/2 Model 80, the Macintosh II, the IBM PC RT, Sun and Apollo workstations, and many supermicrocomputers and minicomputers. Since Unix supports multitasking, and through the new X-Window standard will support a windowing environment, Unix offers now some of the future attractions of OS/2. And the infamous overhead of Unix is not much greater than the overhead associated with OS/2. Unix with a DOS emulator to run old PC software could win new friends. Some software developers will find that Unix is now the easiest single path to the greatest variety of high-end hardware.

There is the possibility of still further fragmentation of the market. IBM will offer sometime in 1988 an extended version of OS/2. This version will include a relational database compatible with IBM mainframe databases and a wealth of communications support for links with large IBM systems. OS/2 Extended Version seems to be IBM's strategy for providing integration from the largest systems to the smallest in large corporations. OS/2 Extended Version may represent for some developers the most attractive part of the market. Also, we can't entirely rule out the entrance of a new 80386 operating system on the scene.

Critical Choices

The age of the commodity computer is passing. If you want to do a major computing task on a small computer, you face a rich range of choices. Things are getting much better—but no easier.

The best news of all is that both IBM and Apple have now shown outstanding new architectures that can carry us far into the future. Starting in July, we will devote regular coverage to next-generation computing that focuses on 80386 and 68020 systems. We will compare and contrast the new systems as quickly as we can get our hands on them.

—Phil Lemmons
Editor in Chief

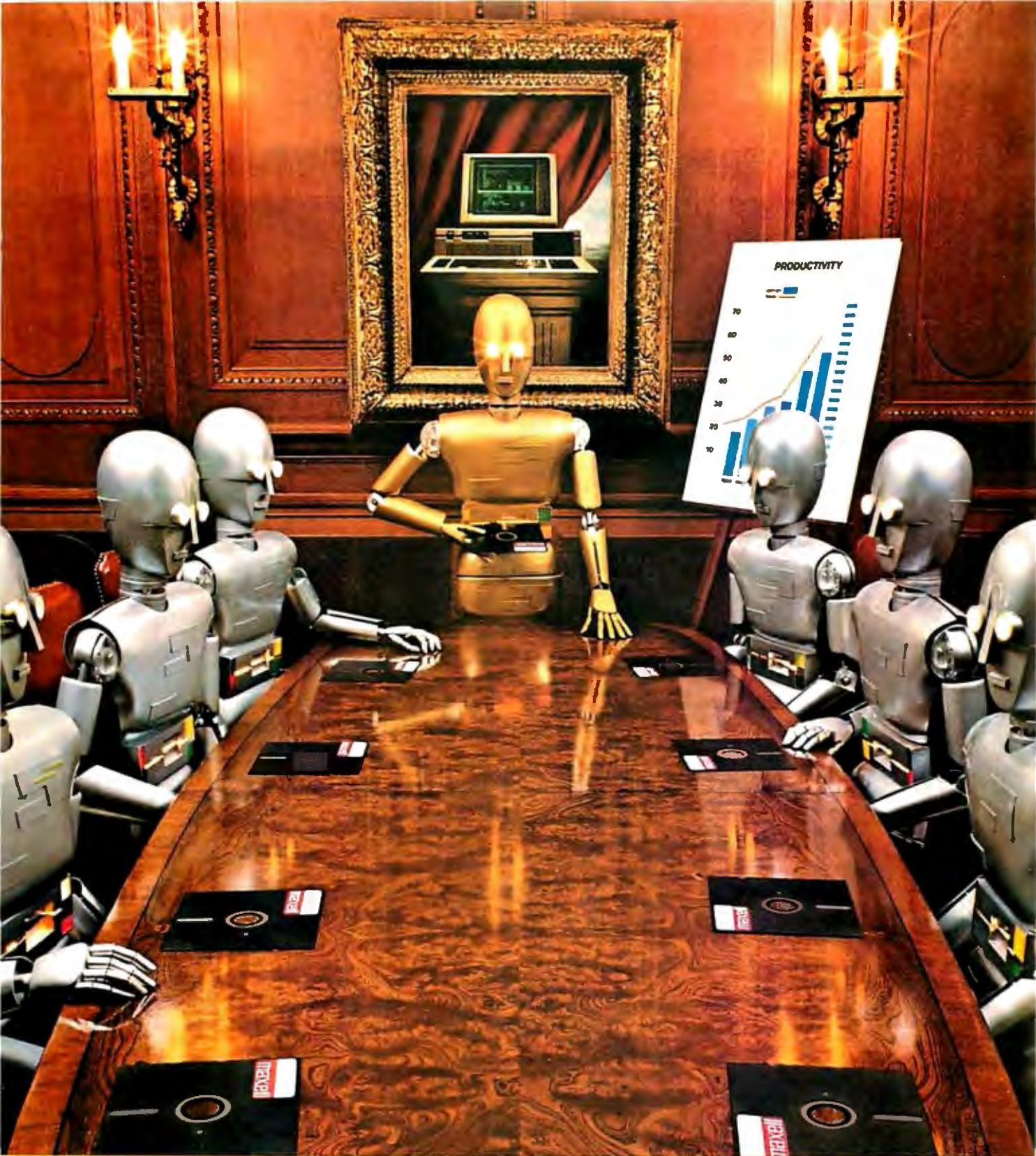

When computers get down to business, they move up to Maxell.

Maxell is ready when you are with the newest technology in magnetic media. A perfect example is this double-sided 3½" microdisk.



maxell.
THE GOLD STANDARD

THE MAKERS OF VTERM/220 ARE PLEASED TO ANNOUNCE THE FOLLOWING COMPANIES HAVE CHOSEN OUR DEC TERMINAL EMULATION SOFTWARE.



Among our largest customers are ~~General Electric, Westinghouse, Bankers Trust, Lotus Development Corp~~ And the ~~IBM Department of Technology~~.

Big institutions can be very close-mouthed about the competitive edge they get from a powerful tool like VTERM/220. So while they'd prefer that we not name names, we can still tell you the reasons why we have more satisfied users than all our competition combined.

First of all, giant institutions don't stay giant by being sloppy. They spec things down to a gnat's eyebrow. That's why we're proud to say that VTERM's biggest fans are large corporate, scientific and government installations that perform very serious evaluations of communications software. They give VTERM the highest praise for accuracy of emulation, ease of use, multiplicity of features, speed of execution, and just plain quality.

Just look at VTERM/220's outstanding features:

- Plug compatible VT220 and VT100 video and keyboard emulation with customizable key mappings.
- Powerful file transfer including the most thorough implementation of KERMIT available on the PC, plus XMODEM, and our proprietary protocol VTRANS with complete host-side software for VMS,™ RSTS/E,™ RSX11 M/M+™ and UNIX.™
- Host data capture and conversion to Lotus® 1-2-3,® Symphony® and dBase®
- 132-column display via horizontal scrolling or optional video board.
- Scrollback buffer for redisplay of up to 2,000 lines (eighty screens!).
- "Hot Key" toggle between host session and PC DOS.
- Programmable softkeys with script-like capabilities.
- Full support for multinational

and national character sets.

VTERM/220 is not the only thing we have to talk about. There's also our VT100 emulator VTERM III, and our Tektronix™ 4010/4014 graphics emulator, VTERM/4010. Both of these VTERM's have a lot of the power of VTERM/220, including file transfer.

So if you're looking for terrific terminal emulation programs for your IBM PC or other compatible computers, you and 50,000 other users have found it at Coefficient. We're the leader in DEC Emulation Software. Just ask AT & oops.

Call us today at
212-777-6707 ext. 408.

Coefficient

Coefficient Systems Corporation
611 Broadway, New York, N.Y. 10012



Every year millions of computers, VCR's and TV's blow their brains out.

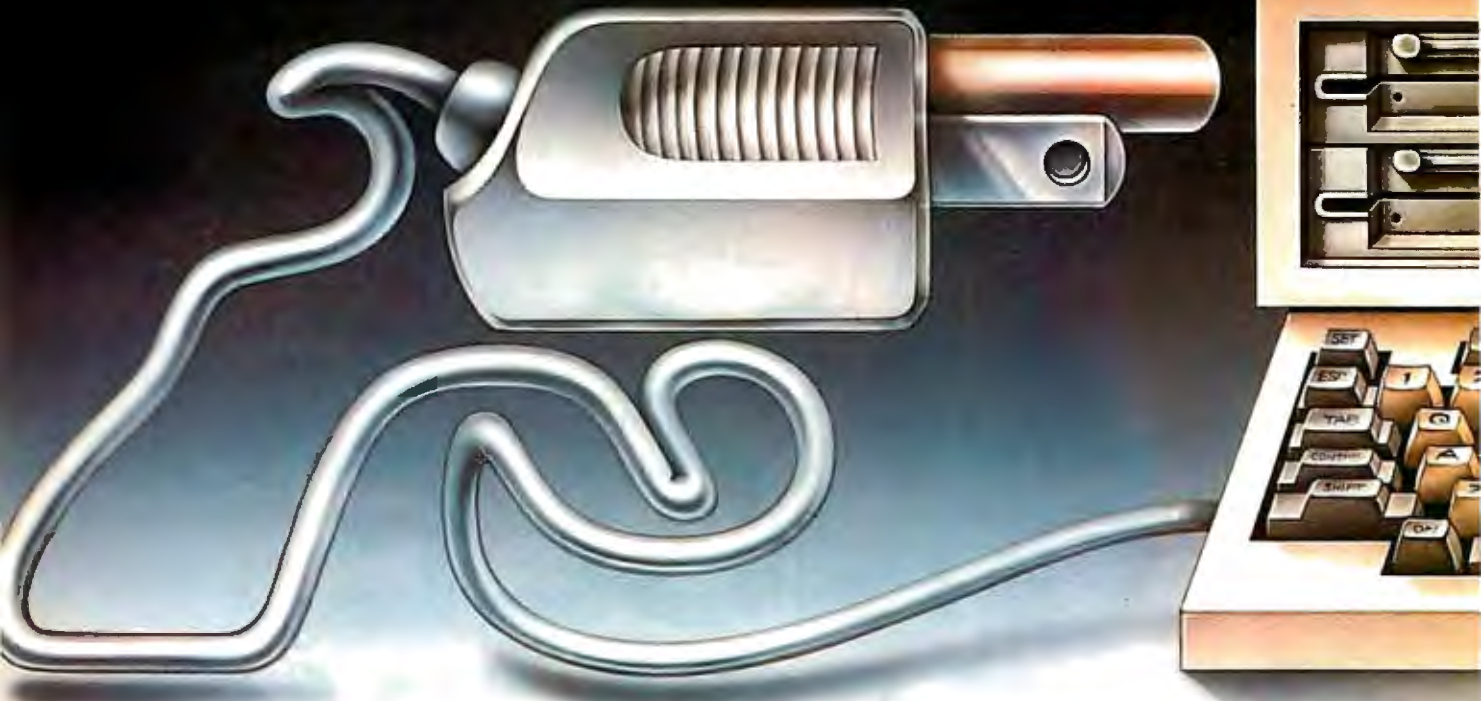

The utility company sends too much power through a critical junction. A major appliance is switched off and creates a power surge. Or a bolt of lightning explodes into your power line.

Electrical overloads that ultimately make their way to your delicate electronics. Erasing memory and data. Frying sensitive circuitry. And causing nearly 80% of all service calls.

Unless you're plugged into a Network[®] electronic protector.

With fast-acting power conditioning circuitry, Network electronic protectors "clamp" surges, spikes and static overloads before they reach your system. Preserving memory, data,

circuitry and peace of mind.

No matter if you're protecting a PC system, stereo, TV, VCR or microwave oven, Network makes an electronic protector for your product. Even versions with built-in phone line protection for modems, answering machines and telecommunications equipment.

Find out about which one is right for you and where to get it. Call Network toll free at 1-800-522-2222, and get the best in protection for high-tech hardware. Before your power cord turns into its own worst enemy.



Network is a registered trademark of Dialight Corp., A North American Philips Company.

Inquiry 207

See us at Comdex/Atlanta
June 1-4 Booth #2348

NETWORK[®]

Computer and Electronic Accessories

We keep it all working.

1913 Atlantic Ave., Manasquan, NJ 08736

JUNE 1987 • B Y T E 9

When you buy a terminal or monitor for your American PC, you want a low price, but not something foreign. You want American quality. American specs. An American look and feel.

Which really means you want the kind Uncle Samsung makes.

Because Samsung has been making them that way in Korea since 1979. For some of America's largest PC manufacturers. So they're already as familiar as the 4th of July.

But now you can buy Samsung terminals and monitors with Samsung's name on them. And save yourself plenty of Yankee dollars.

Our 12" and 14" terminals emulate all of America's most popular models. Our monitors do too, and come in a range of cabinet styles.

And our stateside group, Samsung Electron Devices, has an American design team on staff to answer queries and help OEMs with custom designs. Just call (213) 404-1835.

Meanwhile, our perfected manufacturing techniques keep the costs down. And our automated, robotic, assembly lines turn out everything from CRTs to terminals to computers. All to U.S. standards.

So there's no reason to connect your PC to something foreign in order to save money. You can join up with Uncle Samsung.



Inquiry 273 for End-Users.
Inquiry 274 for DEALERS ONLY.

UNCLE SAMSUNG MAKES IT AMERICAN

HOME OFFICE
7TH FL., THE JOONG-ANG
DAILY NEWS BLDG.
7 SOONHWA-DONG, CHUNG-KU
SEOUL, KOREA
TEL: (02) 756-2333 (511-513)
(02) 757-2095
TELEX: STAFINEC K33217, K22596
FAX: (02) 756-4911, 757-4822

USA HEAD OFFICE
LOS ANGELES
TEL: (213) 404-1835
TELEX: 183423 SEDLA
FAX: (213) 926-7748

SANTA CLARA
TEL: (408) 970-8844
TELEX: 4745070 SPIUI
FAX: (408) 970-9534

TOKYO
TEL: (03) 581-5804, 581-9521/4
TELEX: 2228009 SANSEI
FAX: (03) 581-4835

LONDON
TEL: (01) 831-6951/5
TELEX: 264606 STARS LG
FAX: (01) 430-0096

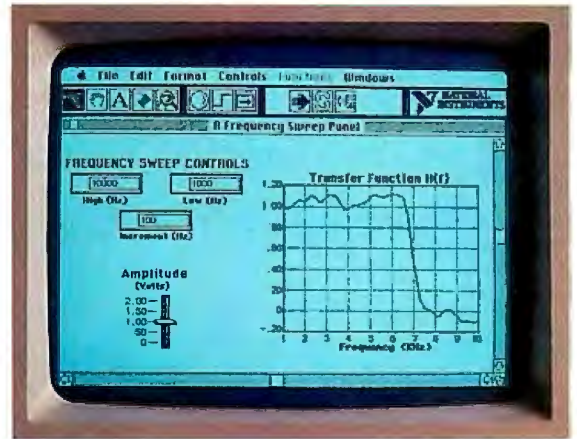
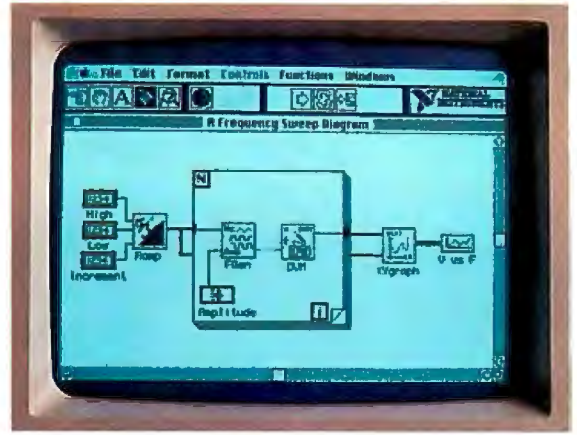

YOU CAN WRESTLE WITH A FEW THOUSAND LINES OF CODE TO PROGRAM YOUR EXPERIMENTS.

Developing scientific experiments takes creativity. Writing code to run them takes sweat. At least it used to. But no longer. Because we've just solved the scientific and engineering programming problem.

OR YOU CAN USE LabVIEW.

Picture the perfect programming language. Imagine software where diagrams are really executable programs.

Imagine running experiments and simulations through front panels that look and act just like instruments. On screen!

Imagine reusable software modules that can control your instruments, *in any application*. Programs for data acquisition, data reduction, signal processing, analysis, conversion, and display.

Imagine a programming environment so powerful that productivity is measured in **hours** instead of days.

The Macintosh made it possible. LabVIEW made it happen. Automated testing, measurement, and simulation has never been easier or faster.

Call for details. 800/531-4742.

DESKTOP ENGINEERING HAS ARRIVED.



12109 Technology Blvd.
Austin, TX 78727
800/531-4742 512/250-9119

PC Engineering Solutions



From The Leader in Finite Element Analysis

The MacNeal-Schwendler Corporation provides a family of engineering software solutions for use on your personal computer.

Mechanical engineers and structural designers can increase product reliability and cut material costs with these powerful yet easy to use PC-based software programs.

MSC/pal 2 is a 3-D finite element analysis program for the IBM PC. It performs static analysis with multiple loading subcases, natural frequencies and mode shapes, transient response and frequency re-

sponse. Color shaded contour plots, deformed animation, XY plots and CAD interfaces are standard features.

MSC/pal is a similar finite element analysis program for the Apple Macintosh. It features the standard Macintosh user interface, with pull-down menus and dialog boxes.

MSC/cal is a finite element heat transfer program for the IBM PC. It has steady-state and transient analysis capabilities, with color shaded contours and XY plots.

Put MSC's family of PC-based engineering programs to work

for you today.

The MacNeal-Schwendler Corporation offers volume, retailer and educational discounts. For more information call (213) 258-9111 or write.



The MacNeal-Schwendler Corporation

815 Colorado Blvd., Los Angeles, CA 90041

The Dark Ages of online information are over.



Now experience The InfoMaster® Age-FREE!

Until now, electronic information services were positively medieval. Their systems were developed by specialists for specialists—and only a wizard could decipher them.

Now there's InfoMaster—the extraordinary information service from Western Union. It's an exciting new realm of online information. Powerful. Practical. Easy to use. And we want you to experience it—firsthand!

A wealth of problem-solving information about your business.

Whatever business you're in, InfoMaster makes critical information immediately accessible. Timely, comprehensive information. About your business. Your market. Your prospects. Your competition.

InfoMaster puts the world's leading online vendors—BRS, Dialog, NewsNet, Vu/Text and more—at your fingertips. Information from over 800 databases! Names like Moody's, Standard & Poor's, TRW, and Dun & Bradstreet.

No computerese. It's easy to use!

InfoMaster bridges the obstacles that can keep you out of most other online services! InfoMaster makes it easy to log on...easy to pick the right database...easy to find the right information.

In fact, you don't even have to know which database to choose. InfoMaster will act as your guide...leading you there, one easy step at a time. Plus, there's free online assistance from a specialist, 24 hours a day.

The instant rewards of instant information.

With InfoMaster service, you spend less time looking for information...have more time to think about it. This can

make a big difference in your reports, presentations, recommendations and decisions. Not to mention your career!

Enter The Age of InfoMaster today —with your complimentary password!

There's no faster, better way to see how InfoMaster service can work for you than by experiencing it for yourself—FREE. So call now or mail the coupon today.*

Call now for your Complimentary Password. Then get on line and experience InfoMaster FREE.

1-800-247-1373

 Dept. 501

Request your Complimentary Password by phone or mail. Sample InfoMaster service—FREE.

- YES! I want to sample the world's largest electronic information source—FREE. Please provide me with a complimentary password so I can log on to InfoMaster without charge or obligation.
- I just want more information at this time. Please send me a FREE InfoMaster Kit.

TELEPHONE

Mail to: InfoMaster, Dept. 501
4230 Alpha Road, Suite 100, Dallas, TX 75244-1401 A134

*Respond now and receive a FREE full-color InfoMaster poster.



Add up to 96K above 640K to all programs, including PARADOX and 1-2-3.

Parity-checked 256K with a one-year warranty.

Run custom software or the 3270 PC Control Program above 640K.

Run resident programs like Sidekick above 640K.

Top off a 512K IBM AT's memory to 640K and add another 128K beyond that.

Short card works in the IBM PC, XT, AT, and compatibles.

Add expanded memory to programs supporting the Lotus/Intel/Microsoft specification 3.2.

MAXIT™ memory works above 640K for only \$195.

Break through the 640K barrier.

MAXIT increases your PC's available memory beyond 640K. And it does it for only \$195.

MAXIT includes a 256K half-size memory card that works above 640K. MAXIT will:

- Add up to 96K above 640K to all programs.
- Run memory resident programs above 640K.
- Top off an IBM AT's memory from 512K to 640K.
- Expand 1-2-3 Release 1A or 2.0 worksheet memory by up to 256K.
- Add expanded memory above 640K to programs like Symphony 1.1.

Big gain — no pain.

Extend the productive life of your, IBM PC, XT, AT or compatible. Build more complex spreadsheets and databases without upgrading your present software.

Installation is a snap.

MAXIT works automatically. You don't have to learn a single new command.

If you have questions, our customer support people will answer them, fast. MAXIT is backed by a one-year warranty and a 30-day money-back guarantee.

Order toll free 1-800-227-0900.

MAXIT is just \$195 plus \$4 shipping, and applicable state sales tax. Buy MAXIT today and solve your PC's memory crisis. Call Toll free 1-800-227-0900 (In California 800-772-2531).

We accept VISA, MC, AE, and DC.



Osborne McGraw-Hill
2600 Tenth Street, Berkeley, California 94710

Turn Your Cottage into a Ranch House for \$79.95. With AUTOSKETCH™

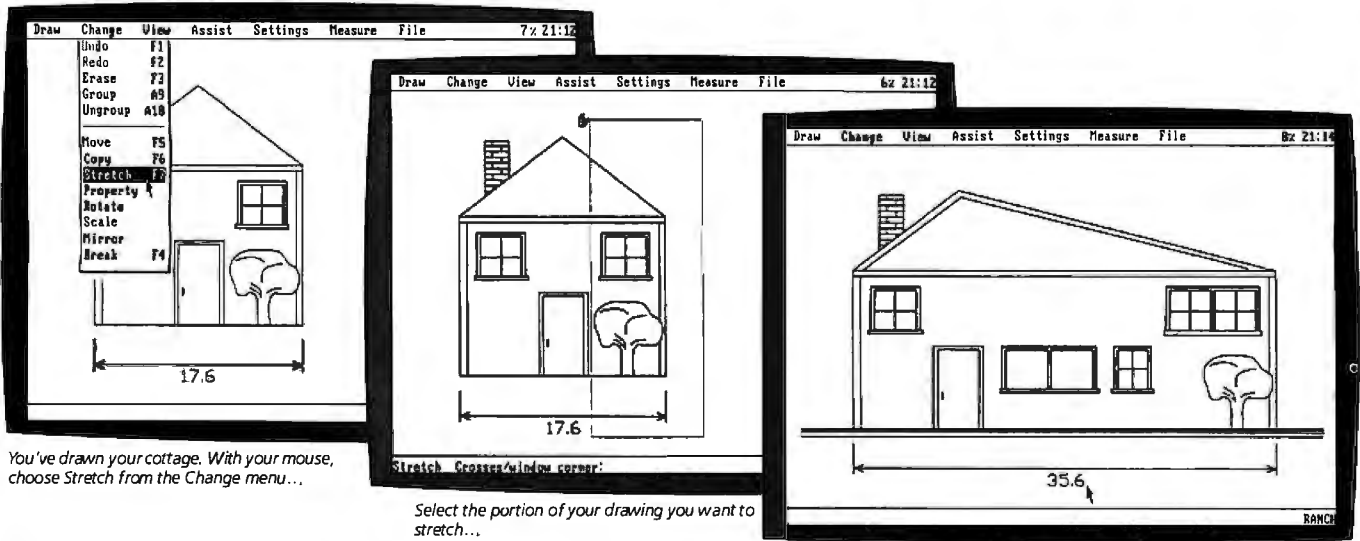

You've drawn your cottage. With your mouse, choose Stretch from the Change menu...

Select the portion of your drawing you want to stretch...

Move the pointer, click, and the job's done. (The dimension changes automatically.) Add the finishing touches, and your ranch house is complete.

Only five years ago, computer-aided design was affordable only by the very largest companies. Then came AutoCAD®, which brought CAD to the personal computer, and to the desktops of more than 60,000 architects, engineers, and designers.

But what about you? Are you one of the tens of millions of others who draw? At home: laying out your office, designing your dream house, or making carpentry plans. At work: making facility layouts, assembly instructions, shop-floor setup diagrams, and inspection checklists. Or at school: learning the principles of drawing and design.

You're probably still drawing the hard way—by hand. You can't justify the price of a full CAD system, nor do you want to spend the time to master a system with the complexity and power demanded by a full-time professional. Now, there's a computer-aided design tool for you.

Introducing AutoSketch

AutoSketch is full-function computer-aided design software for creating line art. You draw with a mouse, using pull-down menus and dialogue boxes. If you're like most AutoSketch users, you'll be drawing in less than an hour. Your drawings will be far more accurate, and you'll spend less time creating them. With AutoSketch, you can revise a drawing and make a new clean copy in seconds: no more erasure marks or redrawing the final version.

A New Way To Draw

AutoSketch automatically draws lines, arcs, circles, polygons, and smooth curves.

You can add text of any size. You can build libraries of frequently used symbols, draw in colors, and use differing line types to distinguish objects. You can even draw on multiple layers and look at them in any combination.

Freedom to Experiment

Once you've drawn something, you can move, copy, rotate, mirror, and erase until it's just right. You can work on objects as a group, or break groups apart. Change your mind? You can Undo anything you've done. Change your mind again? Use Redo and put it back.

Accuracy You Can Count On

AutoSketch drawings are precisely dimensioned, with an accuracy of more than six decimal places. You can have AutoSketch dimension your drawings just by pointing to the distances to be measured. When you scale or stretch the drawing, the dimensions change automatically. You can "zoom in" to work in detail, then "zoom out" to see the whole picture. AutoSketch even allows you to measure angles and areas, so you'll know how much carpet to buy for that new room you're planning.

AUTOSKETCH™

from the Makers of AutoCAD

Autodesk, Inc.
2320 Marinship Way
Sausalito, CA 94965



Make A Hard Copy Easy

When your design is done, you can make a paper copy on any one of a large selection of printers and pen plotters. And you can print any section of your drawing as well, at any scale you like.

Enhanced Speed

If you have an 8087 or 80287 math coprocessor, you can run AutoSketch as much as three times faster. With the enhanced version of AutoSketch, which requires a math coprocessor, you can experience up to nine times the speed, and for a price — \$99.95 — that isn't nine times higher.

If, over time, you want to go further with computer-aided design, you can move on to AutoCAD 2.5 and take your AutoSketch drawings with you—they're fully compatible.

Find out for yourself why so many professionals draw with computers. If you have a PC, you can enter the age of computer-aided design for just \$79.95. Why wait? For the name of an authorized dealer near you, call 800-445-5415. Or simply order direct with a credit card by calling 800-772-9200, ext. 329.

AutoSketch runs on IBM PC, XT, and AT PCs and 100% compatibles. We recommend 512K RAM minimum and two floppy disk drives or one floppy disk and a hard disk. AutoSketch supports the Hercules™ Graphics Card, the IBM Color Graphics Adaptor (in monochrome mode), or the IBM Enhanced Graphics Adaptor with 256K graphics memory and the Enhanced Graphics Display. You can use the Microsoft® mouse (or compatible), or a joystick as your pointing device. For compatible printers and plotters, call 800-445-5415.

IBM PC, XT, and AT are trademarks of International Business Machines Corporation.

DON'T MISS AUTOCAD® EXPO '87, JUNE 23-26, AT THE WASHINGTON, D.C. CONVENTION CENTER.

LETTERS

including Review Feedback

PC Scheme

The review entitled "PC Scheme: A Lexical LISP" by William G. Wong (March) emphasized some of PC Scheme's advanced features, such as continuations and engines, but it did not mention environments (used to implement SCOOPS), streams (like lists, but with delayed evaluation), and ports (files and windows), which are also first-class objects. Also, Mr. Wong faulted PC Scheme for not including record structures, when, in fact, its `define-structure` is similar to `define-struct` in Common LISP and creates extensible structures whose instances are equipped with accessors and recognizers.

PC Scheme has a `string-read` function, called `read-line`, which reads a line from a port and returns it in a string. However, `read-line` does not echo when reading from input or from a window, a fact that impedes interactive programming.

Readers should note that PC Scheme also runs on the TI Professional, and it gives you control of the excellent graphics on this computer, as well as on the IBM PC. It also gives full control of character attributes on either computer.

Finally, Abelson and Sussman's remarkable book is not the only source on PC Scheme. Daniel P. Friedman's *The Little Lisper* uses PC Scheme syntax, and Kent Dybvig's new *The Scheme Programming Language* gives extended examples, including examples using continuations and engines.

Roger B. Kirchner
Northfield, MN

Atari 1040ST

I just read the review of the Atari 1040ST by Dave Menconi (February). Overall, it was a positive and generally unbiased review. However, there are a couple of points that I would like to bring up.

In the Disk Access in BASIC Read and Write tests, I found it disturbing to see ST BASIC results being graphed against the more optimized BASICs of the Amiga and the Macintosh. ST BASIC is the slowest, most clumsy BASIC available for the ST. It takes minutes instead of seconds to load relatively large files. For the reader to see this in a comparison with the other computers, it gives the illusion of the 1040ST being generally slow. This is not the case. Quite a few complete BA-

SICs for the ST are lightning fast, such as Fast BASIC from Computer Concepts or LDW BASIC. These alternate BASICs would speed up the 1040ST's test results significantly.

My second point concerns disk I/O speed and storage size. The ST drive capacity is 360K bytes and 720K bytes, as Mr. Menconi states. However, if you use one of the many formatting programs available in the public domain, you can pack just over 400K bytes on single-sided drives and around 809K bytes on double-sided drives while maintaining compatibility with all file-copy and file-load applications.

Rod Swanson
Napa, CA

I could not agree with you more that using ST BASIC in the benchmarks skewed the results. Unfortunately, at the time that I wrote the review (I completed it in September 1986 and started it some months before that), there were few alternative BASICs available. Thank you for pointing out some of the alternatives that have become widely available since then.

—Dave Menconi

I enjoyed Dave Menconi's review of the Atari 1040ST. Based on my experience with my functionally equivalent Atari, I have a few comments relative to the basically excellent review. First, I've found a good way to use the right mouse button with the desktop. When you have two or more windows open, you can hold down the right mouse button and use the left button to make a selection from another window. I have found this particularly useful when copying files from one disk (or RAM disk) to another disk, since you do not have to change the active window when using the right mouse button.

Next, Mr. Menconi states that if you have a folder open, "you cannot access any of the other files" on that drive. Actually, you can access those files: You simply open a second window for that drive by clicking on that drive. You can have up to four desktop windows open at any one time for accessing files.

Finally, Mr. Menconi says that "the icons are arranged for you." True, the icons do have a default position, but you are free to move them wherever you want on the screen. Then you can point to and

click on the option to save the desktop. Thus, the next time you boot from that disk, the icons will come up in the same position you established.

E. Frank Carlson
Maple Valley, WA

Thank you for comments, especially your tip about the left and right mouse buttons. I'd like to note that the icons I described as being arranged for you are not the icons on the desktop, but the file icons in a disk window, which are, indeed, arranged for you.

—Dave Menconi

This letter is a group effort in response to the review of the Atari 1040ST. We all have extensive experience with our Atari STs, and many of us have a great deal of experience on many other kinds of computers, including the Macintosh and the IBM PC. The review, in our opinion, was written with a preconceived bias and, as a whole, was negatively presented.

One comparison that Mr. Menconi made was between the 1040ST's TOS operating system and the Macintosh's Finder. He mentioned that the Finder was intended to be the "perfect user interface." If you are going to compare the 1040ST to a possible advantage of the Mac, then at least mention that the Mac is incapable of displaying color, a severe disadvantage if you consider user-friendliness. It should also be noted that the ST can run without the GEM desktop with any of several command-line interpreters using MS-DOS, Unix, or CP/M commands.

For some reason, Mr. Menconi presented the fact that the 1040ST does not include an RF modulator as a real negative. Of course, the IBM PC and the Macintosh don't have one, either. But if

continued

LETTERS POLICY: *To be considered for publication, a letter must be typed double-spaced on one side of the paper and must include your name and address. Comments and ideas should be expressed as clearly and concisely as possible. Listings and tables may be printed along with a letter if they are short and legible.*

Because BYTE receives hundreds of letters each month, not all of them can be published. Letters can not be returned to authors. Generally, it takes four months from the time BYTE receives a letter until it is published.

Ven-Tel clears the path to 2400 baud.

Trying to install a 2400 baud modem in your PC can make you feel like you're trying to get through a maze.

With most 2400 baud modems, you'll wade through pages of documentation... only to learn that you must set dozens of parameters and reconfigure your software. Even buy all new software.

Ven-Tel 2400 baud modems eliminate the barriers. Just plug one in, and you're ready to transmit your data twice as fast. Using whatever software you're using today.

Choose Ven-Tel 2400 baud modems in either our convenient desktop, or Half Card™ internal, versions. Each requires minimal installation and will automatically connect with 1200/300 baud modems and services. And each is available with or without X.PC error correction built-in.

Like all of our PC products, Ven-Tel 2400 baud modems are backed by a free *five-year* warranty.

No other major manufacturer even comes close.

So when you decide to shift into high gear, do it with a Ven-Tel 2400. We give you the speed you want—without making you work for it.

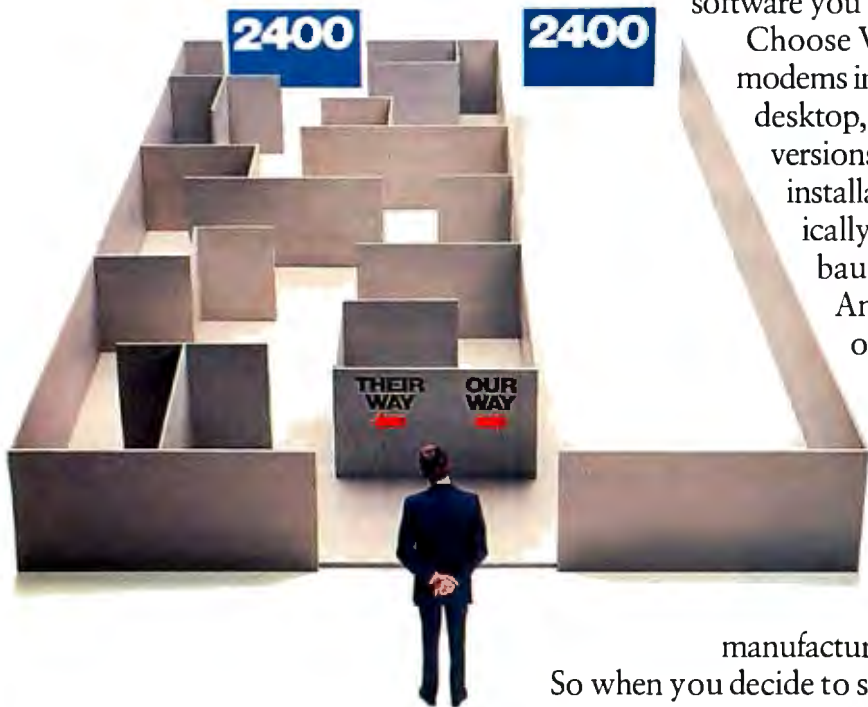

Ven-Tel

Modems

Our free 24-page booklet, "How to Select The Correct Modem," contains specific information about our full line of Ven-Tel 1200 and 2400 baud modems. To request your copy, call 800-538-5121. In California, call 408-727-5721.

FORTRON PRESENTS THE DEPENDABLE POWER

While some power supply importers reduce their selling prices by using cheaper materials, we at Fortron do not jeopardize our discriminating customer's faith in our standards of quality by such compromises.

Here are some differences:

- UL recognized, CSA certified model optional
- OVP, OCP, short circuit protection
- Meets VDE requirements
- MTBF 34,000 hrs.
- Four drives connectors
- Use Burndy® connectors
- Shielded power cord
- Built-in EMI filter
- One full year warranty

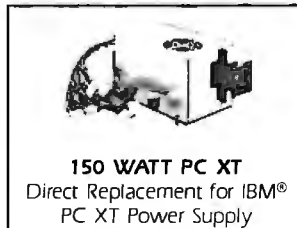
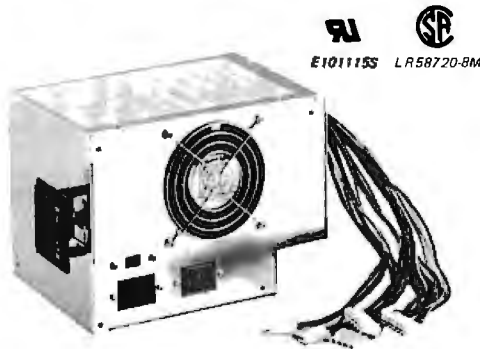

and highest performance 80386 CPU MOTHER BOARD

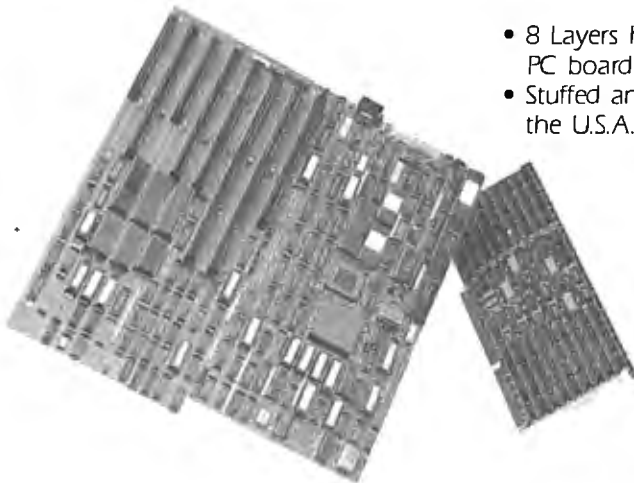

- 8 Layers high quality PC board
- Stuffed and tested in the U.S.A.

- On board 2 serial, 1 parallel port
- On board 80287 socket
- Two 32 bit, four 16 bit, two 8 bit expansion slots

- Support RAM-BIOS
- Standard 2 MB RAM
- Two-way interleaving memory

FORTRON CORPORATION

3225 Seldon Court
Fremont, CA 94538

[415] 490-8171

Telex: 559291 Fortron
Fax: [415] 490-9156

SEE US AT



COMDEX/Spring '87
June 1-4, 1987
Georgia World Congress Center
Atlanta, GA

you really need one, you can buy a third-party RF converter and add it to your ST. However, we are lost as to why someone would want to buy a \$1000 computer with the graphics quality of the ST and use a standard TV as the display screen.

Another point about user-friendliness: Isn't it nice to have all those function keys available? The Mac has no function keys. Switching resolutions is not a problem, either. It can be software-selected, as shown by the paint program, NEO-chrome, which comes bundled with the computer. If you think that the ST method of switching resolutions is a quirk, then having to press Command-E every time you want to remove a disk on the Mac is a "QUIRK+."

Mr. Menconi made no comment on the ST's 640 by 400 monochrome screen or dual-resolution RGB monitor. He also did not mention that the system includes RS-232C, parallel, and DMA ports; a cartridge slot (for running Mac products faster than the Mac using the new Magic Sac emulator); or the MIDI ports. We had to laugh when we read the statement "Unfortunately, relatively little software is available that really makes use of the windows, menus, and icons so characteristic of TOS." While we agree that a good word processor has been a long time coming, most other areas have been taken care of quite well. Look at the public domain CP/M-Z80 emulator put out by Atari; the Macintosh emulator, Magic Sac; and the public domain emulators for the Apple II, Commodore 64, and Atari 8-bit software. There's also DEGAS Elite, a powerful paint program; GEM versions of VIP Professional and dBMAN; and powerful MIDI software.

The 40-folder limit per disk is not as Mr. Menconi presents it. You can have as many folders on a disk as you want, but, in the version of TOS he looked at, if you access more than 40 folders between system resets, you risk a directory error. However, some of us have ignored this precaution for as long as we've owned our STs, and no dire consequences have been reported. One last note: The Esc key does not update the screen; it only updates the current working window.

All in all, many people who are looking for a good, inexpensive computer with the advanced characteristics of the ST may be misled by this review.

Miami Valley Atari Computer
Enthusiasts (MVACE)
Huber Heights, OH

Thanks for your feedback on the review. I'd like to clarify some points you brought out, however. I thought it appropriate to briefly contrast the ST with the Macin-

continued

A disk each month

PACKED with PROGRAMS

**\$20
Super Discount**

DISCOVER UPTIME. You deserve the best from your computer. Have the best and save the most with UPTIME.

We make it easy and inexpensive — a disk each month. You deserve value. At UPTIME we believe in value. That's why each month 30,000 people like you enjoy a disk packed full of programs and information.

Make life easier & get more from your computer. Organize your life and be more productive with **home management** and **finance** programs. Have fun learning with our **educational** programs and fun relaxing with **games** and **adventures**. You will find **business, graphics, utilities & more!**

At least eight great programs on every disk. What's the opposite of "downtime"? It's UPTIME, of course. Just imagine ... a disk each and every month, delivered right to your door and packed with programs for your micro.

Subscribe now, with our introductory offer! Satisfaction guaranteed, or your money back. Make the very next disk yours! Fill in the coupon and return it to us, or simply call. We'll start your UPTIME subscription immediately.

Call
1-800-437-0033
Today!



QUALITY PROGRAMS
LESS THAN
\$1.00 each

Inquiry 330

NOW
FOR YOUR
MICRO
COMPUTER

for your Apple, IBM PC, C64/128 or Macintosh.

A Typical Disk Includes:

- Label Magic ■ Living Art ■ File Doctor ■ Calendar
- One Foundation ■ Financial Package ■ Decision Maker ■ Tips and Hints ■ News and Views ■ Product Reviews

I'LL BYTE!!! I'm a computer enthusiast who wants more. Please start my subscription to UPTIME immediately.
\$20 SUPER DISCOUNT
SAVE \$109.99 → 12 Disk Issues \$99

6 Disk Issues \$59

3 Disk Issues \$36

1 Trial Issue \$14.95

Name _____

Address _____

City _____

Type of Computer _____

Payment enclosed. (Make checks payable to UPTIME.)
Bill my: VISA MC Exp. Date _____

Signature _____

Account No. _____

State _____ Zip _____

Send to:
UPTIME - PO Box 299
Newport, RI 02840
(401) 849-4925

C Programmers!

db_VISTA™: high-speed DBMS written exclusively for C NOW offers SQL-based query

High-Speed data retrieval and access... just two benefits of using Raima's network model DBMS, db_VISTA. Combine these design benefits with those of C—speed, portability, efficiency, and you begin to understand db_VISTA's real measure... performance.

**Says, Dave Schmitt,
President of Lattice, Inc.**

"If you are looking for a sophisticated C programmer's database, db_VISTA is it. It lets you easily build complex databases with many interconnected record types. Raima's customer support and documentation is excellent. Source code availability and a royalty-free run-time is a big plus."

db_QUERY™: new simplicity retains performance!

db_QUERY, our new C-linkable, SQL-based, ad-hoc query and report writing facility... provides a simple, relational view of db_VISTA's complex network database. No longer will you give up performance for simplicity... combine db_QUERY with db_VISTA... you have both!

- **Written in C**
- **Royalty-Free**
- **Source Code Available**
- **Multi-user and LAN capability**
- **Fast B-tree indexing method**
- **Transaction processing**
- **Faster without Data Redundancy**
- **Complete Documentation**
- **Operating systems:** MS-DOS, PC-DOS, UNIX, XENIX, SCO XENIX, UNOS, ULTRIX, VMS
- **C compilers:** Lattice, Microsoft, IBM, DeSmet, Aztec, Computer Innovations, XENIX and UNIX

30-day Money-Back Guarantee

Royalty Free Price Schedule

	db_VISTA	db_QUERY
Single-user	\$ 195	\$ 195
Single-user w/Source	\$ 495	\$ 495
Multi-user	\$ 495	\$ 495
Multi-user w/Source	\$ 990	\$ 990
NEW:		
VAX Multi-user	\$ 990	\$ 990
VAX Multi-user w/Source	\$1980	\$1980



Call Toll-Free Today!

1 (800) db-RAIMA

(that's 1-800-327-2462)

—OR Call 1-206-828-4636



3055 - 112 N.E., Bellevue, WA 98004 USA
(206) 828-4636 Telex: 6503018237 MCI UW

67BY

LETTERS

tosh, a major computer that has a similar user interface. It was not my intention to do a thorough comparison.

The graphics resolution, ports, and cartridge slot were all mentioned in the article or the text box. Since all this information was gone over in great detail in the Atari 1040ST Product Preview (March 1986 BYTE), I thought there was no need to repeat it in the review.

When I wrote the review, only about 20 percent of the software available made use of menus, icons, and windows. I am happy to report that this figure has been climbing steadily since then. The specific software products you mention either don't use menus and windows or simply weren't available at the time.

—Dave Menconi

53 Dot-Matrix Printers

I just had to write to express my appreciation for the review entitled "State of the Art in Dot-Matrix Impact Printers" by Jane Morrill Tazelaar and George A. Stewart (April). What a thorough analysis! This one review was worth the price of a year's subscription and is a great service to customers and vendors.

But I can't for the life of me figure out where you got the figures for sound levels in the graphics mode. Does the Department of Defense know about Radio Shack's DMP 130? A level of 583 dB is about 7 on the Richter scale.

Walter Clark
Fullerton, CA

Playing the Odds

Mr. Carlisle's letter in the March issue reminded me of another speed-up method I came up with while exploring the Mandelbrot set.

The idea is to exploit the area-coherence of the drawing—namely, the fact that it consists of large areas of constant color. If, for example, a pixel is painted red, then its immediate neighbors are likely to be red, too.

The algorithm regards the pixels of the drawing area as two interleaved groups (A and B), analogous to the black and white squares on a chessboard. Note that each pixel in group B is surrounded by four pixels from group A.

Phase 1 of the algorithm paints each pixel in group A using the regular iterations loop. Phase 2 paints each pixel in group B according to the colors of its four surrounding neighbors. If all four neighbors are of the same color, then the pixel receives that color. Otherwise, the pixel's color is determined the hard way—by the regular iteration loop.

Recurring trials with various parts of the Mandelbrot set indicate close to 50 percent reduction in run time. This im-

provement is due to the fact that very few pixels in group B lie close to the border between two colors. Consequently, the iterations loop has to be entered very few times during the second phase.

The price to be paid for increased speed is decreased accuracy. During phase 2, a pixel might receive the wrong color. Such errors, however, are hardly noticeable, because they can only occur in areas of the drawing where feature size is in the order of magnitude of two pixels or less; and even in these areas, the probability of a given pixel being painted incorrectly is only $(n-1)/n^4$, where n is the number of distinct colors used in the drawing. On my microcomputer, using 16 colors, this is less than 0.03 percent.

If the pixels in group B are processed in raster order, then each pixel in its turn has six painted neighbors. The colors of all six may be compared, to reduce the chances of error even further.

Ofer Faigon
Tel Aviv, Israel

The check for repeating values that Mr. Carlisle mentioned in the March issue will indeed speed up calculations for points that lie within the Mandelbrot set. However, it adds some overhead to each iteration, whether or not the point is in the set. This overhead is not worth it for most plots, because people tend to want to see areas that are dominated with points that do not lie in the set.

Mr. Chi's point on the magnitude of the cutoff (also in the March Letters section) requires some clarification. We agree that there is no magic cutoff, and 256 will work for initial explorations at low magnifications. However, at higher magnifications a larger number is often necessary. We have seen plots where a cutoff of 6000 or more significantly improves the picture.

Regarding speeding up the calculations: If you have the 8087 chip, we suggest that you program in assembler, use all eight registers, and go back to memory only when necessary. Also, 16 bits will not be enough for serious exploration—we suggest 32 bits or more. Mr. Chi's comment regarding fixed-point math is otherwise excellent.

Mark W. Bolme
Bellevue, WA

Perspective Check

In Kenneth Perry's article "Abstract Mathematical Art" (BYTE, December 1986), the following sentence caught my attention:

"These one-dimensional automata are 'mathematically irreducible'—there is no shortcut to determine whether a given

continued

Incomparable!

"It outperforms the competition at a price that is simply the best deal on the market."

DataPro Research Corporation

"Wells American's A★Star II stands out from the crowd... This reviewer found the [keyboard] touch to be very good... [The documentation] is well written and easy to understand and all the illustrations are clear and accurate. We find the A★Star II to be a very attractive AT-compatible computer."

Computer Buyers Guide
—Compatibles Report

"If you're looking for a bargain-priced AT type computer - and there are many to consider these days - the A★Star is one that seems well worth the price."

Personal Computing
—Patrick Honan

"This computer is a whale of a buy... Inside the case it is neat and well designed. It just looks like quality!... I would find it hard to believe that you could outgrow the A★Star anytime in the near future... If I were buying a computer now it would be this offering from Wells."

Computer Shopper
—Lon Andrews

"All in all, [the A★Star] is a superior PC/AT compatible unit... When one considers price, performance, upgradability, manufacturer support and assembly within the USA, it is a definite winner."

Computer Dealer
—Jake Epstein

"It is as compatible as the best units tested... Its money-back guarantee is commendable... [the A★Star] has the potential to be a low cost whiz."

PC Magazine
—Jon Pepper

"What the world needs now is an AT which is significantly cheaper than all the others, while providing a higher level of performance than most, with a high degree of compatibility and good quality. And that's exactly what the A★Star II is."

Australian PC
—Ian Davies

"Graphics screens that take 10 and 20 seconds to redraw at 6MHz, now appear in three or four seconds. If it doesn't run at 12MHz, in 5 seconds you can switch to a lower speed. We were very favorably impressed."

DataPro Research Corporation

Unsurpassed quality. Unbeatable performance. Exceptional manufacturer support. The experts agree! There are no other IBM PC/AT compatibles quite like our A★Star microcomputers. With prices starting at only \$1095 for a 12MHz unit, it's no wonder so many of our customers are saying goodbye to IBM in favor of a "good buy" from Wells American. Call or write us today about our 31-day trial offer.

 **Wells American.**

Corporate Headquarters: 3243 Sunset Boulevard • West Columbia, South Carolina 29169 • 803/796-7800 • TWX 510-601-2645

automaton with a given rule and a given initial state will lead to a cyclic structure of long period, a finite structure of long life, or some other possibility. Therefore, the approach taken by this program is not naive. We are not playing a trivial game whose outcome could be more easily predicted by a more sophisticated mathematical approach."

I just wondered about the foundations for such a definitive statement. When I wrote to Mr. Perry about it, he kindly sent me a copy of Stephen Wolfram's article "Computer Software in Science and

Mathematics" in the September 1984 *Scientific American*. Here are two excerpts from this reference:

"Universal computation has been proved for a simple two-dimensional cellular automaton. . . . It is *strongly suspected* that several one-dimensional automata are also universal computers"—that is, admit no mathematical shortcuts to decide their future behavior.

"It is *not yet known* how widespread the phenomenon of computational irreducibility is among cellular automata or among physical systems in general" (my

italics in each quotation).

I think Mr. Perry's passage from these assertions to his conclusive statement illustrates two frequent mistakes. The first concerns elementary logic: The negation of the statement "All automata are reducible" is not "All automata are irreducible," but "There is at least one irreducible automaton."

The second mistake is perhaps not just a mistake, but (in my humble opinion) a mistaken attitude toward computers and their role in the process of scientific development. It is true that many physical problems presently escape our comprehension. It is also true that computer simulation greatly enhances our inside view of these problems. But please, don't confuse ignorance with impossibility; don't confuse computer simulation with theoretical thinking and research; and most important of all, don't deny from the outset the possibilities of good old-fashioned brainwork. Maybe, after all, what these last years of our century lack is not better mainframes, but better brains. Maybe after all we *are* now playing a trivial game.

Ricardo Slutzki
Buenos Aires, Argentina

Fantasy Not Needed

I have ambivalent feelings about the article "The Potential for Interactive Technology" by Alfred Bork (February BYTE). I agree totally with his feeling that our schools need tremendous improvement and that we must be willing to spend money to get that improvement.

Education is an investment in national security, and conservatives are dreadfully inconsistent when they oppose adequate funding for education. I have observed in some of my acquaintances the lack of respect for teachers that Mr. Bork mentions.

However, Mr. Bork lost my sympathy when he brought in the science fiction concept of computers monitoring students' brain waves to ascertain their level of understanding. He might as well have brought in the equally fantastic notion of computers directly manipulating students' brain waves so as to impart learning without effort on the students' part! These concepts have no place in a serious discussion of how to improve our educational system.

Computers are a part of society, and will become more so as they become more powerful and less expensive. They have a place in schools, both as a learning aid and because students can no longer be considered truly literate without at least a basic understanding of computers.

But I have a big quarrel with anyone
continued

MINUTE MAN™

UNINTERRUPTIBLE POWER SUPPLIES

PROTECTION FROM:

- ★ INTERRUPTIONS
- ★ BROWNOUTS
- ★ BLACKOUTS
- ★ SPIKES
- ★ SURGES
- ★ EMI/RFI

30-Day Evaluation Program

NEW!

MINUTE MAN™

600WATT

• Sine Wave Output
• One msec Transfer Time

OVER VOLTAGE PROTECTION

To Be Introduced at Comdex

- Completely automatic operation
- From 1 msec to 4 msec switching time
- Audible and visual status indicators
- Order - ship same day
- Full one year warranty

See Us At:
COMDEX/ATLANTA
JUNE 1-4 BOOTH #4759

MINUTE MAN 250 250 WATT (120V) \$359⁰⁰ <small>Suggested Retail</small>	MINUTE MAN 300 300 WATT (120V) \$549⁰⁰ <small>Suggested Retail</small>	MINUTE MAN 500 500 WATT (120V) \$699⁰⁰ <small>Suggested Retail</small>	MINUTE MAN 1000 1000 WATT (120V) \$1399⁰⁰ <small>Suggested Retail</small>
--	--	--	---

230 V Units Also Available - Dealer Inquiries Welcomed

1455 LeMay Drive
Carrollton, Texas 75007

Telephone:
(214) 446-7363

1-800-238-7272



Enter A New Age In Accounting Software.

Dac-Easy Version 2.0, The Most Amazing Combination Of Speed, Power, Flexibility, Ease Of Use And Value Ever Offered.

We proudly announce Dac-Easy Accounting, the next generation. It will set new standards of performance and value.

Version 2.0 is a dramatic improvement over our revolutionary, best selling original package that won InfoWorld's 1985 overall "Best Software Value" and PC World's 1986 World Class Award.



PC EDITOR'S CHOICE

InfoWorld
1985
PRODUCT OF THE YEAR

Naturally, we've kept all the impressive features that have led nearly 200,000 users worldwide to rely upon Dac-Easy Accounting. The new Dac-Easy Accounting 2.0 has over 50 major enhancements from our first record setting package.

Experts Will Love Its Power. Beginners, Its Simplicity. And Everyone, Its Price.

New Dac-Easy Accounting destroys the myth you have to trade-off power for ease of use. Version 2.0 has awesome power that can help you better manage virtually any type business--fast. You'll have quick, finger-tip access to vital information about cash flow, pricing, inventory turns, sales trends, profitability, and more.

\$69.95

Version 2.0 is also unbelievably easy to install. To set up your files,

Inquiry 84

you simply answer five easy questions. Dac-Easy has a new expanded manual plus context sensitive help to guide you every step of the way.

Best of all, Version 2.0 is available at the amazingly low price of \$69.95.

Feature For Feature, The Number One Accounting Package On The Market.

Seven powerful accounting modules work in perfect harmony in one system. Data entered once is automatically posted to all other modules!

New capabilities include departmental profit & loss by product line or customer, multi-company, point of sale invoicing, automatic back-order control, sample Chart of Accounts & Financial Statements, service business billing, full help screens, on-line and batch processing, financial ratios and much more.

...d these to the features which

*General Ledger
Accounts Payable
Accounts Receivable
Inventory
Purchase Order
Billing
Forecasting*

have made Dac-Easy the fastest selling, most highly praised accounting package in history, and you'll see why Dac-Easy Accounting 2.0 is the best accounting software for your business.

Take Advantage Of Our Special Upgrade Offer.

Upgrades are available to current users at special discounted prices for all Version 2.0 products. Call 1-800-992-7779 with your serial number to order today!

Get Version 2.0 Performance For Your Business.

You win. Version 2.0 gives you absolutely the best combination of user conveniences, power, efficiency, and speed in the industry...at the same phenomenal price of the original. Act now. And put the New Age In Accounting Software to work for your business!

TO ORDER CALL TOLL FREE

1-800-992-7779

IN TEXAS CALL 1-214-458-0038

 dac software, inc.



GENERAL: •Multi-company, multi-departmental •Password protected •Extensive 430 manual with accounting primer •On-line sensitive help •Fast-start installation •nu-driven •Over 700 different reports •Billing module for services •Free phone support* available •Batch & on-line processing

GENERAL LEDGER: •Modifiable pre-designed Chart of Accounts & Financial Statements •3 Year account history •Pencil & pen feature for corrections •Unlimited journals •Unlimited accounts •Automatic budgeting •Financial ratios and more

ACCOUNTS RECEIVABLE: •Open invoice or balance forward •Flexible aging •On-line automatic posting •Departmentalization by customer •Customized text on statements •Cash flow analysis •Mailing labels •Flexible invoice allocations •3 Year history •Automatic finance charges •Notepad window •Supports partial payments •Sales analysis and sales budgeting and more

ACCOUNTS PAYABLE: •Check printing from multiple bank accounts •Automatic allocation of available cash •Vendor directories and labels •Flexible aging •On-line posting to other modules •Flexible invoice allocations •Automatic reprinting of checks •Notepad window •Purchase forecasting •Unlimited allocations per invoice •10 Invoices per check •Browse invoice and more



Software, Inc. Dallas TX 75244. CODE 83

30 Day Money-Back Guarantee

Dac offers 30 day unconditional guarantee on all products bought directly from Dac Software (less shipping charges). There is a \$10 restocking fee if the disk envelope is opened.

*FREE SUPPORT NOW AVAILABLE

Registered users receive 10 minutes within 60 days free support on every Dac-Easy software product (does not include upgrades).

THE AMERICAN FORCE



All across America the word about a new force is spreading. A force that has put American design, technology and manufacturing back on top. Be a part of it!

System 1800 Features:

- 6/8/10MHz Selectable with 10MHz 80286 CPU Chip
- Fully compatible IBM AT™ AMI BIOS with built in SET-UP UTILITY
- 47 drive type table
- 48 hour burn-in
- 512K RAM standard expandable to 1MB
- 200 pages of documentation
- Clock/Calendar with battery backup
- Hard disk/Floppy Controller
- UL/CSA approved 195 Watt power supply
- Made in U.S.A.
- 1 Year Warranty

System 1800 Models

WAIT STATE	MODEL NUMBER
1	System 1800-0 (8MHz)
1	System 1800-A (10MHz)
0	System 1800-B (10MHz)

Over 30,000 units installed



MAJOR OEM

CLUB AT INC.
800-415-8889

KELLECO
1-312-887-0330

QIC RESEARCH INC.
800-843-0806

SERVEX
(416) 827-7807

ELTECH
(408) 943-1764

MICRO CENTER
(614) 481-8041

S.F. MICRO
800-237-5631

PRIDE
(604) 273-0707

COMPUTER LIBRARY
(415) 659-8784

UNITED SOLUTIONS
1-800-922-9025

Total
Compatibility

American Quality
Manufacturing



U.S. Design and
Engineering

SCSI
1-800-237-7274

SPEAR TECHNOLOGY INC.
(312) 480-7300

TECHPOWER
(714) 979-1330

TECHPOWER II
818-882-6300

IBM is a registered trademark for International Business Machine Corporation.

Inquiry 104 for End-Users. Inquiry 105 for DEALERS ONLY.

System



An OEM Product of Everex Systems Inc.

JUNE 1987 • BYTE 25

who thinks that computers can replace teachers.. There is a lot of talk about "interactive" educational software. The computer asks a question, the student attempts to answer it, and that answer determines the computer's next move: perhaps another question, perhaps more instruction. At its worst, it is an electronic "flash card"—an inappropriate use of a still-expensive technology. At its best, it is a useful study aid.

But perhaps the most important part of education is *intelligent criticism*. This may come from parents or peers, but in the school it is the particular job of the teacher. The best math teacher I ever had was the one who stressed that the method you used to approach a problem was as important as the answer. Application of method is easily learned by rote (this is an appropriate place for the computer), but before you can apply method you must have some method to apply.

The assessment of how a student is approaching a problem is a task that requires intelligence. Directing the student from his present incomplete understanding toward a more comprehensive understanding is also a task that requires intelligence. I leave it to Mr. Bork's futurists to speculate about intelligent computers 20

years from now. Today we have very sophisticated expert systems, but nothing that can remotely be called artificial intelligence or even the germ of artificial intelligence. And with no sort of real artificial intelligence yet, and none on the horizon, I think it is irresponsible to base our plans for education on concepts requiring artificial intelligence.

A computer can tell whether you have given the right answer, but it cannot tell whether your wrong answer was due to careless arithmetic or to use of the wrong formula. A computer cannot grade an essay on Hegel's dialectics. I fear that inappropriate use of computers may lead us away from significant areas of thought ("What is the significance of Dostoevsky to Russian literature?") and toward trivial ones ("When did Dostoevsky write *The Idiot*?"). A computer cannot grade your response to the first question, but it can grade your response to the second. We are in danger of letting the limitations of the computer determine the direction of our educational system.

However, there are programs that are truly interactive. They let students see the results of their logic and require them to work through their mistakes. Students must try to understand *why* their mistakes

do not work. In the process of completing their task, they gain insight into the nature of the task. It is of this type of insight that real intelligence is made.

The "educational programs" I am speaking of here are programming languages. I assert that the most efficient use of the computer in school is to allow students to write their own programs. Programming allows students to pick their level of difficulty. The severely retarded student can learn to write a "Hello world!" program. The brilliant student can write a relational database program. The rest of us can write something in between. Programming at any level requires you to think, not just to answer questions, and that is what real education requires.

Dan Schechter
Amenia, North Dakota

Export Controls

The discussion of U.S. export controls for personal computers (November 1986 BYTE and Letters in the February issue) missed one point: This sort of interference is not restricted to Soviet bloc countries. While living in Botswana, a country friendly to the U.S., I bought a Zenith 150 series PC (a standard 8088 machine)

continued

GANG, SET & UNIVERSAL (E)PROM PROGRAMMER

THREE PROGRAMMERS IN ONE:

- GANG EPROM Programmer: Support for MOS/CMOS/HMOS EPROM/EEPROMs
- SET EPROM Programmer: 16-Bit, 32-Bit and optional 64-Bit Words.
- UNIVERSAL Programmer: (Optional) Bipolar PROMs, Logic Array Devices, 40 pin Micro Computer Devices, 3 Voltage Devices, 8 and 16 Bit Emulation, and GANG adapter with additional 8 ZIF sockets.

\$1,495

Model: S125-GL

Shown with optional PROMCel

UV Erasers from \$47

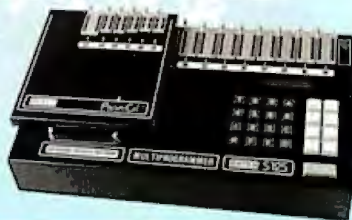

Open and Modular Architecture allows the BYTEK System 125 to communicate with most computers and Program a World of Programmable Devices at affordable prices.

STANDARD FEATURES Include:

- 64K BYTE RAM Buffer, (expandable to 1M BYTE)
- 3-Way Device Type Selection: Manually, Electronic ID or from Menu
- Stand Alone Operation (includes DATA EDITing)
- 25 Key Integrated Keyboard, 32 Character Alpha/Numeric LCD Display
- RS232 PC Interface for Terminal Mode. (Optional 2nd RS232 Port)
- Formats: 15 Popular RS232 Formats • Baud Rates: 50-19,200
- Parallel Printer Port, Centronic Compatible

• FREE SOFTWARE UPDATES (1 year)

BYTEK MultiProgramming Equipment offer User Friendly Operation, High Quality, and are backed by Dedicated Customer Service, Unlimited Product Support, and a Full One Year WARRANTY.

Call TODAY 1-800-523-1565

In Florida—(305) 994-3520



The WRITER™ supports virtually all MOS and CMOS EPROMs and EEPROM up to 512k. The WRITER has complete STAND ALONE programming capabilities including data EDITing, or PC Remote Control with the standard RS232 interface.

LOW PRICE \$495

STANDARD FEATURES of the WRITER include:

- Programs all popular 2716-27512 EPROMs & 2816 EEPROM
- 32K BYTES RAM (256K Bits)
- Large 6 Digit LED Display
- Single 28 pin ZIF socket
- Fast Intelligent Algorithms
- RS232 PC Interface
- 12 Popular RS232 Formats
- Baud Rates: 110-9600
- 14 Functional Keys, including: LOAD, PROGRAM, EDIT, DISPLAY, ERASED CHECK, FILL & VERIFY

Remote Control WRITER-RX ONLY \$345

BYTEK—the #1 CHOICE in (E)PROM Programming Equipment

BYTEK

CORPORATION

Instrument Systems Division

1021 S. Rogers Circle, Boca Raton, FL 33431

Telex: 4998369 BYTEK

FAX: (305) 994-3615

Visit our new California Sales Office:

2847 A Whipple Road, Union City, CA 94587

(415) 487-4694

MADE IN THE U.S.A.

See us at Booth #4626
COMDEX Spring '87
Georgia World Congress Center

80386

Imagine the speed and power of a \$100,000 minicomputer in a desktop PC costing under \$7,000. Now imagine all that power going to waste because the operating system you chose was never meant to take advantage of a computer this powerful. It will take more than just a "window environment" or an outdated operating system to unlock the 80386.

It will take PC-MOS/386™

The First 80386 Operating System. Specifically designed for the 80386 computer, PC-MOS/386™ opens doors. Doors to more memory and multi-tasking. Doors to thousands of DOS programs as well as upcoming 80386-specific software. It's the gateway to the latest technology..., and your networking future.

Memory Management

Without Boards. PC-MOS exploits the memory management capabilities built into the 80386. So, up to four GIGABYTES of memory are accessible to multiple users and to future 80386-specific applications requiring megabytes of memory.

Multi-Tasking, Multi-User Support for One, Five or 25 Users. PC-MOS/386™ allows up to 25 inexpensive terminals to be driven by a single 80386 machine. So the features of the 80386 can be utilized at every terminal. And it comes in three versions so you can upgrade your system as your company grows...without having to learn new commands or install new hardware.

**UP TO
25 USERS.**

**MADE FOR
THE 80386.**

**RUNS DOS
PROGRAMS.**

MULTI-TASKING

PC-MOS/386™



PC-MOS/386™
THE SOFTWARE LINK, INC.

Software Support for Thousands of DOS Programs. Although PC-MOS/386™ totally replaces DOS, it doesn't make you replace your favorite DOS programs. So you can run programs like Lotus 1-2-3, WordStar, dBASE III, and WordPerfect on the 80386. Best of all, it uses familiar commands like DIR and COPY—so you'll feel comfortable with our system.

The Gateway to Endless Features. Distinctive characteristics like file/system security, remote access, file/record locking, and built-in color graphics support for EACH user set PC-MOS/386™ apart from all previous operating systems.

Open the Doors to Your Future TODAY! Call The Software Link TODAY for more information and the authorized dealer nearest you. PC-MOS/386™ comes in single, five & 25-user versions starting at \$195.

PC-MOS/386™
MODULAR OPERATING SYSTEM

THE SOFTWARE LINK
Developers of LANLink™ & MultiLink™ Advanced

3577 Parkway Lane, Atlanta, GA 30092
Telex 4996147 SWLINK
FAX 404/263-6474

For the dealer nearest you.

CALL: 800/451-LINK
In Georgia: 404/448-LINK

OEM/Int'l Sales: 404/263-1006
Resellers/VARs: 404/448-5465

OEM/Dealer Inquiries Invited

THE SOFTWARE LINK/CANADA CALL: 800/87-0133

More Than Just Windows, We've Opened Doors.

Inquiry 371 for End-Users. Inquiry 372 for DEALERS ONLY.

TRADEMARK ACKNOWLEDGEMENTS: MultiLink® is a registered trademark of The Software Link. PC-MOS/386™ MultiLink® Advanced, and LANLink™ are trademarks of The Software Link. Lotus 1-2-3, WordStar, dBASE III, & WordPerfect are trademarks of Lotus Development Corp., MicroPro, Ashton-Tate, & WordPerfect Corp., respectively. Prices and technical specifications subject to change.

through a U.S. mail-order firm and arranged to have it shipped to me. Imagine my surprise when I learned that it had been seized by U.S. Customs, who held it for more than a month while trying to determine whether exporting it would be a violation of U.S. law protecting high technology.

I was also advised that, should the decision go against me, I would face fines and possible criminal prosecution. The final straw came when the computer was stolen, from a bonded U.S. Customs warehouse.

I received an insurance check several months later, and in the meantime I bought the same Zenith from a local dealer, for the same price, with an RGB monitor thrown in for good measure. Apparently large companies export under blanket licenses, however, individuals are forced to prove that their particular machine poses no national security threat.

The Customs Service has more important things to do than investigate off-the-shelf personal computers that are available around the world and whose

components were very likely not even manufactured in the U.S.

Fred Swartzendruger
Alexandria, VA

Calculating Areas

Since I have just recently been involved in providing assistance in calculating areas, I read with interest the article "Calculating the Area of an Irregular Shape," by Stolk and Ettershank (February BYTE). Readers interested in this subject might find the following analysis useful. To adapt my application solutions to those of Stolk and Ettershank for continuity, add two more coordinates (E and F) to figure 2a in the Stolk and Ettershank article.

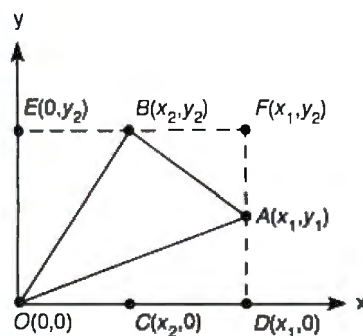

This method may provide a more general solution analysis than the Stolk and Ettershank approach, because it doesn't necessarily involve overlapping areas. The revised figure shows that Area(OAB) may now be described as follows:

$$\begin{aligned} \text{Area}(OAB) &= \text{Area}(OEFD) - \text{Area}(OEB) \\ &\quad - \text{Area}(BFA) - \text{Area}(OAD) \\ &= x_1y_2 - x_2y_2/2 - (x_1 - x_2)(y_2 - y_1)/2 \\ &\quad - x_1y_1/2 \\ &= x_1y_2 - x_2y_2/2 - (x_1y_2 - x_1y_1 - x_2y_2 \\ &\quad + x_2y_1)/2 - x_1y_1/2 \\ &= (x_1y_2 - x_2y_1)/2. \end{aligned}$$

Richard L. Messeder
San Clemente, CA

No Easy Answers

I am a computer store manager in Philadelphia (so much for your theory that computer store managers don't read BYTE), and I really take offense at the prevailing attitude toward the retail computer business.

Let me tell you what a typical day is like. First the phone rings with a question about software errors. The caller has no idea what software package she's using, and she purchased the hardware and software from another vendor. Then someone walks in who has no idea about computer equipment, and we spend an hour educating him only to find that he can't

continued

MIRROR II™ the Crosstalk™ SuperKlone™

You can pay more for Crosstalk™ XVI and get less, or you can pay less for MIRROR II™ and get more.

The Industry Standard For IBM PC Data Communications Software

When You Weigh the Evidence, The Decision Is Clear!

BYTE, April 1986, Ezra Shapiro
"I've deleted my Crosstalk files and plugged in Mirror, and I'm not the sort of person who throws out trusted software without good cause. I've got to have proof, and here it is."

Government Computer News, July 18, 1986, P. L. Olympia
"It is a singular pleasure to review a product such as this. All PC users who need to communicate with another computer should buy it."

PC Products, August 1986, Michael D. Millikin
[Mirror] "A Crosstalk twin that is complemented by a lower price tag, better documentation, and a respect for hard disks."

To order call: (904) 878-8564

VISA MC COD

Shipping/Handling \$5.00 (COD add \$3.00)
Overseas Orders \$18.00
Florida Residents add 5% Sales Tax

\$69.95

60-DAY MONEY-BACK GUARANTEE

MIRROR II™

A Better Reflection

SOFTKLONE™ 336 Office Plaza Dr.
Tallahassee, FL 32301 • (904) 878-8564
Telex: 671 4280 KLON

PRESENTING THE DIFFERENCE BETWEEN FAST COMPILING AND FAST PROGRAMMING.

For compiling speed, you can't do better than Let's C. But to really speed up programming you can't do without the powerful source level debugger, *csd*.

If you want the power, portability and flexibility of C, start with the complete compiler, Let's C. For utilities, editor, compiling speed and fast, dense code, Let's C has it all.

But to get your programs up and running you need more. Because even the fastest compiler can't outrun bugs. You need the revolutionary C Source Debugger, *csd*.

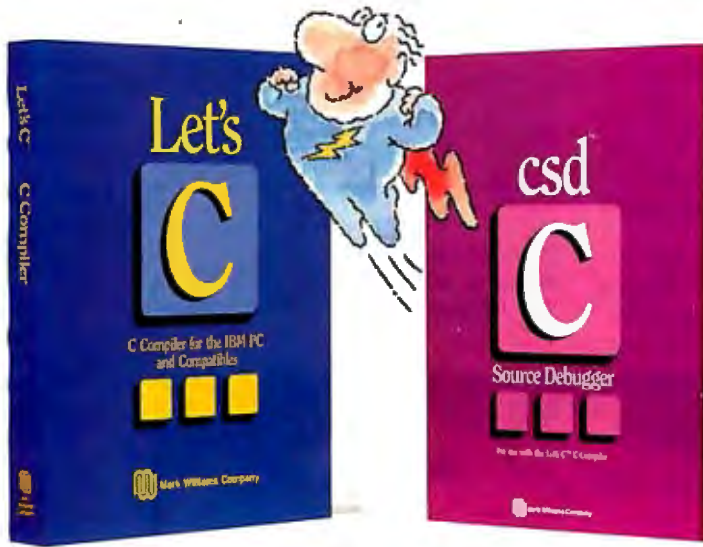

REVIEWERS ARE RAVING ABOUT LET'S C AND *csd*.

"Let's C is an inexpensive, high-quality programming package... with all the tools you will need to create applications."
—William G. Wong, *BYTE*, August 1986.

"The performance and documentation of the \$75 Let's C compiler rival those of C compilers for the PC currently being sold for

\$500...highly recommended..."

—Marty Franz, *PC TECH JOURNAL*, August 1986.

"*csd* is close to the ideal debugging environment...a definite aid to learning C and an indispensable tool for program development."

—William G. Wong, *BYTE*, August 1986.

"This is a powerful and sophisticated debugger built on a well-designed, 'serious' compiler."

—Jonathon Sachs, *Micro/Systems Journal*, April, 1986

START TO FINISH, THERE'S NO BETTER ENVIRONMENT.

Get started with the right C compiler and you'll have everything you need for development—including source level debugging. On top of it all, Let's C and *csd* are today's best values in professional C programming tools. And most reliable: Mark Williams C compilers have been sold with DEC, Intel and Wang computers since 1981.

60 DAY MONEY BACK GUARANTEE

Mark Williams gives you a full 60 days to find out just how good Let's C and *csd* really are—or your money back.

So if you want more than a fast compiler—if you want your programs up and running fast, ask for Let's C and *csd*. You'll find them at your software dealer's, in the software department of your favorite bookstore, through the Express Program at over 5500 Radio Shacks or you can order now by calling 1-800-MWC-1700.*

*In Illinois call, 1-312-472-6659.



1430 West Wrightwood, Chicago, Illinois 60614

© 1987 Mark Williams Company
Let's C is a registered trademark of the Mark Williams Company.
UNIX is a trademark of Bell Labs.

CUT DEVELOPMENT TIME IN HALF WITH *csd*

csd lets you bypass the time consuming frustrations of debugging—like long dumps and clunky assembler. With *csd*, you actually debug in C. You learn faster because you watch your program run in C. You finish faster because *csd* combines the speed of a compiler with the interactive advantages of an interpreter. The end result? Development time is sliced in half.

LIMITED TIME OFFER
FREE *csd* WITH LET'S C!

LET'S C AND *csd* FEATURES

NEW VERSION 4.0!

Let's C:

- Now compiles twice as fast
- Integrated edit-compile cycle: editor automatically points to errors
- Includes both small and large memory model
- Integrated environment or command line interface
- 8087 sensing and support
- Documentation features new lexicon format
- MS-DOS object compatible
- New make utility
- Fast compact code plus register variables
- Full Kernighan & Ritchie C and extensions
- Full UNIX compatibility and complete libraries
- Many powerful utilities including make, assembler, archiver, cc one-step compiling, egrep, pr, tail, wc
- MicroEMACS full screen editor with source included
- Supported by dozens of third party libraries

- For the IBM-PC and Compatibles
- Not copy protected

Sieve Benchmark

(Compile time in seconds)
Let's C: 2.8 (On 512K 6Mhz IBM-AT)
Turbo C: 3.89 (As advertised)

csd:

- Large and small memory model
- Debug in C source code, not assembler
- Monitor variables while tracing program
- Does not change program speed or size
- Provides separate source, evaluation, program and history windows
- On-line help screens
- Can interactively evaluate any C expression
- Can execute any C function in your program
- Trace back function
- Ability to set trace points
- Not copy protected

MARK WILLIAMS LET'S C AND *csd*. ONLY \$75 EACH.

spend more than \$300. We also have to contend with questions about hardware and software bought through mail order.

I use computers; I know what Unix and Xenix are. I have been told that I am honest and know what I am doing in regard to computers. But those very same people who tell me how important it is for them to buy from a knowledgeable source will buy from another vendor because his prices are \$25 cheaper.

There are no easy answers, but one thing is certain: As margins get smaller and smaller, and as retailers must con-

tinue to discount to stay in business, we will have less and less money to pay experienced computer salespeople.

Lee Nelson
Philadelphia, PA

FIXES

Option Update

We stated in the December 1986 What's New section (page 29) that NEC's Multi-

Speed portable computer has as options two external 5¼-inch disk drives. NEC informs us that this is incorrect. The machine "does not need 5¼-inch options because it has a floppy disk transfer port which allows for . . . file transfer from desktop to MultiSpeed and vice versa," NEC says. We apologize for the mistake.

Washington, as in Seattle

Thanks for including notice of our symposium in the Letters section of the March issue. There is, however, an error to be corrected. The letter stated that the symposium will be held in Washington, D.C. Actually, it will take place in Seattle, Washington, on July 12, 1987, the day before the AAAI conference.

Douglas Schuler
Computer Professionals
for Social Responsibility
Seattle, WA

PAL Fixes

Robert Freedman writes to inform us that his article "A PAL Programmer" (January BYTE) requires these corrections: *page 266, Parts List:*

Sprague parts are UCN-, not UNC- as shown.

page 271, Figure 3:

UCN5895A pin 6 should be labeled P13, not P3.

TREFF goes to common pin of 1.0K SIP. +5V goes to pin 2.

page 273, Figure 5:

Upper right: 5.11K resistor is labeled 10 REF on both ends. Lower end should be labeled 10V REF.

Lower right: LS138 should be LS251.

2.5V REF goes to LM339 pin 10.

10V REF goes to LM339 pin 8.

TEST goes to LM339 pins 9 and 11.

Top LS273, pin 1 & /RESET should not be grounded.

page 274, Figure 6:

LS259, data input, pin 13, should go to D0.

LS390 pin 14 /CLR should be connected to GND.

Bubble missing on 7406 pin 4.

Pin 11 of PAL-2 (16R8) must be connected to GND.

page 276, Listing 1:

Equation for SHD2 was omitted:

SHD2 = SD2 & !SD0 & !SD1.

Table 2: 109H: output /ENAB is missing.

page 278, Listing 3:

In pin list, EVCC should be active high—that is, remove ! from !EVCC.

Compatibility Resolved

According to the manufacturer, the GTX-100R 1200-bps security modem from A-O Electronics is not Hayes-compatible, as reported in March (page 32). ■



Z80 68020 C 8051

RISE



to the finest CROSS DEVELOPMENT Software Available

▶ **Does your cross compiler or assembler have limitations?**

▶ **Does it run out of symbols?**

▶ **Does it have trouble with large functions or files?**

▶ **Rise above those limitations and select a product that offers you NO limitations:**

68020 + 68881 C Cross Compiler:
Powerful one-pass optimizing compiler that easily compiles functions and files of any size. Strong type-checking and excellent diagnostics help you meet your deadlines.

from \$995

UniWare is a *complete*, fully-integrated package offering you a powerful linker, librarian, and many utilities.

Available NOW under MS-DOS, XENIX and UNIX

We are so confident of UniWare's capabilities that we will let you use UniWare on your job without risk for 30 days. You must be satisfied. If not, return it for a full refund.

Call Today.
(312) 971-8170

Z80, 8051, 680X0 Macro Assemblers:
Extra long symbol names, unlimited number of symbols and powerful macro facilities are just some of the features you'll receive, and these are just a few of the chips we support; call for others!

from \$295

Developed and Supported by:
Software Development Systems, Inc.
3110 Woodcreek Drive
Downers Grove, Illinois 60515
USA

UniWare is a trademark of Software Development Systems, Inc.
MS-DOS and XENIX are trademarks of Microsoft Corporation
UNIX is a registered trademark of AT&T Bell Labs

WRRROOM.



INTRODUCING FAST FORWARD.[™] NOW ANY SOFTWARE CAN RUN UP TO 10 TIMES FASTER.

No more doodling while your database goes digging. Or lollygagging while your spreadsheet loads. Or taking five while your word processing program takes forever.

With Fast Forward, any software runs 2 to 10 times faster.

CAN SOFTWARE REALLY DO THAT TO SOFTWARE?

Fast Forward can. Normally, your computer is constantly going to your disk and wading through massive amounts of data.

But with Fast Forward, data is retained in your computer's internal memory. Which is incredibly fast. Much faster than hard disks. Hundreds of times faster than floppies.

FAST FORWARD PERFORMANCE

■ With Fast Forward ■ Without Fast Forward

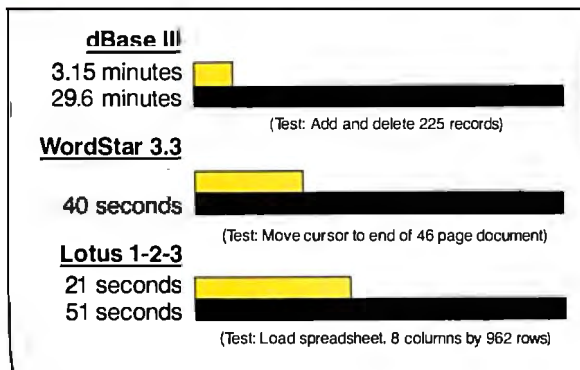

All tests done on 640K IBM PC, 20 megabyte hard disk and floppy drive. 320K RAM allocated to Fast Forward.

THE MORE YOU USE IT, THE FASTER YOU GO.

Once installed, Fast Forward works invisibly. As you use data, it's automatically stored in your computer's memory—and **instantly** available the next time you need it. Programs requiring frequent disk access (like dBase III) will show amazing improvements. And adding extended memory gives Fast Forward more room to work. So software runs even faster.

PERFORMANCE HAS A NEW PRICE: \$69.95.

You can buy a faster computer. Or an expensive accelerator board. But if you're ready to turn on the speed without turning over a bundle of money, ask for Fast Forward. It's from the Mark Williams Company, makers of quality software tools since 1976. And it's available at your software dealer. In the software department of your favorite bookstore. Or by calling 1-800-MWC-1700.* And hurry. Because it'll be going fast.

*In Illinois: (312) 472-6659

 **Mark Williams Company**

1430 West Wrightwood
Chicago, Illinois 60614

Fast Forward runs on IBM-PCs and 100% compatibles. Not copy protected.
© 1987, Mark Williams Company



60-DAY
MONEY-BACK
GUARANTEE

MicroCom Systems
OUTSTANDING SOFTWARE
 For IBM PCs and Compatibles

\$350 PER DISK SMALL QUANTITIES
\$300 PER DISK FOR TEN OR MORE
\$1 OFF 5 DISKS OR MORE WITH THIS COUPON

- BUSINESS 1**—EZ-Forms business form generation, completion and printing program.
- CAD 1**—Altamira, a 4 color object oriented drawing program. Color required.
- COMM 4a,b,c,d,e**—(5 disks) Latest RBBS Bulletin Board System 14.1D.
- DATABASE 1a,b**—(2 disks) File Express menu driven general purpose database mgr.
- EDUCATION 1**—Interactive DOS tutorial for new PC users. Makes learning DOS painless.
- GAMES 1**—3-D PacMan, Kong, SpaceWar, JanitJoe, and more. Color required.
- GAMES 2**—Qubert, Pango, Centipede, Monopoly, Zoarre, and more. Color required.
- GAMES 3**—Blackjack (you set rules), Arm Chair QB, and Empire (War Game).
- GAMES 4**—Castle, Star Trek, and the original Colossal Caves Adventure.
- GAMES 5**—The Hack adventure game from the universities. Like Rogue, only more complex.
- GAMES 6**—Pinball, Othello, Dragons, Sopwith (fly one), and more. Color required.
- INFO 1a,b**—(2 disks) Cooking recipes database with keyword/ingredient retrieval.
- LANGUAGE 5**—Turbo Pascal interactive debugger, pop-up help, formatters, et cetera.
- LANGUAGE 7**—Complete Pascal interpreter/compiler. Great for learning Pascal!
- ORGANIZER 1**—DeskMate, a Sidekick clone, and the Judy calendar program.
- PINUP 2**—Provocative high res digitized graphics pinups. Graphics required.
- PRINTER 1**—Font and sideways utilities, spoolers, banner makers, and more.
- UTILITIES 1**—A collection of invaluable general purpose DOS utilities. A must!
- UTILITIES 2**—More invaluable OOS utilities. Too many to list here!
- UTILITIES 3**—A comprehensive set of debugging and diagnostic utilities.

NEW RELEASES/UPDATES

- CAO 2a,b**—(2 disks) An advanced 2D/3D drafting prog. 640k and color required.
- COMM 1a,b**—(2 disks) Version 2.4 of the ever-popular Qmodem comm program.
- COMM 2a,b**—(2 disks) Procomm 2.42, an excellent modem program with terminal emulation.
- EDUCATION 2**—Learn the Presidents, States (and capitals) and more. Color required.
- EDUCATION 5**—Learn Origami, the Japanese art of paper folding. Color required.
- FINANCES 3a,b**—(2 disks) Express Calc 3.12, a powerful spreadsheet program.
- GAMES 8**—Striker helicopter attack, and Risk, world domination. Color required.
- GAMES 9**—EGARisk, the game of world domination in very high resolution. EGA required.
- GAMES 10**—Solitaire, Teed-Off golfing, and Sailing in the Bermuda triangle. Color required.
- GAMES 12**—MyChess (9 levels), Backgammon, and Wheel of Fortune. Color not required.
- GRAPHICS 1**—Record and play back screen images! Excellent for demo, etc. Color required.
- INFO 2a,b**—(2 disks) Zip-Phone, national areacode/ prefix to zip-code cross reference.
- LANGUAGE 3a,b**—(2 disks) The A86 2.18 macro assembler and debugger.
- SHELL 4**—Automenu menu facility, and HOM II 4.04 hard disk menus.
- UTILITIES 5**—Utilities for formatting, parking, and optimizing hard disk drives.
- UTILITIES 6**—Advanced utilities including Dpath, Esc, Hotdos, Resident program utilities.
- UTILITIES 7**—More Advanced utilities including MasterKey (undeletes files from hard disks).
- WORD 1a,b**—(2 disks) PC Write 2.7, a powerful word processing system, wspell checker.

Catalog available, add \$2. 3.5" format add \$1/disk.
 Cost of Items _____
 CA Res 7% Tax _____
 Ship/Handling _____ Domestic \$1./Foreign \$5.
 Total Enclosed _____

MicroCom Systems
 (415) 325-6500
 P.O. Box 51657, Palo Alto, CA 94303

CHAOS MANOR MAIL

Conducted by Jerry Pournelle

Amiga Defense Redux

[Editor's note: In the March Chaos Manor Mail, Jerry responded to a letter from Warren Block that defended the Amiga as a programming environment and blamed software problems on developers. Mr. Block had included a selection of public domain programs on an Amiga disk that refused to work.]

Dear Jerry,

Here we go again! I had finished putting that disk together at about 3 a.m., and I forgot to include a note telling you to disconnect any external drive before using it. Unplug your external drive and try the disk again. I think you'll like some of those programs a lot.

The problem was that one program (the Mandelbrot program) expects two disk drives. Since I wasn't sure that you had two drives, I used the Assign command to make the Amiga look in a directory on the disk instead of an external drive (called "df1:" by the system).

I don't have an external drive and didn't know this wouldn't work on a two-drive Amiga. As a result, the system gave an error message and quit. (As for ease of use, would MS-DOS handle an error in the AUTOEXEC.BAT file any better?)

So, I am guilty of the same error as those programmers I accused of being lazy or careless. Ouch. I do have an excuse, though: I didn't have any way to test that disk on a two-drive computer.

As for your point that the Amiga may be harder to program than the Atari, I can't say for sure—I don't have an ST. But keep in mind that programmers have been using the ST for a while longer than the Amiga (I'm told it was released in Europe a year earlier than in the U.S.), and it has a less sophisticated operating system—no multitasking, printer support is left up to the individual program, etc. In such a system, programmers can more easily get away with "antisocial activities" that a more advanced OS would choke on. In other words, the Amiga has not yet had a chance to reach the same developmental stage as the ST.

In the meantime, version 1.2 of the Amiga operating system is out. This release fixes the problems of 1.1, and third-party software has begun to appear with real speed.

Warren Block
 Chadron, NE

I pretty well agree on all points; and now that the Amiga 2000, with a PC bus and 8086 chip, is out, I expect to see even more attention paid to the Amiga.

I confess I had figured out what happened before I had your letter printed, but it seemed to illustrate my point rather well—that the Amiga doesn't generally recover gracefully from a lot of errors.

With MS-DOS, you can interrupt the execution of the AUTOEXEC.BAT program, and often it merely ignores errors anyway. Of course, it doesn't do all the Amiga does.—Jerry

Sold on CP/M

Dear Jerry,

Thank you very much for the addresses for CP/M software in the December 1986 Chaos Manor Mail. Regarding the letter from R. Scott Truesdell, I'm glad to see another one has learned the benefits of the SB180. I've been running one almost since Ciarcia's articles appeared. It's a wonderful little beast, with two 5 1/4-inch drives, two 8-inch drives, and a 40-mega-byte hard disk drive on it. I fully agree with you that nothing is truly backed up until it's on 8-inch disks.

I have several clients running CP/M on S-100 systems, and I've converted a couple of them to ZDOS. I've also converted a couple from IBM to the SB180. Let's face it, the IBM PC is far too slow, and PC-DOS is a nightmare for any serious or time-consuming work. I guess the reason so many go the IBM route is that it takes little intelligence to plug in a box.

Like Truesdell, I have too much invested (approximately \$60,000) in CP/M and SB180 software to even think of going with IBM, even if I could afford the waste of time caused by its slow operating system. Any time I have to use an IBM PC at a client's office, I nearly go nuts waiting for it to catch up to me. If you haven't switched to ZDOS, may I seriously suggest you do? It's a whole new world from CP/M: faster, more efficient, and far more labor-saving.

John T. Linnell
 Etobicoke, Ontario, Canada

Well, thanks. I have used ZDOS on the Z-100, and I agree, it's fast; and of course the Z-100 has 8-inch drives. I

continued

"I'll call you right back."

"The check's in the mail."

"It debugs in C like ECHO."

Promises, Promises.

Everybody promises, but nobody delivers a real-time, emulator-based C-debug environment like Arium's ECHO. 16-bit, true multitasking and UNIX-based, ECHO gives you more power, speed and menu-driven features to handle the 68000 and other μ Ps better than the HP 64000, or anything else.

Just words, you say, promises like all the rest?

Prove it to yourself. Read the screens below. Then ask any other development system—standalone or host control—to match them. We'll wait.

Now you know a few reasons (and there are plenty more) why ECHO should be your emulation tool for today's increasingly complicated software debugging.



Code Preview™ lets you see where your code is going. You can follow calls and branches (to 99 levels) on the screen, to select the source line on which to trigger, then set and break in one keystroke! The highlighted trace display (in source) and stack trace window show the path your program took.

Stack-Relative Trigger lets you trigger on the addresses and values of stack-relative variables—a "must" for effective C-debug where the address of an automatic variable is different each time the function is called and is determined at execution. Here, a read of the local variable "nrecur" is included in the trigger sequence.

TimeStamp™ and variable display are two further features that are a must for real-time C-debug. Note the display of two instances of a structure in array "starray." The contents of these structures, as for any C variable, can be changed right on the screen.



For a demonstration call
800/862-7486 (CA 714/978-9531)



1931 Wright Circle, Anaheim, CA 92806

Inquiry 25 for End-Users. Inquiry 26 for DEALERS ONLY.

think that if I didn't do this column, and thus have some need for playing about with a lot of stuff, I could have been happy with my Z-100 with CP/M and ZDOS, from the time I got the machine until now. Indeed, we have some upgrade kits for the Z-100 that I'm about to install.

CP/M isn't dead. It isn't growing as fast as the other systems, but that could change now that Concurrent DOS 5.0 is shipping.—Jerry

Dear Jerry,

In previous columns you have men-

tioned "The Pournelle User's Guide Series." My local bookstores do not have any of the books in this series, and after trying for three months they have still been unable to get them. (Maybe being in the wilds of New Mexico has something to do with this.)

This morning I called Simon and Schuster, at (800) 223-2348, and ordered the series. (They knew all about the books.) Maybe this will help other readers who are having trouble finding these excellent books.

I have long thought about getting a por-

table laptop but could not justify the cost (including the necessary accessories) of the available systems. I finally purchased an Epson Geneva PX-8 system (including the Epson P-80 portable thermal printer) for \$430.

The Geneva weighs 8 pounds. With the Multi-Unit (64K-byte RAM disk and 300-baud auto-answer, auto-dial modem) and MicroPro Portable WordStar in ROM, it makes a fine portable word-processing system. The Geneva also comes with MicroPro Portable Calc Spreadsheet, Portable Scheduler, Microsoft BASIC, and (to me the best feature) CP/M, all in ROM.

Most of the public domain CP/M programs run as is or have been rewritten to run on the Geneva's 8-line by 80-character screen (reasonably legible even in poor light). I still need the 12 pounds of documentation, excellent by the way, that came with the system until I learn the programs and CP/M.

The built-in microcassette drive will save files up to 50K bytes, but it takes forever. The addition of Epson's PF-10 3 1/2-inch disk drive, Traveling Software's Traveler's Pak (appointment, expense, and time manager) from DAK Industries Inc., and Wordpak (Spellguard, Footnote, Documate, and Grammatick) makes the Geneva a very powerful and complete portable system.

I can now appreciate your love of a laptop and the utility of the CP/M system.

I don't believe I have seen FOG (First Osborne Group, P.O. Box 3474, Daly City, CA 94015, (415) 755-2000) mentioned in your column. This group publishes the FOGHORN, a monthly CP/M newsletter supporting Osborne and most other CP/M computers. Readers using CP/M may find it helpful.

CP/M is still very much alive.

Webb V. Turner Jr.
Las Cruces, NM

P.S. There is only a serial printer port on the PX-8, and my NEC printer is parallel only. I have now purchased an MPI-99 printer (because of your recommendation and the super close-out price from Heath) to connect to the serial printer port of the PX-8: It is a strange and wonderful printer!

Things flow in micro land. I haven't written about MPI printers in a long time. They have lots of good features but have to some extent been overtaken by many others. Still, if you can get one cheap, I'd grab it. We still use our Sprinter for travel.

Glad to hear about the Epson Geneva. I've never actually seen one, strange to say.—Jerry ■

NOW, GET GREAT LETTERS and Great Numbers.

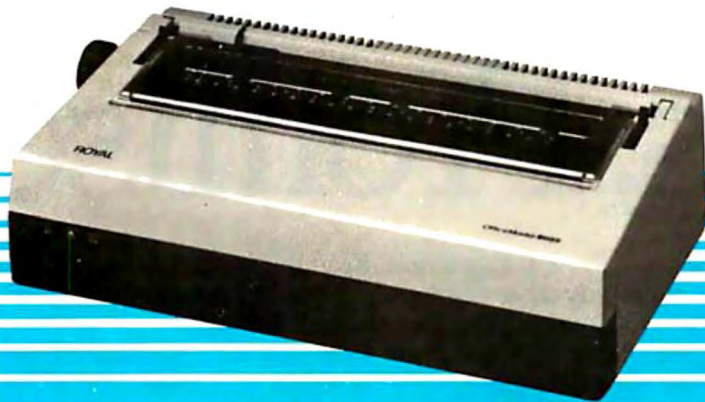

ONLY \$299!

ROYAL™ OfficeMaster 2000 Daisywheel Printer

For \$299, you used to have to settle for a dot matrix. But right now you can get the impeccable letter quality of the Royal 2000 daisywheel printer. The true quality needed for correspondence, presentations, proposals and legal documents.

Previously selling as high as \$595, now it's an incredibly low \$299! Precision-built in Germany, the Royal name means it's a hardworking, easy-to-use, reliable printer. The Complete Electronics name means it's supported with service and backed with a great warranty. So, don't settle for less. Check the list of performance and convenience features. And order now!

- Compatible with virtually all popular systems • Full Diablo™ 630 compatibility
- 1.5K print buffer built-in • Graphics plotting • Centronics parallel interface
- Variable line and character spacing
- Proportional spacing • 10/12/15 pitch

- Shadow print, underline, sub, super script printing • Bi-directional printing at 20cps (Shannon Text)
- Super quiet operation (< 57db)
- 1 year limited parts warranty/90 day parts and labor warranty!**

ROYAL SAVINGS ON ACCESSORIES, TOO!

- Cut Sheet Feeder - Was \$329 - Now \$199!
- Tractor Feed - Was \$179 - Now \$99!
- Printwheels \$19.95! • Ribbons \$5.95!
- Cable \$19.95

SPECIAL PRICES LIMITED TO STOCK ON HAND. ORDER NOW!

1-714-458-0130

Please have computer make and model information handy.



MasterCard • Visa • American Express

Diablo is a registered trademark of Xerox.
Royal is a registered trademark of Royal Business Machines, Inc.

Complete Electronic Peripherals, Inc.

Sales complete with support.

9272 Jeronimo, Building 116, Irvine, CA 92718 • (714) 458-0130

INTRODUCING 1-2-3, dBASE AND 21,398 OTHER PROGRAMS FOR UNIX.

Now you can run DOS on your AT or compatible while others use UNIX from their terminals. With DOSMERGE™, the program that lets you chart profits with Lotus 1-2-3 while they enter sales and check inventory under UNIX. Even use the best programming utilities from DOS and UNIX on the same files without reformatting or partitioning your hard disk. So you can compile a UNIX program and run a UNIX utility while editing text under DOS.

DOSMERGE makes virtually all the 20,000+ DOS applications instantly available to the UNIX world. With no formatting fuss or transporting trouble. You get the advantages of a double standard. Without doubling the price.



That's the kind of thinking you've come to expect from Microport, the company that brings you a real UNIX System V for only \$199. Including 24-hour support. Microport is the leader in logically priced UNIX and UNIX applications like Informix, Unify, RM-COBOL, R-Office etc.

And, we're first to the future with real UNIX and DOSMERGE for 386-based PCs. Available right now.

Honest to AT&T UNIX for \$199.

And DOSMERGE for an additional \$149. Order today on our 30-day, money-back guarantee. Or just ask for our free information pack. But hurry, the first 400 callers mentioning this ad receive a special UNIX discount coupon. Run run run to your phone. You'll be running DOS under UNIX faster than you can say 1-2-3.

Free information:
(800) 722-UNIX
(800) 822-UNIX
in CA

Real UNIX*, \$199.



Microport Systems, Inc. 10 Victor Square · Scotts Valley, CA 95066
(408) 438-8649 Telex: 249554 MICR UR FAX: (408) 438-2511

Inquiry 185

*A real Unix System, System V/AT \$199 (2 user); Software Development System \$249; Text Processing System \$199; Complete System \$539; Call for System V 386 and 386 DOSMERGE pricing. Unix is a trademark of AT&T. System V/AT and DOSMERGE are trademarks of Microport Systems, Inc. Other brands and products are trademarks of their respective holders.

BEWARE OF THE AT MEMORY GREMLINS



See us at booth #406
COMDEX/Spring '87
 June 1-4, 1987
 Georgia World Congress Center
 Atlanta, GA

ONLY ECCELL™— THE ECC-PROTECTED MEMORY CARD— CAN KEEP YOU FROM BECOMING THEIR NEXT VICTIM.

If you're a serious AT user, you live in constant fear of seeing this memory error message:

PARITY CHECK 2

That's your friendly AT's way of saying, "All your long hours of hard work just went down the tubes."

About then you start suspecting gremlins in your AT's memory. The fact is, these errors can be caused by a *single* bad RAM bit out of a possible *256 million**. The odds are against you.

Whatever the cause, these memory crashes become more common when you add a lot of AT memory or leave your system on day and night—like you do for network file servers, bulletin boards or host emulation.

*Based on 16 megabytes of RAM.

Now the good news. One memory card offers a solution to this potentially disastrous problem: Orchid's ECCELL.™ And *only* ECCELL.

KEEP WORKING WHEN THE CHIPS ARE DOWN.

With ECCELL, you're protected against losing all your valuable work due to AT memory crashes. Only ECCELL uses an ECC (Error Correction Code) mechanism to continuously check for errors—and actually *correct* them before they can do any harm. *No other AT memory card does this.*

ECC protection has been available on mainframes and minicomputers for years. Now ECCELL brings this sophisticated technology to the AT user.

MEAN TIME BETWEEN FAILURES: (Based on 6 Megabytes of RAM memory)

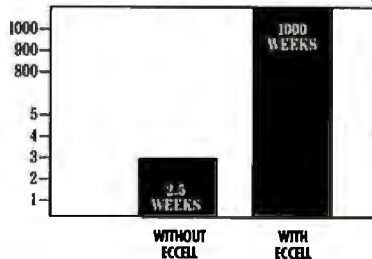

HANDLE DOS, PROTECTED MEMORY AND EMS.

ECCELL gives you conventional DOS memory up to 640K. Extended memory that supports protected mode DOS. And expanded memory conforming to the Lotus®/Intel/Microsoft® EMS standard. Plus ECCELL can be used with other AT memory expansion cards.

DON'T PAY EXTRA FOR I/O PORTS YOU DON'T NEED.

If you need to connect more peripherals, ECCELL offers optional serial/parallel or dual serial ports. Unlike other cards, if you don't need them, you don't pay for them.

ADD 3 MEGABYTES OF RAM PER CARD.

Using multiple ECCELL cards, you can install up to 12 Megabytes of ECC-protected RAM. Installation takes only minutes, guided by an intelligent set-up program.

So don't become the next victim of the AT memory gremlins. Protect yourself with ECCELL. Call (415) 490-8586 today. Or contact your local dealer.

ECCELL is a trademark of Orchid Technology. All other product names are trademarks of their manufacturers.

ECCELL™

ORCHID TECHNOLOGY
 45365 NORTHPORT LOOP WEST
 FREMONT, CA 94538
 (415) 490-8586; TIX 709289.

ORCHID (EUROPE) LTD.
 UNIT 9A, INTEC-2,
 WADE ROAD,
 BASINGSTOKE, HANTS,
 RG24 0NE,
 GREAT BRITAIN.
 TEL 0256-479898;
 TLX 946240;
 REF: 19023380



Inquiry 214 for End-Users.
 Inquiry 215 for DEALERS ONLY.

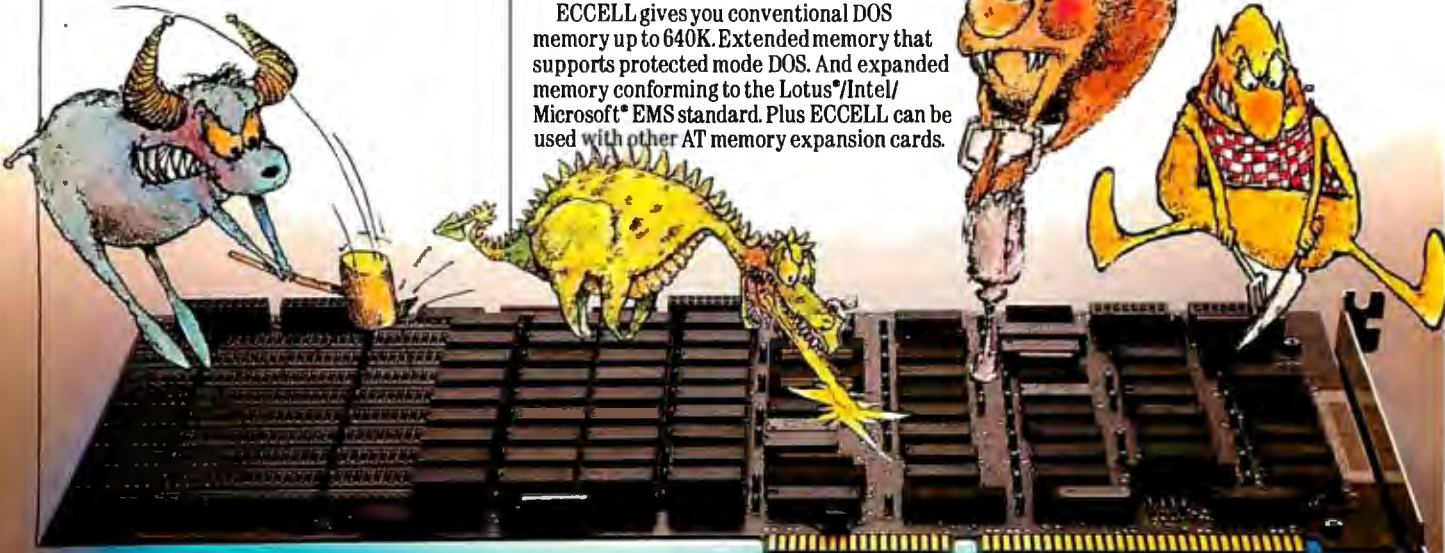

MICROBYTES

Staff-written highlights of developments in technology and the microcomputer industry.

Planar Prototypes Multicolor EL Displays

Planar Systems (Beaverton, OR) has developed prototypes of 5-inch, 320- by 240-pixel, multicolor electroluminescent (EL) displays. Planar engineering manager Brian Dolinar told Microbytes that although the full-color subsystems will be used in environmentally harsh military applications as early as 1990, commercial displays won't be available until at least 1994. The prototypes provide full RGB video and can produce displays with pattern red, green, and blue phosphor dots or in a stacked color dot structure; they can also support from four to eight gray levels, Planar said.

In general, EL displays, which are made by applying thin films of phosphor onto glass substrates, are characterized by their thin profile, high shock resistance, high contrast and resolution, and low power requirements.

Additionally, EL displays interface much like raster CRT displays, enabling hardware designers to use standard display controllers. Power requirements for EL units are typically about 2 watts for the display itself and 14 W for electronic overhead. According to Dolinar, Planar's goal is to have total power requirements for the multicolor EL unit down to a maximum of 10 W. EL displays used in jet fighters routinely operate in temperature ranges from -55 degrees Celsius to +125 degrees C and withstand shocks and vibrations in the hundreds of Gs.

Monochrome EL displays are currently used in portable PCs (Data General's, for example) as well as in industrial control and military settings. Planar previously fabricated two-color (red and green) EL displays for military applications.

Berkeley Unix Going Through Changes

Significant changes to Berkeley Unix are underway, say computer scientists at the University of California's Berkeley campus, but it will probably be a couple of years before users see those changes fully implemented. Marshall McKusick, a scientist with UCB's Computer Systems Research Group, told Microbytes that three major areas of Unix 4.3 BSD are undergoing development: the virtual memory system, the file system interface, and the protocol layering interface.

According to McKusick, "the file system is pretty much operational now," and, because the work is being completed "serially," modifications will be released incrementally. This file system interface uses the 4.3 BSD name-lookup calling convention, but otherwise resembles Sun Microsystems' Virtual File System (VFS) interface.

Future versions of Berkeley Unix, said McKusick, who is working with Michael Karels on the project, will "support virtual memory space at least as great as the sum of sizes of physical memory plus swap space." Additionally, processes will probably be allowed to map files and device memory

into their address spaces and to share memory with other processes.

The protocol layering interface McKusick and Karels are working on will be based on the simple stackable-line discipline of the Eighth Edition Unix rather than the Streams implementation of System V, release 3. McKusick and Karels plan to implement a socket interface rather than a character device interface, and protocols in the kernel will handle the demultiplexing.

McKusick added that "a major change we have made is that we are basing our releases on hardware made by Computer Consoles Inc. We did that because DEC [4.3 BSD is based on Digital Equipment Corp. hardware] was getting to the point where they felt they were competing with us. It was getting difficult to get documentation and so on. Our next beta release will likely be based on CCI." McKusick said that "we are making it [Unix] more portable by doing this. . . . By going to completely different hardware, we've had to face a number of issues that manufacturers have had to face all along."

continued

Nanobytes

Notables and quotables from the West Coast Computer Faire: While Intel was telling Fairegoers that software for its 80386 is on the way, Motorola was claiming its 68020 is the superior processor, partially because of its binary upward compatibility. "The Intel compatibility problem is a nightmare," said Motorola's Kevin Meyer. Someone from Apple Computer said the linear address space of the 68000 series is better suited to bit-mapped graphics and memory-mapped I/O than is the segmented address space offered by Intel. . . . Philip Gill, contributing editor for *Information-week*, told a session on Unix that some users of Xenix on 386-based machines are claiming performance twice as fast, and half as costly, as that of a mini-computer. Brian Boyle, director of research at the Novon Research Group, said Unix on 386 machines will be like an automobile's electrical system: You know it's there, but you have little interaction with it. . . . Dan Bricklin of VisiCalc fame said the development of 16-megabit RAM chips could usher in an era of diskless computers; drives will be junked because of their slowness. . . . At one session, panelists agreed that, for good or bad, Pascal programmers will turn increasingly to other languages, primarily Modula-2, to build more powerful applications. They said Pascal has remained an educational tool and has not moved into programming environments dominated by C. . . . And if you've been waiting for a solution to all those RAM-resident conflicts, well, you've got some more waiting ahead. Without standards, panelists said, software houses can do little to keep their pop-ups

continued

from clashing. The panel members also concurred that RAM-resident software is very tough to implement in multitasking environments because the status of RAM is always changing, which leaves open the question of how these programs will fit in with the new multitasking operating systems. . . . At its spring-time developers' conference, **Apple Computer** (Cupertino, CA) officials said it is interested in these types of products from third-party designers: lab instrumentation boards, industrial cards for process control, communication cards, sound and music peripherals, 68020 accelerator boards, graphics coprocessor cards, expansion cages, and multifunction cards. . . . **Information Storage** (Colorado Springs, CO) says it will bring out in the fourth quarter a WORM drive that stores between 480 and 550 megabytes on each side. . . . **Falcon Technology** (Glendale, CA) has brought out an instrument that measures five system parameters of 8088- and 8086-based machines. The Mipster (\$495) consists of a probe that plugs into the microprocessor socket of the system being checked (and into which the system's processor is reinserted) and a seven-digit LED readout that displays the parameters. It measures machine speed, clock frequency, memory accesses, I/O accesses, and number of times the instruction stream queue is flushed. Probes for the 80286 and 80386 will be available later this year, a company executive said. . . . At the National Computer Graphics Association's annual show, **Cricket Software** (Philadelphia) was running a prototype of its Cricket Draw graphics package in color on a Macintosh II. The final release of the new version will support 256 simultaneous colors from a palette of 16 million, the company said, and will sell for \$395. . . . **Commodore** (West Chester, PA) was showing its newest Amigas, the 2000 and the 500, at the NCGA conference; but the machines were adorned with little notes indicating that because they had not yet passed

continued

Programmers Debate Languages, "Corporate" Programming

Some of the micro industry's best-known programmers gathered recently in San Jose, CA, to talk about how they do what they do. Although the panel—consisting of Bob Carr, Andy Hertzfeld, Scott Kim, Charles Simonyi, Jaron Lanier, John Page, Jef Raskin, Peter Roizen, and John Warnock—did not discuss projects they are currently working on, they did discuss the future of programming languages and how programmers can survive in a corporate environment.

Hertzfeld (developer of the Macintosh operating system) and Carr (chief scientist for Framework-maker Ashton-Tate) said they prefer programming in assembly language. Roizen (developer of T/Maker) and Lanier (former Atari video game programmer) work with Pascal. But Simonyi (from the Microsoft group that has produced Multiplan, Word, and Excel) generally spoke for the group when he said that C is probably the only general-purpose language for most software development. "At Microsoft, we program only in C," he said. "C now and C forever."

Raskin, one of the creators of the Macintosh, pointed out, however, that certain programming tasks often require certain languages. This view was seconded by Carr, who said that the software marketplace will probably become fragmented, making it more exciting than the "homogeneous software environment we've seen over the past couple of years." That environment, he said, will have specialized vertical programs that may be written in specialized languages, perhaps even macro languages that are part of applications programs themselves.

The programmers debated the virtues of single-person programming ver-

sus "corporate" programming (in which a team of programmers produces a product). Hertzfeld bluntly stated, and Roizen and Kim (author of the book *Inversions*) concurred, that the best programs are written by a single person. Page (of Software Publishing and PFS fame) disagreed, however, saying it just isn't realistic for a large company to expect an individual to produce enough code to get a big product out in a timely fashion. Carr agreed, saying that the hundreds of worker-years it takes to build a program such as dBASE or Framework makes it impossible for a company to afford the luxury of "one programmer, one program." Warnock said Adobe has found that a three-person programming team is the most effective. "Two people isn't enough and four is too many. That third person in the group adds balance," the developer of PostScript said.

The panelists also disagreed about the increasing tendency among programmers to use third-party subroutine libraries. Both Carr and Page said they feel that off-the-shelf routines can save programmers both time and money. Hertzfeld countered by asking, "How can you care about your program if you use someone else's code?" He continued, "I consider myself an artist. If I were another kind of artist, a writer for instance, would it be right for me to go out and buy a paragraph here, a chapter there, and include them in my book? Would it still be mine?" Kim added that it usually takes him longer to read and understand another person's code than it does to write it himself in the first place. All the programmer panelists, however, said that over the years they had put together their own subroutine libraries, which they regularly use.

Optical Head Combines Hologram and Lasers; Could Mean Lower-Cost Optical Drives

An optical disk head combining holography and lasers has been developed by researchers at Pencom International (Santa Clara, CA). According to its inventor, Dr. Wai-Hon Lee, the technology could eliminate as many as nine common components (beam-shaping lens, toroidal lenses, wave plates, mirrors, etc.) from standard L-shaped optical heads, resulting in higher performance and lower costs for optical drive manufacturers and,ulti-

mately, users. Lee explained that the reduced weight (6 grams, as compared to a standard of about 400 grams) of such a head will speed up disk access time by factors of 5 to 10.

Key to the design of the Pencom head, Lee said, is a hologram that serves as both the beam splitter and the focusing optic. Equally important, he said, is the combining of the focus detector and the laser in a single pack-

continued

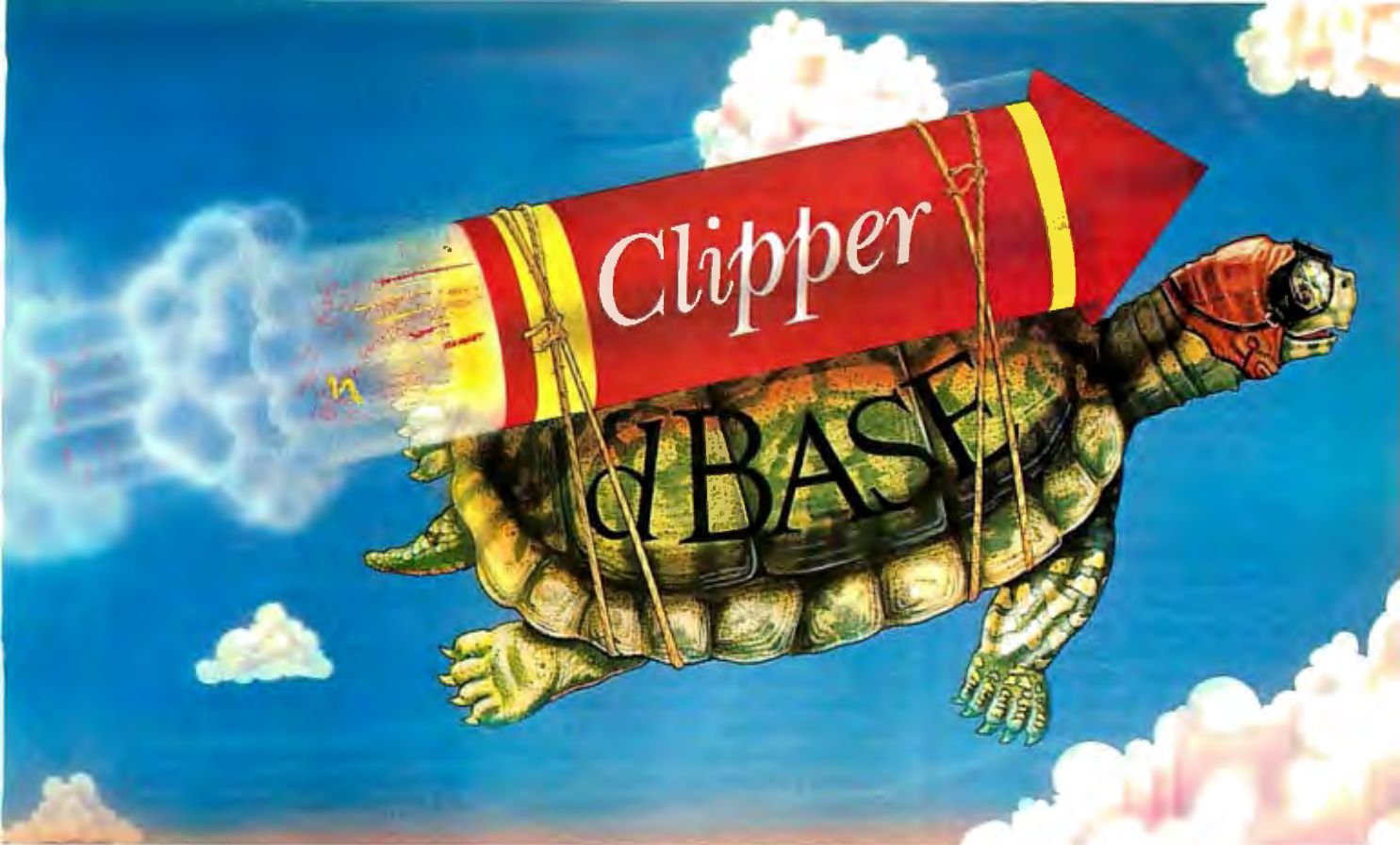

Real programmers don't use dBASE. Or do they?

We're finding that some very swift programmers are using it to write some very fast applications, and are completing their projects much more quickly.

But they cheat.

They use our Clipper™ compiler to combine dBASE™ with C and assembler.

With dBASE used like pseudo-code, they can then quickly create prototypes that actually run.

Then, with dBASE doing the high-level database functions, they use our Clipper compiler to link in C or assembly language modules from their own bag of tricks.

And they're finding that they're linking in less than they expected because Clipper compiled code runs so fast and because of Clipper's built-in enhancements.

Clipper includes easy networking that provides file and record locking the way it should be done.

Fast screens that can be treated as memory variables and eliminate the need for direct screen writes and all that tortuous heap management code.

Box commands that make windowing a breeze. And more.

So if you'd like to use your time more productively, check us out: Nantucket Corporation, 12555 W. Jefferson Boulevard, Los Angeles, CA 90066.

Or if you're on deadline, call (213) 390-7923 today.

Clipper could get you out of the soup.

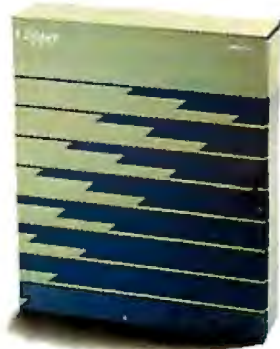

Turtle Souped

 Nantucket®

© Nantucket Corporation 1987. Clipper is a trademark of Nantucket Corporation. dBASE isn't. In Europe: Nantucket Corporation (Europe) 2 Bluecoats Avenue, Fore Street, Hertford, Herts SG14 1PB Telephone 0992 554621.

FCC certification tests, they were not for sale. . . . The **Association of Electronic Cottagers** (Davis, CA) says the top 10 ways for making money at home with a computer are consulting, typesetting, bookkeeping, writing, entering and processing data, researching, word processing, custom programming, desktop publishing, and providing mailing lists. . . . At the "request" of the **National Security Agency, Versitron** (both of Washington, DC) canceled its "How Computer Security Can Be Compromised" seminar at the Interface '87 conference. Versitron was going to demonstrate how data can be stolen from a computer using passive listening techniques. . . . At that same conference, **Dataradio Corp.** (Atlanta) introduced a wireless modem capable of transmitting data over radio channels at as much as 9600 bits per second. The Dataradio Series 9600 is designed to replace leased phone lines or provide data circuits where dedicated lines are not available. . . . You won't be seeing this at your local video shop: **The Boston Computer Society** has produced a series of videotapes on creating software. "There are 14 seminars in the series," the BCS says. "Many are by 'gurus' of the industry who took time out from doing in order to teach and share code." The series sells for \$350. Contact the BCS Software Engineering Forum, 59 Morseland Ave., Newton, MA 02159; or phone (617) 738-8230. . . . When asked at the West Coast Computer Faire to assess the impact of superconductors on new products at Apple, Steve Sakaman of that company said, "It took us a long time to put a fan in the Mac, so it might be a while before we put a refrigerator in it."

age. In Pencom's system, the laser beam passes on a straight line through a single collimating lens and then the hologram before focusing on the media. When the beam returns from the media, the hologram refracts the beam slightly, returning it to the tracking detector.

In general terms, a hologram is an interference pattern between two light

beams. The pattern Lee developed is calculated and generated by a computer, then transferred to a semiconductor-like mask before being replicated onto a glass lens.

Currently, several companies are evaluating the Pencom head. Lee said he thinks optical drives that make use of the holographic-laser head may begin appearing in about six months.

Active-Matrix LCD Called the Display of the Future

Active-matrix liquid crystal displays will be the "the next evolutionary step" in display technology, said panelists at the West Coast Computer Faire recently. According to David Mentley, a display research analyst with DEM Associates (El Cerrito, CA), active-matrix LCDs have already been accepted by makers of small-screen, personal TVs and will be a driving force in developing the technology for computer displays. Mentley predicted that within the next year or so, we may even see "personal portable computers" that have the same 3-inch full-color screens now available for televisions.

Active-matrix technology is based on positioning a transistor and capacitor at each pixel on the screen. This enables full color at high resolution. It also eliminates commonly encountered multiplexing problems, because an entire line on the display can be turned on or off in less than 6 microseconds.

The biggest development problem with active-matrix panels is that engineers cannot yet build ICs that are large enough to power the displays. This

explains why the 3-inch diagonal screens are the most commonly found: The IC must be the same size as the screen. The largest active-matrix prototype he has seen, said Mentley, is a 14-inch diagonal screen, although the largest acceptable screen is only 6 inches in diagonal. Recent advances in thin-film transistor technology, however, indicate that larger acceptable screens may be possible in the near future.

Mentley reported that several companies, including General Electric, Hitachi, IBM, Matsushita, NEC, Sharp, Toshiba, and Xerox, have very large active-matrix programs underway. Current manufacturing costs for active-matrix panels is about \$10, Mentley said, with OEM prices around \$85; he noted that the price of active-matrix LCD televisions has dropped to as low as \$125. Mentley concluded by saying that costs of software drivers will be a factor in determining the eventual costs for PCs because active-matrix drivers cost more to develop than traditional LCD panels.

Device Controls Execution of Programs

Rainbow Technologies (Irvine, CA) has a new hardware key that developers can use to control access to as many as 10 software programs. The Software Sentinel-M has a clock/calendar that lets developers set individual time-outs; the internal counter can be set to monitor a certain number of program executions and then deinstall the program, which can be handy for applications such as software rental and trial usage. Company president Walter Straub said developers can "marry software

to the hardware key" as an alternative to traditional copy protection.

The key hooks to the parallel port of IBM PCs and compatibles and runs under MS-DOS. Straub claimed the Sentinel-M's algorithm technique offers more security than designs based on serial number, fixed response, or returned-pulse methods. The Sentinel-M sells for \$50 in quantities of 500 to 1000. According to the company, a model that plugs into a serial port is in the works.

TECHNOLOGY NEWS WANTED. *The news staff at BYTE is always interested in hearing about new technological and scientific developments that might have an impact on microcomputers and the people who use them. We also want to keep track of innovative uses of that technology. If you know of advances or projects that involve research relevant to microcomputing and want to share that information, please contact us. Call the Microbytes staff at (603) 924-9281, send mail on BIX to Microbytes, or write to us at One Phoenix Mill Lane, Peterborough, NH 03458.*



It takes four of theirs to display the same spreadsheet as one Amdek 1280.

Now, Lotus 1-2-3 and Symphony can be even easier and quicker to run. Because Amdek's 1280 graphics subsystem displays up to four times more spreadsheet than a standard IBM monochrome or compatible monitor.

For incredibly vivid resolution, the Amdek system puts 1280 X 800 pixels on a big 15" white phosphor CRT.

There are a total of 11 modes. What's more, the 1280 provides complete monochrome and color graphics compatibility.

Price? The Amdek 1280 monitor and video board cost only \$999. So, if you work with Lotus, CAD or desktop publishing, Amdek's 1280 graphics subsystem is clearly your best buy.

The Amdek 1280 provides 1280(H) X 800(V) resolution with these software packages:

GENERAL PC SOFTWARE

Lotus 1-2-3
Symphony
PC-Paintbrush

DESKTOP PUBLISHING

AdvanTex
Ventura Publisher
PageMaker/PC
Frontpage
DeskSet
Pagemaster
Rim Systems
Compound Document Processor
Display Ad Make-up System

COMPUTER-AIDED DESIGN

AutoCAD
Cadvance
Drafix 1
In-A-Vision
Generic CADD
VersaCAD ADVANCED
Workview
Procad PC
P-CAD System

GRAPHICS SYSTEM TOOLS

MS-Windows
GEM
MetaWindows
HALO
KEE PC



AMDEK

Clearly the finest in monitors.

1901 Zanker Road, San Jose, CA 95112
Phone: 408/436-8570 FAX: 408/436-8187

How to 386

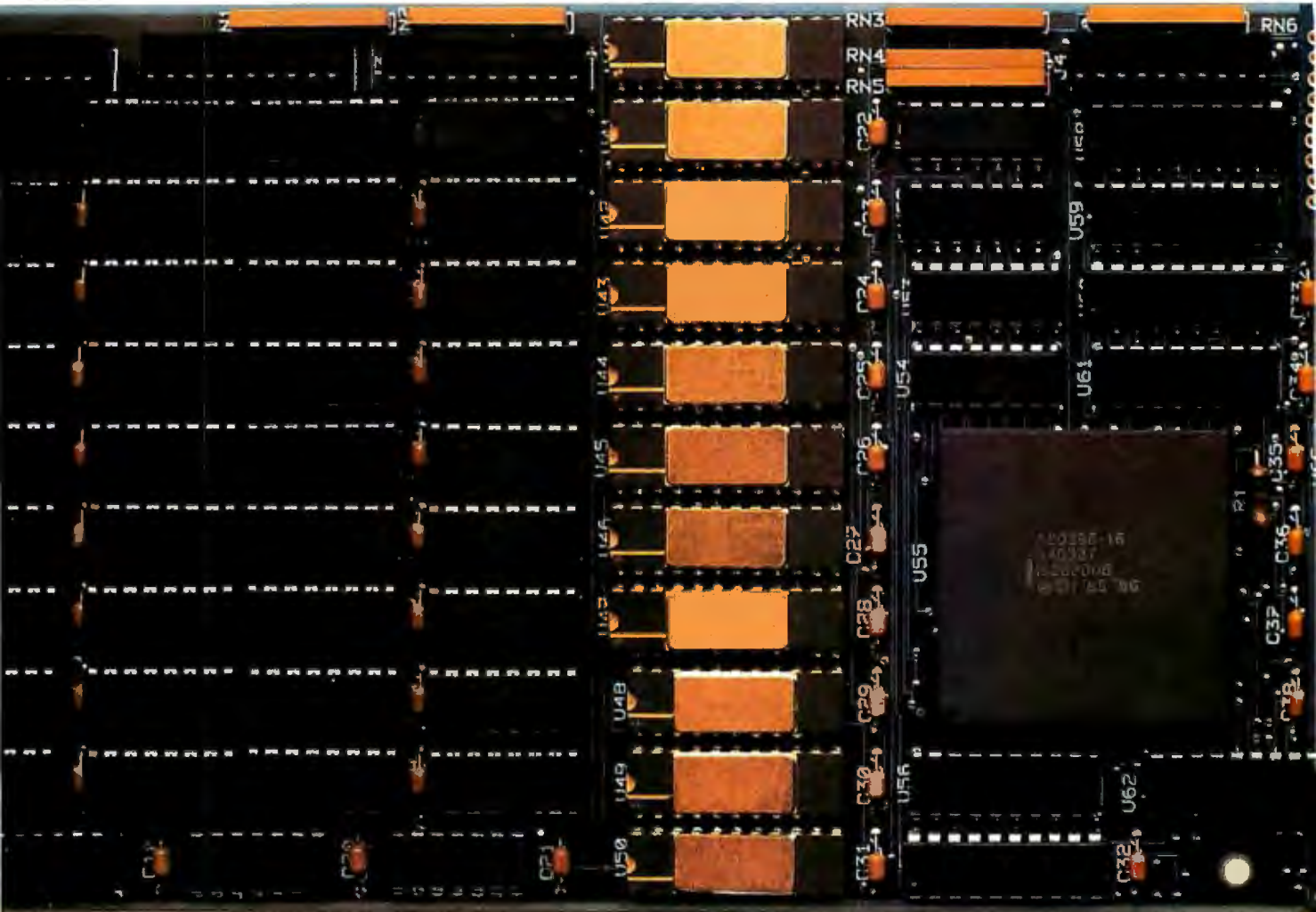

It's simple.

With Intel's Inboard™ 386/AT.

It fits right into your IBM® AT or compatible, and gives you all the performance of a 386 system.

Without having to buy a 386 system. (Which, if you've priced one lately, is about three times as expensive.)

Inboard 386 is based on the revolutionary 32-bit, 16 MHz 80386 chip *we* invented. So it'll work with all the

software you've got sitting on your desk. As well as any add-in boards you may have hiding in your computer—like, just for instance, the Above™ Board. Which we also invented.

Inboard 386 lets you whiz through recalcs with Lotus® 1-2-3®. And it makes your network server serve you even faster. In fact, it'll make any program serve you faster.

And with 386 control software,

Inboard and Above are trademarks and Intel a registered trademark of Intel Corporation. IBM is a registered trademark of International Business Machines Corp. Lotus and

your AT.



you can take advantage of exceptional multitasking capabilities. Like putting together a presentation while your computer is downloading data. (A slightly more efficient way of doing business.)

Don't forget our five-year warranty. Or toll-free technical support line.

1-2-3 are registered trademarks of Lotus Development Corp. © 1986 Intel Corporation

To find out more, check with your favorite computer dealer or call us at (800) 538-3373.

And see why Inboard 386 beats the system.

intel[®]

MAXIMIZE YOUR MULTISYNC™

Lots of EGA boards will take you this far.

A few will take you to here ...



*But now you can maximize your MultiSync—
with Genoa's SuperEGA™ ...*

*and SuperEGA HiRes™,
both with AutoSync™!*

15.75 KHz	18.75 KHz	21.8 KHz	30.0 KHz	31.5 KHz	35.0 KHz
CGA 320 x 200	MDA (Hercules) 720 x 348	EGA 640 x 350 1056 x 352 132 col. x 44	PGA resolution 640 x 480 Drivers for: Lotus 1-2-3, AutoCAD, GEM, Windows, and Desktop Publishing	CGA DoubleScan: 320 x 400 640 x 400	CAD/CAM 800 x 600 Drivers for: AutoCAD, Windows, GEM, and Desktop Publishing

Now you can maximize your MultiSync monitor—with a SuperEGA card from Genoa. SuperEGA gives you CGA (including double-scan!), MDA (Hercules), EGA, and PGA resolution—and 132 columns. Or you can get the SuperEGA HiRes card for your advanced CAD/CAM and desktop publishing applications.

Both SuperEGA cards feature AutoSync; they automatically synchronize with all MultiSync speeds, from 15.75 up to 35 KHz.

The SuperEGA HiRes is the *only* EGA board with 800 x 600 resolution, and it comes with the drivers you need for CAD/CAM and desktop publishing.

For all your graphic applications, you can count on SuperEGA. We've maximized the MultiSync!

Call or write: Genoa Systems Corporation, 73 E. Trimble Road, San Jose, CA 95131; Telephone: 408-432-9090, FAX: 408-434-0997, TELEX: 172319



WHAT'S NEW

Information from this month's most interesting press releases.

Shock-Proof Removable Hard Disk

Tandon's Personal Data Pac is a removable hard disk drive designed for easy transport and durability. Designed for the IBM PC and compatibles, the Pac is a 3½-inch dual-platter 30-megabyte hard disk drive in a hard plastic enclosure about the size of a full-height floppy disk drive. You can easily attach it to an external adapter that contains two slots for the new drives and a caching disk controller.

The Data Pac's drive heads are locked away from the media when not in use. Each pack weighs about 2.6 pounds and measures 2½ by 4¾ by 7 inches, for easy transport in a briefcase.

The Data Pac's drive tests have shown that Pacs can withstand up to 300 Gs of force, (or a drop of 30 inches onto concrete) without losing data or breaking the plastic case.

The data transfer rate for Pacs is 7.5 megabits per second with a maximum access time of 50 milliseconds and average seek length of 100 ms. Each Personal Data Pac can be password-protected by using a special utility. **Price:** \$400; Ad-PAC 2 subsystem (holds two Data Pacs), \$500.

Contact: Tandon Corp., 405 Science Dr., Moorpark, CA 93021, (805) 523-0340. **Inquiry 576.**

Q&A for the 386

The database and word-processing program Q&A is now available for 80386-based systems. The 386 version takes advantage of the Lotus/Microsoft/Intel Expanded Memory System



Tandon's 30-megabyte Personal Data Pac.

(LMI/EMS), letting you access memory above the DOS limit of 640K bytes. Symantec reports that the instruction set increases speed by 10 percent to 40 percent, and that the code size has decreased by about 20 percent. The original 8086 version of Q&A will run on 386-based systems, but without the increased speed and memory advantages of the 386 version.

Q&A requires an Intel 80386 microprocessor, 512K bytes of RAM, and MS-DOS version 3.0 or higher. **Price:** \$349. **Contact:** Symantec Corp., 10201 Torre Ave., Cupertino, CA 95014, (408) 253-9600. **Inquiry 577.**

Hand-Held Scanning

The Handscan is a mouse-like data-entry device that lets you enter portions of printed or typewritten documents directly into an applications program such as Lotus 1-2-3, dBASE III, Microsoft Word, R:base 5000, WordStar, or any program that accepts ASCII data. Working with proprietary memory-resident optical-character-recognition software, the Handscan recognizes more than 200 computer-generated or typewritten fonts. When you enter the font name into the computer, the Handscan displays the name of the recognized font on the screen.

The unit has five push-buttons: one for reading data, and four for cursor movement that let you move around an applications program

screen without having to use the keyboard cursor keys. The unit is programmable so that pressing combinations of two or three keys performs special operations unique to the application. You can also program a substitution table that will automatically enter a discrete character into the application when another specified character is read by the Handscan. This lets you perform functions such as removing commas from numbers or eliminating proportional spacing from text.

The manufacturer claims that the Handscan's error rate is less than one error for every 1300 characters scanned. The Handscan package consists of the scanner, a full-length interface card, and software. It runs on IBM PCs, ATs, and compatibles. A hard disk and 640K bytes of RAM are recommended. **Price:** \$649.95.

Contact: Saba Technologies Inc., 9300 Southwest Gemini Dr., Beaverton, OR 97005, (503) 222-7050. **Inquiry 578.**

Ultra-Parallel 68020 Board

Systolic System's Model 481 is a VME-bus-compatible parallel numeric processor that's capable of full IEEE-P754 standard 32-bit, 64-bit, and 80-bit floating point computations. The board contains a single 68020 processor, four 68881 numeric co-processors, and 256K bytes of 70-nanosecond RAM.

Using a 25-MHz system clock, the system executes 1.29 million 80-bit floating-point

erations per second. Multiple 481 boards can be installed in VME-bus-compatible computers (such as the Macintosh II) for additional performance gains.

The Model 481 board performs nonlinear, transcendental, and trigonometric functions, and is well-suited for running simulations. A scientific software library of more than 400 commonly used subroutines is available in both FORTRAN and C.

Price: \$4995.

Contact: Systolic Systems Inc., 1065 East Brokaw Rd., San Jose, CA 95131, (408) 286-0421.

Inquiry 579.

Ryan-McFarland's Development Tools

RM/Screens and RM/Forte are two new productivity tools from Ryan-McFarland that are designed to enhance program development.

RM/Forte is a file manager, compiler, linker, and debugger that is now packaged with version 2.4 of RM/FORTRAN, an ANSI-77 optimizing FORTRAN. Other enhancements to version 2.4 include a syntax-checking capability, a faster math-co-processor library, and improved interlanguage communications. Its 8087/80287 emulator executes programs five times faster than earlier versions. It lets you handle mainframe-type floating-point arithmetic without installing an 8087/80287 coprocessor chip, but will take advantage of the chip, if you install one.

RM/Forte manages your program files, integrates several development tools into one operating environment, and simplifies the testing process. The project manager maintains information about all files in an RM/FORTRAN application, letting you track projects through all stages of development. The



Application screen generated by RM/Screens.

screen's project-status line shows you the number of files in a project, tells you whether an executable program exists, and reports what development task should occur next. From the screen you can select source files to edit, and you can edit them without having to refer to a printed copy of the listing. The listing file display shows the source code and the compiler diagnostic messages, including leading line numbers, embedded diagnostics, optional allocation maps and cross references, and compilation summaries.

When your files are ready for compilation, RM/Forte invokes the RM/FORTRAN compiler at your request. You can tell it to compile only those files modified since the previous compilations, and you can specify the compiler options for each file.

RM/Forte sets up a link-control file before invoking the linker. The file contains all the commands needed to link the program, and you can modify the link-control file as needed. You can also use linkers other than the one supplied with RM/Forte.

RM/Forte lets you execute a program with or without the debug option. During debug sessions, RM/Forte lets you move between program output, the interactive debugger, and source-code edit-

ing with keystroke commands.

RM/Screens, the screen generator, works with the RM/COBOL-85 compiler, generating COBOL code. It also generates code for the validation checks that ensure that your data meets each field's criteria. RM/Screens can reduce the time you spend producing screens by up to 40 percent.

RM/Screens includes a subsystem that defines screens, letting you design or recall previously stored screens for use in the applications. You can define up to 250 fields per screen and select from a palette of 16 colors. Editing functions are available, as are features for writing and masking literals. You also have a selection of what-you-see-is-what-you-get (WYSIWYG) screen-painting functions that simplify drawing, filling, and moving boxes, and drawing line graphics. Built-in primitives, such as window-like small screens and screen shifting, also simplify and speed the design process.

Another subsystem lets you define fields, field-entry sequences, and a range of field-validation criteria. Using the field directory, you can recall any field definition, including its validation logic, and use them in other screens.

A screen generator produces error-free RM/COBOL-85 source code for your screens and validation logic, after you have formatted, tested, and edited the screens.

With additional utilities, you can test your screens before you generate and compile COBOL code. A cross-referencing capability lets you manage the use of screens throughout an application by comparing listings of all fields within a screen or listing all screens containing a particular field.

Price: RM/Screens, \$400; RM/FORTRAN 2.4 with RM/Forte, \$595.

Contact: Ryan-McFarland Corp., 609 Deep Valley Dr., Rolling Hills Estates, CA 90274, (213) 541-4828. **Inquiry 580.**

TI Professional Goes Compatible

The CSTI Compatibility System is a full-length add-in card that adds IBM compatibility to the TI Professional and TI Portable Professional computers. Containing a video controller and floppy controller, the CSTI System makes use of the TI monitor (monochrome or RGB), keyboard, system memory, and both floppy and hard disk drives. It also supports an 8087 math co-processor.

The CSTI System includes a disk with software driver routines for the controllers, as well as routines that translate between the IBM PC applications and the TI Professional hardware. The manufacturer claims that the system is compatible with over 95 percent of IBM PC programs. The system also supports IBM PC-compatible serial ports. The system requires MS-DOS or PC-DOS, versions 2.1 to 3.2.

Price: \$595.

Contact: Compatible Systems Corp., 2111 30th St., Suite M1033, Boulder, CO 80301, (303) 444-9532. **Inquiry 581.**

continued

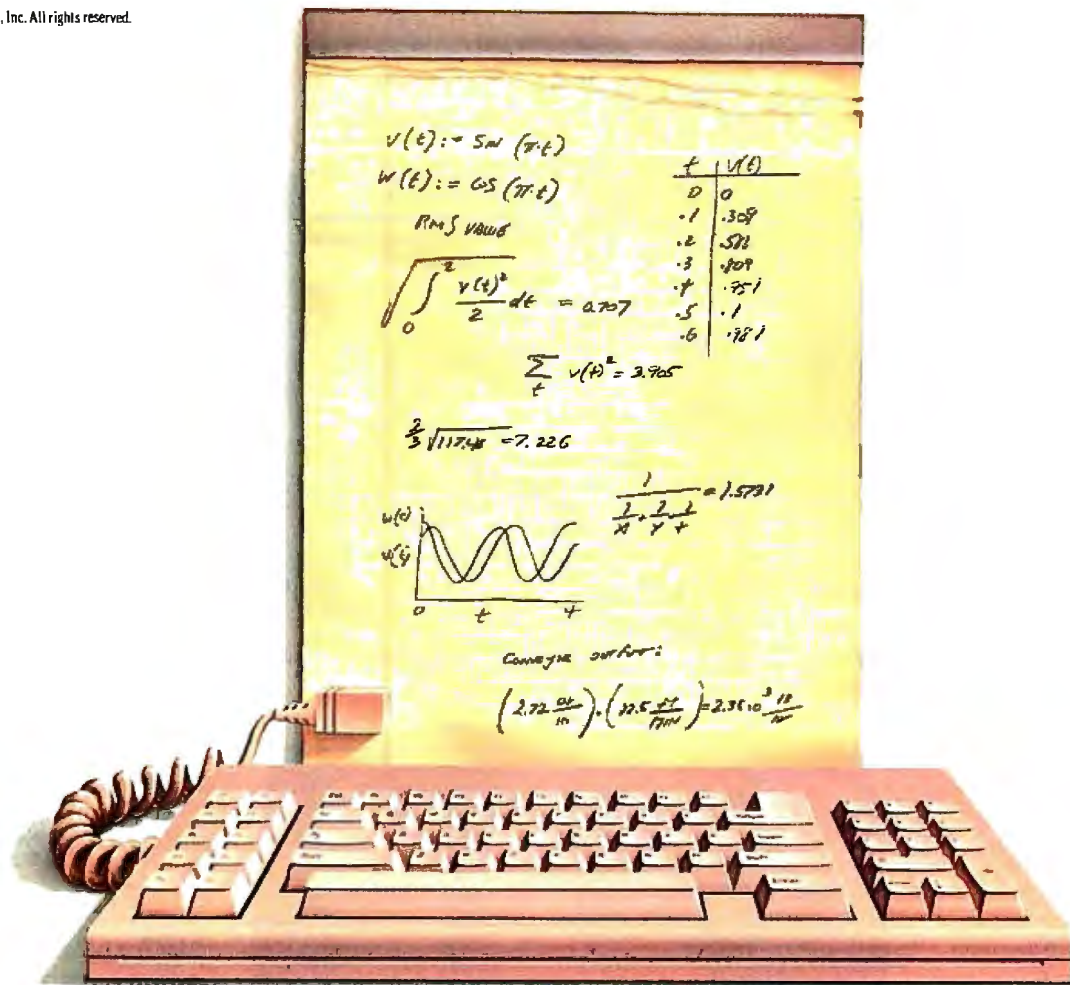

MathCAD™ turns your PC into an electronic scratchpad.

"MathCAD is a real gem of a software package... a program that breaks new ground... the starter of a new software category." **The New York Times**

It's the first numeric software that works like a word processor. The first software of its kind that's not a programming language. Think of it as the first WYSIWYG calculator. For the first time ever, MathCAD lets you do calculations on your PC in real math notation, as simply as on a scratchpad.

"MathCAD is likely to be a trendsetter. Its combination of mathematic power and what-you-see-is-what-you-get interface makes it an excellent tool..." **PC Week**

MathCAD lets you combine equations, graphics and text just like you do on paper. You can input formulas directly and edit equations interactively right on the screen. Just place the cursor anywhere and start typing. MathCAD not only formats your

equations as they're typed, it instantly calculates the results. Sounds simple? It is. In fact, **IEEE Software** writes, "It's fun, and it's much easier to use MathCAD than anything you've ever used before."

"It has a free form style that lets you just sit down in front of the PC and do the work you probably bought the computer for in the first place." **PC Magazine**

MathCAD is much faster and easier than doing calculations by hand or writing programs. And unlike a calculator, MathCAD lets you see and record every step. You can add text anywhere to support your work. And print or save your entire calculation as an integrated document that anyone can understand.

"It's hard to do justice to this software in any review. You feel like you've just discovered the power of a computer for the first time." **IEEE Software**

What kind of calculations can you do with MathCAD? Anything you have a formula for. As **IEEE Software** writes, "its versatility seems unlimited." With its wide range of built-in functions, MathCAD can handle everything from simple

math to your most sophisticated problems. Use MathCAD to calculate your mortgage payments, to solve a heat transfer problem, or to model electrical circuit parameters.

"... if I dealt frequently with numbers, I wouldn't wait... to get my copy." **The New York Times**

Why spend another minute doing calculations by hand or writing and debugging programs? Put MathCAD to work for you and find out why **PC Magazine** writes, "Warning: it could prove addictive." Once you've tried MathCAD, it's hard to imagine how you ever got along without it. To order MathCAD at just \$249, call us today at:

1-800-MathCAD
(In Massachusetts: 617-577-1017)

MathCAD

MathSoft, Inc., 1 Kendall Sq., Cambridge, MA 02139



Windows Drawing

The technical-drawing program Instinct runs in the Microsoft Windows environment and offers color capabilities and unlimited drawing size, rotation, scaling, zooming, and panning. You can merge the graphics you create with other programs to develop publications and overhead projections.

You can select and manipulate graphics, text, and menu commands with a mouse. A status window shows you what command you just invoked and what to do next.

A WYSIWYG screen display lets you create multiple drawings in separate windows and scrolls vertically or horizontally.

Layout tools include metric and English units of measurement. A built-in text editor lets you manipulate multiple lines of text and offers you a palette of text faces, sizes, and styles.

Instinct runs on the IBM PC, XT, AT, and compatibles that run Microsoft Windows. You need at least 320K bytes of RAM with two floppy disk drives. Display devices recommended include the IBM Enhanced Graphics Adapter (EGA), the Hercules Graphics Card, and other Windows-compatible devices. A copy of Microsoft Windows is also required.
Price: \$99.95.

Contact: Cadlogic Systems Corp., 2635 North First St., Suite 202, San Jose, CA 95134, (408) 943-9696; in CA, (800) 962-0660.
Inquiry 582.

TurboView Speeds Up AutoCAD

TurboView converts AutoCAD drawings into high-speed assembly language format and lets you view and animate them in both orthographic and true-perspective modes. TurboView displays your drawings up to 40 times faster than AutoCAD



Graphics capabilities of Instinct used to create perspective view.



AutoCAD drawing viewed and animated with TurboView.

without the math coprocessor and up to 7½ times faster than AutoCAD with the coprocessor.

TurboView also lets you manipulate up to 256 blocks in a drawing and save object-animation sequences at up to 30 frames per second.

The program works with the IBM Color Graphics Adapter (CGA), Enhanced Graphics Adapter, and SubLogic's X-1 Graphics Boards.

Price: \$495.
Contact: SubLogic Corp., 713 Edgebrook Dr., Champaign, IL 61820, (217) 398-4469.
Inquiry 583.

3-Ounce Modem Gets Serial Power

Weighing three ounces and about the size of an audiocassette, the Novation Parrot is a full-featured direct-connect 300/1200-bps modem. For even greater portability, the Parrot has a microprocessor-controlled power management system that takes power directly from the RS-232C serial port. You need neither batteries nor an external AC supply. The unit only draws power from the port when needed, remaining on standby until its circuitry detects activity.

Novation claims that the Parrot is fully compatible with the Hayes AT command set. It has built-in automatic self-

test, analog loop-back, and local and remote digital loop-back testing. It dials using both tone and pulse systems, it is configurable for automatic answer, and detects dial tone, busy signals, ring-back, and MCI/Sprint computer tones.

The Parrot's exact measurements are ¾ by 4½ by 2¾ inches. It has a built-in speaker with volume control, and four LED indicators: normal, off hook, carrier, and data. RS-232C cables and communications software are optional. Starter kits are available for IBM PCs and compatibles, the Macintosh, and Commodore computers.

Price: \$119.

Contact: Novation, Inc., 21345 Lassen St., Chatsworth, CA 91311, (818) 998-5060.
Inquiry 584.

IBM/Toshiba/Zenith Laptop Expander

The CTC Expander from Cypher Technology is an expansion chassis that's designed to provide full IBM-compatible expansion capabilities for owners of the Zenith Z-171, the Toshiba T1100 or T3100, and the IBM PC Convertible.

Each CTC Expander provides four full-length and three half-length expansion slots that can be used for any IBM-compatible expansion board. There's also a slot for the custom laptop interface card, which is shipped with the chassis and connects to the laptop via a three-foot cable.

The CTC Expanders have received FCC Class B approval, and come with a 135-watt power supply.
Price: \$995; with 20-megabyte hard disk, \$1595.
Contact: Cypher Technology Corp., 14003 Ventura Blvd., Sherman Oaks, CA 91423, (818) 905-8161.
Inquiry 585.

continued

CITIZEN

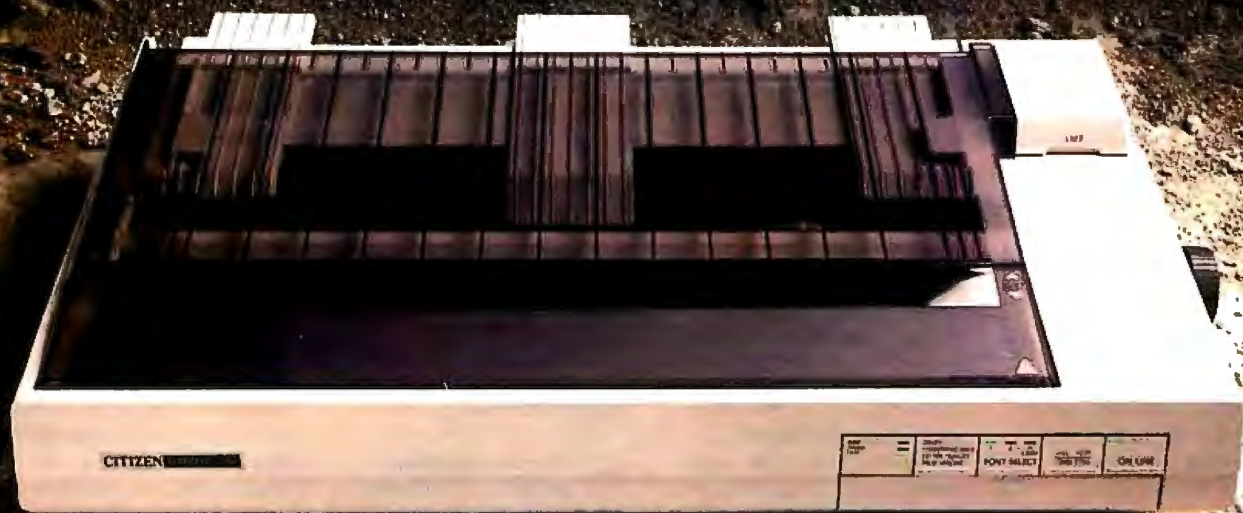

A TRIBUTE TO THE 24-PIN PRINTER.

You're looking at all the printer you'll ever need. For any application you'll ever have.

The Citizen™ Tribute™ 224. A 24-pin dot matrix solution offering superb word processing, spreadsheet, graphics and data processing applications. At a price you'll find surprisingly affordable.

The Tribute 224 delivers true letter-quality printing at 66 cps, correspondence-quality at 132 cps, and drafts at 200 cps (at 10 cpi). In standard or proportional spacing. And optional IC cards enable fonts and emulations to be easily expanded.

You also get high-resolution graphics. A built-in, push-feed, variable-width tractor and automatic paper loading system. Both serial and parallel interfaces for flexible hardware compatibility. Front panel access to most print functions. And compatibility with virtually every major software package.

All this, and it's backed by our nationwide service, excellent documentation, and 12-month warranty.

For more information, call 1-800-556-1234, Extension 34. In California, call 1-800-441-2345, Extension 34.

The Citizen Tribute 224.

There is no higher tribute to 24-pin printing.



CITIZEN

Printers that run like clockwork.

©1987 Citizen America Corporation. Citizen, the Citizen logo and Tribute 224 are trademarks of Citizen Watch Co., Ltd.

3Com's Workstation Goes Diskless

3 Station is a diskless workstation designed especially for local-area networking. Based around an 80286 processor running at 8 MHz, the 3Station's single circuit board includes monochrome, Hercules Graphics Adapter, CGA, and EGA, 1 megabyte of RAM (upgradable to 4 megabytes), and a built-in Ethernet adapter.

Because it has no expansion slots, the 3Station measures just 3 inches high and has a 14-inch-square footprint. The system draws just 25 watts of power, and does not need a cooling fan. A single parallel printer port, two serial ports, and a BNC connector for network connection are included. The 3Station comes with an IBM 101-style keyboard. A monitor is not included.

The 3Station's processor has direct access to the onboard graphics and the integrated network connection; and the system's memory mapping takes advantage of the freed-up memory area that's used for expansion slots in most IBM PC compatibles. The 3Station uses this memory area as RAM to hold the 3+ software, leaving 570K bytes of working memory available for DOS and applications. **Price:** \$1895.

Contact: 3Com Corp., 1365 Shorebird Way, Mountain View, CA 94043, (415) 961-9602. **Inquiry 586.**

Polaroid's Higher-Resolution Image Recorder

The PalettePlus Recorder is Polaroid's higher-end version of its Palette system for generating instant prints, slides, and overhead transparencies from computer graphics. When connected to an IBM PC-compatible system with an EGA and a graphics software package that has a PalettePlus driver, the



3-Com's diskless workstation.

PalettePlus can produce hard-copy with a resolution of 640 by 700 pixels. (The software without a PalettePlus Driver will produce a resolution of 640 by 350 pixels.)

When used with a CGA and software using a Palette driver, the system will produce a resolution of 640 by 400 pixels; 320 by 200 pixels without a Palette Driver.

The Recorder includes software that automatically configures the system for seven generally available EGA and CGA boards. The system includes auto-luminance circuitry, which senses and compensates for variations in the incoming video signal. There's also an electronic zoom control that fine-tunes the image plus or minus 4 percent.

Along with the exposure unit and software, the PalettePlus system includes a Polaroid 3 1/4- by 4 1/4-inch film back, an autowind 35mm camera back, a 35mm film processor, slide mounter, and cables. An optional motorized 35mm camera back is also available. **Price:** \$2999.

Contact: Polaroid Corp., 575 Technology Square-9P, Cambridge, MA 02139, (617) 577-2630. **Inquiry 587.**

A Portable 386

As the name implies, the Noble 386 Portable is a fully portable 16-MHz 80386-based computer. Measuring 17 by 7 1/2 by 19 inches and weighing under 35 pounds, the system is compatible with the IBM PC, XT, and AT, and comes standard with 512K bytes of RAM, which you can expand to 4 megabytes with two 2-megabyte add-on boards.

Other standard features of the Noble 386 include a 20-megabyte hard disk drive, a 360K byte floppy disk drive, and a 9-inch monochrome monitor supported by a Hercules graphics board. The system has six slots, including one for an 80387 math coprocessor. It has a Phoenix BIOS, and runs under MS-DOS or PC-DOS 3.1 and higher (not included with the basic system.)

The Noble 386 runs with one wait state, and you can toggle the clock speed from 16 MHz down to 8 MHz. The standard 20-megabyte hard disk drive has an average access time of 40 milliseconds, and a transfer speed of 5 megabits per second.

System options include a half-height 40-megabyte hard disk drive, a 1.2-megabyte floppy disk drive, and a 2-megabyte RAM board that

fits into a 32-bit slot. **Price:** \$2999; 40-megabyte hard disk drive, \$400; 1.2-megabyte floppy disk drive, \$140; 2-megabyte RAM board, \$700.

Contact: PC Discount, 2100 Travis, Suite 630, Houston, TX 77002, (713) 655-9047. **Inquiry 588.**

AutoCAD Plotter Management

ACS Telecom's 10-Plot is a plotter manager for AutoCAD that offers spool, queue, store, copy, archive, and plot capabilities. The program lets you spool drawings to a plotter or laser printer and return to AutoCAD without waiting for the plotter to finish the drawing. 10-Plot manages drawings in a single queue and plots them in order. You can archive drawing files and plot additional copies, without vector processing delays.

Spooling and queuing functions are performed from within AutoCAD, so you don't have to exit to DOS.

10-Plot requires an IBM PC, XT, AT, or compatible with MS-DOS or PC-DOS 3.0 or higher, AutoCAD 2.0, and at least 640 K bytes of RAM.

Price: \$249. **Contact:** ACS Telecom, 25825 Eshelman Ave., Lomita, CA 90717, (213) 325-3055. **Inquiry 589.**

Stripper Tears Perfs

The Stripper is a manual tool that removes the perforated edges of computer paper and forms. To use it, you insert the perforated edge of up to 20 sheets into the unit, press down, and pull away. **Price:** \$14.95.

Contact: Ra-Lo Inc., East 23301 Mission, Liberty Lake, WA 99019, (800) 334-5447, (509) 928-4139. **Inquiry 590.**

continued



Problem: Mysterious Data Loss Solution: New Verbatim DataHold Protects when Static Strikes.

Static Danger is Everywhere. Your data is vulnerable to loss from an unseen enemy—static electricity! Even small static charges could cause sudden mysterious data loss from your diskette.

And static lurks everywhere. Just walk across a carpeted floor and you build up a static charge of up to 1,500 volts—enough to ZAP your data.

It's DataHold or Data Loss. DataHold is Verbatim's ingenious diskette liner that disperses damaging static charges instantly. Compare DataLife to other popular brands which retain static charges up to four minutes and your choice should be obvious.

DataHold, available exclusively from Verbatim DataLife, for unsurpassed data protection. After all, it's your choice, DataHold or data loss.



Verbatim®
A Kodak Company

Low-End Amiga

Commodore's new low-end member of the Amiga family is the 500. Sporting the general look of the Commodore 128, the Amiga 500 comes standard with 512K bytes of RAM, expandable to 1 megabyte internally using the optional A501 RAM expansion cartridge, which also adds a real-time clock.

With a 68000 processor running at 7.14 MHz, Commodore claims the system is fully compatible with software written for version 1.2 of Amiga 1000 systems' software. The 500 has an 18¼-by-12¾-inch footprint, and weighs 7½ pounds. The external power supply weighs five pounds and has the system's power switch.

The new computer's keyboard has 94 keys arranged similarly to the IBM 101 layout. A single 3½-inch floppy disk drive is built in, as is an 86-pin expansion bus connector. There's also a two-button optomechanical mouse.

Price: \$649.
Contact: Commodore/Amiga, 1200 Wilson Dr., West Chester, PA 19380, (215) 431-9100.
Inquiry 591.

Zenith Z-159 Desktop Computer

The Zenith Z-159 is an enhanced, lower-priced version of the company's desktop personal computer. The Z-159 is available with either an EGA or Hercules-compatible monochrome board.

The Z-159 also accepts LMI/EMS upgrade chips, which lets you install up to 1.25 megabytes of RAM without using an expansion slot. With three additional LMI/EMS memory cards, the system will accommodate up to 5 megabytes of RAM.

With an 8088 processor switchable between 4.77 and 8 MHz, the Z-159 comes

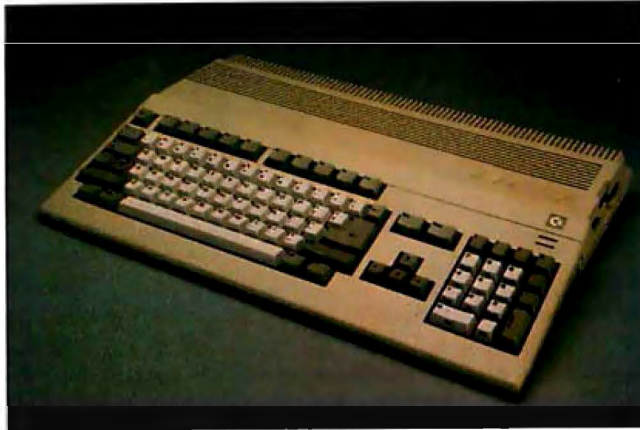

The \$649 Amiga 500.

standard with 256K bytes of no-wait-state memory, serial and parallel ports, and MS-DOS version 3.2.

Price: From \$1749 to \$2799.

Contact: Zenith Data Systems, 1000 Milwaukee Ave., Glenview, IL 60025, (800) 842-9000.
Inquiry 592.

C.Itoh's Multiuser Micro

The CIES/286 by CIE Systems (a subsidiary of printer-maker C.Itoh) is an 80286-based multiuser system that operates at 6, 8, or 10 MHz.

The CIES/286 system is available in two-user, six-user, and nine-user configurations. The basic two-user system includes 512K bytes of RAM (expandable to 12 megabytes), a 40-megabyte hard disk drive (with average 28-millisecond track-to-track access), no-wait-state architecture, a 1.2-megabyte floppy disk drive, four open expansion slots, an RS-232C serial port, a parallel port, a 101-key keyboard, and a monochrome monitor. An EGA-compatible 14-inch color monitor is optional.

A multi-mode graphics adapter is included to support monochrome, CGA, EGA,

and Hercules graphics. The system measures 9¼ by 16½ by 6¼ inches.

The system uses a Phoenix BIOS and comes with MS-DOS 3.2. Other options include a 70-megabyte hard disk drive and a cartridge tape backup unit. An optional 68000-based coprocessor board provides compatibility with PICK, RM/COS, and Unix operating systems.

Price: Two-user, \$5960; six-user, \$8085; nine-user, \$9800.

Contact: CIE Systems Inc., 2515 McCabe Way, Irvine, CA 92714, (714) 660-1800.
Inquiry 593.

Kaypro's Complete Publishing System

Extra! Extra! is an everything-you-need desktop publishing system from Kaypro. The system hardware is based on the Kaypro 286i, an AT-compatible with 640K bytes of RAM, a 30-megabyte hard disk, an EGA color board, an EGA-compatible monochrome board, and a three-button mouse. The printer is the Kaypro Page Printer II, an eight-page-per-minute laser unit with 300 dots per inch resolution. Included are Hewlett-Packard B fonts, an assortment of downloadable fonts, and cabling needed to hook the system together.

Extra! Extra!'s software

includes the Ventura desktop publishing package, WordStar 4.0 with MailMerge and CorrectStar, paint and form-generation software, MS-DOS 3.2 and GW-BASIC. Extra! Extra! can combine text from several other word processors, ASCII text, and graphics into master documents.

Price: \$8495.

Contact: Kaypro Corp., 533 Stevens Ave., Solana Beach, CA 92075, (619) 481-4300.

Inquiry 594.

A Low-Cost 68000 SBC

With the HT-68K TinyGiant single-board computer, all you need to get a fully operating computer is to add a terminal, a disk drive, and a power supply. This complete 68000-based system runs at 8 MHz and has 128K bytes of no-wait-state RAM (expandable to 512K bytes on the board). Two on-board EPROMs can contain up to 64K.

The system's built-in WD1770 floppy disk controller can control up to four 5¼-inch or 3½-inch floppy disk drives. A parallel printer port and two RS-232C serial ports are also included.

Measuring 5¾ by 8 inches, the TinyGiant is not only the same size and shape as a floppy disk drive, but also has holes in the same pattern so the board can be mounted directly. The board requires the same voltage levels and uses the same type of power connectors as a 5¼-inch drive.

The HT-68K comes with the K-OS One single-user, single-tasking operating system that reads and writes MS-DOS-formatted disks.

Price: \$395.

Contact: Hawthorne Technology, 8836 Southeast Stark, Portland, OR 97216, (503) 254-2005.

Inquiry 595.

continued

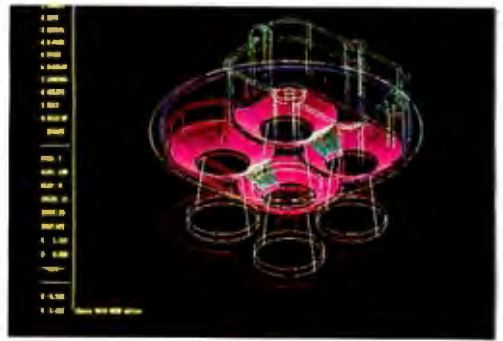
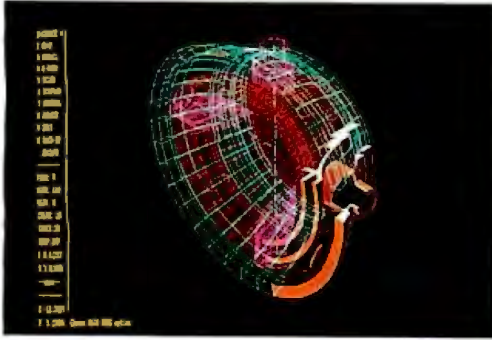

Introducing

CADKEY® 3

REAL WORLD DESIGN

Tools, Not Toys.

CADKEY quickly became the world's leading PC-based mechanical engineering system, with more than 25,000 installations, by pioneering the concept of a fully-integrated 2D-Drafting and 3D-Design system. We gave engineers real design tools, not toys. After all, the real world is three dimensional, not flat.

Real-World Solutions.

Now CADKEY 3 brings more real-world solutions to the PC by integrating all of the *useful* functions of surface-modeling, programmability, macro and tablet customization, and much more...

CADKEY 3 is a design toolbox stuffed with features:

- A Fully Programmable 3D Design Language (CADL 3.0)
- Wireframe and Surface Modeling and Editing
- User-Definable Macros and On-Line Calculator

- Customizable-Tablet Templates
- ANSI and ISODrafting with Ordinate-Dimensioning
- A 3-D IGES Translator
- FEA and Multi-Axis NC Integration
- Family-of-Parts Creation
- Bill-of-Materials Generation
- Technical Publishing Links
- Compatibility with All Popular Hardware
- A Complete Training and Support Network
- World-Wide Dealer Coverage

... And that's just for starters... so how about bringing us *your* real world problem *today*? Call us now at **203-647-0220**.

CADKEY 3
Power... Performance... Price

PERIPHERALS

Big-Screen MultiSync Monitor

Auto-Sync is a 19-inch color monitor from Microvitec that automatically locks onto any scan frequency from 15 to 36 kHz. Because specially-developed analog circuitry synchronizes both the horizontal and vertical scan frequencies, the company claims there's none of the picture-height variation found in some other multi-sync monitors.

The Auto-Sync supports graphics resolutions of up to 1024 by 580 pixels, and is available with either regular or long-persistence phosphors. It accepts both TTL and analog inputs.

Price: \$2195.

Contact: Microvitec Inc., 1943 Providence Court, Airport Perimeter Business Center, College Park, GA 30337, (404) 991-2246. **Inquiry 596.**



The Microvitec automatically locks onto any scan frequency.



Rascol II gives you 2000- or 4000-line slides from your PC or AT.

Ultra High-Resolution Slide Maker

The Rascol II Personal Film Recorder from Lasergraphics produces color slides with either 2000- or 4000-line resolution. The heart of the system is a full-length plug-in card that's compatible with IBM PCs and ATs. The card contains a 68000 processor and operates as a fully independent coprocessor, performing all the intensive operations of rasterizing the image into millions of color dots.

The system is compatible with virtually all graphics software available for the IBM PC and accepts graphics in either the Lasergraphics Language or the Hewlett-Packard Graphics Language (HP-GL). In the 4000-line-resolution mode, the system can produce up to 30 slides per hour; 60 in the 2000-line-resolution mode.

Price: \$4995.

Contact: Lasergraphics Inc., 17671 Cowan Ave., Irvine, CA 92714, (714) 660-9497.

Inquiry 597.

Enhanced Printers: High and Low End

The P351C Model 2 from Toshiba is an enhanced version of its 3-in-1 dot-matrix printer designed to produce color text and graphics as well as 24-pin letter

quality. Graphics resolution is 180 by 180 or 180 by 360 dpi in up to seven colors. It will print at 300 characters per inch in draft mode, 250 cps in the condensed printing mode, and 100 cps in near-letter-quality mode.

Toshiba has redesigned and augmented the LED front-panel display so you can select print quality, font, pitch, paper motion, or the new "quiet" mode at the touch of a button. Also, the DIP switches are now located directly behind the front panel for easy access.

The printer can handle paper sizes from 4 to 15 inches in friction-feed mode. In addition to a bottom-feed pro-

vision that handles multi-part forms, other standard features are three resident type fonts (prestige elite, courier, and high-speed draft), and the ability to accept a wide variety of type fonts from optional disks or cartridges. The Model 2 can emulate the Qume Sprint 11, IBM Graphics Printer, and IBM Color Printer. Increased software support is now provided with most of the popular packages.

Optional paper-handling accessories include a dual-bin sheetfeeder, unidirectional and bidirectional tractors.

Price: \$1749.

Contact: Toshiba America Inc., Information Systems Division, 2441 Michelle Dr., Tustin, CA 92680, (714) 730-5000.

Inquiry 598.

The "Plus" version is C.Itoh's enhanced ProWriter Jr. The unit prints 160 cps in draft mode, a 33 percent improvement over the original. Throughput on the Plus has been increased from 48 to 61 lines per minute, and the size of the printer buffer has been enlarged to 8K bytes.

The ProWriter Jr. Plus has a 30-cps near-letter-quality mode and a built-in printer stand that lets your paper feed from underneath the unit. Another new feature allows you to insert single sheets or envelopes into the Plus without having to remove the tractor-feed paper that's already there.

Besides fully emulating the Epson FX-80 Plus, the ProWriter Jr. Plus also has built-in IBM-compatible character sets.

Price: \$369.

Contact: C.Itoh Digital Products Inc., 19750 South Vermont Ave., Suite 220, Torrance, CA 90502, (800) 423-0300, (213) 327-2110.

Inquiry 599.

continued

The SmartTerm® Theory of Software Evolution What *Really* Happened to the Dinosaurs?

They were replaced with advanced new species.

After you've tried SmartTerm terminal emulation software, you'll think other PC-to-minicomputer communications links are as advanced as . . . dinosaurs.

SmartTerm gives your PC exact feature-for-feature terminal emulation, error free data transfer and programmable softkeys.

SmartTerm already is known worldwide as the leader in advanced DEC*, Data General* and Tektronix* terminal emulation software. Now Persoft soars to greater heights with these new product introductions:

NEW! SmartTerm 240 Version 2.0 features precise DEC VT241* color graphics terminal emulation for full-screen, four-color display of ReGIS* graphics pictures!

NEW! SmartTerm 2392 emulates the popular Hewlett-Packard HP2392* text terminal!

NEW! SmartMOVE combines power, ease-of-use, error-free file transfer and exact DEC VT100 emulation in one "smart" communications software buy!

SmartTerm and SmartMOVE are available through your local dealer. If you would like more information about SmartTerm or SmartMOVE, circle the appropriate reader service number below. Or contact:

Persoft, Inc.
465 Science Drive
Madison, WI U.S.A. 53711
Phone (608) 273-6000
Fax (608) 273-8227
Telex 759491

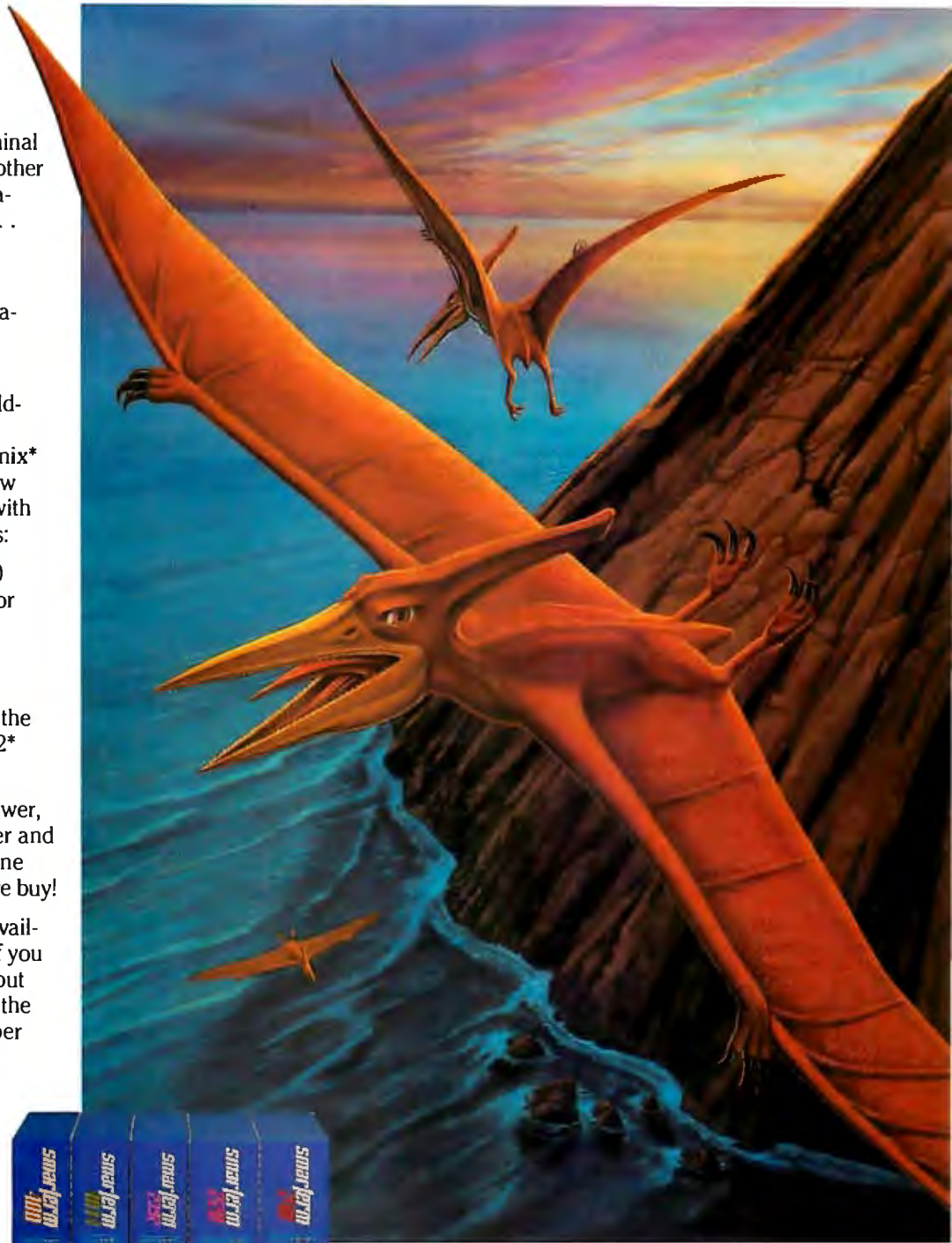

persoft®

**SmartTerm Terminal Emulation Software
. . . The Natural Selection**

VISIT BOOTH 3244 WEST HALL COMDEX/ATLANTA

*SmartTerm, SmartMOVE and Persoft are registered trademarks of Persoft, Inc. DEC, VT, and ReGIS are trademarks of Digital Equipment Corporation. Data General is a trademark of Data General Corporation. Tektronix is a registered trademark of Tektronix, Inc. HP is a trademark of Hewlett-Packard Company. ©Persoft, Inc. 1987. All Rights Reserved.

Inquiry 351 for DEC Emulation. Inquiry 352 for DG Emulation. Inquiry 353 for HP Emulation.

JUNE 1987 • B Y T E 55

When you want to talk computers..

ATARI COMPUTERS

Atari Computers

800 XL 64K Computer.....\$63.99
 65XE 64K Computer.....94.99
 130XE 132K Computer.....129.00
 520ST Monochrome System.....519.00
 520ST Color System.....749.00



Atari 1040 Color System \$879

Includes: 1040ST, 1 mb RAM with 3 1/2" drive built-in, 192K ROM with TOS, Basic, Logo, ST language, power supply and color monitor.

ATARI SOFTWARE

Access

Leaderboard Golf.....26.99

Accolade

Fight Night.....19.99

Activision

Music Studio.....34.99

Antic

Cad 3-D.....32.99

Batteries Included

Paperclip w/SPELLPACK.....39.99

Degas Elite.....48.99

Epyx

World Karate Championship.....24.99

Infocom

Zork Trilogy.....44.99

Microprose

Top Gunner.....19.99

F-15 Strike Eagle.....24.99

Origin Systems

Ultima 4.....39.99

Paradox

Wanderer (3-D).....27.99

Psygnosis

Deep Space.....34.99

Timeworks

Wordwriter ST.....51.99

VIP

Professional (GEM).....144.00

COMMODORE COMPUTERS



Amiga 2000 System

Includes: A2000, 1Mb RAM, 3 1/2" Floppy, A1080 Monitor, Mouse, DOS, A2088, Bridge Board **\$1999**

Commodore-64C 64K Computer 179.00

Commodore-64C Sys. w/1802C 519.00

Commodore-128 128K Computer 249.00

Commodore-128 System Pkg....739.00

Amiga 1000 Computer.....899.00

Amiga 500.....Call for pricing

COMMODORE SOFTWARE

Activision

Hacker.....32.99

Broderbund

The Print Shop.....29.99

The Toy Shop.....39.99

Commodore

Textcraft w/Graphic Craft.....59.99

Assembler.....79.99

Enhancer DOS 1.2.....14.99

Discovery Software

Marauder Back-up.....32.99

Electronic Arts

Deluxe Paint.....69.99

Deluxe Print.....74.99

Instant Music.....34.99

Deluxe Video.....69.99

Infocom

Hitchhiker's Guide.....31.99

Micro Illusions

Dynamic-Cad.....349.00

Mindscape

Halley Project.....31.99

Deja Vu.....34.99

Micro Systems

Analyze Version 2.0.....119.00

Scribble.....64.99

On-Line/Comm.....49.99

Sublogix

Flight Simulator.....37.99

V.I.P.

V.I.P. Professional.....139.00

MS/DOS SYSTEMS

AT&T 6300.....from \$1299.00

Compaq.....from 1699.00

IBM-XT.....from 1099.00

IBM-AT.....from 2499.00

Leading Edge.....from 999.00

NEC Multispeed.....from 1499.00

Panasonic Business Partner from 799.00

Toshiba 1100 Plus.....from 1699.00



PC-T00 20 Meg XT-Compatible \$999

MULTIFUNCTION CARDS

AST

Six Pak Plus PC/XT.....169.00

Hercules

Color Card.....159.00

Graphics Card Plus.....209.00

Fifth Generation

Logical Connection 256K.....329.00

Quadram

Expanded Quadboard.....119.00

Video 7

EGA Video Deluxe.....389.00

Zuckerboard

Color Card w/Parallel.....89.99

MS/DOS SOFTWARE

Ashton-Tate

d-Base III +399.00

5th Generation

Fastback Utility.....89.99

IMSI

Optimouse w/Dr. Halo.....99.99

Lotus

Lotus 1-2-3.....329.00

MicroPro

Professional 4.0 w/GL Demo.....239.00

Microstuf

Crosstalk XVI.....89.99

P.F.S.

First Choice.....119.00

Word Perfect Corp.

Word Perfect 4.2.....209.00



COMPUTER MAIL ORDER

.....When you want to talk price.

MODEMS

Anchor
6480 C64/128 1200 Baud.....\$119.00
VM520 ST520/1040 1200 Baud.129.00

Atari
XM301 300 Baud.....44.99

Commodore
Amiga 1680-1200 BPS.....169.00
CBM 1670 & C-128).....99.99

Everex
Evercom 1200 Baud Internal.....109.00

Hayes
Smartmodem 300 External.....139.00
Smartmodem 1200 External.....389.00

Practical Peripherals
1200 BPS External.....159.00

Quadram
Quadmodem II 1200 Baud.....299.00

Supra
MPP-1064 AD/AA C64.....69.99
1200AT 1200 Baud Atari.....139.00



U.S. Robotics
1200 Baud. \$109.00
2400 Baud Internal.....\$189.00

MONITORS

Amdtek
410 12" TTL Monitor.....149.00
Video 310A Amber TTL.....139.00

Commodore
Commodore 1902.....299.00
Amiga 1080 Hi-Res Color.....269.00

Magnavox
8505 RGB/Composite.....199.00
515 RGB/Composite.....289.00

NEC
12" TTL Green or Amber.....109.00
JC-1401P3A Multi-Sync.....579.00

Princeton Graphics
MAX-12 12" Amber TTL.....169.00

Taxan
Model 124 12" Amber.....119.00

Zenith
ZVM 1220/1230.....(ea.) 99.99

DRIVES

Atari
1050 SS/DD (XL/XE).....\$139.00
AA354 SS/DD Disk (ST).....\$119.00
SHD204 20 Meg ST Hard Drive579.00

Allied Technology
Apple Half-Heights.....109.00

Commodore
Amiga 1010 3½".....219.00
Amiga 1020 5¼".....189.00
1541C.....179.00
1571.....239.00

CSI
10 mb (64-128).....1099.00

Indus
GT Disk Drive.....179.00

Microbotics
20 mb Hard Drive (Amiga).....1299.00



Racore Jr. Expansion \$299

Seagate
20 MB ST-225 Hard Drive Kit....379.00

Supra
30 Meg Hard Drive (ST).....799.00
20 Meg Hard Drive (ST).....569.00

Xebec
20 mb (Amiga).....899.00

DISKETTES

Maxell
MD1-M SS/DD 5¼".....\$9.99
MD2-DM DS/DD 5¼".....10.99
MF1-DDM SS/DD 3½".....12.99
MF2-DDM DS/DD 3½".....21.99

Sony
MD1D SS/DD 5¼".....8.99
MD2D DS/DD 5¼".....10.99
MFD-100 SS/DD 3½".....13.99
MFD-200 DS/DD 3½".....20.99

Hewlett-Packard Calculators
28C Scientific Pro.....199.99
18C Business Consultant.....139.95
12C Slim Financial.....74.99

PRINTERS

Atari
1020 XL/XE Plotter.....\$30.99
1025 XL/XE Dot Matrix.....129.00
XDM121 Letter Quality.....209.00
XMM801 XL/XE Dot Matrix.....199.00
XMM804ST Dot Matrix.....189.00

Brother
M-1109 100 cps, 9 pin.....209.00

Citizen
MSP-10 160 cps, 80-Column.....299.00
Premier 35 cps Daisywheel.....499.00

C. Itoh
8510-SP 180 cps, 80-Column.....Call

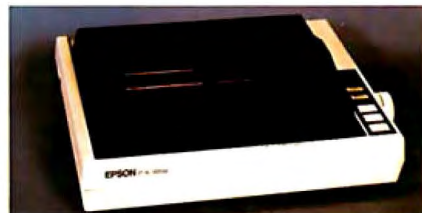

Epson FX-86
240 cps Dot Matrix \$349

Epson
LX-86 120 cps, Dot Matrix.....199.00
FX-286E 240 cps, 132-column.....Call
EX-800 300 cps, 80-column.....429.00
LQ-800 180 cps, 24-Wire Head.....Call

Hewlett Packard
Thinkjet 399.00

Juki
6300 40 cps Daisywheel.....659.00
6100 10 cps Daisywheel.....389.00
5510C Color Dot Matrix.....349.00

NEC
Pinwriter 660 24 Wire.....489.00
Pinwriter 760 24 Wire.....689.00

Okidata
Okimate 20 Color Printer.....129.00
ML-182 120 cps, 80-column.....239.00
ML-192+ 200 cps, 80-column...369.00

Panasonic
KX-1080i 120 cps, 80-column....219.00
KX-1091i 180 cps, 80-column....299.00
KX-1592 180 cps, 132-column...439.00

Star Micronics
NX-10 120 cps, 80-column.....209.00
NX-10C 120 cps, C64 Interface.219.00
NX-15 120 cps, 132-column.....369.00

Toshiba
P321 216 cps, 24-Pin Head.....479.00

In the U.S.A. and in Canada

Call toll-free: 1-800-233-8950.

Outside the U.S.A. call 717-327-9575 Telex 5106017898

Educational, Governmental and Corporate Organizations call toll-free 1-800-221-4283

CMO. 477 East Third Street, Dept. A106, Williamsport, PA 17701

ALL MAJOR CREDIT CARDS ACCEPTED.

POLICY: Add 3% (minimum \$7.00) shipping and handling. Larger shipments may require additional charges. Personal and company checks require 3 weeks to clear. For faster delivery use your credit card or send cashier's check or bank money order. Pennsylvania residents add 6% sales tax. All prices are U.S.A. prices and are subject to change and all items are subject to availability. Defective software will be replaced with the same item only. Hardware will be replaced or repaired at our discretion within the terms and limits of the manufacturer's warranty. We cannot guarantee compatibility. All sales are final and returned shipments are subject to a restocking fee.

ADD-INS

PC Building Blocks from DataBlocks

PC Link is the PC version of DataBlocks' process control/robotics system that lets you interface a virtually unlimited number of the company's Altair-II (A-II) process control blocks to a PC or compatible while using just one expansion slot.

The PC Link interface card provides complete buffering on and off the PC bus, and only loads the bus with a single CMOS load to prevent degradation. The board is designed to operate at full system speed with no wait states.

All IBM PC-compatible I/O commands are converted to A-II commands by the board. The A-II blocks consist of a wide variety of low-cost control modules, with some 37 currently available. Included are A/D and D/A converters, relay blocks, voice synthesis and recognition, a master/slave system, DC switches, timing blocks, a PROM programmer, PROM and RAM disk systems, and others.

Price: \$187; blocks range from \$49 to \$566.

Contact: DataBlocks Inc., 579 Snowhill Rd., Glenwood, GA 30428, (800) 652-1336; in GA, (912) 568-7101.

Inquiry 600.

Jumbo Memory for 286/386 Systems

The Elite 16 memory-expansion board adds up to 16 megabytes of EMS/EEMS-compatible high-speed 16-bit memory to 80286 or 80386-based systems using a single full-length expansion slot. The board works with no wait states at 6- and 8-MHz clock speeds; with one wait state at 10 and 12 MHz.

256K-byte by 9-bit RAM modules are standard, and are directly interchangeable



Data Block's system building blocks.

with 1-megabit modules. A single RS-232C serial port along with a parallel printer port are standard, and a second serial port is optional.

No switch or jumper settings are needed to install the board. Elite 16 comes with AutoRAM software that provides automatic installation by automatically determining the amount of conventional and extended memory that is already in the system, determining how much memory is installed on the Elite 16, and allocating conventional, extended, and expanded memory. You can change the default values via software, and the installation software also automatically locks out malfunctioning memory locations.

Price: \$695 (with 512K).

Contact: Profit Systems Inc., 30150 Telegraph Rd., Birmingham, MI 48010, (313) 647-5010.

Inquiry 601.

HAL Controls the (Real) World

Designed as an aid to the handicapped, Home Automation Link (HAL) lets you control your computer

and compatibles and requires 512K bytes of RAM and a 20-megabyte hard disk. To use the system to control lamps and appliances, you also need the optional BSR Unit.

Price: \$995 for the HAL system; \$149 for BSR Unit; \$75 for Radio Shack's Duo-Phone; \$295 for Teknika's 6510 TV tuner.

Contact: The Voice Connection, 17835 Sky Park Circle, Suite C, Irvine, CA 92714, (714) 261-2366.

Inquiry 602.

Fileserver Expansion for the Compaq 386

The 10-Disk/386 Expansion Kit from ACS Telecom increases the storage capacity and speed of the Compaq Deskpro 386. It's specifically designed to turn the Deskpro 386 into a high-powered fileserver for local area networks, and works with ACS Telecom's 10-CAD, Fox Research's 10-Net, 3Com, IBM's Token Ring Network, and ARCnet.

The 10-Disk/386 adds as much as 630 megabytes of hard disk storage to the Deskpro 386 models 40, 70, or 130. Using a 10-megabit-per-second data-transfer rate, 1:1 interleave, and low access time, the system increases Deskpro 386 throughput by more than 60 percent.

The system uses up to 8 megabytes of high-speed, 32-bit RAM to cache most disk-read requests using an intelligent, most-frequently-used algorithm. The 10-Disk/386 is completely compatible with the Compaq 386 built-in disk controller for a combined storage capacity of up to 760 megabytes.

Price: starting at \$5595.

Contact: ACS Telecom, 25825 Eshelman Ave., Lomita, CA 90717, (213) 325-3055.

Inquiry 603.

continued

THE WORLD'S SMARTEST ANSWERING MACHINE

PERSONAL VOICE MAIL

"Hello. I'm not available right now. Please wait for the tone and leave a detailed message. Touch the star to listen to what you've recorded."

PERSONAL MESSAGES FOR FREQUENT CALLERS

"Hello, I'm not ...☐... Dad! I'm not here, but my computer knows exactly where I am and will pass your message on to me immediately. Wait for the tone and tell me where you are. I'll call you right back."

REALLY PERSONAL MESSAGES FOR FREQUENT CALLERS

"Hello, I'm not avai ...☐... Tess! Sweetheart! I'm in the car, picking up your flowers. My car phone number is 993-1234 if you need me. Otherwise, see you at seven. Kiss-kiss-kiss!"

MESSAGE FORWARDING

"Hello. This is your answering machine calling...☐... Three new messages. Message one was received at 3:52PM today."



MULTIPLE VOICE MAIL BOXES

"Hi. This is the operating systems group. We're out to lunch, but you can leave a private message by dialing 11 for Chip, 12 for Morris, 13 for Joel and 14 for Bob. Or you can wait for the tone to leave a message for our secretary."

INCREASED SECRETARIAL PRODUCTIVITY

"This is Gordie's voice mailbox. Please wait for the tone and leave a message. My computer knows where I am at all times and will call me immediately with your message. If you need to speak to someone right away, touch zero to transfer to my secretary."

DON'T FORGET MOM!

"This is Chip. Please ...☐... Hi, Mom. I've been waiting for your call. How's Europe? Thanks for remembering my birthday. Sorry I missed you, but I had to run some errands. See you Thursday at the airport!"

OUTGOING MESSAGES

"This is Joel's computer calling. Just a reminder for Lynne and Bonnie — We have a budget review tomorrow morning at 8:00 o'clock. See you there!"

Answering machines are irritating because they are so dumb. Even the best of them. For only \$349, we'll give you personal voice mail for your PC, and turn it into the world's smartest answering machine. All without disturbing whatever else you've been doing on the PC.

How smart is "smartest?" The examples above . . . uh . . . speak for themselves. Sure, your PC can answer the phone in your voice, and let you retrieve messages remotely from any touch-tone phone. And it can call you to deliver your messages.

But give your friends and associates their own voice mailboxes. The ability to interrupt your greeting and start recording immediately. To deliver messages to each other as well as to you. The ability to transfer to other extensions. Even let them change their minds *and* their messages. Give them

all this and you'll never again have to apologize for making people talk to a machine.

In your business, it will relieve your secretary of the burden of taking routine messages. And relieve you of the burden of transposed telephone numbers. In business or in personal use, it works 24 hours a day. Without irritating your callers like mere answering machines do. All while you're running your spreadsheet, word processor or just about anything else.

We call the world's smartest answering machine "CAM." For *Complete Answering Machine*. We call ourselves The Complete PC. And CAM is just the beginning of a whole line of smart products designed to help you get *more from your personal computer*.

You should call (800) 634-5558 today for the name of the CAM dealer nearest you.

So tomorrow, you can give your old answering machine to someone who doesn't mind annoying people.



THE COMPLETE PC

More from your personal computer

521 Cottonwood Drive • Milpitas, California 95035
800 634-5558 • 408 434-0145 • FAX 408 434-1048

© 1987 by The Complete PC, Inc. Complete Answering Machine,™ CAM™ are trademarks of The Complete PC. Ads by TRBA

QuickBASIC 3.0

Microsoft has upgraded QuickBASIC to version 3.0 with a faster compiler, improved debugging, and in-line support for the 8087 and 80287 math coprocessors. The enhanced debugger is based on the CodeView debuggers offered with the Microsoft C Compiler. It lets you begin debugging while a program is running by pressing Control-Break. You can find errors by stepping through the source code while it is executing, using animate, trace, or single-step modes. You can see the contents of variables while the program is running, and you can set, examine, and clear dynamic breakpoints to stop a program during execution. Another feature lets you divide the screen into windows and view the source code, variable contents, and program output simultaneously while the program is running.

The coprocessor support added to QuickBASIC 3.0 lets you generate faster code if you have a coprocessor, or it will automatically switch to 8087 software emulation routines that offer the same 80-bit IEEE math accuracy, according to Microsoft.

Other programming features include support for local and global variables, block If . . . Then . . . Else statements, the ability to use alphanumeric line labels instead of line numbers, and separate compilation, which lets you divide your programs into modules and compile each independently. You can keep the modules in libraries and link them into other programs without recompiling.

Microsoft has also added an error-tracking feature to the 3.0 compiler. It keeps track of all errors found during a compilation, so you don't have to correct each error and recompile. At the end of each compilation, the compiler places the cursor on the first error it found.

The QuickBASIC integrated editor supports both insert and overstrike modes and it's compatible with Super-Key, ProKey, and Side-Kick. QuickBASIC 3.0 offers BASIC compatibility and supports graphics statements, sound statements, and EGA extended graphics modes.

QuickBASIC 3.0 requires an IBM PC or compatible with 320K bytes of RAM, MS-DOS or PC-DOS 2.0 or higher and supports 5¼- and 3½-inch disk formats.

Price: \$99.

Contact: Microsoft Corp., P.O. Box 97017, Redmond, WA 98073-9717, (800) 426-9400; in WA or AK, (206) 882-8080.

Inquiry 604.

Turbo Pascal Source Code Debugger

Turbosmith runs as an invisible shell around Turbo Pascal and is displayed as a menu item on Turbo Pascal's main menu. Turbosmith was designed around a portion of Visual Age's symbolic debugger, CodeSmith-86.

When you start up Turbosmith, 14 lines of your source code are displayed in an upper window, and 10 lines of local variables are displayed in a lower window. The next statement to execute is highlighted.

The program features four interactive window types that you can select for various views of your Turbo Pascal code. A Variable View window lets you view or change variables at the time the source code statements are being executed. The multi-window displays are based on a worksheet-type visual interface.

A single keystroke can switch you from one window to another, if the variables you need are in a nested calling

procedure rather than the procedure you're tracing. The variable your cursor is on is highlighted, and you can overstrike variables, if necessary.

You can stack windows up to eight deep. Some of the windows include a machine-language disassembler window, synchronized source- and machine-code windows, and a Hex/ASCII memory-dump window.

Turbosmith also lets you create and debug on the same monitor and features dual-monitor debugging. A Screen Save mode prevents you from destroying your program when you create and debug on the same monitor.

The program is written in assembly language and runs on IBM PCs, XT's, AT's, and compatibles with MS-DOS or PC-DOS. Visual Age recommends 512K bytes of RAM to run Turbosmith and Turbo Pascal. A copy of Turbo Pascal 3.0 or higher is also required.

Price: \$69.

Contact: Visual Age, 642 North Larchmont Blvd., Los Angeles, CA 90004, (800) 732-2345; in CA, (213) 534-4202.

Inquiry 605.

Pascal Helper

Pascal Helper from Modular Software assists you in designing and creating programs with Turbo, IBM, or Microsoft Pascal. You write the Pascal module, and Pascal Helper does the rest.

In creating screens, the program defines your variables and develops the main program and the language-dependent low-level procedures. The main program, the Runtime.Mod, and your calculation procedure, complete the program.

The Runtime.Mod source-code module, consisting of 121 procedures logically grouped into modules, is

included with Pascal Helper. You can remove or replace some of the modules to modify your applications.

It also includes an editor with character, line, and block commands along with commands for duplicating lines and drawing lines, boxes, and logos. The editor also has three help screens.

To run Pascal Helper you need an IBM PC, XT, PCjr, AT, or compatible with at least 128K bytes of RAM. A floppy or a hard disk drive is required along with MS-DOS or PC-DOS 2.0 or higher. You also need a composite, monochrome, or color display and a Turbo, IBM, or Microsoft Pascal compiler to compile and run your applications. To use the color capabilities of Pascal Helper, you must have a color adapter. The program is not copy-protected.

Price: \$79.95.

Contact: Modular Software Inc., 329 Hope St., Stamford, CT 06906, (800) 227-1032; in CT, (203) 854-8806.

Inquiry 606.

Edit with ME

Magma Software's text editor, ME, features a macro language that lets you create new editor commands and configure your programming environment. Other features include multiple windows, regular expressions, line marking, column mode, and one-key-stroke macros.

ME runs on IBM PCs and compatibles and supports the Enhanced Graphics Adapter.

Price: \$35 for the editor; \$85 for editor and source code. **Contact:** Magma Software Systems, 138-23 Hoover Ave., Jamaica, NY 11435, (718) 793-5670.

Inquiry 607.

continued

WHY LOGITECH MODULA-2 IS MORE POWERFUL THAN PASCAL OR C.

APPRENTICE PACKAGE
\$99

- Separate Compilation w/inter-module typechecking
- Native Code Generation
- Large Memory Model Support
- Most Powerful Runtime Debugger
- Comprehensive Module Library
- Maintainability
- Translator from Turbo and ANSI Pascal

WIN A FREE TRIP TO Switzerland



HOMELAND OF MODULA-2

Return your Modula-2 Registration Card or a reasonable facsimile* postmarked between March 1, 1987 and May 31, 1987 to be included in a once-only drawing!

Grand Prize: One week excursion for 2 in Zurich, Switzerland including a guided tour of ETH, the University where Modula-2 was created by Niklaus Wirth. European customers may substitute a trip to Silicon Valley, California.

Second and Third Prizes: LOGITECH C7 Mouse or LOGITECH Bus Mouse with Paint & Draw software—a \$219 value, absolutely free!

*Write to Logitech, Inc. for a registration card facsimile.

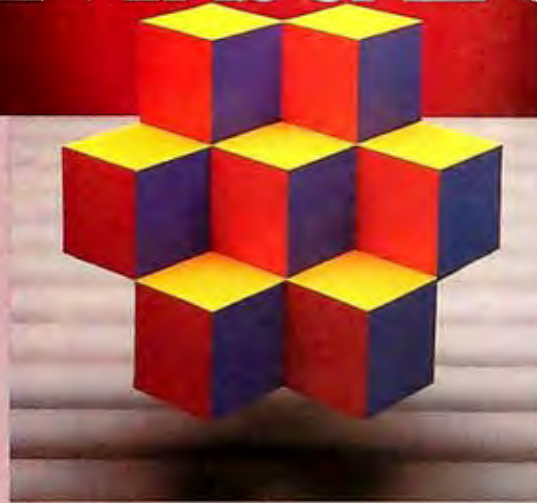

WIZARDS' PACKAGE
\$199

NEW!

APPRENTICE PACKAGE \$99
Everything you need to begin producing reliable maintainable Modula-2 code. Includes the Compiler with 8087 support, integrated Editor, Linker, and BCD Module. We're also including FREE our Turbo Pascal to Modula-2 Translator!

NEW!

WIZARDS' PACKAGE \$199
This package contains our Plus Compiler—for professional programmers or for those who just want the best. The Plus Compiler with Integrated Editor requires 512K and takes advantage of the larger memory to increase compilation speed by 50%. Our Turbo Pascal to Modula-2 Translator is also included at no extra charge.

NEW!

MAGIC TOOLKIT \$99
We've put our most powerful development tools into one amazing Toolkit for use with either the Apprentice or Wizards' packages. Highlighted by our Runtime Debugger, the finest debugging tool available anywhere, the Toolkit also includes our Post Mortem Debugger, Disassembler, Cross Reference utility and Version which keeps track of different versions of one program. Our MAKE Utility figures out module dependencies and automatically selects those affected by code changes to minimize recompilation and relinking. We also provide source code of our major library modules for you to customize—or just play with.

WINDOW PACKAGE \$49

Now you can build true windowing into your Modula-2 code. Features virtual screens, color support, overlapping windows and a variety of borders.

ROM PACKAGE AND CROSS RUN TIME DEBUGGER \$299

For those who want to produce rommable code. You can even debug code running in ROM from your PC.

Turbo Pascal is a registered trademark of Borland International.

Call for information about our VAX/VMS version, Site License, University Discounts, Dealer & Distributor pricing.

To place an order call toll-free:
800-231-7717
In California:
800-552-8885

YES! I want the spellbinding power of LOGITECH Modula-2!

- Apprentice Package \$99
- Wizards' Package \$199
- Magic Toolkit \$99
- Window Package \$49
- ROM Pkg/Cross RTD \$299

Add \$6.50 for shipping and handling. Calif. residents add applicable sales tax. Prices valid in U.S. only.

Total Enclosed \$ _____

VISA MasterCard Check Enclosed

Card Number _____ Expiration Date _____

Signature _____

Name _____

Address _____

City _____ State _____

Zip _____ Phone _____



LOGITECH, Inc.
805 Veterans Blvd. Redwood City, CA 94063
Tel: 415-365-9852

In Europe:
LOGITECH SA, Switzerland
Tel: 41-21-879656 • Telex 458 217 Tech Ch

In Italy:
Tel: 39-2-215-5622

Printed Circuit Board Design on the Macintosh

Douglas CAD/CAM lets you create layouts of printed circuit boards on the Apple Macintosh. During layout, the software creates a database used in the board manufacturing process.

The software accommodates a variety of grids, pads, holes, and trace widths, and provides a layout area of 32 by 32 inches. All parts are user-definable. Input is by a mouse and you can output to printers and pen plotters, or you can output the system's Gerber-formatted data to tape drives for photoplotting. **Price:** \$95; \$395 with drivers for the Apple ImageWriter and LaserWriter printers; \$525 with drivers for the printers and various pen plotters.

Contact: Douglas Electronics Inc., 718 Marina Blvd., San Leandro, CA 94577, (415) 483-8770. **Inquiry 608.**

Active Filter Design

The Active Filter Design program is a menu-driven utility that helps you synthesize active filter circuits. An error-checking feature prevents you from entering incompatible data. Screen windows show the currently activated portion of the program as well as the nesting level of the current menu.

Preformatted filter parameters are included, and you can also create your own parameters and store them on disk.

Lars Olsson Engineering says that it takes about 10 minutes to design moderately complex filters of any class.

The program runs on the IBM PC, XT, AT, and compat-



Circuit layout created with Douglas CAD/CAM.

ibles with at least 128K bytes of RAM and an IBM Color Graphics Adapter. You can plot on IBM graphics-compatible printers. **Price:** \$799.

Contact: Lars Olsson Engineering, 561 Pine St., Edmonds, WA 98020, (206) 778-9480. **Inquiry 609.**

Scientific Subroutines

Mathpac from Systolic Systems is a scientific subroutine program optimized for IBM PC XTs and ATs equipped with 8087 math coprocessors. The program is available in Microsoft FORTRAN, IBM Professional FORTRAN, Ryan-McFarland FORTRAN, Microsoft C, Lattice C, and Computer Innovations C86.

The program has a library of over 400 FORTRAN math routines, which you can link with your own application code. It includes ma-

trix/vector routines, linear equation solvers, numerical integration methods, simulation tools, optimization algorithms, and eigenvalue analyses. It also contains a signal-processing library for fast Fourier transforms, digital filtering, correlation, convolution, and spectrum analysis. Other libraries include real- and complex-vector operations, real- and complex-matrix operations, image processing, simulation and integration methods, numerical optimization, control system analysis and design, and a computer graphics library.

You can display the data on monochrome and color displays with up to 16 variables plotted on the same graph. You can graph X and Y plots, log-log plots, and bar and pie charts.

Price: \$495.

Contact: Systolic Systems Inc., 2440 North First St., San Jose, CA 95131-2310, (408) 435-1760. **Inquiry 610.**

Finite-Element Analysis Added to CAD

ADCAD2 version 2.0 lets you link programs with MSC/Pal 2 for finite-element analysis, and then transfer the results back to the CAD program. MacNeal-Schwendler says that any CAD program that uses DXF file-transfer can use ADCAD2 2.0.

To use ADCAD2, you must mesh the structure by breaking it into beams, triangles, and quadrilaterals from within the CAD program. Then you answer a series of questions about the drawing, including its filename, the file format, and the type of material used in the design (only one type of material can be used in each drawing). ADCAD2 then translates the drawing into MSC/Pal 2 format, where it is analyzed and MSC/Pal 2 creates a version of the drawing that exposes the drawing's structural weaknesses. Then ADCAD2 transfers the altered drawing back to the CAD program (as a DXF file) and displays it as an overlay on the original.

You need an IBM PC or compatible with MS-DOS or PC-DOS 2.1 or higher, 512K bytes of RAM, an IBM Color Graphics Adapter or compatible graphics display, and a math coprocessor. You can print the MSC/Pal 2 drawings on plotters supported by the CAD program. **Price:** \$95.

Contact: MacNeal-Schwendler Corp., 815 Colorado Blvd., Los Angeles, CA 90041, (213) 259-3875. **Inquiry 611.**

continued

We put our money where our Mouse is.

LOGITECH C7 MOUSE

\$99

PC MAGAZINE
"EDITORS CHOICE"

"...To sum up my feelings about this mouse and menu generating system: this is the one I want."

Phil Wiswell
PC Magazine, Jan 27, 1987

At LOGITECH we've spent years perfecting our high-quality mouse hardware and software. And every LOGITECH Mouse reflects the engineering we've devoted to it.

MAXIMUM COMPATIBILITY

The programmable LOGITECH Mouse works with virtually ALL hardware and application software.

BEST MOUSE TECHNOLOGY

The opto-mechanical LOGITECH Mouse offers the best of all worlds. Mechanical tracking (a ball) and optical decoding (precise, reliable optical encoders). Every major computer manufacturer, including Apple, IBM and DEC, has chosen opto-mechanical mouse technology. LOGITECH offers the only opto-mechanical mouse on the retail market.

BEST MOUSE FOR GRAPHICS & CAD

High (200 dot per inch) resolution, precise tracking, and a 3-button design are essential for graphics and CAD.

BEST MOUSE FOR DESKTOP PUBLISHING

Ergonomic styling is a must for all mouse-intensive desktop publishing applications. High resolution is essential for high-resolution screens.

BEST MOUSE FOR SPREADSHEETS & WORD PROCESSING

The smooth-tracking LOGITECH mouse is a productivity tool for all types of data entry and editing. We've even created a special mouse interface for 1-2-3 which makes 1-2-3 users up to 30% more productive!

BEST MOUSE SOFTWARE

"Logitech's Plus Package adds an excellent menu builder (with useful examples), a fast windowing text editor, and an outstanding Lotus 1-2-3 interface."

Ezra Shapiro
Byte, Dec. '86, pg. 324

Our Plus Software also includes our Microsoft-compatible drivers, and CLICK which sets the mouse automatically for any application.

Inquiry 169 for End-Users. Inquiry 170 for DEALERS ONLY.



BEST DEALS

We offer either our C7 or Bus mouse, with Plus software, packaged with some of the most exciting applications on the market, at very exciting prices.

LOGIPAINT Special Offer! \$149

The LOGITECH Mouse with PC Paintbrush is the most advanced paint set available for the PC. It offers 11 type fonts, a pallet of 16 colors, and the ability to import and embellish files from other applications.

LOGICADD \$189

The LOGITECH Mouse packaged with Generic CADD and Dot Plot turns your PC into a complete CADD workstation. Generic CADD offers the features and performance of high priced CADD at an unbelievably low price. DotPlot is the add on utility that enables you to produce crisp, high resolution drawings from your dot matrix printer.

LOGIPAINT-&-DRAW \$219

The LOGITECH Mouse packaged with LOGIPAINT and LOGICADD. Together they are the complete graphics toolkit for combining freehand and technical drawings.

NEW

LOGITECH BUS MOUSE

\$149 with LogiPaint

100% Microsoft Bus Mouse Compatible!

It has all the features of the LOGITECH C7 MOUSE, plus it leaves the serial port on your computer free for other peripherals. It comes standard with our-top-of-the-line Plus Software and LogiPaint.



Lotus and 1-2-3 are trademarks of Lotus Development Corp. Generic CADD is a trademark of Generic Software, Inc. PC Paintbrush is a registered trademark of ZSoft Corp.

YES! I want the opto-mechanical LOGITECH Mouse!

- LOGITECH C7 Mouse w/Drivers \$99
- LOGITECH C7 Mouse w/Plus Software \$119
- LOGITECH BUS Mouse w/Plus Software and LogiPaint \$149
- Additional Software (with C7 and Plus or Bus Mouse and Plus.)
- LOGIPAINT \$149
- LOGICADD \$189
- LOGIPAINT-&-DRAW \$219

Add \$6.50 for shipping and handling. Calif. residents add applicable sales tax. Prices valid in U.S. only.

Total Enclosed \$ _____

30-Day Money-Back Guarantee/3-Year Warranty

To place a credit card order call our special toll-free number:

800-231-7717

Call toll-free in California:

800-552-8885

VISA MasterCard Check Enclosed

Card Number _____ Expiration Date _____

Signature _____

Name _____

Address _____

City _____ State _____

Zip _____ Phone _____

DEALER INQUIRIES WELCOME

 LOGITECH

LOGITECH, Inc.
805 Veterans Blvd. Redwood City, CA 94063
Tel: 415-365-9852

In Europe:
LOGITECH SA, Switzerland
Tel: 41-21-879656 • Telex 458 217 Tech Ch

In Italy:
Tel: 41-21-879656

Information Tracking

DayFlo's Tracker is a database with word-processing features that lets you keep track of everything. You can enter data using the standard forms that come with the system or develop your own by following a menu-directed procedure that requires no programming. You can enter up to 65,000 records per database and print using any of the system's 45 standard reports.

An Application Pack is offered as an option, and it provides ready-to-use application templates for contact records, article-abstract records, task records, and DOS file records.

When entering information into Tracker's records, the length of each field grows to accommodate your text. You can incorporate keywords into each record, so that later on you can recall all the information relating to a particular keyword. After retrieving information, you can use the report-writing capability to produce reports that contain text and tables. You can output to a printer, display, or to DOS files. Other features include text and number formatting with calculations including derived columns, totals, averages, counts, and subcalcs. DayFlo reports that calculations are accurate to 15 digits. A menu-driven mass-mailing capability is also offered, and you can use pre-printed forms. You also have the ability to import files from other word-processing programs.

To run Tracker, you need an IBM PC AT, XT, or compatible with MS-DOS or PC-DOS 2.0 or higher, at least 1 megabyte of hard disk space, 384K bytes of RAM, and a monochrome, CGA, or EGA monitor. A graphics adapter is not required. Price: \$149.95; Application Pack, \$39.95. Contact: DayFlo Software,

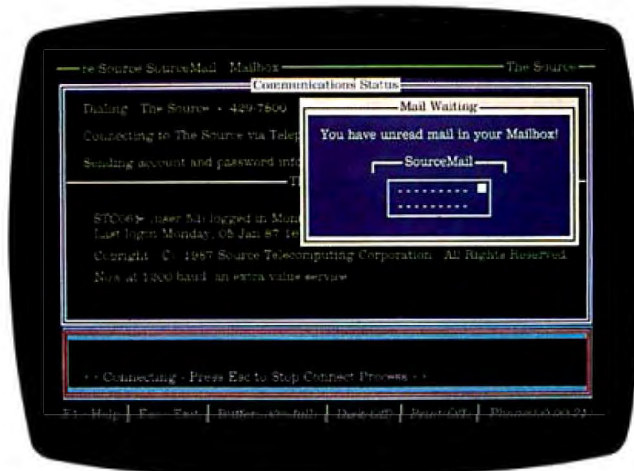

re:Source from The Source.

17701 Mitchell Ave. N, Irvine, CA 92714, (714) 474-1364. Inquiry 612.

re:Source

The communications program re:Source is an interface between your IBM PC and on-line services like The Source. You can automate frequent command sequences, integrate database information, and customize your own on-line scripts before you get on line.

The price of the program includes membership in The Source's information network.

Price: \$89. Contact: The Source, 1616 Anderson Rd., McLean, VA 22102, (703) 734-7500. Inquiry 613.

Harvard Graphics

Harvard Graphics, a new version of Harvard Presentation Graphics, offers new chart types and op-

tions, built-in drawing capability, production tools, and a desktop slide-show feature.

New graph types include histograms, logarithmic charts, paired bars, dual y-axis graphs, and proportional pie charts. Mathematical and statistical calculations include 19 keyword formulas such as sum, average, moving average, and regression. Harvard Graphics offers you three-dimensional options for producing bar, line, and area charts, and you have the ability to place multiple charts on a page, 240 data points per graph, and 60 characters per line in text charts. A user-definable palette of 16 colors is also available.

Drawing tools such as circles, ellipses, polygons, and polylines offer fill, outline color, and outline pattern options. You can group and ungroup drawings for moving and resizing. Preformatted charts are available, or you can create your own. Templates let you select chart attributes once and reuse your selection. You can group charts into

chartbooks, and an Automatic DataLink lets you link a Lotus 1-2-3 worksheet to a chart template, loading the data automatically when you retrieve a template.

The Screenshow feature lets you create slide presentations at your desktop. You can control the motion by moving backward, forward, pausing, and restarting slides.

Harvard Graphics runs on IBM PCs with at least 512K bytes of RAM. You can use most output devices and most high-resolution video boards, according to Software Publishing.

Price: \$395. Contact: Software Publishing Corp., P.O. Box 7210, Mountain View, CA 94039-7210, (415) 962-8910. Inquiry 614.

Music Construction Set for the Apple IIGS

Music Construction Set is now available for the Apple IIGS. The music program features 15 digitized instruments and supports musical instrument digital interface output to MIDI-compatible keyboards and instruments as well as to the SuperSonic stereo card from MDIdeas Inc.

Music Construction Set takes advantage of the mouse and windows interface of the IIGS. High-resolution graphics is used on-screen, and the program can print in standard sheet-music format. Other features include cut-and-paste editing and a library of musical notation items, including thirty-second notes, rests, slurs, quintuplets, double sharps and flats, and octave raisers.

Price: \$49. Contact: Electronic Arts, 1820 Gateway Dr., San Mateo, CA 94404, (415) 571-7171. Inquiry 615.

SEND US YOUR NEW PRODUCT RELEASE

If you want us to consider your product for publication, send us full information about it, including its price, ship date, and an address and telephone number where readers can get further information. Send to New Products Editor, BYTE, One Phoenix Mill Lane, Peterborough, NH 03458. Because of the volume of submissions we must sort through every month, the items we publish are based on vendors' statements and are not individually verified.

TEKTRONIX NEW ADVANCED PC GRAPHICS STANDS ALONE.



BECAUSE IT WORKS TOGETHER.

Introducing Tek Advanced PC Graphics: a fully integrated system of high-performance graphics, easy system connectivity, and unparalleled application



software for your PC. Tek Advanced PC Graphics starts with a flexible multiple-rate color graphics monitor that provides 640x480 Tektronix-style graphics as well as EGA and

CGA software compatibility.

Driving your monitor to a whole new level of graphics speed is Tek's PC4100 graphics coprocessor board. It features Texas Instruments' powerful TMS 34010 32-bit



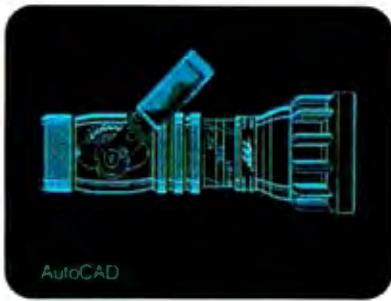

Graphics System Processor for ultra-fast throughput of your design applications. Add to that Tek's PC-05 or PC-07 terminal emulation software, and you're ready for stand-alone computing or access to a world of mainframe graphics.

To bring those applications to life, you can connect a Tek color ink-jet printer. And start producing high-resolution, vibrant hardcopy output on either paper or transparencies.

Couple all that with Tektronix worldwide support and service, and your PC can gain the

same productive advantages that host-based systems in scientific and engineering environments have had for close to two decades.

Tek's PC4100 graphics coprocessor board delivers serious graphics on a stand-alone basis. Built around the Texas Instruments Graphics System

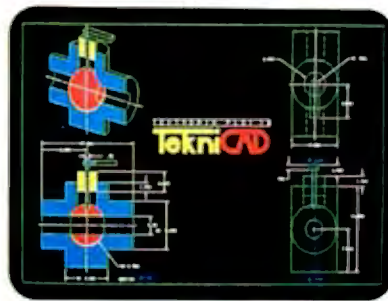

Processor(GSP); the graphics coprocessor board achieves a combination of sophisticated graphics and fast throughput your PC just couldn't deliver before. The GSP assumes the complete graphics processing workload, freeing your PC processor for other requirements.



refresh rate. So you can use advanced packages like AutoCAD[®], Zenographic's Mirage[™] and VersaCAD[™].

Then, to move from GSP graphics to emulation of the IBM[®] Enhanced Graphics Adapter(EGA) mode, you simply soft-switch. And you're

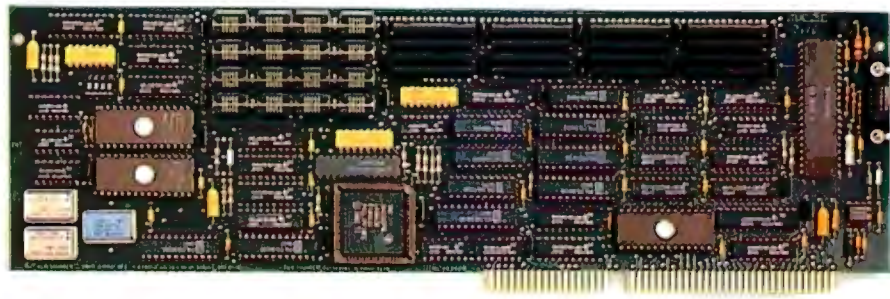

New companion monitor brings together fine detail and maximum flexibility. You'll view your applications on Tek's new multiple-rate monitor. In true Tek tradition, it provides ideally balanced, 640x480 addressability and a 60 Hz non-interlaced

ready to run the popular PC packages you probably already use in CGA/EGA mode—standards like Lotus[®] 1-2-3[®], Microsoft[®] WORD[®] and Microsoft[®] Windows[®], to name just a few.

Last, but not least, Tek's PC4100 links you to a world of mainframe graphics. All you do is load Tek PC-05/PC-07.

Tek PC-05/PC-07 terminal emulation software gives you mainframe accessibility with the local processing power of your PC. Because Tek PC-05 and PC-07 terminal emulation software runs under MS-DOS[®] 2.0 and higher, you can run your mainframe-based



AND SETS YOU APART.

applications software on your PC as if it were a Tek 4105 or 4107 terminal.

Which means you can quickly access the power of Tek graphics—including 4107 segments, true zoom and pan, rubberbanding, definition of up to 64 viewports and more. You can use these highly productive features with a wide range of well-known designer software packages such as ISSCO's DISSPLA[®] and TELL-A-GRAF,[®] MCS's ANVIL-5000,[™] SAS Institute Inc.'s SAS/GRAPH, Precision Visuals' DI-3000,[®] Swanson Analysis Systems' ANSYS[®] and McNeal-Schwendler's NASTRAN.

In addition, you can utilize software development tool sets like Tektronix PLOT 10[®] GKS, IGL, TCS and STI software as well as numerous driver support packages created for the 4105 and 4107.

Completing the picture: perfect color output with Tek's reliable ink-jet printers.

At the push of a button, the Tek 4696 lets you produce exacting color reproductions of

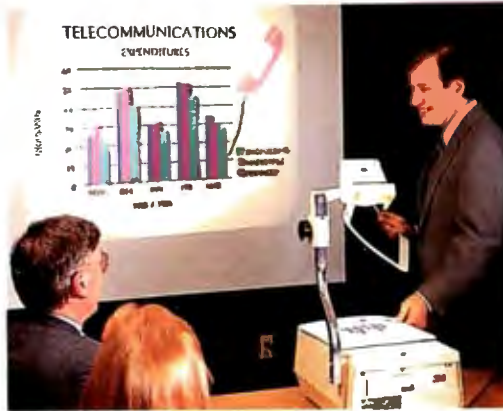

your on-screen display on either paper or transparencies.

Because of its 120 dots per inch addressability in both horizontal and vertical directions, you can achieve resolution of up to 1280 points x 960 points per "A" size image.

All the key tools for software development, right from the outset. The new Tektronix Graphics Interface[™] (TGI) for the PC provides the basics of Tek graphics functionality to application programs

running under MS-DOS. What's more, in-circuit emulator, C-compiler, assembler and linker are all available from Texas Instruments to help software developers write applications packages for the PC4100 graphics coprocessor board.

To enable sufficient workspace for custom interfaces or specific application programs, the PC4100 graphics coprocessor board comes standard with a full megabyte of program memory.

Put yourself on the sure path of Tek graphics evolution.

Whether you choose Tek PC stand-alone graphics, Tek's high-resolution monitor, Tek terminal emulation or all three, you can be assured Tek will keep you current with the best and most productive graphics. Because like all our products, Tek Advanced PC Graphics features a smooth built-in pathway to higher-level graphics.

For more information about how Tek lets you stand alone and work together, contact your local Tek representative about Tek Advanced PC Graphics. Or call, 1-800-225-5434. In Oregon, 1-235-7202.

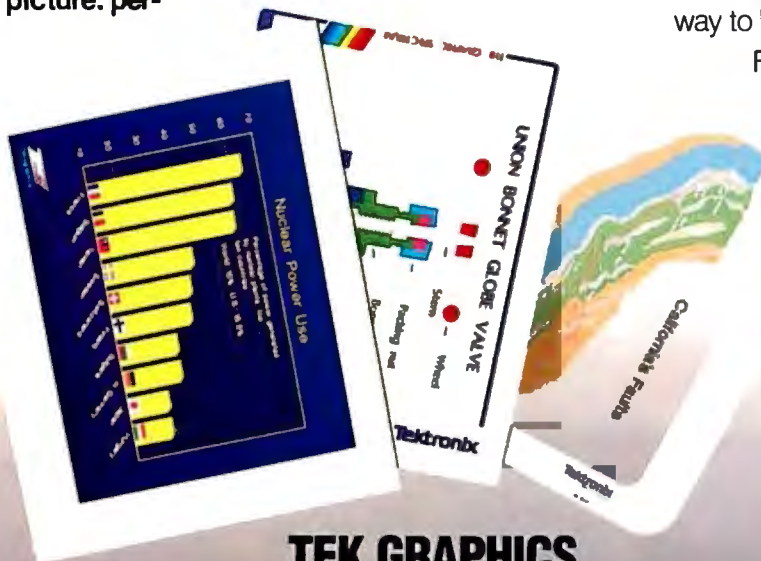

TEK GRAPHICS PROCESSING SYSTEMS

Tektronix
COMMITTED TO EXCELLENCE

EVENTS AND CLUBS

June 1987

EVENTS

COMDEX/Spring, Atlanta, GA. The Interface Group Inc., 300 First Ave., Needham, MA 02194, (617) 449-6600. *June 1-4*

Real-Time Factory Control, Detroit, MI. Dianne Leverton, Society of Manufacturing Engineers, One SME Dr., P.O. Box 930, Dearborn, MI 48121, (313) 271-1500, extension 383. *June 2-4*

Third International Expert Systems Conference and Exhibition, London, England. Learned Information Ltd., Woodside, Hinksey Hill, Oxford OX1 5AU, England, 0865-730275. *June 2-4*

Troubleshooting Microprocessor-based Equipment and Digital Devices, Dallas, TX, and other locations in the U.S. Janet McHenry, Micro Systems Institute, Garnett, KS 66032, (913) 898-4695. *June 2-4*

Artificial Intelligence and Advanced Computer Technology Conference and Exhibition/Europa, Frankfurt, West Germany. TCM Expositions Ltd., 331 West Wesley St., Wheaton, IL 60187, (312) 668-8100. *June 3-5*

ROBEXS '87, Pittsburgh, PA. Instrument Society of America, 67 Alexander Dr., P.O. Box 12277, Research Triangle Park, NC 27709, (919) 549-8411. *June 4-5*

Sixteenth Annual Meeting of the MUMPS Users' Group, Atlanta, GA. MUMPS Users' Group, 4321 Hartwick Rd., Suite 510, College Park, MD 20740, (301) 779-6555. *June 8-12*

USENIX Summer Conference and Exhibition, Phoenix, AZ. USENIX Conference Office, P.O. Box 385, Sunset Beach, CA 90742, (213) 592-1381. *June 8-12*

Computex Taipei '87, Taiwan, R.O.C. Taipei World Trade Center, 201 Tunhwa North Rd., Taipei 10591, Taiwan, Republic of China, (02) 715-1515. *June 8-14*

ESD/SMI Expert Systems for Advanced Manufacturing Technology Conference and Exposition, Dearborn, MI. Marion L. Weber, Conference Administrator, Engineering Society of Detroit, 100 Farnsworth, Detroit, MI 48202, (313) 832-5400. *June 9-11*

Thirty-fifth Annual Technical Writers' Institute, Troy, NY. Office of Continuing Studies, Rensselaer Polytechnic Institute, Troy, NY 12180, (518) 266-6442. *June 9-12*

Advanced Printed Circuit Board Design Techniques, Milwaukee, WI. Peter L. Tocups, Program Director, Center for Continuing Engineering Education, University of Wisconsin-Milwaukee, 929 North Sixth St., Milwaukee, WI 53203, (414) 227-3125. *June 10-12*

National Computer Conference, Chicago, IL. NCC '87, American Federation of Information Processing Societies, 1899 Preston White Dr., Reston, VA 22091, (800) 622-1987; in Virginia, (703) 620-8955. *June 15-18*

ISDN/Broadband Networks for the Future, Atlanta, GA. Information Gatekeepers Inc., 214 Harvard Ave., Boston, MA 02134, (617) 232-3111. *June 15-19*

COMDEX International in Europe, Nice, France. The Interface Group, 300 First Ave., Needham, MA 02194, (617) 449-6600. *June 16-18*

IEEE First Annual International Conference on Neural Networks, San Diego, CA. Nomi Feldman, Conference Coordinator, 3770 Tansy St., San Diego, CA 92121, (619) 453-6222. *June 21-24*

1987 National Educational Computing Conference, Philadelphia, PA. Gayle J. Yaverbaum, Temple University, Department of Computer and Information Science, Computer Activities Building, Philadelphia, PA 19122, (215) 787-8810. *June 24-26*

VDT Health & Safety, Washington, DC. Continuing Education Institute, 21250 Califa St., Suite 102, Woodland Hills, CA 91367, (818) 710-1126. *June 25-26*

If you send notice of your organization's public activities at least four months in advance, we will publish them as space permits. Please send them to BYTE (Events and Clubs), One Phoenix Mill Lane, Peterborough, NH 03458.

CLUBS

New York Personal Computer Inc., Suite 614, 80 Wall St., New York, NY 10005, (212) 533-6972.

C Users Group Italia, c/o Fabrizio Virtuani, Via Valsesia 86, 20152 Milano, Italy.

International Computing Association (ICA), c/o Markus H. Maege, Roebek 6, 2000 Hamburg 52, West Germany, (49) 40-632-3517.

WorldWide Commodore, P.O. Box 4002, S-35004 Vaxjo, Sweden.

The Carrier, newsletter of the Telecommunications Users Group; P.O. Box 45254, Seattle, WA 98145.

Columbia-Baltimore User Group (CBUG), P.O. Box 125, Columbia, MD 21045, BBS: (301) 730-5624.

Real Times, Greater Boston Chapter newsletter of The Association for Computing Machinery; P.O. Box 465, Lexington, MA 02173.

South Bay Apricot Users Group, c/o Ken Stevens, 17302 Yukon Ave., Suite 11, Torrance, CA 90504, (213) 515-7718.

Connect, newsletter of the South Jersey ST Users Group; 205 Emerald Ave., Westmont, NJ 08108, BBS: (609) 858-7817.

Tandem Users' Journal, the International Tandem Users' Group (ITUG); 111 East Wacker Dr., Suite 600, Chicago, IL 60601, (312) 644-6610.

MacHonor Bulletin, newsletter for CE Software Customers; CE Software, 801 73rd St., Des Moines, IA 50312, (515) 224-1995.

Island Reach Computer Users Group, P.O. Box 73, Deer Isle, ME 04627, (207) 348-9917.

Sales Professionals Using Computers (SPUC), 218 Huntington Rd., Bridgeport, CT 06608, (203) 333-6436.

Lake County Amiga Users Group, c/o Philip Brauer, 280 Glen St., #2D, Grayslake, IL 60030, (312) 223-3209. ■

Introducing the Hercules InColor Card.

*It runs more software at a higher resolution
than any other color graphics card.*

The Hercules® InColor™ Card offers everything you'd expect from a high resolution color graphics card from Hercules — and more.

Compatibility: The InColor Card is compatible with the thousands of programs that run on our monochrome cards.

Color: The InColor Card gives color capability to Hercules-compatible software like 1-2-3® and AutoCAD®.

Resolution: The InColor Card's resolution of 720x348 is the highest of any widely supported standard.

RamFont: The InColor Card has our unique RamFont mode — in color.

Better graphics.

Hercules is known for bringing high

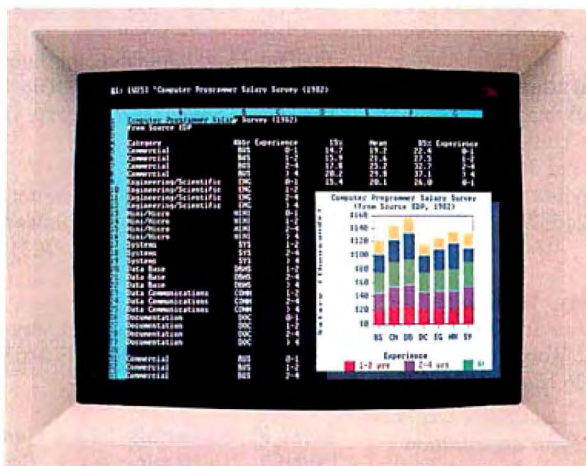

The InColor Card's RamFont mode gives Lotus 1-2-3 a pop-up graphics window and lets you view nearly twice as much spreadsheet data—all in full color.

resolution monochrome text and graphics to programs like 1-2-3® and AutoCAD®.

Now the InColor Card gives you the same high resolution 720x348 graphics in up to 16 colors using an IBM® Enhanced Color Display, multi-sync monitor, or equivalent.

That's the highest resolution of any widely supported graphics standard.

And no other color graphics card allows you to move back and forth between color and monochrome systems *without changing drivers*.

Runs more software.

All Hercules-compatible text, graphics and RamFont software runs on the InColor Card in black and white, or at least two colors.

And many popular programs like 1-2-3, Symphony®, AutoCAD and Microsoft® Windows that use graphics or RamFont, run in full color.

More powerful RamFont.

RamFont is a new mode developed by Hercules that gives your software the ability to display multiple fonts at lightning fast speeds.

RamFont transforms advanced word processors like Microsoft Word from slow to text-mode fast.

Technical word processors like Lotus Manuscript™ use RamFont

to display onscreen the text you want to print.

Even 1-2-3 uses RamFont to almost double the size of the spreadsheet picture.

And now, with the InColor Card, you get an enhanced RamFont with 3,072 programmable characters in up to 16 colors.

All the way up to 12,288 characters in four colors.

With the InColor Card's RamFont, no program should run out of speed, color or fonts ever again.

What the InColor Card could mean to your company.

The InColor Card allows you to run a program in color, and then move to a Hercules Graphics Card Plus and run the same program in monochrome.

Without changing drivers.

Compatibility between the InColor Card and our monochrome card allows you to network around one standard — Hercules. At last your PCs will have compatible graphics, in color or monochrome.

Remember, only the InColor Card has color-to-monochrome compatibility, high resolution text and graphics, and the power of color RamFont.

To find out more about the new Hercules InColor Card, call 1-800-532-0600 Ext. 502. (In Canada, call 1-800-323-0601 Ext. 502.)



AutoCAD gets the same high resolution 720x348 graphics as our famous monochrome cards—only now in full color on an IBM Enhanced Color Display.

Features of the Hercules InColor Card

- Hi-res text with 9x14 character size in up to 16 colors with attributes
- 720x348 Hercules graphics in 16 colors selected from 64 color palette
- Special RamFont mode displays 3,072 programmable characters in 16 colors with attributes, up to 12,288 characters in 4 colors
- Runs Hercules-compatible graphics software in b&w or any two background colors
- Designed for use with the IBM Enhanced Color Display, multisync monitors, or equivalents
- Software diskette includes font editor, sample fonts, and Hercules utilities
- Parallel printer port
- Two year warranty

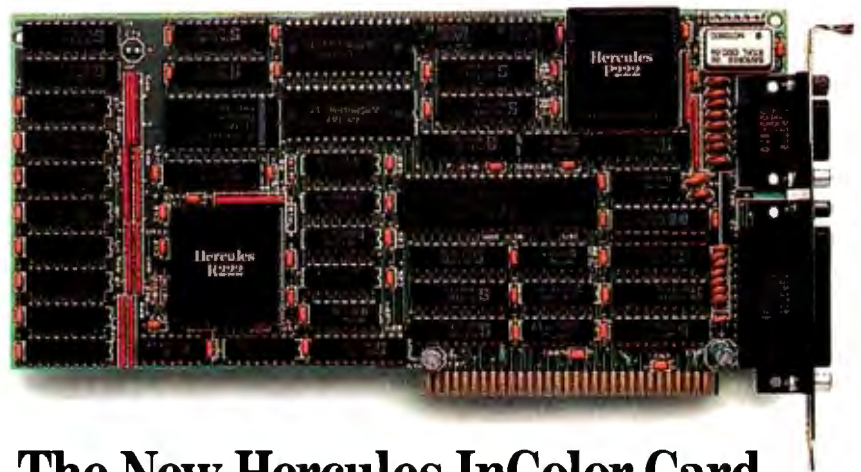

The New Hercules InColor Card.

Hercules Computer Technology, 2550 Ninth St., Berkeley, CA 94710 Ph: 415 540-6000 Telex: 754063 Fax: 415 540-6621 Trademarks/Owner: Hercules, InColor, RamFont/Hercules; Lotus, 1-2-3, Symphony, Manuscript/Lotus; Microsoft/Microsoft; AutoCAD/AutoDesk; IBM/IBM

ASK BYTE

Conducted by Steve Ciarcia

Terminal Problems

Dear Steve:

I am having great difficulties with my computer system. I have an IBM PC AT with two serial ports and three parallel ports. I have been trying to connect a Kimtron KT-7/PC terminal (with AT-type keyboard layout) into one of the serial ports to use as an auxiliary terminal. I have used the MODE command to initialize the port and the CTTY command to change the terminal. But the only thing I can do from the Kimtron is to switch from directory to directory and call up a directory listing. When I attempt to run a program (i.e., SuperCalc3, WordStar, dBASE III, and BASICA), the terminal freezes. In some cases, the program can be seen through the main monitor.

Is this problem associated with the operating system I am using (PC-DOS 3.1), or is it the application software? I have been told that terminal set-up programs may be required; if this is the case, where can I get them?

David Ware
Oklahoma City, OK

The reason that the programs don't work on the remote terminal has nothing to do with either DOS or the rumored set-up programs. It's in the application programs, and it's not fixable. Period.

The CTTY program simply redirects DOS's input and output requests to the remote terminal. Any program that uses DOS calls to read the keyboard and display characters on the screen will work correctly from the remote terminal. But most programs use the BIOS calls to read the keyboard, because DOS doesn't give enough information about the special keys. CTTY doesn't affect the BIOS calls, so programs using those calls will continue to look for characters from the PC keyboard regardless of what you type on the terminal. And some programs use both DOS and BIOS calls, so they tend not to work at all.

Nearly all programs write directly to the screen buffers in RAM rather than using the DOS or BIOS calls, simply because that's the only way to get acceptable performance. CTTY doesn't have any effect on memory writes, so these programs blithely sprinkle their characters on the PC's screen.

To make matters worse, various ver-

sions of CTTY have a variety of bugs. Because nobody ever uses it, the bugs are pretty awful. Because the bugs are pretty awful, nobody ever uses it. And so it goes.

You'll note that most of the programs you list say that they're intended for "IBM PCs or 100 percent compatibles" (although you may have to read the fine print to find that statement). As there is no standard for remote terminals on a PC, even though CTTY is "standard" DOS, it's not going to help you win an argument with the vendors. Sorry, but I don't have a magic fix up my sleeve for you. —Steve

LISP Machines

Dear Steve:

I am a student of mathematics and information science at Warsaw University. I am interested in a computer for implementing some artificial intelligence systems that I have written in LISP (Common LISP version). I read about LISP machines in BYTE last year, and I wonder if you could give me some more information about them; specifically, whether they work by compiling or interpreting, and how their speed of execution compares with IBM PC XT LISP (Waltz-LISP).

Adam Kraure
Warsaw, Poland

A LISP machine is a computer that is specifically designed to run LISP programs. The memory includes (in addition to the normal data) extra bits in every memory word, to describe the data types; the CPU includes special operations to speed up LISP programs; and the display has very high resolution. As you might expect, LISP machines are not cheap: Prices start at around \$20,000 for a stripped version, and beyond that the sky is the limit.

It seems that Common LISP is the emerging standard for the LISP language, so a dialect of that is probably your best bet. Newer versions are optimized for the IBM PC AT, so the performance is at least acceptable, if not in the same league as a true LISP machine. The LISP programs run using the 80286's protected mode to access up to 16 megabytes of RAM and require a great deal of disk space. You won't be able to get by with a stripped PC AT.

You might want to talk your library into a subscription to the Institute of Electrical and Electronic Engineers (IEEE) Expert magazine. It covers the latest technical developments in the AI field and may give you some ideas on the subject. Write to the IEEE Service Center, 445 Hoes Lane, Piscataway, NJ, 08854, U.S.A., for the subscription details. It will cost about \$40 including shipping.

Incidentally, LISP Machine is also the trade name of a company in Andover, Massachusetts. —Steve

What a Deal

Dear Steve:

If you appreciate the occasional off-the-wall question, I have a pair of them for you.

First, a few months ago, while in the U.S., I bought an Oberon Omni-Reader from California Digital. It is a rather nice optical character reader that, since Oberon had gone under, was selling for \$180 rather than the original \$700. The ad implied that the unit came with support for several different computers. Since I had heard of the unit and had even kept the original reviews from the U.K. press, I jumped at the chance and called in an order. As luck would have it, the unit was not delivered until after I left the U.S., so I didn't have a chance to look at it until it arrived here in Saudi Arabia.

continued

IN ASK BYTE, Steve Ciarcia answers questions on any area of microcomputing. The most representative questions received each month will be answered and published. Do you have a nagging problem? Send your inquiry to

*Ask BYTE
c/o Steve Ciarcia
P.O. Box 582
Glastonbury, CT 06033*

Due to the high volume of inquiries, we cannot guarantee a personal reply, but Steve and the Ask BYTE staff answer as many as time permits. All letters and photographs become the property of Steve Ciarcia and cannot be returned.

The Ask BYTE staff includes manager Harv Weiner and researchers Eric Albert, Bill Curlew, Ken Davidson, Jeannette Dojan, Jon Elson, Roger James, Frank Kuechmann, Dave Lundberg, Tim McDonough, Edward Nisley, Dick Sawyer, Andy Siska, Robert Stek, and Mark Voorhees.

News about the Microsoft Language Family

New Microsoft® QuickBASIC 3.0 Includes Integrated Debugger and Editor Enhancements

It's hard to improve on a great product like Microsoft QuickBASIC, but we've added and enhanced features in Version 3.0 that make developing programs faster and easier than ever. Integrated debugger enhancements let you pinpoint errors by tracing or animating through your source code. Now you can observe the contents of your program's variables as the program is running. And set dynamic break-points at runtime to easily stop the program where you want. You don't have to add STOP statements to your programs and wait for another compilation anymore. With the debugger completely integrated into the compiler, you can start debugging your program while it's running simply by pressing CTRL-BREAK.

Microsoft Quick-BASIC's built-in editor has been enhanced to support oertype as well as the existing insert mode so editing your programs is easier. In contrast to other compilers that give up after finding a single error, Microsoft QuickBASIC keeps track of all errors found during compilation. You can correct all the errors at once instead of recompiling for each error. And the Microsoft QuickBASIC Version 3.0 editor is compatible with SuperKey®, ProKey™ and SideKick® programs.

As in Version 2.0, Microsoft QuickBASIC 3.0 supports multiple-module programming. Separate compilation lets you divide your program into pieces that are compiled independently. These pieces can be integrated into other BASIC programs without recompilation. The linker in Microsoft QuickBASIC makes it easy to add Microsoft Macro Assembler object files to your BASIC programs. Just assemble your Microsoft Macro Assembler routines and let the linker incorporate them into Microsoft QuickBASIC automatically. There's no need to convert your Microsoft Macro Assembler routines into COM files or write them as hexadecimal numbers in your BASIC source file as in other compilers.

Math Coprocessor Support in Microsoft QuickBASIC 3.0 Speeds Programs

Microsoft QuickBASIC now has support for the 8087 and 80287 math coprocessors. The full 80-bit IEEE math support of the math coprocessor is needed for programs that demand the most precise calculations. In addition to this, you may use the existing Microsoft Binary Math support for fast 64-bit math or the new 8087 emulation routines for more accuracy when you don't have a coprocessor.

There have also been many dramatic speed enhancements in Microsoft QuickBASIC 3.0, especially in graphics and math. For example, Version 3.0 is 118% faster than Version 2.0 for circles. And with 8087/80287 math coprocessor support, the floating-point math is 160% faster than in Version 2.0.

New Microsoft QuickBASIC Language Extensions Make Programs Easier to Read

A number of new control structures such as SELECT CASE, DO WHILE, DO UNTIL, LOOP WHILE, LOOP UNTIL, and EXIT have been added to Microsoft QuickBASIC 3.0. These are statements similar to those found in Microsoft C and Microsoft Pascal. These statements, in addition to the block IF/THEN/ELSE/END IF (which was incorporated in Version 2.0), make structured programming easier.

The new named constants make your programs more readable and easier to maintain. Subprograms and multi-line functions have true local variables and allow you to call them by name and pass them parameters. These C-like structures let you write programs that are more well organized.

For more information on the products and features discussed in the Newsletter, write to: Microsoft Languages Newsletter
16011 NE 36th Way, Box 97017, Redmond, WA 98073-9717.
Or phone:
(800) 426-9400. In Washington State and Alaska,
call (206) 882-8088. In Canada, call (416) 673-7638

Microsoft and the Microsoft logo are registered trademarks of Microsoft Corporation. ProKey is a trademark of RoseSoft, Inc. SideKick and SuperKey are registered trademarks of Worland International, Inc.

Latest DOS Versions:

Microsoft C Compiler	4.00
Microsoft COBOL	2.20
Microsoft FORTRAN	4.00
Microsoft Macro Assembler	4.00
Microsoft Pascal	3.32
Microsoft QuickBASIC	3.00



Copying diskettes will never be easier than pushing one button.

While your computer is busy doing other things, your Victory Duplicator can be making as many as eight copies of a diskette at once—producing up to 400 copies in an hour. DualMaster™ models can even make multiple copies of two different diskettes simultaneously. Just insert the diskettes and press one button.

Copy different formats, flawlessly.

An automatic format analysis program makes it possible for the Victory Duplicator to

copy virtually any 5¼, 3½ or 8-inch diskette. The system tests for quality and accuracy at every stage of the process.

It practically services itself.

Each drive has a separate controller to maximize uptime. Simple diagnostics to verify drive alignment and industry standard drives allow you to maintain your system without waiting for outside service.

All at an attractive price.

Victory Duplicators offer fast copying, serialization,

copy protection, a communications port, a four-month warranty and much more—all for one low price.

Call 1-800-421-0103.

Call today for more information. (In Texas, call 512-450-0801.)



VICTORY ENTERPRISES
Technology, Inc.

8910 Research Blvd., Suite B2
Austin, Texas 78758

©1987 Victory Enterprises Technology, Inc.

UNLOCK™ Products Remove Copy Protection RUNS YOUR SOFTWARE ON ANY HARD DISK

UNlock "copying" disk allows you to make "unprotected" DOS copies of popular original program disks. Unprotected backup copies perform perfectly, as do copies of these copies. UNlock copies run on any hard disk, including Bernoulli Boxes. No original required in drive "A". Run on a RAM disk simply and conven-

iently. Also, copy DOS 5¼" programs to 3½" diskettes. For IBM®PC,XT,AT, compatibles, 256K or more, DOS 2.1 or higher. Back-ups don't require tedious un-installs, and reorganizing your hard disk doesn't result in your software calling you a thief! Back-ups are as easy as the "COPY" command in DOS.



CHOICE OF THE CRITICS!



"UNlock has two particularly endearing characteristics: it works, and works simply. I was able to quickly produce unprotected copies of Lotus 1-2-3 release 2, Symphony 1.1, Microsoft Word 2.0, dBase III 1.1, and Framework II. These copies performed flawlessly, as did copies of these copies." Christopher O'Malley
PERSONAL COMPUTING, April '86



"Because copy protection can interfere with the ability to back up a hard disk, business-oriented

users may prefer programs like TranSec's UNlock series." Winn L. Rosch, PC MAGAZINE, MAY 27, 1986

TRANSEC™ UNLOCK™ PRODUCTS

ORDER TODAY TOLL FREE:
1-800-423-0772
IN FLORIDA: 1-305-276-1500



TranSec Systems, Inc., 220 Congress Park Drive, Delray Beach, FL 33445
Trademarks are the sole property of their respective owners. UNlock is for use only to improve the useability of legally acquired and operated software.

The software was for an IBM and the main instruction manual was missing, although it did have an interface manual with it. I hooked it up and it works. Have you ever heard of this machine or do you know anyone who might have? I am looking for any available information.

The second question relates to the first: The interface manual says that to interface the optical character reader with Apple II computers you should use the Super Serial Card as an RS-232C interface. Well, I have the old Apple serial card (which is far from super but is at least here and paid for). I wrote a short program to read from the Omni reader using INPUT statements. This program actually works but is clumsy to use. I tried using the GET statement but all I get is trash; I suspect this is a result of not being in sync with the input. I seem to recall that you designed a serial interface card for the Apple, but I only have about three years of back issues and I can't find the article. If you did, can you tell me what issue? Also, I would appreciate any suggestions you might have for my using the reader with my current setup.

Marshall P. Brown
Saudi Arabia

The original developer of the Omni-Reader, Oberon, is indeed no longer among the living. Marketing rights to the design are now owned by G.A.S International Inc., P.O. Box 1282, Euless, TX 76040, (800) 523-4898. They may be able to assist you.

Several descriptions of the Oberon character reader have been published in the American microcomputer press. The reports have indicated that, while the hardware seems capable enough, speed is limited, only a few type fonts can be read, and the error rate is unacceptably high. Software improvements by G.A.S. International may change the situation, however.

Garbage can result when the two systems disagree as to the data rate (baud) and format (number of data bits and stop bits, and the type of parity used). You might try experimenting with variations to the serial card, although your experience using INPUT suggests that this is not the cause of your problems.

Several commercial utility packages have been marketed that use the Applesoft ampersand vector to create routines in machine code that can be used to "input anything," from peripheral devices as well as from the keyboard. Assembly listings and descriptions of programs with similar capabilities have appeared in several of the Apple-specific computer magazines: Nibble and Call-A.P.P.L.E., to

continued

Order Status,
Technical & Other
Info. (602) 246-2222



SPECIAL
MICROSOFT WORD
\$179

Call for programs
not listed

TOLL-FREE ORDER LINE 1-800-421-3135

FREE SOFTWARE! FREE SOFTWARE! FREE SOFTWARE!

Purchase over \$100 and receive one of these disks absolutely FREE! Purchases over \$250 get two free disks, over \$400 get three, or get all four disks when your purchase is over \$500! 1) **MIXED BAG** — A great assortment of utilities and games all packed on one disk. 2) **PC-WRITE** — Try this famous feature packed word processor. It's a winner! 3) **FONT-SET** — Lets you set popular fonts like bold, underline, etc. on most late model printers from Citizen, Epson, NEC, Okidata, Panasonic, Star, Toshiba, etc. You can even use your printer like a typewriter! 4) **ABC-LIST** — Great mailing list program! Sort on any field, do qualified searches, print reports and mailing labels, and more!

— SOFTWARE —

ACCOUNTING

BPI AP, AR, PR, GA \$169 ea.
Cyma Call
Dac Easy Accounting 39
Dollars & Sense 94
Managing Your Money 3.0 108

COMMUNICATION PROGRAMS

Carbon Copy 115
Crosstalk 89
Remote 89
Smartcom II 83

DATA BASE MANAGERS

Clipper 380
Clout 2 Call
Condor III 310
Knowledgeman II Call
Powerbase 2.2 169
Q&A Call
Quickcode 138
Quicksilver 295
Quickreport 138
Revelation 469
R: Base System V 345

EDUCATIONAL

Flight Simulator 28
Turbo Tutor II 25
Typing Tutor III Call

GRAPHICS

Chartmaster Call
Energraphics 2.0 294
In-A-Vision 275
Microsoft Bus Mouse 106
Microsoft Chart 164
Microsoft Serial Mouse 119
Newsroom 31
OPTI Mouse W/DR Halo II 106
Printshop 33
Signmaster Call

INTEGRATED

Ability 59
Enable 355
Smart Software Call

LANGUAGES

Lattice C Compiler 242
Microsoft C Compiler 249
Microsoft Fortran 4.0 255
Microsoft Macro Assembler 84
Microsoft Pascal Compiler 166
Microsoft Quick Basic 55
Ryan McFarlan Fortran 305
Ryan McFarlan Cobol 479
Turbo Basic 55
Turbo Pascal w/8087 + BCD 55

PROJECT MANAGER

Harvard Total Project 262
Microsoft Project 219
Super Project Plus Call
Timeline 2.0 209

SPREADSHEET

Microsoft Multiplan 108

Spreadsheet Auditor 3.0 \$82
Supercalc 4 Call
VP Planner 49

UTILITIES

Copy II PC 19
Copywrite 39
Desqview 55
Double Dos 30
Fastback 85
Graph in the Box 55
Homebase 39
Microsoft Windows 55
Norton Utilities 3.1 48
Prokey 4.0 70
Sidekick (unprotected) 47
Sideways 3.1 36

WORD-PROCESSING

Easy Extra 88
Microsoft Word 179
Multimate Advantage Call
Volkswriter 3 139
Webster Spellcheck 37
Word Perfect 195
Wordstar 162
Wordstar Propac 233
Wordstar 2000 233
Wordstar 2000+ 278

— HARDWARE —

ACCESSORIES

Copy II PC Board 75
150 watt power supply 69
Mini Micro Parallel
Print Buffer 69
Masterpiece 88
Masterpiece Plus 113

BOARDS

AST Advantage Premium 422
AST Premium Sixpac Call
AST Sixpac (384K) 219
Hercules Color Card 145
Hercules Graphics + 182
Intel Above Boards Call
J Laser (Tall Tree) Call
J Ram 3 (Tall Tree) 159
J Ram 3 AT (Tall Tree) 199

COMPUTERS

AZ TURBO PC

IBM Compatible Computer,
4.77 or 7.47 key selectable,
keyboard, 640K, dual drive,
mono graphics card, 150
watt power supply 719
or with 20 MB Seagate
Hard Drive 1025
6 month limited warranty

AZ TURBO AT

IBM AT Compatible, 512K,
6 & 8 MHZ, keyboard,
graphics card, 220 watt
power supply, MS/DOS 3.2
GW Basic 1260

AST 286

PREMIUM COMPUTER

512K, expandable to 2MB on
the system board, RT en-
hanced style keyboard, paral-
lel, serial and clock, 1.2 MB
floppy disk drive, 7 expansion
slots, two 32 bit fastram slots,
DOS 3.1 & Basic
1 year warranty Call

Sharp Portable Call

EGA BOARDS

Everex Enhancer EGA 235
Paradise Auto Switch 480
EGA Card 379
Quad EGA Plus 349
Vega Deluxe Call
Vega Video 299

EGA MONITORS

AMDEK 722 455
NEC Multisync 559
Packard Bell EGA 450

HARD DRIVES

AZ 20 MB Hard Card 425
AZ 30 MB Hard Card Call
Filecard 20 MB 555
Maynard 20 MB Hard Card Call
Plus Hardcard 20MB 665
Seagate 20 MB Int. w/cont. 333
Seagate 30 MB Int. w/cont. 399
Seagate 30 AT Int. 539

INCREDIBLE VALUES

Nationally advertised boards for
IBM PC and most compatibles
at give away prices.

Keyboards (similar
to 5151) \$79
Monochrome Board w/printer
port (similar to Hercules
Graphics) \$79
Expansion Board
0 to 576K \$42
Multifunction Board w/game
port (similar to AST
six pack) \$79
Four Drive Floppy
Controller \$39
Color Card w/o printer
port \$69
Color card w/printer
port \$79

KEYBOARDS

Keytronics 5151 \$162
Keytronics 5153 269

MODEMS

Everex 300/1200 120
Hayes 1200 Call
Hayes 1200B Call
U.S. Robotics Courier 2400 349
U.S. Robotics Passwd. 1200 180

MONITORS

AMDEK 410 Amber 157
AMDEK 600 339
Magnovox Color RGB Call
Multitech Color RGB 299
Princeton Max 12 159
Samsung TTL Amber 72
Samsung TTL Green 70

PRINTERS

CANON LASER 1939

CITIZEN

MSP-10 279
MSP-15 379
MSP-20 315
Premiere 35 Daisywheel 459

EPSON - Call on all models

FUJITSU

DX2100 Parallel Call

DL2400 Ser/Par Call

LASER IMAGE 2000 Call

NEC

NEC P5XLP 1095

NEC P7 Parallel 619

NEC 8850 1059

NEC P6 Parallel 439

OKIDATA - Call on all models

PANASONIC

1091-I 259

1092-I 329

1592 425

KXP3151 399

STAR MICRONICS

NP10 Call

NB15 975

NX10 232

SG15 365

SR15 549

TOSHIBA - Call on all models

RAM

64K 150NS (set of 9) 13.50

256K 150NS (set of 9) 30

256K 120NS (set of 9) Call

TERMS: Shipping on most software is \$5.00. AZ orders +6.7% sales tax. Personal check/company check - allow fourteen (14) days to clear. We accept purchase orders from authorized institutions for 3.5% more than cash price. All returns are subject to our approval. There will be a 20% restock fee. Minimum phone order \$50. All prices are subject to change. Due to copyright laws we cannot take back any open software.

No Charge for Master Card or Visa



We do not guarantee compatibility

TOLL-FREE ORDER LINE 1-800-421-3135

WAREHOUSE DATA PRODUCTS

2701 West Glendale Ave. • Phoenix, AZ 85051

Phone Hours: Monday, Wednesday & Thursday
7 am-9 pm; Tuesday & Friday 7 am-5 pm; Satur-
day 9 am-5 pm. MST.

WHY PAY MORE?



GRAPHICS/CAD-CAM

Autocad 2.52	\$2,195
Drafix	199
Freelance Plus	299
Harvard Presentation	195
Microsoft Chart	179
Prodesign II	179

LANGUAGES

Microsoft C	\$249
Microsoft Cobol	385
Microsoft Fortran	249
Microsoft Macro Assembler	84
Microsoft Quick Basic	59
Turbo Pascal	55

PROJECT MANAGEMENT

Harvard Total	\$339
Microsoft Project	219
Super Project Plus	259
Time Line	219

FINANCIAL/ACCOUNTING

BPI	\$145
Computer Associates	325
Dollars 'N' Sense	95
Great Plains	386
Managing Your Money	105

UTILITIES

Carbon Copy	\$119
Crosstalk XVI	87
Fast Back	84
Fixed Disk Organizer	45
Microsoft Windows	55
Norton Commander	36
Norton Utilities	48
PC DOS 3.2	69
Sidekick	47
Sideways	34
Smart Com II	75
Superkey	38

SPREADSHEET / INTEGRATED

Enable	\$335
Framework 2	395
HAL	89
Lotus 1-2-3	305
Lotus 3.5" Ver.	315
Lotus Metro	55
Lotus Report Writer	99
Microsoft Multiplan	105
Smart Integrated	429
Supercalc IV	285
Symphony	439



YOUR MONEYSWORTH GUARANTEE

- ★ Credit cards not charged until after your order has been shipped
- ★ Orders shipped same day on all stocked products (on orders placed by 2pm EST)
- ★ All products guaranteed to be the latest versions available
- ★ Only factory sealed and fully warranted products stocked
- ★ Never a surcharge for American Express, Visa or Mastercard

• No sales tax on orders shipped outside NY State • Please add 3% for insurance, shipping and handling (\$3.00 minimum) (Some products may have a surcharge due to weight and size restrictions) • Defective merchandise can be returned for repair or exchange (please call for R.A. no.) • Due to variety of products, we cannot guarantee compatibility

DATABASE MGMT

Clipper	\$369
dBase III Plus	389
dBase III Plus Lan Pak	579
Foxbase +	235
Genifer	205
R:Base System V	339
Reflex	79

WORD PROCESSING

Display Write IV	\$309
Lotus Manuscript	319
Microsoft Word 3	247
Multimate	219
Multimate Advantage	269
Volkswriter	135
Word Perfect	195
Wordstar 2000 Plus	275
Wordstar Professional (Ver. 4)	229
XY Write III	199

LAPTOPS

Toshiba T1100 Plus	\$1,575
Zenith Z181	1,749
<i>Now available: luxurious leather carrying case for laptops only \$149</i>	

SURGE PROTECTORS

KENSINGTON MICROWAVE	
Masterpiece Plus	\$109

BACK UP POWER SUPPLIES

DATASHIELD	
200 WT (PC)	\$235
300 WT (XT)	335
500 WT (AT)	525
800 WT (AT)	545

MODEMS

HAYES	
Smartmodem 1200	\$365
Smartmodem 1200B	335
Smartmodem 2400	555
Smartmodem 2400B	499
MONEYSWORTH (Hayes Comp.)	
Money Modem 1200 (Ext)	149
Money Modem 1200B (Int)	125
Money Modem 2400 (Ext)	269
Money Modem 2400B (Int)	299

GRAPHICS

HERCULES	
Graphic Card Plus	\$185
Color Card	145
PARADISE	
Auto Switch EGA	339
Modular Graphics 3	169
QUADRAM	
EGA Plus	289
Pro Sync	345
VIDEO 7	
VEGA	295
VEGA Deluxe	329

MULTI-FUNCTION BOARDS

AST	
Six Pack + 384K	\$189
Six Pack Premium	249
Advantage 128K	325
Rampage AT W/512K	399
Rampage W/256	259
MONEYSWORTH (AST Comp.)	
Money Memory 1/2 Card (384K)	119
Money Memory 1/2 Card (576K)	145
Money-Board AT	
Multifunction (128K)	199
Money-Board Multifunction (384K)	
Money I/O Mini-Half Card	99

MONITORS

AMDEK	
12" 310A	\$145
12" 300A	119
Color 600	369
Color 722	465
NEC	
Multi-Sync	549
PRINCETON	
Amber Max-12	149
RGB HX-12	399
RGB HX-12E	480

PRINTERS

CANON	
Laser LBP8A1	\$1,825
EPSON	
FX286E	499

FX86E	379
LQ800	459
LQ1000	639

HEWLETT-PACKARD

Series II Low Price Call!

NEC

P-6	429
P-7	609

OKIDATA

182 Plug & Play	229
192 Plus	345
193 Plus	525
2410	1,749

TOSHIBA

351 P/S	999
321 P/S	449

KEYBOARDS**KEYTRONIC**

5151 Deluxe Keyboard	\$159
----------------------	-------

MOUSE INPUT DEVICES**MICROSOFT**

Mouse (Serial)	\$119
Mouse (Buss.)	105

MOUSE SYSTEMS

PC Mouse	99
----------	----

HARD DISKS**PLUS**

Hard Card 20 Mb	\$609
-----------------	-------

BACK UP STORAGE DEVICES**EVEREX**

Excel 60 Mb Int	\$719
Excel 60 Mb Ext	845

IOMEGA

Bernoulli (10 + 10)	1,829
Bernoulli (20 + 20)	2,389

Bernoulli 10 MG

Cartridge Tri-Pak	135
-------------------	-----

Bernoulli 20 MG

Cartridge Tri-Pak	215
-------------------	-----

SYSGEN

Image Tape Backup 20 Mb Ext	649
Image Tape Backup 20 Mb Int	549

All prices and policies subject to change without notice.

"The True Measure of Value"

MONEYSWORTH®

COMPUTER PRODUCTS, INC., 500 Bi-County Boulevard, Farmingdale, New York 11735

FOR ORDERS ONLY **1-800-237-9161**

Customer Service
& NY State Orders
(516) 249-8489

CP/M Emulation

Run CP/M software on your IBM-compatible personal computer. We have Z80-HD64180 co-processor cards, V20 or software emulation. At low prices from \$99.95.

New! Z80 At 12.5 MHz!

We offer the world's fastest Z80 co-processor cards. For \$599.95 our *Blue Thunder Super-speed* crunches through your work. Almost as fast is the 10-MHz *High Speed* model at \$399.95. The 6-MHz *Standard* model is \$249.95. Including software.



Blue Thunder \$249.95

RUN ISIS
Very Fast

Plug in one of our co-processors, then run your Intel development tools, on your PC, as much as 20 times faster. Run ASM51, ASM80, CREDIT, etc. \$395.00 and up for a complete package, including serial communications. ISIS diskette translate packages available.

HD64180

Hitachi's new microprocessor has taken the Z80 world by storm. Z80-compatible, but 15% faster for the same clock speed. Counter-timers, serial ports and DMA channels on chip. CMOS. Our customers have reported instances to us where the HD64180 blows away an 80186 at similar clock speeds. This baby moves!

Our \$295.00 D64180LP co-processor comes with our CP/M emulator and real-time programming support. 2-RS232 serial ports and 64K of memory. An excellent basis for a Z80-HD64180 development system. Clock speeds to 9.216 MHz available.

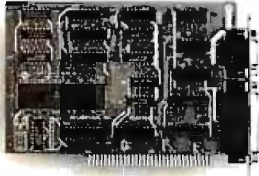

D64180LP \$295.00

For \$445.00 you can get our high powered D64180 real-time co-processor. 256K memory, expandable to 512K. 2 SBX bus connectors which allow you to use hundreds of commercially available interface modules, such as synchronous communications, disk interface, etc.

Software Developers

Let us configure a complete Z80 or HD64180 development system for your PC. Our DSD80 *Remote Debugger* eliminates the need for an ICE. We have VAX and PDP-11 co-processors too.

Z-World
2065 Martin Ave. #110
Santa Clara, CA 95050
(408) 980-1678



In Germany: iSystem Tel: 08131/1687

CIARCIA FEEDBACK

name just two. This type of utility should permit reading characters from your serial card without restrictions, although you may have to experiment to get the exact procedure that will be successful.

I've never published a project article for an Apple serial interface card, but one by Richard Campbell did appear in the April 1979 issue of BYTE ("Cross-Pollinating the Apple II"). It describes a serial interface based on the Intel 8251 PCI chip. You could construct this interface as described, or readily update it by using a 6551 or 2661 serial chip. The latter two have on-chip oscillator components and internal data rate generators; you only need a crystal and a few passive components to complete that part of the circuit. You should also use a transceiver (e.g., the 74LS245) between D0-D7 on the bus and the corresponding pins on the serial IC. You might also want to look into constructing a dual serial interface card using the newer 2681 DART.—Steve

Graphics Woes

Dear Steve:

I have an IBM PC XT clone computer with a Hercules-compatible monochrome graphics card. However, this card will not work with the medium- and high-resolution BASIC commands (e.g., LINE, CIRCLE). These BASIC commands allegedly work only with the CGA card. I would like to write some BASIC graphics routines to output to a monochrome monitor.

Hercules HBASIC only works with a true IBM (since it makes IBM ROM calls), not with a clone. Has anyone written assembler routines that would allow BASIC access to Hercules-compatible graphics?

Alternately, is it possible to output CGA graphics (medium or high resolution) to a monochrome monitor? (My monochrome monitor is TTL.) If this is possible, I wouldn't have to buy a new dual-frequency monitor.

Stephen Goldfarb
Oakland, CA

First, don't even try to adapt your TTL monochrome monitor to accept CGA output. The monochrome monitor is not compatible with the sweep frequencies of the CGA. The result would be a burned-out component in the power supply.

You can write assembly language subroutines and call them from BASIC with the CALL() statement. With interpreted BASIC, you would have to BLOAD the subroutine, or POKE it directly into memory. The IBM BASIC manual has a section on using DEBUG to set up addressing so that the subroutines can be loaded into

high memory as .EXE files.

Another method is to write BASIC programs to calculate the dot positions, use the DEF SEG command to reference the beginning of the Hercules graphics memory, and POKE values directly into memory. According to the Hercules manual, the addresses are calculated from column/row (X,Y) coordinates using a formula of the form:

$$\begin{aligned} \text{offset} = & 2000H * (Y \text{ MOD } 4) \\ & + (90 * \text{INT}(Y/4)) \\ & + \text{INT}(X/8) . \end{aligned}$$

This is the address of the byte containing the dot you want to plot. The value of the byte to POKE is determined by converting the value of $7 - X \text{ MOD } 8$ to a power of 2 (i.e., if $X \text{ MOD } 8$ is 0, the bit is the most significant bit in the byte—bit 7; if $X \text{ MOD } 8$ is 1, the bit is bit 6; and so on down to the least significant bit).

Interfacing is much easier if you compile your BASIC program with the Microsoft QuickBASIC compiler. This allows you to write the subroutines and BASIC programs as separate modules whose addresses will be resolved at link time. The QuickBASIC manual shows how to set up the subroutines so that parameters will be passed to and from the machine language subroutine correctly.

The Hercules manual contains the information you need to determine how to plot graphics points where you want them, and how to switch the controller to graphics mode.—Steve

CIRCUIT CELLAR FEEDBACK

Programming While You Wait

Dear Steve:

I am in the process of building a Z-80-based computer from scratch, using my own design. I will be using a 27C64 EPROM to execute the power-up self-tests and hexadecimal debug routine for data entry from a terminal. This will allow me to write and debug machine-coded programs for future use in other design applications. I like your EPROM programmer project in the October 1986 Circuit Cellar. However, as cost is a concern, I wonder what it costs these days to have an EPROM programmed, and where a person might go to have it done?

Allen Speer
Missoula, Montana

Most large electronic distributors will program EPROMs, PROMs, PALs, and so on, for a fee. This service is usually made available to their volume purchase

continued

FORTTRANS- MIGRATION.

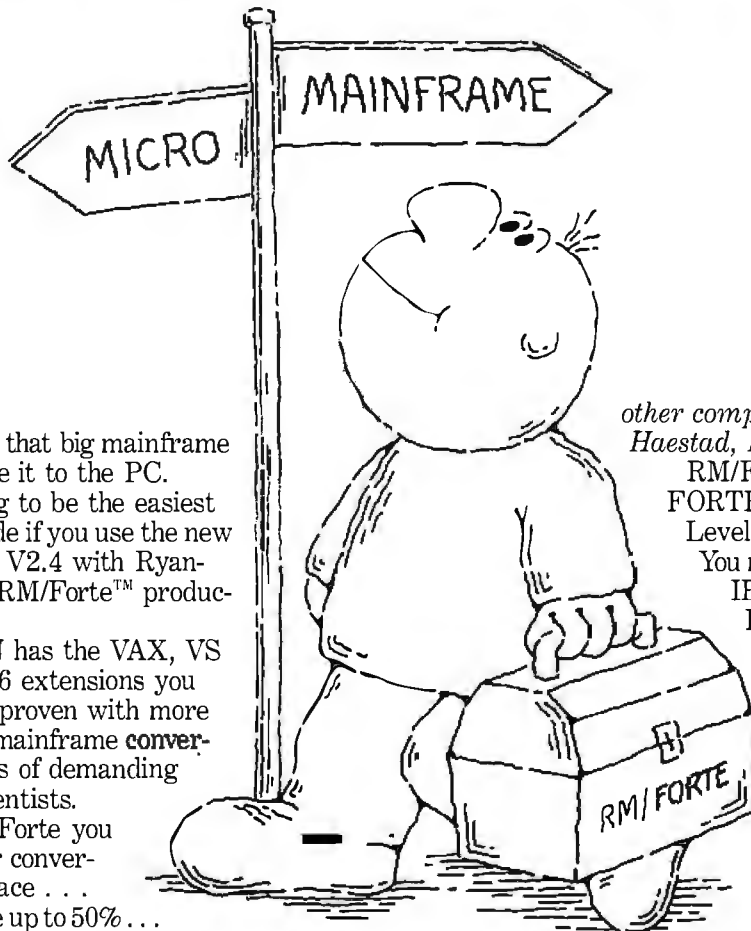

It's moving day.

Time to pack up that big mainframe program and move it to the PC.

Relax. It's going to be the easiest move you ever made if you use the new RM/FORTRAN™ V2.4 with Ryan-McFarland's new RM/Forte™ productivity tools.

RM/FORTRAN has the VAX, VS and FORTRAN-66 extensions you need, and is field-proven with more than two years of mainframe conversions by thousands of demanding engineers and scientists.

And, with RM/Forte you can complete your conversion at a record pace . . . cutting debug time up to 50% . . . diagnosing syntactical errors in 1/5 the time. You're in the fast lane because RM/Forte integrates all major program development tasks—edit, compile, link and debug—into one interactive, menu-driven environment. Just a few simple keystrokes move you from one task to another . . . and back again.

Plus, you get a full screen editor, a syntax checker and a source code manager that automates compiling and linking as you make changes.

RM/FORTRAN applications are more than just easy to develop—they run fast, too. Sieve or Whetstones, RM/FORTRAN benchmarks ahead of the bunch. And if you need it, RM/FORTRAN has a very fast 8087/80287 emulator to give you the power of a coprocessor.

But don't take our word for it. Listen to a moving professional: "RM/FORTRAN lets us move mainframe programs to PCs faster and cleaner than any

other compiler on the market." (John Haestad, Haestad Methods)

RM/FORTRAN was the first PC FORTRAN GSA certified a Full Level ANSI 77 with no errors.

You may have heard of its sister, IBM PC Professional FORTRAN by Ryan-McFarland Corporation.

Enough reading. Start writing. Fill out and send in the coupon below to find out more about RM/FORTRAN with the new RM/Forte productivity tools. Then move it!

Ryan-McFarland
609 Deep Valley Drive
Rolling Hills Estates, CA 90274
Or call 213/541-4828

RYAN-McFARLAND



Let's get moving. Send me details on RM/FORTRAN V2.4 with RM/Forte Productivity Tools, and your special upgrade offer.

B-6

Name

Company Title

Street

City State Zip

Phone ()

HARMONY COMPUTERS

2357 CONEY ISLAND AVE., (BET. AVES. T & U) BKLYN, NY 11223
800-VIDEO84 or 800-441-1144 or 718-627-1000



Commodore 1571-\$206.95
STAR NX-10-\$199.95

PANASONIC 1080 i-\$184.95
IBM PC XT-\$869.00

"PRINTER SPECIALS"

Apple Image Writer II 449	Epson FX 286E 429	Okidata 193 Plus 489	Star NX15 319
Brother HR 20 324	Epson EX800 369	Okidata 292 w INTFC 499	Star ND 10 319
Brother 1509 359	Epson EX 1000 490	Okidata 293 w INTFC 646	Star ND 15 399
Citizen 120D 169	Epson LQ2500 869	Panasonic KXP 1051 195	Star NB 2410 449
Citizen MSP 10 269	IBM Proprinter 379	Panasonic KXP 1091 239	Star NB 2415 664
Citizen MSP 15 369	IBM Proprinter XL 519	Panasonic KXP 1092 312	SR 15, SR 10 Sheetfeed 49
Citizen MSP 20 319	NEC 3550 719	Panasonic KXP 3131 238	Star Power Type 179
Citizen Premier 35 439	NEC 8850 1039	Panasonic KXP 3151 369	Star NB 15 685
Epson L800 158	NEC P6 427	Panasonic KXP 1592 379	Silver Reed Exp 420 199
Epson L805 178	NEC P7 549	Panasonic KXP 1595 459	Silver Reed Exp 600 629
LX 86 Cutsheet 24	NEC Color P6 529	Siekosha SP 1000 179	Toshiba 341 E 659
Epson LQ800 429	NEC Color P7 699	Siekosha SP 1200 189	Toshiba 351 Model 2 869
Epson LO 1000 617	Okidata 182 228	Star NX-10 200	Toshiba 351C 1039
Epson FX 86E 308	Okidata 192 Plus 319	Star NP 10 159	Toshiba 321 SL 489

AT Unenhanced 2195	IBM PC XT(1) Dr 869	IBM PC XT286 6MHz, 640K 2449	IBM Monitor 219	IBM DscDrive 104	AST'S Pack 384K 179	AST Advantage 128K 327	AST'S Pack Premium 256 K 180	Hercules Color Card 138	Hercules Monographic Plus 174	NEC EG4GB 299	Quad EGA+ 268	Quad Prosync 319	Video 7 EGA+ 275	Video 7 Deluxe 359	Paradise Auto Switch (350) 289	Paradise Auto Switch (480) 359	Multifunction Card 109	Everex EGA Enhancer 189	Everex Edge 209	Everex Graphics Pacer 189	Intel 8087-2 109	Intel 80287-5 169	Intel 80287-8 269
AT Enhanced IBM30Meg (339) 3440	IBM PC XT(1) Dr 869	IBM PC XT286 6MHz, 640K 2449	IBM Monitor 219	IBM DscDrive 104	AST'S Pack 384K 179	AST Advantage 128K 327	AST'S Pack Premium 256 K 180	Hercules Color Card 138	Hercules Monographic Plus 174	NEC EG4GB 299	Quad EGA+ 268	Quad Prosync 319	Video 7 EGA+ 275	Video 7 Deluxe 359	Paradise Auto Switch (350) 289	Paradise Auto Switch (480) 359	Multifunction Card 109	Everex EGA Enhancer 189	Everex Edge 209	Everex Graphics Pacer 189	Intel 8087-2 109	Intel 80287-5 169	Intel 80287-8 269

Hard Drives 269	20 Meg w controller 329	20 Meg w controller 349	30 Meg w controller 389	30 Meg AT #403B 549	40 Meg AT #251 599	Tandem 20 Meg Hard Card 409	
SEAGATE	Hard Drives 269	20 Meg w controller 329	20 Meg w controller 349	30 Meg w controller 389	30 Meg AT #403B 549	40 Meg AT #251 599	Tandem 20 Meg Hard Card 409

Amdek 300 Amber 110	Amdek 310 A 129	Amdek 410 A 149	Amdek Co or 500 369	Amdek Co or 722 434	Princeton HX12 334	Princeton HX12E 459	Princeton Max 12E 148	SR12 529	Scan Doub er 159	NEC Multisync 527	Taxan TTL Amber 105	
MONITORS	Amdek 300 Amber 110	Amdek 310 A 129	Amdek 410 A 149	Amdek Co or 500 369	Amdek Co or 722 434	Princeton HX12 334	Princeton HX12E 459	Princeton Max 12E 148	SR12 529	Scan Doub er 159	NEC Multisync 527	Taxan TTL Amber 105

130XE 128	65XE 69	Atar 800 Printer 179	Atar 804 Printer 179	1050C+re 128	AtarWrite+ 37	Atar 1027 109	Atar Model 301 49	520 ST Color System 719	520 ST B & W System 479	
ATARI	130XE 128	65XE 69	Atar 800 Printer 179	Atar 804 Printer 179	1050C+re 128	AtarWrite+ 37	Atar 1027 109	Atar Model 301 49	520 ST Color System 719	520 ST B & W System 479

Lotus 123 Ver 2 299	D Base 3+ 375	Framework 2 301	Symphony 1.2 499	Microsoft Word 3.1 254	Microsoft Windows 03 59	Word Perfect 4.2 196	Q & A 2.0 199	PS Professional Write 109	Norton Utilities 4.0 49	Microsoft Mouse 109	Hayes Smartcom II 69	WordPerfect Library 69	Wordstar Professional 229	Multimate Advantage II 289	Bankstreet Writerplus 69	OAC Easy Accounting 49	
SOFTWARE	Lotus 123 Ver 2 299	D Base 3+ 375	Framework 2 301	Symphony 1.2 499	Microsoft Word 3.1 254	Microsoft Windows 03 59	Word Perfect 4.2 196	Q & A 2.0 199	PS Professional Write 109	Norton Utilities 4.0 49	Microsoft Mouse 109	Hayes Smartcom II 69	WordPerfect Library 69	Wordstar Professional 229	Multimate Advantage II 289	Bankstreet Writerplus 69	OAC Easy Accounting 49

Commodore 128 239	1571 Drive 207	1670 Modem 119	Commodore 64C 145	1541C Disk Drive X 158	1802 189	1902A Monitor 249	MSP 1200 Printer 199	Star SG10C 169	Siekosha 180 VC 147	Amiga 256K Dos, Mouse 649	Amiga 1080 Color Monitor 309	Amiga 256K Upgrade 139	
COMMODORE	Commodore 128 239	1571 Drive 207	1670 Modem 119	Commodore 64C 145	1541C Disk Drive X 158	1802 189	1902A Monitor 249	MSP 1200 Printer 199	Star SG10C 169	Siekosha 180 VC 147	Amiga 256K Dos, Mouse 649	Amiga 1080 Color Monitor 309	Amiga 256K Upgrade 139

Hayes 1200 354	Hayes 1200B w Smartcom 328	Hayes 300 124	Hayes 2400 559	Hayes 2400B w Smartcom 2 499	Modem 2E 125	Prometheus 1200 External 248	Prometheus 1200 Internal 148	Everex Modem Internal 1200B 108	Everex 2400 Internal 219	Hayes Smartcom 2 69	
MODEMS	Hayes 1200 354	Hayes 1200B w Smartcom 328	Hayes 300 124	Hayes 2400 559	Hayes 2400B w Smartcom 2 499	Modem 2E 125	Prometheus 1200 External 248	Prometheus 1200 Internal 148	Everex Modem Internal 1200B 108	Everex 2400 Internal 219	Hayes Smartcom 2 69

Items reflect 4% cash check discount. For your protection we check for stolen credit cards. M.C./Visa welcome. Shipping & Handling charge extra. Defective merchandise will be replaced at our discretion within the terms of our warranty. All Sales Final. Price and availability subject to change without notice. We cannot guarantee compatibility.

PERMA POWER FIGHTS SURGES TWO WAYS...

OR WE PULL THE PLUG

Perma Power Surge Suppressors give you peace of mind, knowing that your computer is protected against power line surges and against suppression element failure.

PROTECTION FROM POWER LINE SURGES

Our unique 2-stage circuit uses heavy-duty metal oxide varistors to protect you against high-voltage lightning-induced surges, and high-speed semiconductor devices to protect against frequent fast surges. Only this kind of hybrid circuit can provide the necessary high power dissipation while still providing fast response time and low let-through voltage.

PROTECTION EVEN IF WORN OR BURNED OUT

Any surge suppressor can wear or burn out. With Perma Power you can relax! Power to your system is stopped... as completely as if the plug was disconnected. Other surge suppressors may use a light or buzzer "warning," while they continue to let raw, unprotected power feed directly into the computer. Only with Perma Power's patented Automatic Shutdown* feature is your equipment kept safe from damaging raw power.

Ask for Perma Power Extended Life Surge Suppressors, in 2, 4, or 6 outlets and Power Control Center models to insure your computer is being protected. At office, computer or electronics dealers nationwide.



*Patent #4,578,579

PERMA POWER
Electronics Inc.

5601 West Howard Avenue • Chicago, Illinois 60648
Telephone (312) 647-9414

Inquiry 232 for End-Users.
Inquiry 233 for DEALERS ONLY.

CIARCIA FEEDBACK

customers. Most of the distributors I have a working relationship with let me use their programming equipment when I need a PROM, PAL, or some other device programmed that my programmer doesn't support.

If you are programming devices as part of a hobby, you probably won't get this type of service from a distributor. However, you might at least ask. Programming fees range from around \$0.50 to \$5, depending on the device and the way you supply programming information.

If you can't find a distributor in your area that is willing to program your devices, try a local college with an engineering department or seek out a computer club.

You will find that not having access to a programmer and eraser on your bench is a bother. If you develop code, run to a distributor for programming, wait for the turnaround, and find that your code has a bug in it so you have to repeat the whole process, you'll discover that a programmer is worth more than the money you save having someone else program the device.—Steve

Musical Floppies

Dear Steve:

I was recently going through some old magazines when I came across a small, one-page article about a digital audio recorder that uses floppy disks as a recording medium. Do you think this would be a candidate for a future Circuit Cellar project? I can envision a similar recording device based on the SB180, using a 3 1/2-inch disk drive for storage with an RS-232C port for interaction with a home computer. I own a compact disk player and I think that a digital recorder would be an ideal enhancement to my home audio system.

Todd R. McMahon
Zurich, Switzerland

Thanks for your suggestion for a Circuit Cellar project. OKI Semiconductor in Sunnyvale, California, has recently announced the MSM6258 speech-processor chip, which may allow construction of the device you mentioned. The chip can be configured into a solid-state audio recorder and can use static or dynamic RAM, ROM, or EPROM for storage. I am reviewing this chip, and if feasible I will include it in a future article.

Another approach is a new digital audio tape-recording system (called DAT for short) that will soon be introduced to the consumer market. It uses a rotating head, just like a videotape recorder, with a (roughly) 1/4-inch tape in a cassette similar in size to conventional analog audio-

continued

WHO YA GONNA CALL? BUGBUSTERS!

This is how PROBE displays real-time trace data. Trace information includes C source code, assembly language and data which was read or written during instruction execution. PROBE software simplifies the display by tossing out prefetched but unexecuted instructions.



PROBE knows all about your local and complex variables. You can display and change an array of structures as easily as shown in this display.

PROBE's menu window means you do not have to look up debug commands in the manual. Entering the command name shows you command syntax.

"Real-time source-level debugging of very large programs simply can't be done without Atron's AT PROBE." Ed Oates, Director of PC Software Development, Oracle Corporation

The good news with your new Microsoft 4.0 or Lattice* C compilers is that they're providing more symbolic debugging information than ever. The bad news is you can't fit your program, a software debugger and that monster symbol table into memory - at least at the same time.

The great news is that Atron's AT PROBE™ hardware-assisted software debugger not only has 1-MByte of onboard memory for debugger and symbol table, but it now supports local variables and complex data types.

The AT PROBE is a debugging tool that plugs into your PC AT and monitors everything the processor is doing. In real time.

REAL TIME DEBUGGING. SOONER OR LATER, YOU KNOW YOU'LL NEED IT.

The AT PROBE's hardware-assisted breakpoints trap on reading, writing, executing, inputting and outputting. On single or ranges of addresses, including particular variable values. All in real time. For a mere software debugger to attempt this, a 1 minute program would take 5 hours to execute.

OPTIMIZED CODE - GOOD, BAD AND UGLY

The good news is optimizing compilers generate very tight code. The bad news. The time to debug optimized code is inversely proportional to the quality of the optimizer. Figuring out how in the world you ended up somewhere gets ugly, fast.

With AT PROBE's real-time trace capability, program execution history is saved on-board, in real time. Once a hardware trap has occurred, PROBE displays the program execution in detail, including symbols and source code. Real-time trace can show you how out-of-range pointers got that way. And there's really no other way to debug interrupt-driven code.

AT PROBE OPTIMIZES THE OPTIMIZED

When the job of bugbusting is done, your AT PROBE becomes a performance analyzer. So you can have both reliability and performance. So you can send only the best software into the field.

CALL TODAY FOR YOUR FREE BUGBUSTING MANUAL

Nine of the top ten software packages were debugged using Atron tools. Our complete tutorial on state-of-the-art bugbusting is yours, free. Full of examples and illustrations, it will show you how to become a bugbuster yourself.

Call today. Bust bugs tomorrow.



BUGBUSTERS

A division of Northwest Instrument Systems, Inc.
20665 Fourth Street • Saratoga, CA 95070
408/741-5900
Inquiry 28

SUNDA 10-5 **ATARI PRINCE** **PROMPT DELIVERY**

COMPUTERS	LAP TOP COMP.	PRINTERS
APPLE Macintosh Plus CALL Macintosh SE 2899.99	NEC Multi Speed Sharp PC-7000 T-1100 Plus 640K Toshiba T-3100 Zenith Z-181	HR15-XL HR-20 Dual Twinwriter 5 M-1109 M-1409 M-1509 M-1709 * w/ purch of T.F. or C.F.
ATARI 1040 w/ Color Moni. 829.99	LASER JET PTR.	EPSON
COMMODORE Amiga 512K w/ 1080 Col. Mtr. 999.99	HP Laser Jet Series II 1699.99 HP Laser Plus-500 Epson OVC-3500	EX-800 EX-1000 FX-86e FX-286e LQ-300 LQ-1000 LQ-2500 LX-86
COMPAQ 386 40 MB, 1 1/2 Floppy 1 MB RAM 4699.99	MODEMS	PANASONIC
EPSON EQUITY I 256K RAM, 1 Floppy CALL	Hayes 300 Hayes 1200-B Hayes 2400 Hayes 2400-B U.S. Robotics 1200-B 2400-B	KXP-1081-I KXP-1091-I KXP-1092-I KXP-1592 KXP-1595 KXP-3131 KXP-3151
EPSON EQUITY II 640K RAM, 1-350K Drive CALL	EGA CARDS	
IBM XT 256K RAM 2-360K Floppies IBM Mono Monitor IBM Graphic Card 1149.99	NEC GB-1 Paradise Auto Plus Quad EGA Pro Sync Video 7 Deluxe	
IBM AT-339 512K RAM, 30 MB 3299.99	SPERRY	
	PC-IT 40 Meg Micro IT	

GUARANTEED LOWEST PRICES
COMPUTER: 1-800-874-1235
VIDEO: 1-800-223-6779
COMPUTER: 1-800-223-6779

TOLL FREE OUT OF N.Y.
IN N.Y. CALL (718) 237-2828

S'nW ELECTRONICS & APPLIANCES
 633 Bedford Ave. Bklyn, NY 11211

HOURS: Mon-Thurs 9-6
 Fri 9-2, Sun 10-5, Sat Closed

COD Accepted
 * Credit Card accounts charged in full
 * Add charge, bank, and
 * city limited * Please refer to
 * change * not responsible for
 * typographical errors

tape. Given the economy of scale of consumer hi-fi equipment (look at how compact disk machines have fallen in price since their introduction), I think that I would rather wait until this technology is established.

There could be quite a number of interesting applications built around a commercial DAT machine, at far lower cost than using conventional data storage devices such as disk drives. —Steve

Reusable Computers

Dear Steve:

I believe that at one time you were the owner of a Digital Group computer, as I was. You'll remember that if you wanted to change processors all you had to do was unplug the processor board and plug in another. All the other boards in the system recognized the same signals on the same pins, so that, in principle, no matter what innovations came out all you had to do was change a single board.

Isn't this idea still viable? What makes me remember the Digital Group machine with nostalgia are all these new chips that sound so interesting but that I will never be able to afford—the 80286, 80386, 32032, the 68020, not to mention all the new graphics chips. It seems that if I want to indulge my hobby to the utmost, every two years I will have to throw away whatever machine I currently own and buy another. Don't you think it would be a good idea if you were to design a Digital Group-like machine that would keep me (and thousands like me) abreast of the latest advances in hardware?

M. Kreiger
 Brooklyn, NY

The concept of bus architecture is alive and well. The IEEE-696 standard, better known as the S-100 bus, offers the possibilities you desire. Although some may think that the S-100 bus is more of a relic than new technology, there are 8088-, 6800-, 6500-, and 68000-based processors available in S-100 boards that support peripherals as defined by the IEEE-696 standard.

Unfortunately, the S-100 bus machines have become the domain of the small-business user, losing hobbyists and home users to the much simpler and ready-made technology of the IBM PC, Commodore, and Atari machines. Perhaps coverage of S-100 projects warrants consideration—it is the base upon which BYTE was built. —Steve

An SB180 in a Kaypro?

Dear Steve:

I have watched the development of your SB180 8-bit computer system with

continued

UTAH COBOL

Utah COBOL™ \$39.95

For IBM® PC's, XT's, AT's and other DOS machines. This is the one you've heard so much about — with faster compile times than many COBOL compilers costing hundreds of dollars more! It's based upon ANSI-74 standards. Now comes standard with source code programs demonstrating full screen, cursor control, color, reverse video, etc., another program shows how to even reprogram your keyboard and much more.

Don't let our mail order prices fool ya! This is a new improved version of our best selling COBOL compiler previously offered at \$300.00 a copy. Look at the December 1979 issue of Byte Magazine for one of our first COBOL ads!

Other outstanding values at \$39.95 are: Utah FORTRAN, Utah BASIC, Utah PASCAL, Utah PILOT and Utah EDIT. Used by 50,000 professionals, students, and teachers in 40 countries.

To order:
 (702) 827-3030

ELLIS COMPUTING™
 SINCE 1977

IBM is a registered trademark of International Business Machines.

Ellis Computing, Inc. • 5855 Piquette Court, South Hill • Menlo Park, CA 94025

THE NO FRILLS PLOTTER

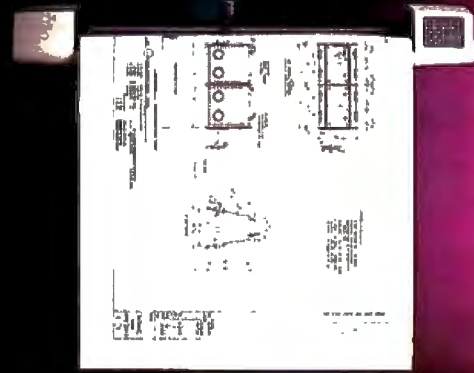

Enter the world of professional CAD applications with Houston Instrument's low cost DMP-41/42 series plotters. These single-pen plotters give you the features you need—C and D size plots, extensive software compatibility, and proven reliability—for a very affordable no frills price of \$3295.*

The DMP-41/42 series' large C and D size formats are ideal for a wide range of CAD applications, from architectural elevations to assembly drawings. And a .005 inch resolution ensures crisp drawings on a variety of media—paper, matte film, or vellum.

Inquiry 132

With the DMP-41/42 series, you can choose from an impressive selection of off-the-shelf graphics software packages such as VersaCAD, AutoCAD, and CADKEY. Or, by using Houston Instrument's popular DM/PL™ language, you can create your own custom software and be assured of upward compatibility with Houston Instrument's entire line of plotters.

The DMP-41/42 series. The plotters that offer superb reliability, comprehensive graphics capabilities, and a no frills price. The proven performers for low-cost CAD.

For more information, call

1-800-531-5205 (512-835-0900 if in Texas), or write Houston Instrument,™ 8500 Cameron Road, Austin, Texas 78753. In Europe, contact Houston Instrument, Belgium NV., Rochesterlaan 6, 8240 Gistel, Belgium. Tel.: 32-(0)59-277445. Tlx.: 846-81399.

houston instrument **AMETEK**
DIVISION

*U.S. suggested retail price. Pricing subject to change. DM/PL and Houston Instrument are trademarks of AMETEK, Inc.



UNITE™ Bridges The Operating Systems Gap.



If you create applications in PC or MS-DOS and/or UNIX, you know the frustration in not being able to integrate, much less communicate, between these dominant operating systems.

Now you can bridge the operating systems gap with CYB Systems' UNITE. UNITE's unique connective power lets you develop and use software with total compatibility and flexibility between MS-DOS, PC DOS and/or UNIX operating environments.

With UNITE, you can boost your productivity and end the isolation of PC stations, departments and work groups by moving data between disparate operating systems and machines. Single function keystrokes enable you to process work on a PC, suspend operations and transfer files locally or to remote stations, access 3270 mode, or act as a UNIX terminal with all utilities. UNITE also provides an on-board upward link to popular mainframes via TCP/IP or SNA protocols. And with UNITE you can add greater interconnective capabilities for true departmental processing further up the road.

UNITE. The bridge to fast, affordable program development today—and tomorrow. For more information, call or write CYB Systems, or visit our suite at the Dallas INFOMART.



CYB SYSTEMS, INC.
INFOMART, Suite 2017
1950 Stemmons Freeway
Dallas, Texas 75207
214/746-5390

UNITE is a trademark of CYB Systems, Inc. MS-DOS is a trademark of Microsoft Corporation.
UNIX is a trademark of Bell Laboratories.

interest, particularly inasmuch as I own three 8-bit Kaypro computers and plan to keep them for some time. Since there are tens of thousands of Kaypro 2s, 4s, and 10s out there, have you considered making available a "plug-compatible" SB180 for these machines?

There wouldn't have been much of an advantage in doing so when the SB180 was running at 6 MHz, but at 9 MHz such a replacement would benefit many.

I would imagine that the changes to the SB180 and associated software would be rather minimal: such changes as allowing the use of the Kaypro CRT as is, perhaps software changes to make Kaypro the standard floppy format, and (for the Model 10), changes to allow the use of the extant hard disk controller and hard disk. The operating software might also require a few modifications so that standard Kaypro software (which expects an ADM 3A monitor) would run as expected.

What do you think?

Norman Buchignani
Department of Anthropology
The University of Lethbridge
Lethbridge, Alberta, Canada

I currently have no plans to build a "plug-compatible" version of the SB180 that could be installed in the Kaypro 8-bit machines.

The SB180 can easily be used with an existing Kaypro by using an appropriate terminal program, such as the public domain MEX, running on the Kaypro to make it into a terminal for the SB180. The SB180 distribution software allows you to specify any of a number of terminals to be used with the SB180. This method would not be exactly what you requested, but would provide the SB180 advantages at moderate cost while retaining all of your present Kaypro features. The SB180 can read and write Kaypro II format disks.
—Steve ■

Between Circuit Cellar Feedback, personal questions, and Ask BYTE, I receive hundreds of letters each month. As you might have noticed, at the end of Ask BYTE I have listed my own paid staff. We answer many more letters than you see published, and it often takes a lot of research.

If you would like to share the knowledge you have on microcomputer hardware with other BYTE readers, joining the Circuit Cellar/Ask BYTE staff would give you the opportunity. We're looking for additional researchers to answer letters and gather Circuit Cellar project material.

If you're interested, let us hear from you. Send a short letter describing your areas of interest and qualifications to Steve Garcia, P. O. Box 582, Glastonbury, CT 06033.

In 1981, we introduced
the world's most successful
personal computer.

Here we go again.

Five years ago, we sent our first personal computer out the door and hoped you'd find it useful.

We're pleased you did.

Over three million IBM® PCs have been put to work, doing everything from financial analysis to first-grade arithmetic.

Yet as PCs grew more popular, and as we kept improving them, one thing became clear. You needed more.

You're in a hurry, so you want PCs

You want improved reliability. And you want all this without obsoleting your investment in equipment, software and training.

So there was only one thing we could do: create a whole new system for personal computing.

The new IBM Personal System/2™. Its heart is a new line of hardware and software, but its soul is bigger; new technology, of course, but also a new "balanced system" approach for

IBM Proprinter II

IBM Proprinter X24

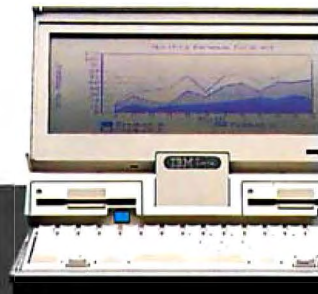

Programs are here for the IBM Personal System/2.

to respond faster.

You do many things at once and wish your PCs could too.

You want software that's more powerful, but also easier to use.

You'd like more color.

You're eager for your systems to communicate with other systems.



IBM PC Convertible

making things work together.

It works with earlier IBM PCs so your investment is protected. It works with larger IBM systems so your future growth is protected. It works for business and education, for professional people of every stripe.

The next generation in

The new systems.

There are four models of the new IBM Personal System/2: Models 30, 50, 60 and 80, with a choice of configurations, with new design and components, and built not merely for speed but for well-balanced performance.

cessor, is an even bigger step forward. It has new architecture (as do the even more powerful models) that breaks old barriers. One megabyte of memory is now standard, and there's plenty of room for more. Its graphics (again, in common with the larger models) are



IBM Personal System/2 Model 30

Model 30 is about 25% smaller than the IBM PC, does many jobs more than two times faster than the IBM PC XT,[™] and comes with 640KB of memory and a 20-megabyte (MB) fixed disk if you want one. Much of what used to be optional is now standard, and improved. Graphics are spectacular. So is the value. *Model 30* offers exceptional performance for the money.

Model 50, with its 80286 micropro-



IBM Personal System/2 Model 50

cessor, is an even bigger step forward. And it finishes many jobs significantly faster than the IBM Personal Computer AT.[®]

Model 60 takes up less space on your desk because the computer itself doesn't sit on your desk, but rather, beneath or beside it. Equipped with a 44 or 70MB fixed disk, up to 15MB of memory and expanded expandability, it's a system for serving a very busy person, and can be a file server for

personal computing.

other busy persons.

Model 80. For everyone who's been waiting to experience the real power of the 80386 microprocessor, it's not just *in* this computer, we built this computer around it. Available this summer, Model 80 is a 32-bit system that does jobs up to

The rest of this booklet tells more about the IBM Personal System/2. And how, all together, it can help make your professional life easier, more productive, and more rewarding.

The new performance.
You'll find new architecture, new



IBM Personal System/2 Model 60

three and a half times faster than the IBM Personal Computer AT. Up to 2MB of memory are standard, and fixed disks can be 44, 70 or 115 megabytes big. Or with two fixed disks, 230 megabytes huge. Computers this capable, and connectible, used to fill whole rooms.

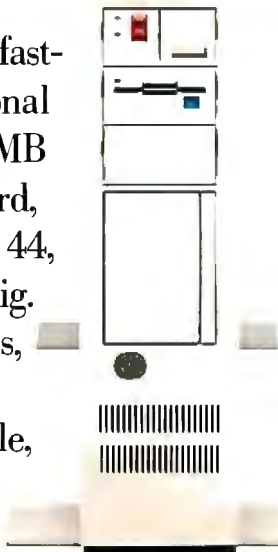

IBM Personal System/2 Model 80

integrated design and new operating systems that together lift raw power to higher levels of true performance, while cost goes the other way.

The new graphics.

You'll see new graphics, all standard, that redefine the words

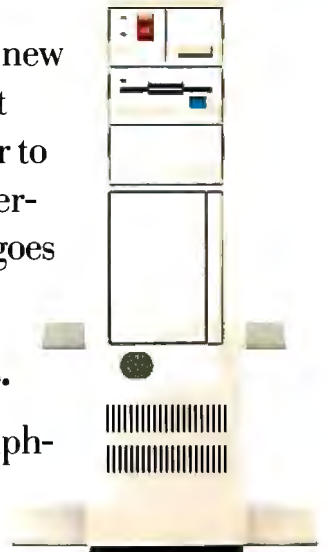

“colorful” and “sharp.” And new displays that give your programs a heightened sense of reality.

The new connectivity.

There will be new avenues for sharing information; new match-ups of hardware and software that shorten the distances and widen the roads between PCs, minis, mainframes and people.

The new media.

You'll see rugged diskettes that are

The IBM Personal System/2 is designed for connecting with larger computers like the IBM System/36 and the IBM 9370.



The new printers.

You'll see an expanded family of



IBM Proprinter XL24

half as big, but hold up to twice as much as floppies did. Plus low-cost devices for transporting your data from one generation into the next. And a new IBM 200MB optical disk drive.

The new solutions.

You'll discover new ways to solve problems; ideas about choosing not just software or hardware, but software, hardware and support in balance.



IBM Quietwriter III Printer

personal printers that fills just about any need, from economy, to speed, to the fussiest levels of document quality.

The new support.

And because it's not just what you buy but where you buy it, you'll learn how we've been working closely with the people who sell the Personal System/2 to create new levels of dealer support.

Introducing the IBM Personal System/2





IBM
Personal System/2
Model 8514
© 1992 International Business Machines Corporation
Made in the United States of America

IBM
Personal System/2
Model 8514
© 1992 International Business Machines Corporation
Made in the United States of America

IBM
Personal System/2
Model 8514
© 1992 International Business Machines Corporation
Made in the United States of America

IBM
Personal System/2
Model 8514
© 1992 International Business Machines Corporation
Made in the United States of America

IBM
Personal System/2
Model 8514
© 1992 International Business Machines Corporation
Made in the United States of America

IBM
Personal System/2
Model 8514
© 1992 International Business Machines Corporation
Made in the United States of America

IBM
Personal System/2
Model 8514
© 1992 International Business Machines Corporation
Made in the United States of America

IBM
Personal System/2
Model 8514
© 1992 International Business Machines Corporation
Made in the United States of America

IBM
Personal System/2
Model 8514
© 1992 International Business Machines Corporation
Made in the United States of America

So, it's power you want

The new performance.

It's tempting to size up computers by the numbers, but in the IBM Personal System/2, real performance exceeds the sum of its parts.

Components were designed not just to coexist, but to cooperate; within each system, and within your total computing environment.

So your software runs faster, and your system is more reliable.

Extras aren't extra.

You could expand earlier IBM PCs after you bought them, but the Personal System/2 is expanded before you even open the carton. Things that used to cost extra don't anymore.

Advanced graphics, parallel and serial ports, a port for pointing devices, and diagnostics are included.

And new IBM technology—our one-million-bit memory chip, high-density logic circuits, and integrated “planar boards”—is sending performance up, and costs down.

Paths to the future.

Models 50, 60 and 80 share a design that's new to personal computing. Technically it's described as parallel bus architecture (we call it IBM Micro Channel™), but think of it as a highway.

Our first PCs were built around a two-lane street. Usually that's enough, but sometimes there are traffic jams. Your sales figures might have to stand on the corner while your mailing list goes by.

The new system is like an expressway. There are more lanes open



The IBM Personal System/2 takes up less space on your desk. The on/off switch is on the front, and monitors tilt and swivel.

t?

The ramps are more smoothly paved, and signals are better synchronized. So data can flow more freely.

This is what the 286 and 386 chips have been waiting for. A highway to match their horsepower.

The new operating systems.

The Personal System/2 is being introduced with a new IBM PC DOS Version 3.3 that lets you tap into the new systems immediately, and works with all previous IBM PCs as well.

There's also an IBM 3270 Workstation Program that, with PC DOS Version 3.3, helps the Personal System/2 connect with

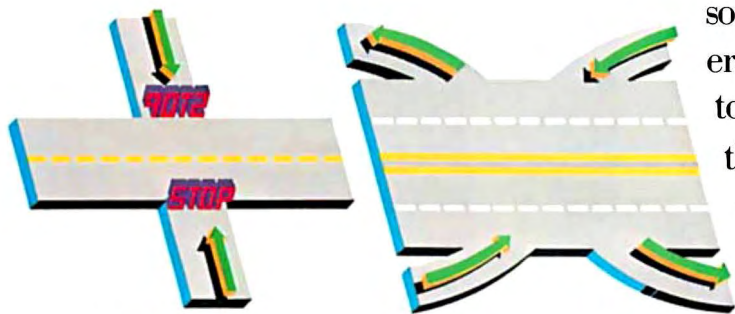

In earlier PCs, data sometimes had to stop and wait. New IBM Micro Channel architecture is more like an expressway. Data flows more freely.

mainframes, supports more memory, and lets you run multiple applications.

But much more is coming.

A new IBM Operating System/2™ will run on Models 50, 60 and 80. Available later on, its development is

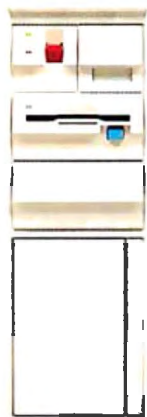

The IBM Personal System/2 Model 80 was created to unleash the power of the 80386 microprocessor.

involved—software makers, our dealers, you—can take full advantage of its power as easily as possible. It will do everything our existing PC DOS does (in fact, they'll get along beautifully), but it also will bring major advances.

Memory. Our new systems offer up to 16 megabytes' worth, and Operating System/2 will make these vast resources easier to access.

Multi-tasking. With IBM Operating System/2, you won't have to be a "power user" to understand how to run several programs at once. Multi-tasking will become a routine experience.

Software. Together with the new architecture and more memory, Operating System/2 will give software developers new freedom to create programs that are more powerful, better looking, and easier to use than ever before.

A bigger idea. Operating System/2 is also part of another new idea, called IBM SystemsApplication Architecture.

Its goal is to bring the world of IBM computing closer together; to provide a greater consistency in look, function and feel—for systems, for software and for people who use them. IBM Operating System/2 is the first step for personal computing in this promising new direction.

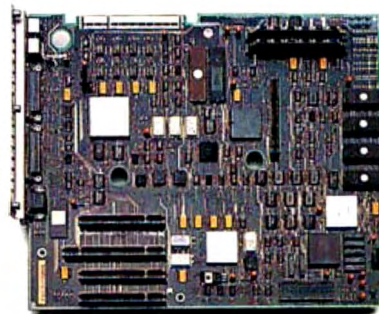

IBM Personal System/2 "planar boards" have many standard features that used to be options.

It's like having 256,000 in one box.

The new graphics.

Back in the dark ages of personal computing, the world was ruled by numbers and words. Graphics were a nicety, but rarely a necessity.

Welcome to the Renaissance.

The IBM Personal System/2 has a talent for graphics that's dazzling.

Each new system can paint up to 256 colors on the screen at once, drawing from an incredible palette of over 256,000.

And not one of those colors costs a penny extra.

Even in monochrome, things aren't monotonous. There can be up to 64 shades of gray for new dimension and contrast.

And the images themselves are greatly improved. The tiny "pixels"

that create the image can now be tinier, and there can be lots more of them. Even the space between them seems to have disappeared. So pictures are



The IBM Personal System/2 Monochrome Displays 8503.

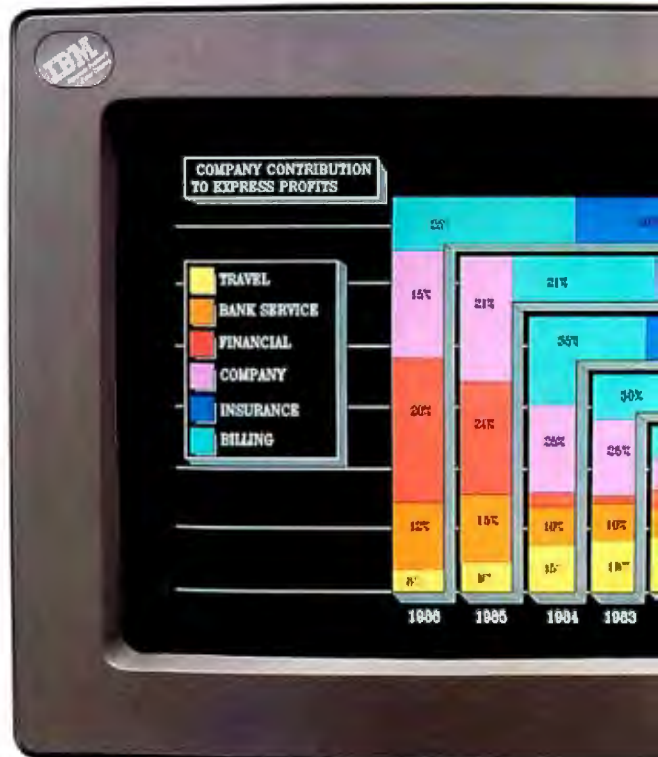

0 crayons

sharp and clearly defined.

Better letters.

Equally important, letters and numbers are clean-edged and precise,



The IBM Personal System/2 Color Displays 8512.



The IBM Personal System/2 Color Displays 8513.

looking more like they're printed than projected. After a few hours with your trusty spreadsheet, you'll appreciate that.

You'll also like the non-glare viewing surface, and

mountings that tilt and swivel so your neck doesn't have to.

There are four new IBM displays, and each works with every Personal System/2 computer, all showing graphic improvements in price.

The 12" monochrome and 14" color displays are great for most general-purpose work. The 12" color display is even sharper, ideal for detailed business graphics. And for design work, there's

the big 16" color display with even higher resolving power.

Your favorite programs.

Just about any program you can run on the IBM Personal System/2 will look better, and will likely be more pleasant to spend time with. Many other programs are being

reworked just to take advantage of the new graphics.

But the future holds real surprises. The screens of the Personal System/2 are like a brand new kind of canvas. How the artists will use them should be something to see.



The IBM Personal System/2 Model 50 and the IBM Personal System/2 Color Display 8514.

The future belongs to well-connected.

The new connectivity.

The earliest computers were big and costly, so people shared them.

Then people wanted smaller computers just for themselves. Soon PCs were in offices everywhere. And how did people want to use them?



The managing director uses IBM 3270 Emulation and Professional Office System™ software (PROFS) for checking calendars and sending electronic mail.

For sharing things. So the idea of PC connectivity was born.

From the start, the IBM Personal System/2 was designed to connect; with other IBM personal systems, with bigger IBM systems.

Each new system comes with built-in asynchronous communications (which can save you an option slot for other uses).



An executive assistant uses IBM DisplayWrite 4 to polish up memos and reports for distribution through IBM DISOSS.

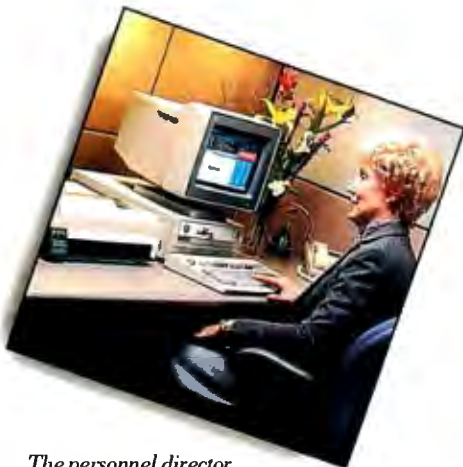

The personnel director sends bulletins using the IBM 3270 Workstation Program and PROFS.



An inventory clerk uses an inquiry to a data base to compare what's out in the warehouse with sales orders.

the

So information has no trouble traveling back and forth. But the real news is what happens inside.

Going with the flow.

The new architecture in Models 50, 60 and 80 will improve the flow of traffic within the system, so when an important message comes in from

corporate headquarters, it's less likely to see stop signs. And if the sender has a properly equipped IBM PC, PC XT, Personal Computer AT or IBM Personal System/2 Model 30,

System/2 Model 30,

that's okay too—they work together.

And as the new IBM Operating System/2 unfolds, communication will become even easier. Its multi-tasking capability will make it easier for your system to receive and store electronic mail, main-frame data, or whatever, while you're busy doing something else.

The scope of communication has been increased, too.

A wide array of local area network and connectivity products is part of the IBM Personal System/2 family, so your resources can be as broad as your needs; from the first IBM PC your company ever bought, to mid-range systems, to the biggest IBM 3090 mainframe, the lines are open.

And this is just the beginning.



A product manager loads her spreadsheet using the IBM Token-Ring Network to access information.



Programmers work within the framework of IBM Systems Application Architecture to develop applications.



The IBM 9370 computer stores information and provides data base management support for the business.



A design engineer uses an IBM Personal System/2 Model 80 to create a product accessing designs from the host computer.

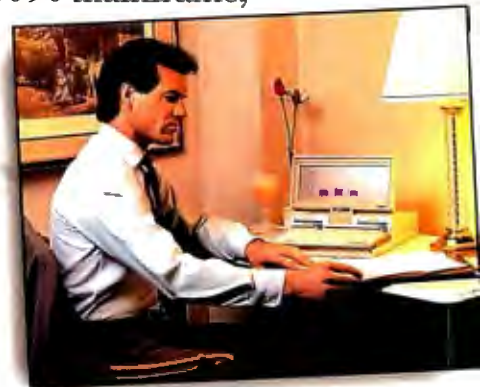

Meanwhile, from a hotel room, a salesman uses the modem in his IBM PC Convertible to send back details of a new order.

IBM just got smaller. three quarter inches.

The new media.

The amazing 5¼" floppy diskette can hold literally hundreds of pages' worth of memos, reports and vital statistics.

So why are we switching to 3½" diskettes?

Because they hold up to twice the information, and they don't flop. A hard plastic case protects them from mishaps that floppy disks are heir to.



A simple accessory kit transports data from 5¼" to 3½" diskettes.

So not only can you slip a diskette into your shirt pocket, you'll have fewer of them, with more of

your work all in one place. You won't have to fool around with write-protect tabs anymore, either. They're built right in.

Bridging the gap.

Very nice, you say, but what about all that work on 5¼" diskettes?

We thought about that from the very beginning, and we're offering a num-



ber of low-cost solutions to make the transition as smooth as possible.

It takes two 360KB 5¼" diskettes to hold as much as one 720KB 3½" diskette.

Also available are special IBM 3½" and 5¼" external diskette drives, to be there



One is a simple cable adapter and software package that lets you send your data from an IBM PC, PC XT or Personal Computer AT to your IBM Personal System/2, then onto the smaller diskettes. Depending on how much data

you have, the whole job could be over in one sitting.

By one and

anytime you need them, for conversions in either direction.

Software is here.

And what about software? Well, 3½" diskettes may be new to full-sized IBM personal computers, but they're not new to personal computing.

They're used, for example, by the IBM PC Convertible. So, many popular spread-

sheet, word processing, data base and other programs (from IBM and other companies) are already available on 3½" diskettes. And software makers are working to get new releases out quickly.

Optical allusion.

If a 3½" diskette can store large amounts of information, here's a way to store gargantuan amounts.

We're introducing a 200-million-byte optical disk drive.

It works with all Personal System/2 computers and, with advanced laser technology, will let you build a massive library of infor-



The IBM 3363 Optical Disk Drive with "write-once, read-many" disks (left) and the IBM 3.5 Inch External Diskette Drive (right).



The IBM 5.25 Inch External Diskette Drive.

mation for business, science and education on removable disks you can hold in your hand.

The solution is part of the system.

The new solutions.

We sell computer systems, but that's not what you're really after.

You want the things a system can do for you.

So while we were busy developing new machinery, we were also active on the software front.

One of the first things we looked at was how you choose software.

Over the last five years, thousands of programs have been written—by us and by others—for IBM PCs. That's a

independent software companies.

Getting with the program.

We're telling them about our move to 3½" diskettes so they can convert popular programs to that size. We're showing them our new graphics so they can revise software to take advantage of them. And we're keeping them up-to-date about the new IBM Operating System/2

so they can create brand new programs with even higher levels of function.



IBM CADwrite Design and Drafting System SolutionPac for designers and engineers.

good thing, and we want to keep it going, so we've continued to work with



So, popular programs like Lotus 1-2-3™, WordPerfect® and dBase III PLUS™ will be available for the Personal System/2.

f the Needless to say, we've also updated our popular IBM software. IBM DisplayWrite™ 4, the IBM Assistant Series™, IBM Business Adviser* and IBM educational programs are ready to go for the Personal System/2.

The IBM SolutionPac™

Then we looked at software from another point of view.

With so many decisions to make, so many combinations of hardware and



IBM Business Adviser Financial Accounting SolutionPac.

software, choosing the right one can be confusing. Maybe you'd prefer "one-stop shopping."

So we created an idea called IBM SolutionPacs.

You'll be able to buy them from selected IBM Authorized Advanced Products Dealers.

What you'll get is a software package

designed for your kind of business, with a hardware ensemble that's been matched to it, and tested. Plus a program of service, training and support.

A wide range of IBM SolutionPacs is in the works.

Among the first ones available are the Business Adviser Financial Accounting SolutionPac, a

CADwrite Design and Drafting System for designers and engineers, a desktop publishing SolutionPac and a Doctor's Office Management package, as well as SolutionPacs for contractors and lawyers.



Popular programs will be available for the IBM Personal System/2.



They will make buying easier, and should shorten the time between "I've got my computer system" and "I've mastered my computer system."

Of course, a big role is played by the new Advanced Products Dealers. Their new "whole-solution" training will make it easier for the two of you to assemble the best system for you.

New power to the prin

The new printers.

Most of what shows up on your computer screen is seen by just one person. You.

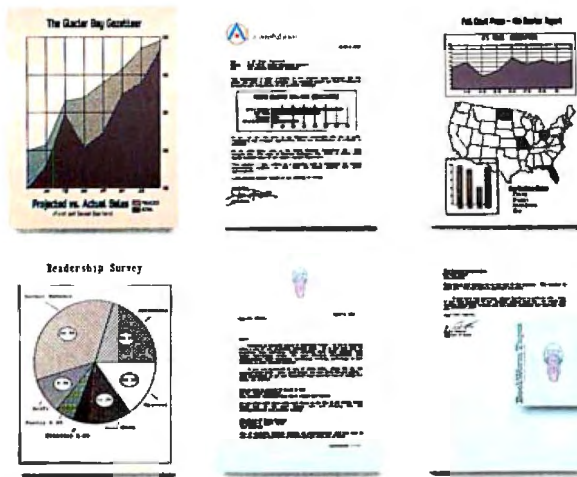

But what comes out of your printer goes out to the world. So it has to look professional, and getting it done has to be easy; virtues that have made IBM personal printers best-sellers.

The IBM Proprinter™ and the IBM Quietwriter® Printer have earned high marks from both customers and critics.

Now our printers are even better, and we've added

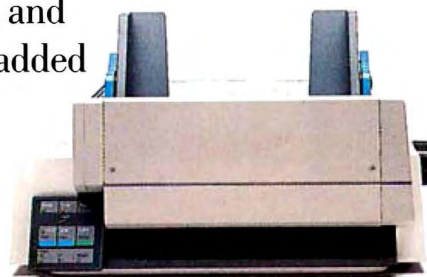

The IBM Proprinter X24 with optional sheet feed.

new members to the existing family.

The IBM Proprinter II.

What made the original Proprinter so popular was speed, versatility and convenience.

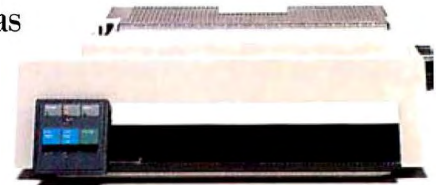

So what do you get more of in the Proprinter II? Speed, versatility and convenience.

The IBM Proprinter II.

fast

letter quality" is faster too, because now there's a button for changing modes.

There's also a choice of typestyles, and of course you can still load envelopes from the front and put in single sheets any time you want.

The IBM Proprinter II is for anyone who wants to print text and graphics, with a printer that's fast and economical.

The IBM Proprinter X24 and Proprinter XL24.

The IBM Proprinter X24 and Proprinter XL24 are new. The "24"

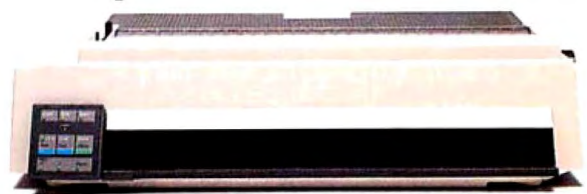

The IBM Proprinter XL24 has a wide carriage, ideal for spreadsheets.

ted page.

stands for 24-wire technology. What *that* stands for is new levels of Proprinter quality for everything you put on paper.

Both models print letter quality text with greater detail and graphics with better density and definition. The improvement is easy to see.

So is the performance. When compared to current, best-selling, comparably priced 24-wire printers, the Proprinter X24 and Proprinter XL24 print 1½ to 2 times the draft output in the same amount of time.*

The Proprinter XL24 has a wide carriage for spreadsheet printing, and both have an optional sheet feed for added paper-handling convenience, plus FontSet,[™] an option that lets you choose from 11 other typestyles.

The IBM Quietwriter III Printer.

Earlier IBM Quietwriter printers have always been

easy on the ears, but the new IBM Quietwriter III Printer is even quieter and goes nearly twice as fast, printing executive letter quality text and graphics in an executive hurry.

There's new flexibility in style, as well. The Quietwriter III Printer comes with four different type fonts built in and you can combine typestyles within the same document.

If that's not enough, there are optional font cartridges that give you the freedom to use up to eight typestyles on one page.

There's also a new dual-drawer sheet feed (with optional envelope feed) that lets you use letterhead stationery for the first page of a letter, then plain paper for the rest.

No matter what level of price or performance you need, there's an IBM personal printer to fit the bill. And they fit very nicely with the IBM Personal System/2.

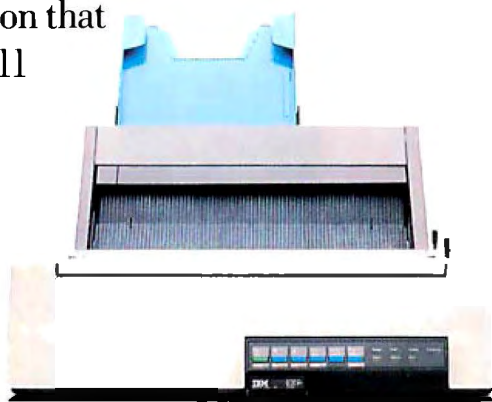

The IBM Quietwriter III Printer with single-drawer sheet feed.



There's also an innovative multiple-drawer sheet feed.

It's not just what you buy but where you buy it.

The new support.

As we designed the IBM Personal System/2, we weren't just thinking about products. We also paid serious attention to how, and where, you buy them.

The IBM Personal System/2 offers so many possibilities, so many new ways to do things better; astute guidance must be there if you need it.

So we're raising the bar for customer support. Naturally, our IBM Marketing Representatives are fully knowledgeable about the Personal System/2. But also, we're bringing even greater levels of support from our dealers to you.

IBM Authorized Advanced Products Dealers.

Announcing the new IBM Authorized Advanced Products Dealers.

Selected from our already outstanding dealers, they're being specially trained and qualified. They will have the IBM Personal System/2 computers, IBM network and connectivity products, peripherals, new IBM Operating System/2 when it's available, and all the support you should need.

Perhaps even more important, they'll have a new focus; on systems instead of single pieces of hardware, on solutions instead of circuitry.

They'll be thinking not only about the system you buy, but also about how you'll be using it.

They'll offer help with learning about systems and software, connectivity, and Operating System/2.

And they're committed to new standards of training for their sales, technical support, and service people.

No matter how big your business, whether you need one computer or a whole network's worth, the Advanced Products Dealer has what you need.

IBM Authorized Advanced Products Value Added Dealers.

If you're a specialist—a dentist, a librarian, a ship-builder—you need help

The Advanced Products Dealer will provide new levels of training. It's all part of the IBM Personal System/2.

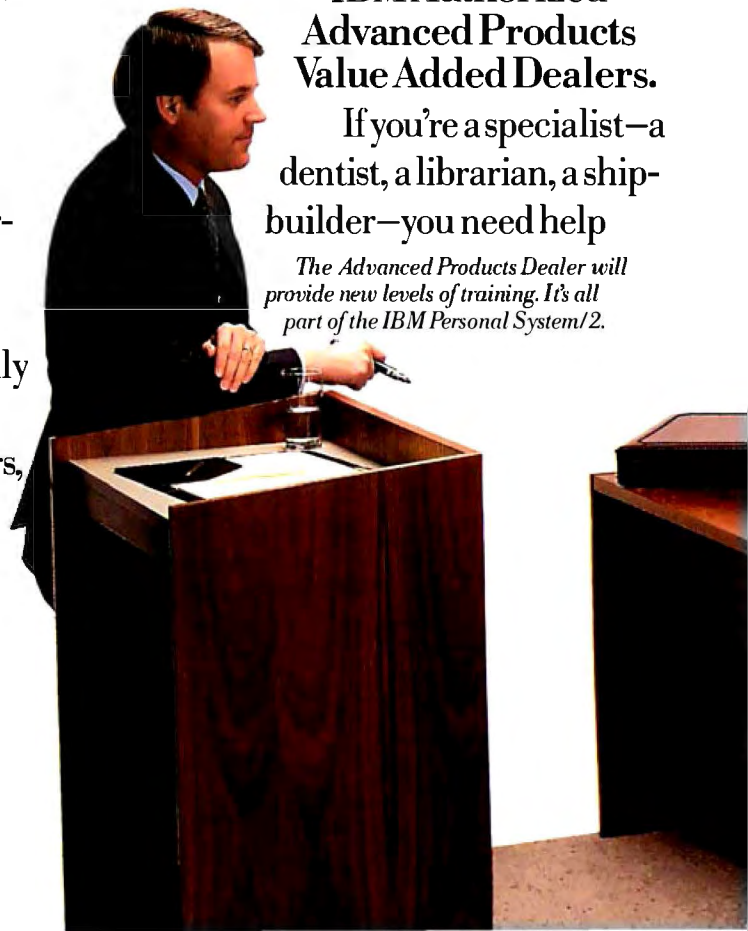

uy,

from a special kind of dealer.
Introducing the new IBM
Authorized Advanced Products
Value Added Dealers.

They're specialists, too. They build enhanced systems for specific industries and now, with the entire Personal System/2 family, their building blocks are better than ever. There's an Advanced Value Added Dealer who understands your business almost as well as you do.

IBM Authorized Dealers and Value Added Dealers.

Our IBM Authorized Dealers and Value Added Dealers will have the IBM Personal System/2 Model 30 and peripherals to go with it, plus special know-how for helping people get started in computing.

IBM Marketing Representatives.

These people have special skills for

helping large companies and educational institutions make the most of their investment in the IBM Personal System/2.

And now, through the IBM Customer Fulfillment Option, our customers may also work with our dealers and value added dealers to get the best of both worlds; additional support for the Personal System/2 plus the benefits of dealing with IBM directly.

Congratulations are in order.

It's not easy to qualify (and stay qualified) as an Advanced Products Dealer. Our expectations are high, as high as yours are.

So when you visit one of our Advanced Products Dealers, give them a nice pat on the back. They've just signed up for a tough course.



A system that's bigger sum of its parts.

A new direction.

The IBM Personal System/2 arrives in the wake of some fairly eager public speculation. So we expect there'll be a focus on "the new IBM PCs?"

But our focus is different.



*IBM's one-million-bit
memory chip joins the world of personal computing.*

While the machines are certainly key to the system, they are not The System.

It's bigger.

And it begins, not with chips or circuit boards, but with you. After all, if our products don't answer your needs, you don't need them.

So everything about the Personal System/2—how we build it, how you learn and use it, where you go to buy it, and how well it works with your other systems—is balanced to give you the highest overall performance.

A new quality.

We're making the Personal System/2 even more reliable than our earlier PCs.

With new Very Large Scale Integration technology, many pieces in a system are now replaced by one piece. Our one-million-bit memory chip reduces complexity, too. So costs go down, dependability goes up, and you get more work done in less time.

We're also using more IBM-made components, and we're subjecting our systems to more rigorous testing.

We even operate each one for several hours before it goes out the door.

Yet in creating all this new technology, we didn't forget that three million earlier IBM PCs are out in the world. So our two generations are close relatives, and your investment in equipment and training is protected.

Nor did we forget that many of you have larger IBM systems. The Personal System/2 will help you build better connections with IBM mid-range and main-frame computers.

New help.

We've also made the Personal System/2 easier to learn. New IBM manuals, tutorial

than the

diskettes, and start-up procedures will help you get your system going quickly.

So will the people you bought it from. Our new Advanced Products Dealers and IBM Marketing Representatives won't just sell you the right system, they'll be

there to help you get the most out of it. And as your needs grow, they'll be able to help you expand your system to meet new challenges.

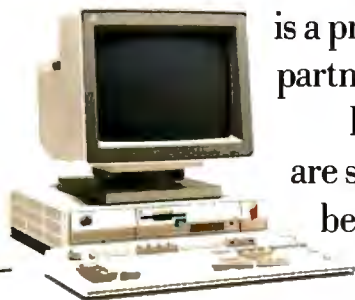

Earlier IBM PCs and the new IBM Personal System/2 work together so your investment is protected.

A continuing tradition.

It's said in the world of computing that the only constant is change, but that's not entirely true.

In IBM's world of computing one thing holds firm, and it's the notion of partnership between our people and our customers. The Personal System/2 is a product of that partnership.

IBM people are some of the best listeners in the business, and when they hear what you

want, they do something about it.

We're very proud of them all, and the more you know about the IBM Personal System/2, the more you'll understand why.



And now for the fine print.

All models include integrated display support, 256-color graphics capability, clock/calendar, and ports for serial, parallel and pointing devices. All systems use a common IBM enhanced keyboard and accept any IBM Personal System/2 monochrome or color display. All models accept the 200MB IBM 3363 Optical Disk Drive option.				
	Model 30	Model 50	Model 60	Model 80
Microprocessor	8086	80286	80286	80386
Potential system throughput¹	Up to 2½ times PC XT	Up to 2 times Personal Computer AT	Up to 2 times Personal Computer AT	Up to 3½ times Personal Computer AT
Standard Memory	640KB	1MB	1MB	Up to 2MB
Expandable to		7MB	15MB	16MB
Diskette size and capacity	3.5 inch 720KB	3.5 inch 1.44MB	3.5 inch 1.44MB	3.5 inch 1.44MB
Fixed disk²	20MB	20MB	44, 70MB	44, 70, 115MB
Additional Options			44, 70, 115MB	44, 70, 115MB
Maximum configuration³	20MB	20MB	185MB	230MB
Expansion slots⁴	3	3	7	7
Operating system(s)	PC DOS 3.3	PC DOS 3.3 and Operating System/2	PC DOS 3.3 and Operating System/2	PC DOS 3.3 and Operating System/2

1. Based on the testing described in the IBM Personal System/2 Performance Guide. Your results may vary. 2. Model 30 also comes in a diskette-based configuration. 3. Models with 44MB fixed disk expandable to 88MB. 4. Model 30 accepts most IBM PC and IBM PC XT option cards. Models 50, 60 and 80 accept new IBM Micro Channel option cards.

Now that you've read all about the new IBM Personal System/2 and examined its specifications, what should you do?

Go to your telephone. Call 1-800-447-4700 (ext. 9) and you'll learn who's the IBM dealer nearest you.

(In Alaska call 1-800-447-0890, in Canada 1-800-465-6600.)

And here are two things to ask when

you finally get face to face.

Ask about an IBM Credit Card. It just makes buying that much easier for a person or a business.

Or, if you prefer leasing, ask an IBM authorized dealer or IBM Marketing Representative about the IBM leasing programs.

With those formalities out of the way, you'll want to join the next generation in personal computing.

The IBM Personal System/2. **IBM**



Lotus and 1-2-3 are trademarks of Lotus Development Corporation. WordPerfect is a registered trademark of WordPerfect Corporation. dBase III PLUS is a trademark of Ashton-Tate. IBM, Personal Computer AT and Quietwriter are registered trademarks of IBM Corporation. Assistant Series, DisplayWrite, PC XT, Professional Office System, Proprinter, "Fastfont," "FontSet," "Micro Channel," "Operating System/2," "Personal System/2" and "SolutionPac" are trademarks of IBM Corporation.

BOOK REVIEWS

THE AUTOCAD PRODUCTIVITY BOOK: TAPPING THE HIDDEN POWER OF AUTOCAD

A. Ted Shaefer and
James L. Brittain
Ventana Press
Chapel Hill, NC: 1986
ISBN 0-940087-00-6
314 pages, \$39.95

THE WORLD OF PROGRAMMING LANGUAGES

Michael Marcotty and
Henry Ledgard
Springer-Verlag
New York: 1987
ISBN 0-387-96440-1
360 pages, \$29.95

THE INGRES PAPERS: ANATOMY OF A RELATIONAL DATABASE SYSTEM

Michael Stonebraker, ed.
Addison-Wesley
Reading, MA: 1986
ISBN 0-201-07185
452 pages, \$35.95

THE AUTOCAD PRODUCTIVITY BOOK: Tapping the Hidden Power of AutoCAD

Reviewed by
Steven H. Rogers

The *AutoCAD Productivity Book* by A. Ted Shaefer and James L. Brittain is targeted at AutoCAD (a CAD program from Autodesk) users who have a basic knowledge of how AutoCAD works. For designers who use AutoCAD, this book contains techniques to customize and otherwise improve the performance of their AutoCAD systems.

The book has two main sections. The first is tutorial in nature, while the second is a library of AutoCAD macros and AutoLISP functions to make life easier for the AutoCAD user. relative newcomers to AutoCAD can proceed through the tutorial and perform the exercises it presents, while those more proficient in AutoCAD might skim it to try out the tools from the Productivity Library.

Unfortunately, AutoCAD was not available in time for this review. I have therefore reviewed the book based on its ability to communicate the concepts and techniques for enhancing AutoCAD. I have focused on the section of the book called the Productivity Library. I cannot comment on the publisher-supplied and updated version of a disk that accompanies the book.



The tutorials cover hard disk management and DOS operations, macro writing, menu customization, and automating some drawing tasks. Detailed examples are appropriately used to illustrate the techniques described. The conversational tone is informal, and explanations are simple without being condescending.

The authors point out that because AutoCAD is a powerful but general-purpose design package, most users will require customization. Commands are provided for operations that some users might rarely use. The 20/80 rule is introduced here: Most users will end up using only about 20 percent of the commands about 80 percent of the time. Editing with Edlin is described in some detail on the grounds that it is bundled with MS-DOS. The authors lead the reader through the construction of a simple macro using Edlin.

Graphics Tablets

Shaefer and Brittain discuss the design of menus for graphics tablets. They assert that graphics tablets are the most efficient way to interact with AutoCAD and that the pro-

ductivity gain more than offsets the expense of a tablet when compared with a mouse. The menu overlay on a graphics tablet can contain more choices than a screen menu, so you save time searching through menus for the desired command. With many commands spread out before you, solutions may suggest themselves that you might overlook if you had to search through a menu tree. The authors demonstrate how to apply ergonomic principles in designing a customized tablet menu for your applications.

The AutoCAD Productivity Book gives examples of design automation with AutoCAD, including a macro that automatically generates a parts list and another that automatically draws baseplates for steel light poles from engineers' specifications. You're encouraged to adapt these macros to your own needs.

The Productivity Library

The AutoCAD Productivity Library consists of a set of 70 macros and AutoLISP routines intended to be entered and run

continued

Expansion Chassis/Tape Back-up

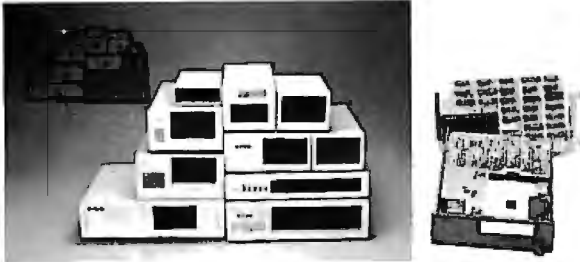

Specification

Model No.	No. of Slot	Space for 1/2 Height Drive	Power Supply (Watts)	Dimension D×W×H(cm)	Price
M-1*	0	1	50	30×15×6.5	\$139
M-2	3	3	100	42×25×16	\$299
M-3	5	3	100	39×30×15	\$239
M-4	12	2	100	40×49×14	\$299
M-5	0	2	45	39×18×15	\$149
M-6	0	1	50	26.5×18×13.5	\$169
M-7	5	2	100	38.5×30×13.5	\$299
M-8	0	2	45	39.5×18×13.5	\$149
M-9	0	2	60	38.5×49×9	\$249
M-10	8	4	135	43×49×14	\$239

* Extra space for a stand alone controller

EXT and RCV Adapters (Interfacing Computer & Chassis With Slots)...\$149

Tape Back-up (With Controller & Cable)...\$499

ORDER TOLL FREE: (800) 826-0267
In California Call (408) 434-0877

SOURCE ELECTRONICS CORP.

2380 Qume Drive, Suite E

San Jose, CA 95131

Telex: 279366

Fax: (408) 434-0539

"as is." An updated AutoCAD Productivity Diskette is available separately that relieves you of the task of manually entering the routines. It also contains routines that are not included in the book. While the authors offer some explanation for the AutoLISP routines, they make no attempt to teach LISP, for which you are appropriately referred to other sources.

The macros are documented with the standard pattern of the macro number and name, its purpose, step-by-step instructions for creating it, an example of its use, and guidelines for customizing the macro to your particular needs. Some of the macros are also used as examples in the tutorial section with more detailed explanation.

Most of the macros and AutoLISP routines are written for AutoCAD versions 2.15 through 2.5, while some are written specifically for version 2.5. Some of the others perform functions that have been added to version 2.5. No one will be able to use all of them, but everyone should find something to make working with AutoCAD easier.

The tools provided in the AutoCAD Productivity Library range from simple one-line macros to AutoLISP routines consisting of about a page of code. All macros are listed in both the table of contents and the index. A nice touch is the boldfacing of macro entries in the index.

The simpler macros merge frequently used sequences of AutoCAD commands into single menu selections. They do such things as erase the last entity created, check the spelling of text without having to specify attributes such as height and rotation, and move objects from one layer to another.

More complex macros are required to fit existing text into a specified area, create a parts list, or insert a sequence of numbers into a drawing. Other macros construct a square, rectangle, or parallelogram at arbitrary angles; draw ellipses and polygons automatically; and transfer text between drawings and ASCII files.

A Lever for Design Tasks

BYTE's April 1987 theme section on instruction set strategies explored the RISC (reduced instruction set computer) design approach. *The AutoCAD Productivity Book* redefines the RISC acronym to mean reduced instruction set command. The authors should have avoided obscuring the meaning of the term.

In my estimation, Shaefer and Brittain's book lives up to its subtitle, *Tapping the Hidden Power of AutoCAD*. The authors provide the necessary guidance to assist AutoCAD users at all levels of expertise to customize AutoCAD to better suit their needs.

In dealing with physical objects, a lever lets you multiply force to accomplish a task more easily, but you have to know where to place the lever to gain the maximum benefit. CAD is like a lever for design tasks, and *The AutoCAD Productivity Book* shows you where to place the AutoCAD lever to achieve the best results.

Editor's note: *A 100-page instructor's guide will be available in June for The AutoCAD Productivity Book: Tapping the Hidden Power of AutoCAD, coauthored by Charles Pietra and Jack Manno. It is designed for teachers conducting courses on customizing AutoCAD and includes a student workbook. The suggested retail price is \$12.95.*

The guide is available from your local bookstore, or you can contact the publisher directly: Ventana Press, P.O. Box 2468, Chapel Hill, NC 27515, (919) 490-0062.

Steven H. Rogers (P.O. Box 10967, Midwest City, OK 73140) is an engineering physicist who has worked with CAD technicians using the CALMA CAD system to design VLSI test structures.

continued

AMX 86

KADAK's engineers bring years of practical real-time experience to this mature

MULTI-TASKING SYSTEM (version 2.0)

for the IBM® PC, PC/XT and PC/AT

- No royalties
- IBM PC DOS® support
- C language support
- Preemptive scheduler
- Time slicing available
- Intertask message passing

- Dynamic operations:
 - task create/delete
 - task priorities
 - memory allocation
- Event Manager
- Semaphore Manager

AMX86™ operates on any 8086/88, 80186/88, 80286 system.

Demo package \$25 US
Manual only \$75 US
AMX86 system \$2195 US
(shipping/handling extra)

KADAK Products Ltd.
206-1847 W. Broadway
Vancouver, B.C., Canada
V6J 1Y5
Telephone: (604) 734-2796
Telex: 04-55670

Also available for 8080, Z80, 68000

Softline PRICE BUSTERS



3.5 INCH SOFTWARE NOW IN STOCK CALL!

Software

Word Processing/ Desktop Publishing	
FANCY FONT	\$139
FINAL WORD II	\$229
HARVARD PROFESSIONAL PUBLISHER	\$389
MICROSOFT WORD 3.1	\$269
MULTIMATE MULTIMATE	\$249
ADVANTAGE-NEW	\$279
LOTUS MANUSCRIPT	\$359
OFFICE WRITER/ SPELLER 5.0	\$249
PAGEMAKER	\$499
PFS: PROF WRITE	\$119
TURBO LIGHTNING	\$ 65
VENTURA PUBLISHER	\$569
VOLKSWRITER 3	\$145
WORD PERFECT 4.2	\$195
WORDSTAR PRO 4.0	\$249
WORDSTAR 2000 + XYWRITE III	\$199

Database Systems	
CLIPPER	\$ 389
DB XL	\$ 99
DBASE III PLUS-NEW	\$ 415
FOXBASE + GENIFER	\$ 219
KMAN 2	\$ 209
PARADOX	\$ 299
PFS: PROF FILE	\$ 389
Q&A	\$ 145
QUICKSILVER	\$ 219
R BASE SYSTEM V	\$ 339
RAPIDFILE	\$ 349
REFLEX	\$ 239
REVELATION	\$ 89
	\$ 499

Spreadsheets/ Integrated Packages	
ENABLE	\$ 339
FRAMEWORK II-NEW	\$ 415
JAVELIN	\$Call
LOTUS 1-2-3	\$ 309
LOTUS HAL	\$ 109
MULTIPLAN	\$ 125
OPEN ACCESS II	\$ 289
SMART SYSTEM	\$ 429
SUPERCALC 4	\$ 319
SYMPHONY	\$ 449

Communications	
CARBON COPY	\$ 119
CROSSTALK XVI	\$ 99
CROSSTALK MKIV	\$ 139
RELAY GOLD	\$ 159
SMARTERM (PERSON)	\$Call
SMARTCOM II	\$ 99

Statistics	
SPSS/PC + STATGRAPHICS	\$699
STATPAC GOLD- WALONICK	\$399
SYSTAT	\$469

*CALL FOR SHIPPING COSTS

THE INCREDIBLE JACK2 "Electronic Workspace" from PECAN™

Do Wordprocessing, Spreadsheets, Database and Graphics all on one screen at the same time.



Normally priced at ~~\$99.95~~
NOW \$9.95
with purchase over \$1,000.

Graphics	
CHARTMASTER	\$209
DIAGRAPH	\$309
DIAGRAM MASTER	\$189
FREELANCE PLUS	\$349
GEM DRAW + GRAPHWRITER COMBO	\$189
HARVARD PRESENTATION GRAPHICS	\$349
IN-A-VISION	\$229
MAPMASTER	\$289
MS CHART	\$219
PC PAINTBRUSH PLUS	\$189
PICTURE PERFECT	\$109
PRODESIGN II PUBLISHERS	\$245
PAINBRUSH	\$159
SIGNMASTER	\$219
WINDOWS/DRAW	\$139
	\$159

Network Applications	
CROSSTALK XVI	\$399
DBASE III LAN PAK	\$599
KMAN 2	\$899
MULTIMATE	\$599
MULTIMATE ADVANTAGE	\$729
REVELATION	\$299
WORD PERFECT SERVER	\$309
WORD PERFECT STATION	\$ 75

Accounting	
BPI	\$ 179
GREAT PLAINS	\$ 499
COMPUTER ASSOC ONEWRITE PLUS	\$ 399
OPEN SYSTEMS	\$ 159
	\$ 409

Desktop Environments	
GEM DESKTOP	\$39
LOTUS METRO	\$65
MS WINDOWS	\$65
SIDEKICK	\$59

Project Management	
HARVARD TOTAL PROJECT MANAGER II	\$329
MICROSOFT PROJECT	\$249
PROJECT SCHEDULER NETWORK	\$379
SUPERPROJECT PLUS	\$319
TIMELINE 2.0	\$259

Languages/Utilities	
APL + V6.0	\$ 369
COPYWRITE	\$ 45
FASTBACK	\$ 89
LATTICE C	\$ 219
NORTON ADV UTILITIES	\$ 89
MICROSOFT C COMPILER	\$ 279
MACE UTILITIES	\$ 65
MS FORTRAN 4.0	\$ 279
1DIR + QUICK BASIC	\$ 69
TURBO BASIC	\$ 69
TURBO C	\$ 69
TURBO PASCAL	\$ 69
TURBO PROLOG	\$ 69
XENIX	\$Call

Productivity Tools	
ORG + INTERACTIVE	\$ 69
EASYFLOW	\$ 125
SMARTNOTES	\$ 49
VP EXPERT	\$ 59
EUREIKA	\$ 69
SIDEWAYS	\$ 39

Hardware*	
Computers	
AST PREMIUM 286	\$Call
WYSE 286 PC	\$Call
PANASONIC BUSINESS PARTNER	\$Call
TOSHIBA 3100/1100 +	\$Call

Emulation Boards	
AST 5211-11 +	\$ 629
FORTE PJ	\$ 775
IRMA	\$ 725
SMART ALEC 5251	\$ 589

Monitors	
AMDEK 310A	\$149
AMDEK 410A	\$ 169
AMDEK 600/722	\$409/519
AMDEK 1280	\$ 779
NEC MULTISYNC	\$579
PRINCETON HX-12	\$439
PRINCETON MAX-12E	\$169
PRINCETON HX-12E	\$529
SONY MULTISCAN	\$699

Display Boards	
ATI EGA WONDER + HERCULES GRAPHICS CARD PLUS	\$279
HERCULES COLOR CARD	\$189
NEC GB1	\$159
PARADISE AUTO SWITCH EGA 480	\$409
QUAD EGA PROSYNC	\$399
QUADRAM EGA +	\$339
TESENG EVA 480	\$289
VIDEO 7 VEGA DELUXE	\$389
	\$399

Modems	
HAYES 1200	\$379
HAYES 1200B	\$359
HAYES 2400	\$579
HAYES 2400B	\$529
MIGENT POCKET	\$159
TRANSET 1000	\$279
US ROBOTICS 1200	\$139
US ROBOTICS 1200B	\$109
US ROBOTICS 2400B	\$189
VENTEL 2400	\$409
VENTEL 2400B	\$409
WATSON	\$339

Multifunction Boards	
AST ADVANTAGE (128K)	
AST 6 PAK PLUS (64K)	\$ 349
AST I/O MINI II	\$ 169
AST PREMIUM	\$ 119
AST RAMPAGE PC	\$ 169
AST RAMPAGEAT	\$ 279
INBOARD 386AT	\$ 439
INTEL ABOVEBOARD	\$1350
ORCHID 386	\$Call
PC TURBO 286(1MB)	\$ 949
PC TINY TURBO 286	\$ 749
QUADBOARD (OK)	\$ 449
	\$ 109

Printers/Plotters	
EPSON EX-1000	\$ 549
EPSON FX-86E	\$ 359
EPSON FX-286E	\$ 499
EPSON LQ-1000	\$ 675
HP 7475A	\$ 695
HP LASERJET II	\$1499
NEC 3550	\$1875
OKIDATA 192 +	\$ 789
OKIDATA 193 +	\$ 379
OKIDATA 292	\$ 549
OKIDATA 293	\$ 539
TOSHIBA P321	\$ 689
TOSHIBA P341 E	\$ 499
TOSHIBA P351 MODEL2	\$ 769
	\$1049

Mass Storage/Backup	
IOMEGA 20 + 20 W/INTFC	\$2599
IRWIN 120D 20MB INT	\$ 469
IRWIN 145AT 40MB INT	\$ 579
IRWIN 445 A TINT MOUNTAIN	\$ 679
BERNOULLI 20	\$1599
PLUS HARDCARD 20MB	\$ 675
PRIAM 42MB AT	\$ 799
PRIAM 60MB AT	\$1099
SEAGATE 225 W/INT	\$ 349
SEAGATE ST238 W/INT	\$ 389
SYSGEN SMART IMAGE 60MB (INT)	\$ 619
TALLGRASS	\$ Call
TECMAR QIC-60AT TBU (INT)	\$1199

Networks	
ARCNET	\$Call
AST PC NET	\$Call
NOVELL	\$Call
ORCHID PC NET	\$Call

Input Devices	
KEYTRONICS 5151	\$169
KEYTRONICS 5153	\$299
MICROSOFT MOUSE	\$129
PC MOUSE/PAINT +	\$109

Accessories	
CURTIS RUBY	\$ 59
DATASHIELD S-100	\$ 69
GILTRONIX SWITCHES	\$Call
LOGICAL CONNECTION	\$ 329
MASTERPIECE PLUS	\$ 129
MICROFAZER II	\$ 269
256K RAM SET	\$ 39
8087 MATH CHIP	\$ 119
80287 MATH CHIP	\$ 189

FREE SHIPPING

on all orders over \$1000.00, credit card orders and prepaid orders.

Our Policy:

* Visa or Mastercard — add 3% * COD — Cash M.O. or bank check only — add \$5.00 per order * Prepaid personal or company check — allow two weeks to clear * We ship via air where shipped out of NY State * Shipping via UPS Surface add \$3.00 per item, UPS Blue — add \$8.00 per item * All returns require prior authorization * Prices subject to change, call for latest prices.



1-800
221-1260

In New York State call (718) 438-6057

Softline
P.O. Box 729, Brooklyn, NY 11230
TELEX: 421047 ATLN U
FAX: 718-972-8346

pmi INTRODUCES

PERFORMANCE PERIPHERALS

FAST286™



ONLY \$295

30 DAY FREE TRIAL 1 YEAR WARRANTY

80286 COPROCESSOR

**CONVERT YOUR PC-XT TO PC-AT
POWER AND PERFORMANCE
WITH 80286 COPROCESSING**

- 10MHz Operation
- BUS Independent Operation
- Switch Selectable Mode Between 8088 & 80286: Guarantees 100% Software Compatibility
- 8KB of Zero-Wait-State Memory
- Compatible with 8MHz Motherboards
- Free IMS Disk Caching Software

FAST286 OFFERS NINE TIMES THE PERFORMANCE PER DOLLAR OF 80386 MACHINES.

LOTUS EMS COMPATIBLE

FASTCARD®



30 DAY FREE TRIAL 1 YEAR WARRANTY

ONLY \$295

THE ONLY EXPANDED MEMORY CARD WHICH CAN SAVE A DAY EACH WEEK.

A major independent testing laboratory benchmarked a PC-XT equipped with FASTCARD and demonstrated a tenfold improvement over a PC-AT on typical disk I/O operations.

- 8 MHz operation
- 1MB of Factory Installed & Tested DRAMS
- Split Memory Fills to 640K, Provides Expanded Memory Over 640K.
- Disk Caching & Print Buffering Software
- Serial, Parallel & Game Ports
- Clock Calendar
- Custom Password Security

LOTUS EMS COMPATIBLE

**BUY BOTH AND SAVE
ORDER FAST286 WITH FASTCARD
FOR ONLY \$495!**

DEALER INQUIRIES WELCOME

FOR ADDITIONAL INFORMATION CONTACT:

pmi PERIPHERAL MARKETING, INC.
7825 E. EVANS RD., BLDG. 500, SCOTTSDALE, AZ 85260
(602) 483-7983

THE WORLD OF PROGRAMMING LANGUAGES

Reviewed by Joel West

As an aficionado of programming languages, my eye was drawn to *The World of Programming Languages*. It's a compelling title that evokes an image of a professor telling a BASIC-hardened freshman of the wonders to unfold in his journey into computer languages.

Sure enough, this new book is derived from a previous college text with a somewhat drier title, *Programming Language Landscape: Syntax, Semantics and Implementation* (Chicago, IL: Science Research Associates Inc., College Division, 1986), also coauthored by Marcotty and Ledgard. Ledgard is the author of numerous books on Pascal and Ada and the editor of the Springer-Verlag series that includes that title. Michael Marcotty was a key player in defining PL/I, which, as the authors note, was the Ada of the late 1960s—a huge language designed by committee to be everything to everyone.

Previous Approaches to Language Design

The book surveys key areas of language design, such as abstractions and control structures. However, it's necessary to acknowledge the limitations of its scope. The authors focus on the evolution of procedural languages to 1981 or so, with particular emphasis on Algol, PL/I, Pascal, and Ada, but they virtually ignore LISP, Prolog, and the numerous object-oriented languages.

In fact, the book might be more accurately titled *The World of Procedural Languages: How to Design Ada*. As the preface notes, "The book has gained much of its breadth by the work done by Ledgard on the design of Ada."

The authors apply their decades of experience in such languages to a comprehensive survey of the previous approaches. Within the theme of procedural languages, they offer a thought-provoking analysis of the challenges facing the language designer, with specific alternatives for each choice along the way. The text is both well structured and eminently readable.

The first part briefly surveys the subject and defines the landscape. Part two discusses variables, control structures, data types, I/O procedures, and lexical scoping. The third part of the book covers type extensibility, dynamic data structures, exception handling, and separate compilation—key strengths of the Ada design. It also examines task synchronization, like that provided by Ada's rendezvous construct. However, the book skips the more experimental and powerful recent approaches to parallel processing. A copious bibliography supplied by the authors chronicles the historical steps along the way.

The Authors' Approach

Marcotty and Ledgard's approach to language design can be illustrated by an example from the "Control Structures" chapter. Suppose you wanted to design a construct similar to the Pascal CASE to select from multiple alternatives, as in

```
CASE character OF
  'A': Write('Vowel');
  'X': Write('Consonant');
  '0': Write('Digit');
END;
```

The text notes that one useful extension to this basic syntax is to allow an "otherwise" clause to be executed for a value that does not match one of the specified cases. But suppose the "otherwise" is omitted from a particular structure, and none of the cases match the value. Should this produce a run-time error? the authors ask.

continued

GET YOUR FEET WET.

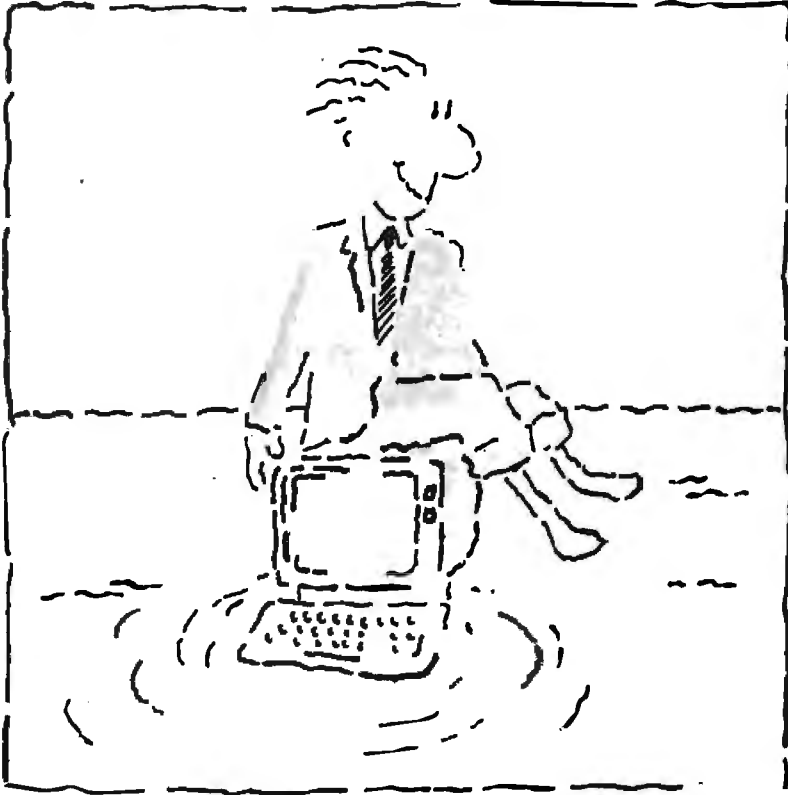

Sample Dow Jones News/Retrieval® — the nation's premier online

business and financial resource—without getting in over your head.

For only \$49.95, the News/Retrieval Membership Kit lets you and your colleagues plumb the depth of this valuable news and information service.

Eight free hours* of online time will get you started. There's a User's Guide to show you the way, step by step. And a year's subscription to *Dowline* (the magazine of News/Retrieval) gives

you background on and suggested applications for our offerings.

Stay on top of the competitive situation in your industry. Check on the positions of your company and clients. Keep up with breaking news or call up past news from *The Wall Street Journal* (online exclusively with News/Retrieval) back to January 1, 1984. You can analyze a wealth of financial data, tap a pool of general knowledge, even plan a trip using almost any computer and modem, terminal or communicating word processor.

The Dow Jones News/Retrieval Membership Kit. It can help you embark on a wave of success. . . and not feel soaked.

To order or for more information, call **1-800-221-7700, Ext. 417F.** (Alaska, Hawaii and foreign, call 1-215-789-7008, Ext. 417F.)

Or use the coupon.

YES! I WANT TO GET MY FEET WET!

Corporate offer—\$49.95 Each includes:

- 8 Free Hours* • Multiple Passwords
- User's Guide • 1 Year of *Dowline*
- \$12 Annual service fee waived for 1 year

Send more information

Personal offer—\$29.95 Each for

- individual use, includes: • 5 Free Hours*
- Single Password • User's Guide
- 1 Year of *Dowline* • \$12 Annual service fee waived for 1 year

\$ _____ ENCLOSED (Check/Money Order) Bill me later Charge to: AmExp MC VISA

(If you pay by credit card, all subsequent usage charges will be billed to your credit card.)

Card No. _____ Exp. Date _____

Signature _____

Name _____ Title _____

Company _____

Address _____

City/State/Zip _____

Daytime Phone Number _____

Mail to: DJN/R Membership Kit, P.O. Box 300, Princeton, NJ 08543-0300
ATTN: John McGovern HOBY0607E

*Per account. Limited to new subscribers only. Free time (8 hours per Corporate offer; 5 hours per Personal offer) must be used within 30 days after receipt of password(s). Certain databases have fees over and above usage charges which are excluded from free time offer.

Dow Jones News/Retrieval®
Fuel for your ideas.

PC/VI™**UNIX's VI Editor Now Available
For Your PC!**

Are you being as productive as you can be with your computer? An editor should be a tool, not an obstacle to getting the job done. Increase your productivity today by choosing **PC/VI**—a COMPLETE implementation of UNIX* VI version 3.9 (as provided with System V Release 2).

PC/VI is an implementation of the most powerful and most widely used full-screen editor available under the UNIX operating system. The following is only a hint of the power behind **PC/VI**:

- Global search or search and replace using regular expressions
- Full undo capability
- Deletions, changes and cursor positioning on character, word, line, sentence, paragraph, section or global basis
- Editing of files larger than available memory
- Shell escapes to DOS
- Copying and moving text
- Macros and Word abbreviations
- Auto-indent and Showmatch
- MUCH, MUCH MORE!

Don't take it from us. Here's what some of our customers say: "Just what I was looking for!" "It's great!" "Just like the real VI!" "The documentation is so good I have already learned things about VI that I never knew before." — *IEEE Software*, September 1986.

PC/VI is available for IBM-PC's and generic MS-DOS⁺ systems for only \$149. Included are CTAGS and SPLIT utilities, TERMCAP function library, and an IBM-PC specific version which enhances performance by as much as TEN FOLD!

PC/TOOLS™

What makes UNIX so powerful? Sleek, Fast, and **POWERFUL** utilities! UNIX gives the user not dozens, but hundreds of tools. Now the most powerful and popular of these are available for your PC! Each is a complete implementation of the UNIX program. Open up our toolbox and find:

- | | | | |
|----------|---------|---------|-----------|
| • BANNER | • DIFF | • PASTE | • SPLIT |
| • BFS | • DIFF3 | • PR | • STRINGS |
| • CAL | • GREP | • RM | • TAIL |
| • CHM(1) | • HEAD | • SED | • TR |
| • CUT | • MAKE | • SEE | • TOUCH |
| • DIFF | • OD | • SORT | • WC |

All of these for only \$49.00; naturally, extensive documentation is included!

PC/SPELL™

Why settle for a spelling checker which can only compare words against its limited dictionary database when **PC/SPELL** is now available? **PC/SPELL** is a complete implementation of the UNIX spelling checker, renowned for its understanding of the rules of English! **PC/SPELL** determines if a word is correctly spelled by not only checking its database, but also by testing such transformations as pluralization and the addition and deletion of prefixes and suffixes. For only \$49.00, **PC/SPELL** is the first and last spelling checker you will ever need!

Buy **PC/VI** and **PC/TOOLS** now and get **PC/SPELL** for only \$1.00! Site licenses are available. Dealer inquiries invited. MA residents add 5% sales tax. AMEX, MC and Visa accepted without surcharge. Thirty day money back guarantee if not satisfied! Available in 5 1/4", 3 1/2" and 8" disk formats. For more information call today!

*UNIX is a trademark of AT&T. *MS-DOS is a trademark of Microsoft.

CUSTOM SOFTWARE SYSTEMS
P.O. BOX 678 • NATICK, MA 01760
617-653-2555



UNIX TOOLS FOR YOUR PC

UNIX TOOLS FOR YOUR PC

Can the case conditions overlap? Is the order of case evaluation important? Answering such questions is the difference between a language defined by a written standard and a language defined only by its various (and possibly conflicting) implementations.

The Mini-Languages Approach

Each of the central chapters is developed around an imaginary simplified syntax for what Ledgard calls "mini-languages," which are stripped to the essentials to illustrate what he is discussing. This approach is at the core of the book's style and is perhaps its most problematic aspect.

These mini-languages let the authors tailor the syntax to just the problem being discussed. And where no existing language provides the necessary features, these languages let the authors focus the discussion on the topic at hand. They also give them a chance to design more languages in one book than many design in a lifetime, without the messiness of actual implementation.

However, many (if not most) of the languages resemble Ada, with a sprinkling of Pascal and PL/I thrown in. For example, the control structures exactly mimic the Ada approach, even where the approach of, say, Pascal provides the identical capabilities with an equally valid syntax.

More significantly, the approach is unnecessarily abstract, particularly when the Ada model is so closely followed. For the most part, each chapter would require only a few small syntax changes and an indication of the language illustrated to make the prose more concrete. In a book that is intended for the professional, an analysis of language design through case studies for each chapter would be more relevant and easier to follow. It would also allow the authors to spend more time acquainting the readers with the characteristics of the key languages, an important benefit for a survey text from such experienced hands.

Significant Omissions

Within its focus on procedural languages, this book's coverage of C seems particularly thin. The discussion of I/O abstractions, for example, somehow ignores one of the most flexible of such facilities available today. Meanwhile, the authors cover PL/I in some detail, despite the fact that the language is, like Ada, at the end of an evolutionary path, rather than the forebear of later languages, as with Algol, Pascal, and Smalltalk.

References to 72-column punched cards are amusing anachronisms that date the authors. However, the dismissal of the IEEE standard for floating point is a significant omission. With its treatment of infinities and imprecise results, IEEE-754 is an important reality of modern microsystems, defined by hardware such as the Intel 80x87 series and software such as the Standard Apple Numeric Environment (SANE).

Keep It Simple

The authors save their best for last. The final chapter, "The Swamp of Complexity," offers a revealing discussion from battle-scarred veterans that is all too brief.

As its title suggests, the chapter outlines how the excesses of language designers hinder the usability of their end result by making a language impracticably complex. The designer may be tempted to keep adding more and more, but the overriding goal should be to simplify and unify the language into a coherent whole. This message is clearly applicable to the design of any programming language.

The tendency toward complexity grows out of hand as the goals of the language become unfocused and the designer attempts to offer all things to all people. The problem is made even worse by the process of design by committee. To quote the authors:

continued

SILICON SPECIALTIES 1-800-354-7330



\$346 With System A or B Only

MIT SYSTEMS TURBO PC/XT
 256K Memory, 360K Brand Name Floppy Drive,
 135 Watt Power Supply Slide Case,
 AT Style Keyboard, 4-8MHz Clock Speed,
 (Keyboard Selectable), 8 Expansion Slots



\$936 With System C or D Only

MIT SYSTEMS PC/AT
 6-8 MHz Switchable, 512K RAM Expandable
 to 1MB on Motherboard, a 1.2MB Floppy Drive,
 192 Watt Power Supply, Dual Hard Drive
 & Floppy Controller Card, AT Style Keyboard
 and clock/calendar with Battery Back-up.

SYSTEM A	SYSTEM B	SYSTEM C	SYSTEM D
MIT XY Monochrome System MIT Turbo XT MIT Monographics Card With Printer Port MIT Amber Monitor With Swivel Tilt Stand MIT I/O Serial/Clock Card MIT 4 Outlet Surge Suppressor	MIT XY Color System MIT Turbo XT MIT Color Card With Printer Port MIT RGB Color Monitor MIT I/O Serial/Clock Card MIT 4 Outlet Surge Suppressor	MIT AT Monochrome System MIT 8 MHz AT MIT Monographics Card With Printer Port MIT Amber Monitor With Swivel Tilt Stand MIT AT Multi I/O Card MIT 4 Outlet Surge Suppressor	MIT AT Color System MIT 8 MHz AT MIT Color Card With Printer Port MIT RGB Color Monitor MIT AT Multi I/O Card MIT 4 Outlet Surge Suppressor
Turbo PC XT w 640K & 1 Drive with System Order Only \$ 379	Turbo PC XT w 640K & 1 Drive & 20 MG with System Order Only \$ 749	Turbo PC XT w 640K & 2 Drives with System Order Only \$ 458	Turbo PC XT w 640K, 1 Drive, 30 MG with System Order Only \$ 819
PC:AT 8 MHz w 1024K, 1.2 Floppy with System Order Only \$ 980	PC:AT 8 MHz w 1024K, 1.2 Floppy, 30 MG with System Order Only \$1586		

Hardware

Software

PRINTERS	MONITORS	COMPUTERS	BOARDS	MODEMS
Alps All Models Call Brother Printers Citizen Printers MSP-10 \$ 269 MSP-15 359 MSP-20 309 MSP-25 459 Premier 35 445 1200 169 Diablo D-25 469 635 759 Diconics 150 \$ 299 Epson Printers Call Hewlett-Packard Laser Jet Series II 1829 NEC 3510, 3550 729 8810, 8850 1059 P-6 429 P-7 619 P-9 429 Okidata Call Panasonic 1080 I 189 1091 I 245 1092 I 319 1592 385 1595 465 3131 229 3151 369 Star Micronics Toshiba 3215L Call 341E 669 351 Model II 1045 359 Color 1029 Cume 101 Plus Green \$ 315 101 Plus Amber 315 Wye 30 285 50 359 75 565 85 425 Bernoulli Box 10 Meg \$ 865 20 Meg 1199 40 Meg 1729 Separate 20 MG w/H/D Controller 339	Amdek Monitors Call NEC Multisync \$ 549 Other Models Call Princeton Graphics Monitors Call AST Model \$1399 Model 120 2099 Model 140 2449 Panasonic Business Partner 719 Sr. Partner 969 Exec. Partner Dual Drive 1429 Toshiba T-1100 SuperTwist 1399 T-3100 2799 AST Six Pack Plus 149 Other Models Call Hercules Color Card 145 Graphics Card 175 Graphic Card Plus 185 Intel All Above Boards Call Paradise Autoswitch 350 299 Autoswitch 480 355 5 Pack 99 Plus Development Plus Hard Card 20 Megabyte Quadran 609 Quad EGA Plus 295 Tecmar EGA Prosync 335 Graphics Master 409 Captain (No Memory) 109 Video-7 Vega Deluxe 315 Enhanced Graphic Adaptor 279 Anchor Automation Anchor Express \$ 185 Hayes All Models Call Prometheus 1200B w/Software 129 US Robotics Password 1200 149 Courier 2400 335 MicroLink 2400 335			

WORD PROCESSORS	SPREADSHEETS	DATA BASE MANAGEMENT	UTILITIES	PROJECT MANAGEMENT	LANGUAGES
Leading Edge Word Processor \$ 19 Leading Edge W/P with Spell & Merg 32 Microsoft Word 3.11 175 Multimate Advantage 255 PFS: Professional Write 89 Volkswriter 3 136 Volkswriter Deluxe Plus 59 Webster New World Writer 73 Word Perfect (Ver. 4.2) 195 Wordstar w/Tutor 3.1 162 Wordstar Pro Pack 3.31 233 Wordstar 2000 2.0 233 Wordstar 2000 Plus 2.0 278 Dollars & Sense w/Forecast \$ 92 Tobias Managing Your Money 105 DESKTOP PUBLISHING Click Art Personal Publisher 59 Harvard Professional Publisher 369 Newsmaster \$ 48 Ventura Publishing 529 DISKETTES Maxell MD-2 (Qty 100) \$250 Maxell MD-2HP (Qty 100) 185 Maxell MD5 (Qty 100) \$ 85 Sony MD-2 (Qty 100) 85 Sony 3 1/2 (Qty 100) 107.50 Sony 5 1/4 80 COMMUNICATIONS CompuServe Starter Kit \$ 19 CrossTalk XV1 88 Microsoft Access 137 Mirror 38 Remote 88 Smartcom II 79 INTEGRATIVE SOFTWARE Ability \$ 55 Enable 2.0 329 Framework II 395 PFS: 1st Choice 82 Smart Software System 3.1 409 Symphony 449 GRAPHICS/MICE Harvard Presentation Graphics 179 IMSI Mouse (PC Mouse) w/Dr. Halo II \$ 92 Microsoft Buss Mouse 6.0 103 Microsoft Chart 163 Microsoft Serial Mouse 6.0 115 PC Buss Plus Mouse (New Ver.) 99 PC Mouse (New Ver.) 89 HAL \$104 Lotus 1-2-3 Ver. 2.01 Call Multiplan 3.0 108 Supercalc 4 Call Twin 35 wP Planner 47 BROOKLYN BRIDGE dBase III Plus 399 DB-XL 82 Paradox Special Price PFS: Professional File Call Revelation 449 R-Base 5000 System V 359 BROOKLYN BRIDGE Carousel 2.0 \$ 29 Disk Optimizer 2.0 29 Double DOS 4.0 25 Fastback 84 Homebase 2.5 40 Microsoft Windows 55 Norton Utilities 4.0 48 Note It 58 PC Tools 19 Sidekick (Unprotected) 45 HARVARD TOTAL PROJECT MANAGER II Harvard Total Project Manager II 282 Microsoft Project \$219 Super Project 269 Timeline 2.0 235 BASIC COMPILER (Microsoft) \$219 C Compiler (Microsoft) 249 Cobol Compiler (Microsoft) 385 Fortran Compiler (Microsoft) 4.0 249 Genifer 188 Lattice C Compiler 236 Macro Assembler (Microsoft) 83 Run C Interpreter 65 Ryan McFarlan Fortran 339 Ryan McFarlan Cobol 539 Pascal Compiler (Microsoft) 163 Quick Basic 2 55 Turbo Jumbo Pack (New Ver.) 159 Microsoft Pascal w/B087 & BCD 55 Turbo Proflog 54 Turbo Database Tool Box 38					

NO CHARGE FOR VISA AND MASTERCARD
 • You Pay the Ground Shipping - We Pay the Air
 • Ground Shipping & Handling \$6.00
 • Free Air Applies ONLY to orders up to 10 lbs. & Over \$50.
 • All products carry a manufacturer's warranty. All Guarantees, rebates, trial period privileges & promotional programs are handled by the manufacturer only.

• No APO, FPO, or international orders, please.
 • Personal and Company Checks Will Delay Shipping 3 Weeks.
 • Prices, Terms and Availability Subject to Change without Notice.
 • Add 3% for C.O.D. Orders.
 • All Sales Are Final
 • We Do Not Guarantee Machine Compatibility

Mailing Address: 2034 West Southern / Mesa, Arizona 85202
 • Order Line Hours: Mon-Fri 8:30 a.m.-5:30 p.m.
 Saturday 9:00 a.m.-1:00 p.m.
 • Order Processing: (602) 461-0020 / Mon-Fri 10:00 a.m.-3:00 p.m.

Announcing the world's
largest 3.5 inch diskette.



3M

3.5, DS, HD

double side
high density
2.0 MB

Other 3.5 inch diskettes can store up to 1 megabyte of information.

3M's new 3.5 inch diskette can store up to 2 megabytes of information. Nobody needs a computer to figure that's twice the capacity.

But it's one thing to announce something this big. It's another to have it available. And that's the one thing you can take for

granted when you deal with 3M.

We're the world's largest supplier of magnetic media. From standard and high-density 5¼ inch floppies to 1 MB and now our new 2 MB diskettes.

Just remember when you order our 2 MB, there's twice as much room on it. Which means you might not need quite as many.



©3M 1987
Inquiry 3

3M



COMPUTEREYES™



Capture Video Images on Your Personal Computer

Now you can easily and inexpensively acquire images from any standard video source – videotape, camera, disk – for display on your Apple, IBM, Commodore, Atari, or Atari ST computer.

ComputerEyes has everything you need: Interface hardware, complete easy-to-use software support on disk, and owner's manual. And it's fully compatible with most of the popular graphics programs. Think of the possibilities!

Prices start at only \$129.95 (monochrome for Apple II series, Commodore, Atari) to \$249.95 (Atari ST color, Apple IIs color, IBM monochrome). Call or write for exact model/price, demo disk, and information on a package complete with camera.

ComputerEyes is backed by a one year warranty and the success of over 10,000 systems sold. Satisfaction guaranteed or return it within ten days for full refund. Demo disk available, \$3. See your dealer or order direct.

For more information call 617-329-5400.

To order call 800-346-0090 or mail your order to: Digital Vision, Inc. 66 Eastern Avenue, Dedham, MA 02026 VISA, M/C, or COD accepted. S&H: \$4 for ComputerEyes. Mass. residents add 5% sales tax.

DIGITAL VISION

NEW!

2 MEGABYTE MODEL AVAILABLE SOON!



THE 3.5" CONNECTION!

This internal 720K 3.5" disk drive is a "drop-in" replacement for 5.25" drives! It's the ideal solution for exchanging data between your PC/XT/AT and the new generation of laptops. Disk format is compatible with IBM, Toshiba and Zenith portables. The Model 853W drive kit contains everything you need, including interface adapters, premium SONY drive, and complete documentation. Uses your existing disk controller (no additional slots required). Requires DOS 3.2 for maximum performance. Ask about our special prices on SONY DISKS!

**SONY DISKS
\$\$ SAVE \$\$**



**\$159.95
+ FRT. & TAX**



2734-C Johnson Drive
P.O. Box 3717
Ventura, CA 93006



IMMEDIATE DELIVERY!

Call 805-658-7466 or 805-658-7467

In both PL/I and Ada, the size and complexity of the languages go to the limits of the user's intellectual control. These languages, which were designed by what amounts to very large committees, may be compared to languages that were designed by individuals or small committees, for example Algol 60, Algol 68, Pascal, and APL. Although they may have other problems, they do not suffer to the same degree from complexity due to absolute size.

Marcotty and Ledgard admonish the designer to build around a minimum of concepts and a readable syntax. And, as is now axiomatic, a language with extensible data types (such as Modula-2) can be much simpler yet more powerful than one in which all types are predefined, such as PL/I.

This concluding chapter presents the overall view of language design that naturally follows from the detailed analysis that preceded it. For newcomers, it is the fitting culmination of an introductory tour, while the more experienced will find it a hidden chestnut at the end of the trip through the familiar territory of programming languages.

Joel West (P.O. Box 2733, Vista, CA 92083) is a writer, programmer, and consultant who dabbles in language design.

THE INGRES PAPERS: ANATOMY OF A RELATIONAL DATABASE SYSTEM *Reviewed by Haim Kilov*

It's hard to find a large commercial database management system whose authors can frankly assess their design and development decisions. INGRES is such a DBMS, and *The INGRES Papers* is a collection of 22 papers selected and edited by its founding father, Michael Stonebraker. The papers are reprinted from various journals and conference proceedings, and two of them seem to have been written especially for this book.

Stonebraker's short introductions both to the book and to each of its six sections provide an interesting and instructive view on corresponding aspects of the system. The reader should note that INGRES is a living and developing organism; new papers on further developments continue to appear.

The papers included in this collection address various theoretical and practical aspects of the design and development of a large relational DBMS. They are usually very well written; the authors never present the material as highbrow mathematics, though the papers do use and at times create theoretically important results. The reader should have a basic knowledge of relational DBMSs, and a certain computing maturity is also desirable.

Technical Superiority

The book includes three papers on the evolution of INGRES from a University of California at Berkeley prototype to a famous commercial system (Stonebraker was one of the creators of Relational Technology Inc., a company in Alameda, California, that has turned INGRES into a product). Not having the support of a large established company, the developers had to base the success of their product on technical superiority.

It is interesting to note that the INGRES project has always been organized as a chief programmer team. All members of these teams—except the chief programmers—were students, and all of them, as well as the chief programmers, are listed in the editor's preface. There are some famous names in the list.

continued

THE BEST PRICE PERFORMANCE CADD PROGRAM ON THE MARKET TODAY JUST GOT BETTER!



Introducing Generic CADD 3.0™
Faster than a speeding pencil!

PC WEEK says Generic CADD: "strongly rivals some of the best mid-range CAD packages that cost thousands of dollars."

And now it's even better! Generic CADD 3.0™, still only \$99.95, is faster, cleaner and prettier. Generic CADD 3.0 is now up to 20% faster on redraws, has user definable line widths, named views, the ability to "unerase" erasures and dozens of additional features!

Inquiry 117 for End-Users. Inquiry 118 for DEALERS ONLY.

Generic CADD is showing up virtually everywhere. Combined with our productivity modules, Generic CADD 3.0 gives engineers, designers and drafters sophisticated CAD power on their personal computer.

Tradespeople use Generic CADD to make plans and change plans. Schools and Universities are using Generic CADD to change the way their students learn.

Business users have found out that Generic CADD offers the same kind of power over their business graphics that

spreadsheet programs give them with numbers!

Where else can you get so much productivity for so little money?

Call 800-228-3601 or 206-885-5307 for dealer nearest you.

For updates of Generic CADD 2.0 or LogiCADD 2.0, call: 800-345-9194.

Generic CADD 3.0™ Not copy protected. 60-day money back guarantee. ■

Generic

S O F T W A R E

JUNE 1987 • BYTE 91

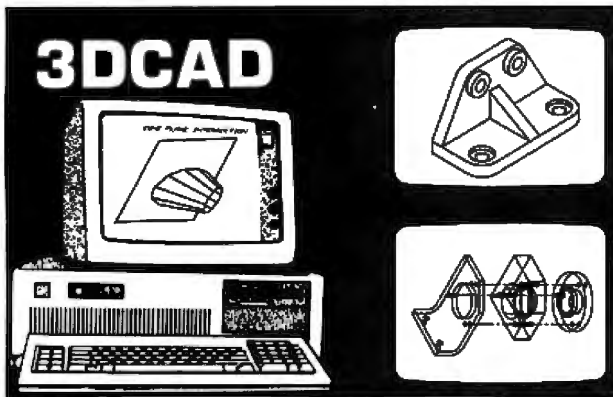

3DCAD allows you to
Build True 3-Dimensional Geometry
 on your IBM personal computer.

- Build Geometry on working plane or in unrestricted 3-D
- Automatic Hidden Line removal
- Modify, Save, and Combine 3-D models with other models
- Seven standard views plus user defined rotations allow viewing from any angle
- Interface geometry to other programs via formatted files
- 256 levels, true 3-D intersections, automatic dimensioning

\$349

CADSOFT SYSTEMS / P.O. Box 90056
 Indianapolis, IN 46290 / (317) 844-7127

Unlike papers on other commercial systems, *The INGRES Papers* discuss at length not only successes but failures and demonstrate lessons learned during the development of the system. Because the authors' approach is always open and sincere, it is clear that their goal was to create a powerful but simple and usable (rather than deliberately complex) system. They have succeeded.

The reader should take into account that INGRES is a full-function relational database management system rather than a flat-file system or a relational interface to a navigational system, too many of which are now proudly proclaimed as "relational." I agree with the authors' note: "We overestimated the ability of others to build relational systems and bring them to market."

Reevaluating Steps

One whole section discusses traditional aspects of DBMS design and implementation. Of interest here is the observation that the services of a very good general-purpose operating system (Unix) are often inadequate. Instead of their "not quite right" service to a comparable applications-specific one, a "mini-OS" runs in user space.

On a higher level, the authors provide convincing evidence that some common beliefs concerning DBMS performance enhancements were just wrong. On a still higher level, it can be seen that query-processing algorithms, however important, are not the main aspect of a relational DBMS. In particular, the corresponding algorithms in "university INGRES" had some drawbacks, but even the systems based on these algorithms were successful (the current commercial INGRES uses a rewritten query optimizer).

The distributed INGRES is discussed in full. Though it is a very interesting project that more or less works, its success was limited by software engineering issues: It was impossible to succeed simultaneously in three areas—application code (distributed INGRES itself), OS code (networking), and obtaining prototype (Ethernet) hardware. As the authors correctly note, smaller steps were needed.

Historical Interfacing

The story of user interfaces ranging from traditional embedding of the relational data sublanguage (QUEL), into a general-purpose programming language (C), and up to more recent and very interesting developments is told. As "it was clear to everyone that ordinary mortals did not want to use QUEL for data manipulation," more convenient means were designed and implemented.

One of the best interfaces was designed through the use of forms—taking into account that a typical database-oriented program is at least 60 percent composed of code to manipulate the screen. In many user interface aspects, the designers of INGRES have done a pioneering job unusual for the development of a commercial system.

Another important example brought forth in the book is RIGEL, a general-purpose language designed for developing database applications; note that the paper corresponding to that topic was published in 1979. RIGEL provides the (Modula-2-like) module facility for definition and use of high-level abstract database operations (like AssignProf and AddStudent) instead of low-level ones (e.g., insert, delete, and update). These high-level operations enforce the semantic integrity in a very natural manner.

Also of interest and importance is the wide use of generators in RIGEL. These aspects provide a good, but not the only, example of DBMS design as a fruitful field for integrating different important computing concepts.

continued

Laptop Users:
"This thing is fabulous"
 John C. Dvorak*

We couldn't agree more with John Dvorak, and couldn't have said it better: "Buy the Brooklyn Bridge from White Crane Systems.... It's a combination cable and software package that hooks the Toshiba or Zenith (and other MS-DOS laptops) to your PC, XT or AT via the serial port and allows you full access to all the disk drives of both machines for effortless file transfer (at 115K bits per second).... Installation is a snap. It works first time out, no glitches. It's transparent. It's great. And since it's priced at \$129.95, it would be silly to buy an add-on drive for your MS-DOS laptop.



**WHITE CRANE
 SYSTEMS**

404-454-7911

Suite 151

6889 Peachtree Ind.
 Boulevard

Norcross, Georgia

30092

"Call the company at (404)454-7911 or write them at White Crane Systems, 6889 Peachtree Industrial Boulevard (Suite 151), Norcross, GA 30092. My highest recommendation."

* Reprinted from PC Magazine
 February 10, 1987
 Copyright 1987 Ziff
 Communications Company



Inquiry 336 for End-Users.
Inquiry 337 for DEALERS ONLY.

E=M C AZTEC

Our thanks to NASA for supplying this computer enhanced ultraviolet photo taken by Skylab IV of a solar prominence reaching out 350,000 miles above the sun's surface

Genius Begins With A Great Idea ...

But The Idea Is Just The Beginning

What follows is the time consuming task of giving form and function to the idea. That's why we concentrate on building into our software development systems functions and features that help you develop your software ideas in less time and with less effort. We've started 1987 by releasing new versions of our MS-DOS, Macintosh, Amiga, ROM, and Apple II C development systems. Each system is packed with new features, impressive performance, and a little bit more genius.

Aztec C86 4.1

New PC/MS-DOS • CP/M-86 • ROM

Superior performance, a powerful new array of features and utilities, and pricing that is unmatched make the new Aztec C86 the first choice of serious software developers.

Aztec C86-p Professional System . . . \$199

• optimized C with near, far, huge, small, and large memory + Inline assembler + Inline 8087/80287 + ANSI support + Fast Float (32 bit) + optimization options • Manx Aztec 8086/80x86 macro assembler • Aztec overlay linker (large/small model) • source level debugger • object librarian • 3.x file sharing & locking • comprehensive libraries of UNIX, DOS, Screen, Graphics, and special run time routines.

Aztec C86-d Developer System . . . \$299

• includes all of Aztec C86-p • Unix utilities make, diff, grep • vi editor • 6+ memory models • Profiler.

Aztec C86-c Commercial System . . . \$499

• includes all of Aztec C86-d • Source for library routines • ROM Support • CP/M-86 support • One year of updates.

Aztec C86 Third Party Software

A large array of support software is available for Aztec C86. Call or write for information. The following is a list of the most requested products: Essential Graphics • C Essentials • C Utility Library • Greenleaf Com. • Greenleaf General • Halo • Panel • PC-lint • PforCe • Pre-C • Windows for C • Windows for Data C terp • db Vista • Phact • Plink86Plus • C-tree.

CP/M • TRS-80 • 8080/Z80 ROM

C compiler, 8080/Z80 assembler, linker, librarian, UNIX libraries, and specialized utilities.

Aztec C II-c (CP/M-80 & ROM) \$349

Aztec CII-d (CP/M-80) \$199

Aztec C80 (TRS-80 3&4) \$199

Aztec C68k/Am 3.4

New Amiga Release

Amiga user groups across the USA voted Aztec C68k/Am release 3.3 the best Software Development System for the Amiga. Release 3.4 is more impressive.

Aztec C68k/Am-p Professional \$199

A price/feature/performance miracle. System includes: optimized C • 68000/680x0 assembler • 68881 support • overlay linker • UNIX and Amiga libraries • examples.

Aztec C68k/Am-d Developer \$299

The best of Manx, Amiga, and UNIX. System includes: all of Aztec C68k/Am-p • the Unix utilities make, diff, grep and vi.

Aztec C68k/Am-c Commercial \$499

Aztec C68k/Am-d plus source for the libraries and one year of updates.

Aztec C68k/Mac 3.4

New Macintosh Release

For code quality, reliability, and solid professional features, Aztec C for the Macintosh is unbeatable. This new release includes features and functions not found in any other Macintosh C development system.

Aztec C68k/Mac-p Professional \$199

• optimized C • 68000/680x0 assembler • 68881 support • overlay linker • UNIX and Macintosh libraries • examples.

Aztec C68k/Mac-d Developer \$299

The best of Manx, Macintosh, and UNIX. System includes: all of Aztec C68k/Am-p • the Unix utilities make, diff, grep • vi editor.

Aztec C68k/Mac-c Commercial \$499

Aztec C68k/Am-d plus source for the libraries and one year of updates.

Aztec C65

New ProDOS Release

Aztec C65 is the only commercial quality C compiler for the Apple II. Aztec C65 includes C compiler, 6502/65C02 assembler, linker, library utility, UNIX libraries, special purpose libraries, shell development environment, and more. An impressive system.

Aztec C65-c Commercial \$299

• runs under ProDOS • code for ProDOS or DOS 3.3

Aztec C65-d Developer \$199

• runs under DOS 3.3 • code for DOS 3.3

Aztec ROM Systems

6502/65C02 • 8080/Z80 • 8086/80x86 • 680x0

An IBM or Macintosh is not only a less expensive way to develop ROM code, it's better. Targets include the 6502/65C02, 8080/Z80, 8086/80x86, and 680x0.

Aztec C has an excellent reputation for producing compact high performance code. Our systems for under \$1,000 outperform systems priced at over \$10,000.

Initial Host Plus Target \$750

Additional Targets \$500

ROM Support Package \$500

Vax, Sun, PDP-11 ROM HOSTS

Call for information on Vax, PDP-11, Sun and other host environments.

C' Prime

PC/MS-DOS • Macintosh
Apple II • TRS-80 • CP/M

These C development systems are unbeatable for the price. They are earlier versions of Aztec C that originally sold for as much as \$500. Each system includes C compiler, assembler, linker, librarian, UNIX routines, and more. Special discounts are available for use as course material.

C' Prime \$75

Aztec Cross Development Systems

Most Aztec C systems are available as cross development systems. Hosts include: PC/MS-DOS, Macintosh, CP/M, Vax, PDP-11, Sun, and others. Call for information and pricing.

How To Become An Aztec C User

To become a user call 800-221-0440. From NJ or international locations call 201-542-2121. Telex: 4995812 or FAX: 201-542-8386. C.O.D., VISA, MasterCard, American Express, wire (domestic and international), and terms are available. One and two day delivery available for all domestic and most international destinations.

Aztec C is available directly from Manx and from technically oriented computer and software stores. Aztec Systems bought directly from Manx have a 30 day satisfaction guarantee.

Most systems are upgradeable by paying the difference in price plus \$10. Site licenses, OEM, educational, and multiple copy discounts are available.

To order or for more information call today.

1-800-221-0440

In NJ or international call (201) 542-2121 • TELEX: 4995812



Inquiry 174

Manx Software Systems

1 Industrial Way, Eatontown, NJ 07724

MS is a registered TM of Microsoft, Inc. CP/M TM DRI, HALO TM Media Cybernetics, PANEL TM Roundhill Computer Systems, Ltd., PHACT TM PHACT Assoc., PHE-C, Plink-86, Plink-86 +, P-Force TM Phoenix, db Vista TM Rama Corp., C-terp, PC-lint, TM Gmpel Software, C-tree TM Faircom, Inc., Windows for C, Windows for DATA TM Creative Solutions, Apple II, Macintosh TM Apple, Inc., TRS-80 TM Radio Shack, Amiga TM Commodore Int'l., Unix TM AT&T, Vax TM DEC, Aztec TM Manx Software Systems

Protect Your Private Parts.



At Rainbow Technologies, we think protecting software developers' investments is very serious business. That's why we designed the first fully effective security solution for software running on PCs and other computers.

Our family of virtually impenetrable Software Sentinel hardware keys provides the highest level of software protection the developer can get. While remaining invisible to the end user.

Take a look.

Key Sentinel Family Features.

Prohibits unauthorized use of software □ No need for copy protection □ Unlimited backup copies □ Virtually unbreakable □ Pocketsize key □ Transparent operation □ Transportable

Software Sentinel.

- Algorithm technique (Never a fixed response)
- Serial or parallel port version
- Minimal implementation effort
- Higher level language interfaces included
- 100 times faster than fixed-response devices (1ms)
- Runs under DOS and Xenix, on IBM PC/XT/AT and compatibles

Software Sentinel-C.

- For developers who want to customize or protect multiple packages with one device
- 126 bytes of non-volatile memory that is programmed before shipment of software
- We supply a unique programming adapter for programming the unit
- Higher level language interfaces included
- Runs under DOS on PC/XT/AT and compatibles
- Parallel port version only

Software Sentinel-W.

- Designed for workstations, supermicros and minicomputers
- Serial port only (modem-type)
- Algorithm technique
- We provide detailed interface specifications: Developer creates a port driver
- Interface requirements: 25 pin DB25P or DB25S; RS232/RS422/RS423
- Only signals used: DTR & RTS from computer; signal ground; DSR or optional DCD from Software Sentinel-W or external device. TXD, RXD, CTS, RI passed through.

Call For Software Sentinel Evaluation Kit Pricing.

For more information on the Software Sentinel family, contact

 **RAINBOW**
TECHNOLOGIES, INC.

17971-E Skypark Circle
Irvine, CA 92714
or call (714) 261-0228

New-Generation Applications

Nontraditional database applications are also considered at length. Stonebraker notes that corresponding extensions to the relational model should be of "great power at very small cost in intellectual complexity," an admirable goal. Some great discoveries in computing (like the relational model itself) can be characterized in such a manner. It is well known that the problem with older, and even some newer, database systems is excessive complexity.

The authors show paths to new-generation DBMSs and implement them by extending an existing commercial system. Of special merit are the use of abstract data types for domains and extending the DBMS with long free-format text document processing facilities. Work in these areas is flourishing in the database community, and the decisions made and implemented by INGRES's authors are both simple and elegant.

New Designs

The issue of assuring semantic integrity through the use of P. Chen's entity-relationship (ER) model in database design and with interesting ways of access path design is a large part of this last section. A semantically correct database schema can be designed at once in a simple top-down manner if we use the ER concepts instead of creating first a more or less arbitrary collection of relations and then normalizing them.

Formal normalization is not a very natural process; it's like writing a structured program by formally and syntactically eliminating goto from an unstructured one. In both cases, a program and a schema should be semantically correct from the beginning; in both cases the creation of a correct object is much simpler. The interested reader can read the variety of papers on normalization and normal forms that seem to have had little impact on actual database design. A new normal form, to quote Stonebraker, is the thing least needed by a database community.

A Coherent Whole

Each of the papers except one was coauthored by the INGRES project leaders. As a result, the papers have some overlap, but they do constitute a coherent whole. The reader should be cautious with respect to papers published in 1975 and 1976, as they contain "naive comments" carefully noted by Stonebraker in his section introductions. Not noted in such a manner is the use of the term "domain" instead of "attribute" in several of these papers. These two terms should be clearly distinguished; they are used properly only in papers published in 1981 and later. I disagree with the statement that existing systems do not support sophisticated domain definition; at least one system that I co-authored does this support, at least partially (see *SIGMOD Record*, volume 13, number 2, 1983, page 64).

The INGRES Papers presents important and diverse aspects of DBMS design and development, including software engineering issues connected with a large project. The authors sincerely present the lessons they learned. Their experience will be useful not only for DBMS designers and sophisticated users, but also for large project developers. The book can best be used as supplementary reading in a DBMS course.

For readers of *BYTE* who too often encounter claims of a DBMS being relational and who are really interested in databases, this well-written book offers a splendid opportunity to get acquainted with various aspects of a full-function relational DBMS on its way to being a new-generation one. ■

Haim Kilov (Karl Marx St. 75-13, Riga 11, U.S.S.R.) is involved in both the design and implementation of relational database management systems and computer science education. His papers and reviews have been published in the U.S.S.R. and in the U.S.

TEST EQUIPMENT THAT MEASURES UP TO YOUR SPECIFICATIONS



DMM-300 \$79.95
3.5 DIGIT DMM / MULTITESTER

Our best model. A highly accurate, full function DMM loaded with many extra features. Audible continuity, capacitance, transistor, temperature and conductance all in one hand-held meter. Temperature probe, test leads and battery included.

- * Basic DC accuracy: plus or minus 0.25%
- * DC voltage: 200mv — 1000v, 5 ranges
- * AC voltage: 200mv — 750v, 5 ranges
- * Resistance: 200 ohms — 20M ohms, 6 ranges
- * AC/DC current: 200uA — 10A, 6 ranges
- * Capacitance: 2000pf — 20uf, 3 ranges
- * Transistor tester: hFE test, NPN, PNP
- * Temperature tester: 0° — 2000° F
- * Conductance: 200ns
- * Fully over-load protected
- * Input impedance: 10M ohm



DMM-200 \$49.95
3.5 DIGIT FULL FUNCTION DMM

High accuracy, 20 amp current capability and many range settings make this model ideal for serious bench or field work. Tilt stand for hands-free operation. 2000 hour battery life with standard 9v cell. Probes and battery included.

- * Basic DC accuracy: plus or minus 0.25%
- * DC voltage: 200mv — 1000v, 5 ranges
- * AC voltage: 200mv — 750v, 5 ranges
- * Resistance: 200 ohms — 20M ohms, 6 ranges
- * AC/DC current: 200uA — 20A, 6 ranges
- * Fully over-load protected
- * Input impedance: 10M ohm
- * 180 x 86 x 37mm, weighs 320 grams



DMM-700 \$49.95
3.5 DIGIT AUTORANGING DMM

Autorange convenience or fully manual operation. Selectable LO OHM mode permits accurate in-circuit resistance measurements involving semi-conductor junctions. MEM mode for measurements relative to a specific reading. Probes and battery included.

- * Basic DC accuracy: plus or minus 0.5%
- * DC voltage: 200mv — 1000v, autoranging or 5 manual ranges
- * AC voltage: 2v — 750v, autoranging or 4 manual ranges
- * Resistance: 200 ohms — 20M ohms, autoranging
- * AC/DC current: 20mA — 10A, 2 ranges
- * Fully over-load protected
- * Audible continuity tester
- * Input impedance: 10M ohm
- * 150 x 75 x 34mm, weighs 230 grams



DMM-100 \$29.95
3.5 DIGIT POCKET SIZE DMM

Shirt-pocket portability with no compromise in features or accuracy. Large, easy to read .5" LCD display. 2000 hour battery life with standard 9v cell provides over two years of average use. Probes and battery included.

- * Basic DC accuracy: plus or minus 0.5%
- * DC voltage: 2v — 1000v, 4 ranges
- * AC voltage: 200v — 750v, 2 ranges
- * Resistance: 2k ohms — 2M ohms, 4 ranges
- * DC current: 2mA — 2A, 4 ranges
- * Fully over-load protected
- * Input impedance: 10M ohm
- * 130 x 75 x 28mm, weighs 195 grams



MODEL 2000 \$349.95
20 MHz DUAL TRACE OSCILLOSCOPE

Model 2000 combines useful features and exacting quality. Frequency calculation and phase measurement are quick and easy in the X-Y Mode. Service technicians will appreciate the TV Sync circuitry for viewing TV-V and TV-H as well as accurate synchronization of the Video Signal, Blanking Pedestals, VITS and Verticle/Horizontal sync pulses.

- * Lab quality compensated 10X probes included
- * Built-in component tester
- * 110/220 Volt operation
- * X-Y operation * Bright 5" CRT * TV Sync filter



MODEL 3500 \$499.95
35 MHz DUAL TRACE OSCILLOSCOPE

Wide bandwidth and exceptional 1mV/DIV sensitivity make the Model 3500 a powerful diagnostic tool for engineers or technicians. Delayed triggering allows any portion of a waveform to be isolated and expanded for closer inspection. Variable Holdoff makes possible the stable viewing of complex waveforms.

- * Lab quality compensated 10X probes included
- * Delayed and single sweep modes
- * Z Axis intensity modulation
- * X-Y operation * Bright 5" CRT * TV Sync filter



DPM-1000 \$54.95
3.5 DIGIT PROBE TYPE DMM

Autoranging, pen style design for the ultimate in portability and ease of use. Custom 80 pin LSI chip increases reliability. Audible continuity tester and data hold feature for added convenience. Case, test leads and batteries included.

- * Basic DC accuracy: plus or minus 1%
- * DC voltage: 2v — 500v, autoranging
- * AC voltage: 2v — 500v, autoranging
- * Resistance: 2k ohms — 2M ohms, autoranging
- * Fully over-load protected
- * Input impedance: 11M ohm
- * 162 x 28 x 17mm, weighs 75 grams

2 YEAR WARRANTY ON ALL MODELS



JDR INSTRUMENTS

110 Knowles Drive, Los Gatos, CA 95030

(408) 866-6200 • FAX (408) 378-8927 • Telex 171-110

ORDER TOLL FREE 800-538-5000

OR VISIT OUR RETAIL STORE

1256 SOUTH BASCOM AVE.

SAN JOSE, CA. (408) 947-8881

Gold Hill delivers GoldWorks.™



GoldWorks.

DESIGNED FOR EXPERT SYSTEM DEVELOPMENT AND DELIVERY

GOLD HILL

Now you can build and deliver serious expert systems on advanced PCs.

GoldWorks changes the economics of expert system building.

GoldWorks, formerly code-named Acorn, is designed for professional software developers who need to build serious expert systems and integrate them with conventional applications running on 286- and 386-based PCs. It combines the best features of high-end expert system tools with the ability to develop and deliver expert systems *inexpensively*, on advanced PCs.

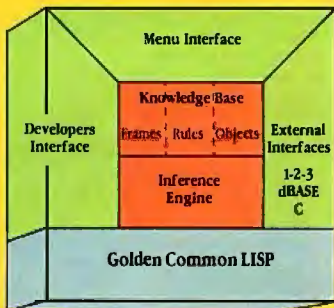

GoldWorks is the most comprehensive expert system tool available for advanced PCs.

Works like a shell.

GoldWorks gives you the best features of an expert system shell. With the easy-to-use menu interface, you can rapidly prototype and build expert system applications without knowing the underlying programming environment. And you get the GoldWorks tutorial, the San Marco LISP Explorer® tutorial, an on-line help system, and example applications to get you started quickly.

Works like a toolkit.

GoldWorks gives you the best features of an expert system toolkit. You can access the underlying pro-

gramming environment to extend and customize the system for your specific applications. And you can address up to 15 MB of extended memory on the PC AT (and even more on 386-based PCs).

Works like expert system tools previously available only on high-end workstations . . . at a fraction of the cost.

GoldWorks sets a new standard for expert system development and delivery on advanced PCs. You get frames with multiple inheritance for flexible knowledge representation. Rules supporting integrated forward and backward chaining for powerful inferencing. Object programming for developing modular applications. Plus advanced features for controlling the inferencing process, including rule sets, sponsors, rule priorities, certainty factors, and extensive rule inspecting and debugging facilities. All on conventional hardware—the PC you already use.

Works to develop and deliver your expert systems.

GoldWorks is the only tool that lets you develop and deliver serious expert systems on PC ATs. And GoldWorks also takes advantage of PCs based on Intel's powerful 80386 processor, including the COMPAQ DESKPRO 386 and Gold Hill's 386 LISP System.

Works to integrate expert systems with conventional PC applications.

With GoldWorks, you can integrate expert system applications with dBASE III and Lotus 1-2-3 . . . integrate C routines and libraries into your expert systems . . . and build and deliver expert systems in network environments.

Works the way you want an expert system builder to work.

GoldWorks from Gold Hill sets the standard by which all other expert system tools will be measured. It was extensively field-tested by developers in dozens of major corporations. And GoldWorks is backed by Gold Hill's comprehensive customer support, training and consulting programs.

Now you have the expert system builder that works the way *you* want to work—GoldWorks. To see how it works, order our unique Demonstration Kit, including full color video and complete User's Guide. It's only \$49 postpaid, refundable with your GoldWorks purchase. To order, call toll-free:

1-800-242-5477.

In Mass., call (617) 492-2071.

GoldWorks from Gold Hill. The expert in AI on PCs.

Gold Hill Computers, Inc.
163 Harvard Street
Cambridge, MA 02139



© Copyright 1987, Gold Hill Computers, Inc. Gold Hill, GoldWorks, GCLISP, and 386 LISP System are trademarks of Gold Hill Computers, Inc. San Marco LISP Explorer is a registered trademark of San Marco Associates. Lotus is a registered trademark and 1-2-3 is a trademark of Lotus Development Corporation. dBASE is a trademark of Ashton-Tate. IBM and IBM PC-AT are registered trademarks of International Business Machines Corporation. Intel is a registered trademark and 80286 and 80386 are trademarks of Intel Corporation. COMPAQ and DESKPRO 386 are trademarks of COMPAQ Computer Corporation.

POWER PLAY



In addition to our full line of XT and AT compatible boards, Turn-Point America is pleased to introduce a range of products for use in developing multiuser systems. Whether you are interested in a Local Area Network or a Time-sharing system, Turn-point can supply all your needs.

a. Baby AT Motherboard \$465.00

- 100% IBM AT compatible
- 10 Mhz with Zero wait states
- XT size board and mounting holes
- Serial port on board
- Setup programs included

b. Ram-Master AT Multi-function w/0k \$175.00

- Up to 3.5 Mb of expansion memory for AT
- Up to 4 serial ports (1 installed)
- 1 Parallel printer port
- 1 Game adapter port
- Ideal for multi-user applications

c. Ram-Master Plus Multi-function w/0k 150.00

- All features of basic Ram-Master
- Battery backed-up clock if using on XT
- 2 Serial ports
- 1 Parallel printer port
- 1 Game adapter port

d. Top-Net Local Area Network Board \$250.00

- 1 Mbit/sec data rate
- Up to 4000 ft. cable length
- Up to 64 Stations

Starter Kit: \$495.00

- 2 Network boards
- Complete software and manual
- 30 ft. twisted pair cable
- Optional IBM Network and Novell drivers
- Software allows any workstation to be a printer server
- System software includes extensive utilities
- System support for Telex server

e. Mighty Mo 1200 Baud Internal Modem \$79.00

- Full Bell and CCITT compatibility
- 100% Hayes command set compatibility
- Line quality monitoring and equalization
- Adaptive dialing
- Local/remote loop tests and self test

f. Ram-Master Extended Memory Board w/0k \$95.00

- Up to 2 Mb of expansion memory
- Full Lotus/Intel compatibility
- User configurable as conventional memory, extended memory or both
- Software included supports 8 mb on XT or AT

g. Multi I/O Plus for XT or AT \$130.00

- Up to 4 serial ports (1 installed)
- 1 Parallel printer port
- 1 Game adapter port
- 1.2 Mb/360k floppy controller
- Battery backed-up clock if using on XT

h. Accelerator 286 \$295.00

- 10 Mhz clock speed
- 80286 CPU
- 80287 support at 5 or 10 Mhz
- 8k of Zero wait state cache memory
- Switchable 8088 in system for compatibility

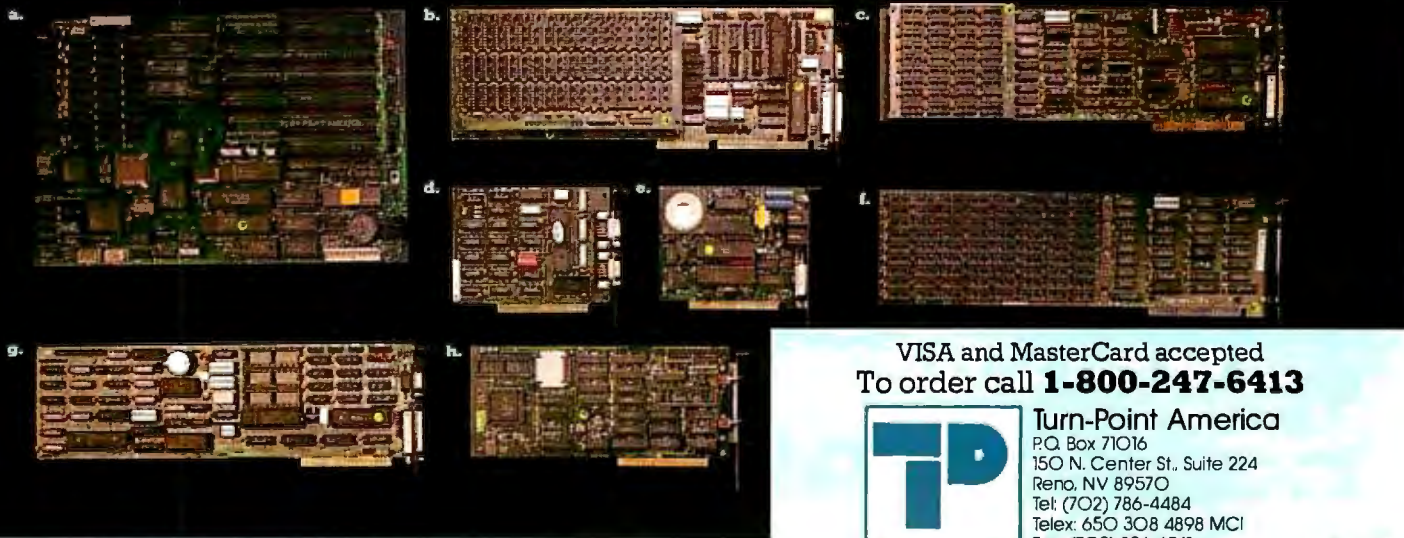

VISA and MasterCard accepted
To order call **1-800-247-6413**



Turn-Point America
P.O. Box 71016
150 N. Center St., Suite 224
Reno, NV 89570
Tel: (702) 786-4484
Telex: 650 308 4898 MCI
Fax: (702) 826-6741

Features

First Impressions:
The IBM PS/2 Computers 100
by the BYTE Editorial Staff

Product Description:
Microsoft's New DOS 116
by Eva White and Richard Grehan

Ciarcia's Circuit Cellar:
**Build a Gray-Scale
 Video Digitizer, Part 2** 129
by Steve Ciarcia

Programming Project:
A Contouring Subroutine 143
by Paul D. Bourke

Programming Insight:
Polynomial Curve Fitter 155
by William G. Hood

68000 Machines:
Atari 520ST Projects 161
by Tim G. Hunkler



FIRST IMPRESSIONS:

The IBM PS/2 Computers

The Personal System/2—including a 32/16-bit bus, new operating systems, and new graphics systems—redefines IBM's microcomputer standards



The timing was almost perfect: Just weeks after Apple launched the 68020-based Mac II, establishing a new standard that will dominate Apple products for some time to come, IBM announced an entire new line of personal computers (complete with a different bus and two new operating systems) that might similarly set the standard for 80x86-based systems.

IBM's Personal System/2 family includes a low-end 8086-based machine, two mid-range 80286 systems, and a 32-bit 80386-based system that is arguably one of the most powerful microcomputers yet. (See table 1.)

Unlike the previous line of IBM desktop PCs, all the new systems have: 3½-inch floppy disk drives (not a 5¼-inch floppy in the group, though you can add one externally), on-board graphics support, heavy use of custom logic chips and surface-mount technology, and a simple, modular assembly technique. IBM claims that, because of the modular construction, the new computers are three times more reliable than the previous IBM desktop machines. Service, when needed, will be simpler: with practice, you can assemble or disassemble the PS/2 machines in less than a minute.

Principal contributors to this article include (alphabetically) Richard Grehan, Philip Lemmons, Rich Malloy, Tom Thompson, Eva White, Gregg Williams, and Stanley Wszola. All are BYTE staff members.

The PS/2 systems feature colorful analog video displays and a keyboard that resembles the "enhanced" AT keyboard, except for three LED indicators for the three Shift-Lock keys. They can also use an optional two-button mouse (\$95), the first mouse ever offered by IBM.

Contrary to rumor, all the systems use off-the-shelf Intel microprocessors and do not appear to employ any extraordinary measures to dissuade imitators—although the complex custom gate arrays will give clone makers pause. IBM also will not publish the PS/2 BIOS listing or the circuit diagrams and electrical characteristics of the new gate arrays, but it will publish the entry points of the BIOS and the electrical signals on the new expansion slots.

Basic Hardware: The Model 30

The Personal System/2 Model 30 uses an 8086 microprocessor running at 8 MHz with no wait states. It comes with 640K bytes of memory and two 3½-inch floppy disk drives that store 720K bytes each. It also has three standard IBM PC-style expansion slots, which are mounted sideways in the machine to conserve space. Much of the circuitry formerly provided by expansion boards now resides on the motherboard: an improved version of the IBM Color Graphics Adapter (CGA), serial and parallel ports, a clock/calendar, and a floppy disk drive controller.

Because of the higher clock speed, a 16-bit-wide data path, and new support chips around the 8086, IBM says the Model 30 can perform at up to 2½ times the speed of a PC XT.

A two-floppy Model 30 costs \$1695; a version with a single floppy drive and a 20-megabyte hard disk costs \$2295. All you need to complete a Model 30 system are a monitor (\$250 to \$685) and version 3.3 of DOS (\$120).

Models 50, 60, and 80

The group of higher-end machines consists of the 80286-based Models 50 and 60 and the 80386-based Model 80. They have all the features of the Model 30, with three major differences: They use a proprietary bus called the Micro Channel, they have on-board support for a new graphics standard that is better than the Enhanced Graphics Adapter (EGA); and they use 1.44-megabyte floppy disk drives that can also read and write to the 720K byte floppies.

These systems also use a high-speed hard disk controller, with a 1:1 interleave factor (AT-class hard drives usually use a 3:1 interleave). This interleave factor is made possible in part by a "burst" mode in the bus that allows high-speed data transfers. Models 60 and 80 also have an ESDI (enhanced small device interface) adapter available for high-speed data transfer to a hard disk. With these features Models 60 and 80 have six times the data-transfer rate of the AT.

Models 50 and 60 are essentially the same machine; they differ primarily in size and storage capacity. Both use an 80286 running at 10 MHz and can support an optional 10-MHz 80287. Both computers come with a megabyte of memory and a 16-bit version of the Micro

continued

The IBM Personal System/2 Computers.
*From left to right,
the Models 80, 50, 30, 60.*



Channel bus. The Model 50, however, is a small-footprint desktop system with three open expansion slots, while the Model 60 is a larger, floor-standing "deskside" system with seven available expansion slots.

The Model 50 comes with a 20-megabyte hard disk and costs \$3595. The Model 60 is available in two versions: The Model 60-041 has a 44-megabyte drive and costs \$5295; the Model 60-071 includes a 70-megabyte hard disk and an ESDI for \$6295.

IBM estimates that with the faster clock speed, the new bus, and the faster drive controller, these systems will perform at over twice the speed of the AT.

The Model 80 is IBM's first 80386-based system. It uses a standard Intel B1-version 80386 CPU chip—the same chip used in the Compaq Deskpro 386. The Model 80, which will be available in

July, comes with 1 to 2 megabytes of memory (using 1-megabit chips) and a 32-bit version of the Micro Channel bus. It is a deskside system that resembles the Model 60 and, like the 60, it has seven expansion slots, three of which are for 32-bit boards. The Model 80-041 has a 44-megabyte hard disk and will sell for a base price of \$6995. The 80-071 has a 70-megabyte hard disk and a base price of \$8495. Both of these systems have a clock speed of 16 MHz. The third version of the Model 80, the 80-111, will have a clock speed of 20 MHz, 2 megabytes of memory, and a 115-megabyte hard disk. It will be available in the fourth quarter of this year for \$10,995. IBM estimates the performance of the Model 80 to be about 3½ times that of an AT.

The Model 80 will compete with Apple's powerful 32-bit Mac II, at least on the hardware level. However, the Mac

II's system software is already in place and available; OS/2, the major new operating system for the PS/2 family, might still be as much as a year away from release. See the text box "IBM PS/2 Model 80 vs. Mac II," which highlights some of the similarities and differences between the two machines.

New Video Standards

The PS/2 family uses three new video standards: the low-end Model 30 has an MCGA (multicolor graphics array) system; the Models 50, 60, and 80 have a VGA (video graphics array) system; and there is an optional high-resolution system called the 8514/A.

Model 30's MCGA system consists of two special gate arrays, 64K bytes of dual-ported RAM, a 16K-byte static RAM character generator, and custom

continued

The Model 80—IBM's first 80386-based system—will compete head-to-head with Apple's powerful 32-bit Macintosh II.



MODEL 80

Table 1: A summary of the characteristics of the IBM Personal System/2 computers, Models 30, 50, 60, and 80.

Model (notes 1,2)	Model 30-021 (8530-021)	Model 50-021 (8550-021)	Model 60-041 (8560-041)	Model 80-041 (8580-041)	Model 80-111 (8580-111)
Microprocessor	8086	80286	80286	80386	80386
Processor speed	8 MHz	10 MHz	10 MHz	16 MHz	20 MHz
Socket for which numeric coprocessor?	8087	80287	80287	80387	80387
Width of system-bus data path	16 bits	16 bits	16 bits	32 bits (note 12)	32 bits (note 12)
Standard RAM	640K bytes	1 megabyte	1 megabyte	1 megabyte (note 9)	2 megabytes
Maximum RAM	640K bytes (note 3)	7 megabytes	15 megabytes	16 megabytes	16 megabytes
Standard ROM	64K bytes	128K bytes	128K bytes	128K bytes	128K bytes
Total number of slots	3	4 (note 5)	8 (note 5)	8 (note 5)	8 (note 5)
Type of slots	IBM PC	Micro Channel	Micro Channel	Micro Channel	Micro Channel
Operating system(s) available	DOS 3.3	DOS 3.3, OS/2	DOS 3.3, OS/2	DOS 3.3, OS/2	DOS 3.3, OS/2
Standard floppy disk size and capacity	3½-inch, 720K (note 4)	3½-inch, 1.44 megabytes (note 6)	3½-inch, 1.44 megabytes (note 7)	3½-inch, 1.44 megabytes (note 7)	3½-inch, 1.44 megabytes (note 7)
Hard disk supplied	20 megabytes	20 megabytes	44 megabytes (notes 8 and 10)	44 megabytes (note 9)	115 megabytes (note 13)
Maximum hard disk capacity	(note 4)	20 megabytes	88 megabytes (note 11)	88 megabytes (note 10)	230 megabytes
Standard graphics modes	MCGA	VGA, EGA, MCGA	VGA, EGA, MCGA	VGA, EGA, MCGA	VGA, EGA, MCGA
Able to use 1024 by 768 IBM 8514 Color Display?	no	yes, with optional board using 1 slot	yes, with optional board using 1 slot	yes, with optional board using 1 slot	yes, with optional board using 1 slot
Location of main system unit	on desk	on desk	on floor, standing vertically	on floor, standing vertically	on floor, standing vertically
System price (note 14)	\$2295	\$3595	\$5295 (note 8)	\$6995 (note 9)	\$10,995
Availability	now	now	now	July 1987	4th quarter 1987
Major improvements over model to the left	N/A	80286, more memory, VGA, Micro Channel slots	more slots, more memory	80386, 32-bit slots	20-MHz clock, more RAM on motherboard

1. For details of the graphics modes, see the main text.

2. All the computers have their video circuitry, serial port, parallel port, pointing-device port, and time-of-day clock on the motherboard. They connect to an analog RGB or monochrome monitor. A two-button mouse is available but not required. All computers can interface to an IBM 200-megabyte optical disk drive (external for Models 30 and 50, internal or external for Models 60 and 80).

3. You can expand memory further by using plug-in boards that meet the Lotus/Microsoft/Intel memory-board specification.

4. Another version of the Model 30, the Model 30-002, has a second 3½-inch floppy disk drive in place of the 20-megabyte hard disk; it costs \$1695. Presumably, the Model 30 can use any hard disk that attaches to the computer via an IBM PC plug-in board.

5. The hard disk interface board occupies one of these slots.

6. The Model 50 contains space for another internal 3½-inch, 1.44-megabyte floppy disk drive.

7. This computer has room for another internal 3½-inch, 1.44-megabyte floppy disk drive and for a second internal hard drive or optical disk drive.

8. The Model 60 comes in a second model, Model 60-071, that is identical to the 60-041 except for its hard disk size, which is 70 megabytes; its price is \$6295.

9. The 16-MHz Model 80 also comes in a second model, the Model 80-071, that is identical except for its hard disk size, which is 70 megabytes, and a total of 2 megabytes of RAM; its price is \$8295.

10. The -071 model's 70-megabyte drive uses an ESDI disk interface running at 10 megabits per second, which is twice as fast as the ST 506 interface used on the 44-megabyte drive.

11. The Model 60-071 can have a maximum of 185 megabytes of hard disk storage.

12. All Model 80s have 8 slots, 3 of which can support either 16- or 32-bit boards. One 16-bit slot is used by the hard disk.

13. Both the standard and the optional hard disk on the Model 80-111 use the ESDI disk interface and are driven at 10 megabits per second.

14. Prices do not include operating system(s) chosen by user (\$120-\$795) or manuals (\$45-\$125 each).

IBM PS/2 Model 80 vs. Mac II

How does the price of IBM's new 32-bit machine compare with Apple's recently introduced 32-bit Macintosh II? At first glance, the prices look pretty even, but look closely at the standard equipment:

IBM's PS/2 Model 80-041	Apple's Mac II Model HD40
16-MHz 80386	16-MHz 68020
1 megabyte of RAM	1 megabyte of RAM
1.44-megabyte floppy	800K-byte floppy
44-megabyte hard disk	40-megabyte hard disk
3 open 32-bit slots	5 open 32-bit slots
4 open 16-bit slots	
keyboard	keyboard
video card	video card
	68881 coprocessor
	system software
	13-inch color monitor
Price: \$6995	Price: \$6996

To get a PS/2 that has features comparable to what comes standard with the high-end color Mac II, you'd have to add these options: an 80387 math coprocessor (\$795); a 12-inch color monitor (\$685); and the OS/2 operating system (\$325), which doesn't yet have graphics and windowing. Tack the costs of the options onto the cost of the Model 80 and the price tag reads more like \$8800, making the Mac II about \$1800 less expensive. You'd have more than enough left over to buy AST Research's Mac286 board (\$1499), which lets the Mac run MS-DOS programs.

circuitry that implements a 256-by-18-bit color palette.

The system supports several modes: 80-column text (with 640-by-400-pixel total resolution, 8-by-16-character box, 16 of 256K colors), 320 by 200 graphics (with 256 of 256K colors, 8-by-8-character box), 640 by 200 graphics (with 2 of 256K colors, 8-by-8-character box), and 640 by 480 graphics (with 2 of 256K colors, 8-by-16-character box). An optional board lets the system boost the text mode resolution to 720 horizontal pixels and allow a 9-by-16-character box.

In each mode, you can use any of 262,144 possible colors. Although the resolution in the 320 by 200 graphics mode is low, the large number of colors available on the screen at one time (256) and the large number of possible colors (262,144) gives the system the ability to produce some striking graphic images.

The MCGA can emulate the old CGA graphics for programs that use it, but cannot emulate EGA graphics without a special adapter card.

The VGA system is standard on Models 50, 60, and 80, and optional on Model 30. VGA is based on one gate array containing 12,750 gates. In addition to the modes supported by the MCGA, the VGA supports the EGA graphics standard and the following additional modes: text (720 by 400 total resolution, 9-by-16-character matrix) and 640 by 480 graphics (16 of 256 colors). The VGA arbitrates between the video memory and the processor, and the video memory and display circuitry.

The optional 8514/A graphics adapter uses the systems' *auxiliary video connector*, a 20-pin connector in line with one of the 16-bit Micro Channel slots. A video card plugged into this slot can substitute its own pixel and/or timing signals for those on the motherboard, providing a way to produce different kinds of video displays without replacing the video circuitry on the motherboard. In this way, the 8514/A supports a high-resolution mode of 1024 by 768 pixels on one of IBM's new monitors, the 8514. With an optional memory-expansion card, it can display 256 colors out of a possible 262,144 at this resolution. At a lower resolution (640 by 480), the 8514/A adapter can provide additional capabilities such as programmable character fonts, proportional spacing, and patterned area fills. The 8514/A costs \$1290.

Analog Monitors

Both the MCGA and the VGA systems can work with any of four new analog monitors: a medium-resolution monochrome monitor, two medium-resolution

continued



The Diconix 150. Take it or leave it.

The world's most portable printer performs as well at your desk as it does when you're on the road. The small footprint reduces desktop clutter, while it enlarges a small budget.

PC
MAGAZINE
The Best
of 1986



In the U.S., for the dealer nearest you,
call 1-800-DICONIX Telex: 288-280

In Europe, for the distributor
nearest you, call (4121) 37 56 04
Telex: 454-199 TXC CH

See us at COMDEX Spring,
Booth 1452.

DICONIX

A Kodak Company

3100 Research Boulevard
Dayton, Ohio 45420.

color monitors, and a large, high resolution color monitor. Each monitor has a horizontal refresh rate of 31.75 KHz and a vertical refresh rate of either 50 or 70 Hz. Total bandwidth is up to 70 MHz.

The Model 8503 monochrome monitor measures 12 inches diagonally and costs \$250. It uses IBM's version of a paper-white phosphor and shows no flicker or unsteadiness. Both the MCGA and the VGA can automatically detect the presence of this monitor and generate a monochrome image by using the 6-bit green component of the video signal to get 64 shades of gray.

The 8512 color monitor measures 14 inches diagonally and costs \$595. The 8513 is similar to the 8512 but is slightly smaller (12 inches) and has a finer dot pitch (0.28 mm); it costs \$685.

The 8514 is a 16-inch color display that is compatible with the 640-by-480 mode of the VGA and MCGA, and can accommodate the 8514/A video system's 1024-by-768 resolution. It costs \$1550.

All of the monitors except the high-resolution 8514 are available now; the 8514 will be available in July.

The Model 30 is up to 2½ times as fast as an XT.

BIOS Compatibility

The biggest news about the BIOS (basic input/output system) contained in the ROM of all the PS/2 computers is that it is almost entirely entry-point-compatible with the old BIOS. This means that any software that accesses system functions by calling BIOS routines (e.g., using the disk, changing the video display) will work on the new PS/2 machines.

The PS/2 Model 30 is compatible at the BIOS level with the older IBM PC, PC XT, Portable PC, and PC Convertible and with most hardware interfaces. It is designed to maintain compatibility with as much software developed for the PC as possible. Unfortunately, code that depends on a set execution time will not run correctly because the Model 30 runs faster than the PCs (8 MHz versus 4.77 MHz).

The PS/2 Models 50, 60, and 80 have a superset of the standard PC BIOS. The compatibility BIOS (or CBIOS) can address up to 1 megabyte of memory; it lets you run most of the currently available software. The Advanced BIOS (or ABIOS) provides support for multitasking operations and can address up to 16 megabytes of memory.

The BIOS on the Model 30 resides in two 27256 ROMs. The BIOS for the Models 50 and 60 is contained in a set of four 27256 ROMs and takes 128K bytes. As with previous models of IBM com-

puters, each BIOS ROM module has a model identification byte located at F000:FFFE hexadecimal.

IBM has changed some of the BIOS interrupts, but the changes make little practical difference. For example, interrupts 0B and 0C hexadecimal (communications), 0D (alternate printer), and 0F (printer) are now reserved. Interrupt 15 hexadecimal, which was the Cassette I/O System Extensions, has been relabeled System Services, though it still performs the same functions. Interrupts 40, 41, 46, and 4A hexadecimal were reserved, but now control Diskette BIOS Revector, Fixed Disk Parameters, and User Alarm respectively. Interrupts 71 through 74, 76, and 77 hexadecimal are now reserved; they had been IRQ 9 through 12, 14, and 15 (decimal). And interrupts F1 through FF hexadecimal, previously not used, are now reserved for User Program Interrupts.

To the average user running most IBM software, these changes to the BIOS will be invisible. Some non-IBM programs will need extensive rewriting, however. A good example of the extent to which IBM has maintained compatibility with the previous PCs: the ROM chips also contain Cassette BASIC Version C1.10.

Micro Channel: The New Bus

The Micro Channel bus is neither electrically nor mechanically compatible with the old IBM PC bus. The trade-off for the lack of compatibility is that the new design is capable of high-speed data and I/O transfers, sharing resources, and multiprocessing support. The Models 50 and 60 use a 16-bit-wide variant of the bus, while the Model 80 supports a full 32-bit-wide data path on 3 of its 8 slots. (However, at press time, we had not yet received full documentation on the 32-bit version.)

The Micro Channel is worth examining in some detail: Basically, it's a non-multiplexed bus (i.e., data and addresses have their own separate lines) that has additional lines for transfer control, arbitration, support signals, and power. All logic signal lines on the channel are TTL-compatible. The channel slots are dual-pin card-edge connectors that accept 1½- by 3-inch peripheral cards. (See figure 1.)

The bus, and indeed the entire system architecture, shows attention to detail in reducing electromagnetic interference: every fourth pin on one side of each slot has a ground line, and the motherboard and all the cards have ground planes. The designers said they think such an architecture is effective for reducing interference, not only for current machines but

continued



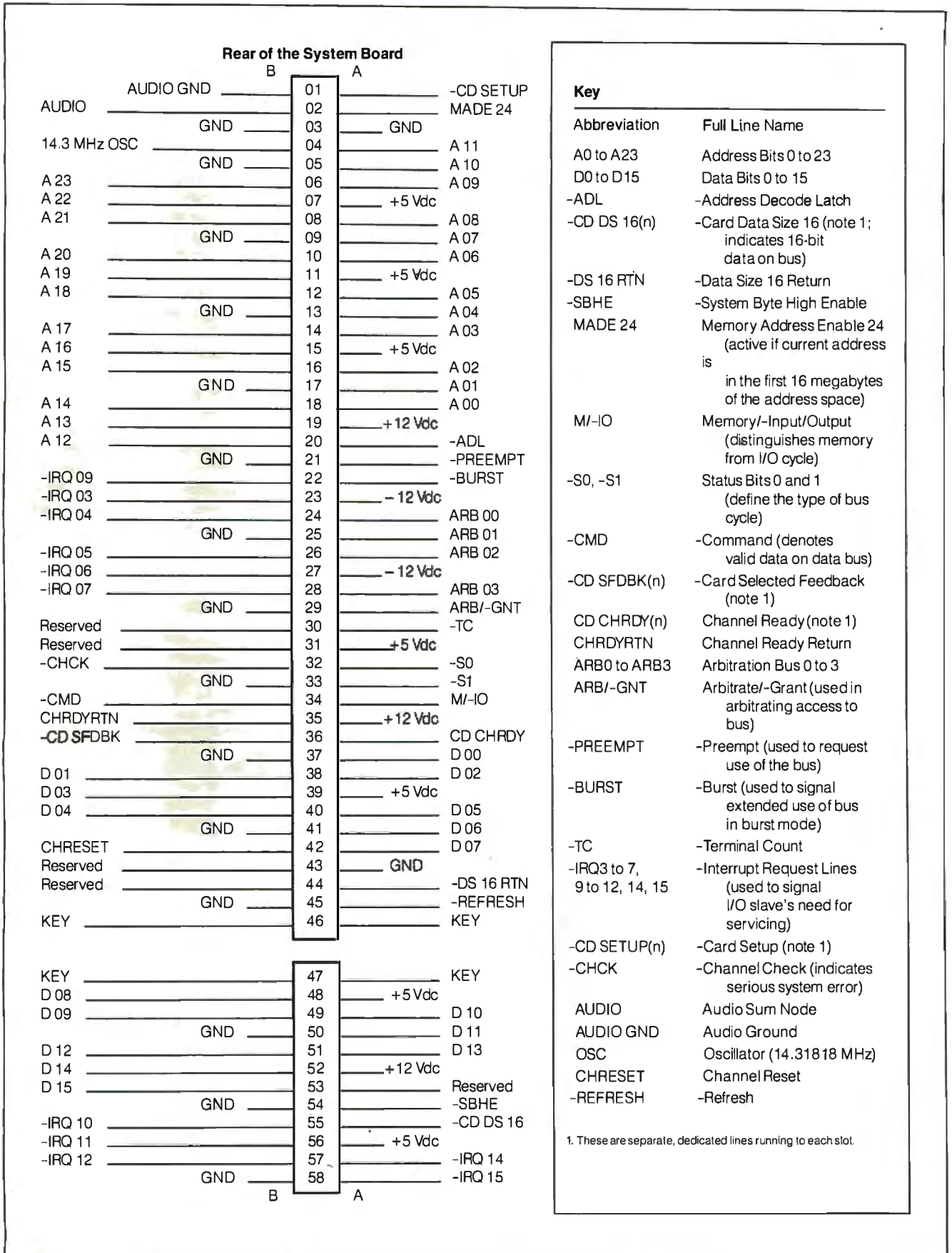

Figure 1: The Micro Channel slot pin-outs.



MODEL 50

for future systems as well. And in fact, all of the PS/2 systems have FCC Class B certification despite the fact that they are running at high clock speeds.

The Micro Channel uses asynchronous protocols for channel control and all data transfers. Two lines (-BURST and -TC) control block transfers of data. (Editor's note: IBM uses the notation "-signal-name" to indicate an active low signal. We'll be using this notation here.) A data transfer can go either to memory or to an I/O device, as determined by the state of a signal line (M/-IO). Two status lines (-S0 and -S1) define the transfer as a read or write operation. The lines -PRE-EMPT, ARB/-GNT, and ARB0 through ARB3 handle bus arbitration.

Lost or "phantom" interrupts can be a problem with concurrent processing. IBM said that to avoid the problem, it designed level-sensitive interrupts (replacing the edge-sensing interrupts used in the IBM PC) to allow for intrinsic sharing of the interrupts on all levels of the bus.

In the level-sensing scheme, each peripheral card toggles an "interrupt pend-

continued

The 80286-based Models 50 and 60 are about twice as fast as current ATs and come with the new Micro Channel bus and the Video Graphics Array system.



MODEL 60



CONNECT MAINFRAME TAPE DRIVES TO YOUR PC!

Whether your tape data comes from millions of miles away by satellite or from just down the hall in accounting, our "TAPE CONNECTION" can read and write 1/2" 9-track magnetic tapes using your PC! Over 500 million reels of magnetic tape are in use by most mainframe and minicomputer systems. For more than 25 years, 1/2" 9-track tape has been the standard worldwide for storing and retrieving large data files. Why not let your PC and our tape system assist you in using the vast resources of the tape data world?

Supporting 800 NRZI, 1600 PE and 6250 GCR, our file transfer software processes labeled or unlabeled tapes from most computer systems, including IBM OS/DOS, DEC/VAX, UNISYS, Honeywell, Burroughs, NCR, and HP. Large multivolume tape reels can be transferred to disk at rates up to 5 MB/minute! Backup and restore capabilities work well with Novell networks for IBM XT/AT. With our Tape Data Extraction software, you can read packed fields, select and extract specific records and fields, such as payroll or personnel data, tax structure statistics, department records, as well as import data into LOTUS 123. You'll find so many applications for your particular business. You could even use your PC to read and display NASA's Voyager II mission datatapes, such as this highly enhanced image of Saturn's rings recorded from a distance of 8.9 million kilometers (from the tape library shown above).

We have years of experience with IBM mainframes using magnetic tape, so we're qualified to assist you in implementing and supporting your application. Since 1981, we have supplied thousands of conversion systems throughout the world, including most of the *Fortune 500*

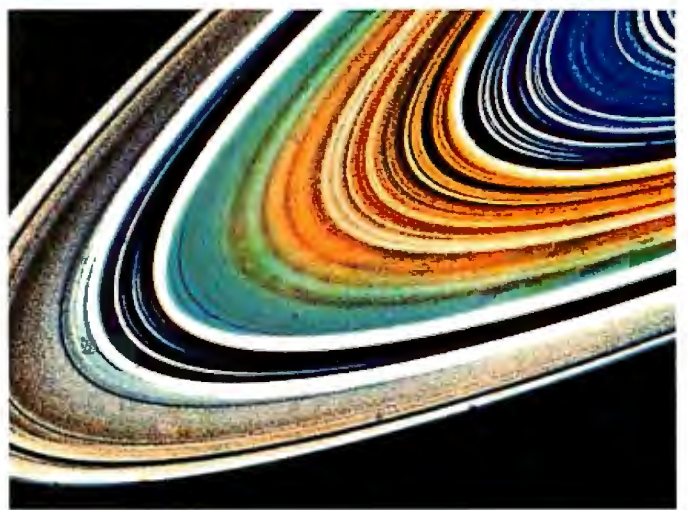

companies. Our customer support personnel are available to answer your questions, free of charge. Our high volume allows us to offer low prices on Anritsu, Cipher, Kennedy and Qualstar equipment. Systems come complete and ready to use with controller card, cables, software and drive. Ranging from \$2995 to \$8995, we have a system for you, so call us today!

Dealer and volume discounts available.



1120 Kaibab • Flagstaff, Arizona 86001 • 602-779-3341
CompuSol-Europe • 12 Rue Rosenwald • 75015 Paris
Tel 530.07.37 • Telex 205431F

Inquiry 109 for End-Users. Inquiry 110 for DEALERS ONLY.

DISC DATA MANAGER:

For people who need a lot of storage now...

Introducing the DISC DATA MANAGER™ from Seagate. The high-capacity storage subsystem that expands module by module to meet your changing needs.

Since you choose the capacity, you never pay for more storage than you need. Yet, affordable growth is there when you need it.

The DISC DATA MANAGER is a SCSI subsystem that provides compatible storage for many environments. Including PC-DOS* and Novell's popular Advanced Netware.*

As your needs for storage sharing increase, the DISC DATA MANAGER can be converted into the LAN DATA MANAGER™, a high-performance, IBM*-compatible file server.

But this is just half the story.

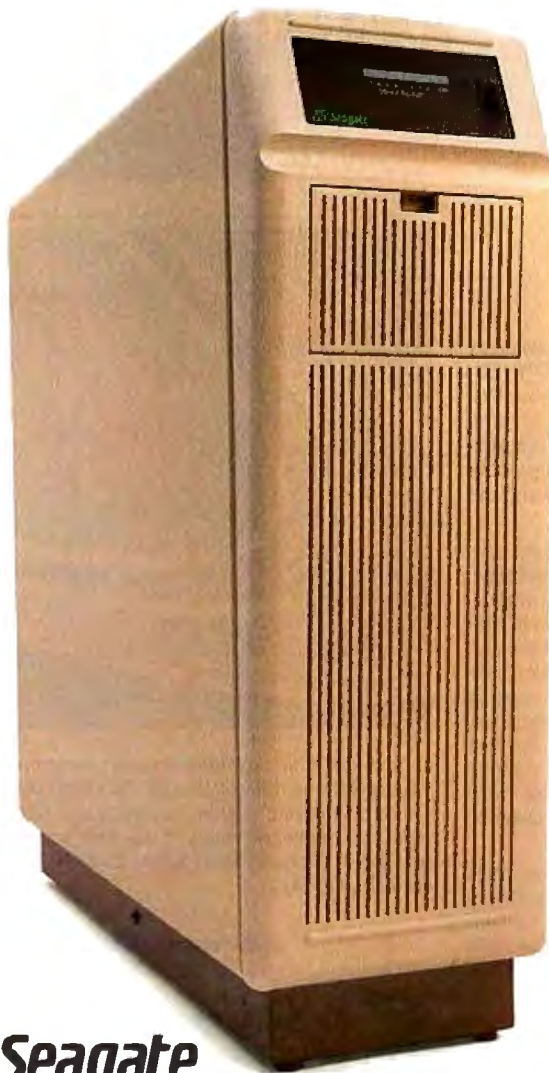

 **Seagate**

ing" latch and holds the interrupt line active until it is serviced. By having the interrupt handler check all the cards' latches until none are pending, multiple peripheral cards can service interrupts without losing any of them. Level-sensing interrupts have the additional advantage of being resistant to line noise. In the Micro Channel, 11 prioritized interrupt lines use level-sensing interrupt signals. (From highest priority to lowest, they are -IRQ9 through -IRQ12, -IRQ14 through -IRQ15, and -IRQ3 through -IRQ7.)

Each slot also has several lines that are not shared (see figure 1, note 1) and others that are used to indicate the data-transfer width (16 or 32 bits wide; 8-bit transfers do not require a signal), card-selected feedback (which indicates slot occupancy at a specific address), and card setup (used to select cards during system configuration). The bus also contains provisions that allow cards to slow down the system speed, and in some cases to speed it up. By taking advantage of this, designers can build cards that will run in any Micro Channel system, whether it uses a 10-MHz 80286 or a 16- or 20-MHz 80386.

The AUDIO and AUDIO GND (audio ground) lines provide a single audio line that can be fed to the system's audio output or used as a path for an audio signal between peripheral cards. The frequency response of the line is 50 Hz to 10 kHz.

A central arbiter device (located on the motherboard) coordinates bus access. A card requests use of the bus by driving the -PREEMPT line active. The central arbiter permits an arbitration contest to take place as soon as the current card releases the bus: The central arbiter signals the start of an arbitration cycle (the ARB/-GNT line is driven to the arbitrate state), and the competing cards drive their arbitration levels onto lines ARB0 through ARB3. The fixed arbitration level for the card is set at system boot-up by a system configuration program. The card with the lowest arbitration level, and thus the highest priority, wins the contest. The winner gets access to the bus as soon as the central arbiter drives ARB/-GNT to the grant state.

The arbitration logic is fair in that it gives each card that entered the competition a chance at the bus before starting another arbitration contest. The arbitration mechanism, by the way, is the same as that used to arbitrate the DMA channels. This should reduce the work for some designers.

Because each card can have its own priority level, you might expect to have to set DIP switches to configure the system and its cards. But instead, a feature called Programmable Option Select (POS) auto-

mates the process. (As one IBM designer told us, "We think DIP switches are appropriately named.") Under POS, each card has its own identity code. Of more than 64,000 possible codes, IBM has reserved half for itself; the rest will be divided up among third-party developers. At boot-up, the system determines which cards are present and compares this with a list of cards stored in nonvolatile RAM during the last power-up. If it detects no new cards, the system loads any registers on the cards with data from the nonvolatile RAM. No switches or jumpers are needed on either the motherboard or on any expansion cards. If the system discovers a new card (or fails to recognize an old one), it can disable the card and give you the option of running a configuration utility to assign system resources to it. This ability to disable unknown cards also adds a measure of security; a malfunctioning peripheral card is less likely to remain on-line and crash the computer.

New Operating Systems

The PS/2 machines can use either of two new operating systems: PC-DOS 3.3, which is available now, and Operating System/2, designed for 80286 and 80386 systems, which won't be available until next year.

DOS 3.3 is an enhanced version of the DOS 3.2; it costs \$120, but you can upgrade from previous versions of PC-DOS for \$75.

DOS 3.3 solves some of the problems of its predecessors. For example, it can address a hard disk larger than 32 megabytes by dividing it into several partitions (former versions allowed multiple partitions, but PC-DOS could address only one of them).

Several new commands help DOS 3.3 meet the needs of an increasingly sophisticated environment. The APPEND command makes it easier for your program to find files in other subdirectories. CALL allows a batch file to execute another batch file, then return to continue its own execution. FASTOPEN is a terminate-and-stay-resident routine (the kind that gives you pop-up desk accessories) that creates a filename cache to speed up the reopening of recently used files; this command improves the performance of the computer when it has files that are opened and closed often (as with networked files).

IBM's OS/2 promises to have some very impressive capabilities when it becomes available. OS/2 is a multitasking system that can access up to 16 megabytes of memory. The new operating system will incorporate several features of IBM's newly announced Systems Application

continued

...and a lot more in the future.

With the DISC DATA MANAGER, you can add more disc drives as your need for storage grows. Adding one or more drives gives you a capacity range from 160 MB to over 1 gigabyte.

Using multiple drives, you can perform overlapping operations. Or back up important files on separate drives. There's even an optional 40 MB tape drive for archival storage.

Best of all, the DISC DATA MANAGER is made by Seagate, the people who have built reliable performance into more than 5 million 5¼" hard disc drives.

For more information on the storage subsystem that grows with you, call us. 800-468-DISC. In California, 800-468-DISK. Ask for Tim.

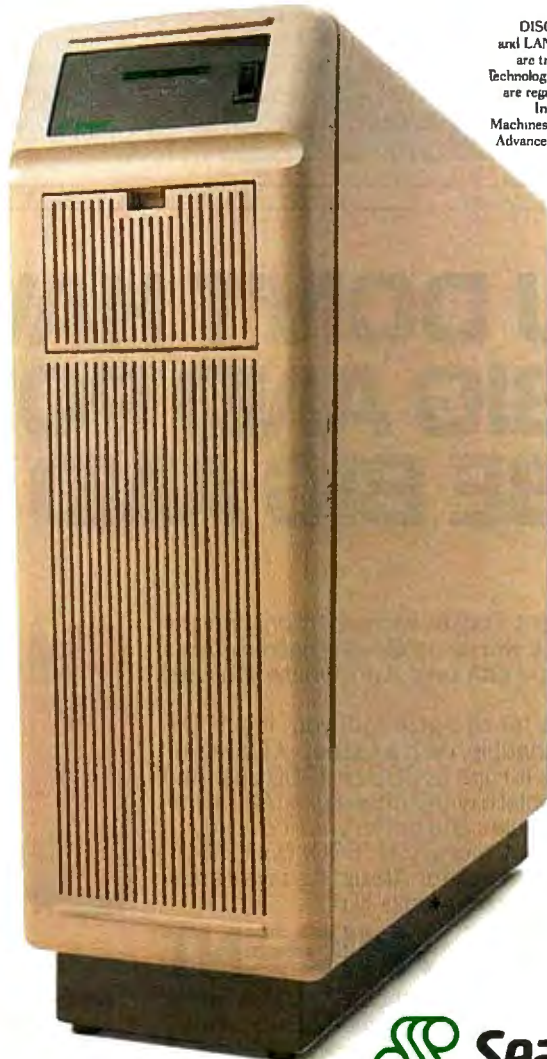

DISC DATA MANAGER and LAN DATA MANAGER are trademarks of Seagate Technology. IBM and PC-DOS are registered trademarks of International Business Machines Corporation. Novell Advanced Netware is a trademark of Novell, Inc.

 **Seagate**

What IBM Didn't Do

For months (years even), rumors have been flying about what IBM would do with its next generation of microcomputers. Discussions with IBM personnel have contradicted many of the more prominent rumors. What follows is a list of what IBM says it did *not* do with its new machines.

- IBM did not alter the masks of the Intel 80286 or 80386 chip.
- IBM did not, and said it has no plans to, introduce a VM-type OS.
- IBM did not decide to hold off the 80386-based system until 1988. It is scheduled to be available in July of this year.
- IBM did not divide communications functions between the motherboard and a proprietary card to make third-party communications products harder to build.
- IBM did not arbitrarily change the bus and the card size—the 32-bit bus introduced on the Model 80 appears to be a solid foundation that can be built on for years to come, supporting multiprocessing and very high speeds.
- IBM did not change the floppies to 3½-inch drives without good reason; the double-sided microfloppies hold 1.44 megabytes of data and are faster and more reliable than 5¼-inch drives. IBM also predicted much higher densities to come on 3½-inch drives.

IBM *did* announce its own windowing system, the Presentation Manager; it will be about two-thirds Microsoft Windows and one-third proprietary. The windowing system, shown in simulation, looks significantly different from Windows, the Macintosh environment, GEM, or anything else. Microsoft has announced that Windows 2.0 (which will run under DOS 3.3, but not OS/2) will be visually identical to the Presentation Manager.

Architecture (SAA), which will reportedly present a common user interface across all of IBM's systems. Eventually, it will have a user interface based on windows, graphics, and icons. And a later Extended Edition will include a relational database and communications functions.

The first version of OS/2, called Standard Edition 1.0, will appear in the first quarter of 1988. It will have no graphics or windows and will cost \$325.

The next version of OS/2, Standard Edition 1.1, will contain a Presentation Manager, which IBM said will include graphics, windows, typographic-quality text fonts, and icons. The Presentation Manager is based on Microsoft's Windows and on the Graphical Data Display Manager (GDDM) interface on IBM's 3270 systems. However, IBM said that the Presentation Manager's interface will be significantly different from those of Windows, the Apple Macintosh, or Digital Research's GEM.

A later version of OS/2, the Extended Edition, will have all the features of the Standard Edition plus a version of IBM's DB2, a mainframe-based relational database, and a version of SQL, IBM's structured query language. In addition, it will

continued

YOU DON'T HAVE TO LOOK BIG AND POWERFUL TO BE BIG AND POWERFUL.

The Migent Pocket Modem. It only weighs 9 oz. And it works on 9-volt battery or ac power, so you can take it anywhere you need your PC.

But don't let the size fool you. It's 100% Hayes-compatible. With a full set of Hayes-AT commands. It runs at 300 or 1200 bps. And comes complete with software, ac/dc power converter, cables and battery, so it's ready to use. To find out more, call (800) 633-3444, Dept. 608, and ask for Alexis. And we'll show you what real power looks like.

MIGENT™

Migent, Inc., 865 Tahoe Blvd., Call Box 6,
Incline Village, Nevada 89450-6062

Registered trademark: Hayes. Hayes Microcomputer Products. Trademark: Pocket Modem, Migent.



GUARANTEED FOREVER.



Introducing the revolutionary new 1/4-inch cartridge from DEI. Series II Gold.™



You think nothing lasts forever?
Think again.

After years of pushing the limits of 1/4-inch technology, the daring and resourceful engineers at DEI have finally outdone themselves.

They've come up with a higher-performance, higher-capacity 1/4-inch cartridge that, storage-wise, begs comparison with formats twice its size.

But they didn't stop there. DEI

went to extremes to extend the reliability of the 1/4-inch cartridge as well.

The net result? The most rugged, high-capacity, high-performance 1/4-inch cartridge the world has ever seen. And a guarantee to prove it.

Here's the inside story.

The media in the Series II Gold is a proprietary anisotropic formula called LT-9000.™ LT-9000 can store up to 150 MB per cartridge. It yields half the data drop-outs. It causes significantly less wear on recording heads than conventional media. And it lasts two times longer.

Mechanically, the Series II Gold is the most sophisticated cartridge in the world. But, complicated it's not. In fact, the tape guiding system

of the cartridge is so simple and exact, it's the least problematic cartridge ever made.

Hence, with great confidence we assure you that every DEI Series II Gold cartridge will last forever.

That doesn't mean you can drive a truck over one and expect it to keep working. But it does mean that in the event that a DEI Series II Gold cartridge fails due to normal use, we'll gladly give the purchaser a new one.

DEI 
Because every little bit counts.™

DEI Series II Gold is a trademark of DEI.
LT-9000 is a trademark of DEI.

USA: DEI, 10170 Sorrento Valley Road, San Diego, California 92121
Phone: In California- 1-(619) 452-7840. Outside California-1-800-DEI-TAPE
EUROPE: DEI-EURO-85187307; FAX-01144293775527

©1986 DEI

Bluespeak

IBM is one of the few entities that, like Big Brother or the Cheshire Cat, can make a word mean what it wants it to mean. If you should ever encounter unfamiliar words in reference to IBM products, the following list might help:

IBM word	Real-world definition
adapter	peripheral card
channel	bus
facility	usually a combination of hardware and software
feature	a hardware add-in, usually a peripheral card or a disk drive
fixed disk	hard disk
pel	pixel
planar	motherboard

contain an advanced communications manager, which lets users communicate concurrently via several different protocols. It will cost \$795. For more details on the general structure and operation of OS/2, see "Microsoft's New DOS," on page 116 of this issue.

Only The Beginning

Overall, the PS/2 computers are a respectable design with considerable room for growth. One of the most significant aspects of the announcement is the announcement itself: Now that IBM has shown its hand, the rest of the industry can move forward again.

We were pleased to find that IBM has not, as some rumors said, created a proprietary (and therefore hard-to-copy) computer by having Intel create a custom version of the 80286 and 80386 processors. Though IBM is secretive about many aspects of its design, it has pledged to document BIOS entry points and Micro Channel signals, thus opening the design to software and peripheral-card developers (but not to designers of compatible computers). A critical issue for companies making PS-compatibles is whether or not IBM will sue to defend its patent of the Micro Channel bus.

Unfortunately, the absence of the OS/2 software until sometime in 1988 leaves us, for now, with a line of computers that are little more than high-speed IBM PCs with large hard disks. Worse, software to exploit the unique features of the Model 80's 80386 processor appears to be even farther off (OS/2 is written in 80286 machine code and does not use any 80386-specific features). The PS/2's ability to run multiple processors off the Micro Channel bus and to run up to a gigabyte's worth of programs under OS/2 offers a promise of high performance sometime in the future. We will not be able to gauge the true worth of this product line until we begin using these new features. ■

Editor's note: In the next issues of BYTE, we'll continue to examine the underlying technology and implications of the new IBM hardware. Our coverage will include full product reviews of the new systems. And in a new series of articles called "The New Generation" we'll begin in-depth ongoing comparisons between the two major new families of 32-bit personal computers: the 80386-based machines (such as the IBM PS/2 Model 80), and the 68020-based machines (such as the Mac II).

Schematic Capture

Auto-Routing

SoftWest Tool Kit

The Success!

New features! Increased performance! Introducing the NEW Auto-Board System 2.1, companion software to AutoCAD®, for printed circuit board design! It still has Schematic Capture, Component Layout, and multiple Auto-Routing strategies. Now it's improved with 0.001" resolution, trace hugging and 45° bends, plus the SoftWest Tool Kit featuring Back Annotation, Netlist Comparator, Combiner and Formatter. Prices in USA start at \$2500.00.

For more information call: **The Great SoftWestern Company, Inc.**
 Japan / AppliCAD
 Tel: 03(498)-6235 Fax: 03(498) 6238
 Sweden / EMT AutoCAD Center
 Tel: 07(563)4020 Telex: 854 12352
 United Kingdom / Datech, LTD.
 Tel: 0689-36231 Telex: 261 752
 France / I.S.T.C.
 Tel: (1)45.32.80.01 Telex: 201 297

207 W. Hickory, Suite 202
 Denton, Texas 76201
 U.S.A.

1-800-231-6880
INFORMATION & ORDERS
 1-817-383-4434
TECHNICAL ASSISTANCE

The Great SoftWestern Company, Inc.®
 The Original

AutoCAD is a registered trademark of Autodesk, Inc.

PRIMAGE 90-GT™

**"DAISYGRAPHER"™
90 CHARACTERS PER SECOND**

"5 in 1" PRINTING SYSTEM

- FULLY FORMED LETTER QUALITY PRINTER—Diablo 630* Emulation
- GRAPHICS AND TEXT PRINTER—Epson FX-80 GRAFTRAX** Emulation
- INTEGRATED PAPER HANDLING—Fully automated PAGEMATE® letter and envelope system
- EXCLUSIVE RIBBON SENSING SYSTEM***—Three way ribbon protection, providing security for unattended operation
- MULTILINGUAL OPERATION—15 standard language sets

Who said you can not print graphics with a daisy wheel printer! Primages once again uses advanced technology to bring a new dimension to Office Automation printing. The Primages 90-GT "Daisygrapher" emulates the Epson FX-80** Graftrax** (bit map graphics mode). This allows graphic images to be printed within fully formed text fields—real letter quality that only a daisy wheel printer will allow, taking full advantage of the ever increasing sophistication of Office Automation applications. This is in addition to the standard Diablo 630* emulation...both are now standard and all this at 90 characters per second!

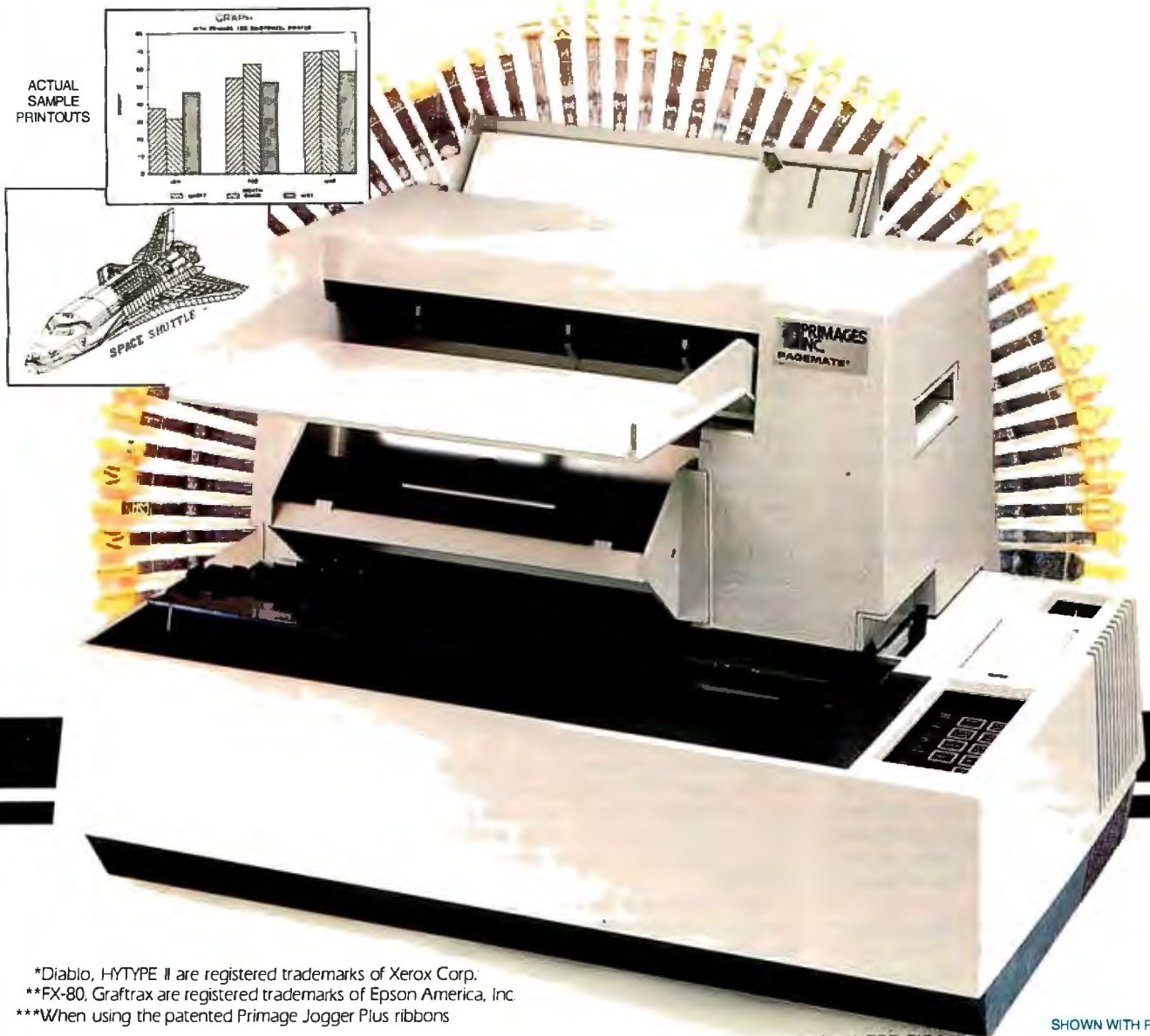

ACTUAL
SAMPLE
PRINTOUTS

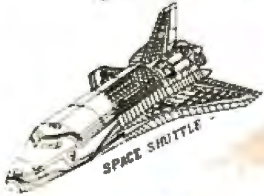
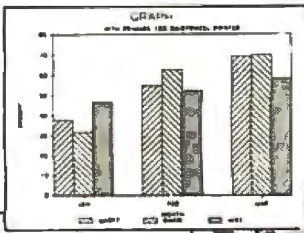

*Diablo, HYTYPE II are registered trademarks of Xerox Corp.

**FX-80, Graftrax are registered trademarks of Epson America, Inc.

***When using the patented Primage Jogger Plus ribbons

Microsoft's New DOS

[Editors' Note: *We based this article on our evaluation of alpha-release software and documentation, and on a series of interviews with Gordon Letwin, chief architect of the OS/2 project.*]

In 1981, IBM introduced MS-DOS 1.0 with the Intel 8086-based IBM Personal Computer. The operating system was very similar to the then-predominant CP/M. It was actually a redesign of an earlier operating system written to mimic CP/M's functions and style of operation.

Through the years, Microsoft has steadily built on MS-DOS: version 1.25 added support for double-sided disks; version 2.0 provided for Unix-like hierarchical file structure and hard disks; versions 3.0, 3.1, and 3.2 added support for 1.2-megabyte floppy disks, higher-capacity hard disks, Microsoft Networks, and 3½-inch floppies. With each enhancement, compatibility with preceding generations of MS-DOS was an important—and restricting—consideration; it kept Microsoft from adding significant new functions to the operating system.

What's more, the 16-bit 8086 is becoming obsolete in a world increasingly dominated by 32-bit microprocessors. Microsoft is attempting to overcome these limitations with a new operating system that harnesses the power of Intel's 80286: OS/2.

OS/2 is an 80286-based, multitasking, single-user operating system that supports a single real-mode application and a theoretically unlimited number of protected-mode applications (the amount of

RAM available determines the number of simultaneous tasks OS/2 can support before performance becomes unacceptably slow). OS/2 will also run on 80386 machines, since the latter's instruction set is a superset of the 80286's.

In developing OS/2, Microsoft's goal was to provide system software that would be suitable for an office-automation environment. Everyone would have their own computer with which they can perform multiple tasks and communicate through network links. [Editor's note: *For a discussion of architectural considerations, see the text box, "Design Goals," by Gordon Letwin.*]

OS/2 provides a powerful, flexible foundation that will make the eventual migration to the 80386 relatively painless. While this new operating system will only run on a machine using an 80286 chip (or higher), the designers have provided an impressive amount of downward compatibility for the current base of DOS applications.

Dual Modes

The 80286 (used in the IBM PC AT and compatibles) offers two modes of operation: the real mode and the protected mode. In the real mode it runs programs written for the 8086 unaltered. In the protected mode it provides, through hardware, protection and virtual-memory management for multitasking. But incompatibilities between the two modes prevent most 8086 programs from running without modification under the protected mode of the 80286. (The 80386's virtual 8086 mode should solve these problems.)

In protected mode the operating system provides virtual-memory management, task management, and protection. With virtual-memory management, your applications get access to the 16-megabyte

real-address space of the 80286 and a 1-gigabyte virtual-address space. A three-level priority scheduler allots processor time slices among the tasks. The operating system takes advantage of the 80286's protected mode to isolate tasks from one another.

Under OS/2 real-mode applications can do everything they could do under previous versions of MS-DOS—but no more. This shouldn't be much of a problem because most people will use the real-mode area—referred to as the 3.X box—to run their DOS 3 applications. (In this article, DOS 3 means all versions of DOS 3.) Anyone developing new software under OS/2 will probably prefer to use the protected mode where the application programmer interface (API) is richer and the debugging facilities are more sophisticated.

Figure 1 is a memory map of OS/2. The operating system itself sits at the low

Multitasking (with semaphores, pipes, and queues), virtual memory management, protection, and compatibility with existing software are just some of the features of Microsoft's OS/2.

Eva White and Richard Grehan are technical editors at BYTE. They can be reached at One Phoenix Mill Lane, Peterborough, NH 03458.

end of memory, occupying about 90K bytes. The 3.X box resides just above it. Notice that the "high-water mark" of the 3.X box is user-adjustable between an address of 512K bytes and 640K (the actual memory available to the 3.X box is that address less the size of the operating system). Sitting above the high end of the 3.X box are BIOS routines and screen memory, and above them are the non-movable protected segments and non-movable, nonswappable code (this is where the memory management code for disk swapping resides—you can't swap the swapping code). Finally, the top end of the system's memory is the domain of the swappable protected-mode applications. (Any memory between the top of the 3.X box and the BIOS region also goes to protected applications.)

A user-alterable argument in a configuration file lets you disable the 3.X box entirely. If you do this, you can run OS/2

in as little as a megabyte. If you want to run the 3.X box, however, the designers recommend at least 1152K bytes of memory (640K bytes below the BIOS area and 512K bytes above the 1-megabyte line). Some memory-expansion cards use linear addressing for their memory above 1 megabyte. In this case, any memory beyond 1 megabyte that the system finds at boot-up goes to protected-mode applications. Other expansion cards window their memory into a fixed-size block within the lower 1 megabyte. The 3.X box can use this memory, and according to Microsoft, such memory cards should work correctly in OS/2.)

Screen Groups

OS/2 uses screen groups to manage multiple tasks on a single machine. Think of screen groups as a series of virtual PCs. The session-manager portion of the operating system handles the switching

from screen group to screen group.

In the version of OS/2 we looked at, the session manager displays a menu showing the current screen groups. If you have configured the system for a 3.X box, you will see one real-mode screen group that uses the command processor COMMAND.COM and a selection to "start a program," which, each time you choose it, starts a new protected-mode screen group using the protected-mode command processor, CMD.EXE. To switch to another virtual PC, you press the session-manager key combination, Control-Escape to returns to the menu of the current screen groups. Pressing Alt-Escape rotates you through the menu. You press the Return key to choose a menu item.

According to Microsoft, the final version of OS/2 will run with Microsoft Windows Presentation Manager, the graphical user interface, and a mouse. It

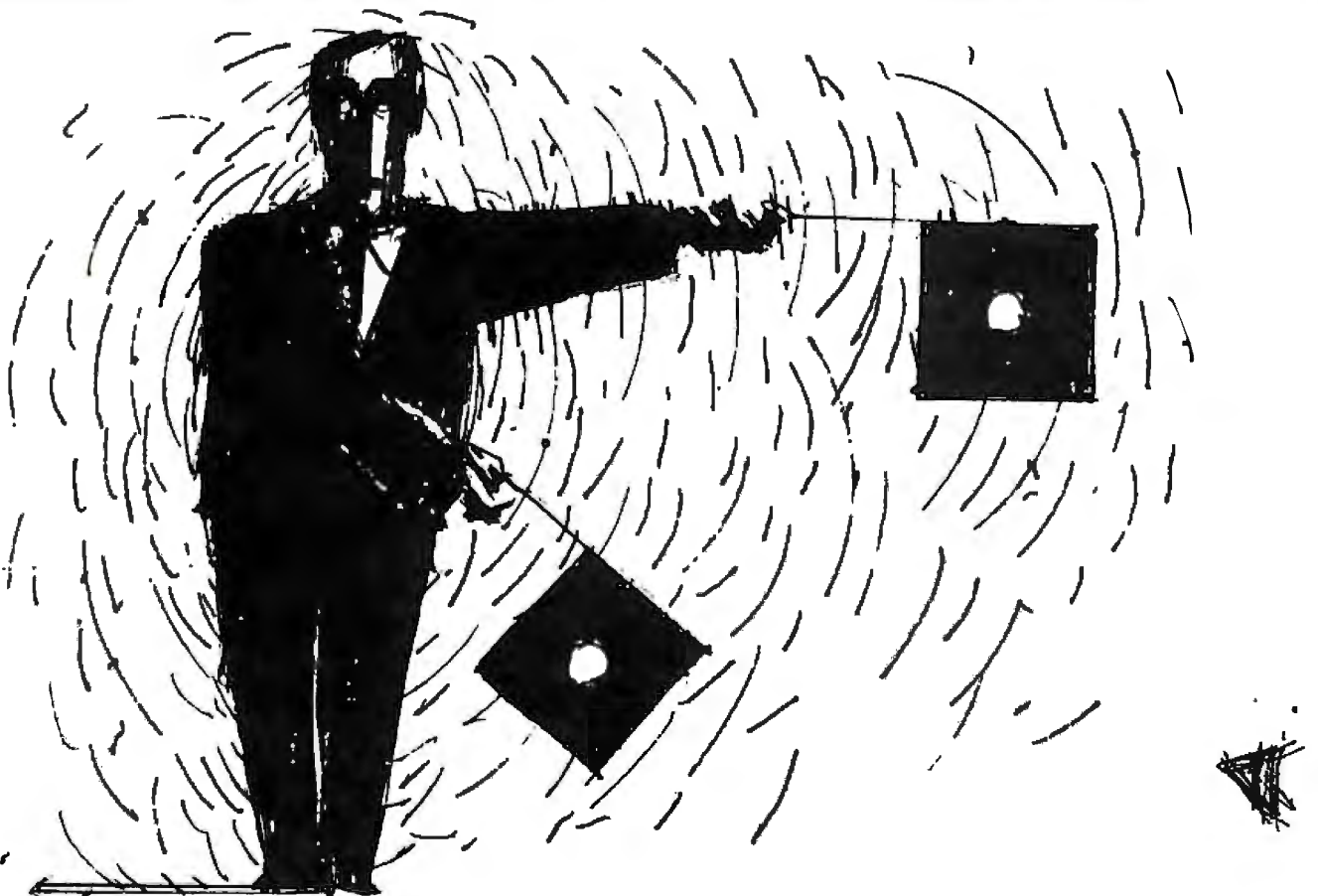

will work as just described except the session manager menu will be a drop-down menu on the current screen group; you click the mouse on a menu option to change to another screen group. The Presentation Manager is the protected-mode version of the real-mode Microsoft Windows already available for DOS 3. It will handle the output of separate tasks to a single physical display.

Because of screen groups, it should take you very little time to get comfortable with OS/2. The protected-mode command processor gives you the familiar DOS commands such as `attribute`, `chkdsk`, `diskcopy`, and so on. One new command available in protected mode, `detach`, lets you start a background process. (More information on the multitasking scheduler later in this article.)

Since OS/2 was designed as a single-user system, you do not need a command for logging off the system. But before turning off the computer, you must check your screen groups and shut down all tasks gracefully (similar to earlier versions of MS-DOS, only now you have to remember to exit more than one process).

The disk structure of OS/2 is identical to the structure of DOS 3, so it can read disks you are using in your PC. While this means that OS/2 continues to carry all the limitations of the old disk directory structure (e.g., the 32-megabyte disk volume limit), the designers have laid the groundwork for removing these limits and adding file protection (file I/O calls contain extra arguments that will be used for this purpose in a future operating system).

Under OS/2, it will be very important to give volume names to your floppies. In a multitasking environment, when a number of programs are executing simultaneously, the odds of writing to the wrong floppy are extremely high. The designers added a field to the disks so that each floppy carries a unique ID number. This ID is derived from the user-entered disk volume name and a system-generated 32-bit binary number. You should be sure to use the DOS `label` command for any DOS 3 disks that don't have a name before using them under OS/2.

Protected Mode

If you've done any programming under existing versions of MS-DOS, you are already familiar with all the features available to OS/2's 3.X box. It is obvious, then, that the real power of OS/2 lies in its offerings to the protected-mode applications. Consequently, for the remainder of this article we'll concentrate on the protected-mode portion of OS/2 (unless we specifically state that a certain function is available to real-mode applications).

Programmer Interface and Dyna-Links

While the user interface of OS/2 is similar to previous versions, the application programmer interface (API) has been dramatically reworked. The most significant change is that programmers will no longer issue interrupts for services. All work in the system is done through a generalized procedure call interface implemented through dynamic links (dynamically links, for short).

Using a procedure call mechanism for requesting system services is quite an improvement over using interrupts. It provides one interface to all system services, hides the implementation of those services, and allows routines to have more meaningful names. When making far calls to routines that expect their arguments to be passed to them on the stack, programmers will now use the Pascal calling convention. Several C compilers can specify the Pascal calling convention.)

Another advantage of using a procedure call is that you cannot overload one of the software interrupts. Interrupt vector redirection in DOS 3 often causes problems when several TSR (terminate and stay resident) pop-ups are installed on the same machine and end up fighting over control of a single vector. Permitting such activity on a multitasking system could be disastrous. (Applications that execute in the 3.X box can continue to redirect vectors and use `INT 21h` just as before.)

The new call scheme allows much of the operating system to be stored on disk in dyna-link libraries and pulled into memory only as needed. Dyna-linking means a program's external references to subroutines in other segments are resolved at run time rather than at link time. OS/2 delays binding of routines by using special "stub code" in place of the actual code in the executable file generated by the linker. This stub code contains the module name and entry point of the actual code.

There are two kinds of dyna-links: preload and load-on-demand. OS/2 loads segments marked preload into memory when the user starts the application and faults-in those segments marked load-on-demand as the application needs them.

So that a dyna-link routine operates efficiently in OS/2's multitasking environment, each routine has three segments: code, instance data, and global data. The code segment's function is obvious: it is the executable portion of the routine. The system creates an instance-data segment for every user of the routine (i.e., if several tasks call the same dyna-link routine, each task will get its own instance-data segment associated with that routine). However, only one global data segment is created for its associated dyna-link routine, regardless of how many customers the routine has.

Dyna-links give OS/2 the flexibility to handle future hardware and software changes efficiently. With them, you can package such services as database engines in dyna-link libraries and these libraries need not even come from Micro-

continued

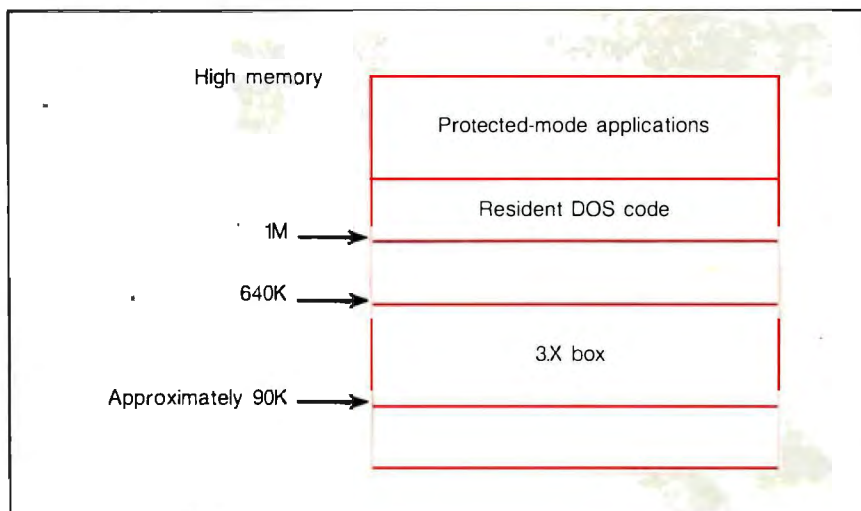

Figure 1: A memory map of OS/2. This figure shows a system configured for both protected- and real-mode applications. You can set up an OS/2 system for protected-mode tasks only, in which case the 3.X box disappears and protected-mode applications can use its memory. Also, you can adjust the 640K boundary at the top of the 3.X box to some lower value, freeing the memory between it and the BIOS area for use by protected-mode tasks.

Microsoft designed OS/2 with the future of the office automation environment in mind—where microcomputers on every desktop handle the routine information-manipulation tasks of a modern office, and the rapid flow of information via networks replaces the slow flow via paper. We built OS/2 so that it achieves the following goals:

- It provides device-independent graphics drivers, but it does not introduce any significant overhead in doing so.
- It gives applications direct access to high-bandwidth peripherals, but it virtualizes the use of those peripherals to prevent cross talk.
- It provides a fully customized environment for each program and its descendants, yet it also provides a standard environment that is unaffected by other programs in the system.
- It provides a protected environment to ensure system stability. It still provides applications with all the capabilities they had under nonprotected systems, but it doesn't limit the capabilities they can add in the future.

OS/2 is similar to traditional multitasking operating systems in many ways: It provides multitasking, scheduling, disk management, memory management, and so on. But it is as different from them as an office desktop environment is different from a multiuser mainframe environment. Traditional multitasking systems were designed at a time when computers were very costly; maximizing the machine's throughput and utilization was important.

Powerful microcomputers are now relatively inexpensive. In designing OS/2, we attempt to maximize the machine's response and utility to its user.

OS/2's emphasis on a graphical user interface is a departure from traditional operating systems. [Editor's note: *The first release of OS/2 will not provide graphics support in its video I/O package; programs will have to do their graphics work through direct device control.*] A powerful graphics capability is essential to an office-automation operating system. Such facilities were rare in minicomputer operating systems because they required a lot of memory and compute power to drive high-resolution displays. Today's microcomputers have the necessary memory and CPU power.

OS/2 also differs from traditional minicomputer operating systems in its management of devices. The classic device driver interface is too slow and one-dimensional for effective use of the graphics-display screen and the mouse,

Design Goals

yet some system interface is needed to provide display-device independence. Instead of screen device drivers, OS/2 uses a set of three dynamic-link packages to provide a high-performance yet device-independent interface to the screen, mouse, and keyboard. Packages such as Microsoft Windows can partially replace these dynamic-link routines, letting Windows or similar packages seamlessly support non-Windows programs.

Most minicomputer systems virtualize—or share—all devices among the running applications. Since users are physically remote from the CPU, their only personal system is their terminal and a low-bandwidth OS-based interface. OS/2 virtualizes some system resources such as system RAM and disks, but allows applications direct access to private devices such as special display hardware, light pens, digitizer tablets, and so on. Such direct access is critical for good performance from high-bandwidth devices.

OS/2's environment is protected so that applications cannot help themselves to what they need by manipulating system memory or devices, but this also restricts an application's ability to effectively add new features to the system. This means that OS/2 must provide functions to support anything that a current or future application might need.

Since Microsoft cannot possibly anticipate all conceivable programs, the OS/2 design includes a variety of adaptable, expandable interfaces that can accommodate future requirements. With dynamic linking, for example, you can access services from DOS, from library routines, and from other processes in a flexible yet controlled way. You can upgrade the system, add packages and services, and process and distribute data across the network, yet the clients of those services will continue to see an unchanged interface to those services.

A multitasking system runs many programs in one computer. Ten programs at once means that the chances of a program bug cropping up are ten times greater. Worse, an errant program may damage another, thereby hiding the true cause of the problem, or perhaps just producing an incorrect result. OS/2 is

designed so that errors are isolated to the program that caused them. The program's normal operation—memory consumption, keyboard usage, and so on—does not affect others. It also restricts a program's ability to interfere with others by the manipulation of global resources, such as the screen or keyboard. A protected-mode application can control the screen and keyboard within its own screen group, but it cannot prevent the user from switching to another screen group and interacting with the application running there.

It is commonly thought that applications programmers are at the mercy of the systems designers because applications have to use the facilities provided by the system. Actually, the opposite is true; systems designers must ensure that existing applications continue to run on any new release.

An operating system can only succeed when there is a good selection of popular applications that will run on it. Those applications, in turn, are only written for already successful systems. This catch-22 means that downward compatibility with earlier DOSs is critical to bootstrap OS/2 into the marketplace. OS/2 provides this compatibility by dedicating one of the screen groups as the 3.X box. A lot of effort went into providing DOS 3 compatibility, but there was no question that it had to be there.

In designing OS/2, we had to strike a balance between many sometimes contradictory goals: We had to provide a flexible operating system environment, yet that environment had to be fast. We wanted to provide application programmers with a rich API that would form a stable application base for years to come. But we couldn't do this at the expense of people who have a large investment in applications running under earlier versions of DOS.

We saw the fundamental incompatibility between protected mode and real mode as our one chance to break compatibility with elements of earlier versions of DOS that are unsuitable for a multitasking, networked, protected environment. Since programmers will have to modify their programs slightly to run in protected mode anyway, we took this opportunity to have them modify the programs a bit further and stop undesirable features from being passed on to future versions of the system. Seeing this break in compatibility as a one-time event put us under a lot of pressure, but we believe that with OS/2, we have designed an operating system that we will be able to support for a great many years and releases to come.

by Gordon Letwin

PC LABELING SOFTWARE



Uses:

Epson/IBM/Okidata Printers

- Labels for shelves, bins, inventory
- Text readable up to 50 ft.
- Bar Codes: 1 2 of 5, UPC/ EAN MIL-STD, AIAG, Code 39
- Any size label • Flexible format
- Color options • Reversals • Fast
- File Input • Menu driven • \$49-\$279

30 Day Money Back Guarantee!

WORTHINGTON DATA SOLUTIONS

130 Crespi Court,
Santa Cruz, California 95060
408/458-9938

Bar Code Readers for PC, XT, AT, PS/2



- RS-232 model..... \$399
- SAVE-A-SLOT model..... \$385 (pictured)
- NO-BOX Slot model..... \$339

- Rugged Metal Case & Wand
- Reads 8 different Bar Codes
- Attaches as 2nd Keyboard
- No software needed to add bar code reading to your system

30 Day Money Back Guarantee!

WORTHINGTON DATA SOLUTIONS

130 Crespi Court,
Santa Cruz, California 95060
408/458-9938

soft. A programmer can use a dyna-link package to extend the operating system. He can install it and then call the entry points as though they were part of the operating system. In fact, the system, screen, mouse, and keyboard services are actually dyna-link packages. A program like Microsoft Windows can simply replace the standard screen and keyboard driver with its own so that a program—without knowing it—is then “talking” through Windows.

Scheduling

OS/2 uses a preemptive three-level priority scheduling system. Each task has a set amount of CPU time. Its duration (and how frequently the task is scheduled) depends primarily on the priority category assigned to the task and secondarily on the task’s CPU and I/O usage history. (See the text box “Scheduling Example.”) The three categories are:

- *Forced-run priority.* This category is for top-priority processes that might cause a functional failure unless they produce a response within a given amount of time. A good example is a network program where you’ll be logged off if you don’t respond to a query fast enough.
- *Middle-range priority, foreground and background.* The foreground screen group has control of the system display and keyboard, while background screen groups are not currently on-screen. At any given moment there is only one foreground task, but you can have any number of background tasks.
- *Background priority.* Not to be confused with middle-range background, tasks in this category are the lowest-priority in the system. Simply put, background tasks run in whatever time is left over. (Microsoft said that the designers didn’t have any candidates to run in this category; they added it because it was symmetric with the rest of the scheduling system.)

Within this scheme, the task running in the 3.X box occupies its own category: If an application is running in the 3.X box and you switch it off-screen, it becomes completely inactive. (However, the converse is not true; while the 3.X box application is on-screen, protected-mode tasks continue to execute.) The OS/2 designers do not allow a real-mode application to run when switched off-screen because such an application will probably have no idea it is executing in a multitasking environment.

If a real-mode program switched off-screen were allowed to execute in the background it could continue to write data directly to screen memory, oblit-

erating whatever the foreground task was displaying.

Threads

There are situations in certain applications where it would be useful to have multiple streams of execution within a task, but where it would be inappropriate to spawn child processes. For example, in a spreadsheet program you might want to perform a recalculation of the cells visible on-screen, then—while recalculating the off-screen cells—prompt for more input.

OS/2 allows multiple streams of execution, called *threads*, within a single protected-mode task. Only register contents and stack are private to a thread. Every thread in a process can access all the other resources associated with that process. Consequently, if one thread opens a file, then all the other threads within that task can perform I/O operations on the file.

Since each thread has its own run history, you can assign a priority level to each thread. However, a thread is only visible to the process that created it; hence, no task can alter the priority level of (or kill) another task’s threads.

Interprocess Communications

OS/2 includes a number of sophisticated methods by which tasks can communicate with one another. Anyone who knows Unix is already familiar with the concept of a pipe; OS/2’s pipes are functionally identical to Unix pipes. In brief, a pipe allows for the exchange of data between related processes: Both processes execute concurrently with the data moving through it as a stream of bytes so that a pipe functions as a first-in/first-out data structure. Programs communicate with a pipe as they would a sequential file; the sender opens it for writing (using a standard file-open call) while the receiver opens it for reading.

A queue is a kind of enhanced pipe. It differs from a pipe in that it can be set up between unrelated processes. Queues allow processes to exchange structured rather than serialized data as pipes do. A queue has some additional features such as receipt acknowledgement: When the program at the receiving end of a queue receives the transferred data, the queue informs the sender. Any number of tasks can write to a queue, but only the task that created the queue can read from it.

Shared memory is an unstructured segment of memory that a task creates and designates as being accessible by other tasks. The creating process assigns a unique name to the segment, and other tasks in the system that have this name

continued

Print Master lets people share printers



Get the most out of your expensive resources—your people, your computers and your printers—with Print Master by BayTech. Not only does it let your people and computers share all of your printers, its buffer keeps them working instead of waiting.

Easy to set up, easy to use

Initial setup is menu-prompted and allows you to configure Print Master to your application. You decide which ports are input and which are output. You also set such functions as baud rates, handshaking, timeout, how you select a printer, etc.

After setup, you simply cable Print Master between your computers and printers, and you're ready to go. BayTech's Memory Resident Program lets your PC users select printers via function keys that correspond to a menu window.



Print Master keeps everything running

All users can send data simultaneously to Print Master's dynamically allocated buffer, keeping your people and computers working. This first-in-first-out buffer also sends data to all printers simultaneously to keep them running at full capacity. The buffer size? A big 512K that's expandable to one megabyte.

Eleven models with serial and parallel

An advantage of Print Master is its flexibility: Any port can be a computer port or a printer port. Choose from eleven models with different combinations of serial and parallel ports. Print Master internally converts serial to parallel and vice versa on combination serial/parallel models. Six ports, \$795. Eight ports, \$895. Ten ports, \$995.

Non-buffered models from \$339.
GSA pricing available.

Want details?

Contact your dealer or Bay Technical Associates for information about Print Master and BayTech's complete line of data communications products, proudly made in the U.S.A.



Bay Technical Associates, Inc.
Data Communications Products Division
200 N. Second St., P.O. Box 387
Bay Saint Louis, Mississippi 39520
Telex 910-333-1618 BAYTECH
Phone 601-467-8231 or
800-523-2702

Inquiry 35 for End-Users.
Inquiry 36 for DEALERS ONLY.

Scheduling Example

To give you an idea of OS/2 scheduling methods, let's look at an example arrangement of tasks (see figure A). Screen group 1 is the active screen group, and in it we are executing CMD.EXE. We have launched JOB1, and it has spawned two child tasks, DIR and JOB2. We have also started up a mailer daemon as a separate process that requires no keyboard interaction. Screen group 2, not currently on-screen, is assembling a source code file with the MASM assembler. On the real-mode screen group, we are doing spreadsheet work with Lotus 1-2-3. Finally, on some other screen groups we are running a time-critical network printer-driver task and a true background-priority job that is calculating π out to hundreds of decimal places.

In what order does scheduling take place?

Of course, the time-critical task is top priority, so the network printer driver gets scheduled first (and most frequently). Next come the tasks in screen group 1: JOB1, DIR, and JOB2. If only one of those processes needs to run, then that task is scheduled. However, if all three need to run, then a secondary level of scheduling looks at the run history of the tasks and schedules them based primarily on CPU and I/O usage. (If the operating system sees that a task performed I/O recently, then that task will be scheduled again quickly in the hope that it will do more I/O in the future. Since I/O in OS/2 is interrupt-driven, a task awaiting I/O will release the CPU, making it available for other tasks.)

The mailer daemon is scheduled next, boosted in priority because it is executing in the active screen group. Notice that this task is scheduled behind JOB1, DIR, and JOB2, since it is not interactive with the display or keyboard. MASM, running in an inactive screen group is scheduled next. Finally, the program to calculate π is given any time left over. This task might do well if all other tasks are awaiting keyboard I/O.

Since the real-mode screen group is not active, the 1-2-3 program is not given any CPU time at all. OS/2 gives no time to real-mode applications that are switched off-screen. This is because they might attempt to write directly to screen memory and overwrite the output of whatever program is currently in the foreground.

Figure A: A sample arrangement of tasks within screen groups.

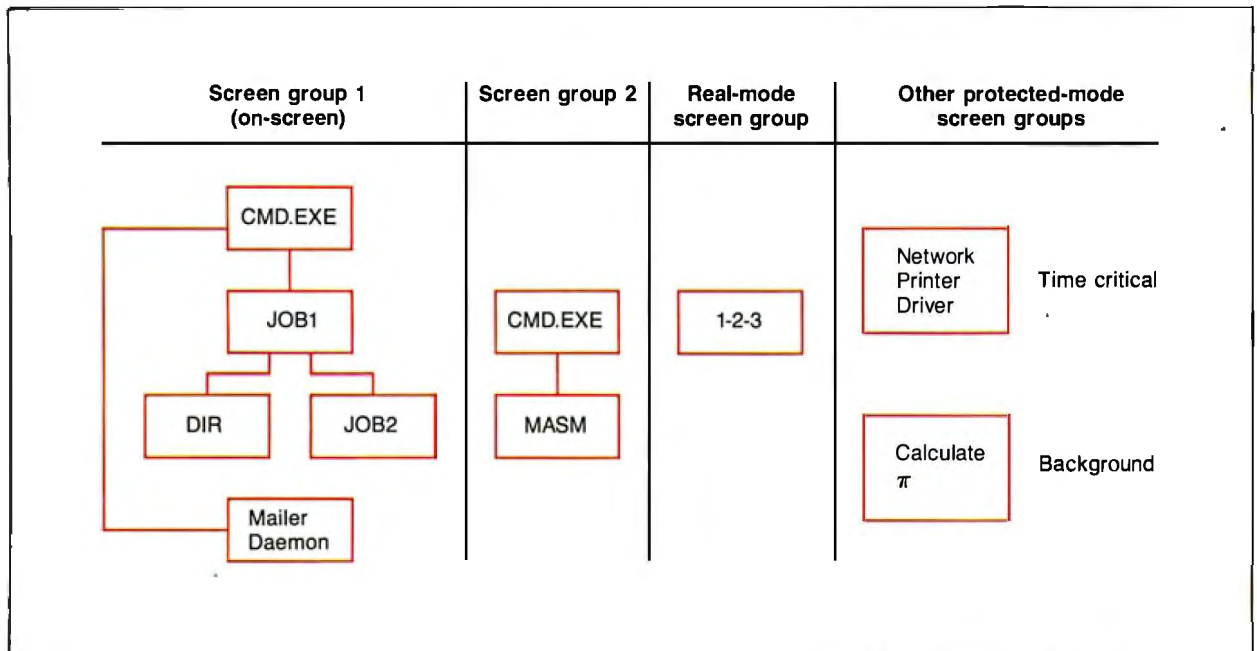

may perform an operating system call to obtain a copy of the segment's selector.

With a flag, one task can trigger an event in another task, as long as the receiving task is set up to receive the flag. In operation, flags are software-generated interrupts similar to Unix signals. Task A defines a flag event and attaches an event-handling routine to it so that when task B triggers the event, task A is interrupted and its event-handling routine takes control.

Semaphores let tasks and threads coordinate accesses to an access-limited resource; only one task at a time can hold a semaphore. As an example, you might set up a semaphore to control access to your printer. When one task calls for use of the printer, it first sets the semaphore. Other tasks that attempt to print will be blocked until the semaphore is cleared.

OS/2 supports two kinds of semaphores: system semaphores and RAM semaphores. System semaphores, though

slower, are more carefully controlled by the operating system. Specifically, a system semaphore won't lock up. If the holder of a system semaphore crashes before it releases the semaphore, the next task waiting in line for the semaphore gets it and can even discover that it was allowed to enter because its predecessor has died.

RAM semaphores are for communication among threads within a task. A RAM

continued

dBASE Users:

DON'T CHANGE A THING! FoxBASE+ does it all.

Ask The Reviewers . . .

**"FoxBASE+ Maintains Stunning Speed, Adds dBASE III PLUS Compatibility . . .
FoxBASE+ zooms to the head of the dBASE-compatible class."**

—Glenn Hart, PC Magazine, December 9, 1986.

"FoxBASE+ is the fastest and easiest-to-use dBASE product on the market."

—George Goley, Data Based Advisor, November 1986.

**"Imagine a dBASE that is at least six times faster . . . 99 and 44/100%
compatible (it doesn't have the bugs) and you have FoxBASE+."**

—Pat Adams, NYPC User's Group Publication
February 1987

**"We now have one answer to the eternal question, 'Which dBASE is fastest?'
The answer is clearly FoxBASE+."**

—Adam B. Green, dBASE Performance Guide
Spring 1987

WHAT FoxBASE+ CAN DO FOR YOU

- **YOU DON'T CHANGE YOUR PROGRAMS.** FoxBASE+ runs your dBASE III PLUS applications more than 6 times faster *without changing one line.*
- Forget about conversion woes. You don't have to do a thing to your databases or other dBASE files to use FoxBASE+.
- You don't have to bend over backward to use FoxBASE+.

It's used in *exactly* the same, familiar, user-friendly way you use dBASE III PLUS. As a dBASE user you already know how to use FoxBASE+.

- FoxBASE+ lets you keep using the best parts of dBASE III PLUS. It's a **fully interactive** compiler so you can still use great features like EDIT, BROWSE, etc.
- FoxBASE+ doesn't make you spend hours compiling and linking your programs like some "speed-up" products.

- FoxBASE+ runs your compiled programs twice as fast as Clipper and 3 times faster than Quicksilver.
- Best of all, Single-user MS-DOS FoxBASE+ costs just \$395 and Multi-user FoxBASE+ \$595 with a **money-back guarantee.** *Royalty-free runtime also available.*

**If you like dBASE III PLUS,
YOU'LL LOVE FoxBASE+ !!**
So call (419) 874-0162 now for the details. After all . . .

Nothing Runs Like a Fox.

FOXBASE™ 

FoxBASE+ is a trademark of Fox Software. dBASE III PLUS is a trademark of Ashton-Tate. Clipper is a trademark of Nantucket. Quicksilver is a trademark of WordTech Systems Inc. MS is a registered trademark of Microsoft Corporation.

Fox Software
27493 Holiday Lane, Perrysburg, OH 43551
(419) 874-0162 Telex 6503040827

Family API provides a compatibility bridge between the two sides of OS/2, giving products an easy way to migrate to OS/2's protected area.

semaphore exists in a piece of memory shared by the threads and, since it is entirely RAM-based, it operates faster than a system semaphore.

Note that the interprocess communication features of OS/2 have added a host of new data structures that must exist in a multitasking world. Each individual queue, semaphore, and shared memory segment must have a unique name and access to them has to be controlled. The designers of OS/2 have therefore devised the idea of the file-system name space: a concept that extends the method by which disk files are named to include any object in the system that requires a name. The syntax that governs disk file-naming conventions now controls queues, semaphores, and shared-memory segments. (For example, to create a queue, you must specify its name by including the prefix `\ QUEUES \`—a valid queue name might be `\ QUEUES \ payroll.dat.`)

As a result, file-permission mechanisms that Microsoft hopes to add in a future version of OS/2 will apply immediately to shared data structures. The networking architecture in OS/2 lets you call a file that is on another machine in the network as easily as if it were on one of your local disk drives. Thanks to the file-name space, you will be able to name queues across the network, so that a task on your machine could send data through a queue to a task on another machine. (This feature is not scheduled to be available in the first release of OS/2.) Additionally, since semaphores are named items, this paves the way for a future release that would make them pseudofiles (a component of the semaphore would be recorded on the disk). This would make semaphores easier to manipulate. Also, if the system crashes, a critical semaphore could be saved and then restored to its former permission level when the system was brought back up. (Currently, Microsoft has no plans to allow shared memory to be accessible across the network.)

Monitors

One problem that arises from OS/2's virtualization of the screen and keyboard is

that it creates an insulating layer between an application and its hardware. Often, a programmer would like to directly inspect and modify the stream of data passing through a device driver (prior to any filtering that the driver might perform). Take, for example, a keyboard device driver that outputs ASCII sequences. Since there are no ASCII sequences that use the Caps-Lock key, a program that indicates on-screen that the Caps-Lock key is engaged (several popular word-processing and spreadsheet programs do this) would be unable to determine the state of that key from the output of such a driver.

A monitor is a program you attach to a device driver that has access to all the characters passing through the driver. A monitor can remove or add characters, or simply watch them go by in the data stream moving through a device driver. You can attach more than one monitor to a single device driver; OS/2 provides routines for registering a monitor with a device driver so you can set up an entire chain of monitors with complete control over the order in which the monitors gain access to the data stream.

Note that monitors let you actually add code to the device driver. And, because the monitor receives data from the device driver, modifies it, and passes it back to the driver, the monitor's presence is invisible to any processes using the driver. (The OS/2 designers said that monitors allowed more global action than they liked; here is a means by which one task could affect another. However, there were strong demands for monitors—Superkey and SideKick need this kind of interaction with the hardware that monitors furnish.)

Since the operating system virtualizes the keyboard, each screen group appears to have its own keyboard device driver and no interaction problems occur when different screen groups register their own keyboard monitors. The designers of OS/2 had to program the keyboard driver so that monitors could not remove the "hot key" (the key used to switch screen groups) from the data stream; otherwise, a monitor could lock a screen group onto the screen.

Family API

Microsoft has designated a subset of the function calls available to the OS/2 protected-mode programs as the Family API. Microsoft chose the members of this subset so that programmers could write applications that would run under both OS/2 and DOS 3 (and of course, the 3.X box).

Since Family API-compatible applications can run under DOS 3, this means

that Family API functions do not provide access to any of OS/2's multitasking features (e.g., semaphores and queues). However, this does provide a compatibility bridge between the two sides of OS/2, giving current products an easy way to migrate to OS/2's protected-mode area. (See the text box, "New .EXE Format" for further information.)

Performance Issues

Performance was a top priority in the design of OS/2, and providing it within a multitasking environment is more difficult than you might think. Consider the following scenario: Suppose two protected-mode tasks are running under OS/2. One makes a request to the operating system for a block of memory, and the operating system determines that there is no single block of free memory large enough to satisfy the request. So the operating system begins moving segments in a compaction process (to consolidate the fragmented free memory space), which might take up to 30 milliseconds. But then a task with a forced-run priority level asks to be scheduled and the operating system must grant the request within 5 ms. A dilemma arises: What happens if the second task asks for access to one of the segments being moved?

OS/2 solves this by marking the segment being moved as being swapped out. It then puts another mark on the segment, indicating that the segment is in the middle of being moved. OS/2 then transfers control to the time-critical task. Now, if the task requests the marked segment again, it gets a segment-swapped-out fault. When the operating system's fault handler takes control, it examines the situation and sees the true cause of the fault. It then completes the move and tells the operating system "I have finished moving this segment for you," and finally returns control to the time-critical task.

An important goal for the OS/2 design team was to ensure that I/O throughput was kept as high as possible. OS/2's new video I/O routines are much faster than the old screen-interrupt routines; only a few programs might find the new routines too slow (in the past, most commercial applications sidestepped the DOS screen routines).

But suppose you have written a program that wants to output to the screen and needs the throughput that it can obtain only by writing directly to screen memory. This is at best a difficult job in any multitasking system. In OS/2's virtual screen environment, accessing video memory directly is particularly dangerous since the user might switch screen

continued

STATGRAPHICS®

NOW!
Faster, More Procedures,
Improved Data Management!

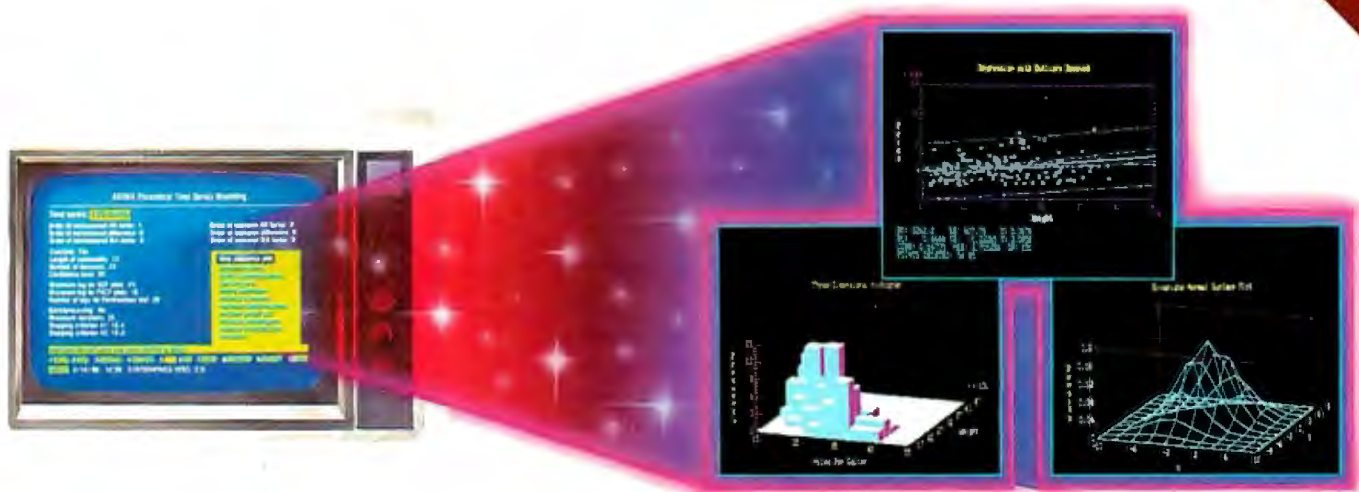

Powerful Statistics, Sophisticated Graphics In One Complete Software System

STATGRAPHICS from STSC is simply the most complete and powerful statistical software available for your PC. STATGRAPHICS integrates powerful statistics with high-resolution color graphics—in one single software system—to give you an extraordinarily powerful analytical environment.

"[STATGRAPHICS] is unusually complete as software systems go in terms of statistical capabilities."
(PC Week)

With more than 250 statistical and mathematical procedures, STATGRAPHICS offers you the power and precision of mainframe software—right on your PC. All the tools you need for comprehensive statistical analysis: ANOVA, complete regression analysis, experimental design, quality control procedures, multivariate techniques, nonparametric methods, and extensive forecasting and time series analysis, including Box-Jenkins.

"I've found STATGRAPHICS to be one of the most complete and easy-to-use statistics programs that I have come across."

(Whole Earth Software Catalog)

All this statistical power is even more valuable with STATGRAPHICS' unique interactive environment. STATGRAPHICS is completely menu-driven so you can get into your statistical analysis work quickly and be productive right from the start. You can easily go back and forth between your numerical and graphical analysis—change variables as many times as you want—and see the effect immediately.

You can also enter and access data easily. STATGRAPHICS has a full-screen data editor and interfaces with standard ASCII files, Lotus® 1-2-3® and Symphony® worksheets, and dBASE® files.

"Verdict: [STATGRAPHICS is] a model PC software system which will set standards for PC statistical software."

(PC User Magazine)

STATGRAPHICS offers you a wide variety of graphics capabilities to help you visually analyze your data—more options and more sophistication than any other PC statistical software. Included are histograms, two- and three-dimensional line and surface plots, scatter plots, time sequence plots, quality control charts, as well as bar and pie charts. STATGRAPHICS supports a wide range of graphics boards, printers, and plotters.

For the most complete, advanced statistical graphics software system available, order STATGRAPHICS today. To order, contact your local dealer. If they don't have it, tell them to call STSC toll-free.

(800) 592-0050
In Maryland or Canada call **(301) 984-5123**.

STATGRAPHICS—the best overall choice!

	Integrated Statistical Graphics	Direct Lotus & dBASE Interfaces	Menu-Driven	Minimum Hardware Required	Helpline Support	U.S. Suggested Retail Price
STATGRAPHICS	✓	✓	✓	Dual Floppy Disk	✓	\$795*
SPSS/PC+™	NO	NO	NO	10 Meg Hard Disk	✓	\$1385
SAS/PC	NO	NO	✓	20 Meg Hard Disk	✓	\$2700+ Annual Maintenance Fee

Data compiled as of April 1986

STSC Inquiry 299

Available nationally through Softsel and distributors worldwide. Dealer inquiries welcome.

*International prices slightly higher. STATGRAPHICS, SAS, and dBASE are registered trademarks of Statistical Graphics Corporation, SAS Institute Inc., and Ashton-Tote, respectively. Lotus, 1-2-3, and Symphony are registered trademarks of Lotus Development Corp. PLUS*WARE and SPSS/PC+ are trademarks of STSC, Inc. and SPSS Inc., respectively.

A PLUS*WARE™ PRODUCT

New .EXE Format

With the development of the Family API definition, Microsoft has enabled developers to write code that operates either in the DOS 3 or as a protected-mode application under OS/2. However, don't get the idea that you need only recompile existing 3.X applications into the new .EXE format to get them to run on the protected-mode side of OS/2. You will also have to recode the operating system calls to comply with the Family API specifications. The designers of OS/2 created an executable file format that both the protected-mode or real-mode sides of the operating system can read. Figure A shows a simplified diagram of this new .EXE file format.

This format is a superset of the structure of .EXE files in current versions of MS-DOS. If you are running in the protected-mode side of OS/2 and you execute a new .EXE file, the operating system looks at a value stored at a specific location in the old .EXE header portion of the file and determines that the file is in the new .EXE format. In this case, the operating system ignores the stub loader and library routines and loads the user program. OS/2 then fixes up any dynalink references that must be satisfied at load time and passes control to the program.

However, if you execute such a file under DOS 3, the entire file is brought into memory (the DOS 3 loader assumes that the file is in the old .EXE format). Control then transfers to the stub loader. The library routines are DOS 3 imple-

mentations of Family API dynalink library routines, and the stub loader code reroutes the program's dynalink references to point to this library code. Finally, the user program gains control and executes.

Figure A: Diagram of the new .EXE file format. Files conforming to this arrangement will run in both the real-mode and protected-mode sides of OS/2.

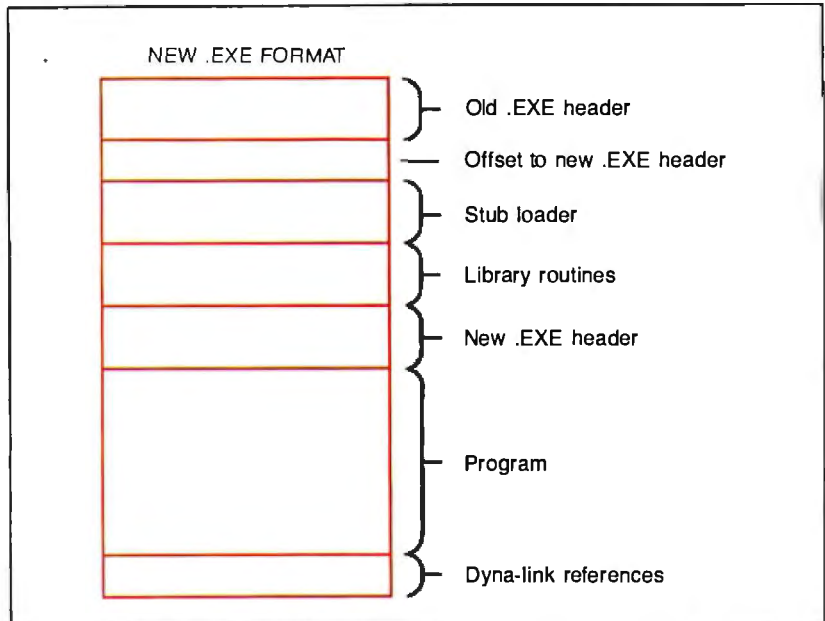

groups in the middle of a screen write.

To handle this situation, OS/2 provides a function that programs can call to obtain exclusive access to the display. The function returns a value indicating that the calling program has access to the screen; it is then that program's responsibility to perform its I/O as quickly as possible and release the screen. (There is a time-out period to guard against a program's grabbing the screen and never releasing it.) During the time that the program has control of the display, the system hot key is disabled.

A Transitional Product

OS/2 provides a high degree of compatibility with the existing software base without compromising the robust API for developers of future applications.

Compatibility has become such a powerful consideration in the microcomputer industry that a staggering amount of work is being directed toward that end: The designers of OS/2 said that over half of their effort went into providing the 3.X box. Parallels elsewhere in the industry

include the Apple IIGS, where a major portion of the design effort was devoted to maintaining compatibility with the Apple II series; the Mac II, where special provisions had to be devised to support the "old" 24-bit addressing of the Macintosh within the Mac II's new 32-bit architecture (firmware routines compatible with those in the Mac and Mac Plus were also incorporated in the system ROMs); and the Amiga 2000, with its A2000 board and dual-bus architecture specifically for the support of IBM PC hardware and software.

The new DOS raises some questions about which computer you should buy and for which application interface you should write programs. Since this operating system can run on the 80386 as well as the 80286, it might make sense to purchase a more costly 80386 machine with an eye on the future full-blown 80386 version of the operating system that is sure to come. If you are a programmer working under MS-DOS, you must now choose whether to wait for the next operating system, in the hope that the transi-

tion away from the limitations of the old MS-DOS will soon be complete, or use one of the current environments for the applications you create:

- Microsoft Windows.
- DOS 3—this would ensure not only that your programs could run on IBM PCs and PC XT's but also in OS/2's 3.X box.
- The new protected-mode side of OS/2—write your programs for this environment and you jump aboard the train headed for a new, more versatile 80386 operating system. (The Family API construct provides some help in choosing between these last two choices.)

OS/2 is a transitional product. It bridges the 16-bit single-tasking world built on the shoulders of CP/M to the 32-bit multitasking realm of fundamentally different operating systems to come—a transition that might span two years. We hope the flexibility that OS/2's designers have incorporated will allow those of us who will use it to handle this transition smoothly. ■

With all these SoftLogic Solutions, you could run out of problems.

Now there's a whole family of low-cost, easy to use SoftLogic Software for the IBM PC, XT, AT, and compatibles. They'll save you time, aggravation, and lots of money. Got a problem? Check out these SoftLogic Solutions.



Software Carousel™—The easy way to move from one program to another.

Now keep up to ten different programs loaded and ready to run—and switch from one to another in an instant. Plus use all available memory with each and every program. Supports AboveBoard™ and RAMPage™. New Version 2 is even faster and more powerful.
\$59.95*

Disk Optimizer™—Speeds up your disk by cleaning up your files.

You may not notice, but your hard disk is getting slower. Because your files keep getting fragmented and scattered on your disk. Disk Optimizer puts back the speed by putting your files back in one piece—where they belong. Now faster, with even more powerful features.

\$59.95*



Cubit™—Packs more of your data onto less disk space.

Filling up your hard disk again? Don't run out and get a bigger drive. Get Cubit, and get up to twice the storage capacity from the drive you already have. Cubit compresses and decompresses word processor, spreadsheet, database, all kinds of files—quickly, safely, invisibly.

\$49.95*

DoubleDOS™—The multitasking software that takes less of everything.

You can spend more money, load more memory, and read more manuals with systems like TopView™ or Windows™. Or you can get DoubleDOS, the amazing concurrent software system that lets you and your computer each work on different tasks at once.

\$49.95*

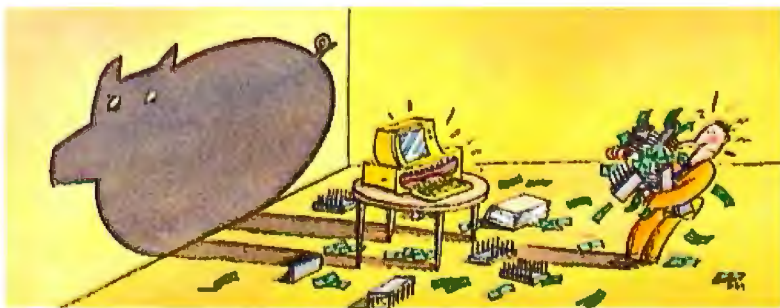

Put your problems behind you! Order today!

Look for SoftLogic products at better computer dealers everywhere.
Or order direct from SoftLogic Solutions by calling

800-272-9900
(603-627-9900 in NH).

**SOFTLOGIC
SOLUTIONS**

SoftLogic Solutions, Inc.
One Perimeter Road
Manchester, NH 03103

*plus \$5.00 shipping and handling.

(Not Copy Protected)

© 1987 SoftLogic Solutions, Inc.
™ signifies manufacturer's trademark.

Inquiry 285

JUNE 1987 • B Y T E 127

12 MHz SPEED!

For your PC, XT, AT
or compatible.

FastCACHE-286™ The Fastest PC Accelerator!

FastCACHE-286 is the fastest half card accelerator ever built. It is also the first to have an on-board 8088 socket, built-in high-speed 80287 clock, and software controlled slow and fast 80286 modes. FastCACHE-286 accelerates the IBM PC, XT and compatibles. It can be purchased in either a 9 or 12 MHz version starting at \$399 (9 MHz). The card combines the best features of our 286TurboCACHE™ (*PC Magazine* "Editor's Choice") with the ability to run asynchronously. This frees it from the 7.2 MHz frequency barrier of synchronous cache cards and enables the board to run on dual-speed motherboards and PCs such as the Zenith 158 or the Leading Edge Model D! The board includes MicroWay's DCache software and is compatible with all PC software and EMS, EEMS, and EGA.

	SI	Sieve MS C (sec)	Shuttle Regen (sec)	Price
PC	1.0	5.88	100 (12)*	-
9 MHz FastCACHE-286	7.1	1.32	28 (7)*	\$399
12 MHz FastCACHE-286	10.3	.93	22 (6)*	\$599

*Times in parentheses are with an 8087 or 80287.

MICROWAY . . . Respected throughout the industry for high quality engineering, service and technical support.
Dealer, VAR, university and corporate inquiries are welcome.

Micro Way

Inquiry 191

FastCACHE-286, 287Turbo, 287TurboPLUS and 286TurboCACHE are trademarks of MicroWay, Inc. MicroWay is a registered trademark of MicroWay, Inc.

287TurboPLUS™ Speeds Up your 80287 and your 80286!

287TurboPLUS adds a new feature to *PC Magazine* Editor's Choice - 287Turbo. 287Turbo increases 80287 speed from the 4 MHz used by IBM to 10 or 12 MHz. It has become an industry standard used in the AT, clones and the 386 Deskpro. 287TurboPLUS lets a user control the 80286 clock speed of the AT motherboard. Typical ATs will run up to 9 or 10 MHz. When used with 100 nsec DRAM and an optional high speed 80286 it is possible to get 11 MHz speed from an AT. 287TurboPLUS includes a 10 or 12 MHz tested 80287, 80287 diagnostic software and easily installs in your 80287 socket.

The World Leader in 8087 Support

P.O. Box 79, Kingston, Mass. 02364 USA (617) 746-7341
32 High St., Kingston-Upon-Thames, England, 01-541-5466

Steve Ciarcia

Part 2: Digitizer/Transmitter

Build a Gray-Scale Video Digitizer

An imaging system with remarkable features for the price

Last month I described the ImageWise video digitizer's display/receiver section. The display/receiver board accepts binary data from a serial RS-232 port and decodes that data to generate a gray-level display (with 64 levels) on a standard TV monitor. This month I'll complete the project by describing the digitizer/transmitter board (see photo 1) and discussing some possible applications. (Note: Certain portions of this article depend heavily on material presented in last month's Circuit Cellar.)

As I mentioned last month, ImageWise is technically a "field" grabber rather than a "frame" grabber. The digitizer/transmitter board makes no distinction between the two fields in a frame: One is as good as the other. The digitizer/transmitter must decide when a new field is starting, wait until the first active line begins, then begin converting the analog video signal into digital bytes that are stored into the field buffer. Because the video can't be "slowed down," all this must happen when the video occurs rather than when the processor is ready.

You might think that you could locate the start of the first active video line by counting horizontal sync pulses after the conclusion of the vertical sync pulse, but it's not that easy. Some cameras do not produce "standard-width" vertical sync pulses, so counting pulses won't work. Instead, I used an internal timer on the

Steve Ciarcia (pronounced "see-ARE-see-ah") is an electronics engineer and computer consultant with experience in process control, digital design, nuclear instrumentation, and product development. The author of several books on electronics, he can be reached at P.O. Box 582, Glastonbury, CT 06033.

8031 to provide a fixed delay period (DIP-switch-selectable, either 16- or 20-line times). The first horizontal sync pulse after that delay becomes the first active line to be digitized.

Digitizer/Transmitter Hardware

The digitizer/transmitter has two main functions. First, it digitizes the analog video signal; second, it transmits the data to the display/receiver over a serial RS-232 link. Figure 1 shows the digitizer/transmitter circuitry.

The analog circuitry merits a detailed description. Many people who are familiar with the level of integration possible in digital circuitry are appalled at the number of components needed to accomplish even the simplest analog task. The whole mass of circuitry attached to the analog video input performs five functions: termination, clamping, filtering, buffering, and level comparison.

Standard composite video is communicated over coaxial cable with a character-

continued

Photo 1: *The ImageWise digitizer/transmitter in prototype printed circuit form. The digitizer/transmitter board flash-digitizes the video output of a TV camera or other video source (connectors in upper right corner) and converts it to serial data that can be stored and manipulated by a computer or redisplayed on an ImageWise display/receiver board (see last month's Circuit Cellar). The flash A/D converter is the 18-pin chip in the upper right corner; the two 28-pin chips on the left are 64K bytes of static RAM.*

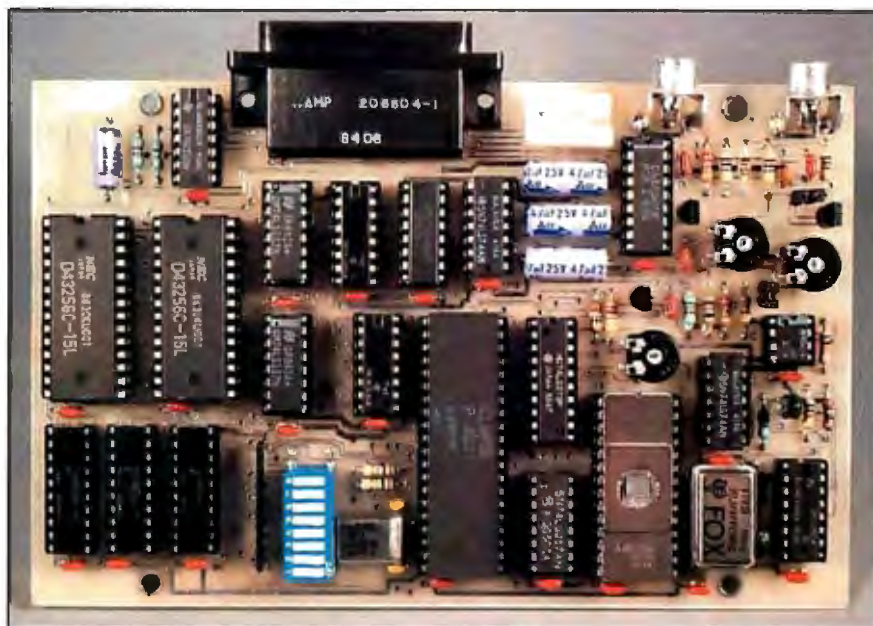

istic impedance of 75 ohms. To prevent reflections from the end of the cable, it must be terminated in that impedance. The 75-ohm resistor at the video-input connector of the digitizer/transmitter (J3 and J4) accomplishes this goal. A jumper (JP1) disconnects the terminator if you

have a terminated device (perhaps a monitor to watch "live" video) connected to the second parallel connector.

Video signals never seem to exhibit "textbook" profiles. Frequently, inexpensive cameras produce video signals with a DC offset that depends on the

scene being viewed. The digitizer incorporates clamping circuitry that forces the tips of the sync pulses to 0 volts. This means that the brightest white will be in the area of 1 to 1.4 V (different cameras give different results).

Both color and black-and-white sig-

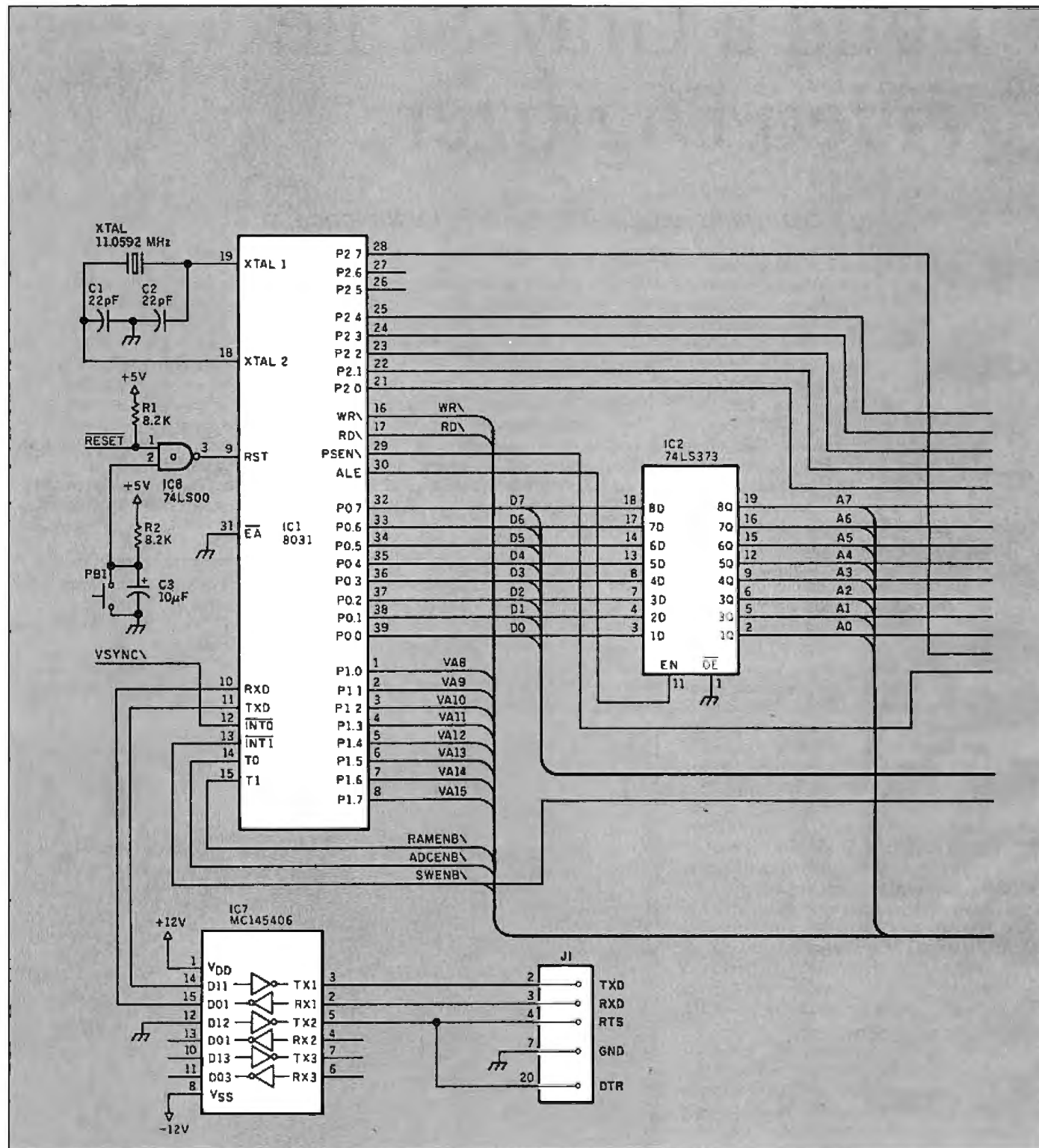

Figure 1: Schematic for the ImageWise digitizer/transmitter board.

CIRCUIT CELLAR

nals will work with the ImageWise digitizer; however, a color signal contains more information than is necessary. This extra color information is detrimental because it can impart a herringbone pattern on the black-and-white digitized image. I solved this problem by using a filter that

removes the frequencies used to encode the color. The remaining signal contains the important intensity voltage that the digitizer measures. You should disconnect this color filter (jumper-selectable JP2) when using a black-and-white camera because the filter doesn't have a sharp

cutoff, and it can "soften" the picture by removing some of the finer details. Try it both ways and use the jumper setting that works best for your application.

The 2N4401 transistor serves as a power amplifier to ensure that the re-

continued

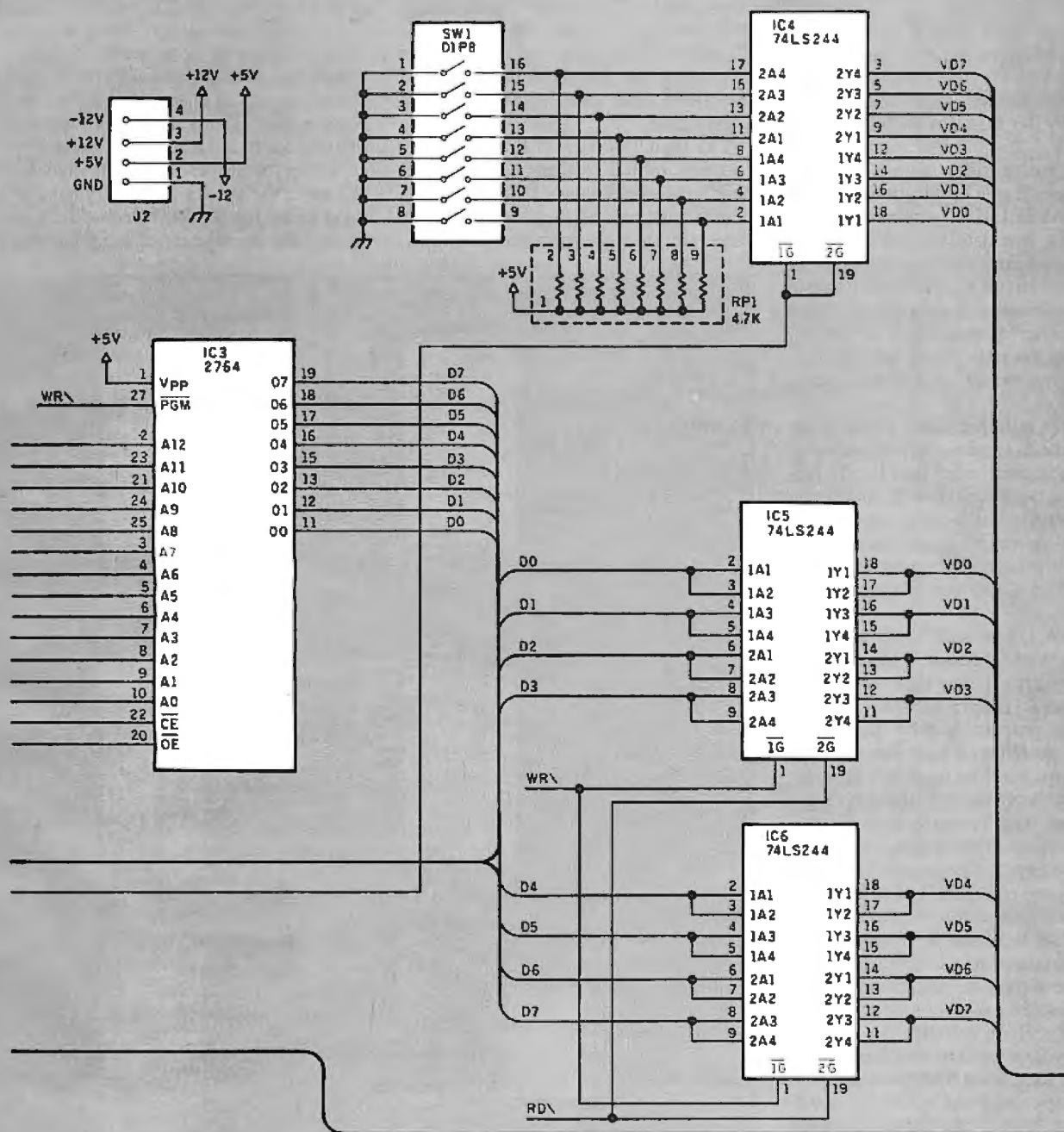

A flash A/D converter differs from slower converters in having more internal circuitry.

maining circuitry gets a clean signal without loading the input. Configured as an emitter follower, this transistor circuit supplies the relatively high input current required by the RCA CA3306 flash A/D converter.

A composite video signal contains both video and synchronization information. I used an LM311 comparator configured as a sync detector. Whenever the video drops below 200 millivolts (set by the resistors on pin 3), the LM311 output goes low. Because the clamping circuit forces the sync tips to ground, the LM311 output goes low only during horizontal or vertical sync pulses and never during video data.

Next, the buffered video signal is directed to the A/D converter. As we've already established, video data is extremely fast, and therefore the A/D conversion must be equally fast. I chose the CA3306 6-bit A/D converter for reasons of economy and the existence of readily available sources. The CA3306 is a special flash A/D converter.

A flash A/D converter is different from slower converters because it has more internal circuitry. Rather than use a D/A converter as an integral component in the conversion process, a 6-bit flash A/D converter contains 64 individual voltage comparators, each set to trigger at a specific level. Sophisticated decoding logic determines which comparator is triggered as a result of the applied signal and outputs the appropriate binary code. The ultimate speed of a flash A/D converter is the reaction time of the comparators and the decoding logic and is independent of any system clocks or other timing signals. In the case of the CA3306, its conversion time is 55 to 83 nanoseconds, or 12 million to 18 million samples per second. The ImageWise system requires a converter that samples at 5 megahertz.

The output of the CA3306 is 6 bits within a relative range defined between $+V^{ref}$ and $-V^{ref}$. Most often these limits are +5 V to +8 V and ground. Because we are digitizing only 64 gray levels, however, it is worthwhile to include only the active video range of +0.2 V to +1.5 V. This is easily accomplished with the white ($+V^{ref}$) and black ($-V^{ref}$) trim potentiometers that adjust the CA3306's conversion thresholds so that a bright

white will be digitized as hexadecimal 3F and dark black will be hexadecimal 00. I'll describe the adjustment procedure later.

Finally, the delay trim potentiometer (R21) determines the blanking delay from the start of each horizontal sync pulse, which must be adjusted to match the camera. Video conversion begins when the LS221 one-shot times out. It ends exactly 256 pixels later. IC20 is a 20-MHz oscillator that is divided by four to produce the 200-ns clock that drives the pixel counters and supplies the RAM write signal.

The digital portion of the transmitter board is similar to that of the receiver board (see last month's article). Both boards must process the video data in the same way, albeit in opposite directions,

so much of the circuitry can be the same.

Without the 8254 counter/timer used on the receiver board, fewer control lines were needed, so I was able to eliminate the 74LS138 decoder. Two 74LS244s isolate the processor data lines from the video data lines, and a third 74LS244 buffers the option switches. An 11.059-MHz crystal lets the 8031 receive and generate standard RS-232 bit rates.

As I mentioned earlier, the input video must be sampled at a rate of 5 MHz, which translates to around 200 ns between samples. A check of the 8031's execution speed shows there is no way that the processor can read the A/D converter, set up the proper address in memory, and store the byte in 200 ns. I chose instead to use the 8031 to select which line is currently being scanned and set up that

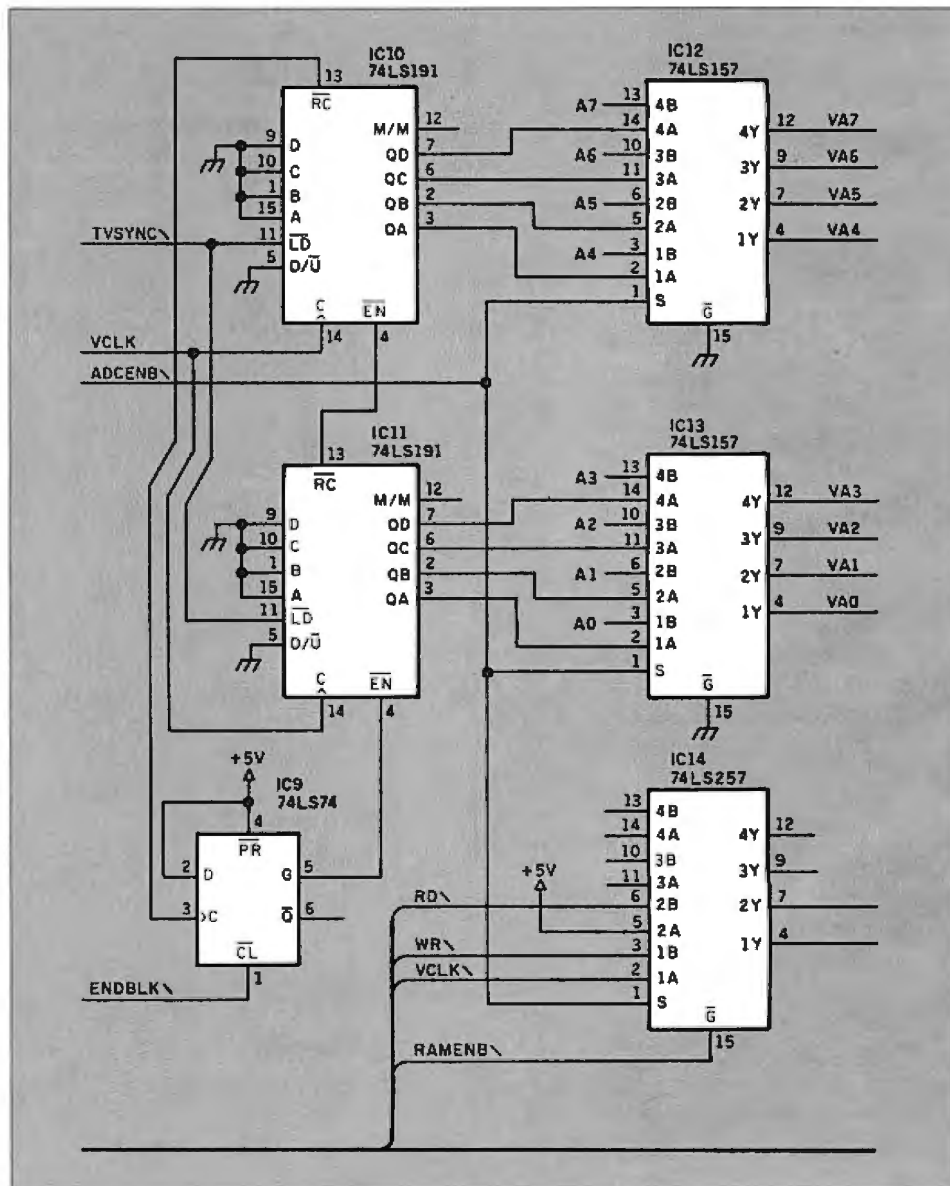

Figure 1: Continued.

address in the upper 8 bits of the memory address. Two 74LS191 4-bit counters provide the lower 8 bits automatically. At the start of each scan line, the counters are cleared, and the 8031 sets up the line number. After each pixel has been digitized and stored, the counters increment the address. Since there are about 66 microseconds between the start of each scan line, the processor has plenty of breathing room.

The 74LS257 ensures that we are always writing to the RAM during digitization. Normal processor reads and writes can be performed at any other time for image transmission or other processing.

The Software Connection

The digitizer/transmitter software is a simple loop that captures a video field in

the RAM buffer, then compresses and transmits the data via serial RS-232. A DIP-switch setting determines whether the digitizer/transmitter will transmit continuously or wait for an XON from the display/receiver before starting each field (see table 1).

The software begins video data capture when it detects the first vertical sync pulse in a field, as described above. The program then waits for the vertical-blanking delay (determined by using the 8031's internal timer) before enabling the RAMs and the A/D converter. Next, the program counts sync pulses and increments the RAM line address after each pulse. When the buffer is full, it disables the RAMs and the A/D converter to prevent further buffer writes.

The flowchart shown in figure 2 de-

The software captures a video field, then it compresses and transmits the data.

scribes the process used to compress the video data in each line. Notice that a unique sync byte designates the start of the field and the line within the field, as well as the end of the video data.

Getting Started

Assuming that you have an ImageWise display/receiver in good working order from last month's project, use the procedure that follows to make your first digitized video connection.

First, connect the camera to the monitor (a coaxial cable without any fancy hardware between) and get a picture that's well-lighted and focused. The adage about "garbage in, garbage out" certainly applies to this operation! Make sure that you've got the monitor terminated in 75 ohms.

Connect the display/receiver to the monitor (remember to disconnect the camera first). Set the DIP switches to 28.8 kilobits per second and no time-out (continuous pictures; see last month's article for a DIP-switch-setting guide for the display/receiver).

Turn the video level (R8) trim potentiometer to midrange and then plug in the power. Do not connect the digitizer/transmitter. The display/receiver will display a diagonal test pattern that includes a gray scale ranging from full white to full black. Adjust the video level trim potentiometer so that the monitor shows the complete range of shades. You may have to tinker with the monitor's hold, brightness, and contrast controls.

Connect the camera to the digitizer/transmitter and install the 75-ohm terminator jumper (JP1). If you're using a color camera, install the color filter jumper (JP2); otherwise, remove it. Set the DIP switches to

- 28.8k bps
- 16-line vertical delay
- Compression enabled
- Ignore +/- 1 count changes
- Paced mode disabled

Turn the delay (R21), black level (R18), and white level (R14) trim potentiometers to midrange; connect a serial cable between the digitizer/transmitter and display/receiver; and plug in the power. (Note: Set up the serial cable so that pins

continued

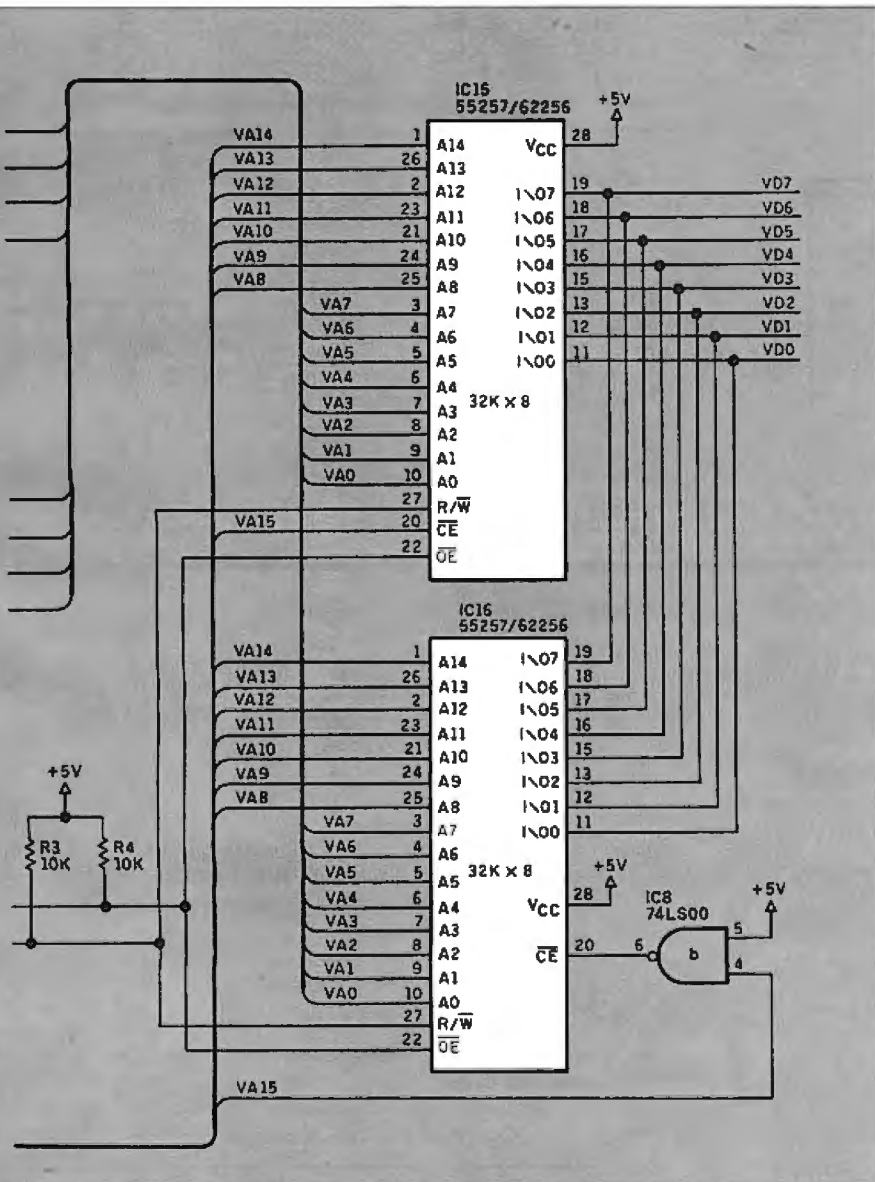

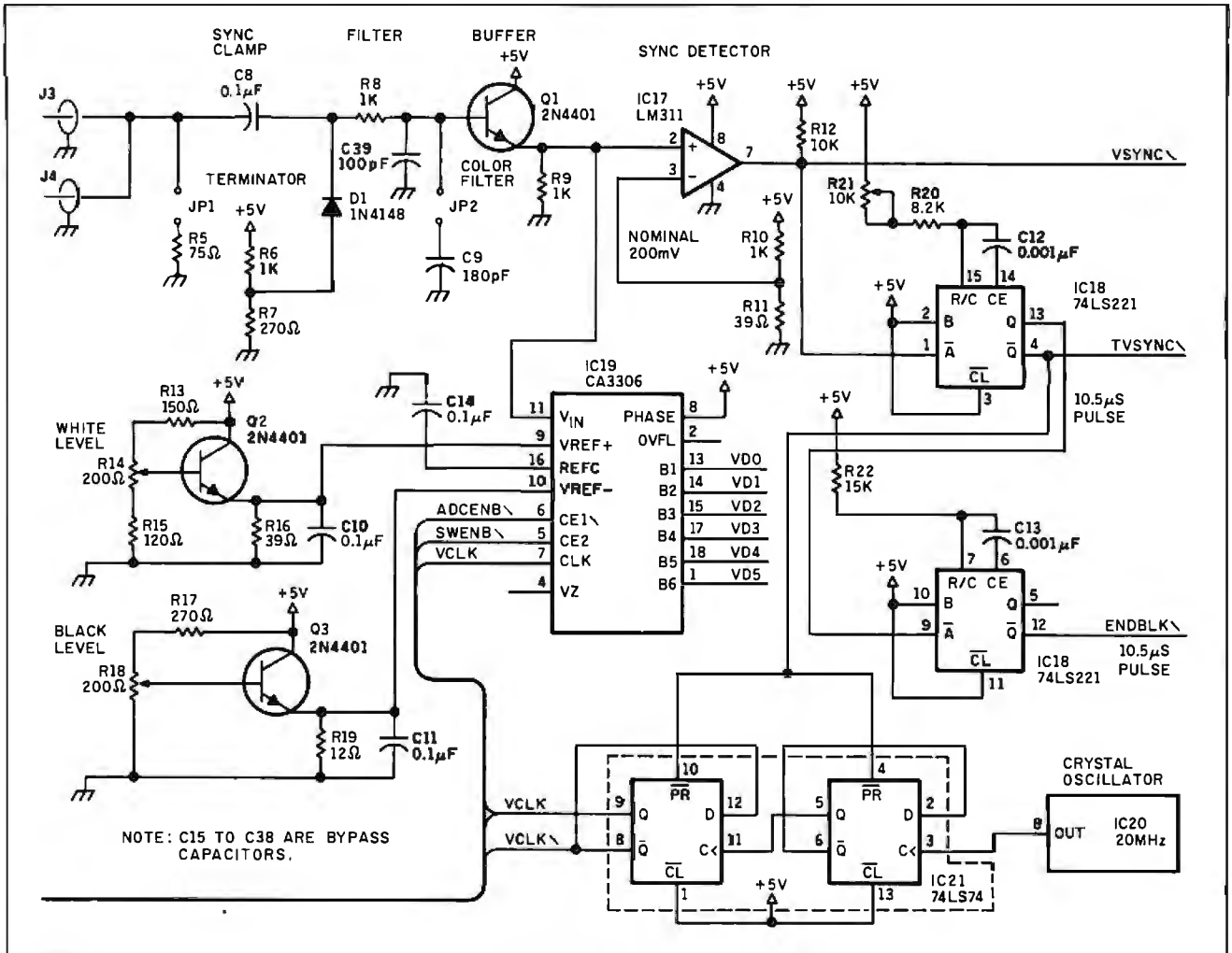

Figure 1: Continued.

Table 1: ImageWise digitizer/transmitter DIP-switch settings. ON and OFF refer to switch positions.

Switches 1, 2, and 3 select the serial bit rate (must match the receiver's rate).

1	2	3	Serial bit rate (must match receiver rate)
OFF	OFF	OFF	300 bps
OFF	OFF	ON	600 bps
OFF	ON	OFF	1200 bps
OFF	ON	ON	2400 bps
ON	OFF	OFF	9600 bps
ON	OFF	ON	19.2k bps
ON	ON	OFF	28.8k bps
ON	ON	ON	57.6k bps

(Note: 4800 bps was intentionally omitted.)

(Note: Switches 7 and 8 are not used and must be OFF.)

Switch 4 selects the vertical blanking delay from the first vertical sync pulse.

4	Vertical blanking delay
OFF	16 lines (normal)
ON	20 lines (extended)

Switch 5 enables or disables picture compression.

5	Run-length encoding
OFF	disabled (no compression)
ON	enabled (compression)

Switch 6 enables or disables the +/- 1 count change compression.

6	Compress +/- 1 count changes
OFF	encode (less compression)
ON	ignore (more compression)

2 and 3 are exchanged and pins 5 and 7 are straight through.) You should see the digitized picture appearing on the monitor, painting from top to bottom. After the entire scene is done, another image will be sent. You'll be able to see a horizontal line marking the descending edge of the new picture overlaying the old one.

You should now adjust the black and white trim potentiometers to get the maximum amount of detail in the picture. If the black level is too high (clockwise), dark areas will have little detail, and the whole picture will be dark. If the white level is too low (counterclockwise), the bright areas will suffer, and the picture will be light. You should have a high-contrast scene in front of the camera to make sure you have the right levels. (On the other hand, don't make the black level too low or the white level too high, because that will reduce the number of digi-

tal levels in your scene. For example, if your camera's highest voltage is 1.4 V, it does no good to have the white setting at 2.0 V; that 0.6-V difference contains some digital codes that will never be used.)

Adjust the delay trim potentiometer so that the scene is horizontally centered on the monitor. If your monitor has a great deal of overscan, it won't matter too much what the delay setting is. You can also adjust the monitor's horizontal hold knob slightly.

If a line of trash (there's no better way to describe it) appears at the top of the monitor's display, try setting the digitizer/transmitter DIP switch for 20 lines of vertical delay instead of 16. Some cameras produce a few lines of trash at the beginning of the field, and the digitizer/transmitter faithfully digitizes it. If you don't see anything, or if the trash moves

to the bottom, leave the DIP switch set for 16 lines.

If you have a monitor connected to the camera (a viewfinder doesn't count), you must make sure that either the monitor is terminated or the termination jumper is installed, but not both or neither. You should terminate the device at the end of the camera cable, not the one in the middle.

You may want to try the filter jumper to see what effect it has on the scene. If you have a color camera, the filter is probably going to be essential; if you have a monochrome camera, you may simply like a softer picture. Do not confuse the effect of the filter jumper with the output of an unfocused camera; make sure the scene is crisp to start with.

Try flipping the digitizer/transmitter switch that ignores +/-1 count changes *continued*

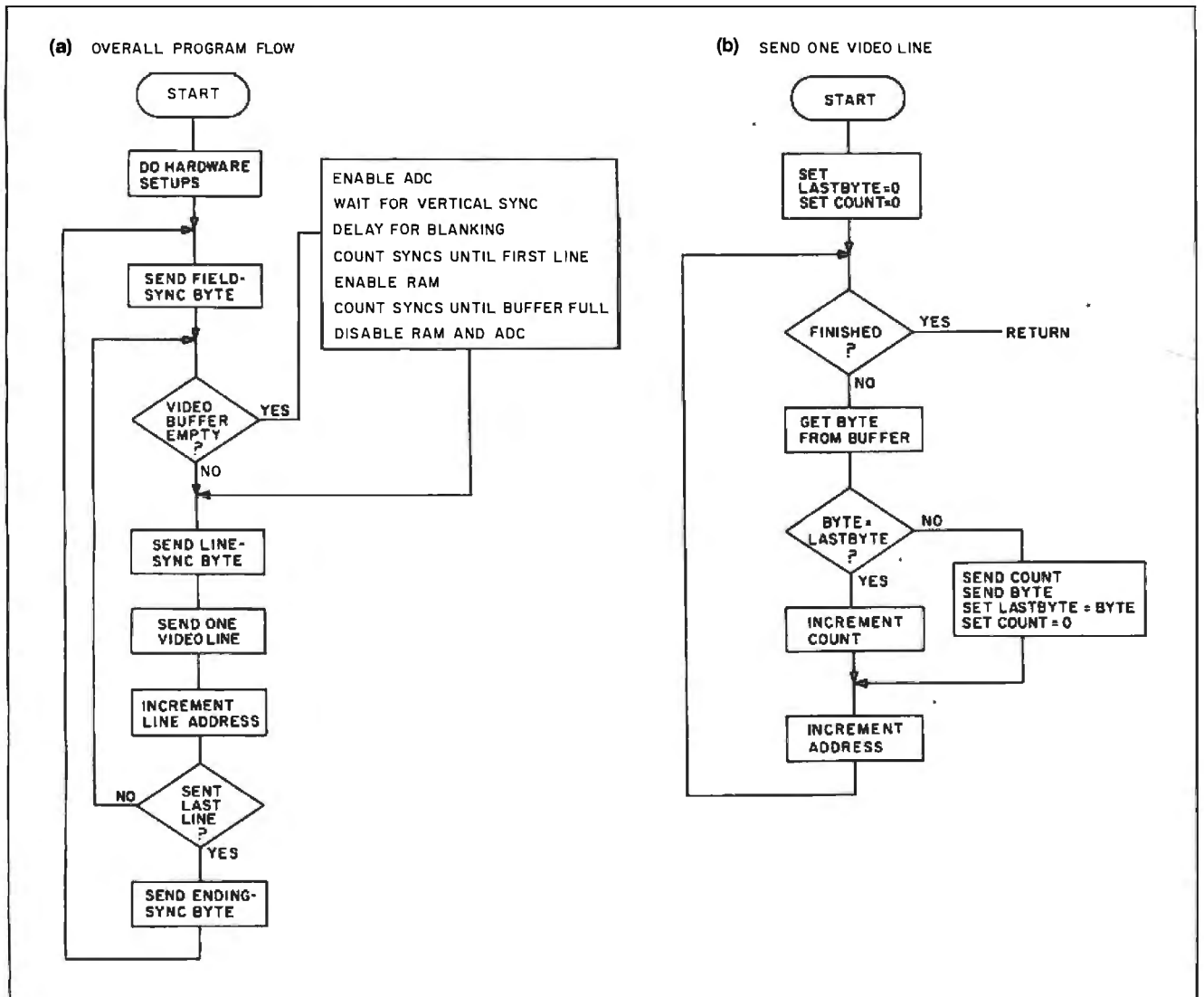

Figure 2: Flowchart of the digitizer/transmitter software. (a) This outlines the overall flow of the software. (b) A flowchart of the routine to transmit a single video line.

to see what happens to the flat areas in the picture. Disable compression and measure the increase in transmission time.

You can also try changing the bit rates to see which rates work for you. A direct connection can run at 28.8k bps, but for longer wires running through the house, you may need to use a slower rate. At 300 bps you can see the compression working. Remember that the display/receiver will get confused when you change the rate, so you may need to reset the system after changing any DIP-switch settings.

Cheap Buffer Option

I've described how the digitizer/transmitter works with a 64K-byte RAM field buffer made of two 32K-byte static RAM chips. It turns out that you can use an 8K-byte buffer in the digitizer/transmitter.

Because the 32K-byte static RAM chips are still rather expensive, I thought it would be worthwhile to reduce the cost for applications that don't need the advantages of the full 64K-byte buffer (Note: The ImageWise kit contains 32K-byte static RAM chips.)

An 8K-byte RAM can hold 32 lines of video (8K bytes divided by 256 bytes per line). The digitizer/transmitter digitizes 32 lines, transmits them, captures another 32 lines, and so on. It keeps track of the last digitized line and starts with the next line for the next group. When it's done, it begins again with the first video line.

Using an 8K-byte RAM is simply a matter of plugging it into the first RAM socket. The 8031 program "feels around" after a reset to determine the

RAM size during initialization and uses the proper addresses automatically; no DIP-switch settings are required.

The only difference between using 8K- and 64K-byte RAM buffers occurs when the scene contains moving objects. The 64K-byte buffer can hold a complete frame that is captured in 1/60 second, and it is the only configuration that can legitimately be called a frame grabber. The 8K-byte buffer holds 32 line groups that are digitized several seconds apart, so it's possible to get confused images. If you've ever seen those "panoramic" shots of a line of people with the same person at both ends of the line, you'll recognize the problem right away. But if your application doesn't involve rapid motion, you can save some money on buffer RAMs.

This trick doesn't work in the display/receiver because it must have the entire picture in RAM at all times. Replacing the 64K-byte buffer with an 8K-byte buffer would simply give you 32 lines' worth of picture.

Using a Modem

Because both the digitizer/transmitter and the display/receiver use a two-wire serial interface and XON/XOFFs to control data flow, they can be connected through a pair of modems as well as by direct wiring. The only problem is the low data rate that modems can handle. This is an ideal application for 2400- and 9600-bps modems.

One application might be to have the ImageWise digitizer/transmitter wait for a phone call, auto-answer, and then transmit the picture it sees at that remote location. Voilà, video security system or videotelephone. The switch settings for a Hayes Smartmodem 1200 are shown in table 2. Note that you can use other modems as long as they have auto-answer capabilities.

Using ImageWise

The ImageWise system can be used as a digitizer and display board pair or as individual components of some higher-function system. Used as a pair, "teleimaging" becomes a reality. By adding the sense of sight to our ordinary audio communication, we add a new level of communication and understanding. No longer does the field engineer have to be frustrated trying to justify replacement rather than repair of an expensive electrical component. A quick digitized image flashed back to the head office verifies significant fire damage and gets the proper authorization for immediate action.

The key factor in this new level of communication is the old saying that "seeing

Table 2: Hayes Smartmodem DIP-switch settings for use with the ImageWise system.

Switch	Setting	Description
1	DOWN	Smartmodem DTR input on pin 20 is forced active.
2	UP	Don't care, UP for English responses to commands.
3	UP	Suppress responses to commands.
4	DOWN	Do not echo characters.
5	UP	Smartmodem will auto-answer on first ring.
6	UP	Don't care, UP for CD when carrier detected.
7	UP	Single-line phone connection.
8	UP	Disable Smartmodem command recognition.



Photo 2: The ImageWise digitizer captures a high-quality gray-scale image that can be used in areas like security and pattern recognition. In the surveillance application shown here, an empty room is entered, used, and then exited. To save space in this presentation, all four scenes are displayed on a GT180 (in 16-level gray scale).

is believing." Consider another example: You are a consultant at a customer's site, and some question arises as to the actual wording and the date of a revision note on an important schematic. Rather than waste a day with express delivery, you can call your office and have them transmit a digitized image of the portion of the schematic in question complete with the authorization signature and date as they appear.

ImageWise has an infinite number of stand-alone uses. It can be used to instantly communicate fingerprints and ID photos, monitor traffic at remote intersections, monitor remote security risk zones (see photo 2) via auto-answer modems, aid in conducting company-wide lectures (standard audio teleconference with pictures of the blackboard periodically sent to all locations; see photo 3), or send x-rays and CAT scan pictures to medical personnel for corroborating diagnosis.

Some of these uses might seem ambitious for ImageWise, but similar more expensive units are already being applied in these areas. My immediate application may seem mediocre by comparison. Recently, I've been spending time out of the Circuit Cellar at an office across town. Since I already had a TV camera in my driveway (no windows in the cellar, remember), I simply attached it to the digitizer/transmitter and a 2400-bps auto-answer modem. Now I can call the house and get the latest snapshot or simply leave it on all the time as a real-time display of all the activity around the house (see photo 4). (I have four telephone lines; I can call the Home Control System on its own line if I want to have some real fun with someone like a delivery man. These guys all think my house is haunted.)

You'll note that I have described ImageWise only in terms of a 256- by 256- by 6-bit digitizer. Because I intended to use it with a modem, I felt the need to increase the picture-transmission speed. One way is to reduce the resolution to 128 by 121 or 64 by 61 bits. Even though such resolutions produce grainy images, they are still quite recognizable, especially if they are of familiar faces or geography (the recently advertised Mitsubishi video telephone has a 94- by 94- by 4-bit resolution by comparison). The 64- by 61-bit image is transmitted eight times faster than a 256- by 256-bit image and is suitable for monitoring gross changes in a driveway scene when a car or a person approaches.

When something appears, I can immediately change the DIP switches on the display board for a higher resolution and trigger another picture while the form is still in view. (The frame is grabbed in-

stantly and is independent of the transmission time.) The picture-repeat rate and resolution, remember, are commanded from the receiver and not fixed by the transmitter. The interaction is completely dynamic. My next activity is to connect the ImageWise digitizer to a computer and let it decide what's happening for itself and make all the decisions.

Fortunately, this is as easily said as done. Probably the most significant feature of ImageWise is that it is computer-nonspecific. It is a serial RS-232 I/O device that does not depend on any computer-specific bus. The ImageWise digitizer/transmitter's serial port can be connected to any personal computer. The computer can receive image data and store it on disk or send it to a similarly connected display/receiver board. So far we've written the software for my SB180 and the IBM PC. Others will follow.

Experimenters

While printed circuit boards and kits are available for the ImageWise system, I encourage you to build your own. If you don't mind doing a little work, I will support your efforts as usual. A hexadecimal file of the executable code for the 8031 digitizer and display system EPROMs, sample picture files, and the Turbo Pascal

continued



Photo 3: This is how a picture of me standing in front of a blackboard in Connecticut would be received by an ImageWise display/receiver board in California. A video printer like the Mitsubishi unit shown here can save the current scene while another is being transmitted.



Photo 4: The equipment counter in the Circuit Cellar where I took most of the photos with the setup you see. The interesting point to realize here is that this picture is completely digitized. A video camera (out of view) is pointed at the two stacked monochrome monitors and the film camera. The monitor on the bottom displays the picture as it is produced by the video camera and input to the digitizer/transmitter board. The display on top shows the output of the display/receiver board after it receives the data from the digitizer. It is the object of view by the film camera. This picture is the screen of the top monitor.

#1 C interpreter



The professional C development environment

Your C compiler creates great final code . . . but as a programming tool, it's too, too slow. With C-terp you can edit, debug, and run without the wait. Nothing, but nothing, is faster for developing professional C programs.

Choose the perfect C-terp companion for your C compiler

C-terp/Microsoft	C-terp/XENIX
C-terp/Lattice	C-terp/Aztec
C-terp/Mark Williams	C-terp/C86

Link in all your compiler's functions, your own functions, add-on libraries, assembly routines, and data objects. Get instant access to everything in the C-terp interactive environment.

Only C-terp offers all this and more

- Full K&R with common ANSI enhancements
- Source level interactive debugging
- Software paging for your big jobs
- Complete multi-module support
- Run-time pointer checking
- Unsurpassed reconfigurable screen editor
- Dual display and full graphics support
- Large model ■ Call-in

ORDER C-terp TODAY (specify compiler)

C-terp runs on IBM PC, AT or compatibles.

Price:

MS-DOS 2.x and up - \$298,
Xenix System V 286 - \$498
MC, VISA, COD
30-day money-back
GUARANTEE

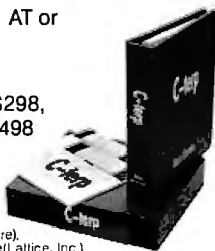

Trademarks: C-terp (Gimpel Software),
C86 (Computer Innovations), Lattice (Lattice, Inc.),
Xenix, Microsoft, MS-DOS (Microsoft, Inc.), Aztec (Manx
Software), Mark Williams (Mark Williams Company),
IBM (International Business Machines, Inc.)

GIMPEL SOFTWARE

3207 Hogarth Lane, Collegeville, PA 19426

(215) 584-4261

138 BYTE • JUNE 1987

code for storing images on an IBM PC are available for downloading from my bulletin board at (203) 871-1988 (similar code written for the SB180 in machine language is also available). Alternatively, you can send me a preformatted IBM PC or SB180 disk with return postage, and I'll put all the files on it for you (the hexadecimal file could be used with my serial EPROM programmer, for example). Of course, this free software is limited to noncommercial personal use.

Next Month

Once you've got a picture in digital format, you can write programs that perform magic tricks with it (hardware people like to think that way). By manipulating the binary data making up the picture, you can transform it into another picture that may be more meaningful. You can even combine two pictures to find differences—this is called image processing.

Now that we have the ImageWise digitizer, we have the means to perform some real experiments. I know many tutorial articles on image processing have been published, but the true Circuit Cellar creed is to build it yourself. Using ImageWise, next month I'll demonstrate how the basics of picture comparison, enhancement, and other image-processing fundamentals can be done for real. Finally, in another conversion of tutorial to example for August, I will demonstrate the process of colorizing the 64-level grayscale ImageWise picture. ■

Special thanks to Ed Nisley for his expert collaboration on this project.

Editor's Note: Steve often refers to previous Circuit Cellar articles. Most of these past articles are available in book form from BYTE Books, McGraw-Hill Book Company, P.O. Box 400, Hightstown, NJ 08250.

Ciarcia's Circuit Cellar, Volume I covers articles in BYTE from September 1977 through November 1978. *Volume II* covers December 1978 through June 1980. *Volume III* covers July 1980 through December 1981. *Volume IV* covers January 1982 through June 1983. *Volume V* covers July 1983 through December 1984.

The following items are available from

CCI
P.O. Box 428
Tolland, CT 06084
(203) 875-2751

1. ImageWise digitizer/transmitter board experimenter's kit. Contains digitizer/transmitter printed circuit board, 11.05-MHz crystal, programmed 2764 EPROM with transmitter software, and CA3306 flash A/D converter and manual with complete parts list.
DT01-EXP \$99

2. ImageWise display/receiver board experimenter's kit. Contains gray-scale display/receiver printed circuit board, 11.05-MHz crystal, programmed 2764 EPROM with receiver software, Telmos 1852 video D/A converter, manual with complete parts list, and an IBM PC 2.0 disk containing sample digitized images and test patterns.

DR01-EXP \$99
DT01-EXP and DR01-EXP
together \$179

3. ImageWise digitizer/transmitter full kit. Contains all digitizer/transmitter components, including printed circuit board, 64K bytes of static RAM, IC sockets, crystals, programmed 2764, CA3306 flash A/D converter, manual, and IBM PC 2.0 disk containing utility routines for storing and displaying (dot-dithered, not gray scale) and downloading image files using an IBM PC. Does not include power supply or case.
DT01-KIT \$249

4. ImageWise display/receiver full kit. Contains all gray-scale display/receiver components, including printed circuit board, 64K bytes of static RAM, IC sockets, crystals, programmed 2764, Telmos 1852 video D/A converter, manual, and an IBM PC 2.0 disk containing sample digitized images and test patterns. Does not include case or power supply.

DR01-KIT \$249
DT01-KIT and DR01-KIT
together \$489

ImageWise is also available assembled. Call CCI for source and availability of assembled boards and complete systems, black-and-white TV cameras, 32K-byte static RAM chips, and power supplies. Software utilities are also available in SB180 format.

All payments should be made in U.S. dollars by check, money order, MasterCard, or Visa. Surface delivery (U.S. and Canada only): add \$3 for U.S., \$6 for Canada. For delivery to Europe via U.S. airmail, add \$10. Three-day air freight delivery: add \$8 for U.S. (UPS Blue), \$25 for Canada (Purolator overnight), \$45 for Europe (Federal Express), or \$60 for Asia and elsewhere in the world (Federal Express). Shipping costs are the same for one or two units.

There is an on-line Circuit Cellar bulletin board system that supports past and present projects. You are invited to call and exchange ideas and comments with other Circuit Cellar supporters. The 300/1200/2400-bps BBS is on-line 24 hours a day at (203) 871-1988.

To be included on the Circuit Cellar mailing list and receive periodic project updates and support materials, please circle 100 on the Reader Service inquiry card at the back of the magazine.

AW . . .

WHAT THE HECK!

ProDesign II — Still \$299!

ProDesign II — the Easy-to-Use CAD System. The CAD system that was introduced two years ago for the amazingly low price of \$299. The CAD system that has undergone four major revisions with more than 400 enhancements. The CAD system that still costs only \$299!

How do we do it? Our accountants said to raise the price to cover research and development costs. Our business advisors said to charge more for the additional features. Our competitors said it's impossible to stay in business selling a comprehensive CAD package such as ProDesign II for only \$299.

And our customers said \$299 is great. So, we said:

"Aw . . . What the Heck! \$299 it is!"

Now, two years after its introduction, ProDesign II is one of the world's leading CAD packages. It has features previously found only on CAD systems costing thousands of dollars. For the single price of \$299, you get these features and more:

- Support for more than 180 printers (including color printers)
- Support for more than 80 plotters, with plotter optimization.
- Easy-to-Use single keystroke commands.
- On-screen menus accessible with a mouse.
- Comprehensive drawing commands, including the finest curve fitting in the industry.
- Editing features unsurpassed by ANY other CAD package.
- Extensive snap features, including snap to point, endpoint, midpoint, line, circle, ellipse, arc, intersection, and perpendicular.
- True Auto Dimensioning with several formats.
- Extensive Layering features.
- Full Macro capabilities.
- Specialized drawing aids, such as tangents to circles and ellipses, parallel lines, parallel curves, wide lines, and more.
- Complete hatching with up to 40 different patterns.
- Area and length calculation for line curves, circles, etc.
- Full Zoom, Pan, and Rotate capabilities.
- Capability to transfer drawings to and from other programs.
- Capability to Break/Trim Lines, Curves, Circles, Arcs, and Ellipses.
- Many more features — All for only \$299!

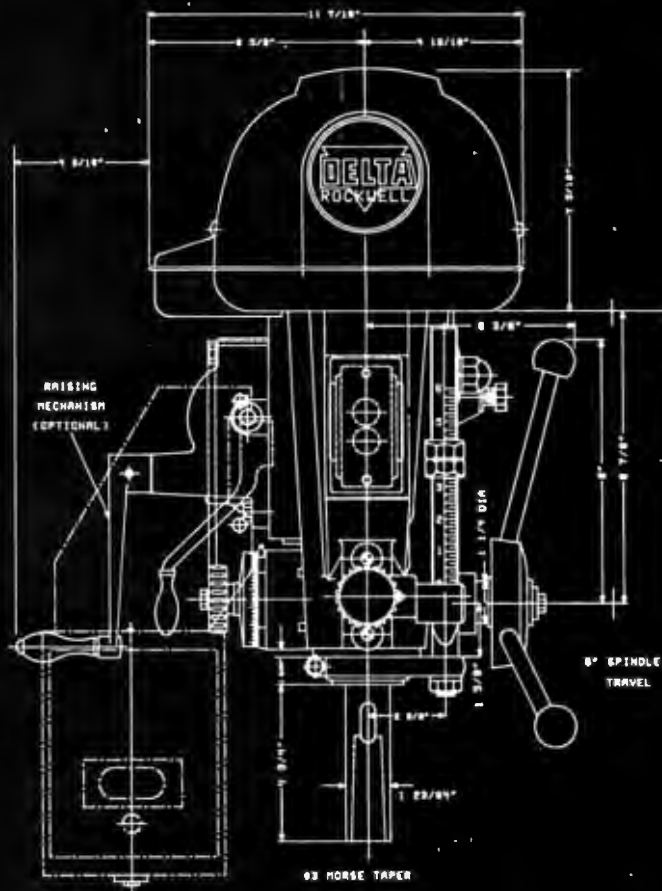

Where do you get ProDesign II? See your local computer dealer, or contact:

American Small Business Computers, Inc.
118 South Mill Street
Pryor, OK 74361
(918) 825-4844
Telex 9102400302

Want more information? Call or write for a detailed brochure and a free demo disk!

PRODESIGN II STILL ONLY \$299!

THE FASTEST TO AN

250 cps



If you want a fast, versatile, reliable printer with superb output, you can do one of two things.

Get an ALPS. Or get an ALPS.

The ALPS P2100™ is our fastest, flying through drafts at 400 cps, memos at 200 cps and letter-quality documents at 80 cps.

And the ALPS P2000™, one of PC Magazine's "best products of 1986," is no slouch, either. With print speeds of 250, 125 and 50 cps.

So both printers will speed

through most any kind of work. From letters and graphics to six-part forms and 16-inch-wide spreadsheets.

But these aren't just high-speed printers. They're also highly efficient.

Each has multiple font cartridges, to let you change type styles quickly and easily. A 4K print buffer—expandable to 256K—that frees up your PC for one job while you're still printing

THING NEXT ALPS.

400 cps



another. A built-in, push/pull tractor feed and bottom feed, to save paper that other printers would waste. Plus full compatibility with most leading PCs and software.

Running these ALPS is as easy as pushing buttons on their front panels. And once they start running, they may never stop. With basic care, in fact, they'll perform flawlessly for over five years.

Now the best thing to do is

see them perform live. For a free demo or more information, call us at (800) 828-ALPS. In California, (800) 257-7872.

You'll discover there's only one printer that can compare to an ALPS. Another ALPS.

ALPS
AMERICA

IT'S TIME YOU SAW THE ALPS.

proteus™

There are plenty of compatibles but none can match PROTEUS in speed, IBM compatibility, reliability, support & delivery.

PROTEUS features include:

12.5MHz Keyboard selectable CLOCK SPEED
4MB RAM ON MOTHERBOARD
3 SERIALS, 2 PARALLELS ON MOTHERBOARD
. . .and more. . .

EDITOR'S CHOICE.

"There are so many nice aspects to Proteus 286 and the company that makes it, there isn't enough room to cover them all."

Lawrence Oakley, Editor, Business Computer Digest

"The Proteus 286 ran all our test software and DOS 3.2 without a hitch...An excellent choice for someone who wants to configure his own system without messing around with the intricacies of matching hardware."

Winn L. Rosch, PC Magazine

30-DAY FULL MONEY BACK GUARANTEE
(TOTAL SATISFACTION GUARANTEED)

- FREE NATIONWIDE ON YOUR SITE SERVICE!
 - 15-MONTH FULL WARRANTY, LABOR & PARTS INCLUDED.
 - FREE 24 HOUR ONLINE CUSTOMER SUPPORT
 - 100% COMPATIBILITY WITH UNIX, XENIX, AUTO CAD, NOVELL, & 3COM
- ALL SYSTEMS DESIGNED AND MADE IN USA**

PROTEUS CUSTOMERS INCLUDE: RCA, XEROX, DUPONT, REVLON, KODAK, DEC, CITIBANK, MIT A.I. LAB, ROCKEFELLER UNIV, COLUMBIA UNIV, JOHNS HOPKINS UNIV, NASA/TIAA...and thousands more!



**30 DAY
MONEYBACK
GUARANTEE**

PROTEUS-286GT

- 80286-12 Intel CPU
- 6/12.5MHz Clock speed (KBD select)
- 8-layer stable motherboard
- 1024K RAM expandable to 4MB on motherbd
- 8 I/O slots
- 80287 Coprocessor Socket
- 3 serials, 2 parallels on mainbd
- 5 Mhz DMA bus
- Hard Disk & Floppy Controller
- Clock, Cal., & battery backup
- 200W quality 110/220v power supply
- Two Floppy Drives; one 1.2MB & one 360K with choice of 3.5" drive
- 84 key AT style keyboard

Price: **\$2495.00**

(Quantity discounts available)

With 30MB fast harddisk, Hercules compatible graphics card & High resolution monochrome monitor — **\$3075***

44MB EGA system with EGA Monitor — **\$3675***

WE CUSTOM CONFIGURE AND TEST THE SYSTEM EXTENSIVELY. WE HAVE THE LARGEST STOCK OF HARD DISKS, MONITORS AND ADAPTERS AT LOWEST PRICES.

HARD DISKS

20MB Seagate	\$285
30MB Seagate	\$595
40MB Seagate	\$730
44MB Miniscribe	\$665
44MB Priam	\$850
80MB Seagate	\$1095
120MB Maxtor	call
190MB Maxtor	call

MONITORS

High Res. Monochrome	\$109
13" color monitor	\$340
Sony Multiscan	\$595
NEC Multisync EGA	\$569

PROTEUS-286 STD.

- 80286-10 Intel CPU
- 6/10Mhz clock speed (kbd select)
- Selectable Wait States 0-1
- 8-layer stable motherboard
- 1024K RAM expandable to 4MB on motherbd
- 80287 Coprocessor Socket
- 5 MHz DMA bus
- Clock, Cal. & battery backup
- 3 Serials, 2 Parallels on mainbd
- 8 I/O slots
- 200W, quality Power supply 110/220v
- Hard Disk & Floppy Controller
- Two Floppy Drives, one 1.2MB, one 360K, with choice of 3.5" microfloppy.
- AT style 84 key keyboard

Price: **\$2195.00**

(quantity discounts available)

PROTEUS-286E

(A Low Cost Proteus AT Compatible)

- Intel 80286 Runs at 8Mhz, opt. 10Mhz
- 512K RAM expandable to 1MB on motherbd
- 8 I/O slots
- Clock, Cal., Battery backup
- 195W 110/220v power supply
- Hard Disk & Floppy comb. controller
- 1.2MB Floppy Drive (reads both 1.2MB and 360K floppy)
- Maxiswitch AT keyboard

Price: **\$1095**

10Mhz system with 1MB RAM 20MB hard disk, Herc. compt. card & high res. mono monitor total system price \$1720

proteus™

The Intelligent Conclusion



TO ORDER OR FOR INFORMATION CALL US DIRECT:
201-288-8629

Proteus Technology Corp

377 RT 17
Airport 17 Center
Hasbrouck Heights, NJ 07604

TELEX 510 601 0960
FAX 201-288-2577

Overseas: Proteus, W. Germany, Proteus, France

Terms: Visa/MC, COD, Prepayment with cash disc., University and Corporate POs accepted upon approval.

*price with one 1.2MB floppy drive only.

Paul D. Bourke

A Contouring Subroutine

Represent any three-dimensional surface on a flat plane with this BASIC program

Contouring is a way of profiling a three-dimensional surface using a two-dimensional medium such as paper or a computer screen. Two everyday applications of contouring are the display of elevations on topological maps and air pressure zones on weather maps.

Generally, given a function F of two variables x and y , the contour of F at c is the set of all (x,y) such that $F(x,y) = c$. Except when $F(c)$ is a local minimum or maximum (the top of a hill or the bottom of a valley), the points satisfying $F(x,y) = c$ define one or more contour lines. Letting c take on various values through the range of F produces a contour map like those shown in figure 1.

Algorithms that do computer contouring typically involve advanced mathematical techniques. As a result, the programs implementing these methods are usually computation-intensive. In contrast, the technique presented in this article is easy to implement, very reliable, and does not require sophisticated programming techniques or high-level mathematics. I have adapted the present BASIC version from a FORTRAN subroutine written in 1983 by Dr. M. D. Jones for a PDP-11 at the physics department at Auckland University in New Zealand.

The subroutine, called CONREC, takes as its input a set of three-dimensional data points (x_i, y_i, z_i) and a list of contour levels that usually spans the range of z_i . The size of the intervals between contour levels determines how precisely the contour map will represent a given set of

continued

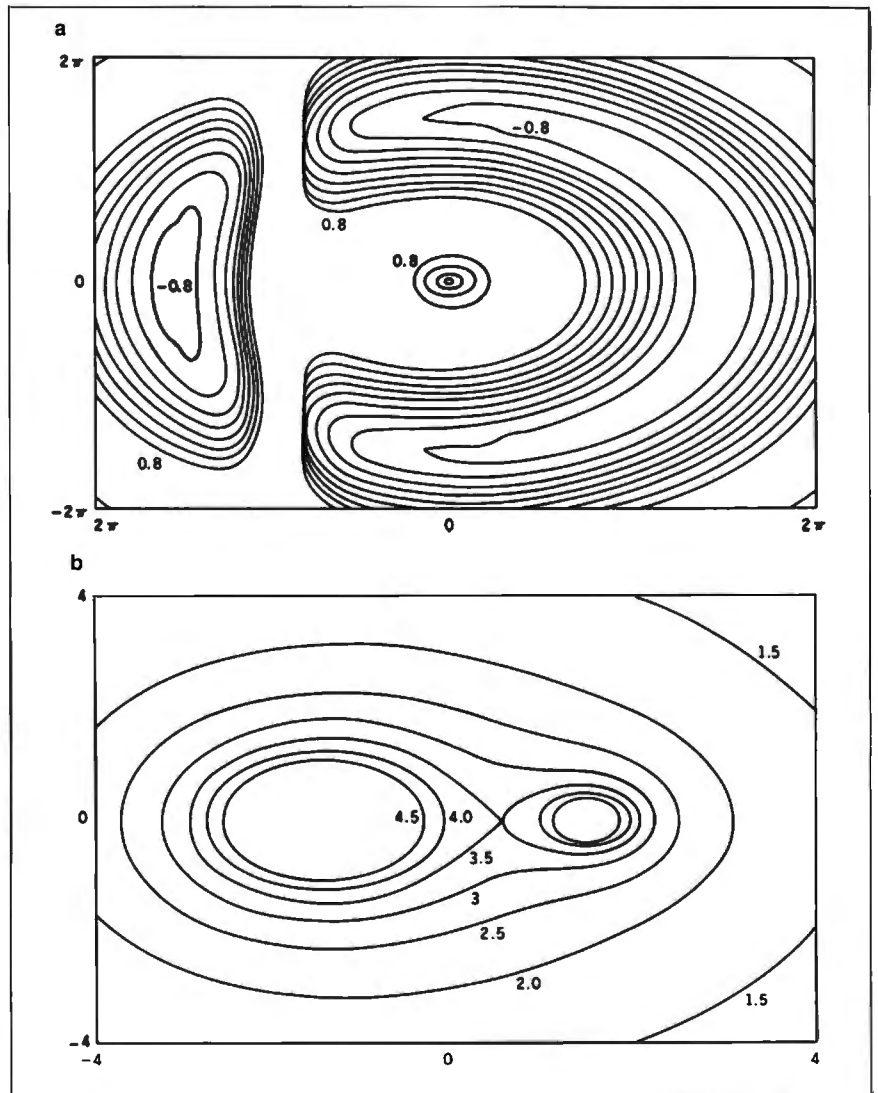

Figure 1: Contour maps of a mathematical function (a) described in the text and of equipotential fields (b) around two charge particles.

Paul D. Bourke can be contacted at P. O. Box 76425, Manakau City, New Zealand.

The program allows for non-square grids and for uneven spacing between coordinates.

data in any specific instance.

CONREC allows for nonsquare grids in which the number of x coordinates is not equal to the number of y coordinates, and for uneven spacing between coordinates. For instance, x coordinates used in a data collection can range from 15 to 36 at intervals of 3, 3, 3, 1, 1, 1, 3, 3, 3 while y coordinates range from 1 to 100 at uniform intervals of 1.

The output from CONREC is a sequence of line segments $(x_1, y_1)-(x_2, y_2)$ and corre-

sponding contour levels. This data is then sent to a plotting subroutine to be drawn by an output device. In the simplest case, the output device draws the line segments on a standard x, y coordinate grid, ignoring the contour-level value. In a color system, the color of the line might be keyed to its contour value. In a monochrome system, you can draw the contour lines with differing line styles or label them according to their contour level (but the latter takes some extra work to avoid cluttering up the map with redundant labels).

The Algorithm

CONREC treats the data in groups of four contiguous points. Ignoring the z coordinates, each quadruplet forms a rectangle whose vertices are (x_i, y_j) , (x_{i+1}, y_j) , (x_i, y_{j+1}) , (x_{i+1}, y_{j+1}) . Each rectangle is divided into four triangular regions by cutting along the diagonals, as shown in

figure 2a. The program interpolates x and y coordinates of the centerpoint C from the four vertices and estimates the z coordinate as the average of the four vertices' z coordinates.

Thus, we have four triangles in three-dimensional space. (Figure 2b illustrates one of them.) The actual work of generating the contour lines is done with respect to these triangles. For each triangle, CONREC finds its intersection with the contour plane. Elementary geometry tells us that two flat planes intersect in a line, a point, a plane, or the null set (no intersection). When the intersection is a line (as in figure 2c), CONREC generates a contour segment along that line. In the other cases (point, plane, or null set), it draws no contour segment. When plotted, the individual contour segments make up the contour lines.

CONREC uses a classification scheme to determine the nature of the intersection and what action is needed. The classification depends on whether the vertices are above, on, or below the contour plane. Only ten cases are possible, and these are grouped into six categories, as shown in figure 3 and enumerated in table 1.

Only the intersections of type I, II, and III result in contour line segments. The start and end points of type I segments correspond to two of the triangle's vertices. For type II segments, one of the endpoints is known and the other is interpolated. For type III segments, both endpoints are interpolated.

As an example, consider the triangle with vertices v_1, v_2, v_3 whose z coordinates (or "heights") are 0, 2, and 3, respectively (see figure 2c). Suppose you want to draw a contour line at height 1. Referring to table 1, you see that the intersection of the triangle with the contour plane is type III—a line through two sides of the triangle. Contour-level 1 intersects the line segment v_1v_2 at its midpoint and intersects v_1v_3 one-third of the way from v_1 .

When all the contour levels have been drawn for a rectangle, CONREC moves to the next rectangle. The process is repeated until all the rectangles have been checked. The rectangles are examined from the top down and from left to right.

CONREC reads the entire array into memory. However, the contouring algorithm does not require access to all the data points at once; only four points are referenced at a time. This makes the algorithm suitable for processing large data sets that would exceed the amount of memory available for array storage. However, CONREC would need some minor modifications to do so.

The program must calculate most of the contour segment endpoints twice—

continued

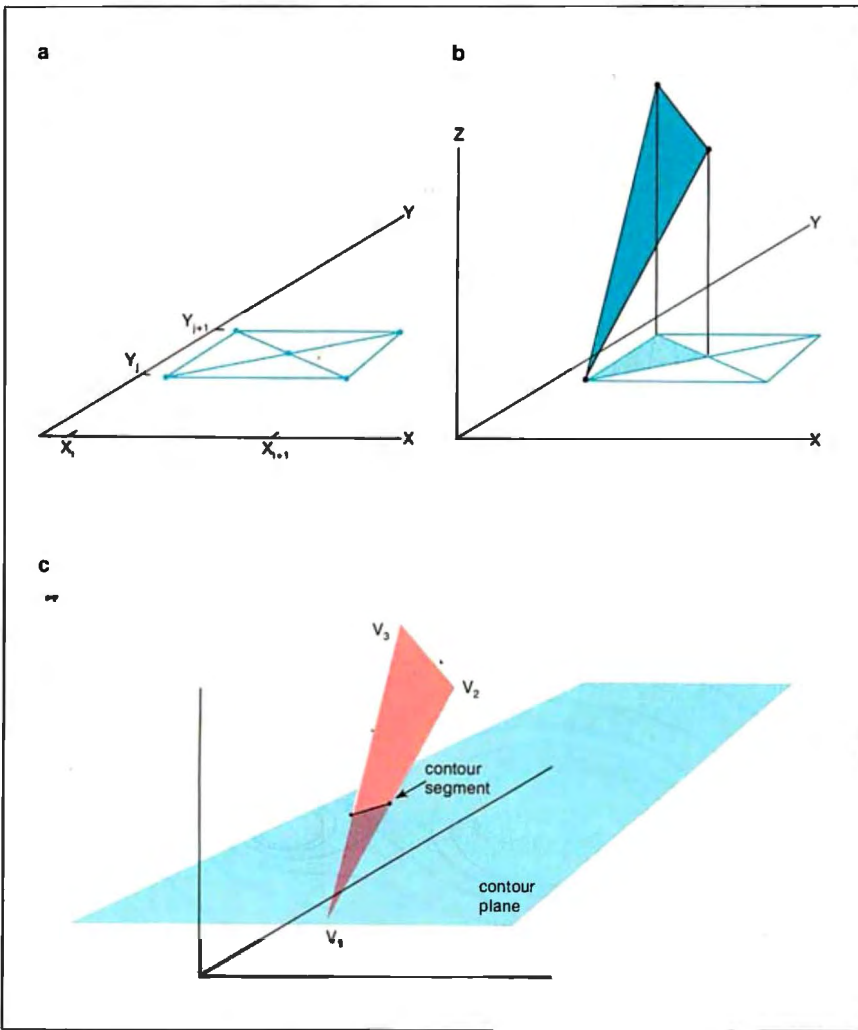

Figure 2: The data points are analyzed in groups of four contiguous points. These rectangles are divided into triangles (a). The centerpoint C 's coordinates are interpolated, giving three triangles in three-dimensional space (b shows one of them). The intersection of these triangles with the contour plane determines the location of the contour segments (c).

PROGRAMMING PROJECT

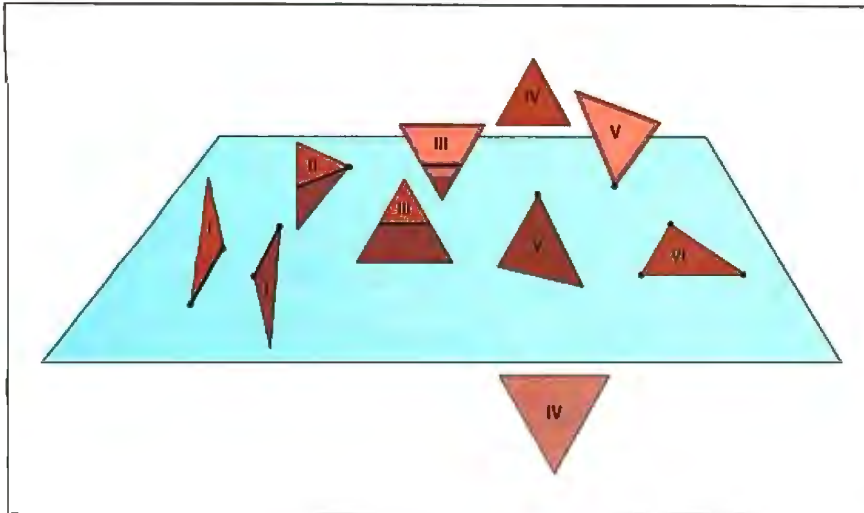

Figure 3: Six types of intersections between triangles and the contour plane; only three types result in contour line segments.

Table 1: Classification scheme for the intersections between a triangle and the contour plane.

Type	Intersection of triangle and the contour plane	Point locations with respect to the contour plane
I	Line through one side of the triangle	1 above, 2 on plane 1 below, 2 on plane
II	Line bisecting the triangle through one vertex	1 above, 1 below, 1 on plane
III	Line bisecting the triangle through two sides	1 above, 2 below plane 2 above, 1 below plane
IV	No intersection	3 above plane 3 below plane
V	Point intersection	2 above, 1 on plane 2 below, 1 on plane
VI	Plane intersection	3 on plane

Listing 1: The CONREC subroutine, written in Microsoft QuickBASIC.

```

REM Input variables to CONREC
REM d(0:iub,0:jub) 'Matrix for the data surface
REM iub, jub 'Index bounds of the data array
REM x(0:iub) 'Data array for column coordinates
REM y(0:jub) 'Data array for row coordinates
REM nc 'Number of contour levels
REM z(0:nc-1) 'Contour levels in increasing order
REM VECOUT 'An external subroutine to plot the contour lines
REM False and true Boolean values
REM
conrec:
REM Local declarations for CONREC
DIM h(4) 'Relative heights of the box above contour
DIM ish(4) 'Sign of h( )
DIM xh(4) 'x coordinates of box
DIM yh(4) 'y coordinates of box
DIM im(3) 'Mapping from vertex numbers to x offsets
im(0)=0 : im(1)=1 : im(2)=1 : im(3)=0
DIM jm(3) 'Mapping from vertex numbers to y offsets
jm(0)=0 : jm(1)=0 : jm(2)=1 : jm(3)=1
    
```

continued

Test RS232C In A Zip.

Test RS232C data communications interfaces—like computers to printers, computers to modems, and computers to computers—fast and easy in the palm of your hand with Beckman Industrial's low-cost, easy-to-use line of testers. Each is self-contained in a Toughpak case, including five models in a durable zippered pouch, and a 10-year warranty on every model. Prices start as low as \$49.95.

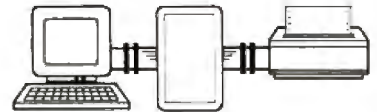

See your nearest Beckman Industrial distributor today, or send for free brochure. We'll send it to you in a zip.

Quick Cable Customizing

Fast RS232C Interfacing and Testing

LED Identification of Cable Configurations

Pocket and Hand-held Compactness

Speeds Up Trouble Shooting

10 Standard, Low-Cost Models



EasyPATCH™ 704

Easy BOB™ 750

In Service Instruments, We're The One.

Beckman Industrial™

Beckman Industrial Corporation Instrumentation Products Division
A Subsidiary of Emerson Electric Company
3883 Ruffin Rd, San Diego, California 92123-1898
(619) 565-4415 • FAX: (619) 268-0172 • TLX: 249031

© 1987 Beckman Industrial Corporation

ENCLOSURES & POWER SUPPLIES



for FLOPPY WINCHESTER TAPE DRIVES

from \$100

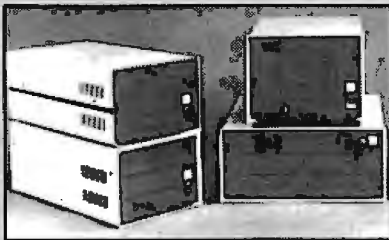

for SINGLE BOARD COMPUTERS

from \$125



for IBM & S-100 SYSTEMS from \$200

*1 piece; prices lower/in quantity.
(Disk drives not included)

Call or write for free catalog

INTEGRAND

RESEARCH CORP.

8620 Roosevelt Ave. • Visalia, CA 93291

209/651-1203

TELEX 5106012830 (INTEGRAND UD)

IBM and International Business Machines

PROGRAMMING PROJECT

Listing 1: continued.

```

DIM castab(2,2,2) 'Case switch table
DATA 0, 0, 8, 0, 2, 5, 7, 6, 9, 0, 3, 4, 1, 3, 1, 4, 3, 0, 9, 6, 7, 5, 2, 0, 8, 0, 0
FOR k=0 TO 2 : FOR j=0 TO 2 : FOR i=0 TO 2
  READ castab(k,j,i)
NEXT i : NEXT j : NEXT k
REM
REM Check the input parameters for validity
prmerr=false
IF (iub=<0 OR jub=<0) THEN prmerr=true
IF (nc=<0) THEN prmerr=true
FOR k=1 TO nc-1 : IF (z(k)<=z(k-1)) THEN prmerr=true : NEXT k
IF (prmerr) THEN msg$='`Error in input parameters`' : RETURN
REM
REM Scan the array, top down, left to right
REM
FOR j=jub-1 TO 0 STEP -1
FOR i=0 TO iub-1
REM Find the lowest vertex
IF (d(i,j)<d(i,j+1)) THEN dmin=d(i,j) ELSE dmin=d(i,j+1)
IF (d(i+1,j)<dmin) THEN dmin=d(i+1,j)
IF (d(i+1,j+1)<dmin) THEN dmin=d(i+1,j+1)
REM Find the highest vertex
IF (d(i,j)>d(i,j+1)) THEN dmax=d(i,j) ELSE dmax=d(i,j+1)
IF (d(i+1,j)>dmax) THEN dmax=d(i+1,j)
IF (d(i+1,j+1)>dmax) THEN dmax=d(i+1,j+1)
IF (dmax<z(0) OR dmin>z(nc-1)) THEN GOTO noneinbox
REM Draw each contour within this box
FOR k=0 TO nc-1
IF ((z(k)<dmin) OR (z(k)>dmax)) THEN GOTO noneintri
FOR m=4 TO 0 STEP -1
IF m>0 THEN
h(m)=d(i+im(m-1),j+jm(m-1))-z(k) : xh(m)=x(i+im(m-1)) : yh(m)=y(j+jm(m-1))
IF m=0 THEN
h(0)=(h(1)+h(2)+h(3)+h(4))/4 : xh(0)=(x(1)+x(1+1))/2 : yh(0)=(y(j)+y(j+1))/2
IF h(m)>0 THEN ish(m)=2 : ELSE IF (h(m)<0) THEN ish(m)=0 : ELSE ish(m)=1
NEXT m
REM Scan each triangle in the box
FOR m=1 TO 4
m1=m : m2=0 : m3=m+1 : IF (m3=5) THEN m3=1
case=CINT(castab(ish(m1),ish(m2),ish(m3)))
IF (case=0) THEN GOTO case0
ON case GOTO case1, case2, case3, case4, case5, case6, case7, case8, case9
REM Line between vertices m1 and m2
case1: x1=xh(m1) : y1=yh(m1) : x2=xh(m2) : y2=yh(m2)
GOTO drawit
REM Line between vertices m2 and m3
case2: x1=xh(m2) : y1=yh(m2) : x2=xh(m3) : y2=yh(m3)
GOTO drawit
REM Line between vertices m3 and m1
case3: x1=xh(m3) : y1=yh(m3) : x2=xh(m1) : y2=yh(m1)
GOTO drawit
REM Line between vertex m1 and side m2-m3
case4: x1=xh(m1) : y1=yh(m1)
x2=(h(m3)*xh(m2)-h(m2)*xh(m3))/(h(m3)-h(m2))
y2=(h(m3)*yh(m2)-h(m2)*yh(m3))/(h(m3)-h(m2))
GOTO drawit
REM Line between vertex m2 and side m3-m1
case5: x1=xh(m2) : y1=yh(m2)
x2=(h(m1)*xh(m3)-h(m3)*xh(m1))/(h(m1)-h(m3))
y2=(h(m1)*yh(m3)-h(m3)*yh(m1))/(h(m1)-h(m3))
GOTO drawit
REM Line between vertex m3 and side m1-m2
case6: x1=xh(m3) : y1=yh(m3)
x2=(h(m2)*xh(m1)-h(m1)*xh(m2))/(h(m2)-h(m1))
y2=(h(m2)*yh(m1)-h(m1)*yh(m2))/(h(m2)-h(m1))
GOTO drawit

```

continued

Tandon just expanded the world of compatibility.



We have just expanded our line of AT-compatible microcomputer workstations with the addition of the powerful PCA-70. With its massive 70MB of Winchester hard disk storage and super-fast access time, even the most complex UNIX® applications and networking tasks are a snap.

And, all at a price that has become a Tandon trademark. At \$3,695* it's around 30% less than our major competitor.

When you choose one of the other four Tandon AT compatibles, the savings become even more convincing. From the 1.2 MB PCA-1 to the 40MB PCA-40 Tandon AT compatibles have been consistently 40% less than systems of comparable quality.

But a low price doesn't mean you have to sacrifice quality. Tandon microcomputers are engineered for performance and reliability by a manufacturer who has been an industry leader for over a decade.

For a Tandon Dealer nearest you, call toll free: 1-800-338-4555. In California call: 1-800-237-1735.

Please send me your Tandon Fact Pac,
a comprehensive set of literature and product reviews:

Name _____
Position _____
Company _____
Address _____
Telephone _____

Tandon Computer Corporation
405 Science Drive
Menlo Park, CA 94021
805/378.6104

BYTE 6/1

Tandon
Price. Selection. Quality.

*Monitor not included.
UNIX is a trademark of AT&T Bell Laboratories.

Increase Your Profit Margin! **TAIWAN** LOW PRICE! HIGH QUALITY!

MANUFACTURER DIRECT

BABY 286 TURBO™ SYSTEM
SUPERCHARGED SPEED - 12 MHz AT™
— The fastest IBM™ AT™ Compatible -

FEATURES:

- * Intel 80286-8/80286-10 microprocessor
- * 6/8 or 6/12 MHz switchable clock speed
- * Expandable to 1MB on board
- * Chips & Technology VLSI chipset
- * CMOS memory to maintain system configuration
- * Legal BIOS
- * Clock/calendar with battery back up
- * 8 I/O slot - 6 w/52 - & 36-pin card-edge connectors
- 2 w/only 62-pin card-edge connectors
- * 180W power supply (220V-110V)
- * XT size case w/keylock protection, reset switch & LED's for Turbo, hard drive, power on/off
- * Enhanced keyboard w/separate cursor, keypad and cross top function keys
- * 20% smaller than IBM AT™ system



BABY 286 MOTHER BOARD
6/12 MHz

Mega 4000 TURBO™ SYSTEM

— IBM PC/XT™ Compatible —
RUN 3 TIMES FASTER
"FCC CLASS B APPROVED"

FEATURES:

- * 8088-2 microprocessor w/8087 coprocessor optional
- * Keyboard selectable 4.77-8 MHz Turbo speed
- * 4 layer mother board, expandable to 640K
- * Legal BIOS
- * 150W power supply
- * AT™ style case w/keylock protection, reset switch, LED's for Turbo, hard drive, power on/off
- * AT™ style keyboard



FCC APPROVED ADD-ONS

- DISK I/O CARD
- TURBO MONO. GRAPHICS PRINTER CARD
- ENHANCED GRAPHICS ADAPTOR
- AT SERIAL/PARALLEL GAME ADAPTOR
- COLOR GRAPHICS CARD

180W/200W POWER SUPPLY

- * For XT™ and Baby 286™
- * 4 Drive Plugs
- * Same Dimension as XT™ Power Supply
- * +12V 8A - 12V 0.5A
- * +5V 20A - 5V 0.5A



Infotronics Corp.

ORDER HOTLINE: 011-886-2-9189798 (8 Lines)
FAX: 011-886-2-9176201, TLX: 32503 INFOTRON

FACTORY & OFFICE ADDRESS:
3F NO. 4, Alley 1, Lane Sze Wei, Chung Cheng Rd.
Shin Tien, Taipei 23136, Taiwan, R.O.C.

MAILING ADDRESS:
PO BOX 10102 Shin Tien, Taipei 23102, Taiwan, ROC

CONTACT OUR U.S. SHOWROOM & TECH SUPPORT
TEL: (714) 895-3900, FAX: (714) 897-9173, TLX: 3720117
FOR INFORMATION & QUOTATION

Listing 1: Continued.

```

REM Line between sides m1-m2 and m2-m3
case7: x1=(h(m2)*xh(m1)-h(m1)*xh(m2))/(h(m2)-h(m1))
      y1=(h(m2)*yh(m1)-h(m1)*yh(m2))/(h(m2)-h(m1))
      x2=(h(m3)*xh(m2)-h(m2)*xh(m3))/(h(m3)-h(m2))
      y2=(h(m3)*yh(m2)-h(m2)*yh(m3))/(h(m3)-h(m2))
      GOTO drawit

REM Line between sides m2-m3 and m3-m1
case8: x1=(h(m3)*xh(m2)-h(m2)*xh(m3))/(h(m3)-h(m2))
      y1=(h(m3)*yh(m2)-h(m2)*yh(m3))/(h(m3)-h(m2))
      x2=(h(m1)*xh(m3)-h(m3)*xh(m1))/(h(m1)-h(m3))
      y2=(h(m1)*yh(m3)-h(m3)*yh(m1))/(h(m1)-h(m3))
      GOTO drawit

REM Line between sides m3-m1 and m1-m2
case9: x1=(h(m1)*xh(m3)-h(m3)*xh(m1))/(h(m1)-h(m3))
      y1=(h(m1)*yh(m3)-h(m3)*yh(m1))/(h(m1)-h(m3))
      x2=(h(m2)*xh(m1)-h(m1)*xh(m2))/(h(m2)-h(m1))
      y2=(h(m2)*yh(m1)-h(m1)*yh(m2))/(h(m2)-h(m1))

drawit:
      CALL vecout(x1,y1,x2,y2,z(k))

case0: NEXT m
noneintri: NEXT k
noneinbox: NEXT i : NEXT j
RETURN
    
```

Listing 2: A QuickBASIC example program to draw the contour map shown in figure 1a.

```

CLS: PRINT "CONREC example. Contour the function"
PRINT: PRINT "f(x,y)=sin((x^2+y^2)^.5) + ((x-c)^2+y^2)^-.5"
PRINT: PRINT "letting x and y range from -2 pi to +2 pi."
PRINT "Building the data set now. Please wait."
OPTION BASE 0 'Lower bound of zero for all array indices
pi=3.141592654#
true=-1 : false=0
ilength=319 : jlength=199 'Dimensions of the output contour plot axes
(full screen in CGA mode)
imin=0 : jmin=199 'Coordinates of the left bottom corner
iub=30 : jub=30 : nc=10 'Number of grid intervals and contour levels
DIM d(iub,jub),x(iub),y(jub) 'Data array
DIM z(nc-1) 'Contour array

REM Define the function and the coordinates
FOR i=0 TO iub 'Check at all x-grid levels
  ix=2*pi*(2*i-iub)/iub 'ix ranges from -2 pi to +2 pi
  FOR j=0 TO jub 'Check at all y-grid levels
    jy=2*pi*(2*j-jub)/jub 'jy ranges from -2 pi to +2 pi
    r=SQR(ix^2+jy^2)
    d(i,j)=SIN(r)+.5/SQR((ix+.05)^2+iy^2)
  NEXT j
  x(i)=i*ilength/iub+imin 'Scale x(i) to span plot area
NEXT i
FOR j=0 TO jub
  y(j)=j*jlength/jub 'Scale y(i) to span plot area
NEXT j
FOR i=0 TO nc-1
  z(i)=(i-5)/5 'Contour levels at -1,-.8,...,1
NEXT i

CLS: SCREEN 1,0 'CGA screen 320 by 200
LINE (imin,jmin-jlength)-(imin+ilength,jmin),,b 'Use a box for axes
GOSUB conrec
IF NOT(prmerr) THEN PRINT : PRINT : PRINT msg$;
WHILE LEN(INKEY$)=0 : WEND 'Any key to stop
END
    
```

CADILLAC COMFORT AT A COZY PRICE.



Avis features GM cars.
Cadillac Sedan deVille.

WITH 500 A^{ADVANTAGE} MILES TO TOP IT OFF

AVIS SUPERVALUE

\$45 A DAY

for a Cadillac Sedan deVille

Now you can drive a luxurious Cadillac Sedan deVille or similar group car for only \$45 a day.

This low SuperValue Rate is available at selected Avis locations across America. And it comes with everything you expect from the company that tries harder. Like Avis Express[®] service and

Avis Rapid ReturnSM Plus a friendly staff that'll speed you on your way. What's more, A^{ADVANTAGE} members can earn 500 AAdvantage miles with every qualifying Avis rental.*

So take off with American Airlines and Avis. For something special in the air. And on the ground. See your travel agent for details. Or call Avis at 1-800-331-1212. *At participating Avis locations.



Inquiry 30

Red hot

Cars and rates are available at selected U.S. locations, subject to availability. Cars must be returned to renting location. These rates are nondiscountable. Rates, terms and conditions are subject to change without notice. Rate has a free-mileage allowance. There is an additional per-mile charge in excess of this allowance. Refueling service charge, taxes, CDW and optional coverages not included. Cadillac or similar group car available in New York area at a higher rate. Seasonal surcharges and blackout periods may apply. Advance booking may be required. Call Avis for complete details. A^{ADVANTAGE} is a registered service mark of American Airlines, Inc. © 1987 Wizard Co., Inc.

once for each of the two triangles that share a common boundary. For instance, in figure 2c, both endpoints of the contour segment will have to be calculated again when the program looks for the intersection of the two adjacent triangles and the contour plane.

The program could be speeded up if these contour segment endpoints were remembered rather than recalculated each time. However, this would complicate the program logic and make the listing longer. It would also require that more

than four points be kept in memory at a time.

Notes on the Listings

The CONREC subroutine (see listing 1) is written in Microsoft QuickBASIC 2.0. With minor changes to the screen output commands, it will run under Microsoft BASIC for the Macintosh. Older versions of Microsoft BASIC will require you to make a few other minor changes.

[Editor's note: Listings 1.BAS through 4.BAS are available on disk, in print and

on BIX; see the insert card prior to page 321. Listings are also available on BYTEnet; see page 4.]

The input parameters to CONREC are:

- The number of discrete intervals in the horizontal and vertical measurement grids, stored in iub and jub.
- The number of contouring levels, stored in nc.
- A one-dimensional array z(0:nc-1) containing the contour levels in increasing order.
- A two-dimensional array d(0:iub, 0:jub) containing the z values computed or measured at each (x,y) pair.
- Two one-dimensional arrays, x(0:iub) and y(0:jub), containing the actual horizontal and vertical coordinates of each sample point, making it possible to use data collected on a nonsquare grid, or data with varying grid intervals.

For the sake of example, I have supplied two sample programs (see listings 2 and 3) that supply CONREC with a set of data points, as well as a subroutine called VECOUT for drawing the contour map on a computer screen (see listing 4).

Example 1 uses CONREC to draw the contour of the mathematical function

$$f(x,y) = \sin((x^2 + y^2)^{1/2}) + ((x - c)^2 + y^2)^{-1/2}.$$

The contour map of the function is shown in figure 1a.

Example 2 is taken from physics. Given two electrical charges q_1 and q_2 , located along the x axis at $-c$ and $+c$, the electrical potential at a point (x,y) is given by the equation:

$$V(x,y) = k \left(\frac{q_1}{r_1} - \frac{q_2}{r_2} \right)$$

where k is a constant and r_1 and r_2 are the distances of (x,y) from q_1 and q_2 . Contouring this function generates a map of equipotential surfaces emanating from two charge particles (see figure 1b). A similar function graphs the gravitational fields around two masses.

To use CONREC for your own projects, you need to write a main program similar to those in listings 2 and 3 as well as a VECOUT subroutine to handle the output to your plotter device (similar to the one in listing 4). Append these subroutines to the main program, and you are ready to begin making your own contour maps.

Contouring as implemented in the CONREC subroutine gives you a fast way to see the shape of a function or a set of data points. Although not as intuitive as three-dimensional representations, contour maps avoid the problems of hidden line removal and three-dimensional projections onto two-dimensional surfaces. ■

Listing 3: A QuickBASIC example program to draw the contour map shown in figure 1b.

```
CLS: PRINT "CONREC example. Graph the equipotential lines"
print "around two charged particles by contouring the function"
print: print "V(x,y)=q1/r1-q2/r2"
print "letting x and y range from -4 to 4."
OPTION BASE 0 'Lower bound of zero for all array indices
pi=3.141592654#
true=-1 : false=0
ilength=319 : jlength=199 'Dimensions of the output contour plot axes
(full screen in CGA mode)
imin=0 : jmin=199 'Coordinates of the left bottom corner
iub=30 : jub=30 : nc=8 'Number of grid intervals and contour levels
DIM d(iub,jub),x(iub),y(jub) 'Data array
DIM z(nc-1) 'Contour array
REM
REM Define the function and the coordinates
a=1.5 : q1=1 : q2=-4 'Charge q1 is at -a; q2 is at +a
FOR i=0 TO iub
  ix=4*(2*i-iub)/iub 'Range from -4 to 4
  FOR j=0 TO jub
    jy=4*(2*j-jub)/jub 'Range from -4 to 4
    r1=SQR((ix-a)^2+jy^2)
    r2=SQR((ix+a)^2+jy^2)
    d(i,j)=(q1/r1-q2/r2)
  NEXT j
  x(i)=i*ilength/iub+imin 'Scale x(i) to span plot area
NEXT i
FOR j=0 TO jub
  y(j)=jmin-j*jlength/jub 'Scale y(i) to span plot area
NEXT j
FOR i=0 TO nc-1 : z(i)=(i+1)/2 : NEXT i
REM
CLS: SCREEN 1,0 'CGA screen 320 by 200
LINE(imin,jmin-jlength)-(imin+ilength,jmin),,b 'Use a box for axes
GOSUB conrec
IF NOT(prmerr) THEN PRINT : PRINT : PRINT msg$;
WHILE LEN(INKEY$)=0 : WEND 'Any key to stop
CLS
END
```

Listing 4: The QuickBASIC VECOUT subroutine for plotting a line segment on the screen.

```
REM User defined subroutine to plot vectors on whatever plotting
REM device is available
REM
SUB vecout(xstart,ystart,xstop,ystop,clevel) STATIC
  LINE(xstart,ystart)-(xstop,ystop)
END SUB
```

The American Success Story:

Once upon a time, America led the world in innovation, quality, engineering, and manufacturing with names like Edison, Ford, and Bell...
Once again America returns:

\$755
Basic system



Basic system 8 MHz CPU with Option A \$1075
Basic system 10 MHz CPU with Option A \$1125

"Low price and blazing speed" ...
Joe Desposito
PC Magazine

FEATURES:

- * Maxi switch keyboard/Pro™ keyboard
- * 6/8/10 MHz selectable, depends on model
- * 1MB of inboard memory (with 512K standard)
- * 8 I/O expansion slots
- * 195 watt power supply, 110V/220V switchable
- * Fully compatible High Speed AMI BIOS
- * Full 200 page documentation, operation manual with binder (written in U.S.A)
- * Full one year warranty



FREE:

Fully configured and tested for your system requirements

RUNS:

NOVELL DBASE
AUTO CAD LOTUS
XENIX SIDEKICK

"If imitation is the sincerest form of flattery, the CLUB AT pays the IBM AT a heartfelt compliment. The only failing of the (CLUB AT) is that it imitates the IBM machine too accurately,...and you can't beat that..."

Karl Koessel PC World December 1986

EVEREX EVERCOM

"Fully Hayes™ Compatible"

300/1200 BAUD 1200/2400 BAUD

\$128



\$229



300/1200 BAUD, half size/half power, excellent for long distance calls, free BitCom communications software

Option A: 1.2MB Floppy Drive WD HD/Floppy Controller

CLUB 286 Mono system \$1309

* Complete system as described above plus mono display card and IBM quality mono monitor

CLUB 286 Color EGA system \$1740

* Complete system with EGA card & monitor

CLUB 286 Color system \$1500

- * High quality
- * Complete system as above
- * Plus color display card and color monitor
- * Fully assembled and tested, no installation required

GRAPHICS BOARDS

MULTIFUNCTION CARD

HARD DISKS TAPE BACKUP SUBSYSTEMS

OTHERS

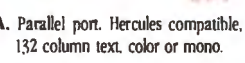

L. FAST HARD DISK FOR AT

20 MB 4026	\$528
30 MB 4038	\$599
40 MB 4051	\$628
72 MB (23 MS)	\$1095
80MB 4096	\$1195

M. FOR PC UPGRADE TO XT

INTERNAL	
20 MB	\$365
30 MB	\$425
WITH FLOPPY CONTROLLER	
ADD \$50	(20MB only)

EXTERNAL TAPE BACKUP SOFTWARE INCLUDED

INT	
EXT	
20 MB	\$580
60 MB	\$827

N.

39 ms access time, auto head parking, linear voice coil activator, one year limited warranty, cables, AT sliding rail and software included.	
65 ms access time, boots from hard disk, Western Digital controller, manual, cables, hardware and software included. 20/30MB Seagate Hard Disk.	
20 or 60MB backup, menu driven software, backup 5MB per minute, image & file-by-file backup.	

HARD DISK CONTROLLER

* Data Switch Box	\$88
* PC/XT controller	\$90
* Floppy controller	\$49
* 25 Pin Serial Cable	\$18
* Split Power Y-cable	\$8
* IBM Type Printer Cable	\$15
* IBM AT Bus Extended Card (good for test & debug)	\$30
* AT HD/Floppy Controller	\$170
* Compaq 286 HD Controller	\$188
* PC/XT/HD Floppy Controller	\$140
* Optical Mouse (Microsoft compatible)	\$75

SOFTWARE

Graphics DR. HALO Communications	\$49
BIT-COM	\$49
ADD ON	
* Kits for Mini I/O	
* 2nd Serial Port	\$25
* Kits for CLUB 2000, 2nd Serial Port	\$25

CHIPS

64K DRAM		256K DRAM	
150 ns (9 pcs.)	\$9	150 ns (9 pcs.)	\$27
120 ns (9 pcs.)	\$12	120 ns (9 pcs.)	\$36
		100 ns (9 pcs.)	\$45

CLUB AT INC.

46707 Fremont Boulevard, Fremont CA 94539

Quality and volume is Our Business

All Sales Call (415) 490-2201

FAX No. 415-490-2687

Now open 7:30-6:30 for your convenience

University P.O.'s are welcome Quantity Discounts are Available Corporate Buyer call for Neil Mehta Dealers are Welcome International sales desk now open.
ORDER BY MAIL: Check or Money Order. California add 6.5% tax ORDER BY PHONE: C.O.D., Cashier Check, VISA (3%), American Express (4%) or Approved Company P.O.
TERMS: All prices are subject to changes and quantity may be limited and we reserve the Right to Substitute Equivalent Items. Unauthorized Returns are subject to 10% Restocking Fee. Call for RMA Numbers for Returns and Repairs. IBM, Hercules, Bitcom, Xenix are trademarks of the Respective Companies. Limited Warranty, 1 year parts and 6 months labor. **Inquiry 53**

- A.** Parallel port. Hercules compatible, 132 column text, color or mono.
- B.** Short card, 256K Video memory, runs color/mono display, 16 colors, 640 x 350 resolution, and with Hercules emulation.
- C.** Printer port, monochrome graphics, runs Lotus 123/graphics, 132 x 44 column display.
- D.** Nonglare, 12" screen, 800 x 350 resolution.
- E.** 640 x 200 resolution, IBM quality.
- F.** 640 x 350, 640 x 200, EGA and CGA.
- G.** Game port, parallel port, 0-2MB memory, runs at 12 MHz, 2 serial ports (2nd optional)
- H.** Parallel port, real time clock/calendar, 2 serial ports (2nd optional).
- I.** Serial port, parallel port, game port (2nd serial option), support base and EMS memory, real time clock.
- J.** Club 576 (for PC Portable) software, short card, 0-576K memory, supports 64K/256K DRAM.
- K.** Club 384 Serial port, parallel port, 0-384K memory, clock/calendar, game port and software.

The fastest, tightest code.



(Though the same can hardly be said of the name.)

We have to tell you, we had a hard time getting the name down this short.

Because Microsoft's new FORTRAN Compiler actually has a far longer list of features.

It uses the same optimizer and code generator technology that made our C Compiler the industry leader.

And we've also added special loop optimizations that give you the

smallest, fastest FORTRAN code a PC can handle.

"Now Microsoft's FORTRAN Optimizing Compiler generates such fast code that an IBM PC/XT approaches the speed of the VAX."

Peter Osgood, MIT, Project Athena, Director of the Real Time Lab Project.

This compiler has already passed the toughest test there is. It's been

Microsoft FORTRAN Optimizing Compiler Version 4.0.

- ◆ Uses the Microsoft C optimizing technology, plus loop optimization to generate the fastest executable code for MS-DOS. NEW!
- | Execution Speed (in Seconds) | Microsoft FORTRAN v. 4.0 | Ryan-McFarland FORTRAN v. 2.11 | IBM Professional FORTRAN v. 1.22 |
|------------------------------|--------------------------|--------------------------------|----------------------------------|
| Sieve | 7.97 | 9.33 | 38.51 |
| Whetstone | 53.82 | 58.67 | 79.04 |
| Lookup | 5.82 | 18.61 | 26.02 |
- ◆ Fully GSA certified for ANSI 77 compatibility with no errors at the highest level. NEW!
 - ◆ Numerous IBM VS and DEC VAX extensions. NEW!

- ◆ Microsoft CodeView: Window-oriented source-level debugger. NEW!
 - Debug using your original source code, the resulting disassembly or both intermingled.
 - Watch and change the values of your local and COMMON variables as you debug.
 - Set conditional breakpoints on variables, expressions or memory; trace and single step.
 - Debug Microsoft C programs as well as Microsoft Fortran programs.
 - Watch and change registers and flags as you execute.
 - Easily debug graphics oriented programs since program output is kept separate from debugger output.

GSA-certified as Full ANSI FORTRAN 77, and 100% error-free.

"The Microsoft FORTRAN Optimizing Compiler let us port the 200,000 line Boeing Mathematical Library (BCSLIB) with virtually no changes. This ANSI FORTRAN 77 code was ported directly from Cray, CDC, DEC, IBM and other mainframes and workstations."

*Ivor Philips, Boeing Computer Services, Program Manager
Mathematical Software Libraries.*

We've also included the same advanced intrinsic math functions found on VAX® and IBM® VS systems. Add

improvements

like our new HUGE

memory model, and porting the biggest mainframe programs has never been easier.

Among the many additions we've made to our package is our exclusive CodeView™ windowing debugger.

It lets you trace through programs at any level you want, from source code to assembly language.

You can open windows and watch both variables (local and COMMON) and CPU registers change.

You can set conditional breakpoints using variables and expressions.

Debugging gets even easier with the compiler's advanced diagnostics. Detailed error messages are thoroughly explained and cross-referenced in our new manuals.

Documentation that has been completely revised and expanded with tons of examples.

If we're talking your language, use one of the numbers below for more details about the Microsoft® ANSI FORTRAN 77 Optimizing Compiler

Version 4.0 with CodeView, and the name of your nearest dealer.

(Even if the call's toll-free, it may be a good idea to refer to it as "FORTRAN 4.0" for short.)

Microsoft® FORTRAN

The High Performance Software.

Call (800) 426-9400. In Washington State or Alaska, (206) 882-8088. In Canada, (416) 673-7638.

Microsoft and MS-DOS are registered trademarks and CodeView is a trademark of Microsoft Corporation. IBM is a registered trademark of International Business Machines Corporation. VAX is a registered trademark of Digital Equipment Corporation.

- ◆ Medium, Large and Huge Memory Model Libraries. NEW!
- ◆ Mix models with NEAR, FAR and new HUGE pointers.
- ◆ Common blocks and arrays greater than 64K.
- ◆ Choose from three math libraries and generate in-line 8087/80287 instructions or floating point calls:
 - floating point emulator (utilizes 8087/80287 if installed)
 - 8087/80287 coprocessor support
 - alternate math package—extra speed without an 8087/80287
- ◆ Link your FORTRAN routines with Microsoft C (v.4.0 or higher), Microsoft Pascal (v. 3.3 or higher) or Microsoft Macro Assembler.
- ◆ Largest number of 3rd party support libraries available.

- ◆ Provides more detailed diagnostic error messages (almost twice as many as competitors) and extensive documentation with non-ANSI 77 features highlighted. NEW!
- ◆ Proven reliability—tested with over 2.5 million lines of code compiled and executed.
- ◆ MS-DOS® network support with file/record locking and sharing.
- ◆ Microsoft Program Maintenance Utility rebuilds your applications after your source files have changed. NEW!
- ◆ Other utilities including faster overlay linker (links over 1Mbyte object code), library manager, EXE file compression utility, EXE file header utility, MS-DOS environment setting utility and setup utility.

For \$19⁹⁵, RS/1[®] will give you a world of understanding.

Thousands of engineers and scientists are using RS/1[®] software to get a better understanding of their technical data. And now you can find out why.

For the first time, you can see why the RS/1 package has become an industry standard in data analysis software. All on your own PC.

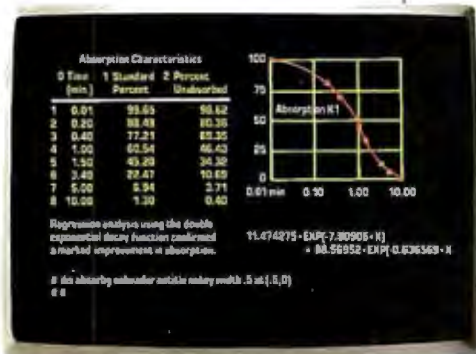

RS/1 software displays results in tabular and graphical forms.

Just send for our new introductory trial version of RS/1 software. For \$19.95, you get a special demonstration version of RS/1 software with data storage limitations. With this trial package,

you can perform all sorts of data analysis in a fraction of the time it would take with conventional methods.

Experience easy-to-use statistical and curve-fitting capabilities. And presentation quality graphics. Plots, graphs, histograms. This trial package does it all.

Before long, you'll discover how RS/1 software can help you improve laboratory research, cut product development costs, and increase manufacturing yields. And that's just the beginning. There's no telling what you can do with such a fast, powerful data analysis tool.

And the \$19.95 you pay for the trial package can be applied to a special promotional price of \$795 for the complete RS/1 software package

for the IBM PC AT and XT.*

Call 1-617-499-8200 for a credit card purchase, or fill out the coupon and send it in.

And find out how much of your world you can understand.

RS/1 Data Analysis System

- Data management: easy entry, import, storage, and retrieval of data
- A full range of data analysis tools
- Presentation quality graphics: graphs, histograms, 3Ds and more
- Easy-to-use statistics: t-tests, 1- and 2-way Anova, non-parametric, and other standard tests
- Spreadsheets and models
- Curve-fitting: linear, polynomial, multiple stepwise, and nonlinear – with goodness-of-fit statistics
- A powerful programming language for customizing applications

BBN Software Products

10 Fawcett Street Cambridge, MA 02238

A Subsidiary of Bolt Beranek and Newman Inc. 

Inquiry 37

*Or full equivalent with 10MB hard disk and 512KB memory. RS/1 is a registered trademark of BBN Software Products Corporation.

Enclosed find a check for \$19.95 for the introductory version of RS/1 for the IBM PC.

AMEX # _____ Exp. Date _____

Signature _____

Name _____

Title _____

Company _____

Address _____

City _____ State _____ Zip _____

BBN Software Products, 10 Fawcett Street, Cambridge, MA 02238

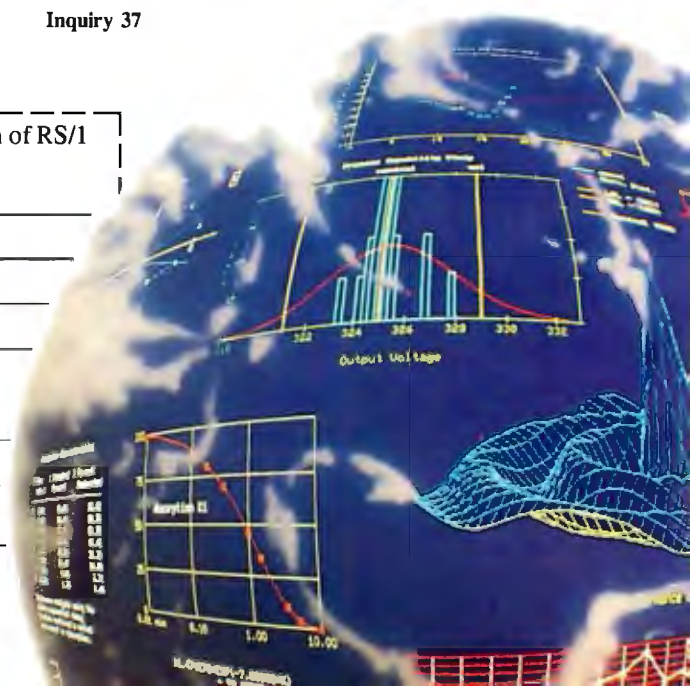

William G. Hood

Polynomial Curve Fitter

This BASIC program finds a polynomial function to fit a set of data points

People in business or industry often need to make predictions based on limited information from lab or field reports.

Situations from the scientific world come readily to mind: In testing an electroplating setup, let's say you have measured the amount of gold deposited on the surface of a metal in one hour under various voltages. You would like to find a mathematical function that describes the relationship between the independent variable (voltage) and the dependent variable (gold deposited in one hour), so you can predict how much plating will occur for any voltage.

In the area of business, suppose you have corresponding lists of monthly advertising expenditures and sales figures. You want to predict what would happen to the sales if the advertising were doubled.

In both cases, what's needed is a mathematical function $f(x) = y$ that approximates the data, with x the independent variable and y the dependent variable. The function would allow you to extrapolate (predict results outside the measurement range) or interpolate (predict additional results inside the measurement range). Plotting the function produces a smooth curve that shows the underlying trend of the data.

In this article, I'll present a BASIC program that finds a polynomial

$$p(x) = c_1x^n + c_2x^{n-1} + \dots + c_nx + c_{n+1}$$

approximation of the empirical data, letting you try different values for n to obtain the best fit. (The variable n is known as the degree of the polynomial; c_1, c_2, \dots are the coefficients.)

When the number of data points equals $n+1$, the polynomial's graph will pass exactly through each data point. How-

ever, usually the number of data points far exceeds the degree of the polynomial, and the curve is only an approximation that does not hit each point exactly.

This type of curve-fitting is appropriate when the data points are empirical, making them subject to error. Because of the probable errors, it is not important that the graph of $p(x)$ pass exactly through each point. But it is necessary that it be a smooth curve that comes *close* to the data points. In applications where the curve must pass *exactly* through the data points, you would be better off using the methods of Bézier curves or B-splines (see "Free-Form Curves on Your Micro" by Steve Enns, December 1986 BYTE). These techniques generate a series of functions connecting the data points.

The program in listing 1 uses the *least-squares method* to calculate the coefficients c_i of the polynomial. Briefly, this method finds a "fit" (a set of coefficients) that minimizes the sum of squares of the errors. The errors are differences between the predicted values and the experimental values for the dependent variable. [Editor's note: *POLYFIT.BAS* is available on disk, in print, and on BIX; see the insert card prior to page 321 for details. Listings are also available on BYTENet; see page 4.]

One advantage polynomial approximation has over other methods, such as the Fourier transform, is that you can evaluate polynomials easily by a program or spreadsheet or even by hand, whereas many of the other methods require far more processing.

The method of least-squares usually leads to the construction of a system of linear equations in which the coefficients of the polynomials are the unknowns. But when you use just one polynomial, the resulting system is often ill-conditioned; the solution is very sensitive to round-off

error. In such cases, use double-precision arithmetic to overcome the problem. But when you fit the data points by a linear combination of *orthogonal polynomials*, you avoid the ill-conditioning and end up with a system that you can handle with single-precision arithmetic. The program in listing 1 uses the orthogonal polynomial method (see reference 1).

Using the Program

The program is written in Microsoft BASIC and will run on IBM PCs and compatibles. For other computers, you might have to make minor changes.

Whether you read in data from a disk file or type it in, each data point consists of an x and a y value and, optionally, a weight w ; $w < 1$ gives a data point reduced influence; $w > 1$ gives a data point increased significance. You can give more weight to data points that you know are most accurate or to points that lie in a region of special interest. Those heavier-weighted points will have greater influence on fitting the polynomial.

After you enter the data, the program asks you to specify the degree of the polynomial you want to try; the degree must be smaller than the number of data points. With this information, the program calculates the coefficients of the polynomial approximation and prints them out in descending order of the exponent of x : coefficient of x^n , coefficient of x^{n-1} , and so forth. The program lets you try other values of n with the same data, and gives a way of gauging which degree results in the best fit.

When n equals the number of data

continued

William G. Hood is a math instructor and system manager of a VAX 11/750 computer. He can be contacted at 711 Mitchell, Conway, AR 72032.

The Better Net

The CompuPro ARCNET® PC Board

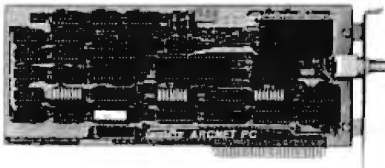

Better Compatibility

The CompuPro ARCNET PC is compatible with all versions of Novell Netware and Advanced Netware™, and DR-NET™ running in all types of PC-compatibles. No other board can say that!

Better Reliability

The CompuPro ARCNET PC board offers distinctly more reliability than other boards. Why? Read on.

Better Design

The CompuPro ARCNET PC board uses unique circuit design to increase signal margins. Better interface circuitry insures operation with even the fastest PC-compatibles.

Better Specs

The CompuPro ARCNET PC board meets all FCC requirements!

Better Made

The CompuPro ARCNET PC board is manufactured, tested and burned in right here in the USA. It is not subject to the wide swings in quality often experienced with foreign-manufactured boards.

Better Value

All of this adds up to the fact that the CompuPro ARCNET PC board is the best value in Novell compatible network boards.

Better Call Today

Call us today for the name of your nearest CompuPro dealer. They are prepared to discuss a variety of network and multi-user solutions to meet your requirements.

CompuPro™

Viasyn Corporation
26538 Danti Court
Hayward, CA 94545-3999
(415) 786-0909
TWX: 510-100-3288
Easylink Mailbox 62877579

Trademarks: CompuPro: Viasyn Corporation. ARC-NET: Datapoint Corporation. Netware, Advanced Netware: Novell, Inc. DR-NET: Digital Research Inc.

Listing 1: A Microsoft BASIC program that fits a curve to a set of data points using polynomial approximation.

```

1000 LN=1000: LD=11: REM LN=Max data points; LD=highest degree+1
1010 DEF FNMI(X,Y)=(X<Y)*(-X) + (Y<=X)*(-Y)
1020 N=0: M=0: S2=0: R2=0: MF=0
1030 S1=0: S2=0: S3=0: S4=0: P1=0: P2=0: P3=0: I=0: J=0: J1=0: K=0:
      VR=0 MM=0: WT=0: P=0
1040 DIM X(LN),Y(LN),W(LN),C(LD)
1050 DIM D1(LD),D2(LD),D3(LD),D4(LD),D5(LD),D6(LD)
1060 GOTO 1450
1070 IF MF>0 AND M>MM THEN J1=MM+1: MM=M: GOTO 1130
1080 J1=1: MM=M: S1=0: S2=0: S3=0: S4=0
1090 FOR I=1 TO N: WT=W(I)
1100 S1=S1+WT*X(I): S2=S2+WT: S3=S3+WT*Y(I): S4=S4+WT*Y(I)*Y(I)
1110 NEXT I
1120 D4(1)=S1 / S2: D5(1)=0: D6(1)=S3/S2: D1(1)=0: D2(1)=1: VR=S4-S3*D6(1)
1130 FOR J=J1 TO MM: S1=0: S2=0: S3=0: S4=0
1140 FOR I=1 TO N: P1=0: P2=1
1150 FOR K=1 TO J: P=P2: P2=(X(I)-D4(K))*P2-D5(K)*P1: P1=P: NEXT K
1160 WT=W(I): P=WT*P2*P2
1170 S1=S1+P*X(I): S2=S2+P: S3=S3+WT*P1*P1: S4=S4+WT*Y(I)*P2: NEXT I
1180 D4(J+1)=S1 / S2: D5(J+1)=S2/S3: D6(J+1)=S4/S2:
      D3(1)=-D4(J)*D2(1)-D5(J)*D1(1)
1190 IF J<4 THEN 1210
1200 FOR K=2 TO J-2: D3(K)=D2(K-1)-D4(J)*D2(K)-D5(J)*D1(K): NEXT K
1210 IF J>2 THEN D3(J-1)=D2(J-2)-D4(J)*D2(J-1)-D5(J)
1220 IF J>1 THEN D3(J)=D2(J-1)-D4(J)
1230 FOR K=1 TO J: D1(K)=D2(K): D2(K)=D3(K): D6(K)=D6(K)+D3(K)*D6(J+1): NEXT K
1240 NEXT J
1250 FOR J=1 TO M+1: C(J)=D6(M+2-J): NEXT J
1260 P2=0: FOR I=1 TO N: P=C(1)
1270 FOR J=1 TO M: P=P*X(I)+C(J+1): NEXT J
1280 P=P-Y(I): P2=P2+W(I)*P*P: NEXT I
1290 S2=0: IF N>M+1 THEN S2=P2/(N-M-1)
1300 R2=1: IF VR<>0 THEN R2=1-P2/VR: IF R2<0 THEN R2=0
1310 RETURN
1320 REM GOSUB 30 calls the subroutine
1330 REM Input:
1340 REM N=# of data points
1350 REM X( )=X-coordinates of the data points
1360 REM Y( )=Y-coordinates of the data points
1370 REM W( )=Weighting factors of the data points
1380 REM M=Degree of polynomial
1390 REM MF=0 if new data, MF=1 if old data but higher degree
1400 REM
1410 REM Output:
1420 REM C=Array of M+1 coefficients
1430 REM S2=Residual variance
1440 REM R2=coefficient of determination
1450 CLS
1460 PRINT ``Polyfit. Copyright (C) 1986 by William G. Hood``
1470 PRINT
1480 PRINT ``This program finds the coefficients of the nth degree
polynomial``
1490 PRINT: PRINT ``y = c(1)*x^n + c(2)*x^(n-1) + ... + c(n)*x + c(n+1)
1500 PRINT: PRINT ``that fits a set of data points in a least-squares sense.``
1510 PRINT ``Each data point must consist of an X value, a Y value, and an
1520 PRINT ``optional weight, separated by commas and terminated by a return.
1530 PRINT ``Data is read from a disk file until the eof is reached, or a
1540 PRINT ``specified number of data points are read in from the keyboard.``
1550 PRINT
1560 LINE INPUT ``Name the data file (null line=keyboard): ``; FI$
1570 PRINT ``Is the data weighted (Y / N, null line=No)? ``;
1580 W$=`` ``: INPUT W$
1590 IF W$<>`Y` AND W$<>`y` THEN W$=``N``
1600 IF FI$<>NU$ THEN 2000

```

continued

THE TANDY® 3000 HL



Plan ahead: go with the computer that's ready for the next generation in software.

The best in 286 technology

When you're looking to the future, you want a computer that will maximize your investment now, as well as down the road. The powerful Tandy 3000 HL computer, with its advanced 286 technology, gives you high performance with today's software—and even more later on.

Top software developers are beginning to introduce more powerful versions of their programs that utilize the power of the 80286 microprocessor—the same processor found in the Tandy 3000 HL.

These new programs will run faster and allow for greater utilization of memory. It all adds up to a new level of efficiency. Ordinary PCs will be stuck with the same old software, same old performance levels.

We beat out IBM®

The 3000 HL beats out the IBM PC XT™ 286 in price, performance and choice of options. The floppy-based Tandy 3000 HL starts at only \$1699. And a comparably equipped Tandy 3000 HL with a 20-megabyte hard disk and other options still costs less than IBM's 286.

Come to a Radio Shack Computer Center and see the Tandy 3000 HL. We'll help you prepare today for the power of tomorrow.

Send me a Tandy 3000 HL brochure.

Mail To: Radio Shack, Dept. 87-A-368
300 One Tandy Center, Fort Worth, TX 76102

Name

Company

Address

City

State ZIP

Phone

TANDY COMPUTERS: In Business . . . for Business™

Price applies at Radio Shack Computer Centers and participating stores and dealers. Monitor sold separately. IBM/Reg. TM and PC XT/TM International Business Machines Corp.

BE A POWER USER!

**MAKE YOUR PC
SEEM LIKE AN AT!**

**MAKE YOUR AT
SEEM LIKE A
DREAM MACHINE!**



The Integrated Console Utility™
**FAST, POWERFUL
ANSI.SYS REPLACEMENT**
For IBM-PC DOS

New Version 2.00 is MUCH FASTER!
Now blink free scrolling on CGA!
Now Uses EMS/EEMS for Scroll Recall!
New Menu Program for Changing Options!

**GET A BOX FULL OF UTILITIES!
MAKE LIFE EASIER FOR ONLY \$75!**

- Speed up your screen writing 2-6x
- Extend your ANSI.SYS to VT100
- Add many more escape sequences
- Scroll lines back onto screen
- Save scrolled lines into a file
- Add zip to your cursor keys
- Free your eyes from scroll blinking
- Easy installation
- Get a 43 line screen w/EGA
- No more annoying typeahead beep
- Prevent screen phosphor burn-in
- Shorten that annoying bell
- Over 60 useful options

"The psychological difference is astonishing"

—Lotus June 85 pg 8.

"So many handy functions rolled into one unobtrusive package"

—PC-World Feb 86 pg 282.

"The support provided by the publishers is extraordinary"

—Capital PC Monitor May 86 pg 25.

"... the best choice for improving your console ..."

—Capital PC Monitor June 86 pg 26.

"... documentation is nicely laid out and well written ..."

"... a fine enhancement to any IBM system."

—PC Tech Journal Jan 87 pg 180.

Manual (w/slip) & disks: \$75 plus \$4 s/h.

**Satisfaction Guaranteed!
Order Yours Today!**

HERSEY MICRO CONSULTING
Box 8276, Ann Arbor, MI 48107
(313) 994-3259 VISA/MC/Amex
DEALER INQUIRIES INVITED



Listing 1: continued.

```

1610 PRINT "Keyboard data entry"
1620 PRINT "How many data points ( 2 <= n <= ";LN;")"; INPUT N
1630 IF N<2 OR N>LN THEN 1620
1640 FOR K=1 TO N
1650 IF W$<>"N" THEN INPUT "x,y,w";X(K),Y(K),W(K): W(K)=ABS(W(K))
1660 IF W$="N" THEN INPUT "x,y"; X(K),Y(K): W(K)=1
1670 NEXT K
1680 PM=FNMI(LD-1,N-1)
1690 PRINT "Degree of polynomial ( 1<= m <= "; PM;")"; INPUT M: M=INT(M)
1700 IF M<1 OR M>PM THEN 1690
1710 GOSUB 1070
1720 PRINT: PRINT "Coefficients (constant term last): "; K=0
1730 FOR J=1 TO M+1: PRINT TAB(K) C(J); K=K+20: IF K>20 THEN K=0: PRINT
1740 NEXT J
1750 PRINT: PRINT "Residual variance: ";S2
1760 R2=INT(1000000!*R2+.5) / 1000000!
1770 PRINT: PRINT "Coefficient of determination: ";R2
1780 PRINT "Try another degree (Y/N, null line=No)"; A$="": INPUT A$
1790 IF A$="Y" OR A$="y" THEN 1680
1800 PRINT "Print a table of the data (Y/N, null line=No)"; A$="": INPUT
A$
1810 IF A$<>"Y" AND A$<>"y" THEN 1870
1820 PRINT: PRINT "Degree of p(x): ";M
1830 PRINT: PRINT "X"; TAB(11) "Y"; TAB(25) "p(x)": PRINT
1840 FOR I=1 TO N: P=C(1)
1850 FOR K=1 TO M: P=P*X(I)+C(K+1): NEXT K
1860 PRINT X(I);TAB(10);Y(I);TAB(24);P: NEXT I
1870 IF F$<>NU$ THEN END
1880 PRINT: PRINT "Save the data (Y/N, null line=No)? "; A$="": INPUT A$
1890 IF A$<>"Y" AND A$<>"y" THEN END
1900 PRINT: LINE INPUT "Name of output file ";FO$
1910 IF FO$=NU$ THEN END
1920 PRINT "Writing to ";FO$
1930 OPEN FO$ FOR OUTPUT AS 1
1940 FOR I=1 TO N
1950 IF W$<>"N" THEN PRINT#1, X(I);",", Y(I);",", W(I)
1960 IF W$="N" THEN PRINT#1, X(I);",", Y(I)
1970 NEXT I
1980 CLOSE 1
1990 END
2000 PRINT "Reading from ";FI$
2010 OPEN FI$ FOR INPUT AS 1
2020 N=0
2030 PRINT "X" TAB(15) "Y"; TAB(28) "W"; : PRINT
2040 IF EOF(1) OR N=LN THEN 2100
2050 N=N+1
2060 IF W$<>"N" THEN INPUT#1, X(N), Y(N), W(N): W(N)=ABS(W(N))
2070 IF W$="N" THEN INPUT#1, X(N), Y(N): W(N)=1
2080 PRINT X(N) TAB(14) Y(N) TAB(28) W(N)
2090 GOTO 2040
2100 CLOSE 1
2110 PRINT: PRINT "File contained "; N; " data points."
2120 IF N<2 THEN PRINT "Too few data points." : END
2130 GOTO 1680
    
```

points minus 1, you are assured of a close fit. But this is not usually the case. For large values of *n*, it is not practical to find a polynomial approximation; the program arbitrarily limits the degree to 10. In practice, the largest degree is typically much smaller than the number of data points and you must try several values of degree *n* to get the best approximation.

You should try to fit a polynomial using a degree high enough that the poly-

nomial will come close to the true function, yet low enough so that it "averages out" errors in the data. The program produces a statistic, the *residual variance*, that you can use to determine which degree gives the best fit. The residual variance is the sum of squares divided by the degrees of freedom (the number of data points minus the number of coefficients).

To find which degree gives the best fit,

continued

Intelligent statistics. Consider the alternatives.

Today there are numerous micro-computer statistics software packages to consider.

But, in the considered opinion of many experts, there is one that is clearly better.

Highest rated.

In its recent review of the five leading microcomputer statistics programs, *InfoWorld* concludes that Systat™ Version 3.0 is "unrivaled in performance", "tops in number crunching power" and "unfailingly accurate."

And *InfoWorld* doesn't stop here, but goes on to rank Systat as the Number One statistics package of the group.

In doing so, they aren't alone. Every published independent comparative review rates Systat at the top of the list.

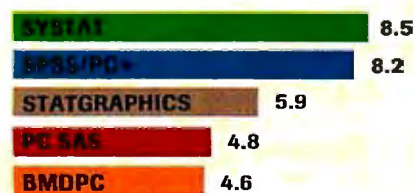

Of the statistics packages reviewed by InfoWorld, Systat rated highest, as it has in every published competitive review.

Some practical benefits.

Such ratings are important because they relate directly to the quality of your work, not just to glitzy features. For example:

Are capabilities important to

you? Systat gives you more statistical capabilities than any microcomputer statistical package, including three major procedures that PC SAS® and SPSS/PC+® programs simply don't offer.

Is accuracy important? Systat gives you more accuracy. In fact,

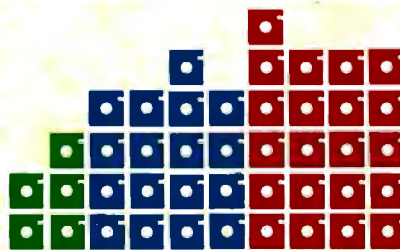

Although more comprehensive, Systat requires less than 1/2 the commands and has 1/2 the bulk of competitive programs. Compare its 5 disks to 17 for SPSS/PC+ and 21 for PC SAS!

numerous reviews and technical conference proceedings consistently prove Systat to be the most accurate statistical package available.

Is ease of operation important? Systat operates on less than 1/2 the commands of its two largest competitors, with less than 1/2 the bulk. According to *InfoWorld*, "Systat's commands are terse, and a few keystrokes will do amazing things."

Is cost important? Systat costs less than any other major package: less than 1/2 the price of the comparably equipped PC SAS or SPSS/PC+.

Truly interactive.

Unlike its major competitors, Systat has *not* ported some 20-year-old code from a mainframe program. Written specifically for microcomputers, Systat Version 3.0 uses an incredibly small amount of disk space: only 1.4 megabytes versus their 5 to 10 megabytes.

What's more, the package is genuinely interactive, freeing you from rigid command protocols. In doing so, Systat allows you to approach statistical problems more intelligently: letting you work the way you think instead of forcing you to think the way it works.

Next to this, the alternatives to Systat don't look very bright.

For more information and a complete copy of the *InfoWorld* review, call 312 864.5670, or write Systat Inc., 1800 Sherman Avenue, Evanston, Illinois 60201.

Systat operates on IBM PCs® and compatibles, MS-DOS® and CP/M® machines, several UNIX® minicomputers and mainframes, and the VAX/Microvax®. Menu/windowed Macintosh® version also available. Single copy price \$595 USA and Canada, \$695 Foreign. Site licenses and quantity prices available.

The following are registered trademarks: BMDPC of BMDP Inc., CP/M of Digital Research, Inc., IBM PC of IBM, Inc., MS-DOS of Microsoft, Inc., PC SAS of SAS Institute Inc., SPSS/PC+ of SPSS Inc., STATGRAPHICS of STSC Inc., UNIX of AT&T and VAX of Digital Equipment Corporation.

Systat. Intelligent statistics.

Numerical analysis requires you to perform a large number of calculations and to interpret the results intelligently.

first fit a polynomial of degree 1 and note the residual variance. Then try degree 2, again noting the variance, which should be smaller. Continue with successively higher degrees. The degree that produces the largest decrease in residual variance over its predecessor is the best fit. For example, consider the following data:

x	y
0.5	3.0
1.5	7.0
2.5	12.5
5.5	14.5
6.5	16.0
9.5	14.5
10.5	16.0
12.5	16.0
14.5	21.0
15.5	23.0

When polynomials of successively higher degree are fit to this data, the pro-

gram calculates the following residual variances:

Degree	Residual Variance
1	7.20688351
2	7.57981379
3	1.02062389
4	0.99174022

Although there is a decrease in going from the third- to the fourth-degree polynomial, the largest decrease is in going from the second- to the third-degree polynomial. Therefore the third-degree polynomial produces the best fit.

The smoothing effect of the third-degree polynomial is evident when you compare the plot of the third-degree polynomial with that of the ninth-degree polynomial (see figure 1). As the polynomial degree goes higher, the curve becomes increasingly spiky as it attempts to hit the points even more closely.

The program calculates another statistic, the *coefficient of determination*, which measures how much of the variation in the values of the dependent variable you can attribute to changes in the independent variable.

For instance, when you fit the above data points with a third-degree polynomial, the coefficient of determination is 0.98. This means that you can attribute 98 percent of the sum of squares of deviations of the y data values from their mean to changes in the x data values, and 2 percent to random error (assuming that

the polynomial is close to the "true" function, that is, the actual physical relation between the independent and dependent variables x and y).

Evaluating the Polynomial

If you use the fitted polynomial in another program or spreadsheet model, you should consider the most efficient way to evaluate it; here, the obvious approach is not by any means the best.

Suppose you have the coefficients of an nth-degree polynomial in a BASIC array C(), where C(1) is the coefficient for xⁿ, C(2) is for xⁿ⁻¹, and so forth. The following BASIC code evaluates the polynomial in an obvious—but wrong—way:

```

Y=C(N+1)
FOR I=N TO 1 STEP -1
  Y=Y+C(I)*X^(N+1-I)
NEXT I
    
```

This code will perform n(n+1)/2 multiplications or execute the EXP or LOG routines n times, depending on the version of BASIC. To quote from an extremely useful resource book on numerical analysis, *Numerical Recipes*, "Come the (computer) revolution, all persons found guilty of such criminal behavior will be summarily executed, and their programs won't be!" (See reference 2.)

A much better approach uses Horner's rule for polynomial evaluation and requires just n multiplications:

```

Y=C(1)
FOR I=1 TO N
  Y=X*Y+C(I+1)
NEXT I
    
```

Suggestions and Caveats

You could expand the program to plot the data and the fitted polynomials. However, that would make it more machine-specific and considerably longer. A more efficient approach would be to enter the generated polynomial into a general-purpose plotting program with all the bells and whistles of scaling, labeling, dotted and dashed lines, and so forth.

Numerical analysis requires you to perform a large number of calculations and to interpret the results intelligently. This program handles the calculation, but the interpretation is still up to you. ■

REFERENCES

1. For additional information on the least-squares method and orthogonal polynomials see Ralston, A. *A First Course in Numerical Analysis*, New York: McGraw-Hill, 1965.
2. Press, et al. *Numerical Recipes: The Art of Scientific Computation*, New York: University Press, 1986.

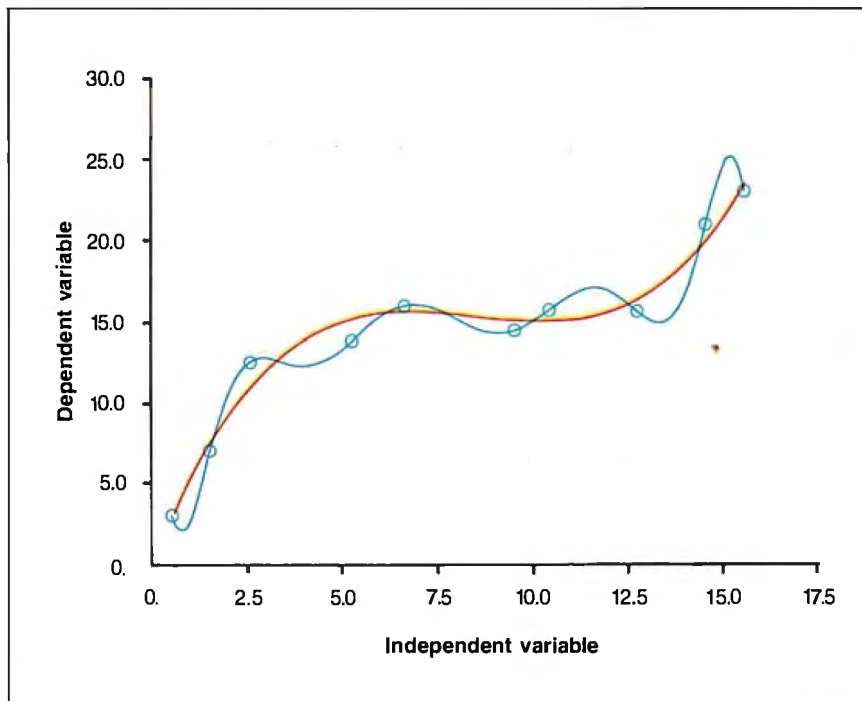

Figure 1: Ten data points approximated by a third-degree polynomial (in red) and a ninth-degree polynomial (in blue).

Introducing
a new personal computer
that does something
no other portable this small
can do.

Everything.



It simply works better

COMPAQ
PORTABLE III

The new COMPAQ PORTABLE III™ represents the most power and performance ever to fit in a package this small. What makes it remarkable is that we sacrificed nothing to accomplish this feat. It's the world's smallest full-function personal computer with *all* the advanced capabilities you'd expect to find in a high-performance desktop computer.

At 18 pounds, and half the size of our original portable, it is clearly the ultimate in portable computing today.

It features advanced 12-MHz 80286 technology that enables you to run programs written for 8-MHz personal computers up to 50% faster without sacrificing compatibility. And it offers enough RAM to satisfy even the

most demanding users. It comes with 640 Kbytes standard and is expandable to 6.6 Megabytes without touching one of its two attachable full-size expansion slots. Plus it offers an optional 20- or 40-Megabyte high-speed internal fixed disk drive. So now you don't have to resort to external add-on drives that make portability difficult.

It feels like we left new COMPAQ

We didn't.



12-MHz 80286
microprocessor



Full-size, detachable



Uses industry-standard
5 1/4" diskettes

We didn't stop there. Notice the full-size standard keyboard *with* a numeric keypad. The industry-standard 5¼-inch diskette drive compatible with the rest of the business world. The full-size, adjustable 640 × 400 high-resolution plasma display, which conveniently provides text *and* graphics on one screen. Even an optional internal modem.

With the COMPAQ PORTABLE III, there are simply no trade-offs. Using ingenious methods to streamline the technology, like surface-mounting chips on boards, we combined full-functionality with enhanced portability. Which reaffirms the status of Compaq® as the world leader in portable personal computers.



something out of the PORTABLE III.

Optional, attachable 2-slot expansion unit

Memory expansion up to 6.6 Mb

20-Mb or 40-Mb drive

8-MHz 80287 coprocessor

640 × 400 high-resolution plasma display

Shock mounts

standard layout keyboard

Optional internal modem

Switchable 110 or 220V power

Protective drive frame

Helpful LED indicators

Optional leather carrying case

Built-in interfaces for adding peripherals

Numeric keypad

Real-time clock

5¼-inch 1.2-Mb diskette drive

It simply works better

COMPAQ
PORTABLE III

No other portable computer harnesses as much power, speed, readability, memory, storage, and built-in industry-standard features as the new COMPAQ PORTABLE III.

Most other portables and laptops use much slower microprocessors. Most don't offer high-resolution displays or expansion slots. Many don't offer

high-capacity fixed disk drives. And not one offers the rugged, patented shock-mounting technology that's so important for the survival of a portable computer.

Their diskette drives are usually 3½" drives which make it impossible to use industry-standard 5¼" diskettes. Compaq, on the other hand,

uses industry-standard fixed disk drives. And our drives maximize compatibility with your desktop personal computers, so you don't have to transfer your data. Plus, our detachable full-size keyboard doesn't force you to use one that's small and cramped.

Not one of our competitors can rival our memory and stor-

It feels like the others

They did.

age capacity. The most RAM others offer is 2.6 Megabytes, which looks very small next to our 6.6 Megabytes. Storage is another story. The internal storage capacity of all our major competitors put together can't equal the storage capacity of a single COMPAQ PORTABLE III. We even offer an attachable, portable expansion unit, with

two full-size industry-standard slots so you can add features of your own.

It stands to reason that if our competitors had included *some* of the features we offer, chances are they would no longer be portables. This might be why Compaq sells more portable computers than any other company in the world.



left something out.



It simply works better

COMPAQ
PORTABLE III

The new COMPAQ PORTABLE III is actually half the size of our first portable. It's also the fastest portable computer in the world today.

With a processing speed of 12 MHz, its 80286 microprocessor is noticeably superior to most advanced-technology desktops. But processing speed, as most serious

business users know, is only one facet of high performance.

The greatest limiting factor of total system performance is the speed of disk drives. The fixed disk drives in the COMPAQ PORTABLE III are three times faster than most others, with an average access time of less than

30 milliseconds. We also built in high-speed RAM. Together, these enhancements work with the high-speed processor to avoid system bottlenecks, thereby maximizing information flow. You can even add an 8-MHz 80287 coprocessor to accelerate math-intensive work. So now there's

We run even faster since



less wait, with less weight.

The COMPAQ PORTABLE III is the most advanced portable in the world and offers the sophisticated user features normally associated with desktops. As with any computer we design, we make your needs our blueprint. Compaq gives you more function-

ality, versatility, power, memory, storage, and performance to go.

Through innovative design and engineering, we've built even more into an even smaller package. So once again, Compaq has set a precedent, a standard by which all other portable computers will be judged.



we've lost a few pounds.



It simply works better

COMPAQ
PORTABLE III

We obviously designed the COMPAQ PORTABLE III for the open road. But what makes it exceptional is that it can also hold its own on a desktop. Its speed, memory, and storage capacity help it outperform most desktop PC's. As an executive power tool, it can handle your biggest spreadsheets and largest data bases. And its ability to network and communicate with

mainframes will also surprise you.

So perhaps it's *not* surprising that the COMPAQ PORTABLE III, like all of our portables, isn't just for people who are going places. It's also for those who appreciate a footprint that's nearly 50% smaller than the average desktop computer. This built-in versatility proves Compaq always has a better handle on personal computing.

See the new COMPAQ PORTABLE III on a desktop near you—at one of over 3000 Authorized COMPAQ Computer Dealers worldwide.

For more information or the dealer nearest you, call 1-800-231-0900 and ask for Operator 31. In Canada, call 416-449-8741, Operator 31.

©1987 Compaq Computer Corporation. All rights reserved. Printed in the U.S.A.

This COMPAQ PORTABLE III
is so busy in the office,
it doesn't get out much.



It simply works better

COMPAQ
PORTABLE III™

Tim G. Hunkler

Atari 520ST Projects

An interface board for the Atari ST cartridge port

The purpose of this project is threefold: to present and test a technique for writing to the Atari 520ST's cartridge port; to build a simple but useful clock/calendar circuit; and to demonstrate some GEM dialogue-handling techniques using 68000 assembly language.

A little history is in order: One main feature of the Atari 520ST is the multitude of I/O capabilities available for the price. It has a serial port, a parallel port, a musical instrument digital interface (MIDI), a floppy disk interface, a direct-memory-access interface for hard disks, two joystick ports, and a cartridge port. With so many I/O methods, the Atari ST has a lot to offer the hardware hobbyist.

Initially, I had two projects in mind for my computer. The first would be an image digitizer that would mount on the printer's print head and let me digitize various images by using the printer to scan back and forth over the image. The second project was a floating-point coprocessor to enhance the ST's scientific and graphics applications. The most convenient connection for both projects would be the cartridge port.

The Problem

While I referred to the schematic for the cartridge port, a problem surfaced: The cartridge port lacks a read/write direction-control line. It appears that the cartridge port was designed as a read-only interface. Having a useful floating-point coprocessor requires that you be able to write data as well as read results.

Although it is possible to tap into a read/write signal within the ST and bring it out to the cartridge port, some additional testing indicated that this would be a futile effort. To protect cartridges from damage due to inadvertent writes, a cus-

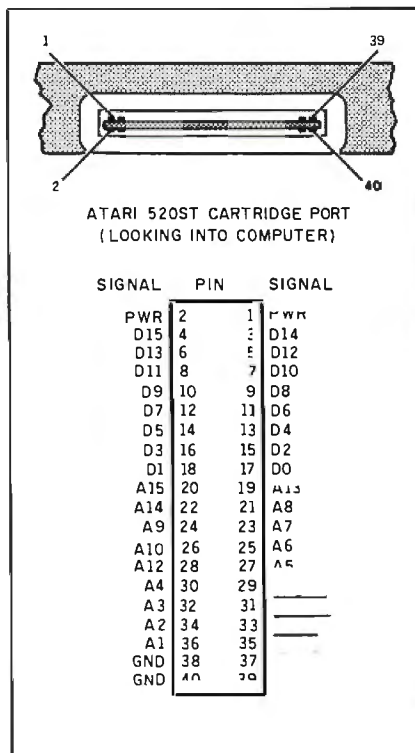

Figure 1: The Atari cartridge port and signals.

tom IC within the ST generates a bus error trap whenever a write to the cartridge address range is attempted for any reason. This protection feature means that you simply cannot create software that performs a write cycle to the cartridge port.

The Solution Revealed

The answer to overcoming the cartridge port's write-protection scheme is to give up using write cycles. A write cycle can be performed using a read cycle, some special software, and a little extra hard-

ware. I admit that this sounds bizarre but, because of the 68000's addressing power, you can actually use a portion of the address lines to pass data to the cartridge port and thereby overcome the write-protection scheme.

As an example, suppose you want to write the data value \$1234 to some hardware that you've attached to the cartridge port. How might you do this? A custom chip inside the ST decodes the range of addresses for the cartridge ROM address space. Two signals are produced and available on the cartridge-port connector. They are ROM3 and ROM4 (see figure 1 for cartridge-port pin assignments). When ROM3 is at logic zero, a read cycle is in progress from the address range of \$FA0000 through \$FAFFFF. Likewise, when ROM4 is at logic zero, a read cycle is in progress from the address range of \$FB0000 through \$FBFFFF (see figure 2 for signal timing).

The technique you use to write your data value of \$1234 to the cartridge port requires placing the data on the address lines, then reading from any address in the cartridge port address map. You need some external hardware to capture the data from the address lines and pass it to your desired destination. The software to do this might look like that in listing 1. The first line defines the symbol ROM3 to be the value \$FA0000. Line 2 ensures that the upper half of data register D0 will be zero when used in line 5. Line 3 loads a base address into address register A0.

continued

Tim G. Hunkler (1807 North Evergreen, Chandler, AZ 85224) has a BSEE from Purdue University. He is currently employed by the strategic electronics division of Motorola as a design engineer and is the author of various software products for the Atari ST.

Line 4 places the data you wish to output into data register A0. Finally, line 5 causes the data value \$1234 to be placed on the lower 16 address lines while an unknown byte value is read from the car-

tridge port and tested for zero. One simple hardware design for writing data using address lines is shown in figure 3. The TST.B instruction uses an addressing mode called Address Register

Indirect with Index to form the address to be tested. This address is composed of three parts:

Address Register: A0.L = \$00FA0000
 Index Register: DO.L = \$00001234
 Displacement: = \$00
 (sign extended to 32 bits)
 \$00FA1234

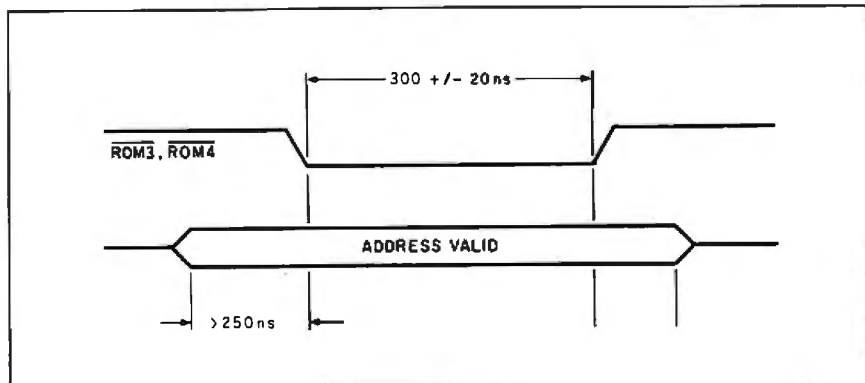

Figure 2: Cartridge-port address timing.

Listing 1: Code to transfer data to the Atari cartridge port.

```

ROM3 EQU $FA0000 ; define ROM select address
MOVEQ #0,DO ; clear the register
LEA ROM3,A0 ; load ROM select address
MOVE.W #$1234,DO ; load data into register
TST.B O(A0,DO.L) ; dummy read
    
```

The address \$FA1234 is generated by the TST instruction and is output by the 68000, which is in turn decoded by the custom chip on the ST into a ROM3 select strobe. Meanwhile the data value \$1234 is presented on the lower 16 address lines during the read cycle caused by the TST instruction.

If instead of writing a single 16-bit value you wanted to output a block of 1024 data words, the program might look like that in listing 2.

With the 8-megahertz 68000 in the ST, this code executes in approximately 4.1 milliseconds, giving a data-transfer rate of a little less than 500,000 bytes per second.

Problems

Some problems occur when you use the 16 lower address lines as data lines. Unless the data being written is guaranteed to be an even value, a byte read cycle must be performed instead of a word or long-word read cycle. To do otherwise would result in a 16-bit word access to an odd address, which would cause an odd address trap and crash your program.

Also, the least significant address bit, A0, does not exist on the 68000 micro-processor. Instead, it is used to generate two other signals, the upper and lower data strobes (UDS and LDS respectively). On the cartridge-port connector, you can use UDS in place of address A0, as long as you use only byte read cycles.

When you combine the data in the index register with the address register, it is important that the upper 16 bits of the index register be zero and that the full 32 bits be specified for the index register. Otherwise, the data will be sign-extended, and the resulting address will cause ROM3 or ROM4 not to be selected.

You now realize that it is not as simple to write data to the cartridge port as you might have first guessed. It has the disadvantage of being slower than a direct-to-memory write cycle and requires that you perform some software contortions for every piece of data to be written. However, it does overcome the limitations of a read-only cartridge port and requires no hardware modification to the Atari ST. This method has a higher data-transfer

continued

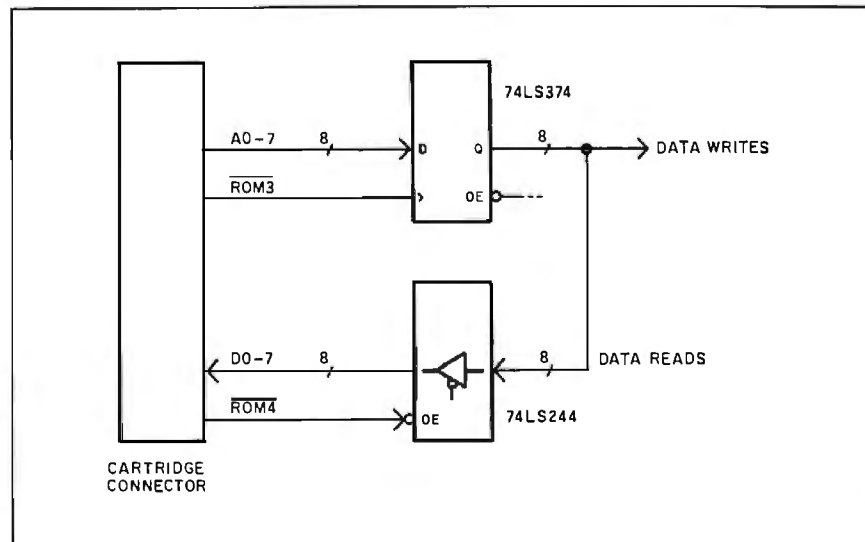
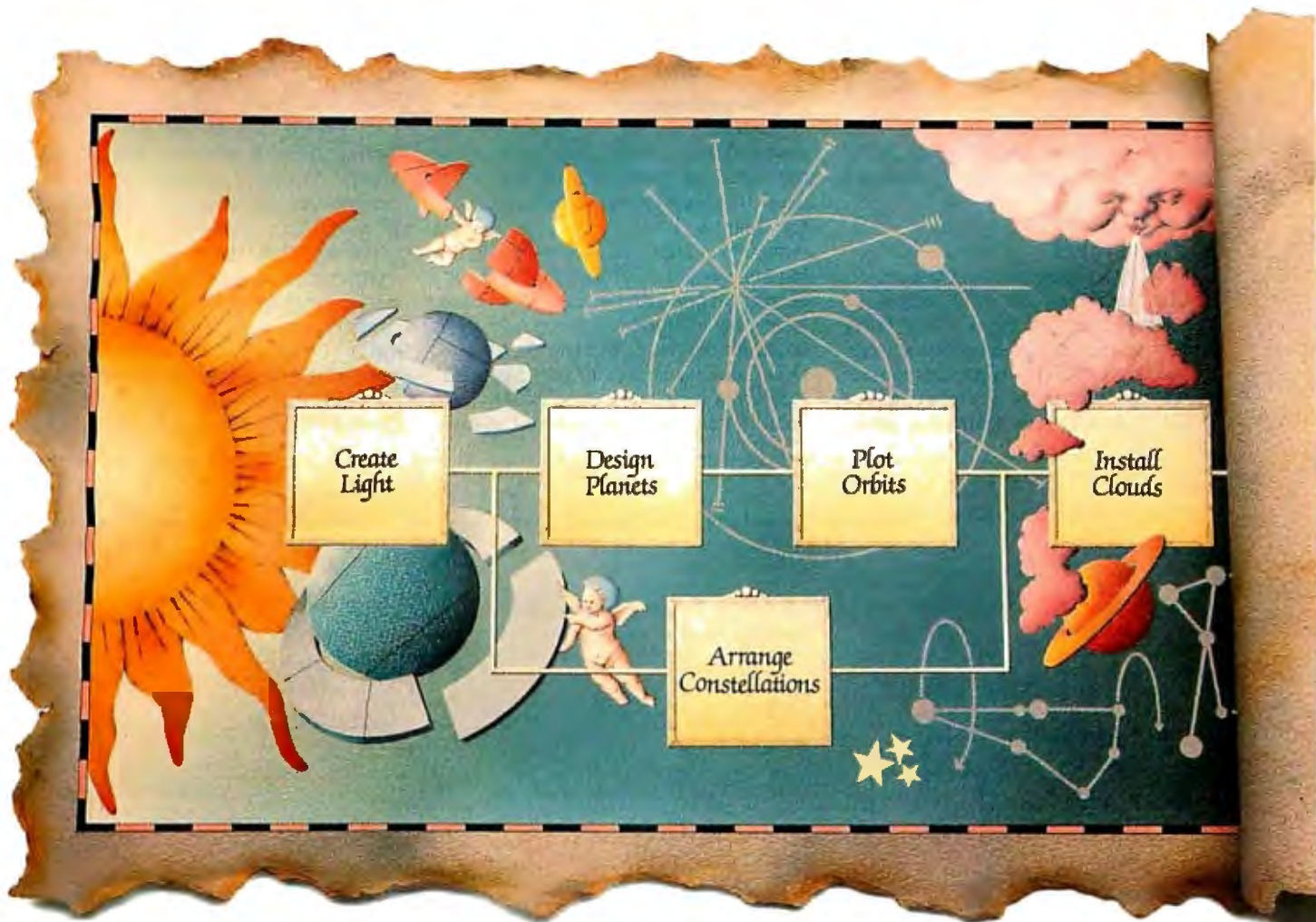

Figure 3: A simple circuit for data separation on the cartridge port.

Listing 2: Code to transfer a block of data to the cartridge port.

```

LEA DATA,A0 ; load address of data block
LEA ROM3,A1 ; load cartridge base address
MOVEQ #0,DO ; ensure upper word is zero
MOVE.W #1023,D1 ; loop count = 1023 + 1
LOOP: MOVE.W (A0)+,DO ; get next data word
TST.B O(A1,DO.L) ; output word on address lines
DBRA D1,LOOP ; repeat for 1024 words
    
```



NOW IT'S EASIER TO MOVE HEAVEN & EARTH.

Introducing Harvard Total Project Manager II.

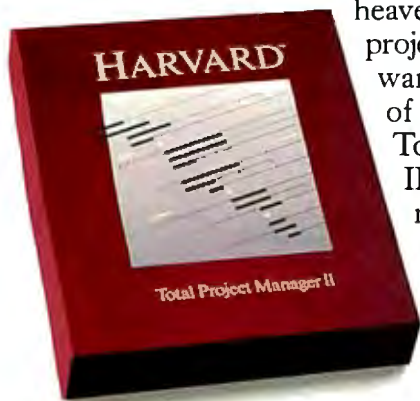

If you have to move heaven and earth, the best project management software can make a world of difference. Harvard Total Project Manager II (HTPM II) lets you manage important projects faster and easier, with earth-shaking new features.

Finally you can plan your project directly on the computer.

HTPM II's unique graphic Work Breakdown Structure lets you identify all your project's tasks entirely on-screen. From there, it's easy to optimize your project's plan through a program-generated PERT chart.

Or, if you prefer, you can create or manage your project in the PERT chart, Gantt chart or HTPM II's own Task List format.

With HTPM II, managing resources has never been easier. When you're juggling several projects, you can track allocations across all jobs and be instantly alerted to over-commitments. Automatic resource leveling easily resolves complex conflicts, too.

HTPM II also clearly displays actual vs. planned and baseline information on-screen, to help evaluate costs and scheduling.

And, for presentation-quality reports, HTPM II supports an expanded list of peripherals, including the HP Laserjet and many plotters.

So for better planning, scheduling, controlling and reporting, choose HTPM II. Because with Harvard Total Project Manager, the sky's the limit!

**For a free trial size diskette call 1-408-848-4391.
For upgrade information call 1-800-255-5550.**

GRADUATE TO HARVARD TOTAL PROJECT MANAGER II.

Runs on IBM XT with hard drive and MS DOS compatibles. Software Publishing Corporation, P.O. Box 7210, Mt. View, CA 94039-7210.

rate than the serial, joystick, or MIDI ports and is suitable for many hobbyist projects.

The Test Project

I chose a clock/calendar as a test project for the cartridge-port write technique. The clock/calendar circuitry is fairly simple and the finished project is a useful addition to the 520ST. However, another problem soon surfaced when I attempted to find a prototyping board that would

plug into the cartridge port. It seems that the cartridge port's 40-pin connector uses .079-inch centers between connector contacts. I tried prototyping boards with .050-, .100-, and .125-inch spacing, but none would mesh with the Atari connector. It appeared that the only solution would be to build a custom prototype board for the Atari. To my good fortune, Douglas Electronics of San Leandro, California built this custom prototyping board for the Atari and added it to their

catalog of board products. The resulting general-purpose wire-wrap board is quite flexible and will support roughly fifteen 16-pin DIPs or 128K bytes of EPROM.

Having solved the problem of the Atari connector as well as which prototyping card to use, I designed the clock/calendar circuitry; the result is shown in the schematic of figure 4. The components required for this circuit are given in the parts list in table 1. The circuitry is divided into three major functional areas:

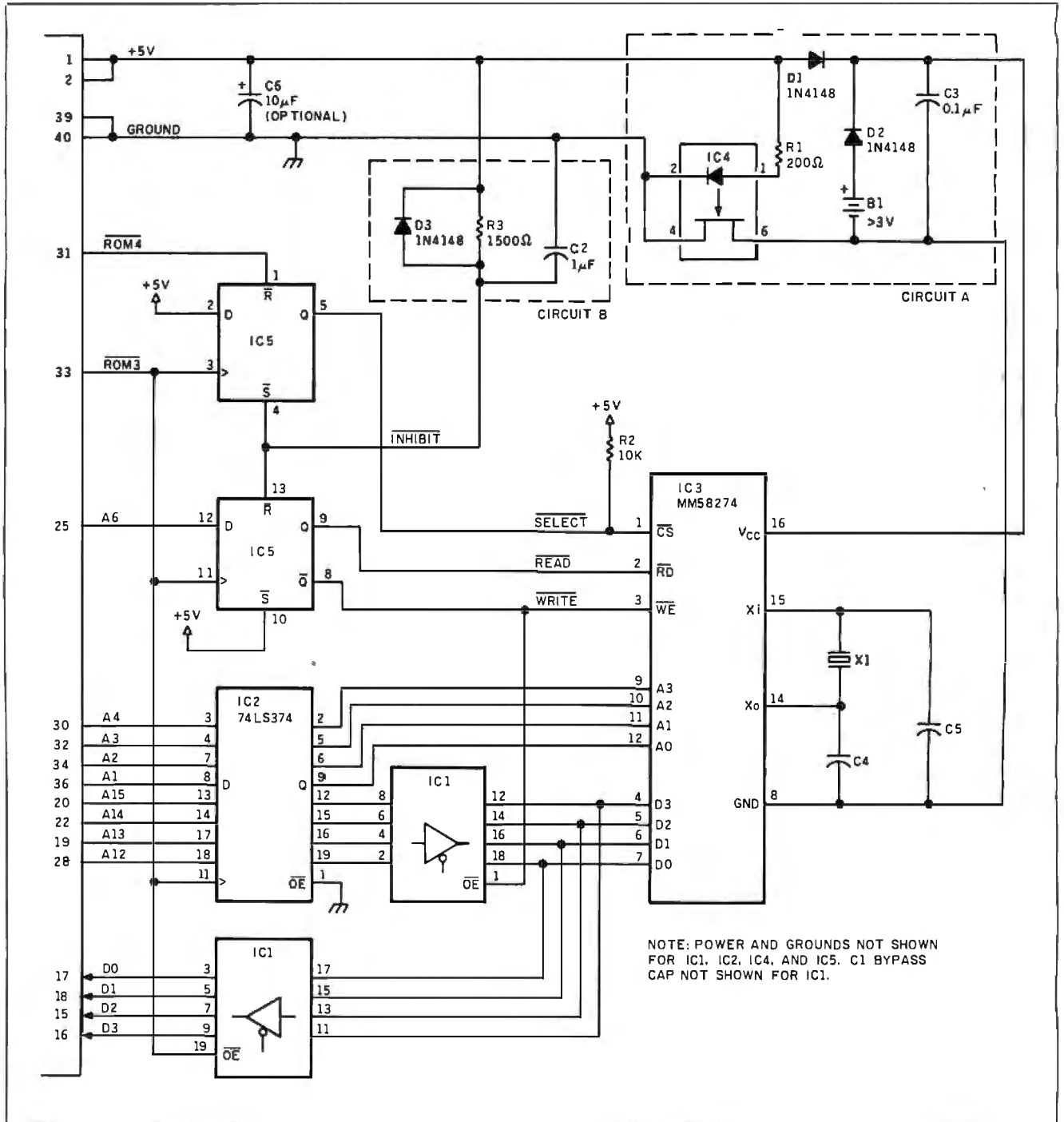

Figure 4: The clock/calendar circuit.

the interface to the cartridge port, the power-down isolation and keep-alive power, and the power-up/power-down glitch protection.

The Interface

Accessing the clock chip, IC3, is a three-step process. First, a 16-bit control pattern is formed and clocked into the IC2 8-bit latch and the IC5 flip-flop by using the ROM3 select strobe. This control pattern is coded as follows:

DDDD W.AAAA. where:

- DDDD = data bits to write
- W = read/write control
- AAAA = clock register address
- . = unused bit

The second step is a read cycle using the ROM4 select strobe. This causes the SELECT to be set low, and the clock chip is accessed for either a read or write operation setup by the W bit of step 1. If the operation is a read operation (W=0), the data from the clock chip is passed through IC1 onto the data lines of the cartridge port and is read by the software. If it is a write operation, the D bits stored in IC2 by step 1 are passed to the clock chip via IC1.

The third step involves a read cycle from ROM3 once again. This will cause the SELECT line to be set high and will end the read or write operation to the clock chip. It is possible to pipeline the accesses to the clock chip by combining step three of one access with step one of the following access.

Glitch Protection

The key to a successful battery-backup clock circuit is avoiding glitches during power-up or power-down that inadvertently produce write cycles. These write cycles can garble the time held by the clock chip. The glitch protection used for circuit B is not 100 percent reliable but is far simpler than alternative methods. The glitch-protection circuitry for power-up/power-down consists of R2, R3, C2, and D3. The R2 pull-up resistor increases the odds that the IC5 flip-flop will power up with SELECT high. The RC combination of R3 and C2 momentarily holds INHIBIT low during power up to force SELECT high and READ low. The D3 diode provides a fast discharge path for C2 so that quickly turning the power off and then on is properly handled.

Power-Down Isolation

The key to a long backup-battery life is eliminating current leakage paths during computer power-down. An effective way to do this is to disconnect the power and ground between the clock chip and battery from the rest of the circuitry.

Circuit A is used to provide power-down isolation and battery backup power while the ST is turned off. When the power is turned on, R1 and IC4 cause the ground of the clock and battery to be connected to the ground of the rest of the circuitry. With power turned off, the ground is disconnected and power is supplied through battery B1 and diode D2. Diode D1 eliminates leakage through the +5 volt line. Test measurements show a battery draw for this circuit under power-

Accesses to the clock chip can be pipelined by combining the read of the last access with the setup of the next access.

down conditions of 5 microamperes. When you use a standard 110- or 150-mA per hour coin-type lithium battery, the expected battery life would be on the order of 2 1/2 years.

The Software

The software consists of two programs. The first, CLOCKSET.ASM, is a program that uses GEM dialogues to verify or change the time and date of the clock cartridge. It also automatically updates the time that both TOS and GEM report. The second program, TIMESET.ASM, will automatically set the time and date during the computer boot-up sequence. [Editor's note: Both programs are available on disk, in print, and on BIX. See the insert card prior to page 321 for details. Listings are also available on BYTEnet. See page 4.]

The first step in writing a GEM-based program is to understand the dialogues

continued

Table 1: Parts list for the Atari clock cartridge.

Item	Part No.	Description	Manufacturer	Sources
IC1	74LS244	Octal buffer	—	—
IC2	74LS374	Octal latch	—	—
IC3	MM58274	Clock calendar	National Semiconductor	—
IC4	H11F1	Opto isolator	General Electric	gikey (H11F1GE)
IC5	74LS74	Dual flip-flop	—	—
X1	—	32,768-Hz crystal	—	Digikey (X32768)
B1	I2325	Lithium battery	—	Digikey (P135 or P136)
BH1	—	Coin battery holder	—	Digikey (BH906ND)
D1-3	1N4148	Diode	—	—
R1	200 ohms	Resistor, 5 percent	—	—
R2	10k ohms	Resistor, 5 percent	—	—
R3	1500 ohms	Resistor, 5 percent	—	—
C1, 3	.1 µF	Bypass cap	—	—
C2	1.0 µF	Capacitor	—	—
C4, 5	18pF	Disk cap 5 percent	—	Digikey (P4403)
—	—	Header, 20 by 1	—	Digikey (929400-01-30), quantity 2
S1-5	—	20-pin WW sockets	—	Digikey (C8120), quantity 5
Board	33-DE40	Proto board	Douglas Electronics	(415) 483-8770

The Digikey references are followed by the part number in parentheses. Digikey's phone number is (800) 344-4539. Douglas Electronics' address is 718 Marina Blvd., San Leandro, CA 94577.

and windows. Dialogues are simple, fill-in-the-blank or select-a-button methods of displaying information and obtaining user input. Windows are a more general-purpose method and can be used for any number of display techniques, from screen editors to paint programs. CLOCKSET.ASM uses a dialogue because it is the simplest way to present the clock chip's time and date and to let you edit these items.

GEM provides function calls to draw a dialogue and to handle all user interaction with the dialogue in the form of the mouse buttons, and editable text fields. To use these routines, you have to define a resource tree that tells GEM how to draw your dialogue and how to react to your input. You specify a dialogue using a resource tree (a memory construct composed of a linked list of objects).

Objects are arranged in what is called a visual hierarchy. This arrangement requires that an offspring object must fit entirely within a parent object. Two or more objects within the same parent are called *siblings*. Siblings may overlap in any way

or not at all. Siblings can also have their own offspring, which may have offspring, and so on, resulting in a nesting of many levels. Resource trees are arranged so that the largest object or root object is first. The objects that follow the root object are ordered starting with the root object's first offspring, followed by the offspring's offspring, and so forth to the end of the list. The resource tree's second offspring of the root object follows, followed by its offspring.

Each object has three linkages: one to the next sibling, one to its first offspring, and one to its last offspring. Each object also contains an *x* and *y* coordinate that is an offset from the upper left corner of the parent of the object. Also present is information concerning a width and a height. The width and height together with the *x* and *y* offset calculate a clipping rectangle used when the object is drawn. Objects contain a general-purpose longword that, depending on the type of the object, can be a string address, the address of a text information block or icon, or can define a border thickness and color. Also present

are words with bit flags that define whether the object can be selected, has been selected, is marked, checked, crossed, disabled, and many other attributes.

The Developer's Kit available from Atari contains the Resource Construction Set (RCS) utility, which generates dialogues and other types of resources. For assembly language programming, it is convenient to use the RCS to build the dialogue and then save a C source-code version of the dialogue. This C source file is edited to convert it into a series of data statements used in the assembly language program.

Figure 5 illustrates the basic form that the dialogue box in CLOCKSET.ASM uses, as well as the corresponding linkage between the objects. Notice how the offspring objects are contained within the borders of their parent objects. Object 0 is the root object. Object 1 defines an inner framing box. Objects 2, 3, 4, 12, 13, and 14 are siblings and offspring of object 1. Objects 5 through 11 are siblings as well as offspring of object 4.

The main body of CLOCKSET.ASM is responsible for displaying the dialogue. Once the support routines are created, the procedure is fairly straightforward. CLOCKSET.ASM first initializes all GEM tables needed to make GEM function calls. The time is read from the clock cartridge and formatted for display in the dialogue. Next, a routine is called that displays the dialogue and waits for one of three buttons to be activated. CLOCKSET.ASM then processes the action required when that particular button is activated. This action will be either: exit the program (Exit), use the information on the dialogue to update the clock cartridge (Set), or update the dialogue information from the clock cartridge (Clock Cartridge). Except when you choose the Exit button, the dialogue is immediately reentered and the cycle repeats itself.

TIMESSET.ASM is a short program that reads the time and date from the clock cartridge and modifies the time and date of both TOS and GEM. When it is placed in an AUTO folder, it will automatically execute during the computer boot-up process and correctly set the time, provided that the clock cartridge is present and working. TIMESSET.ASM initializes the clock cartridge after power-up, reads the time and date, and updates the computer's version with this data. The time and date are also formatted and displayed on the screen. After a brief pause, the program exits. If the time or date is invalid because the battery is dead, the clock cartridge is not attached, or there is some other problem, an error message is displayed prior to exit. ■

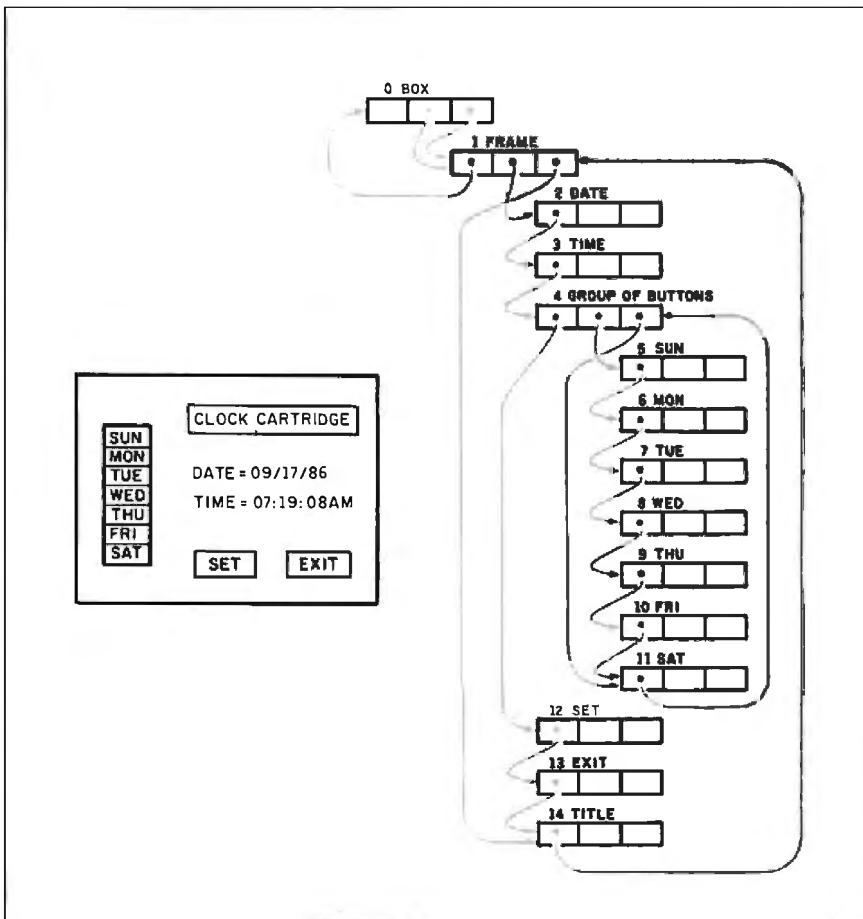

Figure 5: The dialog box for CLOCKSET.ASM and the linkage between objects. The first object (0) is the root object, and object 1 is its offspring, or sibling. Object 1 is the parent of objects 2, 3, and 4. Object 4 is the parent of objects 5 through 11.

These days people are buying all kinds of things over the phone.

Furry slippers. Tulip bulbs

So we think there

are a lot of you out there who might be comfortable with the idea of buying computer over the phone. Don't

be fooled by the salesmen from the people who design and make them. PC's Limited™. We knock that 35 to 45 percent dealer markup right out of the price. So you can get a complete 286 system for about half



and Compaq™ are asking. And we can still make a pretty decent profit.

Naturally, the danger is that people might think such a low priced computer isn't any good. So we teamed up with a company that has more than a thousand trained technicians all over the country. To give you warranty service for our PC's on site, for free, for a whole year.

If there's any better way to tell people how much we believe in our quality we haven't thought of it yet.

So far, about

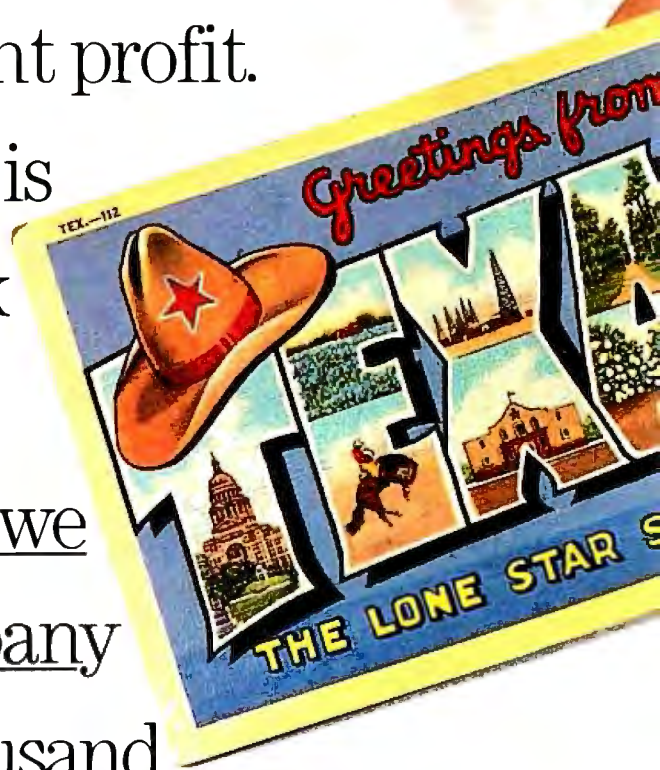

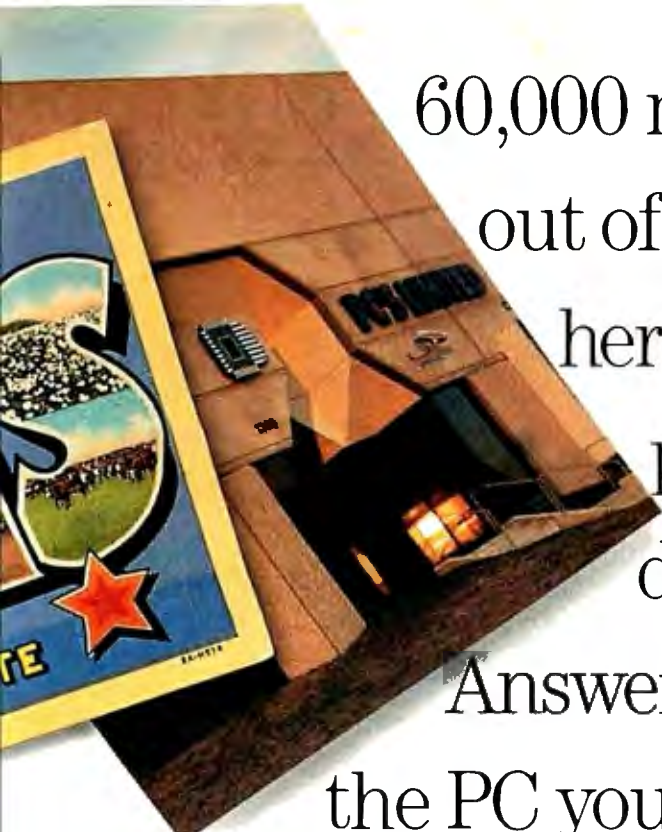

60,000 machines have gone out of the PC's Limited™ plant here in Austin. You just pick up the phone and dial 1-800-426-5150.

Answer a few questions about the PC you want, give us your credit card number, and UPS will deliver your computer right to your door.

We even pay the shipping charges.

And in case you don't like the system for any reason, we give you 30 days to send it back. For a full refund.

So that's how you buy a computer over the phone. It's really pretty simple. But then, it seems the best things in life usually are.



Here are the details about our meg

System

Intel 80286 running at 6 and 12 MHz
 1024K on board
 1.2 Meg floppy drive
 Combined floppy and hard disk Controller
 AT-style Keyboard
 192 watt Power Supply
 Clock/Calendar with battery backup
 Hercules compatible Monochrome Graphics card
 2 Serial and 2 Parallel ports
 High Resolution Monochrome Monitor
 AT standard chassis
 SmartVu™ (Real Time Diagnostic Display)
 With a 40 Meg, 28 MS hard drive \$2,999
 With an 80 Meg, 28 MS hard drive \$3,399

The 286¹² EGA Color System

The above system with our EGA card
 2 Serial and 1 Parallel port
 The EGA High Resolution Monitor
 With a 40 Meg, 28 MS hard drive \$3,499
 With an 80 Meg, 28 MS hard drive \$3,899

System

1.2 Meg floppy drive
 Combined floppy and hard disk Controller
 AT-style Keyboard
 192 watt Power Supply
 Clock/Calendar with battery backup
 Hercules compatible Monochrome Graphics card
 2 Serial and 2 Parallel ports
 High Resolution Monochrome Monitor
 SmartVu™ (Real Time Diagnostic Display)
 With a 20 Meg, 65 MS hard drive
 and the space saving chassis \$1,799
 With a 40 Meg, 65 MS hard drive
 and the AT standard chassis \$2,249

The 286⁸ EGA Color System

The above system with our EGA card
 2 Serial and 1 Parallel port
 The EGA High Resolution Monitor
 With one 20 Meg, 65 MS hard drive
 and the space saving chassis \$2,299
 With a 40 Meg, 65 MS hard drive
 and the AT standard chassis \$2,749



AT standard chassis



Space saving chassis



abytes and megahertz and all that.

The Turbo System

Intel 16-bit 8088-2 running at 4.77 and 8 MHz
640K on board
AT-style Keyboard
130 watt Power Supply
Hercules compatible Graphics Adapter with
1 parallel port
High Resolution Monochrome Monitor
With one 360K floppy drive \$799
With one 360K floppy and a 20 Meg,
65 MS hard drive \$1,199

The Turbo EGA Color System

The above system with our EGA Card
The EGA High Resolution Monitor
With one 360K floppy drive and a
20 Meg, 65 MS hard drive \$1,699
With one 360K floppy and a 40 Meg,
40 MS hard drive \$2,199

To order a PC's Limited™ computer call us at 1-800-426-5150. Extension 711. In Texas call 1-800-252-8336. Extension 711. Our sales lines are open from 7 to 7 Monday through Friday and 9 until 2 on Saturday, Central Standard Time.

There are just a few other things you need to know.

We have technical support people that you can talk to for free by calling 1-800-624-9896.

Our Total Satisfaction Guarantee works like this: Any item bought from us may be returned within 30 days from the date it was shipped for a full refund of your purchase price. Returned items must be as-new, not modified or damaged, with all warranty cards, manuals, and packaging intact. Returned items must be shipped prepaid and insured, and must bear a PC's Limited Credit Return Authorization (CRA) on the shipping label.

Our On Site, One Year Limited Warranty says we warrant each system we manufacture to be free from defects in materials and workmanship for one year following the date of shipment from PC's Limited. During the one year period, we will repair or replace, at our option, any defective products or parts at no additional charge, at your place of business, in the next business day, if your company is located within 100 miles of one of our 180 service centers. This service applies to complete systems only.

Call or write PC's Limited for the complete terms of our total satisfaction guarantee and our one year warranty.

PC's Limited, 1611 Headway Circle, Building 3, Austin, Texas 78754.



Call 1-800-426-5150. In Texas, 1-800-252-8336. Please ask for extension 711.

PC'S LIMITED™

GET SERIOUS



...ABOUT ANALYZING YOUR DATA.

You might be spreading your spreadsheet a little too thin. Or maybe you're starting from scratch. But if you're serious about data analysis, you're ready for SPSS/PC+™ — a full software family that brings you six high-powered ways to complete any data analysis task.

Enter it. SPSS/PC+ Data Entry™ takes the effort out of entering and correcting data.

Analyze it. The SPSS/PC+ Base Package provides a powerful array of statistical and reporting procedures.

Examine it. SPSS/PC+ Advanced Statistics™ lets you get more serious with your data.

Table it. SPSS/PC+ Tables™ produces presentation-ready tables instantly.

Chart it. SPSS/PC+ Graphics™ featuring Microsoft® Chart creates show-stopping graphs and charts.

Map it. SPSS/PC+ Mapping™ featuring MAP-MASTER™ — our latest option — creates maps where vast amounts of data can be summarized and presented in one, simple picture.

SPSS/PC+ products are being put to productive use by serious fact finders in business, government and education. For countless purposes such as market research. Wage and salary studies. Survey analysis. And quality control. Plus each product is superbly documented and supported by SPSS Inc., a leader in statistical software for nearly 20 years. While specially tailored customer support is available through the VALUE PLUS™ plan.

So if you're serious about data analysis, step up to SPSS/PC+. For details, contact our Marketing Department.

CALL 1/312/329-3630

SPSS inc.

SPSS Inc. • 444 North Michigan Avenue, Suite 3000 • Chicago, Illinois 60611

In Europe: SPSS Europe BV • P.O. Box 115 • 4200 AC Gorinchem, The Netherlands • Telephone: +31183036711 • TWX: 21019

SPSS/PC+ runs on IBM PC/XT/ATs with hard disk. Contact SPSS Inc. for compatible microcomputers. SPSS/PC+, SPSS/PC+ Data Entry, SPSS/PC+ Advanced Statistics, SPSS/PC+ Tables, SPSS/PC+ Graphics and SPSS/PC+ Mapping are trademarks of SPSS Inc. for its proprietary computer software. VALUE PLUS is a trademark of SPSS Inc. Chart and Microsoft are trademarks of Microsoft Corporation. MAP-MASTER is a trademark of Ashton-Tate. Hardcard is a trademark of Plus Development Corporation.

© 1987, SPSS Inc.

Computer-Aided Design

Data Structures in CAD Software 177
by Larry Pfortmiller

The CADcompiler 187
by Arthur W. Crooke

Computer-Aided Routing of Printed Circuit Boards 199
by Stephen E. Belter

IGES 209
by Ralph J. Mayer

CAD for Building Chips 217
by Steve Trimberger and Jim Rowson

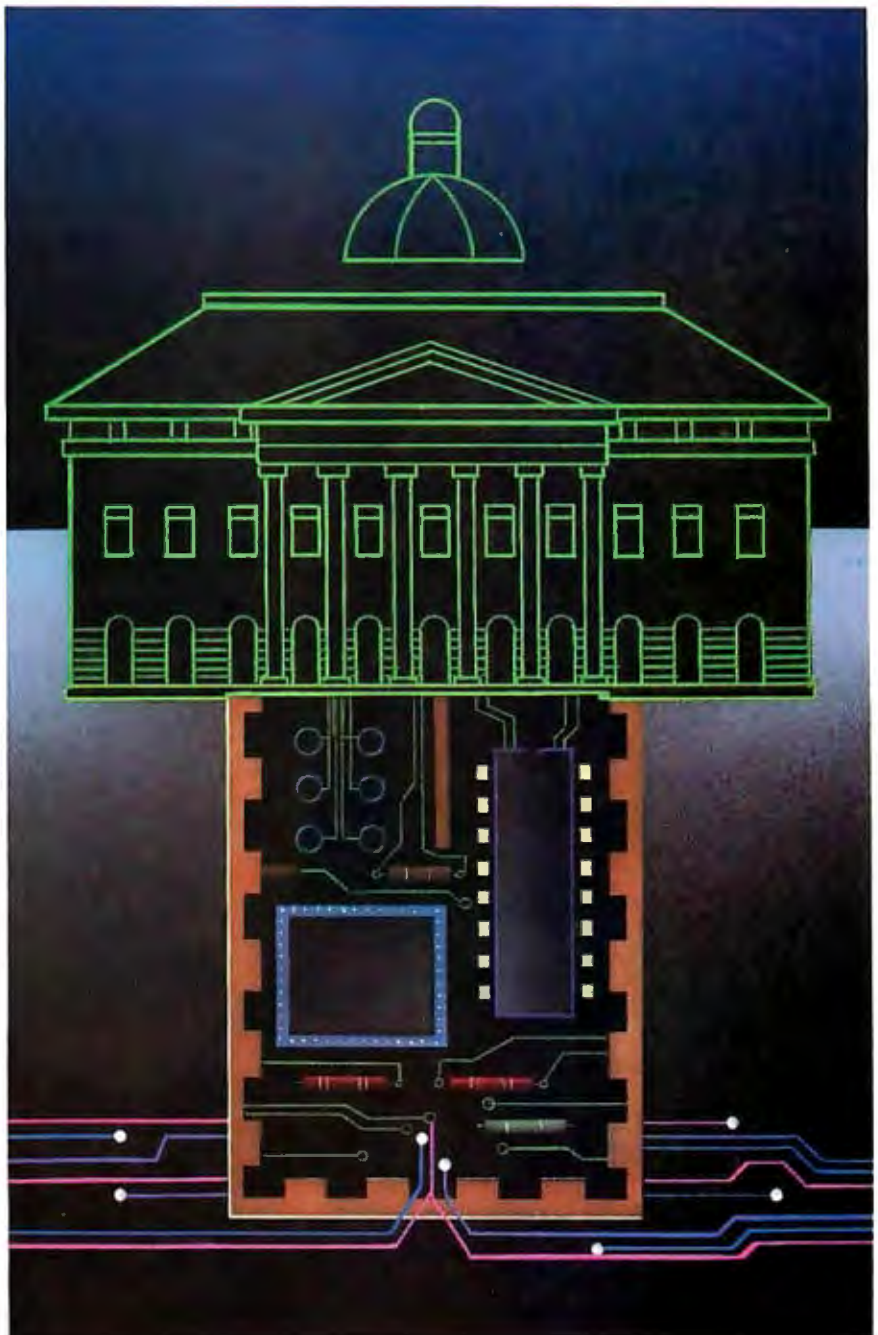



Introduction

Computer-Aided Design

Few innovations have made an impact on manufacturing so great as that of computer-aided design (CAD). The process of designing a part that once might have taken weeks or even months to complete has been reduced to days. The return has been great, but so has the investment. In fact, not long ago that investment could have reached hundreds of thousands of dollars.

But advances in personal computer technology helped to change that. And as the price of a CAD system neared the \$10,000 range, design engineers began finding more uses for CAD. One of the more interesting applications of CAD is in the field from which it emerged—electronic design. After all, CAD systems aren't limited to structural drawings.

Several companies have developed CAD systems to design and optimize electronic circuits for silicon chips. The software that outputs the circuitry artwork for semiconductors is known as a *silicon compiler*. In their article, "CAD for Building Chips," Steve Trimberger and Jim Rowson consider silicon compilers for regular arrays, partially regular arrays, and nonregular arrays.

Once a chip gets to a printed circuit board, there's another particularly helpful function that a CAD system can provide—computer-aided routing of the circuit traces. Because no two traces can cross one another, finding routes for all the traces on, say, a system motherboard can be overwhelming.

But how do you give a computer the intelligence to do the job automatically? If board real estate were not an issue, the problem would be relatively small. Writing a routine that routed traces only so they did not intersect would be simple enough, but the resulting PC board for a system motherboard might be the size of a desktop. The real trick is to use an algorithm that not only avoids intersections but also finds the shortest possible route. Stephen E. Belter, who's been involved in CAD since 1971, contributed "Computer-Aided Routing of Printed Circuit Boards," which provides a close look at one such algorithm—the so-called Lee's Algorithm.

If you'd rather roll up your sleeves and try your hand at working with a CAD program to design your own digital circuits, then read "The CADcompiler" by Arthur W. Crooke,

a digital systems design consultant. Mr. Crooke knows that the drawing of a digital circuit is not nearly as important as its description, so he has written a CAD program that uses what he calls a database management approach. And Mr. Crooke has made version 1.2 of his program available to BYTE readers. You can download and begin using it to design your own circuits right away.

Of course there are other, more generic, CAD issues to consider. At the heart of any CAD software system is the data. Typically, a CAD program stores information as a collection of objects, and each of these objects is made up of graphics primitives, such as lines, arcs and circles, polygons, and splines. Other types of data the system must deal with include text and symbols. The larger and more complicated the drawing, the larger and more complicated the data will be. Structuring that data efficiently is the focus of Larry Pfortmiller's "Data Structures in CAD Software."

It's not enough to be concerned with just the internal data structures of CAD; you should also consider a way to exchange data between CAD systems. While the solution may at first seem easy—just build a direct translator between the systems—the problem grows when you consider all the varied systems available. And nearly every one handles data differently. That's where IGES (Initial Graphics Exchange Specification) comes in. IGES is a neutral file that was developed for CAD data to be what DIF (data interchange format) files are to spreadsheets. Simply put, if a CAD system can translate to and from the IGES format, then it can exchange data with all other systems that use IGES. Ralph J. Mayer, a member of the IGES steering committee, takes a critical look in his article, "IGES," at the benefits and trade-offs of the neutral file solution.

Unfortunately, we cannot cover all aspects of CAD in a single issue of BYTE. In selecting these articles for our CAD theme, we've taken a very narrow focus on CAD, but we hope it's one that you will find useful. However, to add to our CAD coverage, next month we will review several CAD software packages for the Apple Macintosh, and in the following month, several packages for the IBM PC and compatibles.

—Dennis Allen, Technical Editor

THE ADVANTAGE



ENHANCED



Kaypro Corporation — electronics innovator since 1952 — has made a good thing even better. The KAYPRO 286i Model C now features a 40-MB hard drive and the 101-key AT-style keyboard. With the latest standard feature enhancements, the KAYPRO 286i is the smartest choice in advanced computer technology.

Advanced.

The heart of the KAYPRO 286i is the 80286 microprocessor — with a processing rate of 10 MHz and a 640-kilobyte RAM. The perfect match for today's high productivity software.

And Enhanced.

The KAYPRO 286i Model C has

a 1.2-MB floppy disk drive, plus a hard disk with 40 MB of storage. The KAYPRO 286i AT-style keyboard features the new 101-key layout with separate cursor control, numeric keypad, and 12 programmable function keys.

Perhaps the nicest surprise about the KAYPRO 286i/C is the suggested retail price of \$2995.

You won't find distinctive metal construction, 10-MHz processing, and free name-brand software that includes WordStar Professional Release 4 in any other AT-type computer. Other company's extras are Kaypro standard features.



Kaypro's Commercial Leasing



See us at COMDEX™ Booth 628



Kaypro's Revolving Charge Plan

The KAYPRO 286i Model C features...



80286, 10-MHz
Microprocessor.



An internal hard
disk drive with 40MB
of storage.



Enhanced 101-key
IBM PC/AT-style
keyboard with
security keylock.

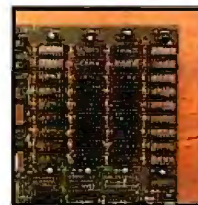

A 640-KB RAM,
expandable to
15 MB.



Bundled software
includes WordStar
Professional Release 4.

Trademarks: 286i, Kaypro Corporation; IBM, AT International Business Machines; WordStar Professional Release 4, Micro Pro International.



made in U.S.A.

For the Kaypro Dealer near you, call 1-800-4KAYPRO.

Data Structures in CAD Software

*A description of image types
and their computer representation*

Larry Pfortmiller

VISUALIZING OBJECTS IS an inherent part of technical design and drawing. Drawing techniques and conventions in many design and engineering disciplines have evolved into a universal form of visual shorthand that communicates both the content and the execution of an idea.

Computer-aided-design/drafting systems become increasingly accessible to designers, engineers, architects, and draftpersons as hardware and program costs decrease. CAD software is a demanding application for microcomputer-based technology due to its calculation-intensive nature. The designer of CAD programs faces an interesting spectrum of options in structuring how the software stores and manipulates the graphics elements that compose CAD images.

This article focuses on the data structures that are efficient for microcomputer CAD and discusses several ancillary issues relevant to both designer and user.

Basic CAD Approaches

There are two approaches to the design and function of CAD systems: the *design* or *three-dimensional-modeling* concept and the drafting *sketchpad* concept.

The first approach creates an analog model of the desired object or processes and stores the objects as geometric data, attributes, and relationships. This approach can be used for both visualizing a real-world object and generating traditional production drawings. The sketchpad approach creates and manages basic graphics primitives. The manual sketching and drawing of lines and arcs on paper is replaced by similar operations on

a CRT screen. In what follows, I shall concentrate on this approach.

Computer-aided drafting systems store drawing information as a collection of images, items, or objects. These terms refer to the same elements; unfortunately, there is no standard terminology. The term *graphics primitives* is also commonly used to designate the base elements that compose an image.

Each image corresponds to a primitive data structure that contains most of the information necessary to fully describe each individual image. The most common drawing primitives encountered in two-dimensional CAD systems are shown in figure 1 and described below.

Points, Shapes, and Markers

A point is, conceptually, merely a location specified by a coordinate value. Unadorned points are not often needed in a finished image but can provide convenient hooks in a drawing for attaching notes and referencing locations. Many systems allow specifying codes that cause a point to be displayed with markers or shapes that can be used as dimensioning terminators (arrows, dots, slashes, boxes), flowline markers, crossover and break symbols, and the like. The geometry of such marking symbols is displayed but usually cannot be edited manually.

Lines

Lines are stored as two-coordinate values marking the line's starting and ending points. Color, line-style, width and level attributes are also usually assignable. An alternative storage representation stores a

line as two pointers that point to the location of the start- and end-coordinate values. Since most drawings consist of connected line segments of the same line type, using pointers this way would seem to be more efficient.

Although the coordinate values need to be stored only once, they still need to be referenced by pointers stored in the line image. If long-integer pointers are used with double-precision coordinate values and all lines are connected in at least one place, then using pointers requires 25 percent less space for two- or three-dimensional images.

Data coordinates that are 4-byte floating-point numbers consume the same amount of space as long-integer 4-byte coordinates, but coordinate values that are 2-byte integers require 33 percent more storage for two-dimensional, and 16 percent more for three-dimensional, images. In addition, the pointer approach necessitates a reference counter stored with each coordinate to recognize when no graphics primitives use that coordinate.

Arcs and Circles

There are several methods of storing circle and arc data. The most common is

continued

Larry Pfortmiller is vice president and director of research and product development at Foresight Resources Corporation (932 Massachusetts St., Lawrence, KS 66044). He has a Ph.D. in physics from the University of Kansas and is the author of Drafix 1 and Drafix 1 Plus.

Symbols are used extensively in almost all CAD systems for representing standard elements in drawings.

storing the center points, radius, and starting and ending angles, or the starting and incremental angle with a positive or negative direction. The incremental-angle method makes it easy to identify an arc's direction. Alternatively, three points can define an arc. The start and endpoint coordinates can be stored along with a third point on the arc itself. The third point is used to compute the arc center, radius, and starting and ending angles as needed.

Polygons

Connected line segments and polygons (closed connected line segments) store a path or connected series of points or lines, all having the same attributes. The argument for pointers versus stored coordinates in the polygon is a bit different than discussed previously. For example, in two-dimensional drawings many lines are singly, not multiply, connected to other line segments. This connectivity is inherently a part of the polygon structure; thus, the use of pointers actually in-

creases storage requirements.

In three-dimensional solids, data representing polygons using a series of coordinate pointers is preferred, since three or more polygons will almost always share the same point, reducing data storage requirements.

Curves and Splines

Curves are smooth paths that pass either through a series of points (traditionally called knot points) or near a set of points called control points. Various mathematical functions control the behavior of the curve, the most common being Bézier, beta, natural, uniform and cardinal.

The control or knot points are stored similar to the scheme used to store connected line segments or polygons. The applicable function is stored as a code that uniquely defines the method used to render the curve for the display or output device. Alternatively, the exact coefficients of the functional representation of the curve's path can be stored for each span of the curve. The span is defined as the curve between two successive control or knot points.

Text Annotation

Text characters in most CAD systems are usually represented as a series of strokes or line segments. This method allows the system to precisely scale, rotate, and skew text through procedures similar to those used to manipulate other graphics primitives. Most plotter hardware includes built-in patterns in ROM, and the

CAD program's plotter drivers can choose to issue text-plotting instructions to the plotter's firmware. However, text generated in the CAD software is usually preferred. Although the software approach is slower, a wide variety of text fonts and styles can be generated.

Text primitives consist of coordinate location, scale, orientation, font type, and justification codes as well as the actual strings of characters, usually stored in ASCII. The attribute data extracts the proper character vector or stroke data from font-definition tables stored separately, either in the hard-copy output device, the plotter driver, or in the drawing itself.

Symbols

Symbols are a collection of drawings, sometimes including other symbols, that behave as a single unit. They can be saved, inserted, and transformed as a single unit instead of individual pieces. Symbols are used extensively in almost all CAD systems for representing standard elements in drawings, much as boilerplate paragraphs might be used in many different documents created with a word processor. Symbols are also called blocks, objects, components, or parts.

Each time the same symbol is used in a drawing, a reference or instance object is stored that references or points to the original copy of the symbol and its components. When symbol instances contain lists of other symbol instances, they are said to be nested. Symbols that reference

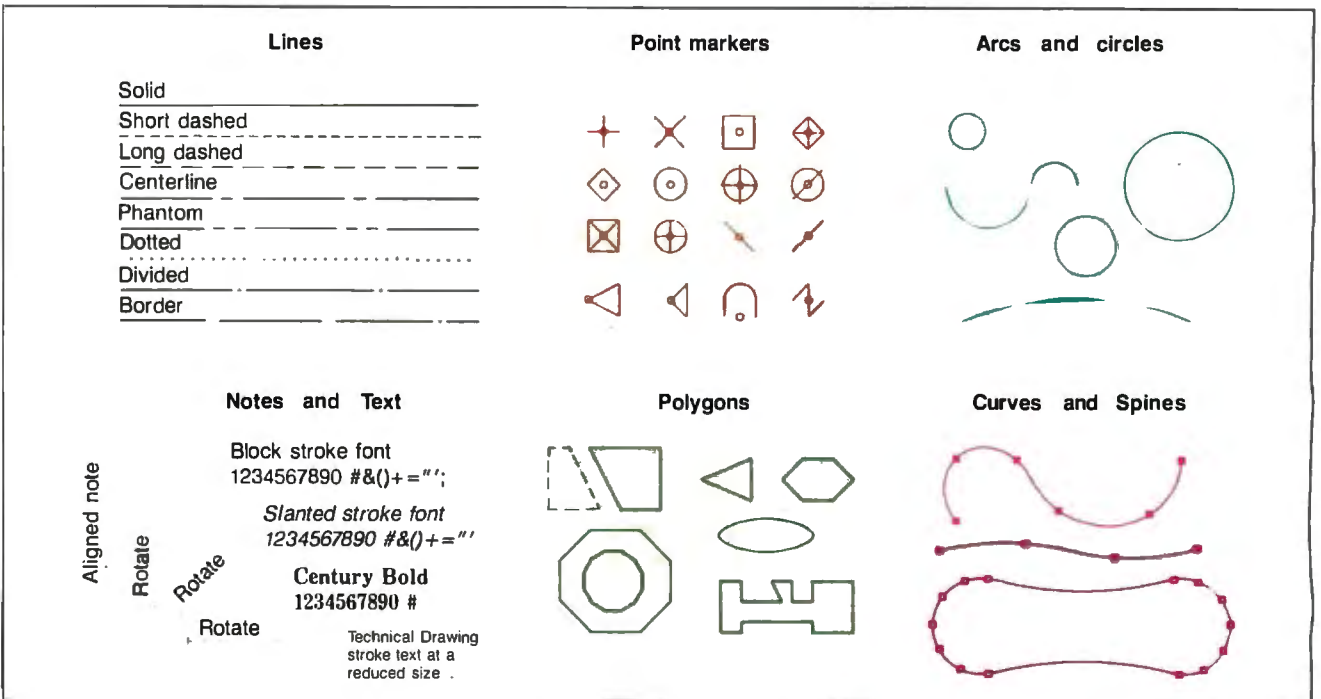

Figure 1: The typical graphics primitives used by standard CAD programs.

instances of themselves are not allowed.

The parts of a symbol are generally referenced to the local coordinate system of the symbol established when it was defined. An instance of a symbol is stored as an object data structure that carries the positional, scaling, mirroring, orientation, and skew geometry transform information to correctly position the symbol instance and transform its local coordinates to the global world coordinates of the drawing into which it is to be inserted.

Graphics-Primitive Attributes

Each of these graphics primitives is defined with geometric information. In addition, each primitive has data attributes to describe how it is drawn or visualized. Lines and curves will have a color, line-style, and width parameter to be used by the display and output devices to render the graphics on the device.

Since most traditional drawing pens are black on white, line styles and widths are the distinguishing graphics features. Short and long dashed lines, center lines, section and phantom lines are common and have precise meanings in a technical drawing. The various disciplines that use CAD have evolved conventions so that a given broken line pattern conveys precise information to the viewer.

These line styles and properties are related to the final drawing sheet sizes and technical-drawing conventions and do not always match nicely the metrics of an object's coordinate scales and sizes. For example, when a broken-line pattern is drawn, convention may require starting and ending on a solid line segment— $\frac{1}{4}$ -inch text may be standard on a D-size sheet, but on a B-size sheet it may be $\frac{3}{16}$ -inch. In most cases, the drawing annotation symbology does not relate directly to the drawing object dimensions. Instead, it is sized for final plot size and overall legibility. There are also accepted ISO and ANSI standards that specify many aspects of item size and style.

Display devices or graphics libraries rarely have the necessary built-in routines to handle these special styles.

An additional attribute or index that appears in two-dimensional drawing systems is a "layer" or "level" code. Layers are akin to the clear acetate overlays used in presentations. Symbols are used to correlate and organize information into logically connected regions in a single drawing plane; layering is used to register and correlate information that is spatially stacked in a two-dimensional drawing.

Viewing Transformations

Viewing transformations are used to transform the physical model of the data-

continued

**STOP SOFTWARE PIRACY
WITHOUT COPY PROTECTION**

Welcome to the world of Copi-Control with Smarti Arti, the first logical strategy in the battle against software copyright infringement. Smarti Arti doesn't prevent the legal creation of archival backups, just the illegal use of those backups.

Smarti ArtiTM
Intelligent Software Security

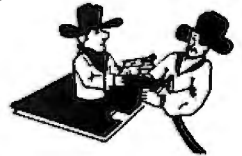

- * Completely invisible and inoffensive to licensed users.
- * Handles hard-disk crashes with ease. No install programs needed.
- * Uses artificial intelligence to detect and deter efforts to steal software.
- * Stops backups from executing unless they're legally authorized to do so.
- * Returns valuable marketing information about the user's computer system.
- * Uses NO key disks, hidden files or other annoying copy-protection games.
- * Allows exact duplicates of original program disks to be made with DOS commands.

**If you hate copy protection,
You'll love Smarti Arti!**

For IBM PCs

Secure hard-drive data with

For IBM PCs

The Secret GuardTM **\$79.95**

The Secret Guard secures sensitive data on your hard disk by making your computer temporarily "forget" that the hard drive exists! Great for software developers who store classified data on a hard disk. Parents can let their children learn how to use the computer without fear that they'll corrupt the hard drive. No special hardware needed. Keep prying eyes away from your sensitive data with the Secret Guard.

**Save Money
with the
Loan
Ranger**TM

METHOD	TYPR YEAR	PAYOFF	PMT PERIOD	INT PERIOD	EVALUATION	
U.S. RULES	360 DAY	FULL TERM	MONTHLY	MONTHLY		
Annual Interest Rate % :	18.00					
Number of Payments :	48					
Loan Amount :	15000.00					
Periodic Payments :	432					
Last Periodic Payment :						
Yield :						
	PRINT MENU	EDIT DATA	DATES	METHOD	PMT PERIOD	
	INT PERIOD	TYPR YEAR	PAYOFF	PROCESS DATA	RESTART	EXIT

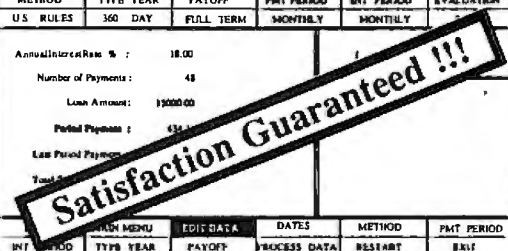

- ALLOWS two loans to be engineered simultaneously.
- ACCOMMODATES up to 500 irregular payments.
- TEACHES how to avoid banking loopholes and pitfalls.
- COMPUTES complex loans that use non-standard structures.
- INCLUDES a complete leasing program. Two programs for the price of one!
- AUTOMATICALLY evaluates loans from "excellent" to "terrible."
- OFFERS defaults and help at any time. Menu-driven. Complex, yet easy to use!

\$199.00

For IBM PCs

PRIDE SOFTWARE DEVELOPMENT CORPORATION

3575 NW 31st Ave., Oakland Park, FL 33309 / 1-800-635-6366 Dial Tone #360

Pride Software Development
Light Years Ahead

Fla. residents add 5% sales tax. All add \$3 handling. COD add \$2.

IBM is a trademark of International Business Machines Inc.

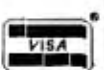

Inquiry 244 for End-Users.
Inquiry 245 for DEALERS ONLY.

Listing 1: The data-structure definitions for the graphics primitives typical in a standard CAD program.

```

typedef struct                /* world coordinate point          */
{
    float    x, y;
} wwcoord;

typedef struct                /* origin, scale, angleref wcoord system */
{
    wcoord   origin;        /* x and y origin coordinates          */
    float    xscale,        /* x scaling factor                    */
           yscale,        /* y scaling factor                    */
           angle,          /* positive x-axis rotation (radians) */
           skew;          /* skew factor for shear in x direction */
} osa;
typedef struct                /* rectangular box coordinates          */
{
    float    xmin, ymin, xmax, ymax;
} rbox;

typedef struct                /* entity attribute data structure      */
{
    char     layer;        /* entity layer index                  */
    char     pen;          /* entity pen type code                */
    union
    {
        char    mark_type; /* entity type code                    */
        char    line_type; /* entity type code                    */
        char    font_type; /* entity type code                    */
        char    poly_type; /* entity type code                    */
        char    obj_type;  /* entity type code                    */
    } type;
} entity_ads;

typedef struct                /* line entity data                    */
{
    entity_ads   attrib;
    wcoord       start; /* startpoint coordinate                */
    wcoord       end;   /* endpoint coordinate                  */
} line_entity;

typedef struct                /* ptmark entity data                  */
{
    entity_ads   attrib;
    osa          rcs;    /* marker positioning                   */
} ptmark_entity;

typedef struct                /* arc and circle entity data          */
{
    entity_ads   attrib;
    wcoord       center; /* center coordinate                    */
    float        radius; /* radius of arc or circle              */
    float        alpha;  /* start angle of arc                   */
    float        delta;  /* incremental angle to end             */
} arc_entity;

typedef struct                /* note entity data                    */
{
    entity_ads   attrib;
    osa          rcs;    /* note placement data                  */
    int          length; /* note string length                   */
    char         *text;  /* address of text string               */
} note_entity;

typedef struct                /* poly entity data                    */

```

continued

base into a view drawn on a two-dimensional plane whose extents are either a CRT or a plotter drawing sheet. Many systems can keep track of several portions of the drawing, sometimes called views. Each view has an associated transformation matrix that transforms the global coordinates into local screen coordinates.

Design and Modeling Transforms

Modeling transformations are associated with the referencing, positioning, mirroring, scaling, rotating, stretching, skewing, and copying of drawings. As discussed earlier, items organized and stored under an object data structure (symbols) are defined in their own reference system and then transformed or mapped into the global world coordinate system of the drawing into which they are placed. Items can also be transformed between different local coordinates to move an image from ownership by one symbol to ownership by another.

The modeling transforms are similar to the viewing transforms in two-dimensional systems. If the view transformations are done in two steps—transforming from local systems to the global world coordinates, then using the display graphics interfaces to transform from the global world system to the display device coordinates—then the first-stage transforms are the same as the modeling transforms. All the images mentioned earlier can be transformed nicely except arcs and circles. When stretching, nonisotropic scaling, and skewing transforms are used, arcs and circles turn into elliptical forms. Some systems add an ellipse primitive to handle this; others treat the transformed arc or circle data structure as a special object and use the object transform data to represent the ellipse or elliptical arc.

Graphics-Primitive Data

Since graphics-primitive information is stored in a specialized form of database, CAD systems are beginning to use many standard database techniques for access, update, modification, and change. However, in most instances the CAD database must satisfy the stringent requirements of a highly interactive and responsive user interface. The principal differences are dictated by hardware constraints of interactive display and plotting systems, and the complex mathematical and geometrical relationships among the primitives themselves.

Graphics primitives by definition contain coordinate positioning information. Coordinates of the underlying object data require precise real numbers—4 bytes for floating-point numbers and 8 bytes for double-precision numbers. Four-byte

continued

2400-bps modems designed around your needs. So one's always a perfect fit.



The new Courier 2400e,[™] the Courier 2400[™] and Microlink 2400.[™] More features. More reliability. More value.

USRobotics new Courier 2400e now offers MNP[™]—a sophisticated error- and flow-control protocol that ensures error-free data transfer—plus all these Courier 2400 quality features:

Extended "AT" command set • Help screens • Call-progress reporting • Printed operations summary on bottom panel • Automatic speed adjustment, for 2400/1200/300-bps • Auto dialing • Auto answering • Call-duration reporting.

We're introducing new pricing too. With the 2400e at the price of our Courier 2400, and the 2400 costing even less.



Bottom panel

Thousands of electronic bulletin board operators, along with Fortune 50 companies and individual PC users, all have chosen

the dependable Courier 2400, with less than 1% returned for service. And all USRobotics modems carry a full two-year parts and service warranty.

Call now and get your FREE brochure, and learn more about our stand-alone Courier modems and IBM-PC[®] plug-in Microlink 2400. Outstanding.

**Call 1-800-DIAL-USR
In Illinois (312) 982-5001**

Yes, please send me your free brochure "24 Questions and Answers on 2400-bps Modems."

Name _____

Title _____

Company _____

Address _____

City _____ State _____ Zip _____

Business Phone () _____

6/87-01-2400F

U-Robotics

The Intelligent Choice in Data Communications.
8100 McCormick Blvd., Skokie, Illinois 60076.

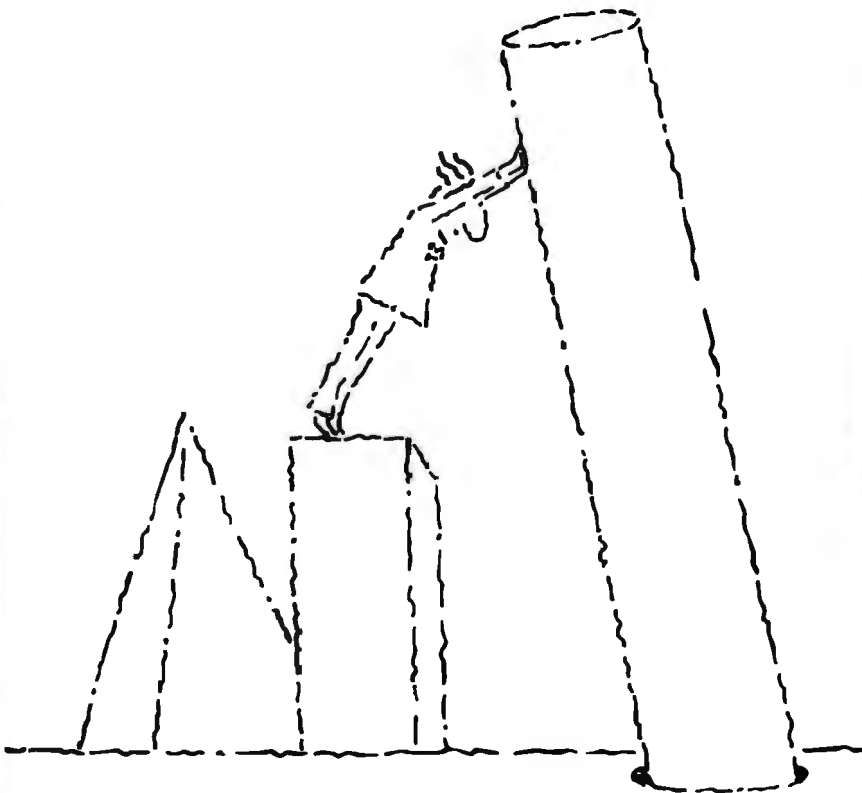

MNP is the Microcom, Inc. trademark for Microcom Networking Protocol, a public domain error-control protocol. IBM-PC is a trademark of International Business Machines, Incorporated.

Listing 1: *Continued.*

```

entity_ads      attrib;
ptmark_entity  *marker;      /* Vertex marker type */
unsigned        fill:1;     /* Is it filled in? */
unsigned        closed:1;   /* Is poly open or closed? */
unsigned        spline:1;   /* Is poly spline smoothed? */
unsigned        spline_type:4; /* Spline function type code */
int             n;          /* Vertex count */
wcoord         *pts;       /* array of vertex coords */
} poly_entity;

typedef struct /* object data */
{
    entity_ads      attrib;
    osa             ref;     /* object placement */
    struct _entity_node *entities; /* pointer to symb header */
    char            *name;   /* address of label string */
} obj_entity;

typedef struct _symb_entity /* symbol entity data */
{
    int             id;      /* symbol index */
    int             ref_cnt; /* symbol reference count */
    rbox            extent;  /* symbol extent (local) */
    struct _entity_node *entities; /* symbol entity list */
    char            *name;   /* address of symbol label */
} symb_entity;

typedef struct _entity_node /* entity node data struc */
{
    struct _entity_node *forward; /* next entity node pointer */
    struct _entity_node *backward; /* previous entity node ptr */
    int                 entity_type; /* entity type & vis flags */
    union
    {
        ptmark_dat *point_ptr; /* pointer to point data */
        line_dat   *line_ptr;  /* pointer to line data */
        arc_dat    *arc_ptr;   /* pointer to arc data */
        note_dat   *note_ptr;  /* pointer to note data */
        poly_dat   *poly_ptr;  /* pointer to poly data */
        obj_dat    *obj_ptr;   /* pointer to obj data */
        symb_dat   *symb_ptr;  /* pointer to symb data */
    } ptype;
} entity_node;

typedef struct_dbh /* Main drawing database header */
{
    struct_dbh *next; /* pointer to next database */
    entity_node *vis; /* list of visible drawing entities */
    entity_node *masked; /* list of blanked drawing entities */
    entity_node *group; /* list of workset drawing entities */
    entity_node *symbols; /* list of symbol header entities */
    char *name; /* drawing database name */
    char *status; /* active - inactive status flag */
} drawing_dbh;

```

floating-point coordinates carry 6- to 7-digit precision, and doubles carry 15- to 16- digit precision. Calculations are extensive and need to be carefully done to avoid cumulative and round-off computational errors, especially in mapping and surveying, numerical control, and other applications concerned with precision.

Integer- or whole-number-based geometry has negative connotations for most engineers and technical designers. In all but a few cases, CAD systems based on integer-coordinate data structures are

considered questionable, if not unacceptable. In general, real-number accuracy and precision is desired in all applications, even though it is not always necessary for schematics, process flow, charting, and many architectural drawings.

Yet most graphics-display and plotter-output devices need integer-based coordinates. In particular, bit-map systems are integer-based. Within the range of display-screen resolutions currently used and even with large plotters, the range of 2-byte integer coordinates (-32768 to

32767) is certainly sufficient to match the resolution of these devices. In fact, additional resolution is questionable in all but specialized output devices.

CAD image coordinates must be converted to integer device coordinates before they can be displayed or plotted. For the programmer, this becomes a constant juggling act in trading off speed for accuracy and choosing between letting the application do the work or offloading it to the device-display routines. Coordinate transforms are computationally intensive and usually are done best in real numbers, as are clipping and extent checking. Simply converting image coordinates to integers and passing them to the device-display routine is usually inadequate.

Drawing Data Structure

Defining the drawing image data and putting it together in a typical CAD drawing-system database is illustrated in listing 1 and figure 2. The data structures shown are for a typical two-dimensional drafting system with 4-byte floating-point accuracy. To change to double precision, simply replace all the floats by double in the data structures in listing 1.

This drawing database is organized into three mutually exclusive, circularly linked lists of images. The visible list represents the major category of items. The workset list is a temporary working set of images that can be selected and identified for selective editing, copying, transforming, moving, and saving as standard symbol definitions. The masked list is another list for blanking or temporarily ignoring entities in the drawing database. It is used for decluttering, performance speedups, and so on.

All the display, image-selection and picking, editing, plotting, and checking routines operate from these list structures. Images are added, deleted, modified, copied, and transformed using special database-access routines. This data structure is basically the heart of the drawing system. The other algorithms and data structures connect the user interface, the file I/O, the calculator, the text-editing facilities, the unit-conversion and display formatting, the command-string parsing, the screen cursor and menu displays, the pointer input control, and the many geometry creation, calculation, and transform algorithms to form an interactive CAD system.

User-Interface Data Structures

Graphics displays used in CAD systems have evolved from vector-generated displays to bit-map displays. The latter have had a major impact on both the ability to visualize three-dimensional surfaces and

continued

Figure 2: The organization of drawing primitives in a CAD database.

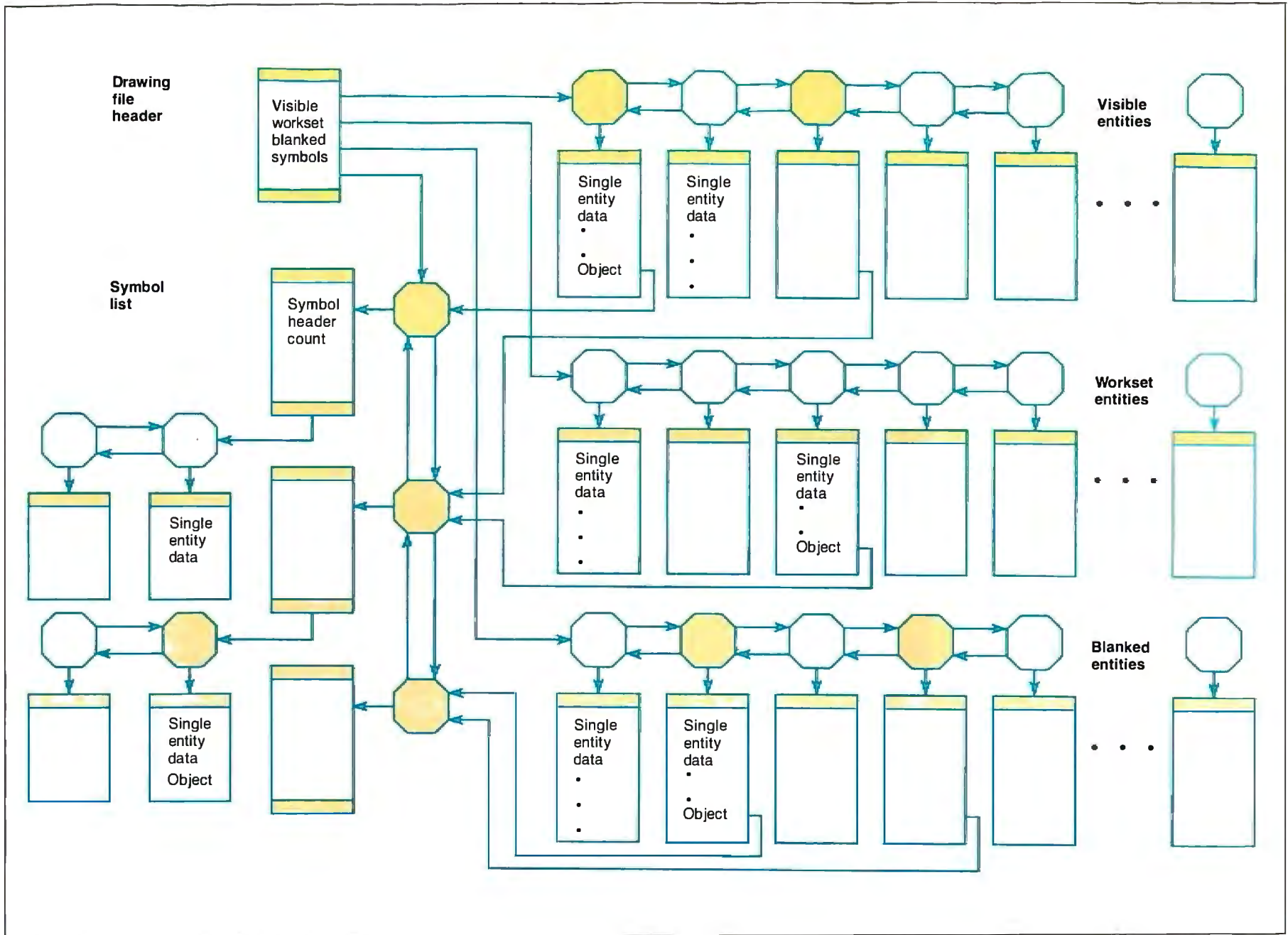

the way user interfaces are designed.

CAD software designed for these environments makes use of two types of graphics. Both share the display bit map. On one hand, the graphics of the visual icons, pop-up menus, and movable sprites or screen cursors is integer-based and bit-map-oriented. The image data structures and bit-blit (bit block transfer—pixel-by-pixel manipulations best performed by hardware for speed) operations that move them are the building blocks of the user interface graphics “software” control knobs. They are best

done in relative screen or pixel coordinates (changing from a 640-by-200 black-and-white resolution device to an 800-by-600 16-color device including text fonts, icons, and so on requires some significant changes in bit-map data and relative screen layout that current devices and device-independent software don't handle well).

On the other hand, the displayed view of the drawing or model database images arrives at the screen pixel bit map only after completing numerous geometric and visualization transforms, again re-

quiring many real-number computations. Serious complications arise when the user-interface graphics and the CAD applications graphics share the use of a common bit map. When windows that overlap are stacked and removed in last-open/first-closed priority and only the last (topmost) of the overlapping windows remains active, then matters are greatly simplified, assuming that bit-map memory holds out and bit-map bit-blit move operations are fast.

All these “sharing activities” can lead to nontrivial windowing-systems complexities. In future display systems, one would hope multiple applications could be fully graphically active in output and partially active in menuing control input if menus are visible, without worrying about partial redraws of a window because of an intervening application window. If much of the windowing activity is moved over to the video control side and the bit-map displays and applications can own their own bit maps as necessary, many of these problems will be solved.

Summary

The drawing primitives required for two-dimensional drafting graphics are becoming well-defined. Personal computer-based sketching and drafting systems are capable of replacing much of the traditional engineering sketching and preliminary drawing done by the designer and engineer. Current personal computer graphics-display technology is adequate for many of the tasks that required high-end workstations a few years ago. Increasing hardware horsepower and declining prices should lead to far more sophisticated CAD tools capable of providing the more complex engineering design, analysis, and three-dimensional-modeling techniques now available only on much larger systems. ■

BIBLIOGRAPHY

- Pavlidis, Theo. *Algorithms for Graphics and Image Processing*, Rockville, MD: Computer Science Press, 1982.
- Foley, J. D., and Andries Van Dam. *Fundamentals of Interactive Computer Graphics*, Reading, MA: Addison-Wesley, 1982.
- Assorted Course Notes, ACM Siggraph 86, 13th Annual Conference on Computer Graphics and Interactive Techniques.

ACKNOWLEDGMENTS

Special thanks to David Hull, Dave Staudacher, Lorenz Huelsbergen, Louie Pfortmiller, and Paul Van Vleck for their support and comments in preparing the paper, and to Glen Hart for his assistance in organizing and editing the manuscript.



THE MURAL PLOTTER D SIZE PLUS. FLATBED TECHNOLOGY.

\$2495.

We're not going to razzle-dazzle you with a lot of hype about the Mural Plotter. We'll let the facts speak for themselves.

- Plot area 25" x 34"
- Compatible with leading software programs
- Emulates Hewlett-Packard 7475 Plotter
- Compatible with IBM/PC/X/T/AT, T.I., NEC, AT&T and more using RS-232-C serial interface
- Desk top or wall mount
- Excellent repeatability • 5 ips

Call for the name of your local CAD Dealer!

UI United Innovations • Crossroads Ind. Park • Holyoke MA 01040 • 413-534-4400



Casio challenges you to find more power. At any price.

The amazing Casio FX-4000P programmable scientific calculator. In power, it's comparable to the most highly touted calculators on the market today.

It offers you 160 total functions, including 83 scientific functions, such as hexadecimal/decimal/binary/octal conversions, standard deviation and regression analysis.

Making it easier to deal with long computations, its 12 character

CASIO	FX-4000P
Functions	160
Display	12 Scrolls to 79
Memory	550 Step
Formula Replay	up to 79 chr.
Computer Math	Hex-Bin-Octal
Regression Analysis	2 Variable

alpha-numeric display scrolls to 79 characters and its instant formula replay feature lets you review, edit and replay your formula at the touch of a button. It even has an answer key that stores your last computed value.

And to make things still easier, the FX-4000P has a "perfect entry" system, which allows you to enter and display a formula exactly as written.

Plus, it has a non-volatile 550 step program memory with 10 program

divisions. This allows 10 different programs to be stored at once.

And it includes up to 94 data memories, which are invaluable for statistical analysis.

Finding all this power at your fingertips is remarkable enough, let alone at half the price of some competitors. If you can put your finger on a scientific calculator that gives you more power at any price, by all means buy it.

CASIO
Where miracles never cease

The Magic.



The Facts.

The fact is, companies that use POSTSCRIPT® laser printers are creating some very exciting communications. Quite often, the word magic pops up.

Yet behind this exciting development in business communication, you'll find some hard facts worth serious consideration.

Fact. POSTSCRIPT is the page description language chosen by some of the best names in desktop publishing.

Fact. POSTSCRIPT gives you the option of printing from an IBM PC, Macintosh, or mini/mainframe.

Fact. You won't be tied to a single vendor so you can buy the printer that's best for your company's needs.

Fact. Since POSTSCRIPT is device independent, you can design a document, then professionally print it later at a higher resolution.

Fact. You can choose from hundreds of software programs that support POSTSCRIPT.

Fact. POSTSCRIPT lets you combine text, line art, and even digitized photographs on the same page.

Fact. If you don't ask for a printer equipped with POSTSCRIPT, you won't get the magic behind desktop publishing.

Now that you have the facts, just think what your company can do with the magic. For more facts, give us a call at 415-852-0271.



POSTSCRIPT from Adobe.
The magic behind desktop publishing.

The pages above were printed on a POSTSCRIPT equipped printer.
*POSTSCRIPT printers include Agfa-Gevaert P400PS, Apollo Domain/Laser 26, Apple LaserWriter/LaserWriter Plus, Dataproducts LZR-2665, Diconix Diji1 V/PS, Digital Equipment Corp. PrintServer 40/Script Printer, IT T Curve ScriptEN, Laser Connection PS Jet, Linotype Linotronic 100/Linotronic 300, NBI Model 908, NEC SilentWriter LC-890, OMS-PS 800/800 Plus, OMS-PS 2400, OMS-PS 2700 CK, Sun Microsystems LaserWriter, Texas Instruments OmniLaser 210B/OmniLaser 2115. POSTSCRIPT is a registered trademark of Adobe Systems Incorporated. Other brand names are trademarks or registered trademarks of their respective holders.

The CADcompiler

A logic design tool with a twist

Arthur W. Crooke

THE CADCOMPILER IS A logic design tool with a different twist on the usual method of creating digital circuits. Instead of using a schematic drawing approach, the CADcompiler uses a database management system to enter and manipulate parts lists and connectivity information to automate the design of circuits. With this information, the CADcompiler then uses character-mode graphics, instead of pixel graphics, to generate a schematic for presenting the design in an easily readable format.

Version 1.2 of the CADcompiler is available in binary format for the IBM PC, along with a documentation file and a sample design. [Editor's note: *Version 1.2 object code for the IBM PC and compatibles only and accessory files are available on disk, in print, and on BIX; see the insert card prior to page 321. The object code is also available on BYTEnet; see page 4.*]

Inception

The CADcompiler was developed by a group of digital-system design engineers for use on a personal computer. It includes features essential to the complete development of digital board-level products. It has been tested and modified over several years to improve speed and functionality, simplify operation, and improve error checking. At the outset of its development, a number of system requirements were specified:

- It should improve the designer's efficiency by automating as many time-consuming elements of the product develop-

ment cycle as economically possible.

- It should make the designer self-sufficient by minimizing the need for support services.
- Where external services are required, it should provide clean, accurate, machine-readable interfaces (e.g., for printed circuit layout, wire-wrap, simulation, and so on).
- It should simplify generating a clear description of the product, both before the start of the design and on completion of the project.
- It should run on a low-cost system (an IBM PC or compatible with a dot-matrix printer, monochrome display, 256K bytes of memory, and no other options).

The Drafting Approach to Logic Design

These five objectives were considered with respect to the following tasks traditionally necessary to bring a digital product from concept to production:

- Develop the concept: Make a sketch or block diagram to illustrate the product.
- Make a mechanical drawing of the details for construction (a picture of the components and interconnecting wires).
- Make timing and state diagrams, and flow charts to check the design.
- Build the product from the drawings.
- Check out the product using the drawings and specifications.
- Make changes to correct for deficiencies found in the application of the product, or to expand the design.
- Provide user and maintenance documentation.

Modern CAD systems rely heavily on automated drafting (since they tend to emulate the manual processes fairly closely) and therefore require more capable computers than other personal computer applications such as word processing or spreadsheets.

This emulation approach to logic design is considerably more difficult than just drafting (task b), since the parts list and connectivity information must be extracted for use in construction (task d) if that too is to be automated. This same information is also needed for simulation (task c) and automated testing (task e).

Engineering change control (task f), one of the most important features of design automation, is often overlooked or compromised, especially in low-cost systems. Though the description of the product for both concept development (task a) and maintenance (task g) is often not considered part of the automation process, systems with good hierarchical design features can support these tasks as well.

A Database Management Approach to CAD

Digital products differ from most others (mechanical or architectural) in one important respect regarding CAD: The drawing is not an essential part of the design's description and, in fact, does not

continued

Arthur W. Crooke (34 Drum Hill Rd., Concord, MA 01742) is an independent design consultant who specializes in digital systems, instrumentation, and signal processing hardware design.

form a complete description for automatic-manufacturing purposes. The actual design is completely specified by a parts (device) list and a netlist (a list of networks of connected device pins).

Component placement and board assembly are mechanical functions of the specific implementation (wire-wrap or printed circuit board) and do not directly

affect the design. In fact, breadboards are often built in one technology and production units in another. The design should not change in the transition.

The essential functions of a digital CAD system, therefore, are entry (design capture), checking and maintenance of the netlist and parts list, and preparation of appropriately formatted output for

manufacturing. The conventional approach of "drawing a picture of all the wires" is time-consuming, produces documents that are hard to read, and leads to errors that are hard to detect. Large graphics-based systems generally provide an alternative based on a structured hierarchy of block diagrams that, at

continued

ADDR00 U01-19 U03-2	ADDR06 U01-13 U04-3 U05-5	ADDR11 U02-16 U04-19 U05-21	DATA03 U01-4 U04-13 U05-15	DATA11 U02-4 U06-13 U07-15	GND U01-9 U02-9 U08-46	WR* U04-21 U06-21 U08-63
ADDR01 U01-18 U04-8 U05-10	U06-3 U07-5 U10-5 U11-5	U06-19 U07-21 U10-21 U11-21	DATA04 U01-5 U04-14 U05-16	DATA12 U02-5 U06-14 U07-16	LCS* U03-3 U08-33	XTAL01 U08-59 U09-1
U06-8 U07-10 U10-10 U11-10	ADDR07 U01-12 U04-2 U05-4	ADDR12 U02-15 U03-8 U05-23	U08-8	U08-7	PLC U08-49 U08-55	XTAL02 U09-2
ADDR02 U01-17 U04-7 U05-9	U06-2 U07-4 U10-4 U11-4	U07-23 U10-23 U11-23	DATA05 U01-6 U03-8 U05-23	DATA13 U02-6 U06-15 U07-17	U07-23 U10-23 U11-23	ZGND U01-10 U02-10 U03-10
U06-7 U07-9 U10-9 U11-9	ADDR08 U02-19 U04-1 U05-3	ADDR13 U02-14 U05-2 U07-2	U07-23 U10-23 U11-23	U08-5	DATA14 U02-7 U04-16 U05-18	U04-12 U05-14 U06-12 U07-14 U08-26 U08-60 U10-14 U11-14
ADDR03 U01-16 U04-6 U05-8	U06-1 U07-3 U10-3 U11-3	U11-2 U10-2 U11-2	U04-16 U05-18 U08-4	DATA15 U01-17 U07-19 U08-1	REC* U03-7 U08-40	ZVCC U01-20 U02-20 U03-20 U04-24 U05-28 U06-24 U07-28 U08-9 U08-43
U06-7 U07-8 U10-8 U11-8	ADDR09 U02-18 U04-23 U05-25	ALE U01-11 U02-11 U08-61	DATA06 U01-14 U04-16 U05-18	DATA16 U04-16 U05-18 U08-3	RD* U04-20 U05-22 U06-20	INTI00 U08-45
ADDR04 U01-15 U04-5 U05-7	U06-23 U07-25 U10-25 U11-25	BHE* U02-8 U08-64	U08-2	DATA17 U03-6 U08-39	U07-22 U08-62 U10-22 U11-22	INTI01 U08-44
U06-5 U07-7 U10-7 U11-7	ADDR10 U02-17 U04-22 U05-24	DATA07 U01-8 U04-17 U05-19	DATA08 U02-1 U06-9 U07-11	DATA18 U01-17 U07-19 U08-1	RMHBS* U03-17 U06-18	DATA20 U10-16
ADDR05 U01-14 U04-4 U05-6	U06-23 U07-25 U10-25 U11-25	BHE* U02-8 U08-64	U08-2	DATA19 U03-7 U08-40	RMLBS* U03-19 U04-18	DATA21 U10-17
U06-4 U07-6 U10-6 U11-6	ADDR11 U02-17 U04-22 U05-24	DATA00 U01-1 U04-9 U05-11	DATA09 U02-2 U06-10 U07-12	DATA20 U03-6 U08-39	UCS* U03-4 U08-34	DATA22 U10-18
	ADDR12 U06-22 U07-24 U10-24	DATA01 U01-2 U04-10 U05-12	DATA10 U02-3 U06-11 U07-13	DATA21 U03-12 U10-20	VCC U05-1 U05-27 U07-1 U07-27 U10-1 U10-27 U11-1 U11-27	DATA23 U10-19
	U11-24	U08-15	U08-15	DATA22 U03-16 U07-20	EPHBS* U03-16 U07-20	DATA24 U11-11
		DATA02 U01-3 U04-11 U05-13	U08-15	DATA23 U03-12 U10-20	EPHBS* U03-18 U05-20	DATA25 U11-12
		U08-13		DATA24 U03-12 U10-20		DATA26 U11-13
				DATA25 U03-12 U10-20		DATA27 U11-15

Figure 1: A CADcompiler netlist containing signal names shows the device pins that are to be wired together for a given design.

AD16 U08-68	DATA28 U11-16
AD17 U08-67	DATA29 U11-17
AD18 U08-66	DATA30 U11-18
AD19 U08-65	DATA31 U11-19
ADDR14 U02-13	DELBHE* U03-5
CLKOUT* U08-56	DEN U03-15
DATA16 U10-11	INTA00* U08-42
DATA17 U10-12	INTA01* U08-41
DATA18 U10-13	INTI00 U08-45
DATA19 U10-15	INTI01 U08-44
DATA20 U10-16	MBHE* U02-12
DATA21 U10-17	REC U03-14
DATA22 U10-18	RES* U08-24
DATA23 U10-19	RESET U08-57
DATA24 U11-11	TMRI00 U08-20
DATA25 U11-12	TMRI01 U08-21
DATA26 U11-13	TMRO00 U08-22
DATA27 U11-15	TMRO00 U08-23

Figure 2: A list of single pins and the other pins to which they are connected.

MICROWAY ACCELERATES YOUR PC!

FastCACHE-286™

Runs your PC Faster than an AT!
Runs the 80286 at 9 or 12 MHz and the 80287 at 8, 9 or 12 MHz. Includes 8 kbytes of 55ns CACHE.

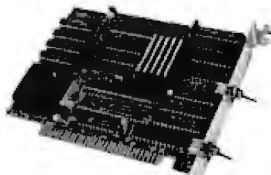

Compatible with Leading Edge Model D, Compaq, and Turbo motherboards. Includes 8088 Reboot Switch, DCache, Print Spooler and Diagnostics... From \$399

LOTUS/INTEL EMS SPECIFICATION BOARDS

MegaPage™ The only EMS board which comes populated with two megabytes of cool-running, low power drain CMOS RAM installed. Includes RAM disk, print spooler, disk cache and EMS drivers. For the IBM PC, XT and compatibles...\$549

MegaPage with 0K..... \$149

MegaPage with 2 megabytes of HMOS RAM..... \$419

MegaPage AT/ECC™ EMS card for the PC AT and compatibles includes Error Correction Circuitry. With ECC, 11 RAM chips cover 256K so the user never encounters RAM errors. With 1 megabyte CMOS RAM..... \$699

INTEL, JRAM, or Maynard..... CALL

INTEL INBOARD 386 0K..... \$1325

NUMBER SMASHER/ECM™

Triples the speed of CAE and all applications!

From \$599

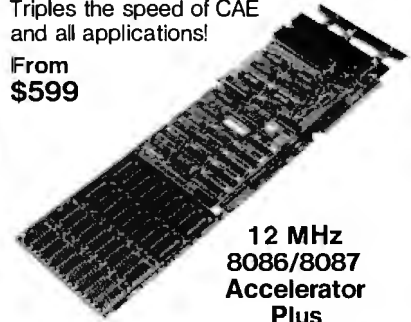

12 MHz
8086/8087
Accelerator
Plus

A Megabyte for DOS!

For the IBM PC, XT and compatibles
PC Magazine "Editor's Choice"

8087 SOFTWARE

IBM BASIC COMPILER..... \$465
MICROSOFT QUICK BASIC..... \$79
87 BASIC COMPILER PATCH..... \$150
87 BASIC/INLINE..... \$200
IBM MACRO ASSEMBLER..... \$155
MS MACRO ASSEMBLER..... \$99
87 MACRO/DEBUG..... \$199
MICROSOFT FORTRAN V4..... \$299
RM FORTRAN..... \$399
LAHEY FORTRAN F77L..... \$477
MS or LATTICE C..... CALL
STSC APL★PLUS/PC..... \$450
STSC STATGRAPHICS..... \$675
SPSS/PC+..... \$695
87SFL Scientific Functions..... \$250
87FFT..... \$200
OBJ → ASM..... \$200
PHOENIX PRODUCTS..... CALL

287 Turbo™ -10/12

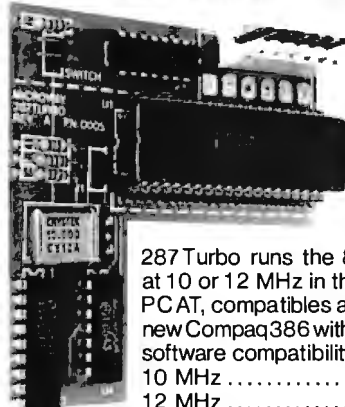

287 Turbo runs the 80287 at 10 or 12 MHz in the IBM PC AT, compatibles and the new Compaq 386 with 100% software compatibility.
10 MHz..... \$450
12 MHz..... \$550

PC Magazine "Editor's Choice"

8087 UPGRADES

All MicroWay 8087s include a one year warranty, complete MicroWay Test Program and installation instructions.

8087 5 MHz..... \$105

For the IBM PC, XT and compatibles

8087-2 8 MHz..... \$154

For Wang, AT&T, DeskPro, NEC, Leading Edge

80287-3 5 MHz..... \$179

For the IBM PC AT and 286 compatibles

80287-6 6 MHz..... \$229

For 8 MHz AT and compatibles

80287-8 8 MHz..... \$259

For the 8 MHz 80286 accelerator cards and Compaq 386

80287-10 10 MHz..... \$395

PC-PAL™ Programmer..... \$395

Call for great prices on V20, V30, 64K, 128K and 256K RAM

AT8™

Turns your AT into a high speed, multi-user Xenix business system!

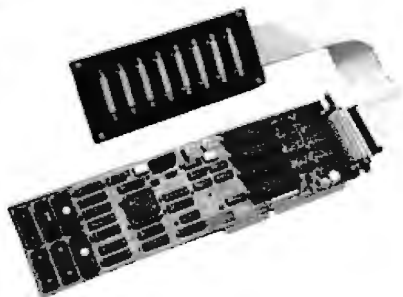

8 port, intelligent serial controller with 3% response degradation. Includes 8 MHz 80186 with built in DMA..... \$1299

MICROWAY SOFTWARE FOR LOTUS 1-2-3™

FASTBREAK™ employs the 8087 to increase the speed of Lotus 1-2-3™ Version 1A or 1A*. Users are reporting speed ups of between 3 and 36 to 1. When run with our NUMBER SMASHER accelerator card, recalculation speed ups of 10 to 30 are being reported..... \$79

PowerDialer® Add-In for Lotus 1-2-3 Release 2. Automated telephone dialing from within 1-2-3. Adds least cost routing, automatic carrier selection and automated phone book worksheet. Builds customized dialing applications. Can be used with DesqView..... \$79

HOTLINK™ adds easy linking of spreadsheets to Lotus 1-2-3 Version 1A... \$99

287 TURBO-PLUS™

Speeds up your AT

Adjustable 80286 Clock 6-12 MHz

10 MHz 80287 Clock

Plus Full Hardware Reset..... \$149

Optional 80286-10..... \$175

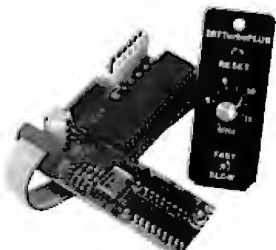

287 TURBO-PLUS
With 80287 10 MHz..... \$549
With 80287 12 MHz..... \$629

CALL (617) 746-7341 FOR OUR COMPLETE CATALOG

MicroWay P.O. Box 79
Kingston, Mass.
02364 USA
(617) 746-7341

You Can
Talk To Us!

MicroWay Europe
32 High Street
Kingston-Upon-Thames
Surrey England KT1 1HL
Telephone: 01-541-5466

Subscription Problems?



We want to help!

If you have a problem with your *BYTE* subscription, write us with the details. We'll do our best to set it right. But we *must* have the name, address, and zip of the subscription (new and old address, if it's a change of address). If the problem involves a payment, be sure to include copies of the credit card statement, or front and back of cancelled checks. Include a "business hours" phone number if possible.

BYTE
Subscriber Service
P.O. Box 6821
Piscataway, NJ 08854

the lowest level, reduce to logic diagrams or even component schematics.

As an alternative, I have implemented a specialized logic-design DBMS. Data is input via "entry forms" (that look like logic diagrams) with a convenient editor that has special functions for entry of register-level (data bus) functions and copying devices. The database format is tailored for efficient storage of design and component library data, as well as for fast access. Many "report" formats are provided—several that look like schematics, plus a number of netlist formats required by different construction services, as well as several for use by the designer for design checking.

Signal Names

The database maintains a list of pin-designator (DEV-PIN)/net-designator (SIGNAL) pairs (the netlist) and a list of device-designator/device-type pairs (parts list). A net is a set of device pins to be wired together to form a network. For the database system to work, these nets must be assigned a name (*net name* or *signal name*) by the designer. Although this seems a tedious use of the imagination compared to drawing a line between two points on a diagram, there are many advantages to using signal names.

With the availability of high-speed field-programmable logic devices, using

continued

Copyright © 1983, 1984, 1985, 1986, 1987 Product Development Systems

This copy for personal use only by readers of

BYTE MAGAZINE

by special arrangement with P.D.S.

Copying of this disk for commercial use is prohibited

(L)ibrary Maker (D)esign Maker (N)etlist (C)hange List

(P)arts List (A)rrange Design (S)chematic

(E)xtract and Merge <esc> Return to Operating System

Command?

Figure 3: The CADcompiler main menu.

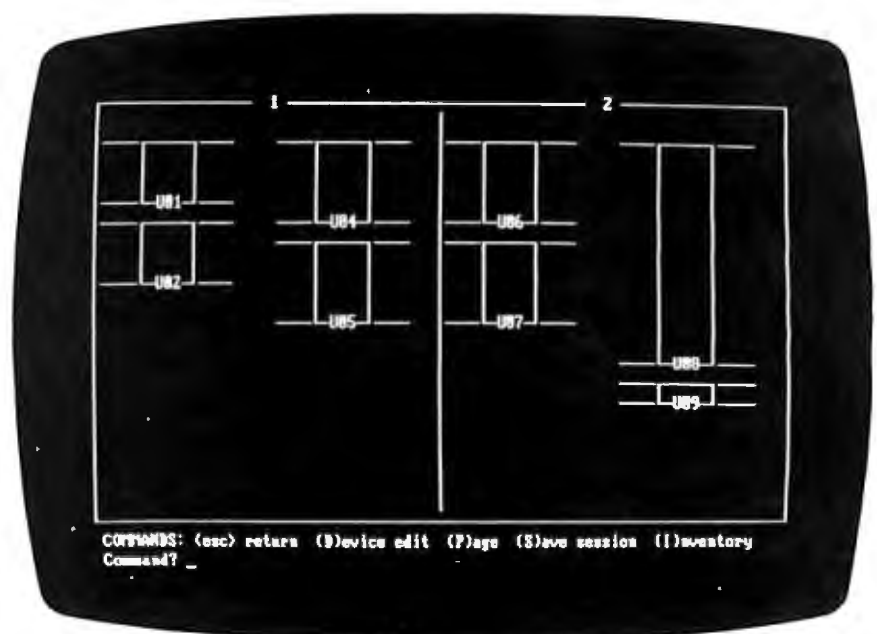
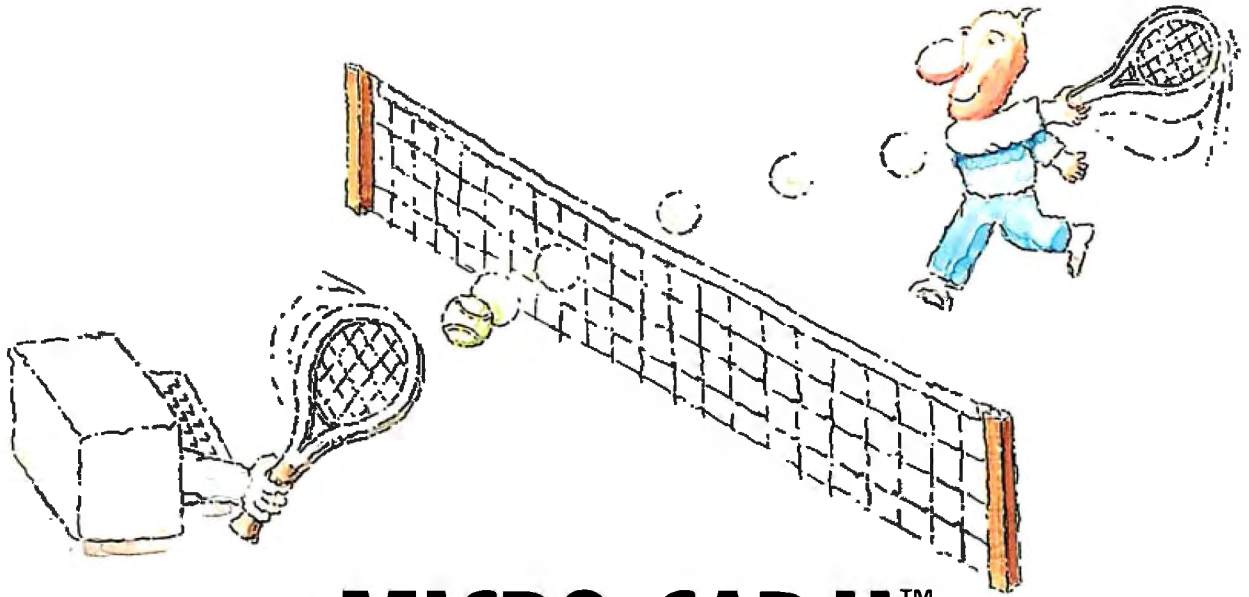

Figure 4: A CADcompiler completed entry form, showing the currently assigned signal names on the corresponding pins.



MICRO-CAP II.™

The CAE tool with fully interactive analog simulation for your PC.

Spectrum Software's MICRO-CAP II® is fast, powerful, and feature rich. This fully interactive, advanced electronic circuit analysis program helps engineers speed through analog problems right at their own PCs.

MICRO-CAP II, which is based on our original MICRO-CAP software, is a field-proven, second-generation program. But it's dramatically improved.

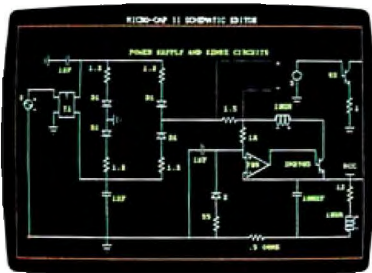

Schematic Editor

MICRO-CAP II has faster analysis routines. Better resolution and color. Larger libraries. All add up to a powerful, cost-effective CAE tool for your PC.

The program has a sophisticated integrated schematic editor with a pan capability. Just sketch and analyze. You can step

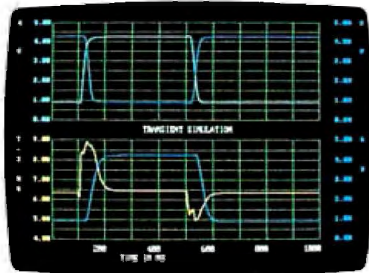

Transient Analysis

component values, and run worst-case scenarios—all interactively. And a 500-type* library of standard parts is at your fingertips for added flexibility.

MICRO-CAP II is available for IBM® PCs and Macintosh.™ The IBM version is CGA, EGA, and Hercules® compatible and costs only \$895 complete. An evaluation version is available for \$100. Call or write today for our free brochure and demo disk. We'd like to tell you more about analog solutions in the fast lane.

- Integrated schematic editor
- Fast analysis routines
- High-resolution graphic output
- Standard parts library of 500* types

*IBM versions only.

- Transient, AC, DC, and FFT routines
- Op-amp and switch models
- Spec-sheet-to model converter*
- Printer and plotter* hard copy



AC Analysis



1021 S. Wolfe Road, Dept. E
Sunnyvale, CA 94087
(408) 738-4387

MICRO-CAP II is a registered trademark of Spectrum Software.

Macintosh is a trademark of McIntosh Laboratory, Inc. and is being used with express permission of its owner.

Hercules is a registered trademark of Hercules Computer Technology

IBM is a registered trademark of International Business Machines, Inc.

An important aspect of a personal computer CAD system is the ease with which the integrity of the design can be maintained.

small-scale integrated devices is no longer cost-effective. Modern designs tend to combine register-level MSI components, memories, and VLSI components interconnected with programmable array logic devices. The program for the PALs can most easily be described by Boolean equations converted to the format required by the device programmer using one of several assemblers, such as PALASM from Monolithic Memories or CUPL from P-CAD Systems. These equations are most useful when the inputs and outputs are given meaningful names, in which case interconnecting lines are generally unnecessary and may only add confusion.

A signal name can be useful in both design and checkout of the product if chosen to be suitably mnemonic of the function of the signal that appears on the designated net. Signal tracing is simplified when an alphabetically sorted, well-formatted signal list (netlist) is available, especially when related groups of signals are given names that are close in alphabetic order.

Use of a fixed number of digits for data bus bit numbers is important to maintain the sequence when sorted alphabetically. Figure 1 illustrates such a signal list. It is relatively easy to identify signals that may be overloaded by looking for those connected to a large number of pins. The single-pin list, illustrated in figure 2, flags potential errors, since a pin to which a name is assigned is usually meant to be connected to another pin.

Even with drafting-oriented systems, a name is required for every net, and one will be assigned automatically (not mnemonically) by the system if not done by the designer. Transferring data from one system to another can produce connectivity errors if the receiving system allows fewer characters in the signal name than were created by the algorithm of the sending system. In such cases, it is often necessary to assign a name to every net, reducing the advantage of drawing pictures of the wires. It is also often necessary to check the netlist at various points, an especially difficult process if the names are

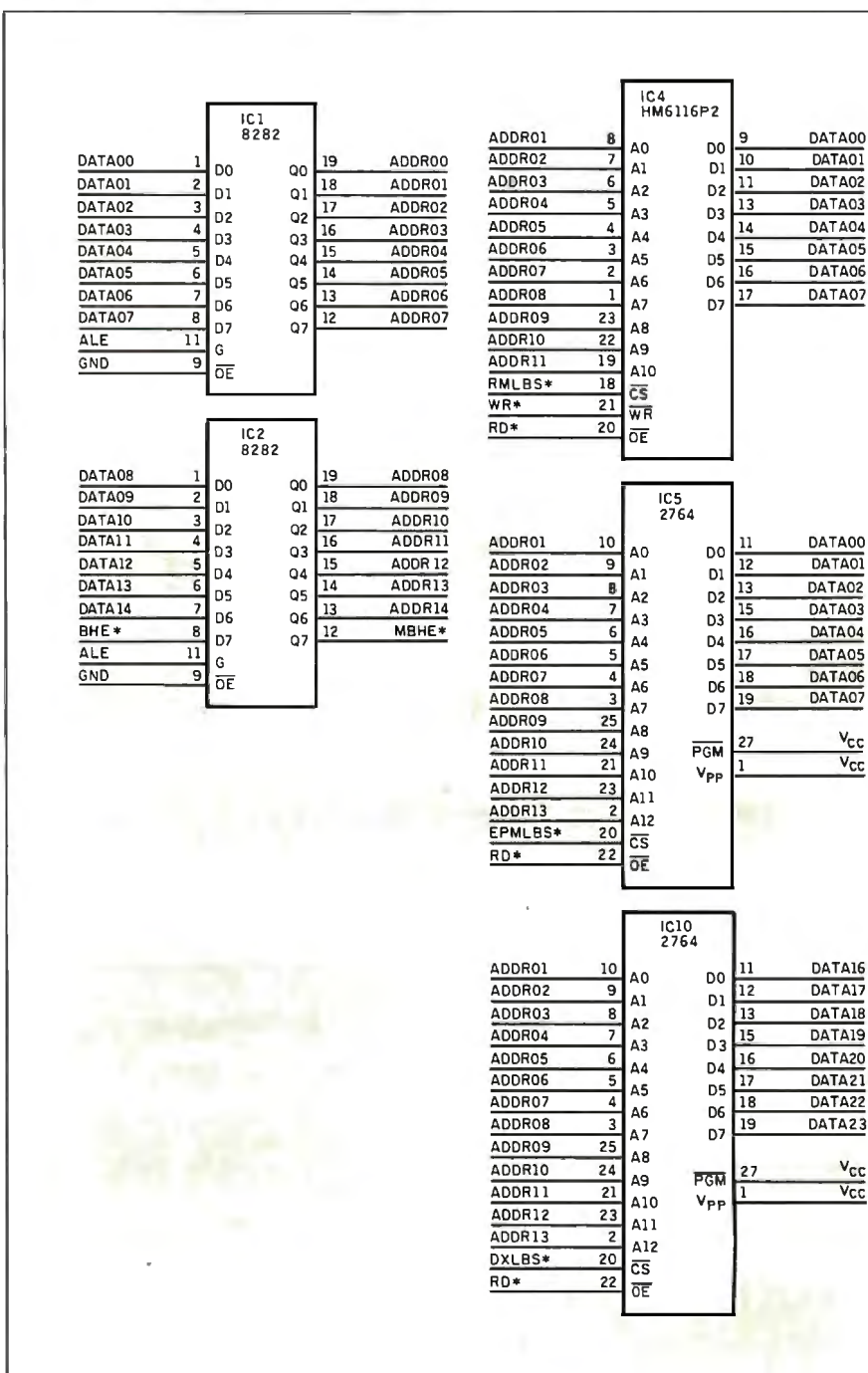

Figure 5: A CAD compiler schematic with each device shown separately, along with the signal names listed next to their corresponding pins.

not meaningful and the list is not well-formatted.

Database Structure

An important aspect of a personal computer CAD system is the ease with which the integrity of the design can be maintained. The data for a design should not expand to the point where a full-time system manager is required to perform regular backup and other routine functions. The complete description of a reason-

able-size design should fit on a single 360K-byte floppy disk, including such peripheral items as component data and technical manuals. The design program and other supporting information should also be contained on a single disk and be able to operate on reasonable-size designs in a minimum system.

Storage economy results from the use of an efficient relational database manager program that permits separation of design and component data into individ-

CAD COMPILER

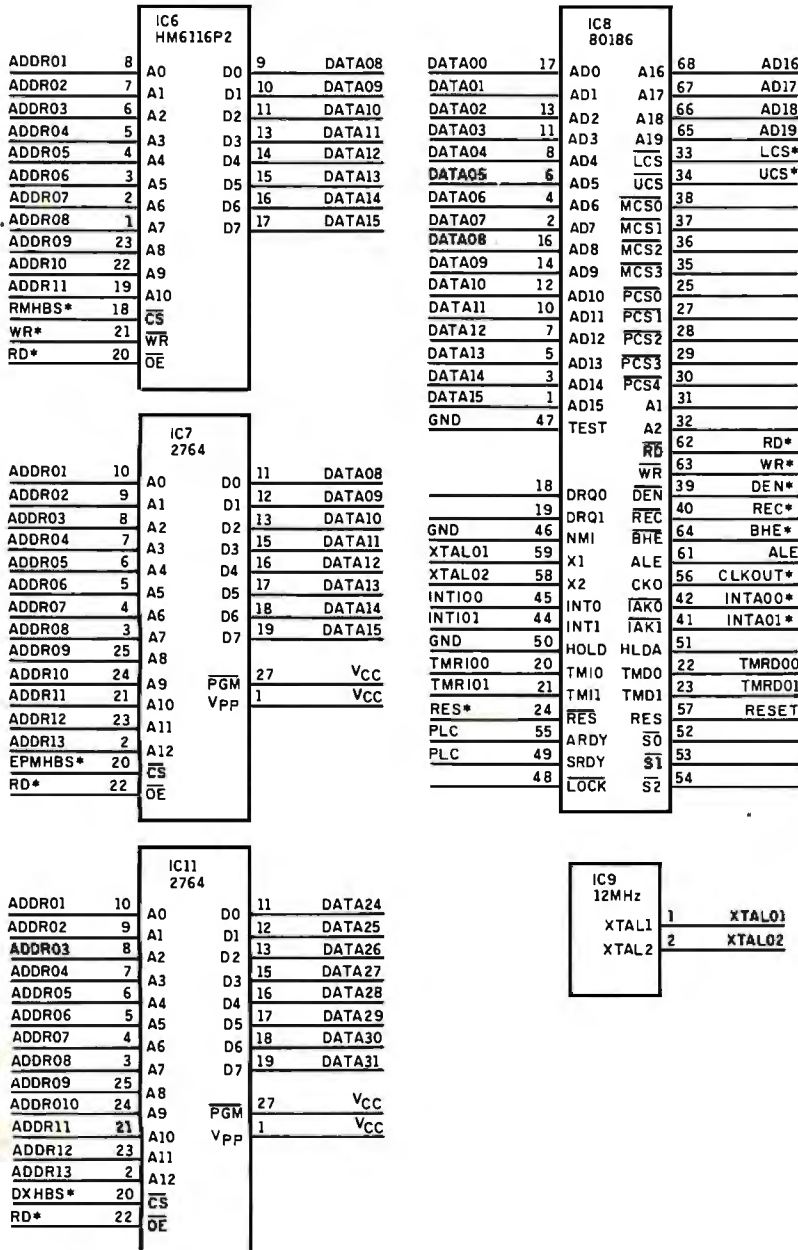

ual files, of similar structure, consisting of fixed-length (128-byte) records. Four records are reserved for file maintenance to permit reuse of space relinquished by deleted components in order to eliminate the need for periodic "packing" (rewriting) of the file. The average file size is 500 bytes per integrated circuit.

Program Structure

The CADcompiler system, written in Microsoft Pascal, was developed as a set

of separate programs using common utility routines and library files. They were then compiled as a set of modules directed by a menu-driven command interpreter. Memory requirements were minimized by placing each module in a separate overlay, with the interpreter and utilities in the main program. The overhead for swapping modules is negligible, since the minimum time each function is used is normally measured in minutes.

continued

MAC INKER™

MAC INKER™, Automatic Ribbon Re-inker. Re-ink any fabric cartridge or spool for **less than 5 cents.** Over 70,000 in the field and



we support **ALL** printers. Universal Cartridge or Universal Spool **MAC INKER**

\$68.50.

We have cartridges re-inkable in 10 colors. Ask for your printer type or for complete listing. Bottle ink \$3.00/each. Shipping \$3.00.

PROTEUS™, the 'Siamese' Buffer.

It is a **Data Switch** with buffer on both ports. Switch manually or via software. Saves time, space and money. Or ask about our **MAC MASTER** line of Universal Buffers and



Printer Controllers (serial or parallel up to 1 MEG).

PROTEUS 64 K-199.00

256 K-299.00 Shipping \$4.00.

Of course we have **Data Switches**, serial/parallel, 2 way, 4 way, crossed etc., at most competitive prices (all lines switched).

CABLES priced \$10-30. We carry cables for all common computers and peripherals. Rapid turn-around on custom orders.

MERCURY MODEM. Really 100% Hayes* Compatible. 300/1200 baud, speaker, full status light display and 2 year warranty. **\$149.00**

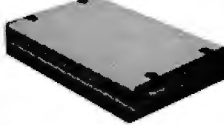

Includes Quick Link Communications Software—fast, quick, easy to learn. \$29.95 (available for IBM PC or Macintosh)

*Hayes is a trademark of Hayes Microproducts.

MAC THE RIPPER. Our newest, original and welcome printer companion. Pulls off paper perforations and tears the sheets apart. Takes little space and will pay for itself almost immediately in saved time and tedium. Ask for brochure. Introductory Price **\$299.00.** Shipping \$10.00.

Order Toll Free.

Call or write for free brochure. **1-800-547-3303**
In Oregon 503-626-2291 (24 hour line)
We are and always will be your

Computer Friends®

14250 N.W. Science Park Drive
Portland, Oregon 97229 Telex 4949559
Dealer inquiries welcome.

Another advantage of this structure is that the program remembers the current design context as the designer moves from one module to another, and is able to provide reasonable default file names as needed to minimize typing.

The modules available in the current version of the program are listed in the top-level menu (see figure 3.) Each module is accessed by typing the letter in parenthesis before the name, and generally responds with requests for necessary file names. Once the basic design name is entered, the default values are usually reasonable and can be accepted with a carriage return or modified. At any point the user can return back up the menu tree by pressing the Escape key.

Design Data Entry

Entry of new data or design modification can be accomplished easily from either a block diagram or marked-up schematic. Selection of the design module initiates a request for a design file name and a library file name, then proceeds to a menu with options to change/add/delete a device or provide an inventory of the design's contents. A device is selected by entering a name of up to 10 characters (normally a sequential designator such as U01). For best formatting, the same number of digits should be used in all designators. If the device has not already been entered, a request is made for a device type that must match a device in the selected library.

When the preliminary data is complete, the entry form is displayed as a logic symbol for the selected device, with the currently assigned signal names on the corresponding leads (see figure 4). A 10-character-wide reverse video field can be moved from pin to pin for entry or modification of signal names. Convenient cut-and-paste options and auto-incrementing or decrementing of bit numbers for data buses minimize the amount of typing required.

When data for a device is complete, the Escape key invokes a request to save the data or exit to the menu without saving. Further typing is often saved by copying the data from one device to a new designator so that only the differences need be entered.

Library Data Entry

The library entry form is essentially the same as that for design entry. If the device already exists, then the form looks the same as for the corresponding device in a design, except that the cursor can move to the 3-character pin number field and the 5-character pin function field. The 7-character field corresponding to the signal name field of the design form is

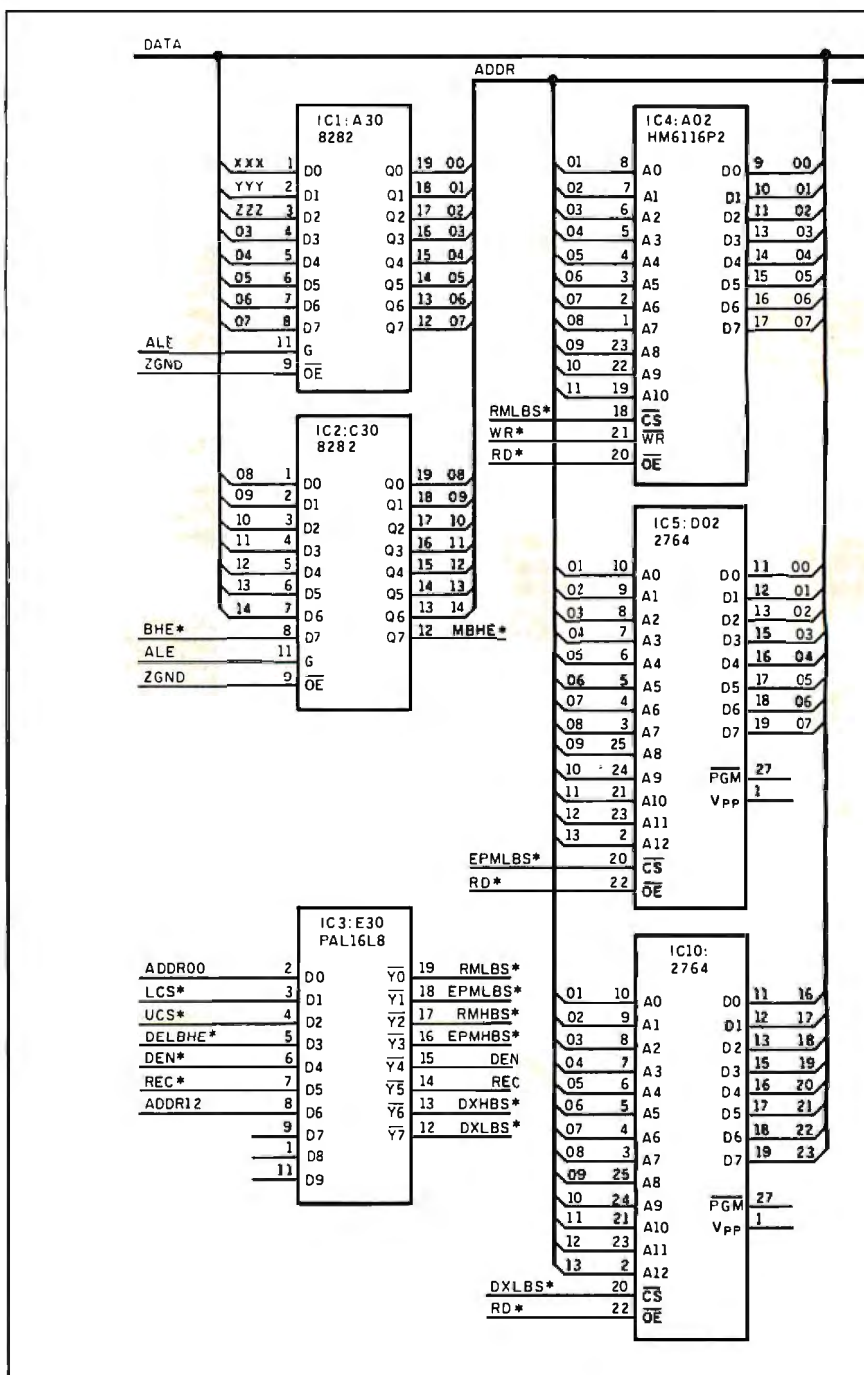

Figure 6: A CADcompiler finished drawing, showing the added data bus lines.

for entry of pin-related parameters.

For example, a Z in this field tells the netlist report generator to take the pin function field (usually GND or VCC), prefix it with a Z, and add it to the netlist for the corresponding pin of any device using this part in the design. It also tells the design entry module not to display this pin on the entry form, and the drawing report generator not to show the pin on the drawings. This feature eliminates the need for entry of these signals and also puts them at the end of the netlist for

convenience in checking.

If the part is not in the library, a small box is displayed with space for one lead on each side. The box can be lengthened for provision of up to 100 leads on a side. No leads are shown until the pin number has been entered. After entry of pin numbers, functions, and parameters, pressing the Escape key invokes requests to save and for device-related information such as physical width and width on the drawing reports. Completion of this data causes a return to the library menu.

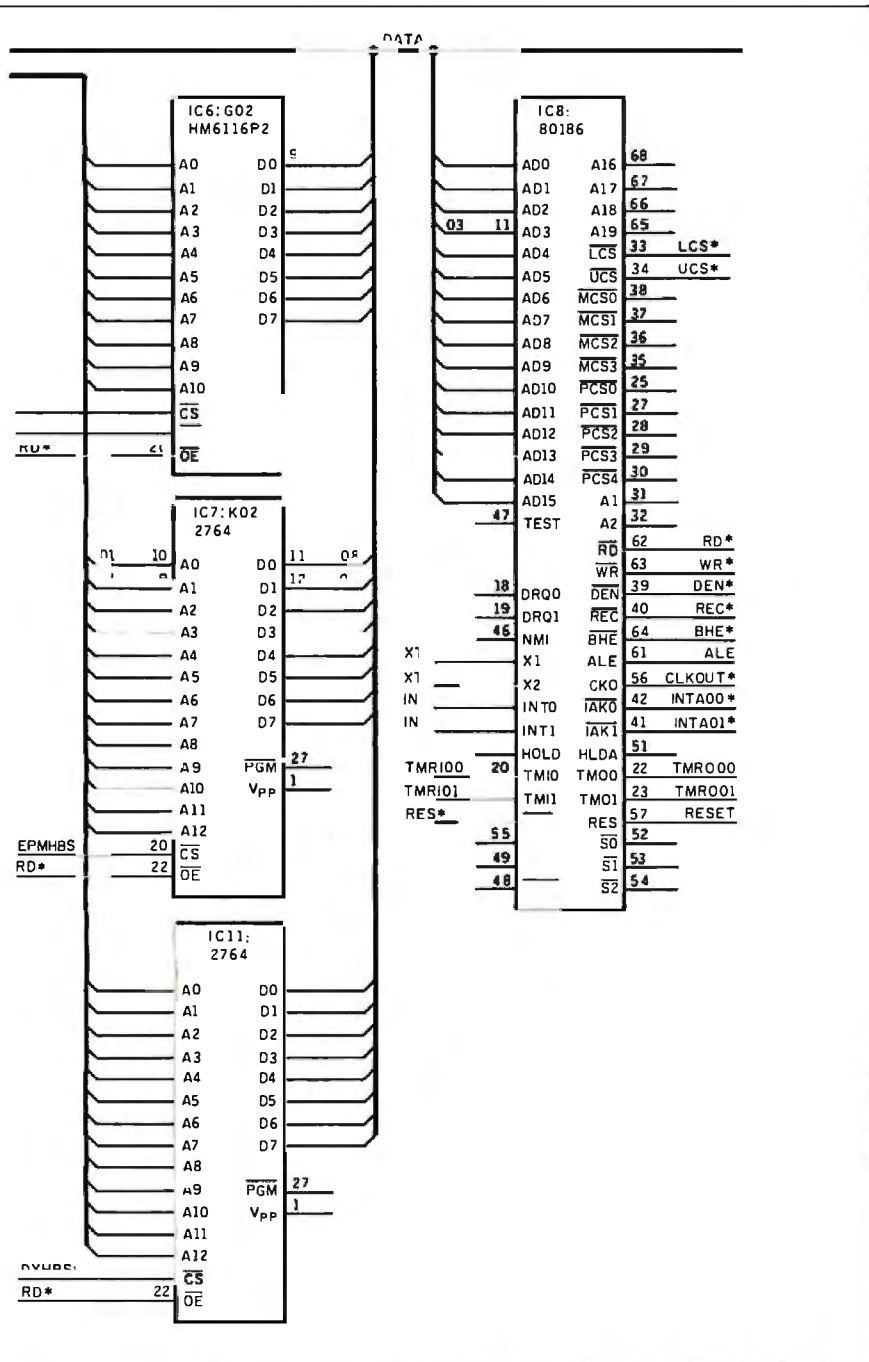

also yields a speed increase of two to four times that of the graphics modes of most printers. The limitation to rectangular shapes with leads on the sides becomes less of a problem with the tendency to use PALs instead of gates.

The primary drawing format is the "check drawing" that presents each device individually with all signal names listed on leads next to the corresponding pins (see figure 5). The devices can be placed on 8 1/2- by 11-inch pages using the Arrange module, a graphics placement program that shows any two pages side by side on the screen. Figure 6 shows a finished CADcompiler drawing.

One significant advantage of the database-oriented CADcompiler system is that since the drawings are generated from the design, rather than the other way around, they need not be completed until the product is complete. This allows the drawing to be arranged for maximum clarity after its full content is known. This drawing modification cannot change the design, as might happen inadvertently with a drafting-oriented CAD system.

Engineering Change Control.

A very important requirement for a digital CAD system is the ability to track engineering changes, especially during the development phase, if several boards are checked out concurrently but cannot be maintained at the same revision level. The Change module provides for comparison of two design files and generates a change report in the form of a netlist showing only the difference between the two files (see figure 7). This format has been used effectively for making the required wiring changes, and since it is simpler to implement than to write a change list directly, it encourages the maintenance of the design file.

An effective strategy is to maintain a copy of the design file at each revision level during development. It is then easy to generate a change list to update a board at any level to the current, or some intermediate, revision. This strategy is particularly effective if for some reason a change is removed or modified in one board prior to being incorporated into another. ■

ACKNOWLEDGMENTS

The author wishes to acknowledge the efforts of several people in the development of the CADcompiler program. Aaron Goldberg (Signatron Inc., Burlington, Massachusetts) developed the database file management system and the screen editor utilities. Rob Croke (Custom Silicon Inc., Lowell, Massachusetts) developed the drawing and netlist report utilities and the hardware assembler module.

Netlist Reports

The netlist report selection produces another menu for selection of a specific format. The diagnostic signal list (figures 1 and 2) provides a compact alphabetic list of the pins connected to each signal. This report also includes a single-pin list and an unused-pin list.

A variation of that list is available for a specific type of wire-wrap or multiwire board where the designators have been converted from device pin numbers to board pin numbers. Two other formats

provide for interface to Redac and Telesis systems for automatic printed circuit layout. At least one should be close enough that a simple format-conversion program can interface with almost any automatic manufacturing process.

Drawing Reports

The CADcompiler uses character-mode graphics and produces all the entry forms and drawings using normal text combined with the graphics characters provided by most dot-matrix printers. This technique



DISCOVER PARADISE

Programmer's Paradise Gives You Superb Selection, Personal Service and Unbeatable Prices!

Welcome to Paradise. The MS/PC-DOS and XENIX software source that caters to your programming needs.

Discover the Many Advantages of Paradise...

- Lowest price guaranteed
- Latest versions
- Huge inventory, immediate shipment
- Knowledgeable sales staff
- Special orders
- 30-day money-back guarantee*

NEW CLUES THIS MONTH!

Discover Paradise Contest — Search for the Hidden Clues to our Island's Identity and Win!

	LIST	OURS
C++		
ADVANTAGE C++	\$ 495	479
PFORCE++	395	215
C COMPILERS		
AZTEC C-86 COMMERCIAL	499	CALL
AZTEC C-86 DEVELOPER	299	CALL
C86 PLUS	497	379
DATALIGHT C DEVELOPER'S KIT	99	79
DATALIGHT OPTIMUM C	139	109
LATTICE C 3.2	500	265
W/SOURCE	900	545
LET'S C	75	59
W/CSD DEBUGGER	150	99
MARK WILLIAMS C	495	289
MICROSOFT C 4.0	450	269
MICROTEK 68000/8/10/20 C CROSS	CALL	CALL
TURBO C	100	65
UNWARE 68020 C CROSS	595	CALL
WIZARD C	450	309
C INTERPRETERS		
C-TERP	300	229
INSTANT C	500	379
INTERACTIVE C	219	219
INTRODUCING C	125	105
Q/C	60	55
RUN/C	120	85
RUN/C PROFESSIONAL 1.1	250	155
ASSEMBLERS, LINKERS		
ADVANTAGE DISASSEMBLER	295	265
ADVANTAGE LINK	395	359
ASMLIB	149	129
DIS 'N DATA	165	CALL
MACRO ASSEMBLER	150	93
PASM 86	195	115
PLINK 86 PLUS	495	279

	LIST	OURS
C UTILITY LIBRARIES		
ASYNCH MANAGER	175	119
BASIC_C	175	129
BLACKSTAR FUNCTIONS	99	89
C ESSENTIALS	100	85
C-DISPLAY LIBRARIAN	99	79
C FOOD SMORGASBORD	150	95
W/SOURCE	300	179
C TOOLS PLUS	175	119
DISPLAY EXPRESS	99	79
ESSENTIAL C UTILITY	185	119
ESSENTIAL COMMUNICATIONS	185	125
ESSENTIAL COMMUNICATIONS PLUS	250	189
GREENLEAF COMM	185	125
GREENLEAF FUNCTIONS	185	125
INTERWORK	129	109
LINK & LOCATE	350	315
MULTI-C	149	135
MULTI-COMM	322	CALL
NUMBER OF ISLANDS	295	209
PFORCE	395	249
SYNERGY DEVELOPMENT TOOLKIT	295	265
TIMESLICER	1000	CALL
W/SOURCE	195	139
THE HAMMER	250	179
TOPVIEW TOOLBASKET	195	179
SCREEN DISPLAY.	295	269
WINDOWS FOR C	125	89
C WORTHY	250	175
CURSES	250	175
W/SOURCE	90	79
FLASH-UP WINDOWS	225	155
GREENLEAF DATA WINDOWS	395	289
W/SOURCE	99	65
MICROSOFT WINDOWS	500	309
DEVELOPMENT KIT	149	109
ON-LINE HELP	295	215
PANEL	495	395
PANEL PLUS	99	79
POLYDESK III	295	265
QUICKSCREEN	150	135
SCREENPLAY (LATTICE)	185	175
SOFTSCREEN HELP	275	199
VIEW MANAGER	225	199
VITAMIN C 3.0	99	85
VC SCREEN	295	239
WINDOWS FOR C	395	315
WINDOWS FOR DATA	245	175
Z VIEW	245	175
FILE MANAGEMENT		
ASMTREE	395	339
B'TRIEVE	245	185
X'TRIEVE	245	185
REPORT OPTION	99	145
B'TRIEVE/N	595	455
X'TRIEVE/N	595	455
REPORT OPTION/N	345	269
C-ISAM	225	195
C-TRIEVE	395	315
W/SOURCE	295	239
C'TREE	650	519
C'TREE/R-TREE BUNDLE	395	329
COL	250	169
HALO - FIVE MICROSOFT LANGUAGES	595	389
METAWINDOW	185	115
METAWINDOW PLUS	235	185
METAFONTS	80	59
METAFONTS PLUS	235	185

	LIST	OURS
DB_VISTA	195	145
W/SOURCE	495	399
DB_QUERY	195	155
W/SOURCE	495	399
FAIS	150	129
FAIS PLUS	195	169
INFORMIX	795	639
INFORMIX 4GL	995	799
INFORMIX SQL	795	639
LATTITUDE	165	CALL
PHACT	295	265
DEBUGGERS		
ADVANCED TRACE 86	175	125
BREAKOUT	125	99
C-SPRITE	175	129
CODESMITH 86	145	105
CSD DEBUGGER	75	59
PERISCOPE I 3.0	345	295
PERISCOPE II 3.0	175	145
PERISCOPE IIX 3.0	145	109
PERISCOPE III	995	825
PFX 86 PLUS	395	229
XVIEW 86	60	49
EDITORS		
BRIEF	195	CALL
DBRIEF	95	CALL
BRIEF/DBRIEF BUNDLE	275	CALL
C SCREEN	75	CALL
CVUE	75	59
W/SOURCE	250	195
EDIX	195	155
EMACS	295	265
W/SOURCE	995	895
EPSILON	195	155
W/SOURCE	295	229
FIRSTIME (C)	100	CALL
INHABITED ISLANDS	125	99
KEDIT	125	99
LSE	149	109
PC/VI	195	115
PMATE	195	145
SP/PC	150	99
VEDIT	185	129
VEDIT PLUS	99	79
XTC		
SORT UTILITIES		
AUTOSORT	150	129
MICROSOFT SORT	195	129
OPT-TECH SORT	149	115
PROFILERS		
CODE SIFTER	119	95
PFINISH	395	229
THE PROFILER	125	89
LINT	139	99
PC LINT	295	155
PRE-C		
MAKE UTILITIES		
ADVANTAGE MAKE	125	99
LNK	195	139
PMAKER	125	79
POLYMAKE V 2.0	149	119
SAMIENS MAKE	79	75

	LIST	OURS
386I ASM/LINK	495	399
HIGH C	895	759
PROFESSIONAL PASCAL	895	759
TRANSLATORS/BRIDGES		
BASTOC	495	399
BAS_C	85	79
BAS_PAS	85	79
DI2C	299	269
F2C	795	CALL
MB 86	895	CALL
PTRAL	179	CALL
R BRIDGE	395	339
TP2C	249	CALL
ARTIFICIAL INTELLIGENCE		
ARITY COMBO PACK	1095	979
ARITY PROLOG INTERPRETER	295	229
ARITY STANDARD PROLOG	95	79
GOLDEN COMMON LISP	495	CALL
GQL 286 DEVELOPER	1190	CALL
INSIGHT 2+	485	379
IQCLISP	300	CALL
IQLISP	270	CALL
MICROSOFT LISP	250	159
PROLOG 86 PLUS	250	CALL
TRANS LISP PLUS	195	CALL
TURBO PROLOG	100	65
TURBO PROLOG TOOLBOX	100	65
SMALLTALK V	99	85
BASIC		
BETTERBASIC	199	129
BETTERBASIC ADD ONS	CALL	CALL
BETTERTOOLS	95	85
87 QB PAK	69	59
87 SOFTWARE PAK	180	149
EXIM TOOL KIT	50	49
FINALLY	99	89
FINALLY MODULES	99	89
GDPEdit	99	89
INSIDE TRACK	65	55
MACH2	75	59
MICROSOFT QUICKBASIC	99	65
PEEK'S 'N POKES	45	39
PROFESSIONAL BASIC	99	75
8087 MATH SUPPORT	50	45
PANEL-BASIC	145	115
QUICK PAK	69	59
STAY RES	95	75
TRUE BASIC	150	105
ADD ONS	CALL	CALL
TURBO BASIC	100	65
COBOL COMPILERS/UTILITIES		
FPLIB	149	129
MICROSOFT COBOL	709	439
MICROSOFT SORT	195	129
MICRO/SOF	175	155
OPT-TECH SORT	149	115
REALIA CICS	995	785
REALIA COBOL	995	785
REALIA MENU	150	119

We'll Match Any Nationally Advertised Price.

	LIST	OURS
RM/COBOL	950	649
RM/COBOL 8X	1250	909
SCREENIO	400	CALL
SCREENPLAY	175	129
SPH	345	279
VISUAL COBOL (MBP)	795	695

FORTRAN COMPILERS/UTILITIES		
AC/TIMESERIES	495	389
DIAGRAM'ER	129	115
DOCUMENT'ER	129	115
87SL	250	225
FORLIB 2.0	95	85
FORLIB-PLUS	70	45
FORTRAN SCIENTIFIC SUBROUTINES	295	249
FOR-WINDS	90	69
GRAFLIB 2.0	175	159
GRAFMATICS OR PLOTMATICS	135	119
GRAFMATICS AND PLOTMATICS	240	219
LAHEY FORTRAN	477	CALL
MICROSOFT FORTRAN 4.0	450	269
NO LIMIT	129	115
PLOTHI 2.0	175	159
PLOTHP 2.0	175	159
RM/FORTRAN	595	389
STRINGS AND THINGS	70	55

MODULA-2		
FARBWARE MODULA-2	90	79
LOGITECH MODULA-2	99	79
APPRENTICE PACKAGE	99	79
WARD'S PACKAGE	199	159
MAGIC TOOLKIT	99	79
ROM PACKAGE & RT DEBUGGER	299	239
WINDOW PACKAGE	49	39
REPertoire	89	75

PASCAL COMPILERS		
MAGNUS PASCAL	189	169
MICROSOFT PASCAL	300	185
PASCAL-2	350	329
TURBO PASCAL	100	65
NUMERICAL METHODS TOOL BOX	100	65
OTHER BORLAND	CALL	CALL

TOOLS FOR TURBO PASCAL		
ALICE	95	69
FIRSTIME	75	59
FLASH-UP WINDOWS	90	79
SCREENPLAY	100	89
SCREENSCULPTOR	125	95
T-DEBUG PLUS	60	50
TURBO-ASM	100	85
TURBO DATABASE TOOLBOX	70	45
TURBO EDITOR TOOLBOX	70	45
TURBO EXTENDER	85	65
TURBO GRAPHIX TOOLBOX	70	45
TURBO HALO	129	99
TURBO PASCAL ASYNCH MGR	100	79
TURBO PROFESSIONAL	70	49
TURBO POWER TOOLS PLUS	100	79
TURBO REF	50	45
TURBO SMITH	69	45
TURBO WINDOWS	80	65
OTHER TURBO TOOLS	CALL	CALL

OTHER LANGUAGES		
IF YOU DON'T SEE IT—CALL!!!!		
APL+PLUS	595	429
JANUS/ADA C PACK	95	89
JANUS/ADA D PACK	900	769
JANUS/ADA ED PACK	395	CALL
LATTICE RPG II COMPILER	750	629
SCREEN DESIGN AID	350	309
SOURCE ENTRY UTILITY	250	199
SORT/MERGE UTILITY	250	199
RPGCOMBO	1100	879
PC FORTII	150	109
PERSONAL REXX	125	99
HOCKET APL	95	75

DBASE COMPILERS, RELATED PRODUCTS		
CLIPPER	695	459
DBC III PLUS	750	599
DBRIEF	95	CALL
FOXBASE	395	CALL
FOXBASE PLUS	395	CALL
GENIFER	395	309
QUICK SILVER	599	499
TOM RETTIG'S LIBRARY	100	79

DIGITAL RESEARCH		
CB 86	600	569
PASCAL MT+	400	379
PLJ—86	750	709
DR ASSEMBLER + TOOLS	200	189
ACCESS MANAGER	400	379
DISPLAY MANAGER	500	475
FORTRAN 77	350	329

BLAISE		
ASYNCH MANAGER	175	119
C TOOLS PLUS	175	119
EXEC	95	69
PASCAL TOOLS	125	99
PASCAL TOOLS 2	100	85
PASCAL TOOLS & PASCAL TOOLS 2	175	119
RUNOFF	90	45
TURBO ASYNCH MANAGER	100	79
TURBO POWER TOOLS PLUS	100	79
VIEW MANAGER	275	179

NEW PRODUCTS

M oport System VAT—New release 2.2 of this system has numerous enhancements, faster speed, improved documentation. Includes free Nutshell guide to UNIX and Sysvision, a user-friendly system administrator front end to UNIX. List \$549 **Ours \$465**

M icrosoft COBOL v. 2.2—Latest release of GSA-certified COBOL compiler. Now includes Microsoft COBOL TOOLS with ViewCob, interactive symbolic debugger and COBOL cross-reference generator. List \$700 **Ours \$439**

P eriscope I hardware breakpoint debugger. Fi al-time sy ms, stop

LATTICE C COMPILER	500	265
W/SOURCE	900	545
C CROSS REFERENCE GENERATOR	50	39
C FOOD SMORGASBORD	150	95
W/SOURCE	300	179
C-SPRITE	175	129
CURSES	125	89
W/SOURCE	250	175
DBC III/II	250	169
W/SOURCE	500	359
DBC III PLUS	750	599
W/SOURCE	1500	1195
LMK	195	139
SECRETDISK	120	89
SIDETALK	120	89
SPP/PC	350	269
TEXT MANAGEMENT UTILITIES	120	89
TOPIVIEW TOOLBASKET	250	179

LIFEBOAT		
ADVANTAGE C++	495	479
ADVANTAGE DISASSEMBLER	295	265
ADVANTAGE LINK	395	359
ADVANTAGE MAKE	125	99
PANEL PLUS	495	395
QUICKSCREEN	295	265
RUN/C	120	85
RUN/C PROFESSIONAL 1.1	250	155
TIMESLICER	295	265
W/SOURCE	1000	CALL

MICROSOFT		
C COMPILER	450	269
COBOL	700	429
FORTRAN—NEW V. 4.0	450	269
LISP	250	159
MACRO ASSEMBLER	150	93
MUMATH	300	185
PASCAL	300	185
QUICKBASIC	99	65
SORT	195	125
WINDOWS	99	65
WINDOWS DEVELOPMENT KIT	500	309

PHOENIX		
PASM 86	195	115
PDISK	145	89
PFANTASY PAC	995	599
PFINISH	395	229
PFIX 86 PLUS	395	229
PFORCE	395	209
PFORCE++	395	215
PLINK 86 PLUS	495	279
PKMAKER	125	79
PMATE	195	115
PRE-C	295	155
PTEL	195	115

POLYTRON		
C BEAUTIFIER	49	45
C LIBRARY I	99	79
C LIBRARY II	80	69
POLYDESK III	99	79
POLYDESK III ADD ONS	CALL	CALL
POLYLIBRARIAN	99	79
POLYLIBRARIAN II	149	115
POLYMAKE 2.0	149	119
POLYHELL	149	119
POLYXREF	219	169
POLYXREF—ONE LANGUAGE	129	99
POWERCOM	179	139
PVCS PERSONAL	149	119
PVCS CORPORATE	395	309
PVCS NETWORK	1000	CALL

OPERATING SYSTEMS		
OPERATING SYSTEM TOOLBOX (WENDIN)	99	79
PCNX	99	79
PCVMS	99	79
SYSTEM/VAT (MICROPORT)	549	465
DOS MERGE 286	149	125
RUNTIME SYSTEM	199	169
SOFTWARE DEV. SYSTEM	249	209
TEXT PREPARATION SYSTEM	199	169
UNLIMITED USER UP/GRADE	249	209
XENIX SYSTEM V (SCO)	1295	999
XENIX DEV. SYSTEM	595	499
XENIX OPERATING SYSTEM	595	499
XENIX TEST PROC. PKG.	195	145

DESKTOP PUBLISHING		
HALO DPE	195	155
XEROX VENTURA PUBLISHER	895	695
TURBO VENTURA PUBLISHER	1595	1249

XENIX/UNIX PRODUCTS		
ADVANTAGE C++	695	CALL
BTRIEVE	595	465
C-ISAM	319	285
C-TRIP	498	CALL
C-TREE	395	329
DB_VISTA	395	329
R-TREE	CALL	CALL
FOXBASE	795	CALL
INFORMIX	995	795
INFORMIX 4GL	1500	1235
INFORMIX SQL	995	795
LYRIX	595	449
MICROSOFT BASIC	350	239
MICROSOFT COBOL	995	629
MICROSOFT FORTRAN	695	439
MICROSOFT PASCAL	695	439
NETWORKS FOR XENIX	595	495
PANEL	625	535
RM/COBOL	1250	949
RM/FORTRAN	750	549
SCO PROFESSIONAL	795	595
UNIWARE 68020 C CROSS	1390	CALL

TELE COMMUNICATIONS		
ANNUAL RAINFALL (MM)	3000	CALL
ASCOM IV	195	175
PTEL	195	115
SIDETALK	120	89

ADDITIONAL PRODUCTS		
C TOOL SET	95	CALL
COMMAND PLUS	80	69
DAN BRICKLIN'S DEMO PROGRAM	75	59
FASTBACK	175	135
HELP/CONTROL	125	99
INTERACTIVE EASYFLOW	150	129
LATTICE TEXT MGMT. UTIL.	120	89
MICROSOFT MACH 10		
W/MOUSE & WINDOWS	549	379
MKS TOOLKIT	139	CALL
NORTON COMMANDER	75	55
NORTON UTILITIES	100	59
PC/EDT	250	CALL
PDISK	145	89
SAPIENS V8	300	269
SCREEN MACHINE	79	59
SCROLL & RECALL	69	59
SECURITY LIBRARY	125	CALL
SOURCE PRINT	75	69
TASKVIEW	80	59
TLIB	100	89
TREE DIAGRAMMER	55	50
VTEK	150	129
ZAP	95	CALL

SOFTCRAFT SPECIALS		
BTRIEVE	245	185
XTRIEVE	245	185
REPORT OPTION	145	99
BTRIEVE/N	595	455
XTRIEVE/N	595	455
REPORT OPTION/N	345	269

CALL TOLL FREE: **1-800-445-7899**
In NY: 914-332-4548

Programmer's Paradise



42 River Street, Tarrytown, NY 10591

DISCOVER PARADISE CONTEST

Win The High-Performance Software Development Package, Valued At Over \$2,000!

Now that you've seen what Programmer's Paradise looks like, we want you to guess where it is! Just search this ad for clues to the identity of our tropical island paradise (Hint: They're mixed in with our product listings). Then send in your guess on this coupon. You could be the lucky winner of the high-performance software development package**, featuring: • **Univation's Dream Board**—Multifunction accelerator board with EMS. Designed to fit into a single expansion slot. The Dream Board combines the functions of three of the most popular enhancement boards—multifunction, EMS, accelerator—into one power-packed package • **ADVANTAGE Link** overlay linker • **Microsoft** compiler of your choice (MS/PC-DOS) • **Editor** of your choice (binary). **... VALUE: OVER \$2,000**

Complete this form and mail to: DISCOVER PARADISE CONTEST, c/o Programmer's Paradise, 42 River Street, Tarrytown, NY 10591. Entries must be received by August 1, 1987.

OFFICIAL RULES: 1. Limit one name per entry, no purchase necessary. Enter as often as you wish, mailing each entry on a separate postcard. All entries must be received by August 1, 1987. 2. Participants must be 18 years or older and a resident of the United States. Void where prohibited by law. 3. Winner will be responsible for all taxes. 4. Odds of winning will be determined by number of entries received. 5. Prize will be awarded within 30 days of all entries received. **No substitutions allowed.

I think the name of the island in your ads is: _____

Name _____ Title _____

Company name _____

Company address _____

City _____ State _____ Zip _____

Phone # _____ 6B



Inquiry 160

Pixel Perfect



The difference is clear.

Infograph combines the unique features of its P100 graphics controller with the IBM® 591 AC Plasma monitor. Plasma technology requires no refresh scan or shift so images are sharp and flicker free. And since the working surface is flat, lines are straight and precise, making this an exceptional display for precision drafting and designing. Graphics and text are razor sharp. No fuzz. No swim. No flicker.

Star of the big screen.

The Infograph system gives you a 17.2 inch diagonal viewing area and high resolution—960 x 768. That's 737,280 individually addressable pixels (71.4 pixels per inch). With a 10,000 character display capability, it's an excellent tool for desk top publishing, spreadsheets or word processing. There's room on the screen to display the equivalent of six conventional CRTs simultaneously.

No big bulky box here. The screen's foot print is just 7.8 inches deep so it saves work space. And with a 110 degree viewing angle, it's an excellent device for group presentations.

A cure for terminal illness.

The 40,000-hour MTBF rating of the Infograph system is two to three times that of most CRTs. It holds up in demanding work environments and sensitive installations. Virtually no radiation is emitted. And since images are flicker free, eye fatigue is minimized.

This is an excellent display for today's sophisticated software packages such as: Autocad, Lotus 123, VIA PC, XYWrite and Ventura Publisher. A software toolkit is available for OEMs and systems developers which makes adaptation of new or existing systems straight-forward. The difference is clear.

Infograph, graphically superior.



infograph

Infograph Inc.
331 Rio Grande, Suite C
Salt Lake City, Utah 84101
(801) 521-0079

*IBM is a registered trademark of International Business Machines. Autocad is a registered trademark of Autodesk. Lotus is a registered trademark of Lotus Development Corporation. VIA PC is a registered trademark of VIA. Ventura Publisher is a registered trademark of Ventura Software and/or Xerox.

© 1987 Infograph.

**See us at June Comdex
booth #3130**

Computer-Aided Routing of Printed Circuit Boards

An examination of Lee's Algorithm and possible enhancements

Stephen E. Belter

ALGORITHMS FOR THE computerized routing of traces on printed circuit boards have been evolving for the past 30 years. The rapid growth of the electronics industry and the availability of CAD programs for personal computers have moved the technology from mainframe computers in research laboratories directly to the desks of engineers.

All modern personal computers use PC boards to interconnect the various integrated circuits and components that compose most of their electronics. PC boards are usually constructed using an insulating glass-epoxy composite sandwiched between two layers of copper. Each copper layer is etched in such a way as to interconnect the appropriate leads of the components soldered to the PC board (see photo 1 and figure 1).

Designing the pattern of copper traces on a PC board can be a difficult task, as the connections cannot cross on a given layer. The process of determining the path a trace will follow between two points on a PC board is called routing. When routing is performed manually on a computer, the designer specifies where each line segment starts and ends for each trace on the board. If the CAD program supports interactive routing, the designer need only point to the two electrical networks to be connected, and the router will find and draw a path connecting the networks, if a path exists.

A so-called "auto-router" automates this process further by using a list of connections to be made and cycling the router through this list, connection by connection. This process can take anywhere

from several minutes to several days to complete, depending on the board density, the number of copper layers on the PC board, the algorithms used, and the computer. In general, the resulting layout will have most, but not all, of the connections completed.

Completion percentages typically range from 60 percent to 90 percent, although examples of 100 percent completion are easy to contrive. Under normal circumstances, an operator must visually analyze the layout for traces that block the connections still to be made. These blocking traces are then moved, and new traces are run either manually or with the help of the interactive router.

In the best cases, only a few traces need to be moved to complete the board. In the worst cases, the majority of the traces placed by the auto-router must be "ripped up." Improved algorithms and the increased use of multilayer boards are resulting in a trend toward higher completion percentages. However, a claim of 100 percent completion is a trivial accomplishment if an unlimited number of layers is allowed.

While the examples cited here are for PC boards, routing algorithms are also applicable to the design of thin-film and thick-film hybrid electronics and the layout of integrated circuits. The rules are similar: Conductors may not cross on a given layer, and fabrication costs require that the number of layers be minimized.

Lee's Algorithm

Many commercial routing packages, including Wintek's smARTWORK, use a

variation of a maze router. This approach was described by C. Y. Lee and is frequently called Lee's Algorithm. The PC board to be routed is represented in memory as a two-dimensional array, or matrix, of cells (see figure 2). Each cell is square and is centered on a grid point. All traces must start and end on a grid point, and traces can only be drawn horizontally or vertically between grid points. As a result, a cell is either empty or contains a conductor that connects to one or more of the four faces of the cell.

The goal, given a source cell and a target cell centered on grid points, is to find a path from the source to the target that does not cross an existing trace. The path must move only horizontally or vertically between grid points, and can change direction only at a grid point (see figure 3).

Accomplishing the goal involves two major phases. The first involves an ever-widening search in all directions from the source cell until the target cell is found. The search pattern is similar to the ripples in a pond that grow in circles around the spot where a pebble hits the water. The second phase retraces the path from the target cell back to the source.

If a path exists, the algorithm is guaranteed to find the shortest path. The

continued

Stephen E. Belter (1801 South St., Lafayette, IN 47904) is president of Wintek Corporation. He received degrees in electrical engineering and computer science from Purdue University and has been involved with computer-aided-design software since 1971.

length of the path is measured using the Manhattan distance, which is defined as the sum of the horizontal and vertical movements.

Lee's Algorithm requires two data structures for the search—a first-in/first-out queue that holds the locations of cells waiting to be searched, and a flag array with one element for each cell on the PC board. This flag array is in addition to the storage structure used to hold the contents of the cells (conductor patterns) for the board. Each flag array element can take

one of eight values: *source*, *target*, *unchecked*, *blocked*, *north*, *south*, *east*, or *west*. The elements of the flag array are initialized to the value unchecked. The queue is initialized to be empty.

Phase One

The algorithm proceeds as follows:

The breadth-first search begins by (1) storing the value source in the flag array at the coordinates of the source cell. Then it (2) checks the flag-array value at the coordinates of the target cell. If it is equal to

source, the search is done; if not, it stores the value target at this location.

Next, it (3) places the coordinates of the source cell in the FIFO queue. While the queue is not empty, (4) it repeats steps 5 through 9 below. If the queue is found to be empty, the algorithm proceeds with step 10.

Step 5 gets the next set of coordinates from the head of the queue. This cell becomes the home cell for the purpose of steps 6 through 12. Then the algorithm (6) checks the flag-array element of the cell to the north of the home cell. If it contains the value target, the phase-one search is complete and the algorithm jumps to step 11. If the value in the flag-array element north of the home cell is any value other than unchecked, then the cell has already been checked and the algorithm can proceed with step 7.

If the value is unchecked, the cell must be checked for a conductor. If a conductor already occupies this cell, the cell cannot be used for a path from source to target, so the value blocked is stored into the flag-array element for the cell, and the algorithm proceeds with the next step. If the cell is empty, the value south is stored into the flag-array element, and the coordinates of this cell are appended to the tail of the queue. The flag value south will be used as the guide back to the source cell if the target cell is eventually found. This cell is added to the queue so that the neighbor cell will eventually be checked in the search for the target. Steps 7, 8, and 9 repeat this process for the cells east, south, and west of the home cell.

Step 7 checks the flag-array element of the cell to the east of the home cell. If it contains the value target, the phase-one search is complete and the algorithm jumps to step 11. If the value in the flag-array element east of the home cell is any value other than unchecked, the algorithm proceeds with the next step. If the value is unchecked, the cell is checked for a conductor. If a conductor already occupies this cell, the value blocked is stored into the flag-array element for the cell, and the algorithm proceeds with the next step. If the cell is empty, the value west is stored into the flag-array element, and the coordinates of this cell are appended to the tail of the queue.

Step 8 checks the flag-array element of the cell to the south of the home cell. If it contains the value target, the phase-one search is complete, and the algorithm proceeds with step 11. If the value in the flag-array element south of the home cell is any value other than unchecked, the algorithm proceeds with the next step. If the value is unchecked, the cell is

continued

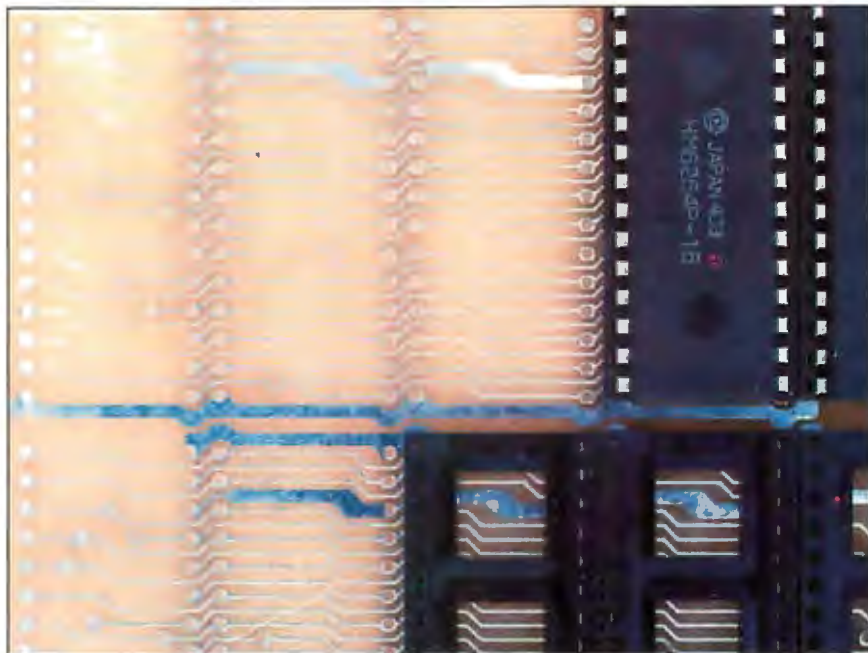

Photo 1: A portion of a Wintek printed circuit board, showing the insulating substrate, copper traces, and components. The copper conductors have been covered with solder, giving them a silver color.

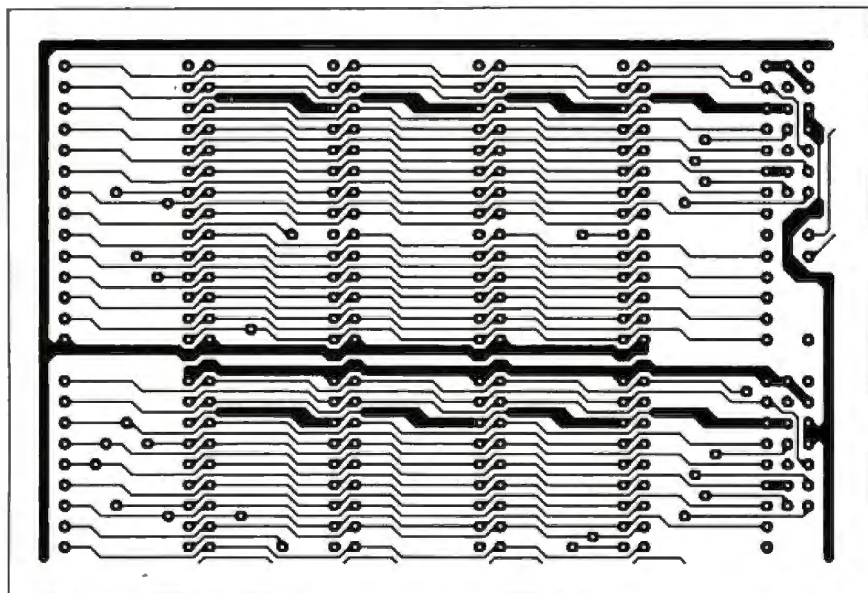

Figure 1: A portion of the artwork used to create the printed circuit board in photo 1.

Aztec C ... The Best C

Frees the genius in you

You've got a great idea . . .

. . . you're ready to write your programs.

You don't want to be sidetracked by all the paperwork. With Manx Aztec C and the ingenious **make** function, your creative processes won't get bogged down in program administration and housekeeping. Manx Aztec C has the most sophisticated, hardworking program administrator available to you. Once you've described your project, adding new features or enhancements is simple. You never have to concern yourself with the repetitive, tedious task of rebuilding your systems.

The development process moves quickly. Compiles, assemblies, link edits . . . all finish in record time.

Manx Aztec C is the fastest, most efficient C development system in the industry. Benchmarks show it . . . reviews commend it . . . users praise it.

You're ready to test the program. You're ahead of schedule. The Manx Aztec C Source Level Debugger shows you the exact C language statement giving you a problem. You fix the problem quickly . . . you're still ahead of schedule.

You've got some time for fine tuning. The Manx Aztec C Profiler examines your program, tells you where the slow spots are and validates your test procedure. A few changes and it's exactly what you wanted.

You've made it!

Aztec C is available for MS-DOS/PC DOS. Call for details on Macintosh, Amiga, Apple II, CP/M-80, CP/M-86, TRS-80, ROM and others.

To order, or, for information

Call Today

1-800-221-0440

In NJ or outside the USA call

(201) 542-2121

30-day satisfaction guarantee. Special Discounts are available to professors, students, independent developers, and on a "trade-in" basis. Site licenses.



Manx Software Systems
One Industrial Way
Eatontown, NJ 07724

MS is a registered TM of Microsoft, Inc., CP/M TM ORI, HALO TM Media Cybernetics, PANEL TM Roundhill Computer Systems, Ltd., PHACT TM PHACT Assoc., PRE-C, Plink-86 TM Phoenix, db Vista TM Raine Corp., C-terp, PC-lint, TM Gimpel Software, C-tree TM Faircom, Inc., Windows for C TM Creative Solutions, Apple II, Macintosh TM Apple, Inc., TRS-80 TM Radio Shack, Amiga TM Commodore Int'l

" . . . a superb linker, a profiler, an assembler, and a set of development utilities are only the beginning of this package . . . performed admirably on the benchmarks, with short compile times and the best link times in this review . . . includes the most professional make utility . . . documentation is clear and complete. There is no doubt that this is a valuable and powerful programming environment." **Computer Languages Feb. '86**

" . . . execution times are very good, close to the best on most tests . . ." **PC Tech Journal Jan. '86**

" Easily one of the fastest compilers overall . . . library provides a lot of flexibility . . . generates small .EXE files." **Dr. Dobbs Journal Aug. '85**

C'Prime (Compiler, Assembler, Linker)	\$ 99.
Aztec C 86-d Developer's System	\$299.
Aztec C 86-c Commercial System	\$499.
PC ROM (8086, 68000, 8080, or 6502)	\$750.

Third Party Software for Aztec C: HALO, PHACT, C-tree, PRE-C, Windows for C, PC-lint, PANEL, Greenleaf, db Vista, C-terp, Plink-86, FirsTime, C Util Lib, and others.

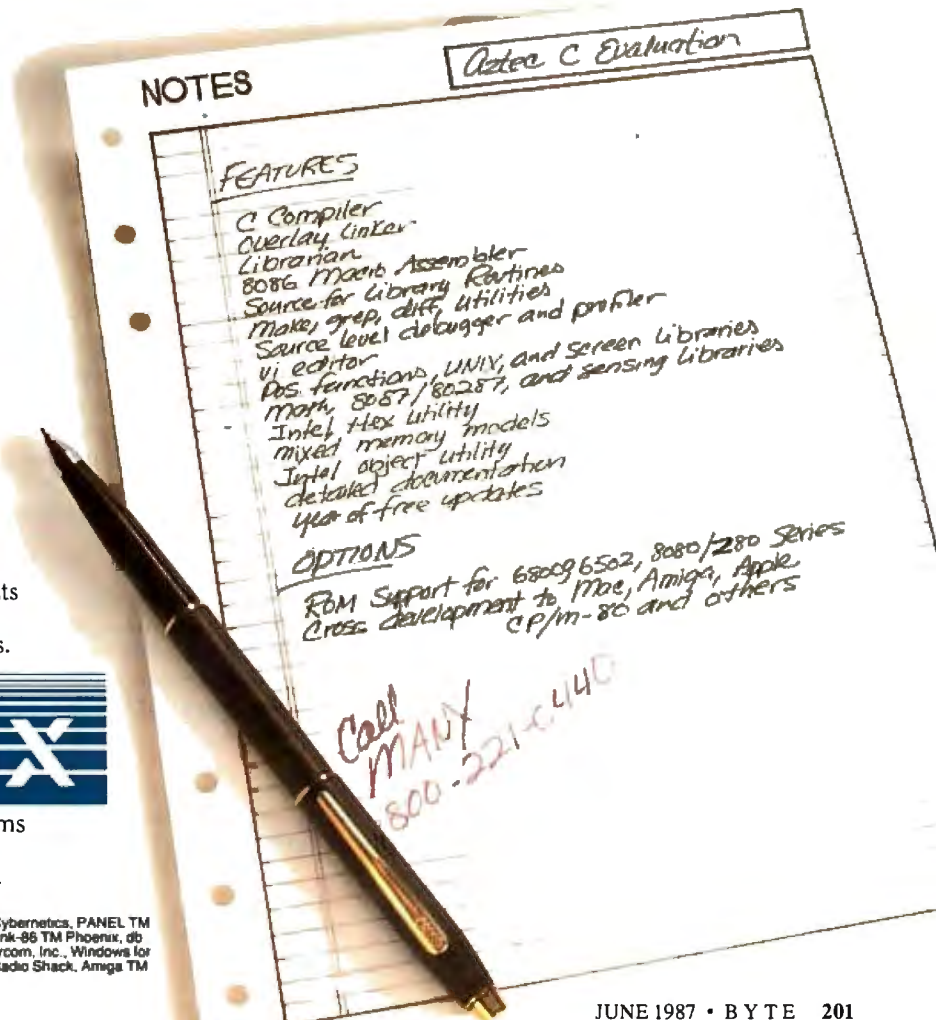

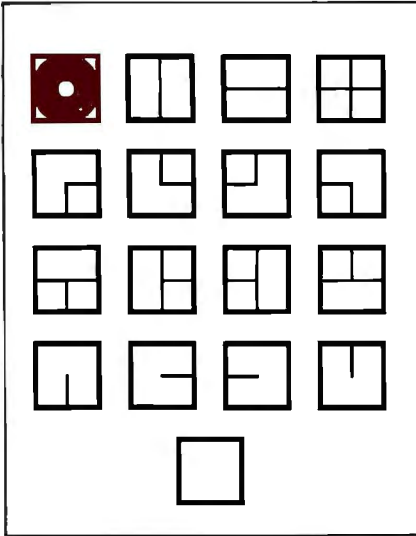

Figure 2: All of the possible cell contents for the basic Lee's Algorithm. Component leads are normally soldered to pads (the circular conductor, also called vias); most traces will start and end at a pad. Pads may be used to connect traces on two different layers.

checked for a conductor. If a conductor already occupies this cell, the value blocked is stored into the flag-array element for the cell, and the algorithm proceeds with the next step. If the cell is empty, the value north is stored into the flag-array element, and the coordinates of the cell are appended to the tail of the queue.

Step 9 checks the flag-array element of the cell to the west of the home cell. If it contains the value target, the phase-one search is complete, and the algorithm proceeds with step 11. If the value in the flag-array element west of the home cell is any value other than unchecked, the algorithm proceeds with the next cell from the queue (step 4). If the value is unchecked, the cell is checked for a conductor. If a conductor already occupies this cell, the value blocked is stored into the flag-array element for the cell, and the algorithm proceeds with step 4. If the cell is empty, the value east is stored into the flag-array element, and the coordinates of this cell are appended to the tail of the queue. The algorithm then loops back to step 4.

If the last step of phase one is reached (10), the queue of cells has been exhausted, and no path exists from source to target.

Phase Two

The second phase retraces the path found from target to source. So far, the algorithm has found the shortest path. All that remains is to (11) place the appropriate conductors in the cells of the PC board to establish a trace from the target to the source. At this point, the home cell is adjacent to the target cell.

Now, the target cell found is modified to add a conductor from the center of the cell to the cell boundary adjacent to the home cell. And the home cell is modified to add a conductor from the cell boundary adjacent to the target to the center of the home cell.

Next, (12) the contents of the flag-array element of the home cell are examined. If it contains the value source, the algorithm is done; if not, it must contain one of the four values north, east, south, or west. The home cell and the cell in the indicated direction are modified to add a

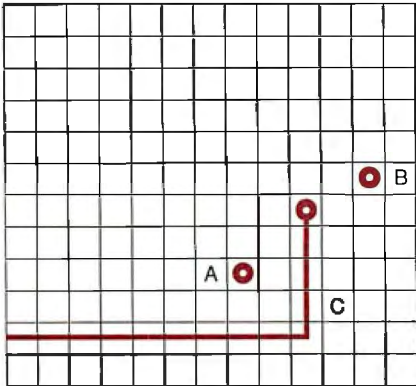

Figure 3a: An example of using Lee's Algorithm to find a path from pad A to pad B. Trace C blocks the most direct route.

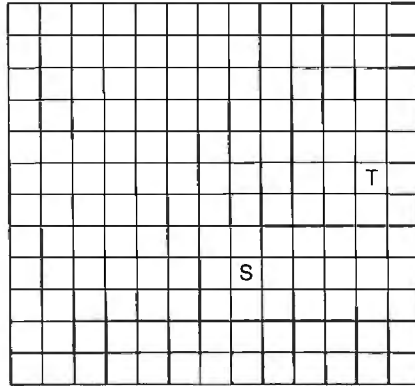

Figure 3b: The flag array is shown pictorially as the search algorithm proceeds during the solution of the problem in figure 4. S and T represent source and target. Unchecked cells are blank. The coordinates of the shaded cell are in the FIFO queue.

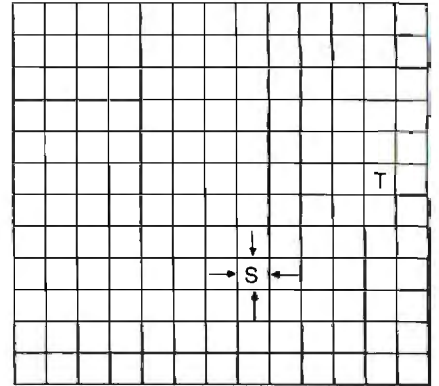

Figure 3c: After following steps 4 through 9 once, the flag array now has four additional entries, and four sets of coordinates are in the FIFO queue. The arrows are used to represent the values north, east, south, and west.

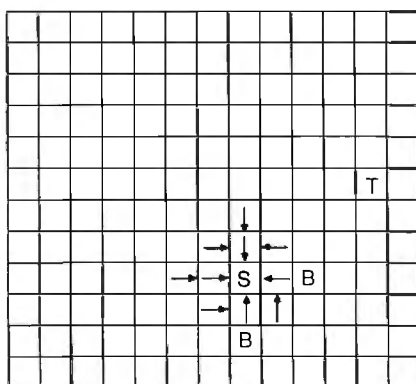
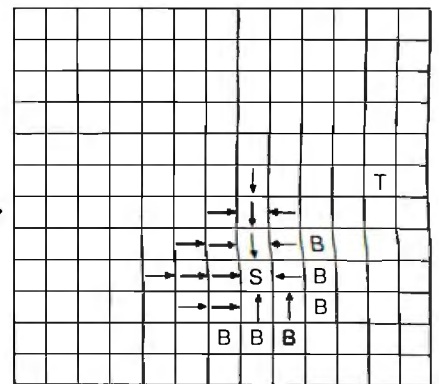

Figure 3d: The diamond-shaped search wavefront is a characteristic of Lee's Algorithm. By this point in the search, two cells that already contain traces have been found and have been marked as blocked.

Figure 3e: Four more blocked cells have been found. The coordinates for six cells are currently in the FIFO queue.



conductor between the cell centers.

Then, (13) the algorithm moves to the cell adjacent to the current home cell in the direction indicated by the home cell's flag-array element. The cell thus reached becomes the new home cell, and step 12 is repeated.

Enhancements to Lee's Algorithm

You could make a number of improvements in the algorithm. In many situations, the source and target cells will already be connected to one or more traces on the PC board before the router is invoked. It is usually desirable to find the shortest path between the source and target networks, rather than insisting on running a new trace between the source and target cells. This is easily accomplished by modifying the first two steps of the algorithm so that all cells electrically connected to the source cell are flagged as source, and all cells in the target network are flagged as target. Also, the coordinates of all cells in the source network are placed in the FIFO queue in step 3. The other steps remain the same.

The algorithm will find one route from

source to target. While the procedure guarantees that there are no shorter routes, there will frequently be more than one route of the same length. In fact, there may be several hundred routes from source to target network with the same Manhattan distance. There are several criteria we can apply to choose among the shortest routes, such as minimizing the number of turns in the trace (turns introduce stress points, which are more likely to fracture) and maximizing the distance to other conductors (to reduce cross talk and avoid solder bridges).

One way to accomplish this task is to modify the search phase of Lee's Algorithm by replacing the north, east, south, and west values with a number indicating the distance back to the source cell. Then, during the retrace, the algorithm could examine the four cells surrounding the home cell for the cells with the shortest distance back to the source. When there are two or more having the minimum distance figure, we can apply the additional criteria to choose among the minimum-length paths.

As presented here, the algorithm

allows only horizontal and vertical traces. Connecting two cells that are located at some diagonal distance with respect to each other can produce a trace with dozens of small "stair steps" (see figure 4). In addition, the assumption that only one trace can occupy one cell can impose severe restrictions on the density of a layout or the minimum distance between components. ICs, which have most of their pins wired in parallel (e.g., memory arrays), may suffer from the "walking jag" problem (see figure 5).

With care, Lee's Algorithm can be modified to allow the introduction of diagonal traces. For example, you can replace a cell holding an L-shaped trace connecting the north and east faces of the cell with a trace moving diagonally from the center of the north face to the center of the east face.

This diagonal cell offers several important benefits. You can now draw smooth lines at 45 degrees in addition to horizontal and vertical traces (see figure 6). The 90-degree junction of a horizontal and vertical trace can now be broken into

continued

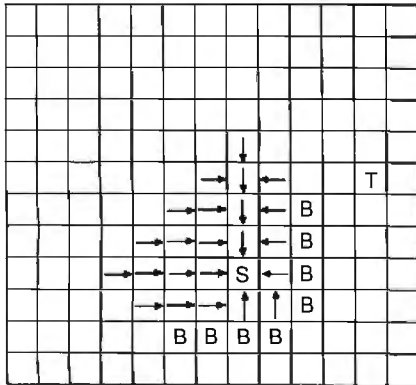

Figure 3f: The search continues to the north and west, as trace C has blocked any further search to the south or east.

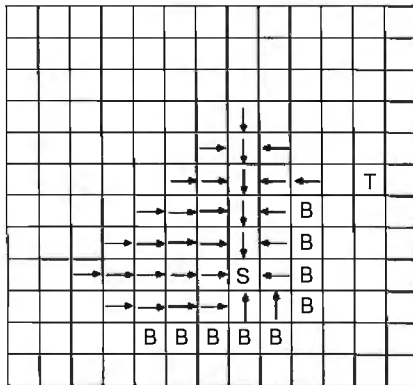

Figure 3g: The algorithm has now found a path to the east again, passing over the upper end of trace C. There are now nine sets of coordinates in the FIFO queue.

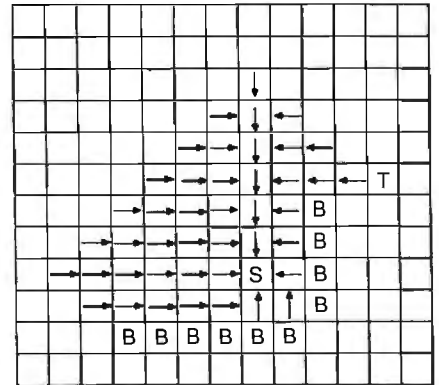

Figure 3h: The search wavefront continues to expand and is now within one cell of finding the target.

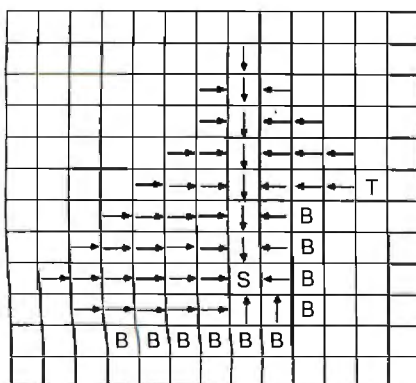
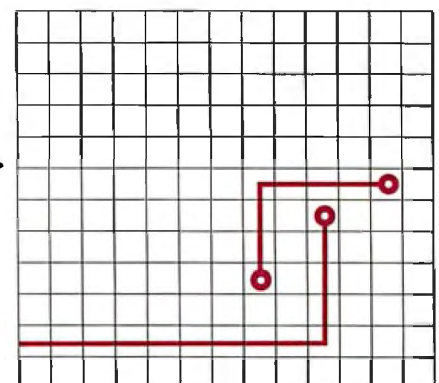

Figure 3i: The flag array after the completion of the search phase. The home cell for step 11 is just to the left of the target (T) cell.

Figure 3j: The route found by applying Lee's Algorithm to the problem in figure 4.



Attention all FX80, FX100, JX, RX, & MX owners:
**You already own half of
 a great printer**

Dealer
 inquiries
 welcome.

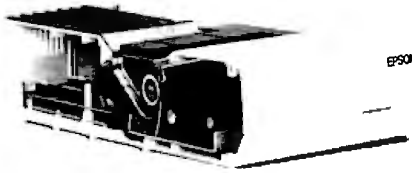

**Now
 Only
 \$79.95**

Now for \$79.95 you can own the rest. You see, today's new dot matrix printers offer a lot more features.

But now, a Dots-Perfect upgrade kit will make your printer work like the new models in minutes—at a fraction of their cost!

For example, with a Dots-Perfect the "dotty" look is gone! In its place is NLQ (Near Letter Quality), a feature that produces printed characters almost as sharp as a daisy wheel or laser printer.

NLQ: Like Having Two Printers

NLQ is not just "double striking." It's a completely redesigned letter form that reshapes each character. Characters are actually formed by four times the normal dot resolution.

And since NLQ can be switched on or off from the touch of a button, you can switch modes whenever you wish.

Installs In Minutes

You can install a Dots-Perfect in minutes with an ordinary screwdriver by following our easy-to-understand illustrated instructions.

All you need do is unplug the existing chips and replace them with a Dots-Perfect—that's all there is to it!

Doesn't Get In Your Way

Dots-Perfect is easy to operate because it actually becomes part of your printer.

It requires no software itself, so it

can be used with every software package.

And you control it from the printer's existing control panel buttons.

You can choose from over 160 printing modes like condensed, double-wide, italic, high-speed draft, or even combinations. All switched on and off at the touch of a button.

Samples shown actual size

NLQ abcdefghijklm
 Condensed Fine Print
Emphasized
Double-Wide
Italics Underline
 Or Hundreds of Combinations!

Dots-Perfect even has a unique panel button controlled buffer clear command.

I.B.M. Graphics

FX, JX and MX versions of Dots-Perfect will even permit switching from the standard Epson® character set to the IBM®Graphics Printer set, allowing you to print IBM screens exactly as they appear on your computer. All three versions have all Graflex Plus™ features, even the MX version.

And, every Dots-Perfect is backed with a full year's warranty.

So, call now toll-free and use your Visa, MasterCard, or American Express card.

Don't replace your printer, upgrade it!

1-800-368-7737

(Anywhere in the United States or Canada)

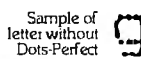

8560 Vineyard Ave., Ste. 405, Rancho Cucamonga, CA 91730

(714) 945-5600

An upgrade kit for EPSON FX, JX, RX, & MX printers

IBM is a registered trademark of International Business Machines Corp. Graflex Plus is a trademark of Epson America, Inc. Epson is a registered trademark of Epson America, Inc.

COMPUTER-AIDED ROUTING

two 45-degree bends (reducing chance of stress fractures). Most importantly, you can allow two parallel diagonal traces in one cell. This eliminates the walking jag problem and allows the placement of memory arrays with only 1/10 inch between ICs.

The modifications to the algorithm re-
continued

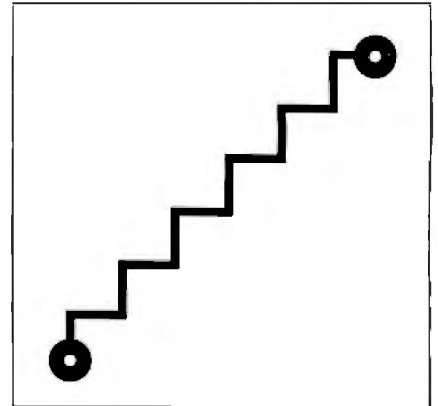

Figure 4: Two diagonally placed cells with a "stair step" trace connecting them.

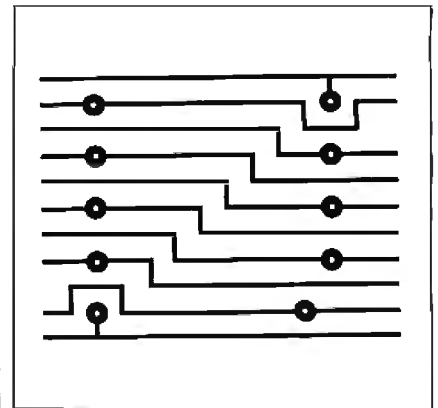

Figure 5: An example of the "walking jag" problem, where two ICs have pins connected in parallel. The distance between the two columns of pads can be reduced by using diagonal traces.

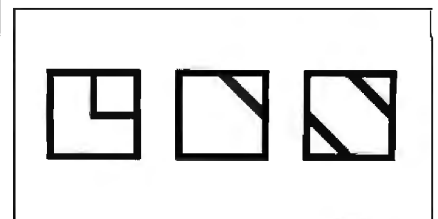

Figure 6: Replacing an L-shaped trace in a cell with a diagonal trace allows the smooth construction of 45-degree traces. Using a double-diagonal cell allows two conductors to occupy one cell.

MULTITECH 900 ACCEL

FULLY IBM AT COMPATIBLE

FEATURES

- 6 MHz/10 MHz Operation
- 512K RAM Expandable to 1MB
- Also runs Xenix, Unix, Pick, Autocad and Network Systems
- Systems are fully tested and burned in for 48 hours
- 80286 Microprocessor
- MS DOS 3.2 and BASIC
- 1.2MB floppy disk drive
- Hard disk and floppy disk controller
- AT style keyboard
- Battery backup clock/calendar
- ROM BIOS
- Complete documentation
- Nationwide one-year limited warranty serviced by TRW

+ OPTIONS

- EGA monitor & EGA card \$659
- Softwhite monitor & card**\$219
- 360K floppy**\$99
- 30MB/40MB hard disk/\$549/\$649
- Multifunction 0-1.5MB EEMS \$219

CHIPS

- 64K/256K RAM Set*****\$10/30
- 8087-2 PC/XT 6MHz*****\$159
- 80287-8 AT 8MHz*****\$299
- 80287-10 AT/10MHz*****\$366



PERSONAL SYSTEM/2 MODEL 80 16MHZ 80386 \$3999

Product Blitzes

PCAM 8 MHZ TURBO SYSTEM

- Fully IBM compatible • One 360K floppy • 20MB hard disk • 8088, 8 MHz CPU • 4.77/8 MHz selectable • 640K memory • 150 watt power supply • AT style keyboard • MS DOS 3.2 • FCC class "B" approved • One year warranty

Hardware

Computers

IBM

- XT 256K 1 DR *\$1050
- AT 256K 1 DR **\$2395

COMPAQ

- Deskpro 286 12MHz*****\$2395

Deskpro 386

- 40 MB, 16MHz *\$4900
- 70 MB, 16MHz **\$5700
- 130MB, 16MHz **\$7475

Portable 256K *\$1644

Portable III

- Model 20 640K *\$4400
- Model 40 640K **\$4950

LapTop

Computer

NEC

- Multispeed **\$1495

TOSHIBA

- T 1100+*****\$1495

- T 3100*****\$2880

- External 5 1/4 ****\$399

Floppy Drives

- FUJITSU 360K**\$79

TEAC

- 55BV 360K *****\$99

- 1.2 MB *****\$129

TOSHIBA

- ND040 360K *****\$99

- 3.5" 720K *****\$129

Hard Disk

Drives

SEAGATE

- 20MB ST225 KIT \$359

- 30MB ST238 KIT \$399

- 40MB ST251 KIT \$649

- 30MB ST4038 **\$549

- 40MB ST4051 **\$649

- 80MB ST4096 **\$999

MINISCRIBE

- 40MB 28MLS (AT)

- + Software *****\$611

- 72MB 28MLS (AT)

- + Software *****\$990

TOSHIBA

- MK 43 92MB (AT)

- 25MLS/controller *****\$1292

- MK 56 130MB (AT)

- 25MLS/controller *****\$1350

- RLC controller makes drive 1 1/2 times larger

- Golden Bow *****\$99

- V Feature Deluxe, + Format Software

FUJITSU

- M2246 (AT) ****\$2090

- 170MB 33MLS

- With software & controller

Tape Backup

ALLOY

- 20/25MB For PC/XT or AT \$359

- 40MB For PC/XT or AT *\$499

- 60MB For PC/XT or AT Ext \$719

EVEREX

- 20MB

- INT/EXT**\$549/\$669

- 60MB

- INT/EXT**\$749/\$849

Graphics

Board

HERCULES

- Graphics + ***\$179

- CLONE Hercules \$94

- EVEREX Edge \$239

- STB Chauffer HT \$199

EGA Graphics

Card

ATI

- EGA WONDER \$259

- EGA, CGA, MBA, HERCULES 132 COL, on TTL, RGB, EGA monitor

NEC

- GB-1*****\$359

Monochrome

Monitor

SAMSUNG

- SM12SSA TTL * \$79

MULTITECH

- 14" Reversible, BK/W \$149

AMDEK

- 410A 132 Col ****\$165

Color Monitor

CTX

- 14" RGB *****\$269

- 640 x 200 (same as Multitech)

EGA Monitor

- NEC Multisync \$559

- Autoswitchable, 800 x 560, Wonderful display quality, Dot pitch .31

- with ATI Wonder* \$799

- with NEC GB-1**\$899

- with Vega Deluxe \$849

- SONY Multiscan \$599

- Autoswitchable, 900x560, Dot Pitch: 26

Plotter

HEWLETT

PACKARD

- 7475A *****\$1599

- 7550 *****\$3329

HOUSTON

INSTRUMENTS

- DMP 40 *****\$889

- DMP 42 *****\$2539

- DMP 52 *****\$3847

Full Screen

Monitor

MICRO DISPLAY

- Genius 402 * \$1295

- 8 1/2" x 11", 736x1008 Pixels, with control or

PRINCETON

- LM300 *****\$1049

- Portrait Display, 8 1/2" x 11", 1200 x 1664 pixels with controller

WYSE

- 700 /280x800 *****\$769

Printer

Dot Matrix

NEC 24 WIRE

- P9XL 400 CPS **\$1265

- P7 216 CPS *****\$651

- P6 216 CPS *****\$461

CITIZEN

- 120D 160 CPS **\$189

TOSHIBA 24 WIRE

- P321 *****\$459

- P341 *****\$573

- 132 col/216/72CPS

- 351C Model 2 \$1077

- 132 col/300/100/132 CPS

- P351 *****\$949

- 132 col/300/250/100CPS

PANASONIC

- 1080I 120CPS **\$217

- 1091I 160CPS **\$281

- 1592 180/38CPS \$439

- 1092I 240CPS **\$355

EPSON

- FX 86E *****\$429

- FX 286E *****\$599

- EX 800 *****\$499

- EX 1000 *****\$699

Printer—Laser

HEWLETT

PACKARD

Laser Jet

- Series II *****\$1899

- Gives you 8 Pages per min.

TOSHIBA

- Page Laser II \$2797

- 12 Pages per minute, Sixtimes the product life of Competition.

OKIDATA

- Laserline *****\$1600

- 6 Pages Per Minute

QMS Kiss

- Laser Printer **\$2495

- With J-Laser Board

KENSINGTON

- Printer Stand *****\$20

Memory

Expansion

MULTIFUNCTION

- PIS/C/G/OK *****\$89

DISK I/O*****\$89

- P/S/C/L/G + Floppy Controller

AST

- Sixpac Premium

- (256K) *****\$308

- Sixpac+ (384K) \$227

- Rampage PC * \$234

- 256K + Deskview

- Rampage AT **\$445

- 512K + Deskview

EVEREX

- 2 MB EMS ***\$129

Scanner

PRINCETON

- LS-300 *****\$1046

- Desktop Image Scanner with OCR Software. LS-300 Allows you to go from paper to PC with text, graphics and photos.

Modem

US ROBOTICS

- Direct 2400 Int.\$179

- Courier HST

- 9600 Baud ****\$699

- Direct 1200 Int.\$109

- 1200 External**\$115

- US Robotics provides the most advanced data communications devices in the world. The modems are Auto Answer/Auto Dial and Hayes compatible.

EVEREX/

HALF CARD

- 1200 INT with software *\$99

- 2400 INT with software \$199

Input

- Logic Mouse ***\$99

- Bus + Paint

Microsoft Mouse

- Paintbrush & Showpartner Bus/Ser \$109/119

Mouse Systems

- PCMouse *****\$109

- Bus + PC Paint

Power Supply

- 150 Watt (XT) * \$79

Software

Business

Software

- Aldus Pagemaker

- desk top publishing *****\$544

- Championship

- Football *****\$25

- Carbon Copy * \$110

- Cricknet Graph* \$129

- dBase III + ****\$399

- DOS 3.1/3.2 \$69/79

- Dow Jones, Market

- Analyzer Plus \$267

- Free lance + * \$356

- Lotus 123 V.2.0 \$305

- Mace Utilities *****\$

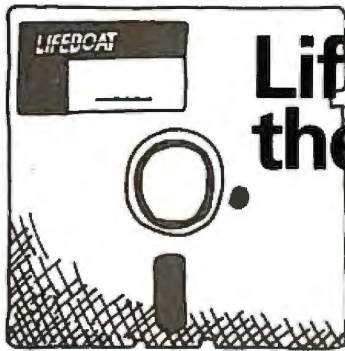

Lifeboat. Your best source for the best names in software.

ADVANTAGE C++

This new object-oriented language lets you develop large and complex programs with greater resilience, fewer bugs. Write reliable, reusable code that is easier to understand and maintain. Fully compatible with existing C programs and tools. All the benefits of C without its limitations. Available for Lattice and Microsoft C compilers; MS-DOS and XENIX operating systems.



Lattice C Compiler

The latest update of the ideal tool for developing high-performance MS-DOS applications in C. Full implementation of K&R C with UNIX and ANSI extensions. Offers the widest selection of C support tools. Now with Microsoft Windows support.



Microsoft FORTRAN

New version produces smallest, fastest PC code. Uses the same optimizer and code generator from the Microsoft C compiler. Full ANSI FORTRAN 77 compatibility. GSA-certified to be error-free at the highest level. Includes advanced intrinsic math functions, Microsoft's CodeView debugger, a MAKE utility, linker, library manager and many other enhancements.



TimeSlicer

A library of C functions to create multitasking and real-time programs at the application level rather than interfacing with the operating system. Create, suspend or terminate tasks at run-time. Compatible with Lattice C, Microsoft C, ADVANTAGE C++ and object-oriented programming.



Your source for the latest 80386 development software.

ADVANTAGE Link

The fastest, most powerful PC-DOS linker available, and the first to take full advantage of EMS. Accepts Microsoft and Phoenix command files, and is compatible with Microsoft CodeView.



VEDIT PLUS

For years, thousands of programmers have depended on VEDIT. If you take your editing seriously, take a good look at the all-new VEDIT PLUS.

Open windows to simultaneously edit several files. Access editing functions with pop-up menus. Use keystroke macros to speed editing. And run other programs within VEDIT PLUS—all with uncompromising speed, flexibility and power. VEDIT PLUS is completely customizable and available for MS/PC-DOS, CP/M 80/86. Ask for your FREE demo/tutorial disk.



Greenleaf Data Windows

A new concept C library containing overlaid logical windows, transaction data entry and three kinds of menu systems. Features virtual windows, many data types, device independence, total screen management and more. Simple to use, yet highly sophisticated. Supports all major compilers, all models, auto installation. Over 125 functions, no royalties, source available.



PANEL Plus

Advanced screen manager with a screen designer, code generator and function libraries. Works with popular graphics libraries to allow data entry in graphics modes. Includes full, portable library source code.



ADVANTAGE Make

Full featured. Supports UNIX MAKE scripts, multiple targets in single definition, full pathname, self-referencing macros. Many internally defined macros; i.e., \$, \$*, \$< and much more.



ADVANTAGE Disassembler

Provides immediate feedback as you work, storing results in tables on disk. Final output is ready for MS assembler. Handles .COM and .EXE files; 8086/186/286 code and 8087/287 coprocessors.



Pascal-2

Have you reached the limits of Turbo? Upgrade to Pascal-2 without loss. Easy migration path from Turbo with compatible strings, equivalent procedures and access to Turbo graphics. Cut execution time by 200% over Turbo. Use all of DOS-accessible memory through efficient, large memory model. Speed development time with sophisticated error checking and reporting. Call Microsoft languages. Plus interactive source-level debugger, error walkback, Intel CEL87 math library, high-level profiler.



Call today Scientific Solutions catalog!

Describes 100 of the best software packages for solving complex equations, number crunching, analyzing data and more.

Call **1-800-847-7078**

In NY **914-332-1875**

or see your local Lifeboat Affiliated Dealer

The Full-Service Source for Programming Software

LIFEBOAT

55 South Broadway
Tarrytown, NY 10591
Telex # 510-610-7602

The names of the products listed are generally the trademarks of the sources of the products.

INTERNATIONAL SALES OFFICES

Australia/New Zealand:
MoS Computer Software/
Charlton Distributors
Auckland (09) 766-361
Canada: Scantel Systems
Toronto (416) 449-9252
Denmark: Ravenholm
Copenhagen 288-7249

England: Grey Matter, Ltd.
Devon 364-53499
System Science, Ltd.
London (01) 248-0962
France: Compusol
Paris 14 530 0737
Italy: LifeboatAssociates Italia
Milan 02-464601

Japan: Lifeboat, Inc.
Tokyo 03-293-4711
SATT Software
Tokyo 03-295-3390
Netherlands: SCOS Automation BV
Amsterdam 020-10 69 22
Spain: Micronet, S.A.
Madrid 1-262-3304

Switzerland: Euro-Link
Zurich 813 514
West Germany: MEMA Computer GmbH
Frankfurt 069-347226
Omnitex
Rheinfelden 07623/61820

Keep in mind, Lee's Algorithm is not without its limitations.

quired to handle this "deadly" double diagonal are well beyond the scope of this article. Many special cases must be anticipated and handled, but the basic outline of the procedure remains the same.

Keep in mind that Lee's Algorithm as presented here only routes on one layer of the PCB at a time. Multilayer strategies are possible, and vias can be introduced to provide an electrical path between layers when required. (Vias are holes drilled through the circuit board, similar to the holes used to accommodate the pins of an IC.) The interior surface of the hole is plated with copper during manufacturing to provide an electrical connection.

Limitations

Using a 50-mil (0.050-inch) grid, Lee's Algorithm can be implemented as an interactive router on a personal computer. However, Lee's Algorithm is not without its limitations.

The time required to find a path between two points n cells apart is proportional to n^2 . For small n , this time is short and not of practical concern. But for large n , the search can take minutes. As a result, some commercial products make use of several routing algorithms.

The storage required to support the algorithm includes space for both the FIFO queue and the auxiliary array (the flag array). This is in addition to the space re-

quired to hold the representation of the conductors on the PC board. Using 3 bits to hold the eight values in each element of the flag array, assuming a 50-mil grid, and allowing for a maximum board size of 10 by 16 inches, the flag array requires 24K bytes. This is well within reason for a personal computer-based program.

But when you use a 10-mil grid, execution time for the router jumps by a factor of 25 ($5n \times 5n$). Storage requirements for the flag array go from 24K to 600K bytes. Going to a 1-mil grid produces astronomical numbers. A route that took 3 seconds to complete with a 50-mil grid now takes 2 hours (3 seconds \times 2500), assuming you could find a personal computer that will directly address 60 megabytes (just for the flag array). Obviously, routers that work with a grid finer than 50 mils use other algorithms.

Other Routing Algorithms

There are several other techniques that may be applied to the routing problem. Most fall into three or four broad categories. Each implementation is unique because of the data structures and heuristics implemented by the program authors.

A *channel router* alters the cell concept described for Lee's Algorithm. Instead of using small, fixed-size cells, the PC board is divided into large rectangles corresponding to the space between rows or columns of IC pins. These rectangles (or channels) are usually long and narrow; some can extend the length of the board. Each can hold several parallel traces.

The routing algorithm finds paths between source and target networks by assigning traces to channels, typically using vias to change sides of the board

when moving from one channel to the next. One interesting characteristic of this procedure is that the ordering or location of individual traces within a channel is not fixed until the routing of all traces is complete. As a result, a trace can be pushed up or down within a channel as other traces are added to that channel.

A *line-probe router* takes an entirely different approach to the data structure used for routing. Instead of organizing the storage by using cells or rectangles, the line-probe router only stores vertical or horizontal lines. These lines correspond either to conductors already in place on the PC board or to other obstructions (e.g., the edge of the board).

To determine if a horizontal trace can be placed in a particular spot, the algorithm checks that the route is not blocked by vertical lines. Similarly, the location of a proposed vertical trace is checked against the existing horizontal conductors. With proper organization of the data, this check can occur very quickly.

The general strategy is to "probe" by constructing a sequence of line segments starting at both source and target points. When two segments from the two sequences intersect, a path from source to target has been found. A retrace procedure is then applied to draw the trace and insert the necessary vias.

While not guaranteed to find the shortest route, nor even guaranteed to find a route if one exists, both the channel and line-probe routers take much less storage and execute more rapidly than Lee's Algorithm on a small grid.

Other ad hoc algorithms are also widely used. For example, routing of ICs with

continued

DataSaver[®] Standby UPS

90 Watt. The original micro-UPS that brought standby AC power to Apple users in 1980. Still the POWER SOLUTION for serious applications of the MAC, small micros, and portables.
Model 9012060 \$350. FCC(15A&B).

400 Watt. Now, POWER PROTECTION and MASTER CONTROL for full-size micros. Filters electrical noise/spikes and provides up to 10 minutes of AC power for the AT and supermicros.
Model 40012060 \$695. UL-E101268.

200 Watt. This DataSaver standby UPS offers compact, cool and quiet line conditioning and backup power to PC, XT, and COMPAQ markets. Data and hardware are protected.
Model 20012060 \$495. CSA-LR51253.



Cuesta Systems Corporation
3440 Roberto Court
San Luis Obispo, California 93401

© 1986. Made with pride in the U.S.A.
805/541-4160 TLX:4949381 CUESTA
Dealer, VAR, & OEM inquiries invited.

many pins wired in parallel (e.g., the address and data pins of a memory array) may require special techniques to guarantee success. Routing of power and ground conductors or the use of separate power and ground planes may also require special handling.

Auto-routers

As mentioned earlier, an auto-router iterates through a list of connections to be made, using one or more of the algorithms discussed above to complete traces one at a time. Large, complex boards may require days to auto-route using sophisticated algorithms on mainframe or superminicomputers. Nonetheless, auto-router packages for personal computers are gaining widespread use.

An auto-router normally starts with a netlist: a list of all the electrical networks in a design, with all the sublists of pins that should be connected in each network. The netlist can be generated by hand (and frequently was 10 years ago), but the most common approach is to use a schematic-capture program. This approach eliminates transcription errors, although it does not eliminate errors in the schematic.

The auto-router reads this list and,

using information specifying the location of each component, generates a wirelist. The wirelist is a pair-wise listing of source and target points that need to be connected. Each network in the netlist is analyzed to determine the minimum set of line segments required to connect each pin in the network. The line segments are chosen so that the sum of their lengths is as short as possible.

Once the wirelist has been constructed, each pair of points to be routed must be assigned to a layer of the PC board, and the routing order must be decided. A number of techniques are in common use, however, short routes are usually tried before long routes, and horizontal or vertical paths are routed before diagonal ones. Different routing algorithms may be used, depending on the relative locations of the two points to be connected.

The success of an auto-router, as measured by its completion percentage, depends on a wide variety of factors. These include board density, component placement, ratio of random to parallel connections, number of layers allowed, number of vias employed, the routing algorithms, and the ordering of the wirelist.

Market pressures are forcing the appli-

cation of more sophisticated electronics across a wide spectrum of applications. The time allowed for design and testing continues to shrink. Fortunately, the emergence of low-cost CAD tools and the increasing computational power and storage available in personal computers is combining to give engineers and other designers the tools they need to meet the challenge. A program for aiding in the layout and routing of PC boards is one of these important tools. ■

BIBLIOGRAPHY

- Ginsberg, G., et al. "An Updated Multi-layer Printed Wiring CAD Capability." *Proceedings of the Design Automation Workshop*, 1969, pages 145-154.
- Hashimoto, A., and J. Stevens. "Wire Routing by Optimizing Channel Assignment within Large Apertures." *Proceedings of the Design Automation Workshop*, 1969, pages 155-169.
- Hightower, D. "A Solution to Line-Routing Problems on the Continuous Plane." *Proceedings of the Design Automation Workshop*, 1969, pages 1-24.
- Lee, C. Y. "An Algorithm for Path Connections and Its Applications." *IRE Transactions on Electronic Computers*, September 1961, pages 346-365.

CMOS Little Board™/PC

Ideally suited for embedded microcomputer applications where IBM® PC software and bus compatibility are required and low power, small size, and high reliability are critical.

- File servers
- Diskless workstations
- Portable instruments
- Remote data logging
- Protocol conversion
- Point-of-sale terminals
- Telecommunications
- Industrial process control
- Distributed processing
- Harsh environments

SCSI BUS INTERFACE
(HARD DISK, ETC)

MATH
CO-PROCESSOR
OPTION

768 K RAM

POWERFUL
V40 CPU

FLOPPY DISK CONTROLLER
(3.5"/5.25",
360 K/720 K, 1.2 MB)

UP TO 128 K
EPROM/RAM/NOVRAM
BATTERY BACKED RT CLOCK

MOUNTS ON A
5.25" DRIVE
(5.75"x8"x1")

5 VOLT ONLY OPERATION
3 WATTS!

2 RS232C
SERIAL PORTS

SPEAKER PORT

KEYBOARD PORT

PARALLEL
PRINTER PORT

PL BUS

4 MODE VIDEO
CONTROLLER
OPTION
(MONOCHROME,
HERCULES, CGA,
HIGH RES CGA)

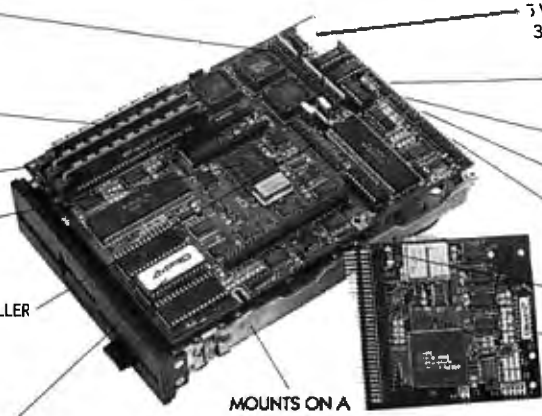

MS-DOS Microsoft Corp.

BOOTS PC-DOS/MS DOS



67 East Evelyn Avenue • Post Office Box 390427, Mountain View, CA 94039 • (415) 962-0230 • TLX 4940302

Distributors • **Argentina:** Factorial, S.A. 41-0018 • **Australia:** Current Solutions (03) 277-5959 • **Belgium:** Centre Electronique Lempereur (041) 23-45-41 • **Brazil:** Computadores Compuleader (41) 262-4866 • **Canada:** Tri-M (604) 438-0028 • **Denmark:** Danbit (03) 66 20 20 • **Finland:** Symmetric OY 358- 585-322 • **France:** Egal Plus (1) 4502-1800 • **Germany, West:** IST-Elektronik Vertriebs GmbH 089-611-6151 • **Israel:** Alpha Terminals, Ltd. (03) 49-16-95 • **Spain:** Hardware & Software 204-2099 • **Sweden:** AB Akta (08) 54-20-20 • **UK:** Ambar Systems Ltd. 0296 43551 • **USA:** Contact Ampro

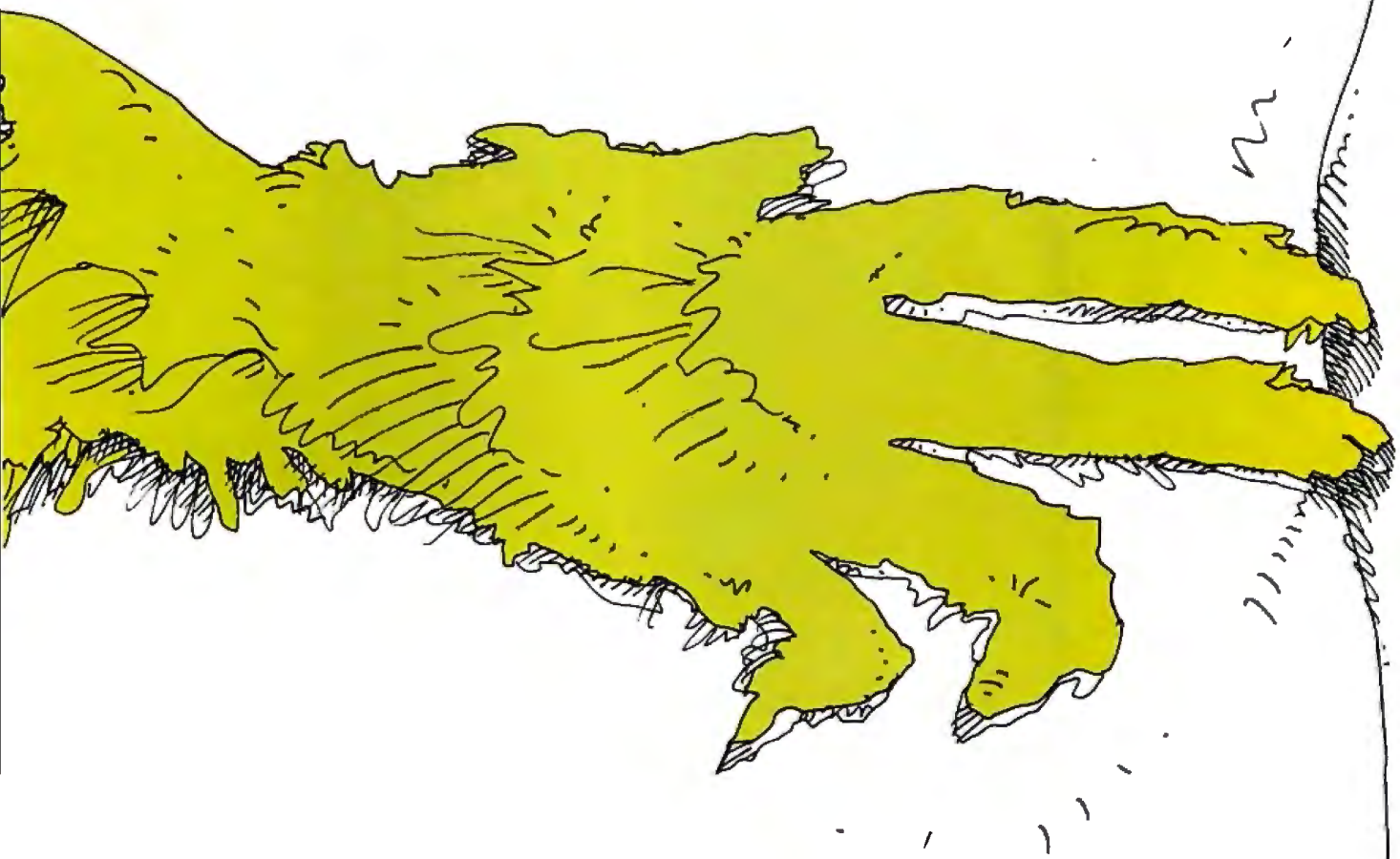

Horror

Brace yourself.
Be prepared for some tales that'll make
your flesh creep and your
blood run cold.

The problem comes
about in many ways.
Inadvertent com-
mand error. System
breakdown.

Power source failure. Whatever.
The problem is data loss.

And it led to these true-to-life
stories of unending horror that
could make you start
regretting every moment
you forgot to back up that
important data of yours.
Read 'em and weep...



True-to-life
stories of
men and women
who didn't do
their computer
backup

and
lived to
regret it.

Stories.

Once upon a time there was a guy, let's call him Joe, who set up shop in the market research business.

He had a very small office, one corner of which was set aside for his computer.

Then one evening Joe got a visit from the data-crash monster.

It happened like this.

When he worked on the computer, Joe kept his diskettes next to him... in a shoe box, on top of a covered trash bin which doubled as a table top until he could get around to finishing the furnishings.

Each night before he left, he put the shoe box away in the desk drawer.

Every night but one.

Nearing completion of his first major research project, one evening Joe went home without remembering to take the diskettes off the trash bin.

The cleaning people took his diskettes out with the trash.

Oh, Joe was able to duplicate it, all right. In a mere three months.

Joe now backs up everything but the laundry marks on his shirts.

So the monster got discouraged and went on to other victims.

Kurt, a playwright, was working on the last act of his new play, which had been in rehearsal for six weeks. After various rewrites, Kurt was still agonizing over the right ending.

Two days short of opening

night, Kurt finally came up with the ending he wanted. He sat down to his computer and cranked it out.

After a few hours, when it was just about finished, the phone rang. As he

reached over to pick up the phone he somehow kicked the plug to the computer, and out of the socket it came.

(Kicking out plugs is one of the monster's specialties.)

Crash. That was the end of the ending.

Devastated because he knew he could never in a million years recreate it, he called the director and quit the show. The show never did open.

Finally, there's a horror story that actually happened to the writer of this copy.

I put together a compilation of idiomatic clichés once, with an eye to getting it published as a reference book.

In a move to another city I shipped some boxes ahead to be held by the hotel for my arrival.

Including one with the only copy of my book in it. Before my arrival it got lost in the shuffle.

Reconstructing the whole book was about as appealing as wrestling a jellyfish.

Scratch one book.

But if you think those horror stories are bad, you don't know the half of it...

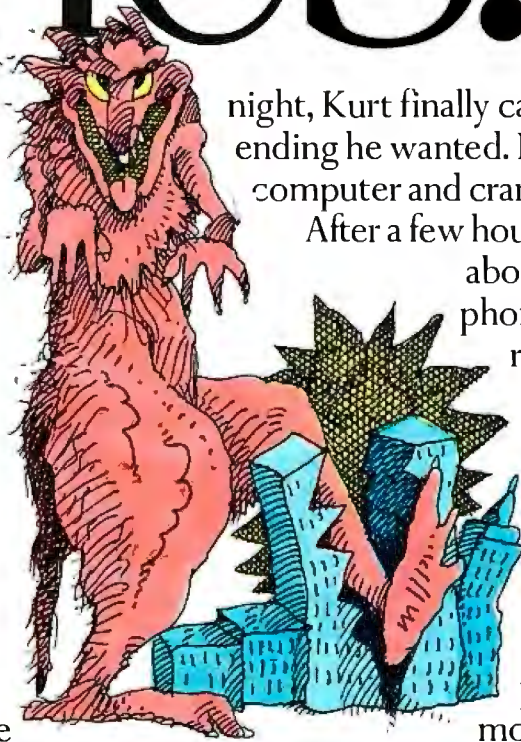

Behind every horror
horror story wa



or story is another biting to happen.

Never relax your guard when dealing with the data-loss monster. Even if you've done your backup.

He has a one-two punch, you see.

He not only mauls the data you *don't* back up, he can also rip to shreds data you *do* back up.

Because those hard disks you're backing up aren't the only things that can suffer data loss, you know.

The backup media itself can have data loss, as the following gruesome details will show.

Data cassettes and video cassettes have an Achilles' heel monsters thrive on.

Their rollers and tensioners lack an independent support, and instead are part of the drive. **Alignment** problems may be the result.

Which means slipping and jamming.

Which means data loss.

Which means another victory for the insatiable data gobbler.

Don't go fleeing to floppies or backup software for mass storage protection, either. The Cruncher will mash them between his paws without half trying.

Floppies are great for

what floppies are for. Including even a little backup. But for backing up a lot of data, you'll not only get a tired arm slugging the things in and out of your PC, you'll get too much risk of crunching, crushing and creasing (deeds that data gremlins delight in perpetrating).

Imagine. You can even mess up your data by a simple fingerprint at the floppy's sausage-shaped opening. And if a fingerprint can mess things up, imagine what the big guy can do to your data with all his digits and limbs going at it.

Finally, some people are trying to outfox the monster by using a second hard disk that they only turn on when they need to use it.

That's like protecting your home with a burglar alarm that's not turned on all the time.

Turning on the second disk some of the time just means it's only at risk some of the time. It improves your odds, but you're still at risk.

And if that hard disk isn't the removable kind, fate could remove some of your data in a generalized problem like a fire at the office that could sabotage both your backup and main disk.

So what do you do, surrender?

No, you turn the page...

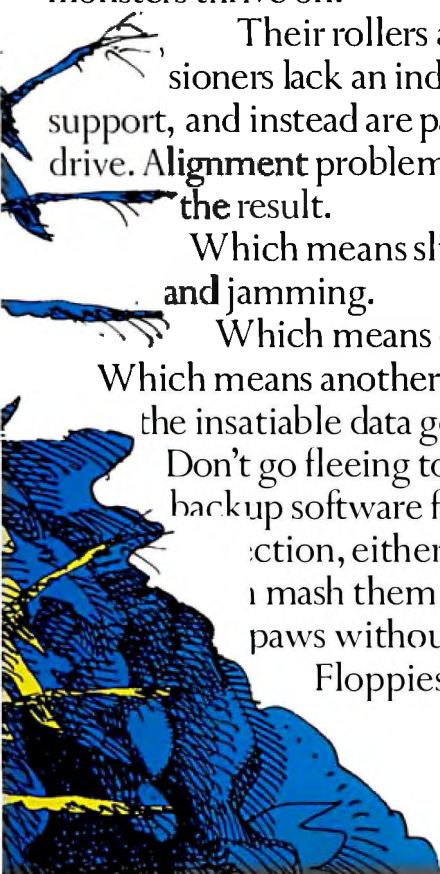
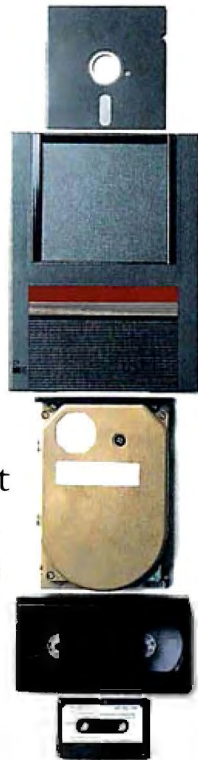

The monster

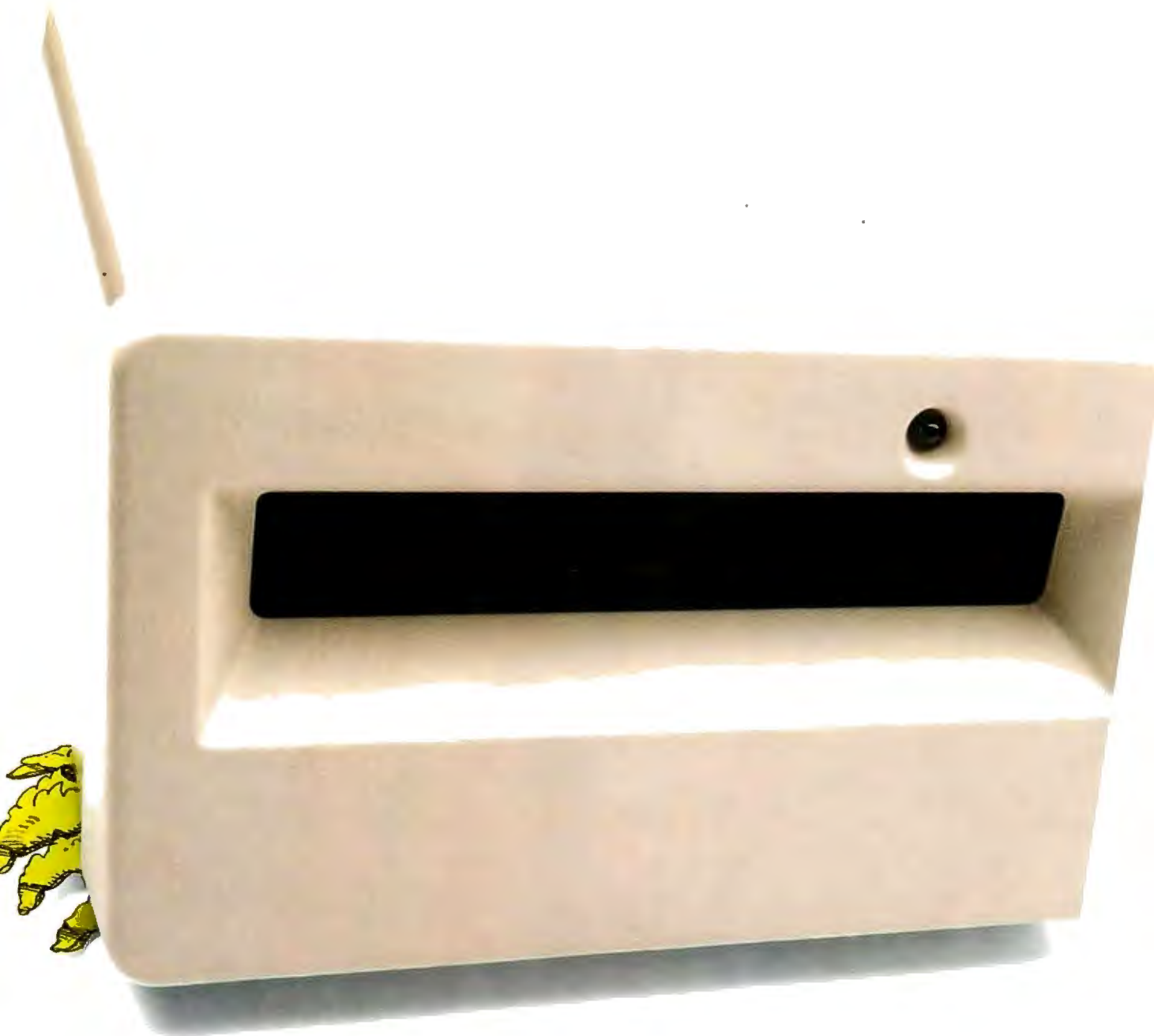

meets his match.

All good monster stories have happy endings where the beast gets his just desserts, and this story is no exception.

3M has figured out a way for you to exorcise the demons of data destruction.

Data cartridge tape.

An inexpensive, easy-to-use way to store lots of stuff in very little space.

A cartridge is only 5¼" tall (its little brother is only 3½") but it keeps the data-loss monster at bay better than anybody.

Data cartridge tape is less expensive than half-inch tape or the removable, rigid disk-based systems. And in fact offers a lower cost per

megabyte than any other type of removable mass storage for the PC user.

More storage capacity, too.

Up to 150 megabytes.

The tape itself is fully enclosed in a tough plastic shell that data-loss monsters find particularly frustrating. It stands up to rough handling, and thus can survive monstrous attacks that floppies can't.

You don't have to worry about data-loss problems from improper handling of the tape, because you don't handle the tape. It stays put in the cartridge.

The tape is further protected by a built-in metal plate that supports the rollers and tensioners. This precisely controls the tape

alignment, preventing slipping and jamming of the tape — something which can cause data loss in cassettes. There's also a little protective "shutter door" that cassettes don't have, which closes over the tape when the cartridge is disengaged.

All of which pretty much does the data-loss monster in.

Leaving you with unequalled reliability, economy and convenience.

What more could you want in data backup? Not to mention

data cartridge's other functions, such as archival storage, data-base distribution, software distribution, transaction logging, image storage, and data acquisition.

Finding the hardware isn't hard.

3M invented data cartridge technology to meet the needs of mass storage. And more and more manufacturers (over 150 at last count) are utilizing it in their designed-in cartridge drives and plug-compatible subsystems.

For a list of manufacturers who can answer your questions about data cartridge technology, turn the page.

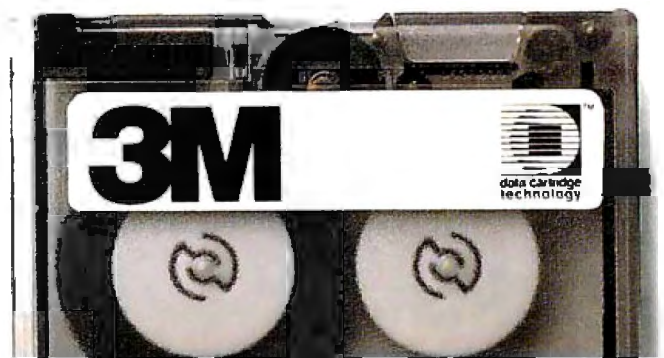
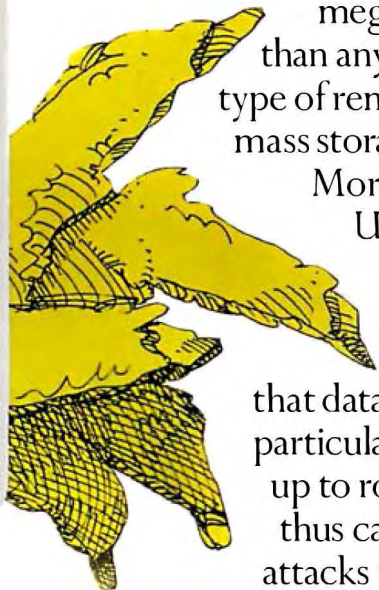
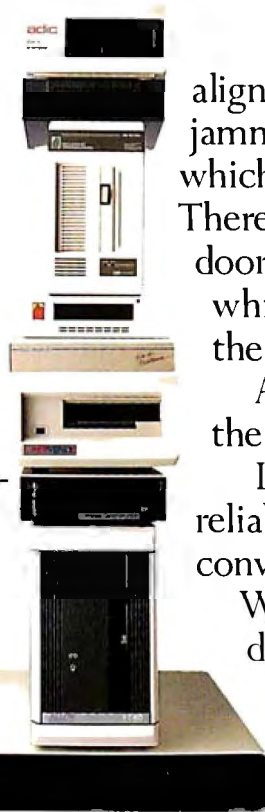

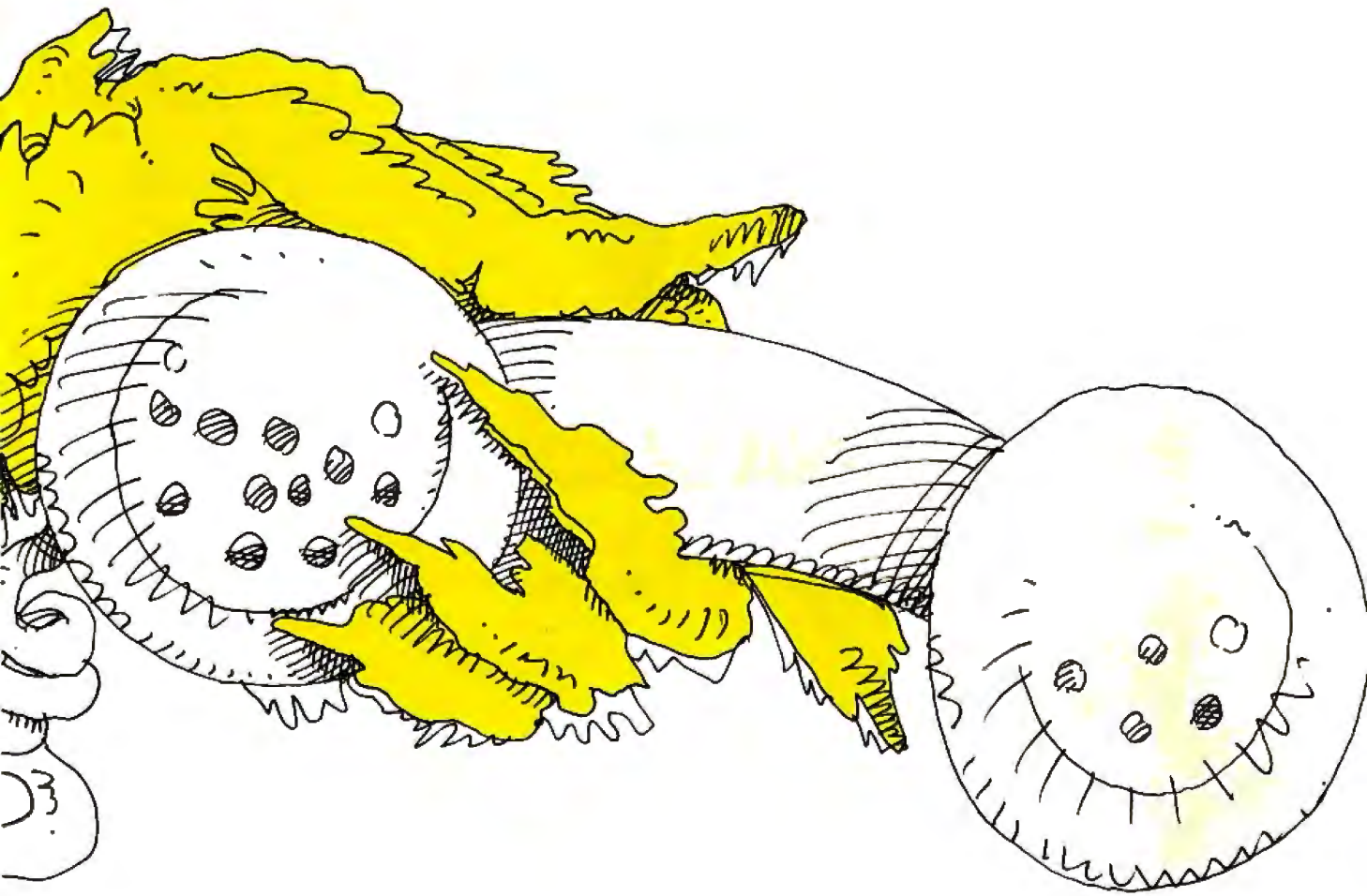

(800) 423-3280
(And woe be to the monster.)

IGES

One answer to the problems of CAD database exchange

Ralph J. Mayer

IGES (INITIAL GRAPHICS Exchange Specification) has gained worldwide acceptance as the most popular method of moving data from one CAD system to another. IGES was developed in 1979 under the leadership of the National Bureau of Standards, whose goal was to facilitate the transfer of product definition data between different CAD systems. Version 1.0 of IGES was published as part of an ANSI standard in 1981. Version 2.0 was published in 1982, and version 3.0 in 1986.

Data transfer using IGES has been demonstrated at many trade shows, and the IGES organization has grown from its original three developers to a volunteer organization of over 600 people and over 100 companies and other organizations. IGES also has its detractors, however, who claim that it does not work as well as it should and that there are better alternatives. The controversy surrounding IGES is likely to continue as CAD users are only now beginning to appreciate the technical and management issues regarding database transfer.

Technical Overview

Designed originally to avoid problems encountered during the 1970s with the proliferation of direct translators, IGES uses the neutral file concept. Writing direct translators between four different systems requires 12 different translators (see figure 1). Adding a fifth system adds eight additional translators, and the number of translators continues to go up geometrically with the number of systems. Conversely, translation using a neutral

file is done from one native format to the neutral file and then to another native format (see figure 2). For four systems, eight translators are required. Each system added will require only two more translators.

A side benefit of neutral files is that they can potentially be archived. Some companies in the aerospace industry, for example, need to keep CAD databases for 20 to 50 years. The IGES organization has a commitment to upward compatibility so that IGES files created today can be read by new CAD systems as they are developed.

IGES itself is just a document describing what should go into a data file. Developers must write software to translate from their system to the IGES format, or vice versa. The software that translates from a CAD system to IGES is called a preprocessor. The software that goes the other way (translates from IGES to a CAD system) is called a postprocessor (see figure 3). The preprocessors and postprocessors determine the success of an IGES translation.

Like most CAD systems, IGES is based on the concept of entities. Entities range from simple geometric objects, such as points, lines, and circles, to more sophisticated entities, such as dimensions, subfigures, and sculptured surfaces. Entities in IGES are divided into three categories: geometry, annotation, and structure. Geometry entities, such as lines, circles, and surfaces, define an object. Annotation entities include dimensions, notes, title block, and so forth that aid in visualization and documentation of

the object. Structure entities consist of the various ways CAD systems combine other entities to make descriptions easier.

An example of a structure entity is a subfigure (also called a block, a cell, or a ditto in various CAD systems), which might be used to combine all the curves of a wheel into a single subfigure entity. You could place the subfigure entity four times on a drawing of a car without making four copies of all the individual entities that make up the wheel.

In its beginning, IGES was only defined in an ASCII, user-readable format using 80-character records. To create smaller files (IGES file sizes are typically 5 to 10 times the size of CAD native databases), a binary format and a compressed ASCII format have been defined, but the majority of IGES processors still only support the original ASCII form.

The files are divided into five sections: start, global, directory entry, parameter data, and terminate (see figure 4). The start section is just readable text at the start of the file used for documentation. The global section is 24 parameters of a global nature, such as the name of the file, its author, date of creation, units of measurement, precision of the numbers in the file, and so on. The directory entry (DE) section contains data that is common for each entity in the file, such as its type, color, line style, layer, views it's

continued

Ralph J. Mayer is an original employee of Adra Systems Inc. (59 Technology Dr., Lowell, MA 01857), and he is now director of software.

visible in, and a transformation matrix used to position the entity in three dimensions.

The parameter data (PD) section contains specific entity information. For lines, it's the x,y,z endpoints; for surfaces, it's the x,y,z locations and definition vectors that describe the surface. There are two lines in the DE section for each entity, and one or more lines in the PD section for each entity. Since IGES files typically contain thousands of entities, these sections constitute the bulk of the file. The terminate section is a single line at the end of the file that contains the number of records (or lines) in each section.

The IGES document describes formats for about 50 different entities, many of which have alternate forms, resulting in about 150 possible formats. All entities have the same data defined in the DE section. They have unique formats for the PD section. The data in the PD section can range from the x,y,z values that define a point to hundreds of values that define a sculptured surface. Some entities contain text that is used in dimensions or notes on a drawing. Entities can also reference other entities, allowing you to build structures.

The entities in version 1.0 of IGES

were basically wire-frame entities and some surfaces, typically those found in the CAD systems of the late 1970s. IGES has grown since then, and version 3.0 includes not only additional surfaces, but entities for specific applications such as finite element modeling (FEM), electrical diagrams, printed circuit board design, piping, and architectural design. Version 4.0, which is due in 1987, will also support solids. In general, IGES tends to be a superset of the data found in existing CAD systems.

Current Status

IGES is supported by over 30 CAD vendors. It is generally the first method attempted by developers trying to move CAD data from one system to another. However, it has not lived up to some expectations, although many of those expectations were unrealistic. The expectation is that a user can take any CAD file, translate it into IGES, read the IGES file into another CAD system, and have 100 percent of the data transferred, including resolution of system differences. In real life some transfers are 100 percent, some are still zero (i.e., one or more translators failed), and most lie somewhere in between. It is difficult to give an average figure since the success rate depends on

the IGES processors used and the types of entities in the file to be translated.

The quality of IGES processors varies widely. Some processors handle surfaces and complicated structures, whereas others handle little more than lines, points, and circles. Some processors are flexible and have options to facilitate reading files from different types of systems. Other processors can read only the files they output. Obviously, some of the success depends on the type of systems; two mechanical three-dimensional systems, for example, should have more in common than a solids system and a two-dimensional system, or a mechanical CAD system and an electrical CAD system.

Most IGES processors, however, do handle points, lines, and circles. Since these three entities constitute the majority of any CAD database, you generally get something to view—perhaps only part of the original drawing. Support for other entities varies widely. Unfortunately, there is no way to know what will happen in advance. Some entities may be missing; other entities may be modified, and the only way to be certain is to run fairly exhaustive tests.

After the file has been transferred, you must evaluate the IGES translation itself. A good procedure is to create three types of test files. The first test consists of simple parts—lines, points, and circles. These parts provide a baseline of what works. The second test is a grid. Make a series of boxes and in each box put one entity, such as a line, a circle, or a text string. This test makes it easy to see which entity types are successfully transferred and which entities are missing. The third test uses a normal production part. Although using "real" data is best, it is also the most difficult to evaluate.

The most important method of evaluating an IGES transfer is to compare two plots—one from before the transfer and the other from the system it was transferred to. This is best done on a light table and is easier to evaluate if the plots are in different colors. Another method is to list out positions and counts of entities on the two systems to check that all the data is transferred and is in the same place. You should also try manipulating the data—edit text strings or dimensions, scale views, and move some of the geometric objects. Curves can be tested by creating a series of parallel lines that intersect the curve. The intersection points of the lines and the curve can be calculated on both systems and should be equal. Similarly, surface transfer can be evaluated by using parallel planes.

Many of the problems with IGES are caused by the way in which it is imple-

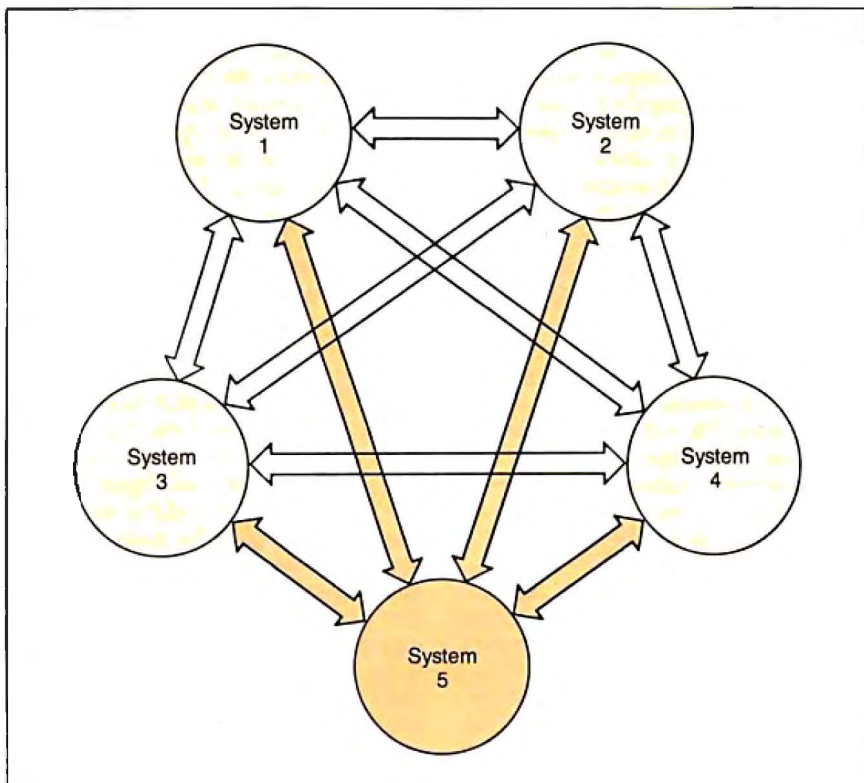

Figure 1: Writing direct translators between four different systems requires 12 different translators. Adding a fifth system adds eight additional translators, and the number of translators continues to go up geometrically with the number of systems.

mented. Each CAD developer implements its own IGES processor, and some simply do a better job than others. After all, the IGES organization is a voluntary one, and developers implement as much (or as little) of the specification as they see fit. Because of the large variety of data defined in IGES, no developer supports even close to all of the specification; in fact, the majority probably support less than half. To make matters worse, the problem is compounded by inevitable differences in interpretation and even bugs in software.

Also a problem is finding an agency to certify IGES processors. The National Bureau of Standards runs the IGES organization, but its charter prohibits it from any action that would smack of certification. And in light of current legal issues, no standards organization wants to say that a company's product does or does not meet a particular standard. Instead, the IGES organization is working with the Society of Automotive Engineers (SAE) to develop a validation program. Under the program, the SAE will certify that an IGES processor works as well as the developer claims. The program is scheduled to start this summer. The test data used for it will be in the public domain and available for any IGES user or developer interested in testing an IGES processor. Meanwhile, IGES implementation is dependent on the developers, who are not eager to implement IGES.

Yet there are some organizations trying to bring order into the confusion surrounding IGES. These are the large CAD users who want IGES to succeed. Prominent among them are the U.S. Navy, General Motors, Boeing, Pratt and Whitney, Hughes Aircraft, and the Department of Energy. These companies or departments have issued a simple edict: Support IGES or we won't buy your CAD system.

Alternatives

Even though the need to do CAD transfer is great, IGES has not been a perfect answer, and a number of alternatives—each with its own strengths and weaknesses—exist or are planned.

The first alternative is a direct translator, which goes through only one translation (IGES goes through two) and is not limited by IGES if the two CAD systems sharing data have capabilities not supported by IGES. However, a direct translator is usually written by one CAD developer to work with another developer's system, so there may be a lack of knowledge about at least one system. This knowledge can be obtained (often by reverse engineering) but is frequently incomplete. IGES translators, on the other

hand, are usually written by the developer of the CAD system. The developer has full knowledge of that system and is in a position to easily keep pace with changes and improvements in it. Nonetheless, direct translators will continue to prosper as they satisfy specific market niches not met by IGES.

The second alternative is an external database format such as DXF (from AutoCAD) or SIF (from Intergraph). External formats are created by many CAD vendors to provide a way for their users to access the CAD database. The external database format is generally similar to the vendor's internal database format but is designed for ease of access and is unlikely to change. These formats are primarily created for users who write specialized applications. Mostly due to marketing clout, some of these external formats are sometimes considered "standards."

The disadvantage of these external formats is that they tend to be parochial. If the CAD system does not support a particular entity, then in most cases its external format doesn't contain it either. For example, AutoCAD, and by extension DXF, does not have a dimension entity or a spline entity. Inasmuch as most CAD systems do have dimensions and spline entities, that data would be lost using

DXF as an exchange format. An industry-wide standard such as IGES defines virtually all the data types created by any CAD system.

A third possible alternative to IGES is Specifications du Standard D'Echange et de Transfert (SET), a neutral file format that contains essentially the same data types as IGES. SET was written by Aerospatiale, the French aerospace company, which has made sure that all the translators work together. The main advantage of SET is its file format, which is much more compact than IGES.

For example, consider the sample IGES file discussed on page 212; it contains a dimension entity that actually consists of six entities (the dimension entity, the text entity, two leader entities, and two extension line entities). These six entities take up considerable space (1840 bytes) and require a lot of processing time to create and decipher. SET, on the other hand, uses the concept of blocks (equivalent to IGES entities) and subblocks. A dimension block in SET contains the data found in the IGES DE section, along with five subblocks containing the text, two leader lines, and two extension lines. Aerospatiale claims that this arrangement results in both substantially smaller files

continued

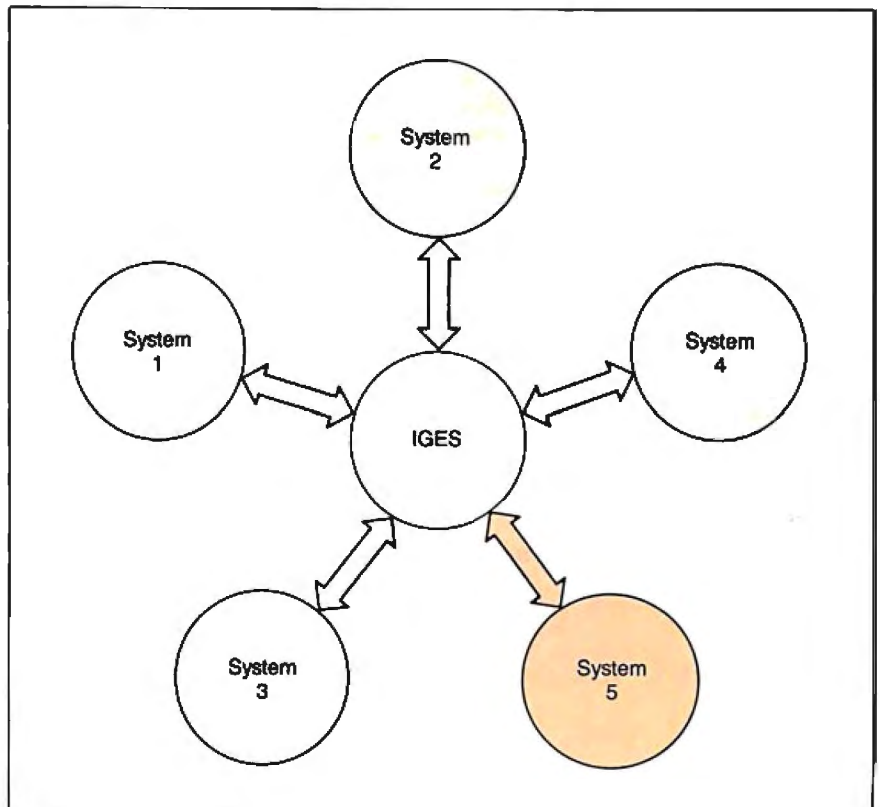

Figure 2: Translation using a neutral file is done from one native format to the neutral file and then to another native format. For four systems, eight translators are required. Each system added will require only two more translators.

A Sample IGES File

In the sample IGES file (see listing A), five sections are defined by an S, G, D, P, or T in column 72. The start section for this file is contained in lines 1 and 2, the global section in lines 3 through 6, the DE section in lines 7 through 48, the PD section in lines 49 through 75, and the terminate section in line 76. The global section contains information on the processor that generated the file, that the file adheres to IGES version 3.0, that the part is measured in inches, plus other values.

The file contains 21 entities. Entity 1 has its DE section on lines 7 and 8, and its PD section on line 49. The number 406 present on all three lines identifies it as a property entity. The other entity types in the file are: 410 for view entity, 116 for point, 100 for arc, 106 for copious data (used for dimension extension lines), 214 for leader arrow (used for dimension leader lines), 212 for general note (or text), 216 for linear dimension, 110 for line, and 404 for drawing. The data stored in the sample file represents a rectangle from (1, 1) to (3, 2) with a circle of radius 0.2 at its center and a dimension on its top edge (see figure A).

To understand a little more about the structure, examine line 7. The 1 following the 406 indicates that the PD section for this entity is at PD:1 (or line 49). Similarly, in line 49 the 1 in column 71 (just before the P) indicates that the DE section for this entity is at DE:1 (or line 7). Other entities have corresponding values. Looking at the entity content, examine the line entity defined at DE:29 and 30, PD:21 (lines 35 and 36). The

values from left to right in the DE section have the following meaning (note that the blank columns are equivalent to zeros):

```

110 Line entity
21 PD data is on line PD:21
Blank No structure
1 Line font 1, which is sold
0 Is on level (or layer) □
3 Is only visible in the view defined at DE line 3
Blank No transformation matrix
Blank No label display
0 Status is 0
D 29 DE line 29
110 Line entity (again)
2 Line weight is 2
5 Color 5, which is yellow
1 Entity has one line of PD data
Blank Form 0
Blank Not currently used
Blank Not currently used
Blank No label
Blank No subscript
D 30 DE line 30
    
```

The PD values have the following meaning:

```

110 Line entity
3.0 X1
2.0 Y1
0.0 Z1
3.0 X2
1.0 Y2
0.0 Z2
0 No associated entities
0 No properties
    
```

A very different type of entity is the linear dimension at DE:25 through 26 and PD:16. The DE data will be equivalent to that of the line entity, but its PD data is defined as follows (the other entities have their data defined in similar ways):

```

216 Entity type is linear dimension
17 DE value of general note entity with dimension text
15 DE value of first leader arrow entity
13 DE value of second leader arrow entity
11 DE value of first copious data entity with dimension extension line
9 DE value of second copious data
0 No associated entities
0 No properties
    
```

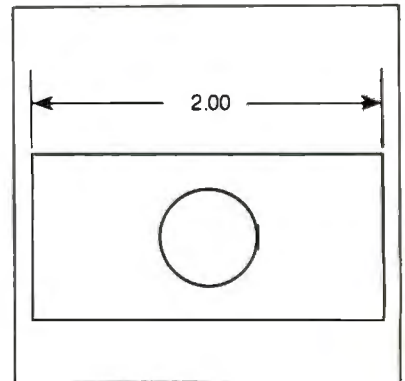

Figure A: Drawing from the sample IGES file.

Listing A: A sample IGES file.

```

THIS IGES TEST FILE WAS GENERATED BY ADRA SYSTEMS INC.
FOR BYTE MAGAZINE
1H,,1H;..15HADRA IGES DEMO[,56HADRA SYSTEMS CADRA-II IGES REV 1.0DEVELOPG
MENT ,16HIGES VERSION 3.0,32,8,24,8,56,,1.000000,1,4HINCH,3, G
0.030000,13H870219.120500,5.000000E-04,8.507059E+37,17HCADRA-II OPERATORG
,13HCADRA-II SITE,4,0;
406 1 0 1 15 10300D 1
406 0 1 0 15 D 2
410 2 0 1 0 10100D 3
410 0 1 1 0 D 4
116 3 1 0 3 0D 5
    
```

116	2	5	1			D	6
100	4		1	0	3	0D	7
100	2	5	2			D	8
106	6			0		10100D	9
106		0	2	40		D	10
106	8			0		10100D	11
106		0	2	40		D	12
214	10			0		10100D	13
214		0	2	2		D	14
214	12			0		10100D	15
214		0	2	2		D	16
212	14			0		10100D	17
212		0	2			D	18
216	16		1	0	3	100D	19
216	2	5	1			D	20
116	17		1	0	3	0D	21
116	2	5	1			D	22
116	18		1	0	3	0D	23
116	2	5	1			D	24
116	19		1	0	3	0D	25
116	2	5	1			D	26
116	20		1	0	3	0D	27
116	2	5	1			D	28
110	21		1	0	3	0D	29
110	2	5	1			D	30
110	22		1	0	3	0D	31
110	2	5	1			D	32
110	23		1	0	3	0D	33
110	2	5	1			D	34
110	24		1	0	3	0D	35
110	2	5	1			D	36
406	25			0		10300D	37
406		0	1	15		D	38
406	26			0		10300D	39
406		0	1	16		D	40
404	27			0		101D	41
404		0	1			D	42
406,1,3HTOP,0,0;						1P	1
410,1,1.000000,0,0,0,0,0,0,1,1;						3P	2
116,2.000000,1.500000,0,0,0,0;						5P	3
100,0,0,2.000000,1.500000,2.200000,1.500000,2.200000,1.500000,0,0;						7P	4
						7P	5
106,1,3,0,0,1.000000,2.000000,1.000000,2.000000,1.000000,2.874256,0,0;						9P	6
						9P	7
106,1,3,0,0,3.000000,2.000000,3.000000,2.000000,3.000000,2.874256,0,0;						11P	8
						11P	9
214,1,0.156000,0.062061,0,0,3.000000,2.724256,2.307130,2.724256,0,0;						13P	10
						13P	11
214,1,0.156000,0.062061,0,0,1.000000,2.724256,1.568844,2.724256,0,0;						15P	12
						15P	13
212,1,4,0.582286,0.156000,1,1.570796,0,0,0,1.646844,2.646256,0,0,4H2.00,0,0;						17P	14
						17P	15
216,17,15,13,11,9,0,0;						19P	16
116,3.000000,1.000000,0,0,0,0;						21P	17
116,3.000000,2.000000,0,0,0,0;						23P	18
116,1.000000,2.000000,0,0,0,0;						25P	19
116,1.000000,1.000000,0,0,0,0;						27P	20
110,3.000000,2.000000,0,0,3.000000,1.000000,0,0,0,0;						29P	21
110,1.000000,2.000000,0,0,3.000000,2.000000,0,0,0,0;						31P	22
110,1.000000,1.000000,0,0,1.000000,2.000000,0,0,0,0;						33P	23
110,1.000000,1.000000,0,0,3.000000,1.000000,0,0,0,0;						35P	24
406,1,7HDRAWING,0,0;						37P	25
406,2,5.000000,5.000000,0,0;						39P	26
404,1,3,0,0,0,0,0,2,37,39;						41P	27
S	2G	4D	42P	27		T	1

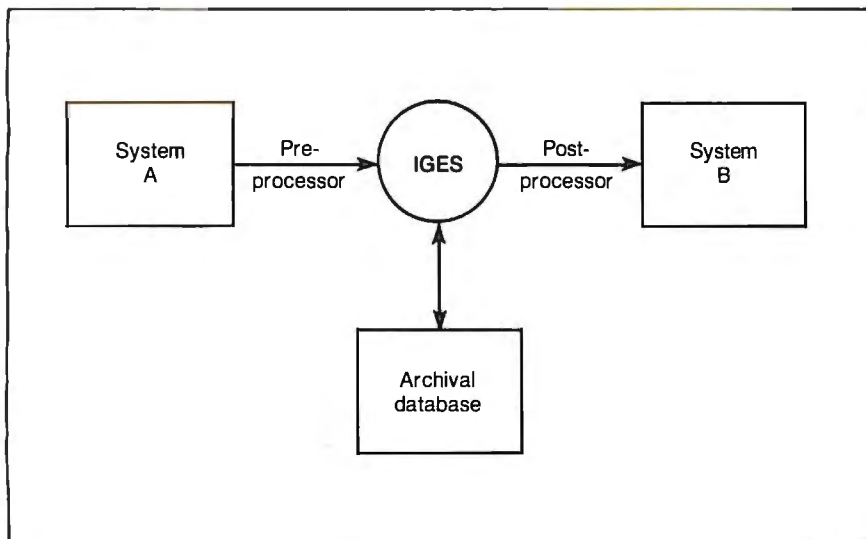

Figure 3: The software that translates from a CAD system to IGES is called a preprocessor. The software that goes the other way (translates from IGES to a CAD system) is called a post processor.

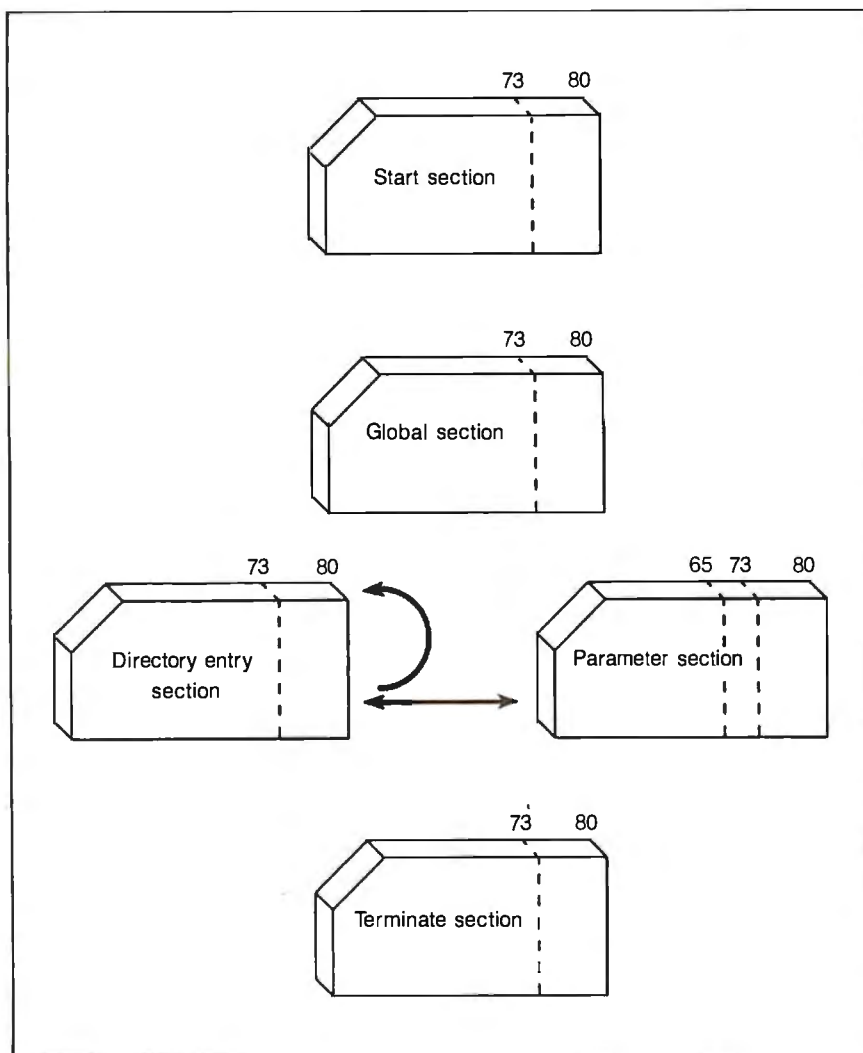

Figure 4: The files are divided into five sections: start, global, directory entry, parameter data, and terminate.

and substantially less processing time than in IGES. For a single dimension, the size of an IGES file can be seven times that of a SET file. The concept of blocks and subblocks is technically superior to the IGES method of using just entities. (IGES was based on CAD systems of the 1970s, which used only entities.)

SET is not currently supported by any U.S.-based CAD vendor. However, it is a French national standard and has been proposed as both a European and an international standard. International politics will determine whether SET will ever become a realistic alternative in this country.

Future Alternative

A future alternative to IGES is the Product Data Exchange Specification (PDES) being developed by the IGES organization. PDES will go beyond IGES's lines, circles, and dimensions entities to define a more conceptual model. Parts will be based on solids and defined in terms of features such as holes, flanges, or ribs. Instead of dimensions, PDES will define a tolerance envelope for the part to be manufactured. PDES will also contain nongeometric information such as the materials to be used, manufacturing processes, costs, and suppliers. PDES will be a complete computer model of a part.

PDES is intended for applications such as mechanical, electrical, and AEC (Architectural and Engineering Construction) drawings, as well as manufacturing. The development process includes applying information-modeling techniques to each application and finding the minimal set of conceptual data required by all applications. Then a data representation will be used to store the information in a three-level architecture: the application layer, the conceptual (or logical) layer, and the physical layer. This resulting data exchange format will be much more sophisticated than IGES.

Indeed, PDES is an ambitious undertaking. Even though a first draft is scheduled for late 1987, PDES translators are unlikely to be available until the 1990s. It is clearly a future-oriented file format meant to work with more sophisticated CAD systems that use solids, features, and maybe even artificial intelligence.

In the meantime, the IGES organization has made testing translators its highest priority. Although the quality of IGES processors has improved over the years, the SAE validation program promises to accelerate improvements. And with the pressure that's being applied by the Department of Defense and some of this country's largest corporations, the success of IGES translation should approach 100 percent. ■

Introducing . . .

FastCAD[®]

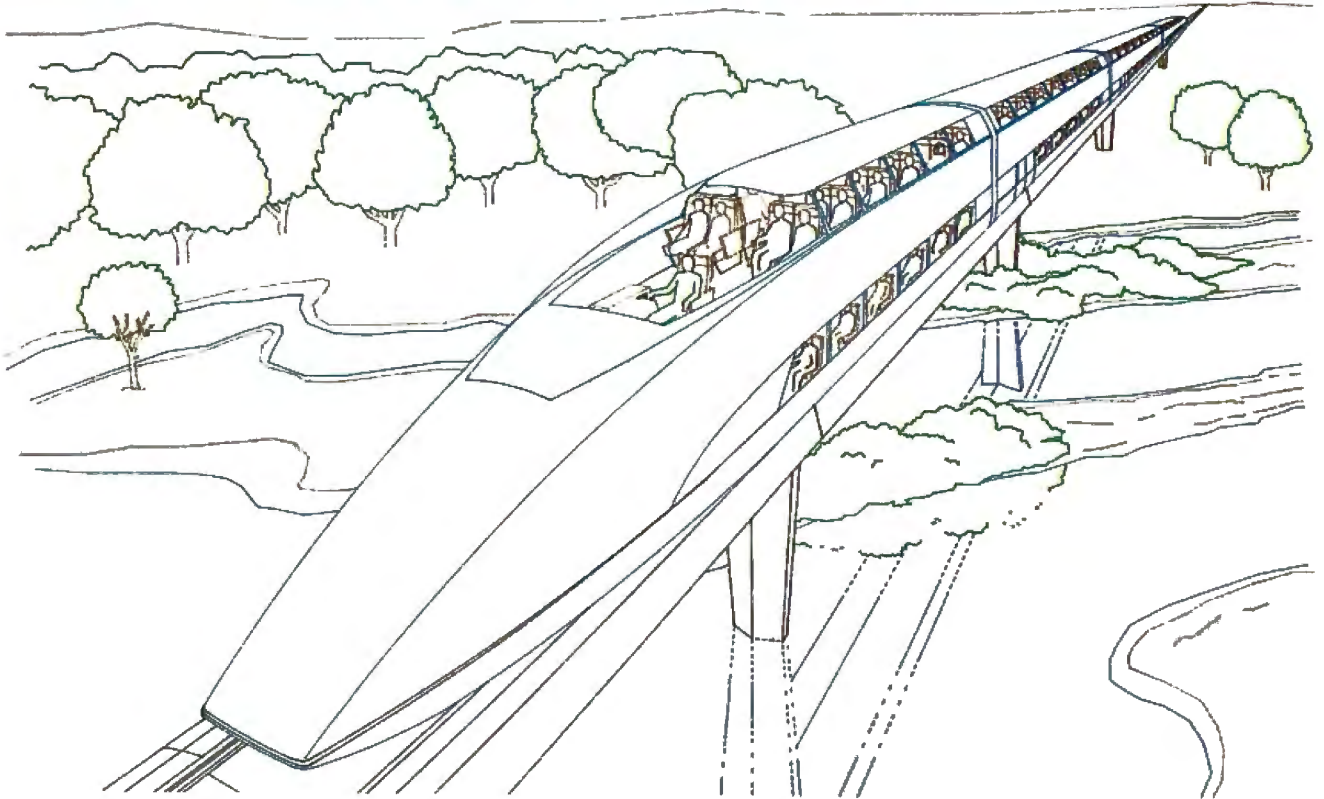

CAD software that works with you

When you convert your office to CAD, you need to plan for three costs—CAD software, the equipment to run it, and the time you and your staff will spend learning to do productive work with it. For many businesses, that third cost dramatically outweighs the first two.

FastCAD significantly reduces training time. It's easy and natural to work with. Pull-down menus, icons and dialog boxes combine with a logical command structure to get

you up to speed fast. Our clear and readable manual covers everything from basic CAD concepts to custom menus and macros.

FastCAD saves time after you learn it, too. It's written in assembly language, so screen redraws and selections happen astonishingly fast—on equivalent hardware, it's faster than any other PC-CAD program. With FastCAD, you won't have to break for coffee every time you zoom in or out on a complex drawing.

FastCAD doesn't make you plan every step in advance. Icons and modifiers let you change your mind while working, reacting to the drawing as it develops. You can zoom or pan, change colors, layers

or line styles, and open and close view windows in the middle of any drawing or editing action. Multiple windows show you magnified details and overall views at the same time, and you can draw in all windows simultaneously.

You owe it to yourself to see FastCAD at work. Contact your dealer or Evolution Computing today for a demonstration.

Dealer inquiries invited
FastCAD list price \$2,295.00

For the IBM PC, AT and 100% compatibles, including Compaq Deskpro 386. 512K RAM and 8087/80287 math co-processor required.

FastCAD is a registered trademark of Evolution Computing. IBM is a registered trademark of International Business Machines Corporation. Compaq Deskpro 386 is a trademark of Compaq Corporation.

Original train concept by C.M. Montooth, Taliesin Associated Architects
FastCAD drawing by Rick Axtell

**EVOLUTION
COMPUTING**

437 S. 48th Street, #106
Tempe, AZ 85281
(602) 967-8633

American Made Computer—Overseas Price

Features:

- 8 MHz/10 MHz Operation
- 512K RAM expandable to 1MB
- Also runs Xenix, Unix, Pick, AutoCad and Network systems
- Systems are fully tested and burned in for 48 hours
- 80286-8 Micro processor
- 1.2MB floppy disk drive
- Hard disk and floppy disk controller
- AT® style keyboard
- Battery backup clock/calendar
- ROM BIOS
- Complete documentation
- One year limited warranty

Options:

- 1.2MB TEAC floppy drive
- Hard Disk/Floppy controller for AT®

Accessories:

- EGA monitor & EGA card \$615
- Mono monitor & mono card \$187
- 512K of RAM \$52
- 80287 Math Co-processor \$235
- 360K floppy disk drive \$99
- 1.2MB floppy disk drive \$135
- MS DOS and Basic version 3.2 \$85
- RAM chip 64K \$1 256K \$3
- AT® style keyboard, 5151 \$88

8 MHz System with Option

without mono monitor and Video card **\$1028**

10 MHz System with Option

without mono monitor and Video card **\$1128**

Upgrade to 30MB 39 ms add **\$195**

SCSI-286 8 MHz version

\$756

Basic system

Made in U.S.A.

Desktop Publisher
SCSI Press Pac I \$7945
SCSI Press Pac II \$5555



SCSI-286 FULLY CONFIGURED AT® SYSTEMS

SCSI-286m

Mono AT® System **\$1215**
Basic system as described above, Monochrome monitor with Tilt swivel base, Hercules compatible Monochrome Graphics card with Printer port

SCSI-286s

The 286 Steal with 20MB HD **\$1699**
Basic system as described above, 20MB H.D., Monochrome monitor with Tilt swivel base, Hercules® compatible monochrome graphics card, 1MB of RAM, expandable to 3MB, four I/O ports, fully tested and burned in for 60 hours, fully configured systems

SCSI-286e

Special EGA 20MB H.D. **\$1895**
Basic system as described above, 20MB H.D., fully configured, EGA/CGA compatible monitor, EGA color display card with parallel port, fully assembled and tested before shipping

HARD DISK FOR PC, XT & AT

Hard Disk for AT®

*39 ms access time

*20MB	ST4026	\$528
*30MB	ST4038	\$628
*40MB	ST4051	\$699
80MB/28 ms	ST4096	\$1195
72MB/25 ms	Toshiba	\$1095

Seagate 20/30MB Hard disk Subsystem

20MB Internal ST225	\$350
20MB External ST225	\$499
30MB Internal ST238	\$470

With Floppy Controller add \$55 (20MB only)



MODEMS BY EVEREX

Evercom 12

- Hayes compatible
- Software included
- Half size/Low power **\$109**
- 300/1200 Baud internal
- Runs Smartcom and all Hayes comp software
- Excellent for Long Distance Calls

Evercom 24

- Hayes compatible
- Half size/Low power **\$199**
- 1200/2400 Baud internal
- Software included
- Runs Smartcom and all Hayes comp software
- Excellent for Long Distance Calls

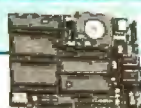

GRAPHICS DISPLAY CARDS

Mono Hercules Compatible

- Printer port **\$99**
- Hercules compatible
- Software switchable
- Runs Lotus 123 Graphics
- Runs 132 columns

EGA Graphic Card

- Parallel port **\$178**
- Fully IBM compatible
- 256K video memory
- Runs color/mono enhance display
- 6 colors, 640 x 350 resolution
- 1 printer port



Micro EGA

- External Switch **\$178**
- 640 x 350 EGA
- 320 x 200 CGA
- 640 x 350 Monochrome
- Hercules compatible

MONITORS

Mono monitor

- Nonglare **\$99**
- 800H x 350V resolution
- FCC class 'B' approved

EGA monitor

- 640 x 350 **\$429**
- 640 x 200
- EGA and CGA



NEC Multisync

- 800H x 560V **\$555**
- Text Mode Switch
- EGA, PGA, CGA compatible

MULTIFUNCTION CARDS

Multifunction for AT®

- Software and game port
- 0-2MB memory
- Two serial ports
- One parallel port **\$148**
- Runs on 12 MHz AT®
- 2nd serial port optional

Mini I/O for PC/XT/AT

- Parallel port **\$79**
- Real time clock/calendar
- 2 serial ports (2nd optional)



Six-Pac Compatible

- Serial port **\$88**
- Parallel port
- Clock/calendar
- 0-384K Memory
- Game port and software

TAPE BACKUP BY EVEREX

Tape Backup Subsystem

- Backup 5MB in 1 minute
- Image/File-by-File
- Mounting hardware
- Software and tape
- Controller included

		INT.	EXT.
TEAC	20MB	\$580	\$620
Wangtek	60MB	\$727	\$827
Archieve	60MB	—	\$650



MEMORY CARDS

Memory card for PC

- Short card **\$45**
- 0-576K Memory
- Support 64K/256K DRAM

Memory card for the AT®

- 0-3MB **\$135**
- 256KB RAM chip
- Split Memory address
- One year limited warranty



TURBO XT

- Hercules Monographics card
- Fully IBM compatible
- 8088-2, 8 MHz CPU
- 20MB Hard Disk Drive
- 4.77 and 8 MHz keyboard selectable
- With 360K Floppy Drive
- 1 parallel port
- Option math Co-processor

- 640K memory
- 135 watt power supply
- Keyboard
- MS DOS 3.1
- FCC Class 'B' approved
- One Year warranty

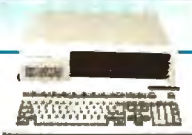

\$945

OTHERS

Turbo PAC-286

- Makes your PC/XT 33% faster than IBM
- 80286 processor
- Socket for 80287
- 128K RAM **\$399**

Everex Edge

- Parallel port **\$235**
- 132 column text, color or mono
- Color display 16 colors
- color software thru mono monitor

Microsoft Compatible

- 200 dots/inch
- Work with AutoCad
- 3 buttons/built-in microprocessor **\$76**

Mouse with DR. HALO **\$109**

HD/Floppy controller

- Hard disk & Floppy controller for AT **\$160**
- PC/XT Hard disk & Floppy controller **\$128**
- PC/XT Western Digital (chipset) Hard disk controller **\$108**

Quantity Discounts available

Dealers are Welcome

ORDER BY MAIL: Check or Money order, California add 6% sales tax.

ORDER BY PHONE: C.O.D., Cashier Check, VISA, MasterCard, American Express (3% extra) or Approved Company P.O.



Southern California Systems, Inc.

10525 Humboldt St., Los Alamitos, CA 90720 (In Orange County, Los Angeles)

CALL us now toll free at 1-(800) 237-7274 (Outside CA)

1-(213) 493-6633 (Sales)

GUARANTEE 30 DAY MONEY BACK

For Technical Support Call (213) 596-9748 FAX # 1-(213) 493-5187 Corporate accounts call Anil and get total satisfaction for your money.

TERMS: Due to our Low Price, all sales are final. All prices are subject to change and some quantities may be limited and we reserve the Right to Substitute Equivalent Items. Unauthorized Returns are subject to 10% Restocking Fee. Call for RMA Numbers for Returns and Repairs. *All Prices are subject to change without notice. IBM, Hercules, BitCom, Xenix are Trademarks of their Respective Companies

CAD for Building Chips

Silicon compilers and the automated building of VLSI circuits

Steve Trimberger and Jim Rowson

A SILICON COMPILER IS a CAD program that translates a high-level description of complex circuits into the artwork needed to fabricate a semiconductor integrated circuit chip. The high-level description that we use depends on the function we wish to build and on the capabilities of the silicon compiler.

We can compare a silicon compiler to a software compiler. A Pascal compiler translates a function in the high-level Pascal language to machine code that implements that function. The compiler can optimize its output to produce fast code that uses memory efficiently. Silicon compilers also can optimize their output to improve the speed and size of the resulting chip.

There are many programming languages, each targeted to solve a particular kind of problem and each with a different specification language. Similarly, there are different kinds of silicon compilers. We will look at some common silicon compiler types and explain their importance in the development of new chip technology.

Impact of Silicon Compilers

Silicon compilers differ from programming language compilers in two important ways. First, a chip is two-dimensional. We lay out circuit functions on a planar surface, whereas software generates a one-dimensional sequence of instructions. The extra dimension of silicon makes good optimization difficult. The second major difference is the physical nature of the communication. In software, moving numbers requires no addi-

tional space. On an integrated circuit, every signal travels on its own wire. The wire takes space, and long wires contribute to long delays. On a chip, we pay a heavy penalty for using a value far from where we compute it. Silicon compilers tend to restrict the flow of data to make efficient chips.

The time savings from using a silicon compiler can be enormous, reducing the development time of a new IC from years to days. Like a software compiler, the silicon compiler guarantees correct interaction among the parts of a complex circuit, eliminating a whole class of potential errors.

The same specification to a silicon compiler can be used to build a better chip when the chip-making technology improves, just as a Pascal program can be recompiled and used on new, faster computers.

Compilers, whether software or silicon, are productivity-enhancement tools. They help you in two ways: They help raise the level of description so that a small amount of specification provides a large amount of functionality, and they make modification easier by automating the reimplementing of a project.

Effect on Personal Computers

As ICs become more complex, their design cost becomes a greater fraction of a chip's total cost. Silicon compilers reduce the system design cost, so the chips themselves are cheaper. More importantly, silicon compilers speed the design process, so new products become available sooner.

As a further benefit, as the technology improves, the same specification for a compiler can be used again with the new technology to instantly provide the next generation of faster, cheaper machines.

Types of Silicon Compilers

There are three main types of silicon compilers: those targeted to memories, those targeted to datapaths, and those targeted to general logic and state machines. The output code that a silicon compiler generates can be targeted to different kinds of semiconductor implementation (CMOS, HMOS, and so on), just as Pascal compilers generate code for different machines.

Silicon compilers tend to excel in one or more of three distinct areas: memory logic, multibit logic, and arithmetic and single-bit control type logic. The most popular compilers have specialized in one of these areas.

Software compilers tend to be classified mostly by input language and to a lesser degree by processor. However, the big difference between silicon compilers is how their outputs are implemented in silicon, with the differences in specification being largely a result of their implementation style or layout.

You can classify software compilers in

continued

Steve Trimberger is manager of advanced development at VLSI (1109 McKay Dr., San Jose CA 95131). Jim Rowson is manager of design technology at VLSI. Both received Ph.D.s in computer science from Caltech.

many ways. One useful way is by the level of abstraction in the input language—assembly language, procedural language, or object-oriented language. Another useful differentiation is how they are implemented—interpreter, compiler, or optimizing compiler. Similar methods classify silicon compilers. One method is to look at the layouts generated by the compilers (their implementation) for similarities. There are three broad classifications: regular array compilers, partially regular array compilers, and nonregular compilers.

Regular array compilers need very little specification because of the high degree of uniformity in their final output. A RAM compiler is an example. Partially regular array compilers take advantage of some repetitive structure in both their output and their specification language. A datapath compiler is an example of this type. Nonregular compilers need a powerful specification language, since

every function must be specified by the designer. A state machine compiler is a nonregular compiler.

Because of their uniform nature, regular array compilers most efficiently use the area on the chip, with partially regular array compilers second and nonregular compilers last.

Regular Array Compilers

A regular array compiler implements functions by connecting many identical cells in a two-dimensional rectangular array. This core array usually requires some peripheral logic of replicated cells of another type. The spatial organization of identical-cell, rectangular-array circuits limits the communication of the cells to nearest-neighbor connections.

Building a RAM

A memory chip, such as a RAM, is a typical example of this kind of organization. We build a RAM compiler so we

can generate a RAM with any word size and number of words. We are not restricted to a predefined word size or memory size.

Each regular array compiler has a fixed structure or “floorplan” it follows to build the layout (see figure 1). The RAM compiler builds the core array of the memory in two pieces, separated by address row decoders. The compiler puts address buffers on the top and address accelerators on the sides. On the bottom are the column address decoders, data line precharge circuits, sense amplifiers, and I/O buffers.

All cells in the core array connect to a horizontal address select line and a vertical data I/O line. The compiler does not make these connections explicitly because they are built into the memory cells. The compiler places the memory cells in the array, making the connections by abutment. Similarly, the peripheral circuitry connects to wires where they enter and leave the core array. The compiler adds sense amplifiers and additional decoders and finishes wiring the power and ground wires, sizing them to drive the entire memory circuitry.

RAM specification is very simple and requires only the word size and the number of words in the RAM. The compiler specification may include options to separate the read and write data lines, provide an output enable, or specify a faster access time. These specifications determine the size of the memory arrays, while their organization is prespecified in the floorplan.

All the cells in the compiler are predefined layout blocks. The compiler merely assembles the correct number of them in the correct order to produce the final assembly. The task is complicated by options that you may request. These options can often be satisfied by selecting a different kind of cell for the driver, based on the option desired. The compiler also calculates power consumption and sizes buffers and power wires to match the memory size. For example, a large memory with large word size requires large drivers for the decoders; a memory with more words of storage requires different sense amplifiers.

As a further complication, the core array of the compiler may not be completely regular. The compiler must take into account power and ground distribution and insert extra power supply connections in the core array at regular intervals as they are needed.

Other Regular Array Compilers

A RAM compiler requires only the number of words and number of bits per word

continued

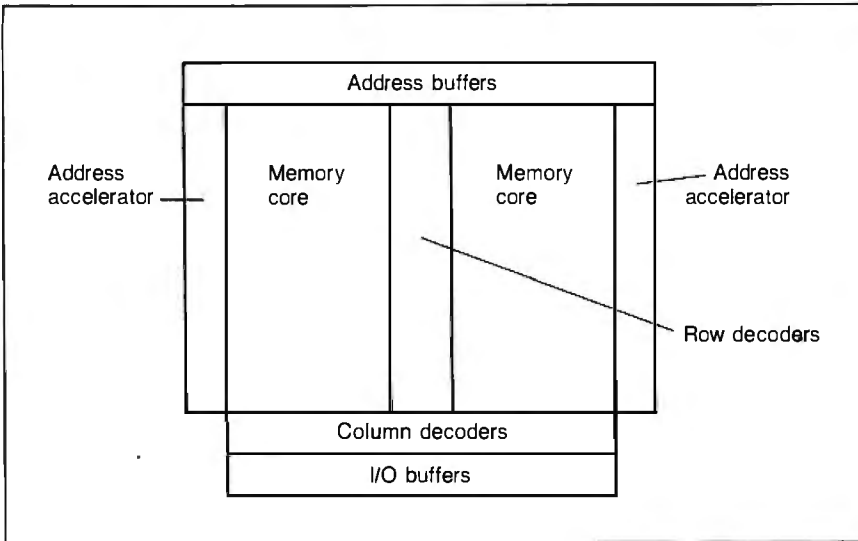

Figure 1: A floorplan for a RAM chip.

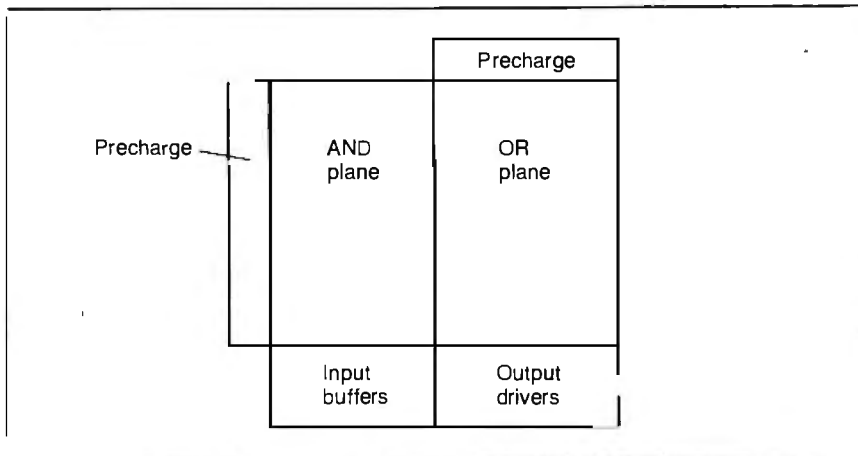

Figure 2: The organization of a programmable logic array chip.

**CONTROL SYSTEMS
ANNOUNCES ARTIST 10/16™...
THE FASTEST GRAPHIC CONTROLLER
FOR PC CAD.**

**The ARTIST 10/16
is three times faster
than our closest competitor.**



- Single Screen, Single Board, Single Slot
- Runs CGA Software; Lotus 123, Sidekick, etc.
- 65,000 Vectors/Second Drawing Speed
- 1024 x 768 x 4 Resolution
- 16 Colors out of 4096 choices
- Display List Processing from Extended Memory
- Low Retail Price—\$2495

Call Control Systems today for more information. We'll send you a FREE copy of our "Display Performance Report". It details complete results of the benchmark tests.

Call 800-826-4281
In Minnesota 612-631-7600



Control Systems

2675 Patton Road
P.O. Box 64750
St. Paul, Minnesota 55164
Telex 756 601

PC-TOWER® / 386 COMPUTER

UNINTERRUPTIBLE MAINFRAME POWER
UNDER YOUR DESK



VARs

OEMs

S/Is

20MHz

80386 CAD-WORKSTATION

Single-User, Multi-User, or Networked

Your Choice of Operating Systems:

MS-DOS® UNIX® MS-OS/2® XENIX®

Our Variable Storage Architecture offers:

- Upgradeability second-to-none (CPU/drives)
- Stay on the leading edge at minimal cost
- Supports up to 7 drives (5.25" & 3.5")
- Floppy, Winchester, tape & optical drives
- Storage from 40 megabytes to 1.5 gigabytes
- Faster transfer rates & disk access times
- 100% IBM compatible (software & hardware)
- Supports any MS-DOS network (Novell, 3-Com)
- PC-Tower grows with you, not away from you

Mix & Match the best components available.
Enclosures to complete computer systems!
Build your own custom CAD computer!

TSI is The Source for many VARs Nationwide.
Now there's a "PC-Tower" Just for You!

MEGACAD H-HAUER
DELTA ACS ALR



Mini-Micro
Business Systems

Box 13063, Boulder, Colo. 80308
(303) 444-3746 (516) 698-3216

*There are virtually
as many ways to
specify datapaths
as there are compiler
products available.*

to be specified because each bit of the RAM is identical. Other memory compilers require more specification. A ROM compiler, for example, also needs the data to be programmed into each memory location. A slight modification of a ROM is the programmable logic array, where each cell represents an input to a NAND or NOR gate for implementing control logic. The PLA is similar to the ROM in that each input to the NAND or NOR gates must be specified.

You implement the programming by defining two cells with identical size—one for an on bit, one for an off bit. You take programming data from a file to select which cell goes into each location in the core array.

Each memory compiler has a different structure. The RAM has two memory arrays with address decoders and sense amplifiers. The PLA shown in figure 2 has two arrays, one for computing AND terms and one for OR terms. The PLA has input buffers and output drivers as well as precharge circuitry around the core arrays.

There are many other types of memory compilers including first-in/first-out (queue), last-in/first-out, (stack), and multiport RAM compilers. These compilers share the common characteristic of generating uniform arrays of identical cells surrounded with support circuitry. The dissimilarities include different kinds of cells and a different number and arrangement of arrays.

Memory compilers are not the only regular array compilers. Systolic array processor compilers build a regular array of processors. Each processor computes a partial solution to a problem as the data flows through the array of pipelined processors. Systolic array processors have been designed to compute array multiplication, solve linear equations, and perform image-processing tasks.

Partially Regular Array Compilers

Partially regular array compilers are a generalization of simple array compilers. The layout here is still a two-dimensional array of simple functions. In one direction, the same function is repeated with local and global communication. In the

other direction, different functions are placed. The layouts of these functions must follow conventions to allow them to tile together easily. The wiring between dissimilar functions is much less structured than in the regular array compiler. You can think of the partially regular array compiler as building a custom cell—sometimes called a bit slice—and then repeating the bit slice.

A typical partially regular array compiler is a datapath compiler. A datapath compiler is optimized for multibit logic and arithmetic. Every microprocessor has some multibit logic in it in the form of an ALU, adders, and registers. A very popular off-the-shelf part is the bit-slice datapath multiplexer, such as the 2901 from Advanced Micro Devices. With TTL designs, the 74181 ALU and other 4-bit packages are often used to build multibit logic. A datapath compiler provides a general mechanism for constructing your very own customized 2901-type design.

The datapath compiler is similar to a simple array compiler in that it builds repetitive structures in at least one direction: The same logic is simply applied to multiple bits. However, the specification of a datapath is much more complex, requiring a schematic or equivalent. You must describe the functions you want in the basic bit slice and how they should be wired. The compiler may optimize placement of the functions to minimize wire length and wiring congestion, making a faster, smaller chip. The compiler may also check that the datapath elements are connected reasonably.

There are as many ways to specify datapaths as there are products available. Some datapaths use textual languages that select the functions and describe their interconnection. Other systems provide an interactive way to fill out forms that describe the datapath. Still others provide a way to draw a schematic as a specification. In all cases, the result is the same: A bit-slice block is constructed of dissimilar elements, and then that bit slice is repeated.

A Sample Datapath

To illustrate how a datapath compiler works, let's examine a very simple 8-bit accumulator. The accumulator consists of an ALU with a register on each input. One of the registers can be either preset or can get the result of the ALU operation. The schematic for this datapath is shown in figure 3.

Each block in the schematic represents an entire functional unit, which could range from the simple two-input multiplexer up to a register file or barrel

continued

FRUSTRATION INSURANCE

For Only \$99.95 **BOOKMARK™** Protects You From:
 NOW Non-Copy Protected Software!

FROZEN KEYBOARD

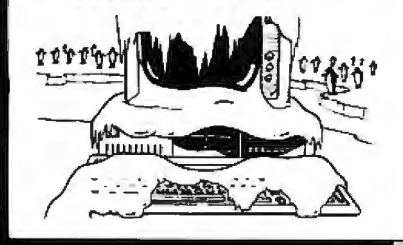

When the keyboard freezes up you've got to reboot — and you can't even save first. But with **BOOKMARK**, work is already saved.

SYSTEM CRASH



System crashes used to mean complete loss of data in memory, but not any more.

FORGETFULNESS



You can even power down without saving and not lose more than a few moments' worth of work!

NOVICE MISTAKES

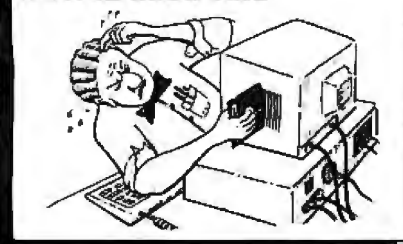

Novices can't possibly go wrong when everything's already saved.

BLACKOUTS



Work in progress, up to the previous **BOOKMARK** placement, is safe!

ACCIDENTS

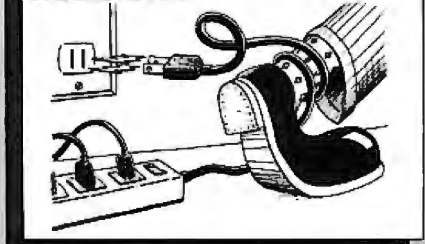

BOOKMARK protects you against loss of work and time due to unexpected incidents.

BOOKMARK™

A memory-resident utility that automatically saves work in progress to the hard disk at user-definable intervals.

To Order Call Toll FREE
800-544-MARK

In California Call Toll Free **800-543-MARK**
 or call for the dealer or distributor nearest you

INTELLISOFT™



INTERNATIONAL

70 Digital Drive • P.O. Box 5055 • Novato, CA 94948 • 415-883-1188

See us at
COMDEX/Spring '87

June 1-4, 1987
 Georgia World Congress Center
 Atlanta, GA Booth #4034

Requirements:
 IBM PC/XT/AT or 100% Compatible • 256k to 640k • IBM DOS 2.1 or Higher, 1 Floppy Drive • Hard Disk Drive (10 Megabyte Minimum) • Video Display Adapter IBM (Monochrome, Color, Enhanced Color), Hercules, AST (**BOOKMARK** occupies an equivalent space on hard disk as in system RAM plus video RAM)

BOOKMARK™ is a trademark of INTELLISOFT International. Copyright © 1986 by INTELLISOFT International. All rights reserved. Patent Pending. IBM PC/XT/AT are registered trademarks of International Business Machines Corporation. Hercules is a trademark of Hercules Computer Technology. AST is a registered trademark of AST Research, Inc.

GET BACK FASTER!

Resume where you left off with a single keystroke.



YES! Please send **BOOKMARK(s)** at \$99.95 each to:
SHIPPING AND BILLING ADDRESS

Name _____ State _____
 Company _____
 City _____ Phone (____) _____
 Zip _____

PAYMENT METHOD

Money Order Visa
 MasterCard Amer. Exp.

Account Number _____
 Expiration Date _____

Signature _____

ORDER INFORMATION

Please send **BOOKMARK(S)**
 at \$99.95 each (total) _____
 Sales Tax \$6.00
 (Calif. Residents Only) _____
 Shipping & Handling
 (\$5.00 per unit) _____

TOTAL _____

FORMAT (check one)
 3 1/2" 5 1/4" Mac Plus

New! Mac Plus Version

shifter. The wires in the schematic represent entire buses. No control signals (such as the operation control for the ALU) are necessary in this specification, since the blocks imply the existence of the control signals.

The process of compiling this specification schematic into an optimized layout starts by creating a bit-slice block to implement the function. This bit-slice block will need to include four cells: two registers, a multiplexer, and an ALU. The

compiler automatically orders these cells to minimize the wiring between them and also automatically routes them. Once the bit slice is created, it is repeated. Figure 4 shows an overall floorplan for the resulting layout.

The wiring within the bit-slice block between different cells is unique for each datapath. Between bit slices the wiring is very similar to that used in the RAM and other regular array compilers. The layouts of the individual cells have built-in connections to their nearest neighbors that are connected by abutment when the bit slices are arrayed. Along the top of the array of bit slices are placed control signal buffers to interface between the control logic and the insides of the datapath.

A CPU execution unit is obviously a datapath, but a datapath processes any multiple-bit data, so it is a very general mechanism that can be used to design any piece of multibit logic. Some examples of datapath applications include pipelined functions, counter/comparator logic, register/shifter logic, and cache memory handlers. These datapaths can contain dozens or hundreds of cells.

The above description concentrated on the layout generated by the compiler. Today's compilers can also generate a gate-level network connections list (netlist) for their functions. These netlists are suitable for input to gate array and standard cell implementations. Gate arrays provide for

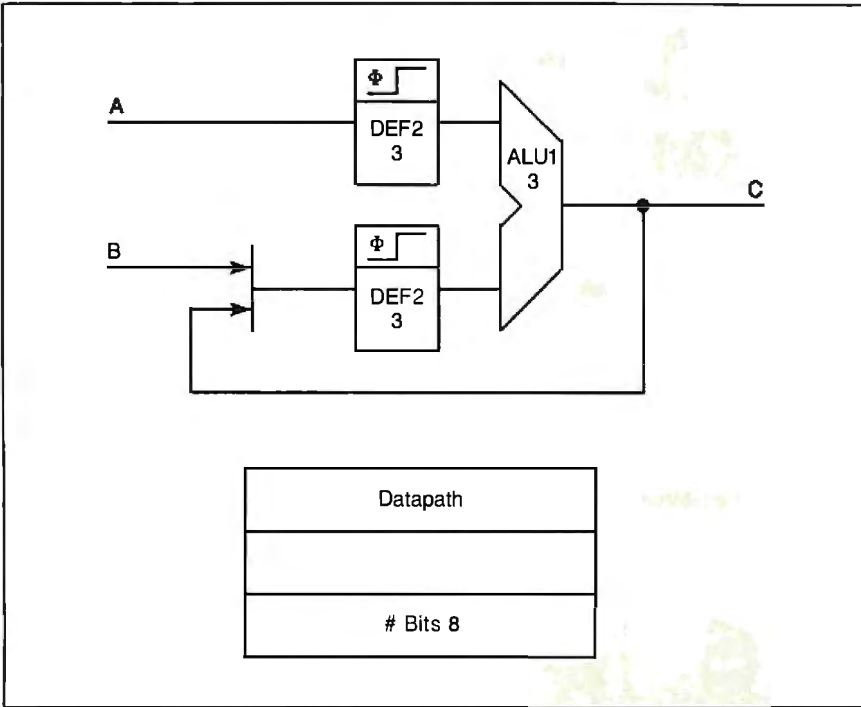

Figure 3: The datapath logic specification for an 8-bit accumulator.

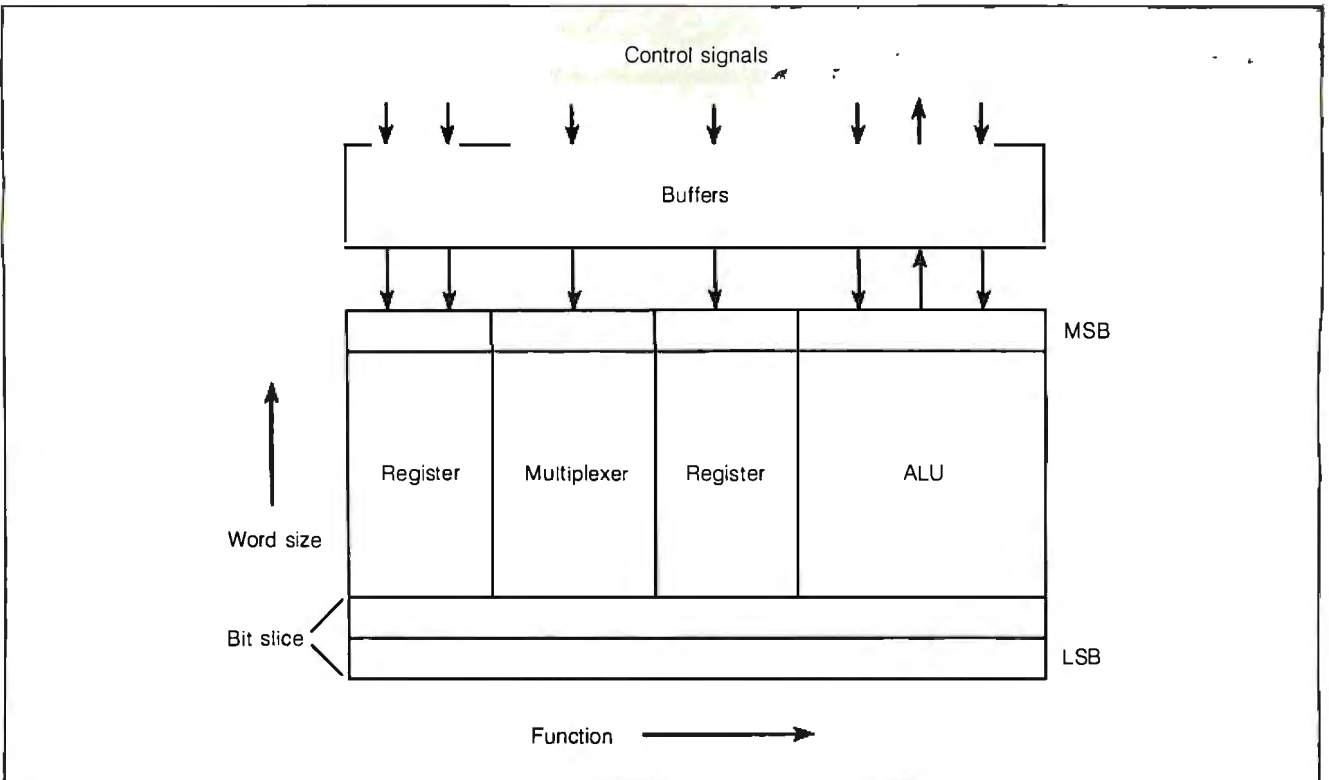

Figure 4: The floorplan used by a silicon compiler for a datapath component.

A logic compiler can implement any function that is expressed in equations, whereas more regular compilers are limited.

quick turnaround implementation and small quantities. Standard cells are quite flexible when floorplanning a complex chip with other large blocks, such as memories. Both gate array chips and standard cells provide a convenient way for people to add their own functions within the overall datapath environment without doing any custom layout.

Nonregular Compilers

Many functions that we wish to implement on an IC do not fit into regular structures of any kind. These functions are usually control functions or glue logic between large blocks or systems. They do not fit into a regular structure, so we have a class of silicon compilers that let users specify functions as equations and implement those functions as collections of gates wired together (see figure 5). A compiler of this type is called a *random logic* or *state machine* compiler, depending on the features of the input language.

Control logic is difficult for most silicon compilers because there is no regular, repetitive structure to exploit. Unlike memories and datapaths, each piece of control logic is unique, requiring a unique layout.

A state machine offers a convenient way to express control logic. A state machine is always in a specific state. The current state and the inputs determine the next state and the values of the outputs. A user can define Boolean equations of significant complexity to express the conditions under which the machine changes states and the values of its outputs. A set of random logic equations is a special case of a state machine with no states.

The state machine is a very good model for control logic for sequencing, peripheral control, or microcode. The specification of the equations may be very complex, including multiple-bit values, comparisons, and conditionals. The example shown in figure 6 is a state machine description of a traffic-light controller. The default state of the lights has the highway light (hl) green and the farm road light (fl) red. When a car trips

continued



Project data beyond the limits of your computer screen

Your personal computer images can now be shared by projecting them onto a wall or screen.

Until now, the only effective way to share computer data with a room full of interested people was to use an expensive large screen CRT. Now, with your personal computer, a standard overhead projector and a Telex **MagnaByte™ Electronic Imager** your data is no longer confined to the few square inches of a display screen.

The MagnaByte system consists of a translucent LCD "palette" which fits on the top of an overhead projector, an interface card to insert into the personal computer and a remote control. The MagnaByte system does not require any additional hardware or software investment to operate. Just turn on your computer, focus the overhead projector and you're ready to present. It's compatible with IBM's PC/XT/AT, the Apple II family including the GS series and systems compatible with IBM such as Telex's Intelligent Workstations. MagnaByte comes complete with a program created in English, German, French and Spanish designed to help you easily capture and assemble PC information onto your own presentation disc.

For more information and the name of a dealer near you, phone or write to: Telex Communications, Inc., 9600 Aldrich Ave. So. Minneapolis, MN 55420

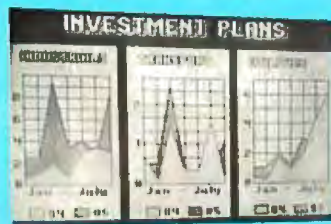

* Palette pricing starts at under \$900. (USA)



**Call Toll Free 1-800-328-5727, Extension 8812
In Minnesota Call 1-800-742-5685, Extension 8812**

the sensor on the farm road, the lights change to let the car go through the intersection. There is one state in the state ma-

chine for each state of the lights. The silicon compiler has a target collection of gates. The gates are Boolean

logic gates—such as AND, OR, and NAND—plus some registers, latches, and complex gates. In the first step, the compiler translates the input equations into a netlist, a collection of these gates and their interconnections. In the second step, the compiler uses a general placement and routing package to implement the layout.

Logic optimization for large collections of logic is still an unsolved problem. A current solution reduces the equations to two-level logic and optimizes each output independently. It then searches the entire system of Boolean equations, extracting common factors. Finally, the compiler substitutes smaller gates for larger gates where possible, such as substituting NAND-NAND for AND-OR logic, as seen in the optimized version of our simple example (see figure 7). The result is an implementation of the logic that is usually better than a designer would make. It is more consistent, faster, and less error-prone.

The final placement and routing of the netlist can go to a gate array or a standard cell system. A gate array is a two-dimensional array of identical cells that are personalized and interconnected with the logic from the netlist. A standard cell chip consists of rows of nonidentical cells with routing between the rows. Usually, both gate array and standard cell implementations are less efficient than arrayed datapaths and memories because the general interconnections consume space and reduce performance. There are no built-in, optimized communication paths like those in memories and datapaths. However, a logic compiler can implement any function that is expressed in equations, whereas more regular compilers are limited in their function.

Many silicon compiler systems implement control logic in PLAs to take advantage of their regularity. However, while PLAs are a simple regular structure to build, they often do not meet the performance or area constraints required in a design.

What's Next?

The design of silicon compilers is certainly an active area of research and development, one where we can expect to see radical changes. Some of the areas in which we expect to see rapid advancement include automatic test generation for compilers; higher-level, more focused specification languages; compilers that call other compilers to build very complicated systems; other silicon floorplans that give rise to whole new classifications of compilers; analog circuits; and process technologies other than silicon, such as GaAs. ■

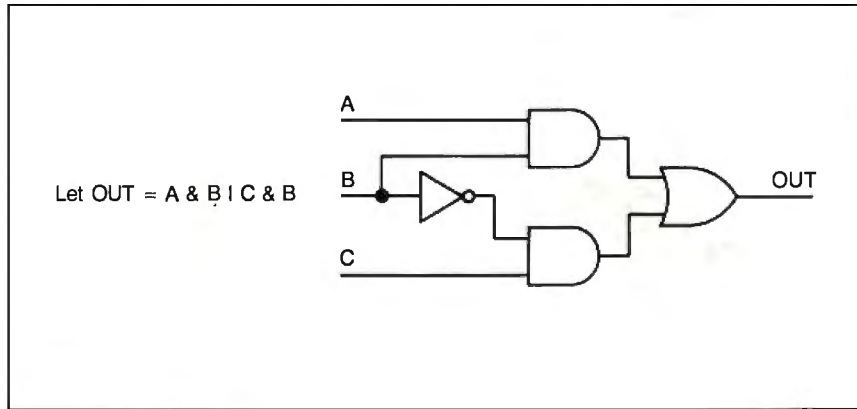

Figure 5: A Boolean equation and the logic gates a silicon compiler generates for it.

```

sm Traffic; # Traffic-light controller

`define color      red green=0 yellow=1;

clock clk 65;
reset !reset -> hg;

latched inputs car;
inputs tlong tshort;
latched outputs st;
outputs hl:color=red fl:color=red;

state hg car & tlong -> hy st hl=green,
                        ->          st hl=green;      # state defaults to same
state hy tshort      -> fg st hl=yellow,
                        ->          st hl=yellow;      # single-bit outputs
state fg !car | tlong -> fy st fl=green,
                        ->          st fl=green;      # default to off, unless
state fy tshort      -> hg st fl=yellow,
                        ->          st fl=yellow;      # the designer says to
                                                                # default to something
                                                                # else.
end
# the first guard satisfied is taken and blank is true, so in state HG you
# stay in HG when !(car & tlong)
    
```

Figure 6: The state machine description of a traffic-light controller.

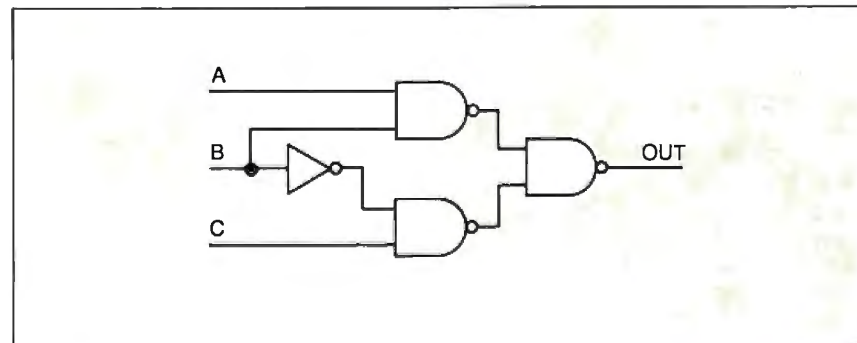

Figure 7: The optimized logic diagram for the circuit described in figure 5.

A Chip off the Ol' Blue.

Today's lesson is on Economics. There is a great supply of high priced name brand personal computers with advanced capabilities. And a great demand for low priced name brand personal computers with advanced capabilities. A scenario that has many people singing the blues. But, there's a new blue in town at a shade of the price...the Blue Chip™ Personal Computer by Hyundai.

The Blue Chip is 100% compatible with the IBM XT. So it runs over 10,000 IBM programs including Lotus 1-2-3®, Symphony®, Wordstar® and other popular software. Its features include: 512K memory (expandable to 640K), a 360KB floppy disk drive, six expansion slots, a parallel printer port, an AT style keyboard, a 130 watt power supply (enough to drive a 20MB hard disk), a Hercules® compatible mono/graphics card and a high resolution monochromatic monitor. And there's plenty of Blue Chip stock at Logicsoft, so you can get it overnight and at a great price.

As the world's leading direct distributor of computer products, Logicsoft can configure your Blue Chip to any specification. And we offer free overnight delivery, custom leasing programs, free service contracts and corporate volume discounts. Blue ribbon policies that make other companies contemplate cashing in their chips.

The Largest Direct Distributor
of Software and Hardware Products
...in the World.

LOGICSOFT®
AN MSC INTERNATIONAL COMPANY

1-800-645-3491

(516) 249-9700 • 110 BI-COUNTY BLVD., FARMINGDALE, NY 11735

Logicsoft is a Direct Distributor for
Over 250 Leading Manufacturers and
Publishers of Computer Products Including:
Ashton Tate • AST • Compaq • Epson • Hayes
• IBM • Leading Edge • Lotus • MicroPro • Microsoft
• Okidata • Quadram • Seagate • Tecmar • Word Perfect

SAN FRANCISCO 415-621-4411 BOSTON 617-247-6406 CHICAGO
312-372-0939 BOCA RATON 305-392-4644 HOUSTON 713-227-0201 EUROPE 020-83-4864



Free on-site service and



IBM AT-30 Mb

- 8 MHz • 512K • 30 Mb IBM Hard Drive (Full Height, w/controller) • 1.2 Mb Half/Height Floppy • Eight Expansion Slots • IBM Enhanced PC Keyboard • Serial/Parallel Adapter • Free 90-Day, On-Site Service Contract • Color or Monochrome Monitor Available as Option.
- **Purchase Price: \$3,895**

Lease for **\$155** per month



IBM XT 286-20 Mb

- 6 MHz • 80286 Based CPU • Zero Wait States • 640K • 1.2 Mb Half/Height Floppy • 20 Mb Full/Height Hard Drive • Serial/Parallel Adapter • Eight Expansion Slots • (5) 16-Bit, (3) 8-Bit • IBM PC Enhanced Keyboard • Free 90-Day, On-Site Contract • Color or Monochrome Monitor Available as Option.
- **Purchase Price \$2,799**

Lease for **\$110** per month



IBM XT-20 Mb

- 512K • 20 Mb IBM Full Height Hard Drive • 360K Floppy Drive Half/Height • Eight Expansion Slots • IBM Enhanced PC Keyboard • Asynchronous Communications Adapter • Free 90-Day, On-Site Service Contract • Color or Monochrome Monitor Available as Option.
- **Purchase Price \$2,199**

Lease for **\$92** per month



AT&T 6300

- 640K RAM Memory • One 360K Floppy Drive • Seven Expansion Slots • AT&T Keyboard • High-Resolution Monochrome Graphics Card • High-Resolution Monochrome Graphics Monitor • Serial & Parallel Ports • GW Basic and MS, DOS • Free 90-Day, On-Site Service Contract. Color Monitor Optional.
- **Purchase Price: \$1,299**

Lease for **\$52** per month

FREE ON-SITE SERVICE—

With the purchase or lease of most systems you receive 90 days of free service at your facility. Over 96 authorized service centers to serve you throughout the U.S. with an average 4 hour response time.



LOWEST PRICE COMMITMENT—

Because we are the largest direct distributor, our buying power allows us to offer the lowest possible prices on our wide range of products.



FREE OVERNIGHT DELIVERY—

Buy it today, use it tomorrow on orders totaling over \$100. Due to certain restrictions, some bulk items and orders under \$100 are shipped UPS FREE (within Cont. U.S.).



LOGICSOFT CUSTOMER SERVICES

TOLL-FREE CUSTOMER SERVICE—

On-line computer system allows instant access to customer information. Call 1-800-431-9037.



LOGICLEASE—

Allows affordable low monthly payments, helps eliminate equipment obsolescence, offers outstanding flexibility plus possible tax benefits. 24 hr. lease approval by phone (on orders over \$1000).



SYSTEM CUSTOMIZATION—

Your system customized to your needs plus Free 48 hour configuration, testing and burn-in service so your system is ready to run upon delivery.



• No surcharge for MasterCard, VISA, American Express, C.O.D., money order, check or PO's (please call for price verification) • No sales tax on orders shipped outside N.Y. State • Please add 2% for insurance and handling (\$3.00 minimum) (int'l orders add'l) • We do not bill until we ship. All products covered by mfg's warranty. Defective merchandise may be returned for repair or exchange only. We do not guarantee compatibility. Any goods returned for credit are subject to a 10% restocking charge. All prices and policies subject to change without notice.

5 YEAR WARRANTY

Look for the items printed in **red** to identify Logicsoft's own line of computer hardware products. They are fully compatible with, but priced well below, the major manufacturers. You save—not by our use of inexpensive labor and parts—but through state-of-the-art technology.

Each product carries our 5 year unconditional replace or repair warranty.

SPECIAL

NEW ISOBAR® WITH REMOTE POWER SWITCH AND MODEM PROTECTOR



The most electronically advanced surge suppressor you can buy. Exclusive multiple filters (up to 21 in IB 8-15) protect equipment and data against transient voltage spikes and AC line noise. Isolation feature even guards against equipment interaction between duplex receptacles.

"Cascade Circuitry" design lets you choose the level of protection you need, offering more protection for your more sensitive equipment.

For the most complete spike & noise protection, order the ISOBAR®.

with Remote **\$69**
without Remote **\$65**

PRINTERS*

BROTHER

M-1109	\$209
M-1409	349
M-1509	389
M-1709	509

DICONIX

Diconix 150 (for laptops)	339
---------------------------	-----

EPSON

EX 800	Low Price Call!
EX 1000	Low Price Call!
FX-86E	Low Price Call!

The Nation's I and f



FX-286E	Low Price Call!
LQ 800	Low Price Call!
LQ 1000	Low Price Call!
LQ 2500	Low Price Call!

NEC

P 660	489
P 760	689
CP 660 Color	589
CP 760 Color	799
P 560 XL	1049
P 960 XL	1249

OKIDATA

182 Plug & Play	267
192 Plus (IBM)	379
193 Plus (IBM)	559
290 Series	Low Price Call!
2410P Plug & Play	1759

PANASONIC

KX 1080 i	229
KX 1091 i	299
KX 1595	569

TOSHIBA

321 SL	Low Price Call!
P 341	649
P/S 351 (IBM)	999
351 Color Printer	1299

CITIZEN

MSP 10	299
MSP 15	399
MSP 20	339
MSP 25	499
Premier 35	509

PRINTER BUFFERS

QUADRAM

Microfazer Series	Low Price Call!
-------------------	-----------------

LASER PRINTER*

CANON

Laser Printer LBP8A1	\$1949
Laser Printer LBP8A2	3089

HEWLETT PACKARD

Series 2	1939
----------	------

PLOTTERS*

HEWLETT PACKARD

7475A	\$1629
7550	3275

HOUSTON INSTRUMENTS

DMP 40	879
DMP 41	2599

MONITORS*

AMDEK

Color 600 RGB	\$399
Color 722 (EGA Comp.)	489
Color 725	559
12" Amber 310A	149

12" 300 A	135
410A	159

IBM

Color Monitor	525
Monochrome Monitor	209
Enhanced Color Display	629

LOGICSOFT

Logic RGB 14"	369
Monochrome 12"	99

NEC



Multi-sync color w/swivel base	579
--------------------------------	-----

PRINCETON GRAPHICS

LM 300	559
RGB HX-12 (690x240)	449
RGB HX-12E (EGA Comp.)	535
RGB SR-12	569
Amber Max 12	165

QUADRAM

Amberchrome 12"	149
Enhanced Graphics Monitor w/swivel	479

MULTI-FUNCTION BOARDS

AST RESEARCH

Six Pack Premium	\$299
Six Pack Plus (384K)	209
Rampage w/256K	275
Rampage (AT) w/512K	349
Advantage (128K)	399
I/O Mini Half Card	119
I/O Plus II	125

COMPUTER PERIPHERALS

Half Pint I/O	105
Overachiever 512K	349

LOGICSOFT

Logic Board (Lotus/Intel/ Microsoft Expanded memory specification)	\$135
--	-------

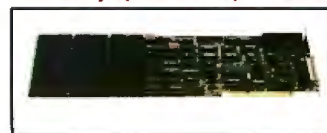

Logic (AST Compatible) Multi-function Board w/ØK w/384K	99
	155-

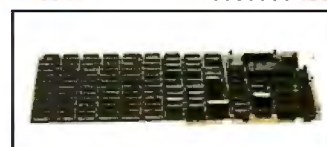

Logic (AST Compatible) AT Multifunction Board w/128K (Expandable to 2.0 Mb)	205
---	-----

NEW!

Increase your productivity and expand your knowledge quickly and easily with state-of-the-art TRAINING VIDEO CASSETTES AND DISKS



One person or an entire staff can work smarter, better, and faster using these effective interactive, hands-on training programs right at your PC. Novice, intermediate and experienced users of business software can profit by learning to use the most popular software quickly and with measurable results.

MICRO VIDEO Learning Systems



are guaranteed because they're designed with companies like Ashton-Tate and Microsoft. Over 50% of the Fortune 2,000 are using these Learning Systems today. V-S or Beta.

	RETAIL	LOGICSOFT
dBASE III Plus	\$495	\$359
IBM PC Primer	\$295	\$259
The 1-2-3 Learning System Release (2.0)	\$495	\$359
Running MS DOS	\$495	\$359
Multimate Advantage	\$495	\$359
Symphony	\$495	\$359

When purchased with corresponding product **SAVE \$20**

Cdex - Intelligence SUDDEN KNOWLEDGE On Disk Training Programs.

New Co-Residency Feature™ allows switching between training program and application program. You can immediately practice skills acquired in the training program through actual application program use.

	RETAIL	LOGICSOFT
Advanced Lotus 1-2-3	\$124.95	\$89
Analyzing Financial Statements with Lotus 1-2-3	\$149.95	\$109
Analyzing Sales Performance with Lotus 1-2-3	\$149.95	\$109
Building a Business Plan with Lotus 1-2-3	\$149.95	\$109
dBASE III Plus	\$124.95	\$89
IBM PC/AT	\$124.95	\$89
IBM PC/XT	\$124.95	\$89
Lotus 1-2-3	\$99.95	\$75
Managing Your Business with Lotus 1-2-3	\$149.95	\$109
Multiplan	\$99.95	\$75
Symphony	\$124.95	\$89
Word Perfect	\$124.95	\$89
Wordstar	\$124.95	\$89

When purchased with corresponding product **SAVE \$5**

Free overnight delivery on software for all your IBM PC applications!

WORD PROCESSING

Display Write IV	\$325
Lotus Manuscript	349
Microsoft Word 3	279
Multimate	239
Multimate Advantage	289
Office Writer	259
PFS Professional Write	115
Volkswriter 3	147
Word Perfect	209
Wordstar	179
Wordstar Professional	
Rel. 4	239
Wordstar 2000	245
Wordstar 2000 Plus	289
XY Write III	219

WORD PROCESSING ADD-ONS

Fancy Font (FX)	\$135
Print Shop	39
Punctuation & Style	85
Turbo Lightning	59
Word Finder	55
Word Perfect Library	59

DATABASE MGMT.

Cornerstone	\$ 65
d Base III Plus	415
d Base III Lan Pak	619
Foxbase Plus	249
Foxbase Plus Multiuser	375
PFS Professional File	145
Paradox	449
Powerbase	185
Q & A	245
R: Base 5000	265

R: Base System V	359
Reflex	89
Revelation	519

DATABASE MGMT. ADD-ONS

Clipper	\$399
Ext. Report Writer	179
Genifer	219
Quickcode III	145
Quick Report	145
Quicksilver	369

SPREADSHEET / INTEGRATED

Ability	\$ 69
Boeing Calc	309
Enable	389
Framework II	419
Lotus 1-2-3	329
Microsoft Multiplan	119
PFS First Choice	95
PFS Integrated	459
Supercalc IV (NEW)	309
Symphony	459

SPREADSHEET ADD-ONS

HAL	\$109
Lotus Report Writer	99
Lotus Metro	65
Quickcode for 1-2-3	85
Sideways	45
Smart Notes	49
Spreadsheet Auditor	95
SQZ	59

DESKTOP PUBLISHING

Click Art Personal Publisher	\$99
Harvard Pro Pub.	445
Page Maker	619
Ventura	659

GRAPHICS

Chartmaster	\$215
Diagram Master	195
Energraphics (NEW)	309
Freelance Plus	339
Harvard Presentation	239
Map Master	225
Microsoft Chart	189
Sign Master	149

CAD/CAM

Auto CAD 2.52	\$2,399
Auto CAD Basic	247
Drafix 1	209
Generic CAD	69
Pro Design II	179

LANGUAGES

BASIC Compiler (MS)	\$255
C Compiler (MS) (4.0)	279
COBOL Compiler (MS)	425
FORTRAN Compiler (MS)	279
Lattice C Compiler	239
Macro Assembler (MS)	97
Pascal Compiler (MS)	183
Quick Basic (MS)	67
True Basic	99
Turbo C	65
Turbo Basic	65

Turbo Pascal (plus BCD & 8087)	65
--------------------------------	----

PROJECT MANAGEMENT

Harvard Total 2	\$375
Microsoft Project	239
Super Project Plus	305
Timeline	235

FINANCIAL

Managing Your Money	\$115
Dollars N' Sense	107

ACCOUNTING

BPI Entry	\$189
Computer Associates	
Low Price Call!	
Great Plains	449
Open Systems (3.0)	419

MISC / UTILITIES

Carbon Copy	\$125
Concurrent PC DOS	165
Copy II PC	35
Crosstalk XVI	99
Dan Bricklin's Demo	59
Disk Optimizer	35
Fastback	89
Microsoft Windows	67
Norton Commander	39
Norton Utilities	55
PC DOS 3.2	78
Remote	149
Sidekick	55
Smart Com II	89
Superkey	45
Traveling Sidekick	49
XTREE	39

2 NEW FREE CATALOGS.

CALL TODAY!

1-800-645-3491

• Brand new **Programmer's Language and Utilities Guide** • A convenient and valuable listing of timesaving tools for the programming professional • Complete with product description.

• Brand new **Productivity Guide** • Full line catalog of software enhancements for the business professional • Full descriptions of templates, memory management, menu management, backup software, training, and much more.

Circle #400 on reader service card

and overnight delivery



Compaq Deskpro 86-40 Mb

• 6, 8 & 4 MHz Clock Speeds • 1 Mb RAM Memory • 80386 Based CPU • One 40 Mb Hard Drive (w/ controller) • One 360K Half/Height Floppy Drive • 6 Expansion Slots • Compaq 101 Keyboard • Color or Monochrome Available as Option.

• Purchase Price: \$5,349

Lease for **\$203** per month



Compaq Deskpro 286-40 Mb

• 640K RAM Memory • 80286 Based CPU • One 40 Mb Hard Drive (w/ controller) • One 1.2 Mb Half/Height Floppy Drive • Seven Expansion Slots • Compaq Keyboard • Graphics Card • One Parallel Port • Free 90-Day, On-Site Service Contract • Color or Monochrome Available as Option.

• Purchase Price: \$3,999

Lease for **\$158** per month



Blue Chip / by Hyundai IBM PC / XT Compatible

• 512K RAM Memory • 4.77 MHz • One 360K Half/Height Floppy Drive • Six Expansion Slots • Low Profile Keyboard • Serial/Parallel Ports • 130 Watt Power Supply • High Resolution. Monochrome Display Card Standard • Abbr. DOS

• Purchase Price: **\$579**

Blue Chip Options:

MS DOS & GW Basic \$79.00
Blue Chip Amber
Monochrome Monitor \$85.00
Blue Chip Green
Monochrome Monitor \$75.00

Additional 360K Half/
Height Floppy Drive \$99.00
10 Mb Hard Drive Option \$365.00
20 Mb Hard Drive Option \$409.00

100% Burn-In and Testing

All systems undergo a 48-hour configuration, testing and burn-in period. We configure system boards, set DIP switches, format hard drives, perform memory diagnostics and check system with monitor.



Zenith Z-181 Laptop

• 640K RAM Memory • CMOS 8088 Running at 4.77 MHz • Two 720K 3.5" Floppy Drives • Supertwisted Backlit LCD Screen • RGB/Monochrome Composite Card • One Parallel and Serial Port • Clock Calendar • External Floppy Drives Optional.

• Purchase Price: \$1,999

Lease for **\$84** per month



NEW! Toshiba Laptop T-1100 Plus

• 640K RAM Memory • CMOS 80C86 Running at 7.1 MHz • Two 720K 3.5" Floppy Drives • One Expansion Slot • TOSHIBA Keyboard • NEW Supertwist LCD Display • Color Graphics/ Monochrome Composite Card • One Parallel and Serial Port • Clock Calendar • External Floppy Drives Optional.

• Purchase Price: \$1,599

Lease for **\$69** per month



Toshiba 3100 Laptop

• AT Power in a Compact Size • 640K RAM Memory • Intel 80286 Running at 8MHz • One 3.5 720K Floppy Drive • One 10 Mb Hard Drive • Gas Plasma Screen • Color/ Graphics/ Monochrome Composite Card • Parallel Port • 81 Key Keyboard.

• Purchase Price: \$3,299

Lease for **\$130** per month

LOGICSOFT[®]
AN MSC INTERNATIONAL COMPANY

100 Bi-County Blvd., Dept. 543
Rm 11735

To order, call our National Hotline:

1-800-645-3491

For Orders or Technical Assistance,
call: (516) 249-9700

Largest selection of peripherals Free overnight delivery!

Logic (AST Compatible)
576K Ram Board 1/2 Card

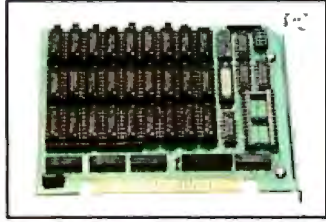

w/384K	119
w/576K	145
Logic (AST Comp.) I/O	
Mini Half Card	105
QUADRAM	
Quadboard (384K)	165
Silverboard	209
INTEL	
Above Board (PS/AT)	
w/128K	389
(PC) w/64K	249
(AT) w/128K	399
(PS) 64K	289
(PS) 256K	399
8087-2 Math	
Co-Processor	179
8087-3 Math	
Co-Processor	125
80287 Math	
Co-Processor 6MHz	199
80287 Math	
Co-Processor 8MHz	275
80287 Math	
Co-Processor 10MHz	355

TURBO CARDS

INTEL	
Inboard 386/AT 1Mb	\$1597
MAYNARD	
Surprise	105
ORCHID	
Jet 386	Low Price Call!
Tiny Turbo	429
Turbo EGA	575
WAVEMATE	
Bullet 286	Low Price Call!

GRAPHICS BOARDS

AST	
Preview	\$239
Six Pack Premium/EGA	
Series	Low Price Call!
ATI	
EGA Wonder Board	299
ORCHID	
Turbo EGA	569
HERCULES	
Monochrome	
Graphics Card	199
Color Card	155
Graphics Card Plus	185
LOGICSOFT	
Logic (Hercules Comp.)	
Color Graphics Board	89



Logic (IBM Comp.) Enhanced
Graphics Adapter (EGA) . . . 239

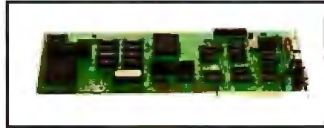

Logic (Hercules Comp.) Monographics Board	89
NEC	
GB1 EGA Board	369
PARADISE SYSTEMS	
Auto Switch EGA Card	339
Modular Graphics Card	199
PRINCETON	
LM 300 A Driver Card	559
QUADRAM	
EGA Plus Graphics	339
Pro Sync EGA	369
STB	
Chaffeur HT	199
EGA Plus	299
TECMAR	
Graphics Master	475
EGA Master	275
VIDEO 7	
VEGA (1/2 Card)	305
VEGA Deluxe (1/2 Card)	369

COMMUNICATIONS BOARDS

AST	
5251-11 Plus	\$655
5251-11	609
DCA	
IRMA Board	779

MODEMS

EVEREX	
Evercom II	\$119
Evercom 2400B Int.	229
HAYES	
Smartmodem 1200	389
Smartmodem 1200B	
w/Smartcom II	359



Smartmodem 2400	585
Smartmodem 2400B	
w/Smartcom II	529

LOGICSOFT

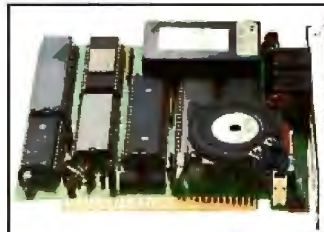

Logic (Hayes Comp.) 1200B Internal Modem with Mirror (Crosstalk Clone) Software	125
Logic (Hayes Comp.) 1200 Baud External Modem	149
Logic (Hayes Comp.) 2400 Baud External Modem	269
Logic 2400B Internal Modem 2400B w/Software	299
PROMETHEUS	
Pro-modem 1200	229
Pro-modem 1200B	139
TOSHIBA	
1200B Laptop Modem (T1100 Plus)	299
ZENITH	
1200B Laptop Modem (Z181)	299

MOUSE INPUT DEVICES

MOUSE SYSTEMS	
PC Mouse w/DR Halo 2	\$119
MICROSOFT	
Microsoft Mouse (Serial)	129
Microsoft Mouse (Buss)	119

SURGE PROTECTORS

TRIPPLITE	
Isobar	\$65
Isobar RM	69

KENSINGTON MICROWARE



Masterpiece Plus	119
LOGICSOFT	
Logic Spike Bar	39
Logic Spike Block	29
CURTIS	
Diamond	35
Ruby	59
NETWORK	
Power Mouse	115

KEYBOARDS

KEYTRONIC	
5151 (Deluxe)	\$169
5151 (AT&T)	189
LOGICSOFT	
Logic Enhanced Keyboard	99

MEMORY STORAGE

IOMEGA	
Bernoulli Box (10 + 10)	\$1999



Bernoulli Box (20 Mb)	1849
Bernoulli Box (20 + 20)	2399
Bernoulli Box Plus	4199

Bernoulli 10 Mb Cartdg. Tripak	13
Bernoulli 20 Mb Cartdg. Tripak	23

HARD DISK DRIVES

MOUNTAIN COMPUTER	
Hard Drive Card (20 Mb)	
or (30 Mb)	Low Price Call

PRIAM CORP.

60 Mb Internal Hard Drive	\$139
Innerspace ID 40 Mb	110
PLUS	

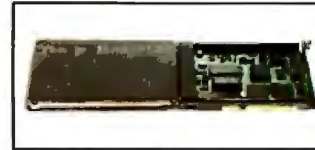

Hard Card 20 Mb	69
-----------------	----

SEAGATE

10 Mb 1/2 Ht Int	37
20 Mb 1/2 Ht Int	40
30 Mb 1/2 Ht Int	51
20 Mb Full Ht (AT)	56
30 Mb Full Ht (AT)	61
40 Mb Full Ht (AT)	73
80 Mb Full Ht (AT)	111

CARTRIDGE TAPE BACK-UP

SYSGEN

Image Tape Backup	
20 Mb Int	\$59
Image Tape Backup	
20 Mb Ext	69

TECMAR

QIC 60 AT (Int)	129
QIC 60 Ext Tape Backup	159
QIC 60 Host Adapter Card	129

FLOPPY DISK DRIVES

Panasonic 360 K 1/2 Ht	\$109
Tandon TM-100 360 K F/Ht	119
Tandon TM-100 360 K 1/2 Ht	109
Toshiba 360 K 1/2 Ht	109
Toshiba Ext. 5.25 360 Drive	309

BACK UP POWER SUPPLIES

DATA SHIELD

200 Wt (PC)	\$299
300 Wt (XT)	399



500 Wt (AT)	599
800 Wt (AT)	699
LOGICSOFT	
Logic 325 WT	399
Logic 450 WT	399
Logic 675 WT	599
Logic 1000 WT	899

Reviews

Reviewer's Notebook 227
by Cathryn Baskin

Beyond Turbo 229
by Wayne Rash Jr.

Turbo-Amiga 235
by Warren Block

Pick of the Litter 238
by William H. Murray and Chris H. Pappas

Four C Language Interpreters 245
by John Unger

Microsoft Windows Development Kit... 250
by David and Lee Hart

Smalltalk/V Release 1.2 256
by Mat Davis

Acquaint 265
by Ernest R. Tello

Zoomracks II 272
by Tyler Sperry

Special BIX supplement: The following bonus reviews appear in the BIX conference jun87.sup: "The IBM PC XT Model 286" (by John Unger), a look at IBM's unusual hybrid of an XT chassis with an AT's CPU; and "Turbo Prolog versus Chalcedony Prolog" (by Robert Schalkoff), two very different, low-cost implementations of Prolog. (For information on joining BIX, see page 337.)

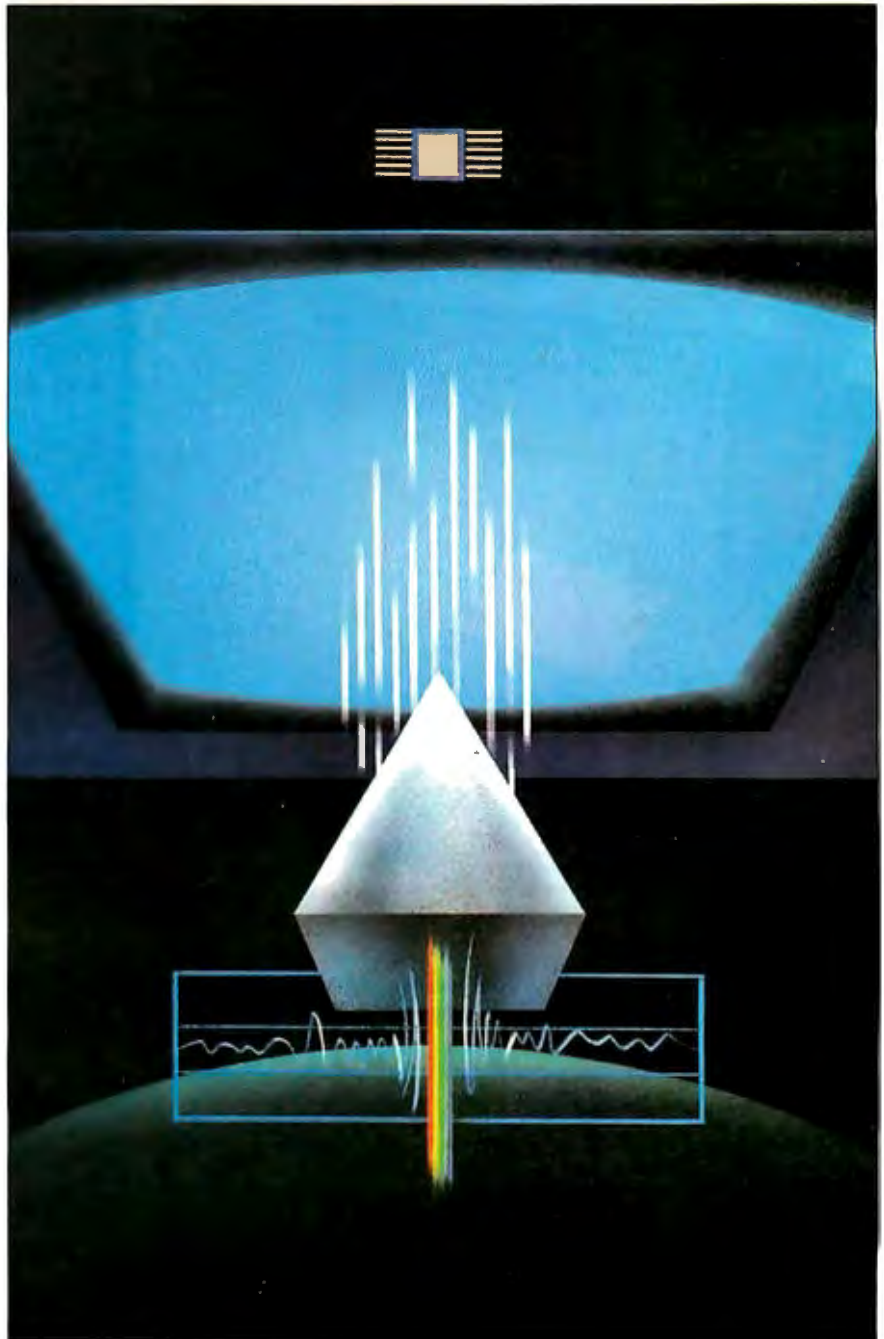

THE START OF SOMETHING BIG.

- Fast plotting minimizes drawing time.
- High quality results through precise and accurate plotting.
 - Automatic pen control for proper pen speed and pressure.
- Priced reasonably for all office applications.

● Plot produced by AUTOCAD™ software (courtesy of Autodesk Inc.)



● \$78,350 (OPTION) WITH SUPPLY

DRAFTING PLOTTER DPX-2200

ANSI-C/ISO-A2 SIZE

- MAXIMUM PLOTTING AREA: 430mm (W) x 594mm (D) (16.93" x 23.35")
- MAXIMUM PLOTTING SPEED: 450mm/sec (18"/sec)
- MECHANICAL RESOLUTION: 0.025mm/step (0.000984")
- PEN USED: 8 Pens
- INTERFACE: Parallel (Centronics) Serial RS-232C
- DPS-20 (OPTION) ORIGINAL STAND FOR DPX-2200

DRAFTING PLOTTER DPX-3300

ANSI-D/ISO-A1 SIZE

- MAXIMUM PLOTTING AREA: 810mm (W) x 1188mm (D) (31.89" x 46.77")
- MAXIMUM PLOTTING SPEED: 450mm/sec (18"/sec)
- MECHANICAL RESOLUTION: 0.025mm/step (0.000984")
- PEN USED: 8 Pens
- INTERFACE: Parallel (Centronics); Serial (RS-232C)
- DPS-36 (OPTION) ORIGINAL STAND FOR DPX-3300

Roland DG

ROLAND DG CORPORATION

1006-14 Takaoka-cho, Hamamatsu-shi, Shizuoka-ken 433, Japan
Phone: (0534)36-8700 Fax: (0534)37-8271 Telex: 4225070 AMDROL J

Inquiry 267

INTERNATIONAL DISTRIBUTER

U.S.A.:

Roland Corp US
Phone: (213) 685-5141 Telex: 0674489 RCUS LSA

CANADA:

Roland DG Canada Inc.
Phone: (604) 273-4453 Telex: 4357819 ROL/AMB VCR

AUSTRALIA:

Roland Corporation Australia Pty. Ltd.
Phone: (02) 982.8266 Telex: 27769 ROL.AUS AA

BENELUX:

FRANCE:
W. GERMANY:
AUSTRIA:
SWITZERLAND:
Roland DG Europe N. V.
Phone: (014) 58 45 35 Telex: 71046 R08NL B

ENGLAND:

Roland (U.K.) Ltd.
Phone: (01) 568 4578 Telex: 934470 ROLAND G

SCANDINAVIA:

Roland Scandinavia A/S
Phone: (01) 32 47 22 Telex: 19720 ROLAND DK

NEW ZEALAND:

Roland Corporation (NZ) LTD
Phone: (09) 398-715 Fax: (09) 391-065

■ If the above doesn't cover your inquiries, please contact Roland DG Corporation, Japan.

REVIEWER'S NOTEBOOK

Turbo BASIC, Borland International's answer to Microsoft BASIC, has elicited yet another BASIC compiler from Microsoft: QuickBASIC 3.0. Like Turbo BASIC, the new version of QuickBASIC supports Intel's 8087 and 80287 math coprocessors. BYTE technical editor George A. Stewart, who wrote the Product Preview of Borland's Turbo BASIC compiler that appears in the March issue, reports below on a pre-release version of QuickBASIC 3.0. (For more details, see page 60.)

Beyond the magazine's pages, two additional reviews appear in the jun87.sup conference on BIX. Robert J. Schalkoff examines two implementations of Prolog: Chalcedony Prolog 1.10 and Borland's Turbo Prolog 1.1. The two implementations are quite different: Unlike Turbo Prolog, a typed compiler, Chalcedony Prolog is an untyped interpreter. Robert recommends Turbo Prolog for beginners because of its friendly, structured environment, many program examples, and compiling capability. Chalcedony Prolog is better if you're looking for full Clocksin and Mellish compatibility. (Contact Borland International, 4585 Scotts Valley Dr., Scotts Valley, CA 95066, (408) 438-8400, and Chalcedony Software, 5580 La Jolla Blvd., Suite 126, La Jolla, CA 92037, (619) 483-8513.)

In the second BIX review this month, John Unger looks at IBM's PC XT Model 286, a hybrid that's a cross between the IBM PC XT and PC AT. Although IBM recently dropped the price of the Model 286 from \$3995 to \$2810, John still considers this a premium price to pay for a PC XT-compatible computer.

—Cathryn Baskin
Senior Technical Editor, Reviews

Microsoft's QuickBASIC 3.0 compiler includes support for the 8087/80287 floating-point processors, allowing math-intensive applications in BASIC to run up to 30 times faster than they can on systems lacking the Intel chip.

To test QuickBASIC's new math capabilities, I ran the Savage benchmark (see *Dr. Dobb's Journal*, September 1983, pages 120 to 122) using Microsoft BASIC 2.0 and 3.0 and Borland's Turbo BASIC 1.0. The host computer was a 4.77-MHz IBM PC equipped with an 8087.

QuickBASIC 3.0 took 6.4 seconds to

Table 1: *Savage floating-point benchmark results.*

Run-time program	Time	Double-precision result	Error
QuickBASIC 2.0	175.5	2499.999999941009	5.899×10^{-8}
QuickBASIC 3.0 with 8087	6.4	2500.000000000087	8.7×10^{-11}
QuickBASIC 3.0 emulating 8087	240.7	2500.00000000024	2.4×10^{-10}
QuickBASIC 3.0 binary-format math pack	175.5	2499.999999941009	5.899×10^{-8}
Turbo BASIC 1.0 with 8087	4.7	2500.000000000005	5.0×10^{-12}
Turbo BASIC 1.0 emulating 8087	139.7	2500.000000000005	5.0×10^{-12}

run the test and had an error of 8.7×10^{-11} . Turbo BASIC 1.0 ran the test in 4.7 seconds with an error of 5.0×10^{-12} . Table 1 summarizes the results of these and additional tests.

Numeric coprocessor support is great for users whose computers have the coprocessor chips but a mixed blessing for those who do not. One standard solution, available in QuickBASIC and Turbo BASIC, is for the compiler to emulate the coprocessor in software. This approach preserves software compatibility but at a great cost in speed. For instance, using 8087 emulation, QuickBASIC 3.0 took 240.7 seconds to run the Savage benchmark with an error of 2.4×10^{-10} . Notice that QuickBASIC's emulation accuracy is different from its 8087 result: Programmers must use caution in writing software that must run the same way in both coprocessor and emulator environments.

For users who don't have 80x87s and don't want to run the slower emulation routines, QuickBASIC 3.0 comes with a noncoprocessor version; the math module is the same one that is used in QuickBASIC 2.0 and BASICA and is based on Microsoft's own binary-format system.

What about compatibility between the two versions? The most obvious problem here concerns random-access data files containing numbers in Microsoft's binary format; these values must be converted to the 80x87's IEEE format before they can be used in a coprocessor environment.

QuickBASIC 3.0 offers a couple of solutions. One is a /MBF configuration switch used when you start the program; it tells the compiler that all numbers in random-access disk files must be converted into the IEEE format as they are read into memory and vice versa as they are written back out to random-access disk files. The other solution is to use a set of the new built-in conversion functions for going back and forth between the two numeric formats.

Another more subtle compatibility issue regards how programs will operate under the IEEE and Microsoft binary-format systems. The IEEE numbers allow for a much wider dynamic range and from one to two digits of added precision. These differences could affect the operation of certain programs that compare values for equality or that generate very large intermediate results. We'll continue to deal with these issues in future reviews of BASIC compilers.

Numeric coprocessor support isn't the only new feature of QuickBASIC 3.0. Perhaps most important for program developers are the improvements to the debugging environment. These include program breakpoints; watch variables, which give you a dynamic view of selected variables' contents; and the generation of descriptive compiler error messages during batch (command-line) compilation.

—George A. Stewart
Technical Editor

What if..you could get a plotter that features 24 ips, the ability to handle A,B,C and D size plots, resolution quality of .0005 inches, an 8-pen turret with variable pen force, a wide range of pens including ball points, an intelligent control panel, 1.2g acceleration, an accuracy factor of .1%. And a host of other options. All for only \$6495.

The new CalComp 1041GT.

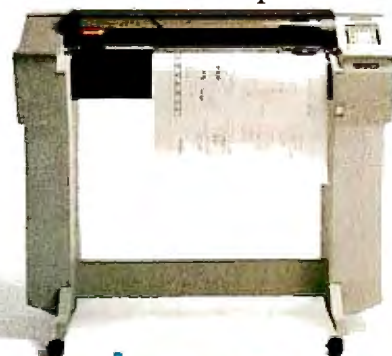

 **CalComp**

A Lockheed Company

For more information call 1-800-CALCOMP
Or write CalComp, P.O. Box 3250, Anaheim, CA 92803

Inquiry 347 for End-Users. © 1986 CalComp
Inquiry 348 for DEALERS ONLY.



Beyond Turbo

Wayne Rash Jr.

*PC's Limited's 286¹² and Wells American's A*Star II, two 12-MHz machines*

The quest for speed continues. With each passing month, the speeds of Intel 80286-based computers creep inexorably higher. Two of the latest speed demons are PC's Limited's 286¹² and Wells American's A*Star II. These fast machines are relatively low-cost clones of the IBM PC AT. The 286¹² has a list price of \$1999 for the basic model, and the A*Star II basic model costs \$2295. They are both much faster than the PC AT and boast some unique capabilities.

The 286¹² is distinguished by having a front panel of sorts. This feature has all but disappeared from personal computers; 10 years ago, nearly every machine had one. The front panel is a small alphanumeric display that tells what the computer is doing. When you boot the 286¹², it lists the boot-up ROM programs that are running. After boot-up, the display shows the microprocessor speed when it is changed, the letter of the disk drive being used, and the number of the track that's being accessed.

The A*Star II that I reviewed came configured for network use (see the text box "Using the A*Star II LAN" on page 000), and it signs on calling itself a multi-user computer. It also came with the Wells American Multiuser Network Operating System. This computer is obviously aimed at the business market; its version of GW-BASIC is labeled "Business BASIC." Unlike the 286¹², which is switchable only between 6 MHz and 12 MHz, the A*Star II gives you a wealth of speed choices. It is switchable among 6, 8, 10, and 12 MHz, and you can choose between no wait states and one wait state in the 6- and 8-MHz speeds. This enables you to operate add-on boards at their highest possible speeds, even if they



won't go as fast as 12 MHz.

The great speed of these computers is likely to cause problems with add-on boards, especially memory boards. [Editor's note: *For more information on this problem, see "Nine PC AT Multifunction Cards" by Wayne Rash Jr. in the January BYTE.*] There was a time when some software companies had copy-protection schemes that depended on a 6-MHz microprocessor on a PC AT to work, but this practice has mostly been abandoned. I have not found any software that has problems running at 12 MHz, although some games run too fast to be played.

The 286¹²

The 286¹² allows you to switch microprocessor speeds at any time. This switching can take place within a program, which means that if you have software that needs

6-MHz speeds to satisfy its operation or copy protection, you can still run at 12 MHz the rest of the time.

You switch between speeds by simply typing the Ctrl-Alt-\ (backslash) key sequence. When you shift to 6 MHz, you are greeted by a single beep from the speaker, and the front panel says "6 Mz." A shift to 12 MHz results in a two-tone beep and a "12 Mz" reading from the front panel. While writing this paragraph, I was able to switch speeds from within WordStar without problems.

The front-panel display is called SmartVu, and it is a handy device. Besides telling you how fast the machine is running, the SmartVu readout can display error messages and diagnostic indicators. When you perform a cold boot, the display indicates which ROM diagnostic routines are being run. When the memory is tested, you get a display of the RAM address that is under test. When the time comes to boot the system, the word boot appears on the display, followed by the drive and track that the disk controller is telling the drives to read.

All this activity is reassuring, but there's more to it than that. If the machine fails to boot, you can see where in the process the failure happened. If a program hangs, you will see that the disk drives are no longer accessing tracks, despite the drive light being on. Next to the SmartVu readout are two LEDs: a green

continued

Wayne Rash Jr. is a member of the professional staff of American Management Systems Inc. (1777 North Kent St., Arlington, VA 22209), where he consults with the federal government on microcomputers.

PC's Limited 286¹²**Wells American A*Star II**

Company: PC's Limited
1611 Headway Circle, Bldg. 3
Austin, TX 78754
(512) 339-6800

Size: 21 by 16½ by 6½ inches; 43 pounds

Components: Processor: intel 80286, switchable between 6 MHz and 12 MHz with one wait state
Memory: 1 megabyte, expandable to 16 megabytes
Mass storage: One half-height 5¼-inch 1.2-megabyte floppy disk drive or one 360K-byte floppy disk drive and one 40-megabyte hard disk drive
Display: 12-inch monochrome, EGA, or CGA; 80 characters by 25 lines
Keyboard: 84 keys; 10 function keys; indicator lights for Caps Lock, Scroll Lock, and Num Lock keys
I/O interfaces: Eight slots: two IBM PC-compatible, six PC AT-compatible; two parallel ports on monochrome system; one parallel port on EGA system; two serial ports; one game port

Options:

I/O adapter card:	\$99
EGA video card:	\$299
CGA/EGA color monitor:	\$529
360K-byte floppy disk drive:	\$109
40-megabyte hard disk drive:	\$849

Documentation: User's manual, 102 pages

Price:

Basic system:	\$1999
With 40-megabyte hard disk drive, 1.2-megabyte 5¼-inch floppy disk drive, and EGA color monitor:	\$3499

Wells American
3243 Sunset Blvd.
West Columbia, SC 29169
(803) 796-7800

21¼ by 17¼ by 6½ inches; 37 pounds

Processor: Intel 80286, switchable among 6, 8, 10, and 12 MHz (optional) with one wait state; also switchable between no wait states and one wait state for 6 and 8 MHz
Memory: 1 megabyte, expandable to 16 megabytes
Mass storage: One half-height 1.2-megabyte 5¼-inch floppy disk drive or one 360K-byte floppy disk drive and one 30-megabyte hard disk drive
Display: 12-inch monochrome; 80 characters by 25 lines
Keyboard: PC AT-style: 84 keys; 10 function keys; indicator lights for Caps Lock, Scroll Lock, and Num Lock keys; RT PC-style: 101 keys; 12 function keys; indicator lights for Caps Lock, Scroll Lock, and Num Lock keys
I/O interfaces: Eight slots: two IBM PC-compatible, six PC AT-compatible; two serial ports; one parallel port; one game port

PC-DOS 3.1:	\$85
360K-byte floppy disk drive:	\$130
30-megabyte hard disk drive:	\$855
Monochrome monitor:	\$105
Video display card and parallel port:	\$95
I/O adapter card:	\$85
12-MHz capability:	\$395
Multiuser Network Operating System:	\$395
A*Star II Network adapter card:	\$395
A*Star II Network adapter/amplifier card (required for a workstation net with more than 32 stations):	\$495

User's manual, 23 pages

Basic Model 300 with 30-megabyte hard disk drive, I/O adapter card, and 1 megabyte of RAM: \$2295
Basic Model 300 with A*Star II Network adapter card, monochrome graphics adapter, and monochrome monitor: \$2890

one, which lights when the computer is running at 12 MHz, and a red one, which lights when the hard disk is in use.

The more I used SmartVu, the better I liked it. Some applications require long periods of disk use, and it's comforting to see that the disk and the computer are both really working.

Inside the 286¹²

The 286¹² has a traditional IBM-style interior layout. It has eight expansion slots,

six of which are 16-bit slots. The machine that I reviewed came with the maximum of 1 megabyte of memory on the motherboard. The 256K-byte, 100-nanosecond memory chips are soldered in place, so you'll need to have PC's Limited repair your machine if a RAM chip fails.

Located near the left edge of the motherboard is a DIP switch used for configuring the system. It is very much like similar switches on other PC AT

clones, but, in a nice touch, PC's Limited has printed the switch functions next to the switch. This means that you don't have to dig out the manual every time you want to change display cards, for example.

The 40-megabyte Micropolis hard disk drive is located in the center of the computer. To the right is the bay for the 1.2-megabyte floppy disk drive, and enough room is left over for two other half-height disk drives, tape drives, or additional

DISK ACCESS IN BASIC (IN SECONDS)

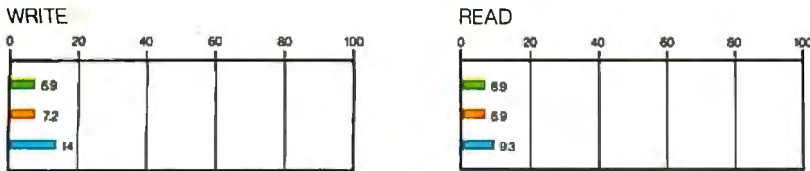

BASIC PERFORMANCE (IN SECONDS)

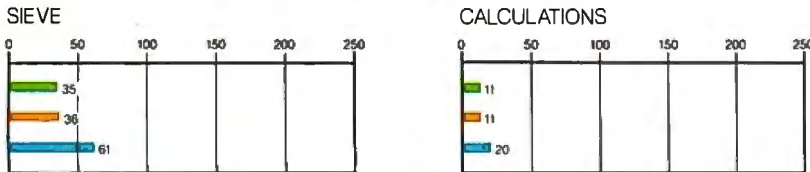

SYSTEM UTILITIES (IN SECONDS)



SPREADSHEET (IN SECONDS)



■ PC'S LIMITED 286¹² ■ WELLS AMERICAN A*STAR II ■ IBM PC AT (8 MHZ)

The graphs for Disk Access in BASIC show how long it takes to write and then read a 64K-byte sequential text file to a 30- or 40-megabyte hard disk. (For the program listings, see *BYTE's Inside the IBM PCs*, Fall 1985, page 195.) The Sieve graph shows how long it takes to run one iteration of the Sieve of Eratosthenes prime-number benchmark. The Calculations graph shows how long it takes to do 10,000 multiplication and 10,000 division operations using single-precision numbers. The 40K Format/Disk Copy benchmark was not performed because the computers had only one floppy disk drive. The 40K File Copy graph shows how long it takes to copy a 40K-byte file using the system utilities. The Spreadsheet graphs show how long it takes to load and recalculate a 100-row by 25-column spreadsheet in which each cell equals 1.001 times the cell to its left. The spreadsheet used was Microsoft Multiplan 1.06. Tests on the 286¹² were done using MS-DOS 3.1 and GW-BASIC 3.1. Tests on the A*Star II were done using PC-DOS 3.1 and GW-BASIC 3.1. PC-DOS 3.2 and BASICA 3.2 were used for the 8-MHz IBM PC AT.

mass storage devices.

The 286¹² uses a 192-watt power supply, which should be adequate for any internal add-on equipment. The fan that cools this supply is louder than most, but it is not loud enough to cause distraction.

Using the 286¹²

The 286¹² that I reviewed had an optional I/O adapter card with two serial ports, one parallel port, and one game port. Also included was PC's Limited's op-

tional EGA video card and CGA/EGA color monitor. The monitor is manufactured by Mitsubishi and produces text and graphics that are crisp and easy to read.

The keyboard has the same layout as the original PC AT design. The 10 function keys are on the left side in two vertical columns of five, and the Ctrl key is in its traditional location next to the A key. The keyboard has a crisp touch with distinct but unobtrusive audible and tactile feedback.

The 286¹² has an extensive set of user-selectable routines available in ROM. You can access these by simply pressing the Ctrl-Alt-Return key sequence. This causes a menu to appear on the screen.

The machine's ROM menu allows you to run the Setup program, park the hard disk heads, and find out the meaning of the error codes on the SmartVu readout. You can also set up some special operating conditions, such as not requiring a monitor or keyboard, or you can disable parity checking for RAM. All these capabilities are useful if you need to diagnose a problem.

When you change the configuration of the 286¹² (by adding more memory, for example), you get the same warning as you do on other PC AT clones; that is, you are alerted to the fact that the amount of memory actually in the machine and the amount of memory that the machine "thinks" it's supposed to have are different. Also, as with most other machines, you're asked to press F1 to continue. At this point, most other PC AT clones require you to go through the setup menus and figure out how much memory you need to add. The 286¹² also has a menu. But once you choose to make the memory adjustment, the computer takes care of the rest for you. The adjustment is made automatically, saved to the battery-backed CMOS RAM where configuration information is stored, and you are returned to MS-DOS. This is a procedure that other companies should consider for their machines.

Getting Started

Other than instructions for entering information about the configuration into memory, there's little in the user's manual about getting started with the machine. The 286¹² does not come with MS-DOS. In addition to the Setup program that is supplied on a disk for configuring the computer, you'll need a version of DOS and its manual to format and use the hard disk. I substituted Zenith's MS-DOS version 3.1, and it worked fine.

The A*Star II

Like the 286¹², the Wells American A*Star II is a fast, capable machine. While it lacks the flash of the front-panel display, it boasts the widest selection of microprocessor speeds of any machine I've used. The A*Star II comes with 6-, 8-, and 10-MHz speeds as standard equipment. The 12-MHz speed capability is a \$395 option.

Changing speeds on the A*Star II is not as convenient as it is on the 286¹². For the A*Star II, you have to run a program called Speed. You enter SPEED and a nu-

continued

meric value for the proper speed (e.g., SPEED/12) at the system prompt. This returns a multiple tone that sounds a lot like something from a video game. You can do this from within a program, such as WordStar, only if the program will allow you to execute another program from within it. While this is a little more involved than the procedure for the 286¹², it's still practical. With many machines, you can change their speeds only with a switch, and you must reboot immediately thereafter.

Inside the A*Star II

At first glance, the interior of the A*Star II is very much like that of the 286¹². The motherboard has eight expansion slots, six of which have 16-bit connectors. The machine that I reviewed came with an optional adapter card with two serial ports, one parallel port, and one game port. The 30-megabyte Seagate ST4038 hard disk is mounted in the center, flanked on the right by the 1.2-megabyte 5¼-inch floppy disk drive. There is room for two more half-height floppy disk drives, tape backup units, or hard disk drives. The power supply can handle a hefty 220 watts,

which should satisfy nearly any requirement.

Despite the similarities between these two machines' interiors, there are also some important differences. The A*Star II's RAM chips are 256K-byte, 120-ns SIPs (single in-line packages). They are mounted on edge to conserve space. The first 512K bytes of RAM is soldered in place on the motherboard, and the remaining 512K bytes of memory is socketed, allowing easy removal and replacement.

A feature that will be appreciated by all-night hackers is that the batteries that power the A*Star II's CMOS RAM are four standard alkaline AA penlight cells. A box of these cells is included with the computer, and you can easily get replacements. This will save trouble for all users in the long run, because ordering batteries from the factory will no longer be necessary, and users won't have to call in a service representative to replace batteries.

On the rear of the machine is a system reset switch. This is an important addition that most clone companies are leaving off of their machines. With a reset

switch, you have a chance of recovering your information if your software crashes and the machine does not respond to the Ctrl-Alt-Del key sequence.

Using the A*Star II

The A*Star II that I reviewed came with the optional monochrome monitor made by Wells American. The optional video display card is a clone of the Hercules graphics card. The result is crisp, clear text and excellent graphics. The card is compatible enough with the Hercules card to run Lotus Freelance Plus without a hitch.

Two keyboards are available for the A*Star II, one of which is a copy of the original IBM PC AT keyboard, and the other is a faithful copy of the 101-key enhanced keyboard that is on the current PC AT. The 84-key keyboard that came with my review unit was defective, and it caused double characters to show up from time to time. A new keyboard solved the problem. The Wells American keyboards have more obvious tactile and audible feedback than the 286¹²'s, but they are not loud enough to be objectionable.

Like the 286¹², the A*Star II handles

Using the A*Star II LAN

Wells American bills its A*Star II as a multiuser business machine. One of the reasons for this label is the local-area network that the company produces for use with the A*Star II. Wells American included an A*Star II Network adapter card and a coaxial cable with the unit I used for this review. I tried it out using the A*Star II as the file server and the PC's Limited 286¹² as a workstation. I also attempted to add a Zenith Z-148 to the network as a second workstation.

The Wells American Multiuser Network Operating System is a baseband LAN with a data transfer rate of 1.25 megabits per second. This is slightly faster than the 1-megabit-per-second Corvus Omninet and about one-eighth the speed of the 10-megabit-per-second 3Com version of Ethernet. It is not Netbios-compatible.

Of course, the actual speed at which data will transfer depends on many factors besides the raw capabilities of the hardware. Factors that slow a network down include the number of users, the capabilities of the network software, and the level of traffic on the network. As a result, most 10-megabit-per-second networks rarely transfer information faster than half their potential speed.

The Wells American LAN will support 256 independent users with a maximum of 254 workstations, and it will support up to 250 megabytes of disk space. It costs only \$395 per workstation. Of course, you have to add the cost of an A*Star II computer, since the network requires that the A*Star II be dedicated as a file server.

Setting Up

The preliminary manual states that the network is designed so that any user can set the network up and use it. The interface boards are, according to Wells American, easy to install. Given the proper instructions, they may well be. Unfortunately, I tried to use this network with the preliminary documentation. Pictures, drawings, and examples would have been welcome. Because of this, my installation of the network was not entirely successful.

I did get the network to run, however. I was able to set up the A*Star II as the file server, and the PC's Limited 286¹² functioned as the workstation. I was able to move files to the server and run programs from there. I was not able to get the Zenith Z-148 to function as a workstation, however. It refused to recognize the existence of the network. I don't

know if this was due to a compatibility problem with the Z-148 or with the LAN. [Editor's Note: *Wells American says it has not heard of any compatibility problems with its LAN during installation on other brands of computers*

I was able to set up a variety of disk partitions on the A*Star II, ranging from disk G: to disk K:. The disk F: partition, which was supposed to be available, refused to format. The network is designed to give each user access to as many as four public areas of the server's disk, as well as an additional four private areas. Again, this may have been a problem with the documentation or my installation. [Editor's note: *Wells American said it did not know what caused the problem.*]

Is It Worthwhile?

Setting up a network is one area in which even an experienced user needs detailed instructions and plenty of examples. In addition, a new user needs easy access to technical support. The instructions in the preliminary manual are sketchy at best. Fortunately, the help from Wells American is good. Still, you should consider your personal skills in this area before you take on the task of becoming a network administrator.

changes in configuration with aplomb. While the procedure for the A*Star II is slightly different, you still must press the F1 key and proceed to the setup menu in ROM. As with the 286¹², the A*Star II takes care of making the changes in configuration; you need only give it permission to do so.

Getting Started

Included with my A*Star II was the system setup disk and a copy of IBM's PC-DOS 3.1. Wells American offers PC-DOS 3.1 as an option for \$85. There is specific information in the hardware manual about getting the computer running, but without the PC-DOS manual, a novice user wouldn't have enough information to format and use the hard disk drive. My review machine also came with the optional Multiuser Network Operating System for Wells American's local-area network, as well as drivers for the monochrome graphics card.

Documentation and Service

Neither of these computers excels in the completeness of its documentation. Of the two, however, the 286¹² has the superior user's manual. This is not to say that the A*Star II's manual is inadequate, but that it contains the minimum information necessary.

The A*Star II user's manual is only 23 pages long. It includes a number of drawings that clearly illustrate the procedures being covered, and basic operations are explained. Also included is a discussion of some of the initial steps necessary for setting up the system with PC-DOS.

The 286¹² user's manual also contains all the information you need to set up and operate the system. In addition, it gives clear explanations of troubleshooting, adding accessories, and a description of operations supported by the ROM. Regrettably, it also contains some errors in its description of the SmartVu functions. A function called SmartVu Scan, a bar graph display that is available on other PC's Limited computers, such as the 286⁸ and the 286¹⁰, was not available on my review machine.

Neither PC's Limited nor Wells American has a large national dealer network. In situations such as this, service is always a concern. Wells American has retained the RCA service organization to provide repairs of its equipment. RCA service is widespread, so service should be readily available. PC's Limited doesn't offer third-party service, but it does offer to help resolve problems over the phone when you call its toll-free number. When this will not work, you must ship the computer back to PC's Limited's service facilities. The company says that

you need to call for a return authorization before shipping your computer.

The benchmark times for these machines were very similar—within a few tenths of a second of each other. I performed benchmarks on the hard disks only and used a larger spreadsheet developed for faster machines for the Spreadsheet benchmarks.

The times obtained for these tests echo the closeness of the times in the other tests. The results for the Sieve and Calculations benchmarks show these machines to be almost twice as fast as the 8-MHz

IBM PC AT. For the complete benchmark results, see page 231.

The Final Verdict

I enjoyed working with both of these machines. Of the two, I preferred the PC's Limited 286¹², primarily because of the SmartVu readout and the ease of changing speeds. However, I was concerned with the limited service arrangements. Frankly, I would not refuse either machine if I had to work with one on a regular basis. These machines perform well, and they are quite fast. ■



Arity/Prolog. Not for the meek. But Arity/Prolog[®] is for you...if you hunger for the power to create sophisticated programs right on the IBM[®] PC. Everything from weather prediction and process control systems to database design and medical diagnostic software.

It's for you if you're already building programs on the PC and now want to do things you've never done anywhere but on a VAX[™] or mainframe. And it's for you if you've read all about the new programming technologies and are ready to start coding.

Whatever your need, Arity/Prolog offers a total development environment including Arity/SQL and Arity/Expert. It even has an open architecture so you can work with other languages and software packages.

So if you're ready to boldly face the future of programming now, write for more information and an Arity power mask: **Arity**, 30 Domino Dr., Concord, MA 01742. Or call **1-800-PC-Arity** (in MA 617-371-1243).



MICROSERVE GUARANTEES THE LOWEST PRICE FOR QUALITY COMPATIBLES OR YOUR MONEY BACK!*

PRO-PLUS+™ XT TURBO

PRO-PLUS+™ AT TURBO



\$659
COMPLETE!
 With One 360k Floppy
 and One 20Mb Hard Drive
ONLY \$959

\$1199
COMPLETE SYSTEM!

Requests For Bids
 on High Volume
 Orders Welcomed



STANDARD FEATURES:

- IBM PC/XT Compatible
- 4/8 MHZ CPU speeds
- 640k RAM Memory
- Two 360k Diskette Drives
- 150 Watt Switching Power Supply
- FCC Approved Chassis
- AT Style Keyboard
- High-Resolution Amber Monitor
- Hercules Compatible Graphics Card
- Parallel Port
- User Manual
- Complete and Ready to Run!

STANDARD FEATURES:

- IBM AT Compatible
- 6/10 MHZ CPU speeds
- 1Mb RAM Memory
- One High Density 1.2 Mb Diskette Drive
- Hard/Floppy Disk Controller Card
- 200 Watt Switching Power Supply
- FCC Approved Chassis
- Enhanced AT Style Keyboard

- High Resolution Amber TTL Monitor
- Hercules Compatible Graphics Card
- On-Board Clock/Calendar
- Parallel Port
- User Manual
- LAN & Multi-User Ready
- Complete and Ready to Run!

**CALL MICROSERVE FOR QUOTES
 ON CONFIGURATION OF YOUR CHOICE**

MICROSERVE Computer Products are the Highest Quality and Best Values on PC/XT and AT Compatibles!

HARD DRIVES

Seagate 20Mb w/contr. ST225 . . .	\$335
Seagate 30Mb w/contr. ST238 . . .	389
Seagate 20Mb for AT ST225	289
Seagate 30Mb for AT ST4038	529
Seagate 40Mb for AT ST251	629
Seagate 80Mb for AT ST4096	929

MONITORS

Amber TTL w/Tilt Swivel Base . . .	\$119
Color RGB Monitor	279
EGA Monitor w/Card	569

PRINTERS

Panasonic 1080I	\$219
Panasonic 1091I	269
Okidata 182	229
Okidata 192+	350
Okidata 193+	525
Citizen 120D	189
Citizen MSP10	279
Citizen MSP20	315
Citizen MSP15	379
Citizen MSP25	459
Toshiba P321	445
Toshiba P341E	659
Toshiba P351III	929

**MOST ORDERS SHIPPED
 WITHIN 48 HOURS**

*** PURCHASE WITH CONFIDENCE!**

Here is our commitment to you:

30 Day Money-Back Guarantee — If you are not satisfied with any item you purchase from MicroServe, you may return it within 30 days of the date of shipment for a full refund. Returns must be "as-new", not modified or damaged, with all warranty cards, manuals, and original packing intact, and must be pre-authorized by MicroServe, and be shipped prepaid and insured.

One Year Limited Warranty — MicroServe Corporation warrants the products it manufactures to be free from defects in materials and workmanship for a period of one year from the date of shipment. During this one year period, MicroServe will repair or replace, at its option, any defective products or parts at no additional charge, provided the product is returned, shipping and insurance prepaid, to the MicroServe repair facility.

TERMS: All prices subject to change without notice. Shipping is FOB Phoenix, AZ. Minimum shipping charge is \$2.50. UPS C.O.D. is \$3.00 additional. Arizona residents only, add 6.7% sales tax. Allow extra two weeks shipping time when paying by personal or company check. No extra charge for MasterCard or Visa orders. All shipments sent insured. A Returned Materi-

al Authorization number obtained from MicroServe in advance must be shown on the shipping label for all returns. All systems are burned-in and tested for 24 hours. We configure systems boards, set up switches, format hard drives, perform all diagnostics, and check the system with your monitor. All systems are FCC approved: Class 15J, Part B.

CALL TOLL FREE:

1-800-621-8285

(In Arizona, Call: 1-252-0017)



Turbo-Amiga

Warren Block

A peripheral for the Amiga 1000 that's actually another computer

The Turbo-Amiga add-on package for the Amiga 1000 by Computer System Associates (CSA) consists of Motorola's 68020 processor, a 68881 math coprocessor, and 512K bytes of 32-bit-wide RAM for \$3670.

The Turbo-Amiga connects to the expansion slot of the Amiga 1000 and essentially takes over the machine when it runs. Housing for the processor and memory cards is provided by a five-slot Zorro-compatible expansion box, which is called the Turbo Chassis, with a 100-watt switching power supply and cooling fan. (Zorro is a bus standard designed by Commodore that expands the 86-pin expansion slot to a 100-pin backplane.) One slot on the Chassis is occupied by the 68020/68881 processor board, and another is taken up by the 512K-byte memory board, leaving three slots for other expansion options.

CSA also offers a 2-megabyte 32-bit-wide memory board, an SCSI (small computer system interface) hard disk controller, and 20-, 40-, or 80-megabyte hard disks to fit inside the Turbo Chassis. Also available is a removable portable Secure Data Cartridge (essentially a self-enclosed 20-, 40-, or 80-megabyte hard disk) for applications in which security or portability of data is necessary. [Editor's note: CSA also offers a board with a 68020 processor and a 68881 coprocessor, as well as a 32-bit 512K-byte or 2-megabyte memory board for the Amiga 2000. The processor board fits into the 2000's processor slot, and the memory boards fit into the Amiga bus slot. These products will be available when Commodore begins shipping the Amiga 2000.]

Hardware and Software

The Turbo-Amiga's 32-bit 68020 processor runs at 14.28 MHz, twice the speed of the Amiga's 32-/16-bit 68000. Another increase in speed is possible using the Turbo-Amiga's 32-bit-wide memory, allowing you to fetch a 32-bit memory value with one 68020 processor access

rather than the two required for the 16-bit-wide Amiga 1000's RAM. The data-bus connection between the Amiga 1000 and the Turbo-Amiga is only 16 bits wide, so any transfer of data between the two devices will not benefit from the use of the Turbo-Amiga's memory. Additionally, graphic images must be located in the 16-bit-wide memory on the Amiga 1000 for the blitter chip to address them.

The Turbo Chassis is a 10- by 9-inch metal box that is the same beige color as the Amiga and has large rubber feet on the bottom. On the front are two LEDs: One is a power indicator, and the other shows when the internal hard disk is being accessed. The latter is unused when the hard disk option is not present (as was the case with the review unit I examined). Four vertical slots in the front of the box allow air circulation for the internal boards. The construction is rugged and somewhat utilitarian.

Included with the Turbo-Amiga is a 3½-inch floppy disk with programs for enabling and testing the Turbo-Amiga: ABasiC version 1.0 (Metacomco's BASIC interpreter that was originally packaged with the Amiga), BASIC programs for testing the Turbo-Amiga's memory and 68881 math coprocessor, and a public domain program that plots Mandelbrot graphics.

The documentation provided with the unit that I reviewed consisted of two binders with photocopied instruction sheets prominently marked "Preliminary." The sheets were copies of various articles describing the 68020 and 68881 chips; engineering drawings of the chassis, processor, and memory boards; and benchmark times and listings. The sections describing the installation and use of the Turbo-Amiga were terse, but, con-

sidering the ease with which you can install the hardware, they were sufficient. [Editor's note: The documentation now provided with the Turbo-Amiga consists of two manuals: 68020

Turbo User's Manual and 68020 Turbo User's Manual and Illustrated Parts List.]

Installation and Use

To connect the Turbo-Amiga, you remove the plastic cover to the Amiga 1000's expansion port and slide the Turbo-Amiga's connector into it. This makes the computer about 9 inches wider, which presents a problem if you own an external disk drive, as the Turbo-Amiga occupies the area where the drive normally rests. However, you can resolve this problem and save space by setting the external disk drive vertically on top of the Amiga 1000 between the monitor and the Turbo-Amiga.

The documentation warns that you should always apply power to the Turbo-Amiga first instead of to the Amiga 1000, lest you damage both machines. The simplest way to accomplish this is by plugging the Amiga 1000 and the monitor into the electrical outlets provided on the back of the Turbo Chassis.

My initial experiences with the Turbo-Amiga were frustrating: The system would usually, but not always, crash when I loaded another disk into the disk drive. The documentation warned that some Amigas might require a small hardware patch to work correctly with the new equipment due to inadequately grounded chips on the Amiga's Kickstart RAM daughterboard. Installing the patch voids the warranty on the Amiga, but, since mine had expired, I went ahead and installed it. The patch consisted of solder-

continued

Warren Block (1921 5th St., Apt. 3, Rapid City, SD 57701) is a freelance writer who has been interested in computers since 1979.

Turbo-Amiga

Type

Expansion chassis with a 68020 processor, a 68881 math coprocessor, and 512K bytes of RAM for the Commodore Amiga 1000

Company

Computer System Associates Inc.
7564 Trade St.
San Diego, CA 92121
(619) 566-3911

Size

10 by 9 by 8¾ inches; 11 pounds

Components

Processor: 14.28-MHz Motorola 68020 with 68881 math coprocessor
Memory: 512K bytes of 100-nanosecond, 32-bit-wide RAM
Chassis: Five-slot Zorro backplane with 100-watt switching power supply and fan

Software

One 3½-inch disk with ABASIC 1.0 and utility, test, and demonstration programs; not copy-protected

Options

- 2-megabyte 32-bit static memory board: \$3995
- SCSI hard disk controller: \$745
- 20-megabyte hard disk: \$945
- 40-megabyte hard disk: \$2200
- 80-megabyte hard disk: \$2300
- 20-megabyte Secure Data Cartridge: \$895
- 40-megabyte Secure Data Cartridge: \$3895
- 80-megabyte Secure Data Cartridge: \$4090
- Turbo Chassis for Secure Data Cartridge: \$995

- Amiga 2000 products:
- 68020/68881 processor board: \$1480
- 512K-byte 32-bit static memory board: \$1295
- 2-megabyte 32-bit static memory board: \$3995

Documentation

68020 Turbo User's Manual
68020 Turbo User's Manual and Illustrated Parts List

Price

- 68020/68881 processor board: \$1480
- 512K-byte 32-bit static memory board: \$1295
- Turbo Chassis: \$895

DISK ACCESS IN BASIC (IN SECONDS)

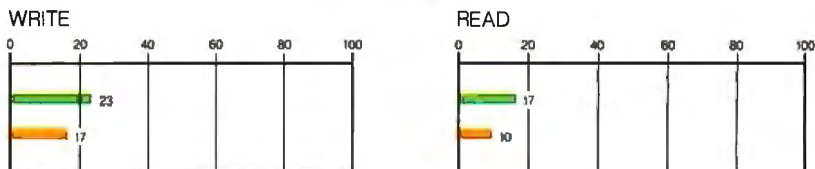

BASIC PERFORMANCE (IN SECONDS)

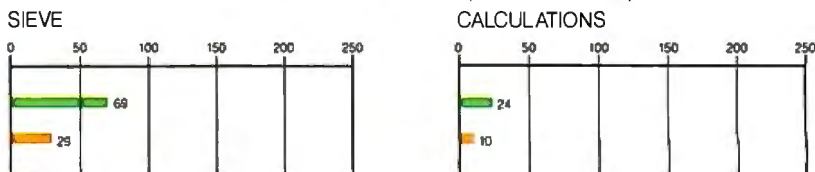

SYSTEM UTILITIES (IN SECONDS)

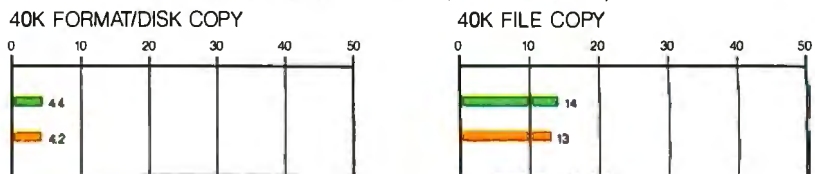

SPREADSHEET (IN SECONDS)

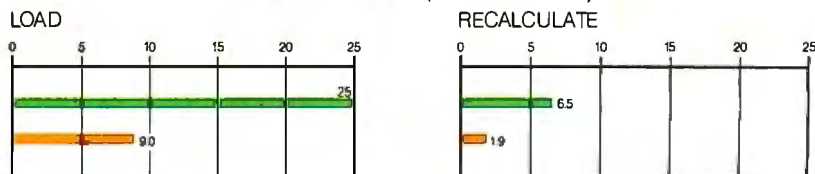

■ AMIGA 1000 ■ TURBO-AMIGA

The graphs for Disk Access in BASIC show how long it takes to write and then read a 64K-byte sequential text file to a blank floppy disk. (For the program listings, see *BYTE's Inside the IBM PCs*, Fall 1985, page 195.) The Sieve graph shows how long it takes to run one iteration of the Sieve of Eratosthenes prime-number benchmark. The Calculations graph shows how long it takes to do 10,000 multiplication and 10,000 division operations using single-precision numbers. The System Utilities graphs show how long it takes to format and copy a 40K-byte file using the system utilities. The Spreadsheet graphs show how long it takes to load and recalculate a 25- by 25-cell spreadsheet in which each cell equals 1.001 times the cell to its left. The Calculations benchmark had to be modified (the DEFSNG statement was removed) before it would run. Tests were run using Kickstart/Workbench 1.2. The spreadsheet used was Lattice's Unicalc 1.0; Metacomco's ABASIC 1.0 was used for all BASIC tests. Note: The System Utilities times originally reported in the Amiga 1000 review (October 1986 *BYTE*, page 234) are in error. The correct times are presented here.

ing a jumper between three points on the daughterboard, and this operation cured the problem. Although the modification should be unnecessary on most Amigas, individuals who know their way around with a soldering iron should have no problems with it, although you should check with CSA to confirm that the patch is necessary before trying it. This is because there is no pattern to the problem: It can plague a new or an old Amiga 1000.

When the Turbo-Amiga and the Amiga 1000 are turned on in sequence, the Turbo-Amiga's 68020 processor takes control of the bus, disabling the Amiga's 68000. At this point, running the CSAMemon program included on the disk enables the memory in the Turbo-Amiga, allowing it to realize its full speed potential. You can modify the Startup-Sequence script file to call CSAMemon every time you boot the machine.

Performance

The Mandelbrot graphics program provided on the disk is a good example of the power of the 68020/68881 combination. A normal Amiga can plot the demonstration graphic in about 50 minutes; in contrast, the Turbo-Amiga runs it in about 3 minutes.

For more precise measurements of performance, I ran various benchmarks in three languages: FORTRAN, Modula-2, and the BASIC system tests normally performed for a system review. See page 000 for the BASIC benchmark results and table 1 for results of the FORTRAN and Modula-2 Sieve benchmarks. The "Products Used" text box provides more information on the compilers I used for the tests. Both the Amiga 1000 and the Turbo-Amiga had 512K bytes of internal memory and two disk drives, and I used Kickstart/Workbench 1.2 in all cases for consistency.

The Spreadsheet benchmark results hint at the kind of performance increase you can expect from programs not written expressly for use with the Turbo-Amiga, as was the case with the spreadsheet I used (Lattice's Unicalc 1.0). Not only did the Spreadsheet Recalculate run more than three times faster than normal, but the Spreadsheet Load time was cut by about two-thirds.

Benefits and Drawbacks

Most operations I performed with the Turbo-Amiga in place were noticeably snappier. Using the Command Line Interface (CLI) became much quicker and more responsive. Program compile times were reduced, although the compilers tested were restrained by the amount of necessary disk I/O. Adding one of the op-

tional hard disks to the Turbo Chassis would help speed things up more, as would the addition of more memory to the unit.

One recurrent problem I had was software incompatibility; some of the operations that are performed by the 68000 without question are restricted in the 68010 and 68020. [Editor's note: *Such operations modify the status register, and Motorola made them privileged to properly support the virtual machine mode in the 68010 and 68020. A few of these op-*

erations are MOVE SR, <ea>, MOVE <ea>, SR, ANDI <data>, SR, and EORI <data>, SR.] Executing a restricted instruction causes a Software Error_Task Held message, after which the computer resets itself. The few programs that had this problem were either old or from the public domain. Since Commodore has warned developers to keep code compatible with the 68010/68020 processors, this problem will most likely be short-lived. Some programs with this problem

continued

Products Used

Absoft (4268 North Woodward, Royal Oak, MI 48072, (313) 549-7111) makes FORTRAN and BASIC compilers for the Amiga, Atari ST, and Macintosh. Absoft lent me a copy of its FORTRAN/020 version 2.2d compiler for use with the Turbo-Amiga. FORTRAN/020 is a complete implementation of FORTRAN 77 for the Amiga and costs \$495. It generates code optimized for the 68000 and 68020 microprocessors, includes a debugger, and has a library for use with the 68881 math coprocessor. It is source-compatible with Absoft's FORTRAN compilers for the Atari ST and Macintosh. I was pleased with the quality and ease of use of this product. If you purchase a Turbo-Amiga for number crunching or scientific applications, you should consider FOR-

TRAN/020 a necessity.

The Modula-2 compiler I used was TDI Modula-2 version 2.20 (Developer's version) from TDI Software Inc. (10410 Markison Rd., Dallas, TX 75238, (214) 340-4942). It includes a complete library to interface with the Amiga's graphics, sound, and system routines. The compiler is available in several configurations: the Regular version (\$99.95), the Developer's version (\$149.95), and the Commercial version (\$299.95). I had difficulty getting the Developer's version to work with the Turbo-Amiga; sometimes it ran smoothly, and other times it would cause a system crash. According to TDI, version 3.0 of TDI Modula-2, which is now shipping, works with a 68010 or 68020 processor.

Table 1: FORTRAN and Modula-2 Sieve benchmarks. All times are in seconds. The two versions of the Sieve program used were identical except for the number of array elements. The Short Sieve (the version BYTE uses for benchmark tests) has an array size of 7000 elements, while the Long Sieve's 8191-element array is the same as that used in "Eratosthenes Revisited: Once More Through the Sieve," in the January 1983 BYTE. Absoft's FORTRAN/020 version 2.2d and TDI's Modula-2 version 2.20 (Developer's version) were used. Since there are no special provisions for using the 68020 or 68881 chips with the TDI Modula-2 compiler, the program was compiled and linked normally for both the Amiga 1000 and the Turbo-Amiga. When run with the Turbo-Amiga, Absoft's 68881 hardware floating-point math library (m81.rl) was linked to the program. For use on an Amiga 1000, the software floating-point library (f77.rl) was used. Both Sieve programs were modified to run 100 iterations (rather than the normal 10) to make measurement of execution speed more accurate. The execution times were then divided by 10 to provide the results shown.

	Short Sieve		Long Sieve	
	FORTRAN	Modula-2	FORTRAN	Modula-2
Amiga 1000	5.6	5.9	6.5	6.9
Turbo-Amiga	1.0	1.4	1.2	1.7

are usable with the public domain DeciGEL program, which attempts to correct code with operations illegal to the 68010 and 68020. [Editor's note: *For more information on DeciGEL, see the review "Public Domain Software for the Amiga" by Warren Block in the February BYTE.*]

Another problem was that Amiga BASIC would not run correctly with the Turbo-Amiga enabled. For example, although Amiga BASIC would start properly, I could not load a file; instead, I got a File not found error message, even though the file existed. According to Commodore, the reason this error occurs is that Amiga BASIC uses only 24-bit addressing, and loading Amiga BASIC into a 32-bit address space on the Turbo-Amiga's memory board causes the errors. CSA provides ABasiC with the Turbo-Amiga for this reason, but it is incompatible with Microsoft BASIC. Since practically all the BASIC programs available in the U.S. are written with a Microsoft interpreter, this limits the availability of BASIC software.

You can use Amiga BASIC on the Turbo-Amiga by disabling the 32-bit memory, which is done by simply not running the CSAMem program when you start the computer. However, I still found an Amiga BASIC program, ObjEdit, that caused crashes that didn't occur when the Turbo-Amiga was disconnected.

The Bottom Line

Rather than looking at the Turbo-Amiga package as an upgrade to the Amiga, it's more appropriate to think of it as an extremely high performance Amiga clone from another company. The Turbo-Amiga has some incompatibilities with the regular Amiga, such as the problems with Amiga BASIC, but the inability to use Amiga BASIC won't bother those who want to run only calculation-intensive programs in FORTRAN.

Although the combination of the Amiga and the Turbo-Amiga upgrade is somewhat high-priced for a microcomputer (\$4965, which includes 512K bytes of 32-bit RAM for the Turbo-Amiga and a \$1295 list price for an Amiga 1000), its performance is in the range of a much more expensive minicomputer. For example, compare the FORTRAN Long Sieve benchmark times in table 1 to those in "Eratosthenes Revisited: Once More through The Sieve" by Jim and Gary Gilbreath in the January 1983 BYTE; the combination of the Turbo-Amiga and Absoft's FORTRAN/020 beats all the times listed for the VAX-11/780 in the January 1983 article.

It is interesting to compare the Turbo-Amiga system to computers that use the

new 80386 chip. [Editor's note: *For two examples of these computers, see the review "The ALR Access 386 and the Compaq Deskpro 386" by Stanley J. Wszola and Curtis Franklin Jr. in the February BYTE.*] In terms of performance, the Turbo-Amiga comes close to the 80386-based machines (29 seconds for the Sieve benchmark on the Turbo-Amiga versus

21 seconds for the Compaq Deskpro 386), and it adds the Amiga 1000's graphics capabilities to the battle.

Professionals in need of a well-made computer that combines the Amiga's graphics prowess with the sheer computational power of the 68020/68881 chip set should take a close look at the Turbo-Amiga. ■

Pick of the Litter

William H. Murray and Chris H. Pappas

With graphic user interfaces becoming more and more popular, a proliferation of companies are selling mice to traverse these interfaces. A mouse can simplify maneuvering around windowing environments, such as Microsoft Windows or DESQview, paint programs, or computer-aided design programs, such as AutoCAD. Companies have come up with ways to add mouse support to programs that were not originally designed to be used with a mouse.

We've compared features of eight different mice: the Microsoft Mouse (\$175 and \$195 for the bus and serial models, respectively), the Logitech Bus Mouse (\$149) and C7 Mouse (\$99), Mouse Systems' PC Mouse Bus Plus (\$199), Summagraphics' SummaMouse (\$119), and The Torrington Company's Manager Mouse models 1001C-IR (\$229) and 1001C-KF (\$179). See table 1 for a complete list of features.

These eight models are for use on the IBM PC, XT, AT, and compatibles; we tested all of them on an 8-MHz PC AT with 640K bytes of memory, an 8087 math coprocessor, and one serial port. We'll discuss the advantages and disadvantages of two- and three-button mice and compare mechanical versus optical operation, as well as corded versus cordless models. We'll also take a look at the usefulness of the bundled software. We've noted the number of ICs used to build the mice; fewer chips probably mean higher reliability. We tested the mice with a variety of software packages, including WordPerfect, dBASE III, Lotus 1-2-3, Reflex, Turbo Prolog, AutoCAD, Microsoft Windows, and DESQview. We had no trouble installing and running any of the mice with these programs.

Interfaces

Mice must have a hardware interface to the computer and a software interface to

an application program. Each mouse comes with software that you install either at run time or boot time that tells application programs how to communicate with the mouse. The software controls the cursor position, and the mouse moves the cursor relative to the initial position at start-up.

Because the Microsoft Mouse was the first mouse for the IBM PC and compatibles to gain widespread use, its software interface has become the de facto standard. While other mice may provide an interface that is a superset of the Microsoft Mouse driver software, they all provide the ability to run software written for the Microsoft Mouse interface standard.

The hardware interface between the mouse and the computer falls into two categories—serial or bus. Most companies selling mice today offer both versions, and each has advantages and disadvantages. A serial mouse plugs into serial port 1 or 2 on the computer and sends data to the mouse software that the user installs. The serial mouse's speed of data transmission is limited by the data rate of the mouse software (1200 bits per second for all the mice we reviewed). The disadvantage of the serial mouse is that it ties up one of your serial ports. The advantage is that it's easy to move between computers: You simply unplug it from the serial port of one and plug it into the serial port of the other.

A bus mouse has its own interface card that plugs into a peripheral socket on the IBM PC, XT, or AT, so it does not tie up one of your serial ports. It transmits information in a parallel fashion. Its speed of data transmission is limited only by how fast the interface board can be polled, which is determined by the clock rate of the computer you are using. We found in practice that the faster speed of the bus mouse was not much of an advan-

continued

\$595
Suggested Retail
Price

Creating With
Pictures
Just Got Easier!

Now Available Professional Image Board

The new Professional Image Board is a PC board which allows an ordinary home video camera (color or black-and-white) to be plugged into an IBM personal computer or IBM compatible. Now, live, fast action scenes can be instantly captured in full color and frozen. The frozen pictures can be computer enhanced feature by feature and stored on a floppy or hard disk. The frozen pictures can also be transmitted to any remote computer in the world via modem.

Unretouched frozen
video image in full
color. Captured with
ATronics' Professional
Image Board.



SPECIFICATIONS

- Resolution 512 x 256 capable of 32K different colors
- Adding text on the captured picture
- Mixing external image with internal image in live mode
- Adapter available for European standard TV
- Works with IBM PC/XT/AT or compatible
- Capture one picture in 1/60 second from standard NTSC signal source (Regular video camera, VCR, etc., or RGB camera)
- Shows picture on analog monitor or TV

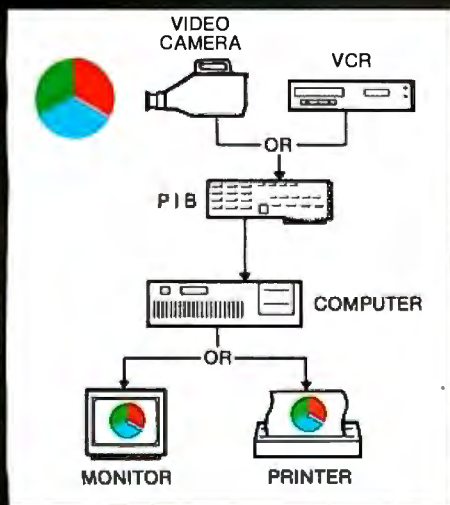

See us at



COMDEX/Spring '87

**BOOTH #3822-
WEST HALL**



**ATronics
International Inc.**
We Deliver Advanced Technology

1830 McCandless Dr. Milpitas CA 95035 USA

(408) 942-3344 TLX: 510-600-6093 FAX: (408) 942-1674

For technical support in Southern California contact:

CNT MARKETING 16580 Harbor Blvd. Ste. J Fountain Valley, CA 92780
(714) 839-3724

Table 1: Summary of mouse features. Cord length sizes are in feet; pad sizes are in inches; resolutions are in dpi. For those mice where we reviewed two versions, the systems mentioned are compatible with both. The \$149 price for the Logitech Bus Mouse now includes LogiPaint in addition to the other software listed. The Logitech C7 Mouse is also available bundled with LogiMenu, Click, M1-2-3 Shell, and Point for \$119; for an additional \$30, LogiPaint is included. The Manager Mouse 1001C-KF is available for \$139 bundled with mouse-driver software only. In March, Mouse Systems introduced a new model of its PC Mouse Bus Plus, which, according to the company, is more reliable. It does not come bundled with PC Paint Plus and costs \$179. Summagraphics now offers a SummaMouse that doesn't require an external power supply. Call the individual companies for the latest prices and configurations.

Company	Name	Price	Type	Buttons
Microsoft Corp. 16011 Northeast 36th Way P.O. Box 97017 Redmond, WA 98073 (206) 882-8080	Microsoft Mouse: Bus	\$175	Mechanical	2
	Serial	\$195	Mechanical	2
Logitech Inc. 805 Veterans Blvd. Redwood City, CA 94063 (415) 365-9852	Logitech Bus Mouse	\$149	Optomechanical	3
	C7 Mouse	\$99	Optomechanical	3
Mouse Systems Corp. 2600 San Thomas Expressway Santa Clara, CA 95051 (408) 988-0211	PC Mouse Bus Plus	\$199	Optical	3
Summagraphics Corp. 777 State Street Ext. Fairfield, CT 06430 (203) 384-1344	SummaMouse	\$119	Optical	3
The Torrington Co. 59 Field St. P.O. Box 1008 Torrington, CT 06790 (203) 482-9511	Manager Mouse: 1001C-IR	\$229	Mechanical	3
	1001C-KF	\$179	Mechanical	3

tage over the serial mouse, because moving a mouse fast enough to hit the 1200-bps limit is unlikely. A drawback of the bus mouse is that, to move it between two computers, you have to open the machine, pull out the interface card, and install it in the other computer.

Movement Detection

There are two ways in which mice can detect movement: by use of either a variable resistor or a data encoder. Of the eight units reviewed, the Microsoft Mouse is the only one that employs variable resistance. As the mouse moves, electronic circuitry detects a change in resistance because the trackball is connected to a potentiometer. The circuitry passes that information to the mouse software, which the user has already installed. The accuracy of the mouse is dependent on the linearity of the two variable resistors (one for horizontal and one for vertical directions). The disadvantage of a mechanical mouse is that the trackball can pick up dust and dirt from the desktop.

All the other mice use some sort of direct data encoding for detecting movement. This involves sending "make-and-break" signals from the mouse to the port—a digital form of encoding that tends to be more precise than the analog encoding of variable resistors.

A mouse can generate this make-and-break information in different ways. Optical mice, such as the SummaMouse and

the PC Mouse Bus Plus, require a special pad for operation, and they detect motion by the interaction of a light beam and a detector, which are located in the mouse, with the reflection of the light from the grid pattern on the pad. Optical mice provide the most trouble-free operation, since there are no wheels or balls to get clogged with dust or dirt.

Optomechanical mice require no special pad for operation. In these mice, movement is transmitted to a rotating wheel that has a special code on it. The Logitech Bus Mouse and C7 Mouse, the only optomechanical mice of the eight, use an encoding wheel to chop a light beam, sending coded make-and-break information to the port. The Manager Mouse, which is purely mechanical, uses a similar concept, but, instead of a light beam, it uses an encoding wheel with a conducting metal pattern. Special spring wires rub against the conducting metal pattern and send the coded make-and-break information.

Microsoft Mouse

The Microsoft Mouse is a two-button mouse. Most vendors writing software with mouse support will make sure that their software works with the Microsoft Mouse. Also, most software available today requires only a two-button mouse; generally, software requiring three buttons is developed only by vendors of three-button mice.

Internally, the Microsoft serial and bus mice differ greatly, although both offer a resolution of 200 dots per inch. First, the serial mouse has two surface-mounted ICs that encode and send the information on mouse movement. The ICs are not necessary in the bus mouse because the separate peripheral board interfaces the resistor readings to the computer. These mice require only minor cleaning.

Logitech's Mice

With regard to hardware, Logitech's C7 Mouse is our favorite. This three-button mouse offers a resolution of 200 dpi. It has a high-quality rubber-coated trackball, just like that of the Microsoft Mouse, which moves easily over almost any surface. But, unlike that of the Microsoft Mouse, its trackball rotates two optical encoding wheels instead of variable resistors. The Logitech C7 thus offers the advantage of a smooth-rolling trackball, eliminating the need for a special pad to roll the mouse on, while giving the user the precision and reliability of an optical mouse. The C7 Mouse contains two ICs and has a 6-foot cord. Logitech's Bus Mouse has a peripheral board with 19 small ICs. The mouse itself contains one IC and has a 4-foot cord.

PC Mouse Bus Plus and SummaMouse

Both the PC Mouse Bus Plus and the SummaMouse are three-button optical

Interface	Power	Connector	Cord length	Pad size	Resolution	Systems	Additional bundled software
Bus	Internal	9-pin round custom	5	None	200	IBM PC, XT, AT; 100 percent compatibles;	Microsoft Paintbrush, Show Partner
Serial	Internal	25-pin and 9-pin D shell	5	None	200	IBM 3270 PC; Olivetti M24	Microsoft Paintbrush, Show Partner
Bus	Internal	9-pin D shell	4	None	200	IBM PC, XT, AT, and compatibles	LogiMenu, Click, M1-2-3 Shell, Point
Serial	Internal	9- or 25-pin D shell	6	None	200		LogiMenu, Click, M1-2-3 Shell, Point
Bus	Internal	9-pin D shell	5	7¼ by 9	100	IBM PC, XT, AT, and compatibles	PC Paint Plus, Designer Pop-up Menu
Serial	External	9- or 25-pin D shell	5	10½ by 9	100	IBM PC, XT, AT, and compatibles	None
Serial	External	25-pin and 9-pin D shell	Infrared	None	100	IBM PC, XT, AT, Compaq, and compatibles	Keyfree
Serial	Internal	9- or 25-pin D shell	5	None	100		Keyfree, TelePaint

mice, each with a resolution of 100 dpi. They both require a special surface to glide on, and they detect motion by the interaction of a light beam and a detector located in the mouse with the reflection of light from the special pad's surface. While the PC Mouse Bus Plus and the SummaMouse accomplish their motion detection in slightly different ways, the nonmechanical contact eliminates the threat of problems caused by dust and dirt. The PC Mouse Bus Plus uses a rigid metal pad with a specially coated surface. Our concern with this pad is that the surface might become scratched during rough use, causing tracking errors. The SummaMouse uses a flexible pad, and the instructions clearly warn that exposure to strong sunlight may cause the lines on this pad to fade, rendering the mouse useless, or leading to an unacceptably high number of tracking errors.

We do not like to use mice with special pads; a pad's limited size forces you to be aware of how close your mouse is to the border, thus restricting your movement. For long sweeps, your only option is to pick the mouse up, move it to the other side of the pad, put it down, and begin tracking again.

The PC Mouse Bus Plus that we used for this review came with a peripheral card containing seven ICs and one regulator. The cord on this mouse measured 5 feet. The SummaMouse that we reviewed was a serial version with one transistor,

five ICs, and an internal crystal. It was also equipped with a 5-foot cord.

Manager Mouse

The Manager Mouse comes in two serial versions: one with a 5-foot cord, and one that transmits information via an infrared beam. These are three-button mice, both offering a resolution of 100 dpi. They have two small plastic wheels set at 90-degree angles to each other. One wheel detects horizontal motion, while the other detects vertical movement. The wheels connect to a rotor with a metallic coded pattern. We found that the small plastic wheels did not track easily over all surfaces. They sometimes slipped on extremely hard surfaces, such as glass, or became bogged down in soft materials, like felt.

The infrared transmitter in the model 1001C-IR is a creative concept in mouse freedom, although we question how useful it might actually be. The infrared mouse contains batteries that must be charged by the mouse receiver. The receiver plugs into the computer's serial port and also into a small power supply. The receiver is a small lightweight device containing one IC and one transistor along with the infrared detector. The mouse contains two infrared transmitters set at slight angles at the front of the mouse, one large IC, one transistor, and a set of rechargeable batteries.

During operation, we could position

the mouse at just about a 90-degree angle to the receiver, and it still transmitted information correctly. Distances up to about 10 feet were acceptable. Background light levels did not affect this mouse. The mouse offered a few problems, however. First, the batteries must be kept charged by plugging the mouse into the receiver. If you forget to charge the batteries, the mouse will work with the charger plugged in, but then you must contend with its cord. The lack of a physical attachment to the computer also opens the potential of a lost or stolen mouse.

Software Concerns

All the mice reviewed came with easy-to-follow installation instructions. Standard software included a RAM-resident mouse driver. The mouse driver is loaded when you boot your system, and it remains invisible until an application calls for it. Several of the mice came bundled with additional software that may factor into your decision of which to buy. The Microsoft Mouse, PC Mouse Bus Plus, and Manager Mouse 1001C-KF each come with an excellent graphics program: Microsoft Paintbrush, PC Paint Plus, and TelePaint, respectively. These paint programs allow you to create graphic designs, charts, and labels and capture graphics images produced by other programs. You can then enhance a captured image with color, patterns, and

continued

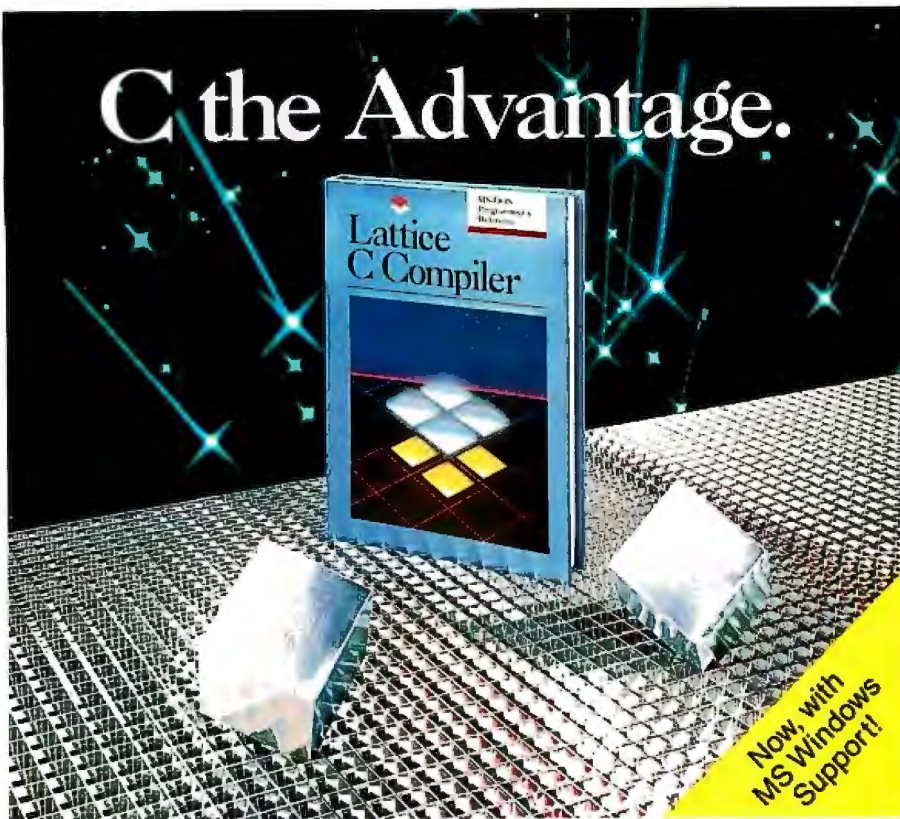

Introducing the Lattice® MS-DOS C Compiler, Version 3.

There's never been a better time to buy Lattice C. Professional programmers the world over have made Lattice C the standard compiler for serious MS-DOS programming. Now Version 3 offers even more of the features that have made our previous versions so popular. Our new compiler features include:

ANSI language constructs including, *unsigned* as a modifier, *void* data type, *enum* data type, structure assignments, structure arguments, structure returns, and argument type checking.

The compiler also contains better aliasing algorithms, more efficient code generation, and more flexible segmentation, in-line 8087 code generation, and 80186/80286 code generation.

The library contains more than 200 new functions, including: ANSI/UNIX/XENIX compatibility; extended support for MS-DOS; extended support for networking including file sharing, file locking, and I/O redirection; and flexible error handling via user traps and exits. Plus the library has also been re-engineered to produce much smaller executables.

Try the new Version 3 C Compiler from Lattice. Because C-ing is believing.



Lattice

Lattice, Incorporated
P.O. Box 3702
Glen Ellyn, IL 60138
312/858-7950 TWX 910-291-2190

INTERNATIONAL SALES OFFICES:

Benelux: Ines Datacom (32) 2-720-51-61
Japan: Lifeboat Inc. (03)293-4711
England: Roundhill (0672)54675
France: SFL (1)46-66-11-55
Germany: (49)7841/4500 (49)8946/13290

labels of different sizes and font types. A graphics slide-show-type program called Show Partner is also bundled with the Microsoft Mouse. With Show Partner, you can enhance graphics created by other programs and select the order, timing, and presentation style of each screen.

The Microsoft Mouse, Logitech Bus Mouse, PC Mouse Bus Plus, and Manager Mouse 1001C-KF include software that lets you custom-design application-dependent pull-down menus. Special mention goes to the Logitech Bus Mouse, which has one of the most complete selections of predefined menus for such popular programs as Borland's Turbo Pascal and Turbo Prolog and Logitech's Click program, which detects the application you're using and automatically sets the mouse to your predefined settings. Each mouse also comes with an emulation-mode driver that enables it to interface with programs written only for the Microsoft Mouse.

Which Should You Choose?

All the mice passed some simple tests that we applied to them. To simulate dropping them off a desk, we dropped them three feet onto a concrete floor covered with a half inch of carpeting; they all continued to work. We rolled them through dust and dirt taken out of a vacuum cleaner, and they all continued to track properly. None of the mice were affected by bright ambient light, or by varying humidity levels.

We found that all these mice performed well and were reliable. Your decision of which to choose might be based on the number of buttons, whether you have a communications port available for a serial mouse, or whether you have a spare slot for the interface card of a bus mouse. Also, you need to decide whether you will use a mouse for applications that come with mouse support or whether you'll need to customize a mouse menu/button function.

We recommend either the Microsoft Mouse or the Logitech C7 Mouse. Both offer high resolution and proven performance, and both use an easy-gliding trackball that will roll over just about any surface. If you need a graphics program in addition to having a mouse, then consider one of the Microsoft mice or the PC Mouse Bus Plus. All three include excellent software for custom-designed mouse menu/button functions. ■

William H. Murray and Chris H. Pappas are professors at Broome Community College (Binghamton, NY 13902). They are currently working on a book about 80386 hardware.

\$109
EVEREX
EVERCOM

- | | | | |
|-----------------------------|-----------------|-----------------|--|
| | <i>External</i> | <i>Internal</i> | |
| ■ 60MB Tape Backup | \$829 | \$759 | |
| ■ 20MB Cassette Tape backup | \$649 | \$579 | |
- Backup 20MB in less than 5 minutes
 - Image/file-by-file backup and restore
 - Menu driven software
 - Interchangeable DMA, port address and interrupt

- Comes with Bit-Com Software
 - 1/2 size 300/1200 Baud Modem
 - Fully Hayes, Bell 103 & 212 compatible
 - Supports Coin 1, 2, 3 & 4
- External 300, 1200 Baud
 - 1200/2400 Baud internal 1/2 size modem

■ 20 MB Seagate 1/2Ht. hard disk (with controller)
 C O D., VISA, MC only **\$339**

Company Terms **\$369**

- 30MB seagate 1/2Ht. hard disk (65 Ms) with controller
- 20MB Seagate full Ht. hard disk (40 Ms)

- 8088 CPU (4.77 and 8 MHz keyboard switchable) **\$399**
- 8 Expansion slots
- 256K Memory on Motherboard
- 360K Drive with controller FCC Class B
- 150 W power supply
- AT Style keyboard
- Socket for 8087 Math Co-processor

- Runs with IBM PC, XT and compatibles
- With the Turbo card, your PC will run 7 times faster than IBM, PC, XT or 33% faster than 6 MHz IBM AT
- 16 bit 80286 design
- Accepts optional 80287 Math Co-processor

FCC Class B
 Made in USA

\$339

Made in USA

- Compatible with AT, XT and PC
- 0 wait state, work with any video display card and multifunction card

- | | |
|--------------------------------------|--------------|
| 3 sizes | Power supply |
| • Full size, 8 slots | 130W |
| • 1/2 size, 4 slots | 75W |
| • slimline, 3 long and 1 short slots | 70W |

- 720 x 348 Resolution
- Hercules compatible
- Runs Lotus 123 Graphics
- Printer Port

\$95

- IBM Color Card compatible
- 16 colors, 640 x 200 resolution

- | | |
|-------------------------------------|--------------|
| AT Version (16 bit) | \$169 |
| • XT size format XT Version (8 bit) | \$149 |
- Western Digital Chipset
 - Control 2 hard disks and 2 floppy drives

- Teac/Fujitsu/Toshiba
- 1/2 Ht. size
- High Reliability
- Low Power Consumption

1.2 MB **\$135**
 360K **\$95**

256K RAM (150 ns)
 64K RAM (150 ns)

\$27
\$9

- Keytronics 5151 style keyboard
- IBM PC/XT, AT compatible
- 95 keys keyboard • LED lights

\$88



- IBM EGA compatible
- 640 x 350, 16 colors
- 720 x 348 mono
- 640 x 200 color

\$178

- Expandable up 2MB
- Compatible with IBM, PC/XT
- Fully socketed with parity check
- Lotus/Intel/Microsoft compatible

\$99

- Hercules compatible graphics
- Monochrome high resolution 720 x 348
- Parallel printer port • Game port
- Serial communication port

- PC, XT compatible 135W **\$79**
- 4 Power leads for drives 150W **\$89**
- Reliable

Policy:

Returned items must be as-new, not modified or damaged, with all warranty cards, manuals and packaging intact. Returned items must be shipped prepaid and insured, and must bear a QIC return Authorization (RA) on the shipping label. Call QIC Customer Support Department for RA. No credit issued after 30 days from date of shipment.

QIC RESEARCH
 INCORPORATED
 753 Ames Ave.
 Milpitas CA 95035

800-843-0806 (Sales)
 (408) 942-8086 (CA)
 Tech support (408) 942-0856
 Dealer and Quantity discount are available

QIC Research of Chicago
 1926 Waukegan Rd., Suite 3A
 Glenview IL 60025
 (312) 998-8903

Seagate, Tandon, Hercules, Hayes, Bell, IBM are trademarks of their respective companies



WRITE TAKES FLIGHT.

Datasouth Presents The PageWriter 8 High Performance Page Printer.

Fasten your seatbelts.

And watch your productivity take off with the PageWriter 8. It delivers everything you need for first-class, high volume word processing output. Near-typeset quality text at 8 pages a minute. Business graphics. Electronic forms. Multi-column formats. And its quiet operation will

never break the sound barrier. All of which is enough to permanently ground any daisywheel.

The PageWriter has capabilities that elevate it above other page printers, too. Like its 5000 page-per-month duty cycle—2000 pages higher than the so-called standard. Or its superb paper handling-

250-sheet input and output trays for letter or legal size documents. Face-up or face-down delivery. And with its optional second input hopper, the PageWriter can fly through 500 pages completely unattended.

Changing type styles is also a breeze, with four resident fonts to choose from—plus additional fonts in dual plug-in cartridges or downloaded from your computer.

It doesn't take much to get the PageWriter up to speed, either. Diablo 630 and Epson FX-80 emulation let you get all this extra mileage from the software you already own. And emulation options are selectable from the front panel, eliminating clumsy dip switches.

So let your ideas really take wing with Datasouth's PageWriter 8. To find your nearest Datasouth distributor, call us at 1-800-222-4528.



Datasouth
AMERICA'S HIGH PERFORMANCE
PRINTER COMPANY



Four C Language Interpreters

John Unger

An overview of Run/C, Run/C Professional, C-terp, and Instant-C

Run/C version 2.03 and Run/C Professional version 1.03 by Lifeboat Associates (\$120 and \$250, respectively), C-terp version 2.22 by Gimpel Software (\$298), and Instant-C version 2.20 by Rational Systems (\$495) are four C interpreters for MS-DOS machines. The packages are designed to accomplish the same general tasks, but the approaches they take and how they interface with the user are all distinct.

Run/C and Run/C Professional are essentially the same program. The major difference between them is that the Run/C Professional package includes the ability to load external object libraries and code. Because they differ only in this respect and because their interfaces, much of the content of their manuals, and their benchmark results are identical, throughout most of this review I will use one term, Run/C, to refer to both of these interpreters.

All four software packages are classified as interpreters. Instant-C can also produce a stand-alone executable file. However, only Run/C executes programs in a mode similar to most BASIC interpreters—interpreting each line of source code on a line-by-line basis without producing any intermediate code. This situation accounts for the relatively slow speed of Run/C in the benchmark tests. The other interpreters feature a compile mode, in which the source code is compiled internally into an intermediate code and then is run from this compiled form.

Instant-C and Run/C allow you to operate in a direct mode, which is similar to BASIC. This means that you can enter any valid C expression, including calls to library functions, while in the interpreter, and the result will be evaluated and displayed on the console.

Hardware and Software Requirements

The four interpreters are designed to run on the IBM PC, XT, AT, and compati-

bles and require at least one 360K-byte floppy disk drive for loading their software. All four packages run on MS-DOS 2.0 or higher.

Each of the interpreters requires a lot of free memory. C-terp requires 256K bytes of RAM, Run/C requires a minimum of 320K bytes, and Instant-C needs at least 512K bytes. None of the interpreters uses overlays. This means the entire interpreter, editor, library, and other required modules are all part of one executable file and load into memory at run time. Access to the various parts of the interpreters is fast, but your computer must have sufficient memory for the operating system, the interpreter, and your program. The maximum size of the source code you can load into any of the four packages is usually limited only by the amount of RAM you have. Run/C can handle a maximum of 640K bytes of RAM, C-terp can handle up to 16 megabytes of virtual memory (you activate this memory option by a command when you start the program), and Instant-C can manage a maximum of 1 megabyte of nonextended RAM, or an additional 64K bytes of expanded Lotus/Intel/Microsoft (LIM) memory.

All four interpreters use C syntax that is compatible with the Kernighan and Ritchie definition of the language. You can set up Run/C Professional, Instant-C, and C-terp to use libraries specific to either Microsoft or Lattice C compilers. C-terp also comes in versions that are compatible with Manx Aztec C, Computer Innovations' C-86, and Mark Williams' C.

None of the interpreters is copy-protected. All four user's manuals urge you to make backup copies of the distribution disks immediately. I had no problems

copying any of the programs to a hard disk.

Overview of the Interpreters

The authors of Run/C strived to make their C interpreter look like the environment familiar to users of Microsoft BASIC interpreters. Most of the commands closely follow those used in BASICA and GW-BASIC. The in-memory full-screen editor has many of the features and uses the same keystrokes as the popular WordStar editor.

C-terp moves further away from familiar patterns and provides an integrated environment of a menu-driven command level, a powerful screen-oriented editor with line numbers, and a debugger.

Instant-C is the most sophisticated of the four packages. It provides all the features of the other interpreters plus a few extras. Instant-C lives up to its name as far as speed of program compilation and execution is concerned; it was by far the fastest in the benchmark tests.

All four packages are designed to execute C source code only from within the confines of their individual interpreters to produce the desired output. What good are they, then? I think that there are two principal roles they might play: as a tool for learning how to program in C or as a tool for quickly writing portable C programs that you will later compile into executable programs. The least expensive package, Run/C, is especially good if you're a beginner in C and are familiar with the screen layout and operation of GW-BASIC or BASICA.

All four packages' user's manuals provide good descriptions of how to get the programs running on your computer and take you step by step through a simple example program. Each manual provides

continued

John Unger (P.O. Box 95, Hamilton, VA 22068) is a geophysicist for the U.S. government who uses the C language to write software for earthquake research.

	Run/C version 2.03 Run/C Professional version 1.03	C-terp version 2.22	Instant-C version 2.20
Type	C language interpreters	C language interpreter	C language incremental compiler
Company	Lifeboat Associates 55 South Broadway Tarrytown, NY 10591 (914) 332-1875	Gimpel Software 3207 Hogarth Lane Collegeville, PA 19426 (215) 584-4261	Rational Systems P.O. Box 480 Natick, MA 01760 (617) 653-6194
Format	Two 5¼-inch floppy disks	Two 5¼-inch floppy disks	Three 5¼-inch floppy disks
Computer	IBM PC, XT, AT, or compatible with at least one 360K-byte floppy disk drive and 320K bytes of RAM running DOS 2.0 or higher	IBM PC, XT, AT, or compatible with at least one 360K-byte floppy disk drive and 256K bytes of RAM running DOS 2.0 or higher	IBM PC, XT, AT, or compatible with at least one 360K-byte floppy disk drive and 512K bytes of RAM running DOS 2.0 or higher
Documentation	530-page user's manual	148-page user's manual	520-page user's manual
Price	Run/C: \$120 Run/C Professional: \$250	\$298	\$495

you with a listing of the files on the distribution disks and describes the ones you will need to run the interpreter. All the manuals have tables of contents and indexes to help you locate specific subjects.

The amount and usefulness of the documentation supplied with the interpreters vary considerably. Run/C has the best manual of the lot. Nearly 400 of the manual's 530 pages contain descriptions and meaningful examples of how to use all the 115 library functions included with the interpreter. This is in sharp contrast to C-terp's 66 functions, which are described without examples in 50 pages of its user's manual. Instant-C's manual contains almost 300 pages of terse descriptions of its extensive collection of 162 library functions and has only a few short examples.

Although complete at 430 pages, the Instant-C manual is difficult to use and confusing, mostly because it is difficult to locate specific information on the interpreter's commands and functions, despite the manual's index. Instant-C is a large, sophisticated program with no on-screen help. Fortunately, a well-written chapter in the manual that contains an example showing how to create, edit, and debug a program helps to overcome some of these difficulties. Anyone starting out with Instant-C should read this chapter first.

The Run/C Interpreter

When you start Run/C, you are greeted by a familiar-looking screen layout that mimics that of Microsoft BASIC: 10 highlighted boxes appear across the bot-

tom of the screen to show the commands that are assigned to the function keys. Run/C's editor also has easily accessible help screens that are just a keystroke or two away.

You use the LOAD command to get an existing file from your disk. The FILES command allows you to see the files in the default directory. These and similar BASIC-like commands make it easy for someone who has used BASIC to get started with Run/C. Run/C's debugging aids consist of the TRON and TRACE commands, along with the ability to DUMP the values of variables after halting the program with Control-C or Control-Break. The DUMP command displays these values on the computer's screen; a corresponding LDUMP command dumps the values to a printer.

The aspect of Run/C that I found most bothersome was its rather slow execution speed. You can't do much about this, except to use the program on a faster microcomputer. Run/C also has sluggish disk I/O that makes the interpreter a bit tedious when loading large files from or saving them to disk. Beginners may not become as frustrated with Run/C's slow speed as I did, but I think it's fair to say that the slow execution of source code will render Run/C unfit for use by experienced programmers. [Editor's note: *The latest version of Run/C Professional is 1.11. This new version offers support of the Microsoft C 4.0 compiler's features.*]

C-terp

C-terp first appears on the screen as a menu, giving you a choice of 14 opera-

tions. Most choices are obvious, such as LOAD, COMPILER, EDIT, or RUN. To choose a command, you need only type its first letter, which is highlighted on the menu. A normal sequence would be to load a file with C source code from disk, edit it to make changes or just to preview the code, and then compile and run the program. Each of these operations takes just one keystroke, with the exception of typing in the name of the file.

The screen-oriented editor is fast and has most of the features that programmers have come to expect from editors, including block moves and copies, but it lacks macro commands and auxiliary buffers. An Alt-H keystroke combination instantly displays a helpful menu of editor commands on the screen. You use line numbers for the editor, and they act as a handy reference for the debugger and error messages. The line numbers are not saved as part of the file.

C-terp allows you to set breakpoints anywhere in your source code by use of a `breakpt()` function. This function serves as an entry point into the debugger. In the debug mode, you can display or change the value of any active variable and then continue execution of the program. A split-screen feature shows the source code in the top half of the screen, with the debugger commands and their results in the lower half. You can also flip back and forth to a screen showing the program's output or **browse** through the source code without ever leaving the debugger.

A major shortcoming of C-terp is its lack of a built-in library of mathematical

functions, such as sine, tangent, or square roots. Normally, C is not looked upon as a language for writing scientifically oriented software, but I have used it for this purpose and routinely write scientific programs in C rather than in FORTRAN. You can overcome this lack of mathematical functions if you have access to C source code for the math functions you need, and you can include this code with your program.

Another alternative is to use an object code math library that is compatible with C-terp. If you already use a C compiler, this solution is easy because C-terp comes in versions that are compatible with Manx Aztec C, Lattice C, Computer Innovations' C-86, Microsoft C, and Mark Williams' C. With the Microsoft-compatible version of C-terp that I tested, I was able to create a version of C-terp that used all the Microsoft compiler's library functions. This feature allows you to use the interpreter to test programs that you can later generate into executable files with your compiler. [Editor's note: *The latest version of C-terp is 2.30B. It now supports the keyword far for large memory-model addressing, as well as ANSI extensions to the C language, such as function prototyping.*]

Instant-C

Instant-C is unique among the interpreters in that it gives you the capability to create stand-alone executable files. However, the executable module produced includes the entire Instant-C library code (which is larger than 32K bytes), along with all the storage allocated by Instant-C to your source code during the debugging session, unless you follow special procedures.

Instant-C has a variety of debugging aids and offers elaborate control over execution of your program. As with C-terp, you can set breakpoints anywhere in the source code with a `_()`; function, and you can examine and change variables once the debugger is entered.

This interpreter was difficult for me to understand and use, compared to the others. First, most of the user's manual is hard to read; for example, it informs you that you can edit a *function* (e.g., `main()`) only after you have loaded the file into memory. However, this vital bit of information lurks in a section entitled "Style Differences," which follows the introductory section on the editor. Furthermore, the description of the `#load` command is located in yet another section entitled "The Instant-C Work space."

Second, the program itself is distinctly user-unfriendly and has no on-screen help; you must rely on the manual and

your memory. After the program is invoked, the only thing that appears on the screen is a `#` prompt, not a menu. Instant-C has a total of 65 valid commands that you can enter from the interpreter mode. This gives you a great deal of control over editing, testing, and debugging your code, but it also gives you a great number of keywords to remember.

The program is particularly powerful for debugging and provides the programmer with a good set of tools for unraveling problems. However, Instant-C's true forte is the speed at which it executes C programs; it is clearly in a class by itself in this category. Instant-C also includes the largest library of built-in functions for programmers to take advantage of. For example, it has a number of commands for displaying memory in hexadecimal, octal, or decimal format. The math library provides exotic transcendental functions, such as hyperbolic cosine. A `setjmp` function is provided, as well as interrupt support to invoke MS-DOS functions.

Performance Evaluation

Because both C-terp and Instant-C compile the complete source code into an internal form before executing the program, I expected to see large differences in execution time between them and Run/C, which operates as a true interpreter. Clearly, as shown in the benchmark results in table 1, Instant-C is the fastest of the four, with C-terp in second place. Run/C was the slowest in all the benchmarks. Run/C and Run/C Professional performed virtually identically in the tests. To give you an idea of how the C interpreters compare to a standard C compiler, I have included the results of the benchmarks run on version 4.0 of the Microsoft C compiler. I ran the benchmark programs as functions called from within a `main()` function. The `main()`

function included code to start a system timer, run the benchmark program, and then read and display the elapsed time.

However, the times shown in table 1 aren't the only factors to consider when choosing an interpreter. Programmers spend much of their time editing and debugging source code that they have created; usually only the end user gets the benefits of fast execution. The speed with which a programmer can produce C language code that executes flawlessly is clearly the important benchmark to consider if you choose to operate in an interpretive environment. On the other hand, the speed with which you can learn C syntax and instructions and begin to write real C source code is a key benchmark measurement for someone trying to learn the intricacies of the C language. In this sense, Instant-C is not as clear a winner, nor is Run/C as clear a loser, as the benchmark times would indicate.

As an attempt to compare the four interpreters in a fair way, I used the scenario in which you finish entering a program using the interpreter's editor and then proceed to debug and run the source code. First, I took a simple C program (see listing 1) that ran identically on the four interpreters. I then introduced two types of common errors into the source code. Table 2 gives an explanation of the error types used. I will refer to code in the program by line number and to error types by their code names, for example, S2 for syntax error number 2.

For error S1, Run/C prints out an error code, the offending line number, and the message `Variable or function foeh not found`. The compile-time errors S2 and S3 frequently are not obvious to compilers or interpreters until a line or so later or, in the case of a missing left brace, until the end of the program. Run/C did not handle error S2 well at all.

continued

Table 1: Benchmark times for the interpreters and the Microsoft C compiler (for reference). Times are in hours:minutes:seconds. The Sieve test measures how long it takes to run ten iterations of BYTE's Sieve of Eratosthenes prime-number benchmark on an array of 8190 numbers. Sort tests each compiler's handling of pointers during a sorting operation. Fib tests the efficiency of each compiler's recursion while computing a Fibonacci series. Float measures the time it takes to do 140,000 floating-point multiplication and division operations. Fileio exercises the I/O functions of the compiler by reading and writing to a 65,000-byte disk file. An IBM PC with 512K bytes of RAM was used for the benchmark tests.

	Microsoft C 4.0	Instant-C 2.20	C-terp 2.22	Run/C 2.03
Sieve	11	40	59:37	5:29:33
Sort	20	1:10	46:27	3:53:26
Fib	1:16	3:49	3:04:52	15:15:28
Float	1:33	8:09	16:29	51:58
Fileio	7:20	10:49	23:10	1:21:58

Table 2: *Type and location of the errors that were introduced into the program in listing 1. The first three, S1, S2, and S3, are simple syntax errors. The latter two, L1 and L2, are errors that can be detected only while the program is running.*

Error code	Type of error	Location in listing 1
S1	misspelled variable name	fohr for fahr—line 11
S2	missing ;	end of line 11
S3	missing { and }	lines 10 and 13
L1	integer instead of floating-point division	line 11
L2	integer instead of floating-point format in printf statement	line 12

Listing 1: *A simple program that demonstrates how the three interpreters handle syntax and run-time errors. The lines have been numbered for referencing in the text.*

```

1 #define UPPER 300.0 /* upper limit of Fahrenheit degrees */
2 #define LOWER 0.0 /* lower limit of Fahrenheit degrees */
3 #define STEP 20.0 /* step to increment Fahr. degrees */
4
5 main( )
6 {
7     float fahr, celsius;
8     printf("\t\tFAHRENHEIT\t\tCELSIUS\n\n");
9     for (fahr = LOWER; fahr <= UPPER; fahr += STEP)
10    {
11        celsius = (5.0/9.0) * (fahr-32.0);
12        printf("\t\t\t%4.0f\t\t\t%6.1f\n", fahr, celsius);
13    }
14 }
```

and it produced the message Required lvalue not found. S3 produced the message **Error: unmatched braces** with the line number of where the last left and right braces were found. The only way to untangle run-time bugs like L1 and L2 is with a debugger or by sprinkling calls to the printf function throughout the source code to examine the values of variables. With the L1 error, the program compiled well and listed the values of fahr correctly, but the output of the variable celsius was all 0.0s. For L2, the output of both variables was 0. Run/C has two ways of debugging run-time errors: You can turn on a TRACE command toggle, or you can interrupt the program with a Control-C. This will interrupt Run/C and print the menu Continue, dump, ldump, interactive, help or end (C/D/L/I/H/E)? on the screen. The dump option lists all the variables and their values from three different areas: automatic variables declared in the function where the break occurred, automatic variables from the calling function, or all global and static variables. Prior to running the program, you can turn on the TRACE toggle, which prints out the cur-

rent values of all the variables each time they are referred to as the program runs. Run/C also has a TRON/TROF command pair, which is similar to BASIC, to trace program logic and aid in debugging. These error messages and debugging aids are adequate, but a cut below what C-terp and Instant-C offer.

Both C-terp and Instant-C handled syntax errors easily and in a similar manner. For the S1 error, C-terp prints an error code and the message Undeclared identifier. Hitting any key puts you back into the screen-oriented editor with the cursor at the first letter of the word that caused the error.

C-terp handles both the S2 and S3 errors very well. For the S2 error, it gives the message Expecting ';' and places the editor cursor at the first character in the line following the omitted ;. For the S3 error, it gives the message expecting 'identifier' for a missing left brace and the message expecting '}' for a missing right brace. As with Run/C, the L1 error compiled but produced 0.0s for the variable celsius; I obtained similar results for L2. This was a good place to try C-terp's breakpoint(); function, so I

inserted it within the for loop after line 12. The effect of having this function in the loop was that execution stopped just after the printf function was called, and the program automatically exited to the debugger screen.

In C-terp's debugger environment, the top two-thirds of the screen contains a listing of the program's source code where the breakpoint(); function is set. The bottom part of the screen displays a menu of commands for displaying variables, tracing, or stepping through code. You can select the appropriate command by typing its first letter. For example, hitting the D key selects the Display option and causes the debugger to print the prompt expression:, to which you can respond with the name of any valid variable and press Return. The current value of that variable is then displayed.

Instant-C makes it virtually impossible for you to leave the editor without compiling your source code function in its most recently edited form. The compiler handles all syntax errors logically and with somewhat more chatty messages than the other interpreters. For example, error S1 results in the message I'm sorry but I don't know the word 'fohr' and the cursor was placed at the first character in fohr. For error S2, it displays the message Missing semicolon (;) before 'printf' and the cursor was placed at the first character in printf. S3 produces the message I'm sorry, but I don't know the word '{' for a missing left brace and Missing closing brace (}); possible unterminated remark for a missing right brace. As with Run/C and C-terp, errors L1 and L2 generated 0.0s for the output.

You can track down run-time errors such as L1 and L2 with a variety of debugging tools. Instant-C's special __(); function serves as a breakpoint to halt program execution and is similar to C-terp's breakpoint(); function. When you break out of a running program in Instant-C, the fragment of source code surrounding the __(); appears in a window at the top half of the screen, and you are back in the command mode with a # prompt in the bottom half. From this prompt, you can issue special commands to view and change variable values and list the source code or reenter the editor mode and view the source code. But you cannot browse through the source code, as is possible in C-terp's split-screen debugger, nor do you have any on-screen aids to help you choose commands.

Technical Support

The support I have received from Lifeboat Associates, Gimpel Software, and

continued

CAREFUL—YOU'RE ABOUT TO LOSE YOUR AMATEUR STATUS.



Now even novices can make their PC's do things that the experts had to strain at.

By slipping Ability Plus™ or Ability™ into their PC's.

With both programs, you get full-featured word processing. Spreadsheets larger than Symphony and the ability to import Lotus 1-2-3 1A files. A forms-oriented database with Ability and a relational database with Ability Plus. Professional business graphics with just a few keystrokes. Menu-driven Migent Pocket Modem™ and Hayes-compatible communications.

Even "slide shows" on your PC!

They both use menus and the same commands in all the applications, so there's no programming.

And they're the only integrated business programs that work with "live" data, not just copies pasted in. So you only have

to enter data once, and changes you make in one application are automatically made for you in all your linked applications.

Perfect for those endless daily, weekly and monthly reports.

Ability Plus, our latest addition, adds a spelling checker, system-wide advanced macros, four-quadrant X-Y graphs, EGA support and much more. And it's a fully relational system that can look up information for you from any application. (Enter a name, it gets the phone number; enter a part number, it gets the description; etc.)

They both run on the IBM PC, Personal System/2, and compatibles. Ability Plus is yours for just \$259 while

Ability is budget-priced at \$119, including both 5¼" and 3½" diskettes. (Original Ability is available for just \$99 on 5¼")

If it all sounds too good to be true, get your free demo disk and start doing more and working less today.

Whether you're a computer expert or would just like to be one.

CALL (800) 633-3444 TODAY

MIGENT™

Free Demos!

Sounds great! Please send the name of your nearest dealer and a demo disk for:

Ability™ Ability Plus™

Name _____
 Address _____
 City _____ State _____ Zip _____
 Phone _____

Send to: Migent, Inc., 865 Tahoe Blvd,
 Call Box 6, Incline Village, Nevada 89450-6062

©Migent, Inc. 1987 Ability, Ability Plus and Pocket Modem are trademarks of Migent, Inc.



Inquiry 193 for End-Users.
 Inquiry 194 for DEALERS ONLY.

Microsoft Windows Software Development Kit

David and Lee Hart

Rational Systems has been excellent. All my questions have been answered quickly, accurately, and, in many cases, by the person who actually wrote the program. None of the companies has a toll-free number for technical help, but, instead of that convenience, you get a much more important one: no long waits or being told that someone will call you back. It is simply courteous, quick service. This situation may change as the number of users for the software grows, but I hope not.

Rational Systems has a service for Instant-C that I've never seen before with any other software I've used. It includes a stamped, self-addressed envelope with the documentation for you to use to send back bug reports or questions. Also, Rational Systems offers a money-back guarantee for the first 31 days you own the software.

Which to Choose?

Without a doubt, the best C interpreter I can imagine would combine features found in all four software packages reviewed here. First, it would have the documentation and editor of Run/C. Second, it would present you with an easily accessed menu-driven environment and an easy-to-use symbolic debugger like C-terp's. Third, it would have the speed, sophisticated features, and extensive library of Instant-C.

Of the four interpreters, C-terp comes closest to this ideal right now. Its only major shortcomings are the lack of an in-program math-function library and the terseness of some of its documentation.

Run/C is an excellent package for beginning C programmers. I would recommend it particularly to those who are familiar with BASIC and who won't be put off by the slow execution speed. Run/C's low cost makes it especially enticing. Run/C Professional, with its ability to load external object libraries and code, adds more power to the basic Run/C package but does not improve on its execution speed.

The performance of Instant-C is excellent. However, the problems I had understanding how the software worked and its awkward documentation detract from the usefulness of the package. I cannot recommend Instant-C to beginning programmers, but experienced C programmers would appreciate and utilize its sophisticated features and power.

A big plus for C-terp and Instant-C is their ability to create versions of the interpreter that are completely compatible with the libraries of popular C compilers. In the case of Run/C Professional, you at least have the option to load and include different object libraries with the programs you are creating. ■

The Microsoft Windows Software Development Kit version 1.03 (\$500) is a set of libraries and utilities (see table 1) that you can use to give an application a window-based iconic user interface. These libraries let you create multitasking, device-independent applications and provide virtual memory management for them. The system also has two facilities for giving your programs the ability to exchange data: the Clipboard and the Dynamic Data Exchange protocol.

The development kit is designed to work with the Microsoft Windows operating environment, PC-DOS or MS-DOS 2.0 or higher, 512K bytes of memory, a graphics monitor, and a graphics adapter card, such as a CGA or EGA. Other graphics adapters will also work as long as they have a Windows device driver. Technically, you can run the system with two floppy disks, but Microsoft recommends using a hard disk. Windows runs sluggishly on any machine slower than a PC AT with a 20-megabyte hard disk drive. Microsoft strongly recommends using a mouse; you cannot use the Dialog, Font, or Icon editors without one.

Debugging with Symdeb, the symbolic debugger, requires an external console or a monochrome monitor with a display adapter in addition to the graphics adapter. The development kit also requires a language compiler with Windows support. Windows support means that the compiler supplies prologue and epilogue code to a program's segments to give the memory manager the information it needs to relocate or swap these segments to disk. The compiler must be able to specify Pascal-calling sequences, as all routines called by Windows use that convention. Four Windows-compatible compilers are available: Microsoft C 4.0, Lattice C 3.2, Microsoft Pascal 3.31, and the Microsoft Macro Assembler (MASM) 4.0. Examples in this article are written for the Microsoft C compiler.

Windows Architecture

A Windows application sees Windows support as a layer that lies between the

operating system and the drivers that consists of three main sections: the Kernel, the Graphics Device Interface (GDI), and User (see figure 1). The Kernel handles the system-level chores of multitasking and memory management. The GDI handles output to the display and printer. It also isolates you from the details of specific hardware through the use of generalized drawing commands across all devices. User, the user-interface portion of Windows, handles the specifics of dialog boxes, pull-down menus, and scroll bars.

The Windows development kit gives you the tools you need to create Windows applications. A Windows application is a task that sits in a loop, polling the message system for messages and responding to them. Messages can be generated by the clock, mouse, keyboard, or by other tasks. A task may or may not have a window; one that does must also have a window procedure that interprets messages sent to the window. Tasks can send messages synchronously to the application queue with `PostMessage` or asynchronously directly to the window procedure with `SendMessage`. `PostMessage` returns without waiting for the corresponding window to process the message, whereas `SendMessage` doesn't return until the message is processed.

Figure 2 shows the structure of a Windows application. Every task must have a task-entry point, called `WinMain`. `WinMain` initializes an application's data, registers the application's window class, creates and displays the windows, and enters the message loop. It then uses the message function `GetMessage` to retrieve messages from the application's queue. `GetMessage` yields the processor to other applications when other programs are waiting. `WinMain` then translates and dispatches the messages to their respective window procedures.

All communication in a Windows application is accomplished by sending messages. The information transmitted in a message includes the handle of the target window; the message number; the parameters, `wParam` and `lParam`, which

carry extra information specific to the message; the time at which the message was sent; and the mouse position. Mnemonic names for messages, as well as Windows-specific types and structures, are defined in the header file `WINDOWS.H`.

For each action or event that affects a window, there is an appropriately named message to inform the application. For example, when you select a command from the system menu, your program gets a `WM_SYSCOMMAND` message, indicating which command was chosen. You can then take some application-specific action or just take the default for that message.

If a message is received that the program doesn't need to process, it is passed on to the default window procedure, `DefWindowProc`, which carries out an appropriate default action. For example, `DefWindowProc` handles `WM_PAINT`, which means part of the window needs to be redrawn, by painting the entire window with the background color. `DefWindowProc` can change as Windows changes. This way, Microsoft can add new messages to future versions of Windows while retaining compatibility with older Windows applications.

A typical scenario for exiting the message loop is choosing `Close` from the system menu. This initiates a call to `DestroyWindow`, which generates the message `WM_DESTROY` for the application's queue. Your window function could then respond to `WM_DESTROY` by calling `PostQuitMessage`, which places a `WM_QUIT` message into the application queue. When `GetMessage` sees the `WM_QUIT`, it returns a zero (for all other messages, it returns a nonzero number), causing the program to exit the message loop and terminate.

Compiling

Figure 3 shows the process of compiling a Windows application from the C source files. The C compiler compiles the source code into the object file; resources, such as icons, cursors, fonts, and dialog boxes, are listed in the resource script file. The resource compiler uses this file to create the resource file.

The Windows linker, `Link4`, then combines one or more object files from the compiler into an executable file according to the module definitions file. This file is an ASCII text file that specifies the size of the program's heap and stack, the names of functions that are exported (so that Windows can call them), whether the program's code is shareable (so that several instances of the program running at the same time use the same code), and whether Windows can move

the code and data around to make room for other programs. The executable file produced by `Link4` has everything but the resources in it.

The last step is to use the resource compiler to add the resource file to the executable file from `Link4`. The result is a Windows format executable file. Windows format executable files are intended to be started from within Windows. If you start a Windows program from DOS, it displays the message `This program requires Microsoft Windows`.

You can automate all the steps for com-

pilation by building a make file for the program-maintainer utility, `Make`, that describes all the necessary actions. This saves you from having to remember all the steps involved in compiling each time you modify your program, but compiling still takes a long time.

On a 4.77-MHz PC XT compatible with a 20-megabyte hard disk, we found the compile-cycle time to be just over 5 minutes for a 21K-byte C source file with two resources, a 1K-byte icon and a 270-byte cursor. That is a long period to wait

continued

Table 1: The major components of the Windows Software Development Kit. Two versions of the executable files are available: one for debugging and one for normal operation of your application. Windows retails for \$500; you will also need to purchase the Windows Operating Environment, one or more of the Windows-compatible languages, and a text editor.

Executable windowing support

Kernel
User
Graphics Device Interface

Library files

Small, compact, medium, and large versions of the C library files;
Pascal library files

Include files

`WINDOWS.H` (C language)
`STYLE.H` (C language)
`WINDOWS.INC` (Pascal)
`CMACROS.INC` (Assembler macro file)

Must be purchased separately

Windows 1.03 text editor
One or more of the following:
Microsoft C version 4.0
Lattice C version 3.2
Microsoft Pascal 3.31
Microsoft Macro Assembler 4.0

Sample C programs

hello, cardfile, clock, fonttest, mapmodes, motion, shapes, template, track, type

Sample Pascal program

muzzle (template for application)

Utilities

Running under Windows:
`Iconedit` (requires mouse)
`Dialog` (requires mouse)
`Fontedit` (requires mouse)
`Heapwalk`
`Shaker`

Running under DOS:

`Link4` (makes Windows executable)
`Make` (program maintainer)
`RC` (resource compiler)
`Symdeb` (debugger)

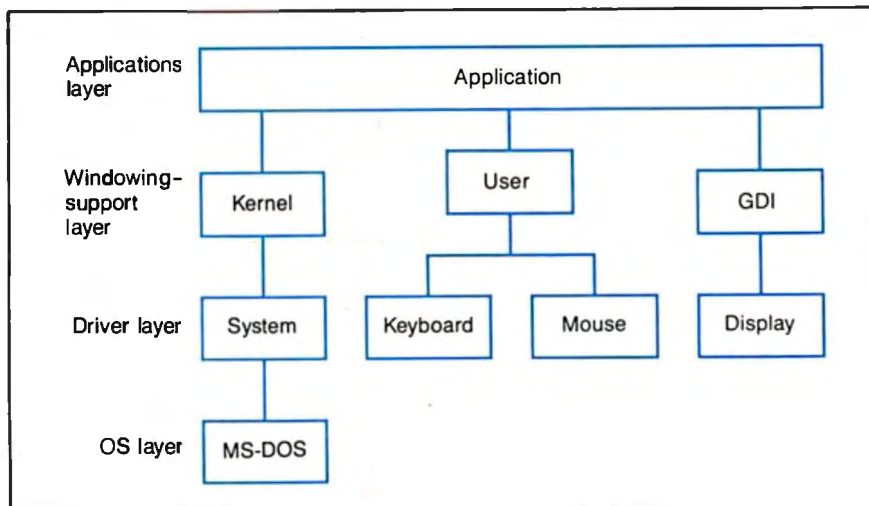

Figure 1: The architecture of Windows as seen from an application.

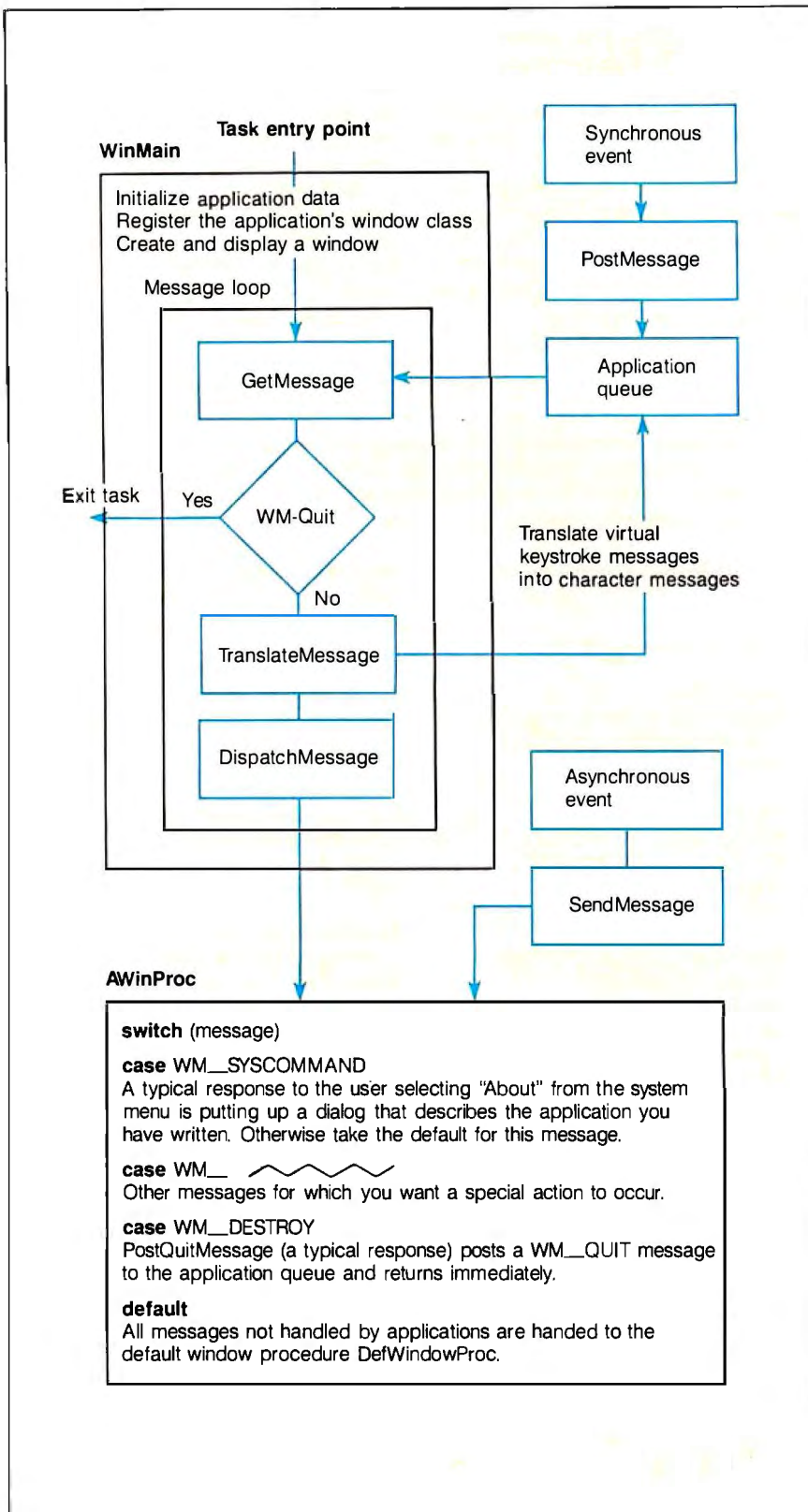

Figure 2: Every Windows application must have a WinMain procedure, which serves as the entry point to the task. WinMain sets the stage for the application and then supervises the removal of messages from the application queue and the distribution of messages among the application's windows. PostMessage returns without waiting for the corresponding window to process the message; SendMessage doesn't return until the message has been processed.

each time you make a change. The cycle is much more manageable with a PC AT compatible. On an 8-MHz PC AT clone with a 40-megabyte hard disk, the time for compiling the same application was under 2 minutes. Much of this time is spent plowing through WINDOWS.H, an 80K-byte header file that must be included at the beginning of C language source files to gain access to Windows's types, structures, constants, and functions. You can shorten the compile cycle substantially by making a custom version of WINDOWS.H for each application that you are compiling and cutting out all definitions dealing with any features your program doesn't use, such as sound, kanji characters, scroll bars, or serial communications.

Utilities

The utilities shown in table 1 that run under DOS are typical of utilities that DOS programmers have always used. The utilities that run under Windows, however, are more like those that a Macintosh developer might use. Every Windows application has an icon that represents it when its window is collapsed. You create these icons with Iconedit. Iconedit gives you a large window in which you design your icon by toggling bits on or off. Simultaneously, another window shows the actual-size icon that is the result of the pattern you are creating. You can also use Iconedit to create any nonstandard cursors that your program uses.

You can use Fontedit to create custom fonts for your Windows applications. You cannot edit the fonts included with Windows using Fontedit, however, since those fonts are distributed in a compiled format.

You can create dialog boxes by hand and specify them in the resource script file or on-screen using the dialog box editor, Dialog. The dialog editor allows you to prototype dialog boxes on-screen, which is considerably easier than planning them on paper and typing in specific (x,y) locations and sizes for each element. Dialog produces an ASCII dialog description that you can include in the resource script file.

Heapwalk displays each block of memory, giving the size of the block and the name of the program that allocated the memory. This information is useful when debugging a program that may have bugs in its memory management.

The Shaker utility torture-tests the integrity of a program's memory management by allocating and freeing up blocks of memory. This forces all other programs running at the same time to move

continued

EGA WONDER™

Graphics Solution™



Graphics Solution



EGAWONDER®

ATI Technologies – “Technology You Can Trust”

ATI's innovative solution for displaying graphics in a simple and straight-forward manner is the highly acclaimed EGA WONDER.

With automatic mode switching, EGA WONDER displays all popular graphics modes on any monitor. Taking the confusion of complicated software standards out of the hands of the user, EGA WONDER eliminates the use of specific monitors for specific programs. Because of its flexibility, EGA WONDER is a breakthrough for business and teaching institutions which use many different types of monitors.

ATI Technologies' solution for displaying graphics on Monochrome or RGB monitors are the unique GRAPHICS SOLUTION and GRAPHICS SOLUTION-SP. Certified by Lotus for 132 column spreadsheets, these low cost graphic cards display Color/Graphics and Hercules software on either color or monochrome monitors. GRAPHICS SOLUTION-SP includes both parallel and serial ports to allow addition of peripherals such as a printer, modem, mouse, or plotter.

Breaking through barriers of compatibility, EGA WONDER and GRAPHICS SOLUTION mean “Technology you can Trust”.

Reasonably priced by all leading computer stores. Contact your dealer or call us at (416) 756-0711.

See us at
 **COMDEX/Spring '87**
 June 1-4, 1987
 Georgia World Congress Center
 Atlanta, GA booth no. 1020 / 1021



Technology you can Trust.

ATI Technologies Inc.
 3761 Victoria Park Ave., Scarborough, Ontario, Canada M1W 3S2
 Telex: 06-966640 (ATI TOR) Tel.: (416) 756-0711 Fax: (416) 756-0720

Trademarks: ATI, EGA Wonder, Graphics Solution – ATI Technologies Inc.
 Lotus – Lotus Development Corporation. Lotus logo used by permission.

Any Software. Any Monitor. AnyTime – Digital Monitor.

Inquiry 27

Microsoft Windows Software Development Kit version 1.03**Type**

Libraries and utilities for making stand-alone Windows applications

Company

Microsoft Corp.
16011 Northeast 36th Way
P.O. Box 97017
Redmond, WA 98073-9717
(206) 882-8080

Format

Seven 5¼-inch MS-DOS disks

Computer

MS-DOS- or PC-DOS-based machine with a graphics monitor, 512K bytes of RAM, DOS 2.0 or higher, two double-sided floppy disk drives or one floppy disk drive and a hard disk drive (recommended), and a graphics adapter card; mouse recommended

Language

Microsoft C; Microsoft Assembly

Documentation

Programmer's Utility Guide; Programmer's Reference; Update to the Programmer's Reference; Programming Guide; Application Style Guide; Quick Reference

Price

\$500

around in memory. This movement will cause your system to crash.

Device Independence

The GDI gives applications a large degree of device independence by acting as a layer between the application and the hardware. The main benefit of the separation of the program from the hardware is that a Windows application requires no modification to work with any display device or printer that has a Windows driver. The same program that runs on an IBM PC with a CGA and an Epson printer will run on a Compaq 386 with a super-high-resolution screen and a laser printer. The GDI and its device drivers handle the transformations. If necessary, you can query the GDI to find out specifics of a hardware device, such as resolution of a screen or the colors available on a printer, but, in most cases, the GDI's transformations are adequate.

This device independence has another benefit: As graphic coprocessors become more common in display adapters, Windows programs can readily take full advantage of them, since most devices will

come with Windows drivers. Already companies are working on using the Texas Instruments 34010 graphics coprocessor in graphics boards so they will work with Windows applications. Renaissance GRX has announced one such board, the Rendition I, which makes the Windows operating environment from 23 to 91 times faster for EGA mode.

Data Exchange

Windows has two types of data exchange. If you are familiar with the Macintosh, you probably know about the Clipboard, a holding place for data. You can cut or copy text or graphics from one document and then paste it back into the same document at a different place or into another document. The handy Clipboard makes integration of different programs a snap.

Dynamic Data Exchange (DDE) is a protocol developed by Microsoft for message-passing between applications. Using DDE, a spreadsheet would notify a graphing program each time a cell's content changes so the associated graph is kept current. Similarly, the graphing program would notify the word processor each time the graph changes. In this way, changing a spreadsheet would automatically update the graph in a word-processing report. The DDE protocol is not described in the Windows manuals, but the definition of the standard is available from Microsoft.

Memory Management

Windows's sophisticated memory manager allows dynamically loaded and linkable program code, data, and resources. You can move code, data, and resources around to group all free memory together or discard them when free memory is low. When a discarded code segment or resource is needed again, it is automatically reloaded from the disk.

This means that you can run a program that is larger than available memory if you design it so that it is separated into several segments of associated code. Only the segment being executed will be loaded if memory is low. If there is enough room, the entire program will remain in memory. The memory manager also provides for code-sharing where two or more copies of a program running at the same time share the same code but use separate data segments.

Debugging

A modified form of Microsoft's Symdeb symbolic debugger is supplied with Windows. You must run Symdeb on a different screen than Windows. If you have a CGA and a monochrome adapter, you're in good shape, since Symdeb will use the monochrome monitor. If you don't have

two monitors, you must hook up a dumb terminal or another PC using terminal software to the COM1: serial port. As your program runs, Symdeb displays memory-allocation messages on the terminal or monochrome card when memory is allocated or moved. When you are in Symdeb, you can set breakpoints in your program, look at global variables, see the currently executing line of the program's source code, and examine the processor's registers. If you have a PC AT or compatible, you can use the System Request key to break out of Windows and get into the debugger at any time. If the computer hangs up, all you have to do is hit the System Request key to get into Symdeb and look at the offending line of code. If you use a PC XT, you'll have to simulate this by setting breakpoints where you suspect trouble.

Symdeb is much better than its predecessor, Debug, and can be useful, but it is far from what it should be. A debugger for Windows should run under Windows, not requiring a second screen, and it should use menu commands and dialog boxes to interactively debug instead of requiring cryptic two-letter commands. Microsoft's newer CodeView, a symbolic debugger included with Microsoft C version 4.0, cannot yet be used with Windows, although Microsoft has said that will change. A Windows version of CodeView would be useful, although another PC would probably be required solely for debugging.

Symdeb on a terminal is so awkward to use that we found it easier to use debugging messages like starting function foo() or count = %d at key points in the program. We put these messages in a standard dialog box using the MessageBox function. Such messages are easy to code and give exactly the information that you want.

Documentation

The Windows development kit documentation totals about 1200 pages in three binders. One binder consists of the *Programmer's Utility Guide* and *Update to the Programmer's Reference*. The utility guide describes the syntax and usage of the utilities shown in table 1. The update explains features new to Windows version 1.03. The *Programmer's Reference* describes Windows functions, Windows data structures, and messages. Unfortunately, it is hard to see how the components work together.

What is conspicuously missing is a tutorial guide to Windows programming. The binder containing the *Programming Guide*, *Quick Reference*, and *Application Style Guide* explains one simple pro-

continued

Ctrace

Find your programming errors the fun way with Ctrace. Our exciting C source debugger makes it so easy to track down bugs that you'll love doing it.

Your MIX C programs will come to life on the screen. You'll see your variable values change as you watch your source code execute. Our unique animated trace feature highlights each C statement as it executes. It's like watching the bouncing ball as the cursor moves from one statement to the next. The internal workings of your program are revealed through 6 windows: source, output, variables, watch, memory, & symbols. View up to 4 of these windows at the same time.

You have complete control of your program. Execute one statement at a time, or run the program at trace or full speed. Insert an unlimited number of break points to stop execution at selected statements. Insert watch points to stop execution when selected variable values satisfy your defined conditions. Interrupt the program at any time, even in the midst of reading input from the keyboard. You can even change variable values, alter the execution path, or trace the flow of control backwards.

Ctrace is so simple to operate that you can almost use it without thinking. No complicated commands to remember, just press a key. Help screens list the keys & popup windows list the options. After 30 minutes, you'll be using Ctrace like a pro. Your productivity will improve dramatically & your programs will work more reliably. What was once a dreaded chore becomes an enjoyable experience. Debugging is fun when you have Ctrace doing all the work. So order your copy of Ctrace today and start working smarter instead of harder.

TO ORDER CALL TOLL FREE: 1-800-523-9520

For technical support and for orders inside Texas please call (214) 783-6001 Or Contact one of our Distributors in Canada: Saraguay 1-800-387-1288 • France: Info/Tech 1-43-44-06-48 • Australia: Techflow 047-586924 • Switzerland: DMB Communication CH-0-523-31817 • England: Analytical 04215-62099.

System Requirements: MSDOS/PCDOS 2.0 or higher; 256K Memory; 1 Disk Drive or CP/M 2.2 or higher (280); 55K Memory; 1 Disk Drive (2 recommended) Ctrace requires MIX C compiler & MSDOS/PCDOS (not available for CP/M).



Ctrace

Put some fun into your programming with this exciting C source debugger.

Only
\$39.95

MIX C COMPILER \$39.95

You can see that Ctrace is not your typical debugger. It's powerful but easy to understand & simple to operate. MIX C is designed the same way. Unlike other C compilers, it's small and fast. In fact, it's the only standard, full featured C compiler that can be operated comfortably on floppy disks. And as you would expect, MIX C is easy to use. It produces a complete program listing with all errors clearly identified and explained.

Although it's small, MIX C is not a subset. MIX C supports the full K&R standard, including the extensions that are often omitted in other C compilers. MIX C comes complete with a fantastic book, a library of more than 175 functions, a blazingly fast linker, and tools for optimizing your programs for minimal space or maximum speed. All of this is yours for little more than the cost of most C books alone.

The combination of MIX C with Ctrace makes C programming a real joy. MIX C provides the power of a compiler while Ctrace provides an execution environment that's better than an interpreter. Now you can have the best of both worlds at a very down to earth price.

SPLIT-SCREEN EDITOR \$29.95

Another great companion to the MIX C compiler is our split-screen editor. It makes writing programs even faster & easier. With the MIX Editor, you can compile, link, & execute or trace your program at the touch of a key. Compiling is fast because the MIX C compiler reads the program directly from memory. Correcting errors is easy because the editor automatically positions the cursor to the first error in the program. The editor is similar to Micropro's WordStar but with additional programming features like split-screen, macros, and much more. Together with the C compiler & Ctrace, the editor forms an integrated programming environment.

ASM UTILITY \$10

Our ASM utility is available if you want to link assembly language functions to your C programs. It works with Microsoft's MASM or M80 assemblers. Call assembly language functions just like C functions. Call C functions from assembly language. Lots of useful assembly language functions are included as examples.

The MIX C Works Only \$89.90



Save \$29.95 on the Works includes Editor, C Compiler, Ctrace, & ASM Utility

Product	Price	Total
—Ctrace	(\$39.95)	\$
—C Compiler	(\$39.95)	\$
—ASM Utility	(\$10.00)	\$
—Split-Screen Editor	(\$29.95)	\$
—The MIX C Works	(\$89.90)	\$
(includes all of above)		
Subtotal		\$
Texas Residents Add 7.25% Sales Tax		\$
Add Shipping Charges		\$
In USA: add \$5 per order		
In Canada: add \$10 per-order		
Overseas: add \$10 for editor		
add \$20 for compiler		
add \$30 for Works		
Total of Your Order		\$

30 Day Money Back Guarantee Not Copy Protected

Please check method of payment
 Check Money Order MC/VISA
 Card # _____
 Expiration Date _____
 Please give name of computer _____

Please check operating system
 MSDOS/PCDOS CP/M

Please check disk size
 5 1/4" 3 1/2" 8"

Please check disk format if CP/M
 SSSD SSDD DSDD

Your Name _____
 Street _____
 City _____
 State _____ Zip _____
 Telephone (____) _____
 Country _____

MIX software 1132 Comstock Drive
 Richardson, Tx. 75081
 (214) 783-6001

Ask about our volume discounts! Dealer Inquiries Welcome **B**

gram, which prints "Hello, Windows." The example is useful, but one example is not enough. It took us quite a bit of reading and playing around with the sample programs on the disks before we started to understand Windows and how the applications work. A tutorial guide is desperately needed to explain the new concepts and caveats of Windows programming.

Once you get a feel for Windows programming, the documentation is efficient and easy to use. The manuals are organized logically with an ample number of examples, all in Microsoft C, and a good index.

Developers can obtain a license at no cost from Microsoft that allows the distribution of the Windows run-time system. This means that you can develop Windows applications without requiring the purchasers to own Windows. The catch is that the version distributed is specific to your application. The Windows package is needed to use more than one application at a time.

Why Windows?

The Microsoft Windows Software Development Kit 1.03 is expensive, slow, and difficult to understand at first. Once the learning curve is conquered, though, you can enjoy the benefits of a consistent, in-

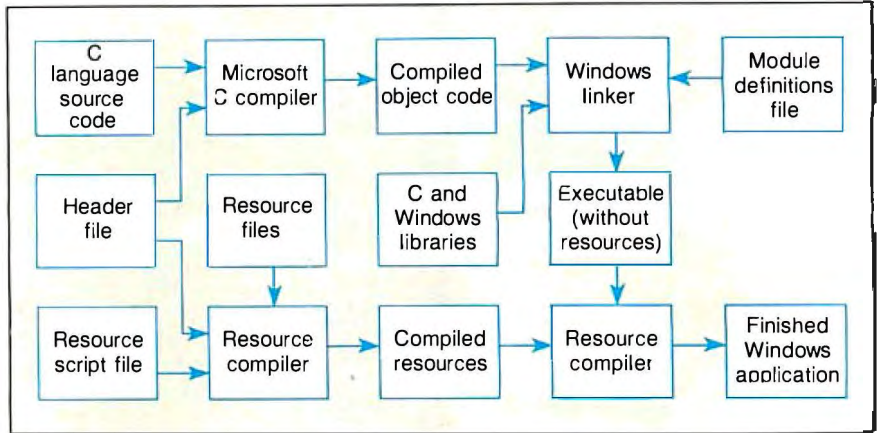

Figure 3: The flow from source code to executable code required to build a Windows application. You can automate the process with the Make utility.

tuitive, window-based user interface with pull-down menus, multitasking, and device independence. Also, Microsoft has stated that Windows applications will be easily ported to future operating systems.

Windows applications created with this kit require a hard disk with a PC XT compatible for mediocre performance and a PC AT for acceptable performance. The speed of Windows will become less of a problem as available hardware improves. Already companies are taking ad-

vantage of Windows's device independence by creating fast graphics boards for it. ■

David Hart (855 High St., Chestertown, MD 21620) is an independent software developer and freelance writer. Lee Hart (201 Cedar St., Chestertown, MD 21620) works in the Naval Architecture Department at Advanced Marine Enterprises and regularly consults with MicroSystem Specialists in Blacksburg, Virginia.

Smalltalk/V Release 1.2

Mat Davis

Smalltalk/V release 1.2 from Digitalk is an inexpensive object-oriented programming environment for the IBM PC and compatibles. At a cost of \$99.95, Smalltalk/V implements the complete Smalltalk language, except for multitasking, as developed by researchers at the Xerox Palo Alto Research Center (PARC).

Smalltalk/V 1.2 is not copy-protected, and it follows in the tradition of Borland's Turbo Pascal in being a high-quality software package at an affordable price. However, Smalltalk/V requires 512K bytes of memory, two floppy disk drives or a hard disk, and a graphics adapter. Digitalk strongly recommends that you also have a Microsoft-compatible mouse, and an 8087 coprocessor is required for floating-point operations. The system supports the IBM Color Graphics Adapter in 640 by 200 mode, the Enhanced Graphics Adapter in 640 by 200 and 640

by 350 modes, the new Video Graphics Array's 640 by 480 mode, the AT&T PC 6300's and Toshiba T3100's 640 by 400 mode, the IBM 3270 PC's 720 by 350 mode, and the Hercules video boards. For this review, I used an IBM PC-compatible ITT XTRA with 640K bytes of RAM, a 20-megabyte hard disk, a Hercules graphics adapter, and a Microsoft Mouse.

Methods, Digitalk's original Smalltalk implementation that sold for \$250, has been replaced by Smalltalk/V. The language supported by Smalltalk/V is identical to that used in Methods. In contrast to Methods, however, Smalltalk/V supports graphics, uses a mouse, and communications support is optional.

Features of Smalltalk/V

As with other object-oriented languages, a Smalltalk/V program consists of a col-

lection of objects, such as integers, strings, programs, or airplanes, that perform computations by sending each other messages, such as add, parse, run, or dive. Smalltalk/V features all the characteristics of Smalltalk, including the ability of different objects to respond to the same message in different ways, support for inheritance, and encapsulation of objects. [Editor's note: For more information on Smalltalk, see the August 1986 *BYTE*, which has a theme of Object-Oriented Languages.]

The language implemented in Smalltalk/V is generally consistent with Smalltalk-80 from the Xerox PARC. However, while Smalltalk-80 considers a windowed application to consist of a model, several views, and several controllers, the same application in Smalltalk/V consists of a model, several panes, and several dispatchers. Even though this difference is primarily one of terminology, it means that programs using some of the more sophisticated classes may need considerable translation.

continued

MEET ^{ONE}_{OF} THE FASTEST TURBOS IN EUROPE



BASIC MODELS UNDER \$800
NOT SHOWN

When you hear "turbo" you no doubt think of Europe's finest. Well, *Spring Circle*, one of the most popular computers in Europe and Israel for over five years, puts that same kind of quality and performance into its *Turbo-88 System*. And now it's here. The *Turbo-88* is completely *IBM* compatible, offers 85% faster processing speed, and comes with extras like keylock security and front panel Turbo/Reset switches. *Spring Circle* has a full line of monitors and keyboards for you to select from.

WITH A MODEM TO MATCH. The *Spring Modem 1200X* is the most advanced on the market. Microprocessor based, this modem has all the features of other modems and more. Unlike any other modem, the *1200X* features an auto data/voice transfer system that lets you use your phone while transferring data. *Spring Circle* computer systems are recognized throughout Europe for their quality and reliability, and now for their speed.

Call *Spring Circle Technology, Inc.* for more information on one of the hottest Turbos now in the US. Dealer inquiries are welcome.

IBM is a registered trademark of International Business Machines Corp.
Spring Circle is a registered trademark of Spring Circle Technology, Inc.
Designed by Bennett Design and Illustrating, Seattle

Inquiry 297



SPRING CIRCLE TECHNOLOGY, INC.

Spring Circle Technology, Inc.
717 Industry Drive
Seattle, WA 98188
Tel.: (206) 575-8086
Fax.: (206) 575-6808

Manufacturer
Spring Circle Computer, Inc.
3rd Floor, No. 126 Roosevelt Rd. Sec. 3
Taipei, Taiwan
Tel.: (02) 341-3111 Fax.: (02) 394-5587

JUNE 1987 • B Y T E 257

Smalltalk/V has several special features, such as its use of virtual memory techniques that allow the normally huge amount of source code in Smalltalk (a minimum of around 600K bytes for Smalltalk/V) to work in a 512K-byte environment with a hard disk. While a 512K-byte system may not sound very small for a PC, many versions of Smalltalk require a minimum of a megabyte of RAM, and some require as much as 4 megabytes to achieve good performance. Thus, Smalltalk/V runs in a relatively cramped system.

Here's how Smalltalk/V's virtual memory works: When, during program development or when a program is running, the 512K bytes of memory fills up,

Smalltalk/V spends a few moments moving some objects (those that do not "contain" other objects) to the hard disk before resuming normal operation. This does not happen with floppy disk-only systems, which, according to Digitalk, are too small and slow to support it. While the system slows down somewhat after this swap-out occurs, it brings objects back into memory as they are used, and, within a minute or so of your using the system, all the objects currently in use are brought back into memory. The system actually runs faster than before because more memory is available.

Smalltalk/V comes with many sample programs, one of which is Prolog/V. While the syntax of Prolog/V is not iden-

tical to the standard Clocksin and Mellish version, the differences are minor. Unfortunately, the only documentation provided for Prolog/V is in a file on one of the distribution disks.

Using and Modifying Smalltalk/V

Installing Smalltalk/V is quick and easy: you run a batch file that configures the system for either floppy or hard disks and your graphics adapter, and the system is ready to go. In addition to the Smalltalk interpreter and a small configuration file that gets modified by the installation process, Smalltalk/V comes with an image file, a sources file, and a change log.

The image file contains the current

continued

PREVENT POWER PROBLEMS FROM STEALING YOUR TIME AND MONEY



400 Watt System - \$449
800 Watt System - \$795

100% parts and labor warranty for 12 months, with 1 day turnaround service.

The powerline can wipe out your data, cause computer and printer failures, damage hard disks, and cause data errors. It is a primary source of operator frustration and lost time and money.

Fortunately, there is a solution!!

The Meirick Stand-By Power System provides backup power when a power interruption or low voltage occurs. It also filters out powerline noise and eliminates damaging surges.

The Meirick System is the total solution.

MEIRICK INC.

Box 298 Frisco, Colorado 80443

Call us at 303-668-3251



Revolution.



Drafix 1 CAD, \$195

Evolution.



Drafix 1 Plus CAD, \$295

Drafix 1 totally changed the image of low priced CAD software.

It proved that you could have extremely sophisticated performance and features demanded by serious CAD users.

Yet still be very easy to learn and use for the novice. All at an amazingly low price.

Now we've done something even more dramatic. We've improved it.

Drafix 1 Plus. A great new package at a great old price. \$295.

Reviewers called Drafix 1 a "breakthrough" in design, speed and ease of use.

Drafix 1 Plus is a breakthrough in value.

Check these exciting new features:

— A pop-up text editor for writing, editing and rearranging even large blocks of copy.

— Function key macros so you can store and customize Drafix commands to your personal workstyle.

— Sophisticated curve-fitting splines and free-form sketching functions to let you draw complex shapes.

Plus we added two more bonuses. A symbol library (an \$80 value) with 450 pre-drawn, time-saving symbols.

And, along with our standard pen-plotter support, our DotPlotter software (worth \$45) that lets you create high resolution plots of any size on your dot matrix printer.

Of course if these are more features than you need there's an equally good choice — Drafix 1.

Drafix 1. Everything you want in CAD software — at \$100 less.

Reviewers called Drafix 1 "the best CAD buy in town" at \$295. We wonder what they'll say for \$100 less.

That's right. The original Drafix is still available at a dramatically reduced price. For just \$195 you can have all of the features and performance that made Drafix 1 "the best CAD buy under \$500."

A powerful CAD tool you'll be using in minutes.

You'll never use an easier menuing system than Drafix. Everything is on display all of the time so there's no searching, backtracking or memorizing.

In just minutes you'll be doing drawings that would take days to learn on most other CAD software.

And you'll find yourself easily using features that are normally found only on software costing more than 10 times as much as Drafix.

Rotating, scaling, stretching and trimming, multiple object snap modes—they're all included along with much, much more.

Drafix is a powerful, full-featured CAD tool. It just doesn't happen to be priced like one.

Order toll free and get our 30-day money back guarantee.

One thing hasn't changed. Our money back guarantee.

Try Drafix 1 or Drafix 1 Plus for 30 days and return it for a full refund if you're not completely satisfied.

With no-risk, high performance and affordable prices, there's just one choice to make.

To buy the package that started the CAD software revolution. Or the one that's continuing it.

Make your toll-free choice today.

Order Now!

Contact your local Drafix dealer or call toll-free.

Use your Visa, MasterCard or American Express

1-800-231-8574

Ext. 150

- Drafix 1 CAD package, now only \$195.00
- Drafix 1 Plus CAD package (Includes \$45 DotPlotter and \$80 symbols library) just \$295.00
- Mouse Systems mouse also available (add \$100)
- Ask about our Architectural, Mechanical and Electrical symbol libraries and OTTD, our AutoCAD File Exchange Utility.

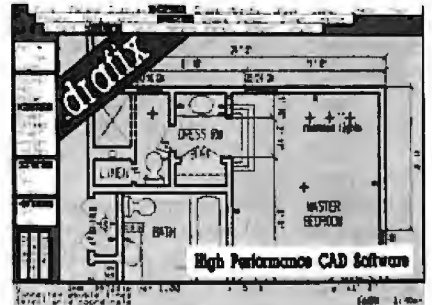

FORESIGHT
Resources Corp.
932 Massachusetts
Lawrence, KS 66044
(913) 841-1121

Smalltalk/V release 1.2**Type**

Smalltalk language and programming environment

Company

Digitalk Inc.
9841 Airport Blvd.
Los Angeles, CA 90045
(213) 645-1082

Format

Three 5¼-inch floppy disks

Computer

IBM PC, XT, AT, or compatible with 512K bytes of memory, two floppy disk drives or a hard disk, and a graphics adapter; mouse recommended

Necessary Software

DOS 2.0 or higher

Language

Smalltalk/V; Assembly language

Options

EGA/VGA color-extension kit:	\$49.95
Communications package:	\$49.95
Goodies extension kit:	\$49.95

Documentation

514-page *Tutorial and Programming Handbook*; tutorial source code on disk; Prolog/V documentation on disk

Price

\$99.95

image of the system. Unlike other languages, in which each program is isolated in its own file, a Smalltalk program is a collection of objects, classes, and methods, all of which become a part of the Smalltalk system after they are created. To save your work, you save an image of this system, which includes all the classes and objects in it. Since even the windows on the screen are objects, their size, position, and contents are also saved in the image. Note, however, that this creates some problems for developing applications with Smalltalk/V, since the program you are developing is actually part of the complete system. Distributing the application would mean distributing the entire system unless the other users already have Smalltalk/V.

The sources file contains, in a compressed format of about 300K bytes, the source code for the entire system except the compiler. Changes to the system take place as follows: When you add or change a method, the system writes the new code

to the change log file, which is initially empty. Then the system updates its record of the code to reflect the new code's location in the change log. Thereafter, the new code supersedes any code that may be in the sources file. Since the information about the location of the new code is part of the image, you must always keep together a set consisting of the image file, sources file, and change log for them to remain consistent.

The change log also serves as a safety net; anytime an expression is evaluated, it is written to the change log. Since new objects can't be created unless some kind of expression is evaluated (even if the expression is as simple as Dashboard Open), the change log provides a complete record of the state of the system in the event of a crash. Even if you haven't saved the image for hours and a power failure or crash occurs, all the changes made during that time are in the change log, and you can recover them. Thus, the chances of losing work in a Smalltalk system are remote.

While the change log protects you against losing work, this protection is not often needed. Smalltalk/V is capable of handling the majority of programming errors by simply interrupting the errant program and allowing you to debug it interactively. The only exception to this arises when you make an incorrect modification to portions of the windowing code, and the system can't open its usual debugging window. In this severe case, Smalltalk/V encounters an error while trying to report an error and usually cannot recover. Fortunately, these cases are relatively rare, and you will generally have no problems modifying the system while it is running, a capability that became a tradition with Smalltalk-80, and it makes Smalltalk/V a robust system.

Smalltalk/V Windows

The standard Smalltalk/V system contains several types of windows. You can subdivide each window into smaller sections, called panes, and each window has two or more pop-up menus associated with it: a window menu for resizing, moving, or closing the window, and a pane menu that lists actions relating to each pane in the window. For example, the menu for a standard text-editing pane contains choices such as cut, copy, paste, and search.

The system-transcript window is Smalltalk/V's message window, and you cannot close it, although you can resize and move it. Class browsers provide the means for modifying and creating classes in Smalltalk/V. A class-browser window consists of five panes. The first two are used for selecting whether class methods

(for messages sent to the class itself) or instance methods (for messages sent to individual instances of the class) are listed in the methods pane. The other three panes are for class, methods, and text. The class pane shows a list of all classes in the system. Choosing one of these classes causes a list of the methods defined in that class to appear in the method pane. The method pane's menu provides choices for adding and removing methods. You can also select a method, which causes the source code for the method to appear in the text pane, where you can edit and save it.

A workspace is a Smalltalk text editor that serves as a place for testing code, making notes, or performing calculations. To test programs or perform calculations, you can type any sequence of Smalltalk statements, select them with the mouse, and evaluate them using either the Do it or Print it choices from the pane menu. The Do it option evaluates the expression and discards the answer and is useful for expressions such as reading new code from a file where you do not need to see an answer from the system. The Print it command evaluates the selected expressions and displays the result in the workspace. Thus, you can do calculations by typing and selecting an expression, such as $7 * 3 + 4$, and then selecting Print it.

While the only code that is really a part of the system is that contained in the methods in the various classes, the contents of all the windows are saved along with the rest of the system, so code typed into a workspace can effectively become permanent.

Smalltalk/V provides debugging assistance through a series of interactive windows. When an error occurs, the system presents you with a walkback window that shows all the messages that have been sent but not yet answered. From this window, you can elect to either debug the problem or abandon the computation. If you choose to debug, a special debugging window appears. This window enables you to examine any of the variables in use, change their values, or change code. Once the error has been corrected, execution can be resumed.

Using Windows in Development

Class-hierarchy browsers, workspaces, and debuggers all play an important role in writing Smalltalk programs. For example, you use a class browser to create a new class by simply selecting its superclass and filling in a template for a class definition. You then use the class browser to write the methods for that class, and you can use a second or third browser to

continued

The Small Office LAN

User-Friendly, Full-Featured, 6-PC Networking Solution

Only \$149.50 per PC Complete.



Standard phone wire



TRUE NETWORK PERFORMANCE

- Peripheral Sharing:** enables up to 6 PC users to share laser or impact printers and storage devices.
- Runs 99% of PC/MS-DOS Software*:** lets you share software you already own for word processing, accounting, database, spreadsheets, CAD/CAM, etc. (PC, XT, AT and compatibles).
- Transparent Natural Use:** allows direct access to remote files and programs on remote PC's. You don't have to leave your application and use a special program to copy files to your PC.
- Print Spooler:** lets you continue using your PC while your data is being printed or waiting to be printed. You use your present printing commands to automatically send your data to the printer.
- Fault Tolerance:** Software is resident on all networked PC's so any PC can be turned off or fail without interrupting network operations.
- Security:** Network users can be restricted from using printers, and reading or writing to designated storage devices.



USERS REPORT

Innovative Solutions:
Dick Crawford, President — "Extremely economical. . . We now save file space and share printers. . . A significant cost savings."

Holiday Inn, Corporate Headquarters:
Ben Holcomb, Director of Finance and Planning of International Hotels — "The Knowledge Network is an exciting product for the price. . . in fact, we're encouraging other Holiday Inn branches to use it."

Quantitative Software Reports:
Jay Siegal, Managing Director — "The Knowledge Network offers the minimal amount of disruptions to my complex programs. . . No hardware needed, no new commands. . . it meets my networking needs perfectly."

InsMark:
Max Dunn, System Manager — "It's our number one choice among software LAN's that we've reviewed. It's ideal for sharing disks, virtual drives and our other costly peripherals."



FEATURES

- **Guaranteed:** If you're not satisfied, return the product within 60 days for reimbursement.
- **Complete:** comes with everything: software, Network Controllers, phone wire and RJ 11 connectors.
- **Proven:** more than 2,000 satisfied Knowledge Network users.
- **Easy Installation:** user installable in 10 minutes. Network Controller connects to RS232 serial port using standard telephone wires and jacks. All PC's networked in parallel on a single "party line."
- **Low Complete Cost:** best price/performance ratio in PC networking: \$299 for the two PC Starter Kit and \$149.50 per Add On Kit. No networking boards, file servers, dedicated computers, dumb terminals or additional bridge software is necessary.
- **No Learning Curve:** uses standard PC/MS-DOS commands.
- **Fast:** operates at up to 115,200 bps and uses automatic error correction Ethernet-like system (CSMA CD/CA).

Network Controller (plugs into RS232 serial port in each PC)



Applied Knowledge Groups, Inc.
1095 E. Duane Ave.
Suite 203
Sunnyvale, CA 94086
(408) 739-0300



Harry Coin, designer of the Knowledge Network:
"It's a low-cost, complete network. You don't have to learn new commands, or buy special network programs to get the job done."

THE KNOWLEDGE NETWORK

2 PC Starter Kit \$149.50 × 2 = \$299 (2 RS232 Network Controllers, phone wire, RJ 11 connectors, software and manual)

1 PC Add-On Kit \$149.50 each (1 RS232 Network Controllers, phone wire, RJ 11 connector, software and manual)

Add \$10 for shipping & handling

CA residents add applicable sales tax

Payment or Charge: VISA MC AMEX Check

Inquire for overseas pricing

1-800-443-1254

1-800-422-1254 in CA

NOT COPY PROTECTED

*MS-DOS (from V 2.0 and up), Lotus 1,2,3, dBASE (II & III +), Wordstar, Word Perfect, Word, Signix, Reflex, The Analyst, AutoCAD, etc. Supports plotters. AutoCAD is a registered trademark of Autodesk, Inc. dBASE is a registered trademark of Ashton-Tate. IBM PC, XT, AT are registered trademarks of International Business Machines Corp. WordPerfect is a registered trademark of Software International. Lotus 1,2,3 is a registered trademark of the Lotus Development Corp. Wordstar is a registered trademark of MicroPro. Ethernet is a registered trademark of the Xerox Corp. Word and MS-DOS are registered trademarks of the Microsoft Corp. Signix and Reflex The Analyst are registered trademarks of Borland International, Inc.

consult methods in other classes, which is a real convenience.

A workspace serves two purposes during program development: for defining any global variables that the application requires and for testing the partially completed application.

Finally, the debugger allows easy inspection of conditions when an error occurs. You can inspect objects, correct and recompile the code, and restart the program at the point where a selected message was sent. In fact, if you use an unimplemented menu choice in your application and get an error, you can use a class browser to add the missing method and then use the debugger to pick up execution where you left off. Thus, a menu may have a choice on it for which no method yet exists, but, as long as that choice is not used, no error occurs. This flexibility strongly encourages incremental testing and refinement.

Benchmarking Smalltalk/V

While Smalltalk systems work well for prototyping applications, they are not normally very useful for compute-bound programs. Smalltalk/V is no exception. It ran the BYTE Sieve benchmark in 31 seconds. This doesn't seem long when compared to the times achieved by BASIC, but most C compilers can run this same benchmark in under 15 seconds, and some can run it in under 5 seconds.

The speed difference is primarily due to the fact that compilers for production languages, such as C or Pascal, read your program once and then translate it into an equivalent machine language program. The interpreters for languages such as Smalltalk and BASIC, however, are constantly reading your program and carrying out its instructions. In the Smalltalk version of the Sieve benchmark, the main loop is interpreted over 8000 times, while the C version is compiled into machine language only once. [Editor's note: *The BENCH.OBJ source code for the benchmark tests is available on disk, in print, and on BIX. See the insert card prior to page 321 for details. Listings are also available on BYTENet. See page 4.*]

On the other hand, Smalltalk/V is well-suited for certain types of numeric problems; with its support for virtually unlimited integers and arithmetic operations on fractions, overflow or round-off errors are rare.

For example, Smalltalk/V doesn't support floating-point numbers without a numeric coprocessor, so in the Calculation benchmark, I used the fractions $\frac{314159}{100000}$ and $\frac{271828}{100000}$ instead of 3.14159 and 2.71828. Since Smalltalk/V was performing its calculations using fractions, there were no errors, even after

5000 iterations. The test took 38 minutes and 44 seconds; certainly not quick, but neither the numerator nor denominator of either fraction fits in the 8086's 16-bit word. Since they do not fit, Smalltalk/V must expend considerably more effort to multiply, divide, and reduce these fractions than it would for integers.

A short program to calculate the first 50 factorials runs in just under 3 seconds and calculates each factorial exactly; the answer to 50 factorial is 65 digits long. In fact, while the recursive factorial routine provided by Digitalk causes a stack overflow while computing 1000 factorial, you can easily write an iterative version that will give you the full 2568-digit value.

The Disk Access in BASIC Write benchmark test (writing a 64K-byte sequential text file to a blank floppy disk) took 54 seconds, while the Read test (reading the same file) took 112 seconds. Compare this to the results for the ITT XTRA, whose tests were written in ITT's Advanced BASIC, with times of 33 seconds for the Write test and 32 seconds for the Read test. [Editor's note: *See the review "The ITT XTRA" by John D. Unger in the April 1985 BYTE.*]

Regardless of the results of such benchmarks, the real test of speed for an interactive language environment such as Smalltalk/V is actual use. Smalltalk/V usually takes only 3 to 4 seconds to recompile a typical method, and then you're ready to move on. This rapid response gives you the feeling that the system is quick, even on standard PCs.

Drawbacks of the System

While Smalltalk/V will run with 512K bytes of RAM and two floppy disks, the package responds much more quickly on a system with 640K bytes and a hard disk; the more memory you have, the less often the system has to swap objects in and out to disk, do garbage collection, and so on.

Smalltalk/V is also a considerable strain on a standard PC's processing power. The package includes a speed/space software option that speeds up the graphics at the expense of some available memory. After invoking it, the system will save windows that get covered up by other windows so that they do not have to be redrawn every time you access them. This saves time but eats up a lot of memory.

In addition, while Smalltalk/V works with a CGA, this adapter does not really provide enough resolution. The large pixel size results in crude characters and makes it awkward to make a class browser large enough to be useful. Using a Hercules-compatible graphics card, as I did, or an EGA in high-resolution mode eliminates these problems.

A Useful Manual

The documentation for Smalltalk/V is a rather impressive 514-page softbound handbook. The first half is an introduction to Smalltalk in general, and Smalltalk/V in particular, in the form of eight chapters of tutorials, with full source code for the examples on disk. While this book is probably not enough in itself to teach you all the ins and outs of object-oriented programming, it is a good start.

The second half of the book is an encyclopedia of the classes in the Smalltalk/V system. You'll probably use this section frequently, even well after you've become a Smalltalk hacker, due to the sheer number of classes and methods provided.

Smalltalk/V Options and Goodies

Options available for Smalltalk/V include an EGA/VGA color-extension kit and a communications package. This communications package comes with full source code for the assembly language communication primitives and sample Smalltalk classes, such as a simple terminal-window class and a Unix browser class. Omissions from the terminal windows include protocol transfers and emulation of the Digital VT-100 or any similar terminal. If Digitalk doesn't provide transfers and terminal emulation relatively soon, it's a good bet that someone else will.

The browser for use with Unix systems lets you, after logging on, transfer files to or from the Unix system (in text mode only), change directories, or run programs. Again, since full source code is provided, you can fix any minor problems or expand the browser in any way you desire.

Digitalk has also announced a Goodies extension kit that has support for sound and multitasking, but it was not available at the time of this review.

Good Things in a Smalltalk Package

Smalltalk/V is an unusually robust and complete system. Even when running on a standard PC, it rivals other Smalltalk systems that require more powerful computers, more memory, and more disk space. The supplied source code provides many examples of Smalltalk programming, as well as virtually unlimited potential for customization.

While Smalltalk/V may not be suitable for producing production systems due to speed and space requirements, the package is well worth its \$99.95 price tag as an introduction to Smalltalk and object-oriented programming. ■

Mat Davis (Virginia Polytechnic Institute, Department of Computer Science, 562 McBryde Hall, Blacksburg, VA 24061) is an instructor of computer science.



This dial modem comes with a feature you wouldn't expect for \$445. Our reputation.

When you buy a dial modem for \$445, most people don't expect to get much in the way of features. Least of all, a top notch reputation for quality.

But our 2230 Series of 2400 bps modems is made to the same exacting standards as other Codex modems. Modems that have earned such a reputation for quality, they are preferred by more experienced data communications managers than any other brand.

And rest assured, a reputation is hardly the only feature our dial modems come with. The 2230 Series also provides outstanding performance, reliability, and flexibility. They are all full duplex 2400 bps modems that operate synchronously or asynchronously with a unique auto dial feature that supports virtually any com-

puter. Plus they're Hayes compatible and are available as standalone units or as dual modem cards that pack two modems on a single card for maximum space savings.

Of course it's impossible to tell you about every feature of our 2230 Series in this space. But a certain peace of mind comes with the knowledge that everything that goes into our dial modems has to measure up to what goes on them. Our name.

For information about 2400 bps modems starting at \$445, call us at 1-800-426-1212 Ext. 234. Or write Codex Corporation, Dept. 707-34, 7 Blue Hill River Rd., Canton, MA 02021-1097.

codex
MOTOROLA

The Networking Experts

Hayes is a registered trademark of Hayes Microcomputer Products, Inc.

© 1987 Codex Corporation. Motorola and M are trademarks of Motorola, Inc. Codex is a registered trademark of Codex Corporation.

Sales offices in more than 40 countries worldwide. In Europe call 32-2-6608980, in Canada 416-793-5700, in the Far East 852-5-666706 (in Japan 81-3-5848101), in the Americas 617-364-2000.

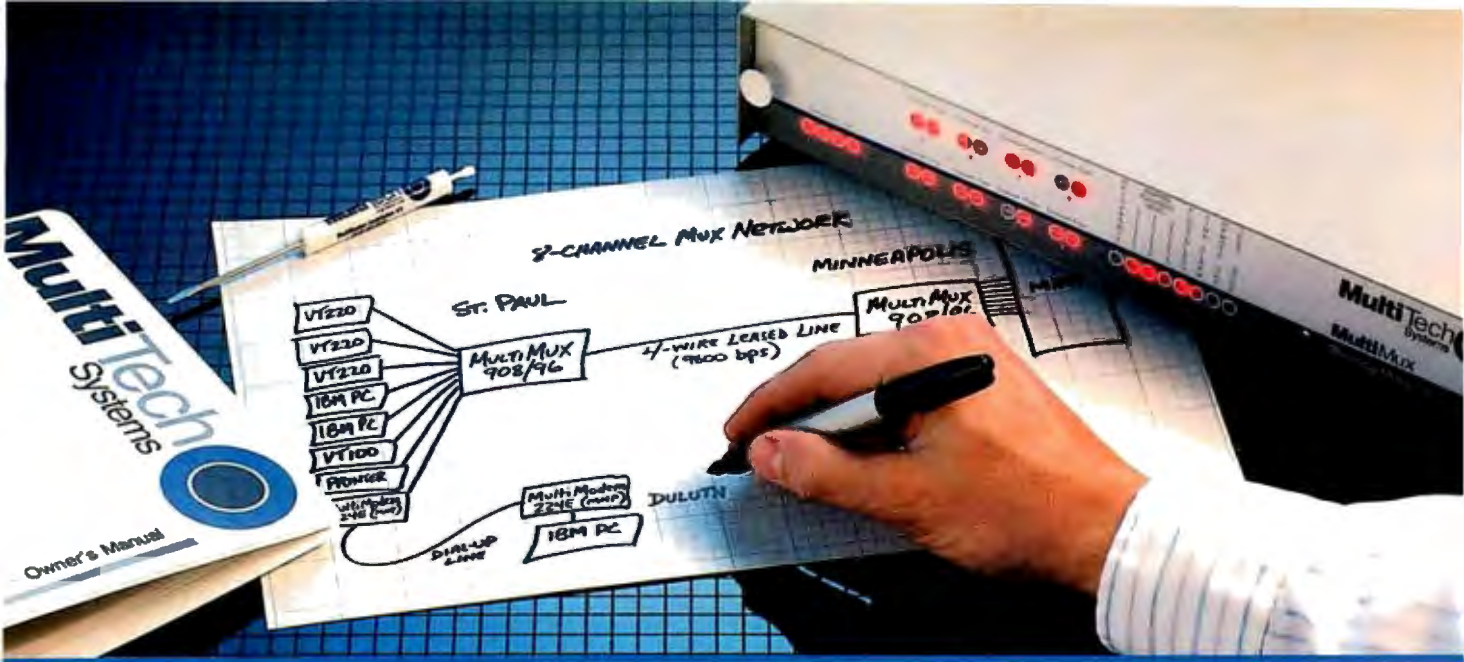

Four- and Eight-Channel Statistical Multiplexers from Multi-Tech Systems:

When it has to be as simple as it is smart

- There are a lot of good reasons to buy a pair of statistical multiplexers. Reduced line expenses, network security and the elimination of transmission errors are the three main ones.
- Unfortunately, most multiplexers come with a big reason not to buy them: They're nearly impossible for mere mortals to install and understand. In other words, they're just not worth the trouble.
- With that in mind, we'd like to introduce you to the new MultiMux™ from Multi-Tech Systems. The biggest difference between the MultiMux and other muxes is that you can easily install a pair of them yourself, without the excessive time, expense and frustration you've avoided in the past.

- You may know us best for our MultiModem™ line of 1200 and 2400 bps dial-up modems. The same simple approach we use for our modems is now used for our MultiMux. We even use similar "AT" type commands.
- The MultiMux is offered in four- and eight-channel versions, with or without an integral 9600 bps V.29 modem. Instead of paying for up to eight dial-up lines for your asynch terminals, PCs or printers, you can use a pair of MultiMuxes to combine them all into a single leased line, for much less money.
- Convinced? If not, consider that the MultiMux is completely command driven, with a supervisory port, help menus, downline loading, full LED display, statistical reporting, and an integral 1200 bps dial-up modem for remote configurations and diagnostics. Also, consider that the MultiMux (like all of our products) is manufactured and supported by us in Minnesota, and that we've been doing so since 1970. Finally, consider our price. You'll find that to be a pleasant surprise too.
- Please call us toll-free at **1-800-328-9717**, for additional information... get a multiplexer that's as simple as it is smart!

MultiMux, MultiModem and the Multi-Tech Systems logo are trademarks of Multi-Tech Systems, Inc.

MultiTech Systems

The right answer every time.

Inquiry 201 for End-Users.

Inquiry 202 for DEALERS ONLY.

Multi-Tech Systems, Inc. • 82 Second Avenue S.E. • New Brighton, Minnesota 55112 U.S.A.
1-800-328-9717 • 1-612-631-3550 • FAX 612-631-3575 • TWX 910-563-3610 (Domestic) • Telex 4998372 MLTTC (International)

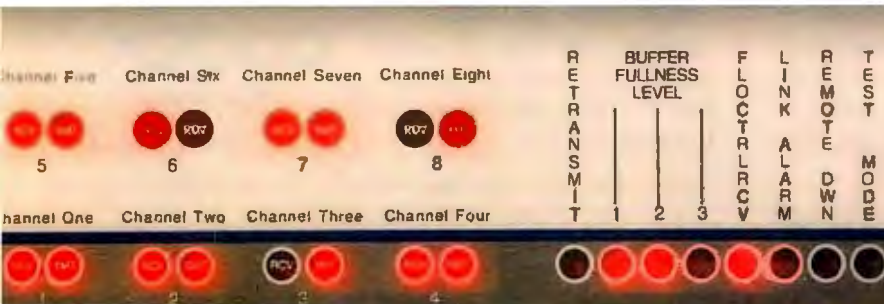

MultiTech Systems

MultiMux
Statistical Multiplexer



Acquaint

Ernest R. Tello

A frame-based knowledge-development system for the IBM PC

Lithp Systems' Acquaint version 2.4F is an expert-system tool, one of the first true frame-based systems for the IBM PC that I have seen. Frame-based systems use object-oriented representations for both knowledge and control. Acquaint is written in Soft Warehouse's muLISP. Within the artificial intelligence community, choosing LISP as a delivery environment usually means a significant loss of performance; however, this package is an exception.

Acquaint requires an IBM PC, XT, AT, or compatible with a minimum of 256K bytes of RAM running MS-DOS 2.0 or higher with one floppy disk drive. I tested it on an IBM PC with 512K bytes of RAM running MS-DOS 3.0 with one floppy disk drive and a Bernoulli box.

The Acquaint system is comprised of three main programs: QAINTEXE, the user environment, QEDIT.EXE, a text editor for creating the knowledge-base file, and KAINTEXE, the development environment. Three main windows are always present when QAINTEXE runs: STATUS, INFO, and BROWSE. Acquaint also has a multiwindow drop-down menu environment for both users and developers. Developers can build stand-alone expert-system applications without paying an additional license fee, and the users need not purchase Acquaint.

The Heart of the System

Acquaint system architecture is built on four basic types of knowledge structure: concepts, rules, contexts, and forms. The concept structure provides the basis for classes of attributes that have limited property inheritance capabilities. The DefConcept construct uses a basic LISP-like frame template to declare concepts (see listing 1). Some of these options are self-explanatory: The PROMPT slot requests what text you want Acquaint to use to request the value of the concept, the FACT slot is for explanatory text to be used in displays needed with the BROWSE facility, and the COMMENT slot can contain

any additional explanation.

Other concepts require more explanation. In the EXPECT slot, you specify the concept's data type and legal values. The simplest option is Y/N, a yes or no question that stores a certainty factor as an answer. The GROUP option specifies that the concept being defined is a collection of related subconcepts. You can specify subconcepts by listing them after GROUP, or you can include them in any rule that specifies this concept group; that is, you put GROUP in the EXPECT slot and then specify the subconcepts later in the rules when you write them.

For a numerical concept, you can specify maximum and minimum values with the RANGE option or a list of permissible values with the VALUE option. For example, you could define the concept Workday in the following way:

```
(Defconcept Workday
  EXPECT:
  Monday
  Tuesday
  Wednesday
  Thursday
  Friday)
```

Using the plural VALUES instead of VALUE lets you select more than one value from the list. Other options for the EXPECT slot include CONVERT and CONVCS, which associate a word with a value.

The DO slot uses available functions and operators to perform a calculation or an operation on various input arguments to determine the value of the concept. For example, you could use DO: (LENGTH * WIDTH] to define the concept RECTANGLE-AREA. The VAL slot lets you specify a constant concept, for example, the concept MONTHS-IN-YEAR is a constant

and could be defined as (VAL 12]. The FUN slot lets you define new functions that you can call by name either in the DO slot or in the rules. FORMAT lets you format the screen into fields, and CLASS makes a true class

hierarchy available so that all properties and formulas can be inherited. DEFAULT holds default values for concepts in case the system can't find a value.

Finally, the options for the PROP slot include ASK (the default), ASKFIRST, ASKNOT, CALC, and STORE. If you omit the PROP slot or specify the default, Acquaint tries to look up the value or infer it from the knowledge base. It asks you for the value only if this process fails. ASKFIRST tells the system to ask you for the value first. Some ASKFIRST concepts at the beginning of a program save time because they give the knowledge base some facts to process. ASKNOT is usually used for concepts that are conclusions the system must reach. CALC and STORE are opposites: CALC asks that Acquaint calculate a defined formula each time it is requested; STORE asks that it be calculated once and then stored so all subsequent requests will return the same value.

Writing the Rules

Once you have declared the concepts and constants, you can begin writing rules. DefRule uses a format similar to DefConcept's:

```
(DefRule rule name
  IF
  PROP option
  premise
  THEN conclusion
  ELSE conclusion)
```

continued

Ernest R. Tello is director of research and development for Integral Systems (1518 West Cliff Dr., Santa Cruz, CA 95060). He has an M.S. from Rensselaer Polytechnic Institute.

Listing 1: The LISP-like frame template that Acquaint uses to declare concepts.

```
(DefConcept concept name
  PROMPT: question
  FACT: description of the fact
  COMMENT: further explanation
  EXPECT: type of answer
  DO: calculations to be made
  VAL: value to assign as constant
  FUN: LISP function definition
  CLASS: place of concept in hierarchy
  FORMAT: subset of Common LISP formatting
  DEFAULT: default value of concept
  PROP: properties of the concept)
```

In Acquaint, an entire rule must be of a logical type defined by one of the logical operators. The type of logical operator tells the system how to combine the premises and their certainty factors. The options you can use with PROP include the familiar logic operators, \$AND, \$OR, \$NOT, \$NAND, and \$NOR, and two others, \$OR* and \$AND*, which let you declare collection rules.

Ordinarily, the evaluation of a rule ceases once the system knows whether it is valid or invalid. For example, with an \$OR rule, if the first premise is true, you don't need to check the rest. Similarly, if the first premise of an \$AND rule is false, you don't need to evaluate the rest. However, if you want to find out as much as you can as soon as possible, you may want to use collection rules. The \$OR* rule always seeks the values of all its premises, even after finding one or more to be true. Similarly, the \$AND* rule evaluates all premises even after one is found to be false.

A Tree Structure

The context, Acquaint's knowledge structure, differentiates it from many of the other expert-system shells currently available. The context determines how to group sets of rules together for processing. It is a kind of "metarule" because it tells the system which rules to consider. However, the context itself also has conditions that must be processed before Acquaint can transfer control to another context. To define a context, you use the following format:

```
(DefCont name
  IN: name, name
  COMMENT: text
  PROP: properties
  IF: if clause
  DO: do clause
  FORM: forms)
```

The IN slot is where you declare the context's dependencies on other contexts.

Only one context, the one occupying the root node of the hierarchy, has no IN slot. Subcontexts must all mention either the root context or one of its child nodes in their IN slots. The result is a hierarchical tree structure of rule sets, each defined by a context.

Contexts can have properties specified in a PROP slot. Each member of a concept group with the same name as that context will inherit those properties. For example, if the PROP slot of the INVESTIGATE context specifies ASKNOT, and a concept group called INVESTIGATE also exists, then all concepts in the concept group also inherit the ASKNOT property.

The IF slot follows the same syntax that it does with rules; it allows the context to act as a "super rule," or group rule. If the rules in a set contain one or more common premises, you can write these rules with only the premises unique to each; the IF slot will contain the common premises of the context that groups them together.

The DO slot also follows the same syntax that it does with rules. In addition, it can contain the \$FLUSH option, which sets the value of a class of concepts to zero so that Acquaint will not pursue them, or it can contain the \$DO-CONT option, which lets you declare the sequence of contexts you want the system to consider. This sequence must end with the END context, or processing will not terminate.

Rapid Input

Forms are input templates on which you enter information directly into Acquaint rather than in response to questions. Forms are relatively easy to declare in a knowledge base, but you must be careful to reserve the fields properly. You declare them in the following way:

```
(DefForm var-1
  var-2
  ...
  var-n)
```

You list the variables in the order you want them to appear on the input form. If a form is attached to a context in the context declaration, then the form automatically comes up when that context fires, or executes. If no form is attached to the context, you can call it up voluntarily via the INPUT option on the QAINTE user environment's DIALOG menu. If you plan to use unattached forms, however, the user needs to know that the form is available, as well as how, when, and why to use it. You also need to create special instructions to explain the unattached forms available, or the user may miss them entirely.

Acquaint combines the best features of the consultation and the mathematical problem-solver paradigms with the input forms facility. You can get a complete consultation environment with as much instruction and help information as you wish, but you can still use a template form to supply your input rapidly when you need to.

How Acquaint Reasons

Acquaint is one of the first IBM PC-based systems to offer both contextual rule sets and forward and backward chaining. Contextual rule sets can partition an expert system's knowledge into distinct sets of rules so that, at any given time, the system needs to search only a limited set of rules rather than all of them. Contextual rule sets can make an enormous difference in the performance efficiency of a large knowledge-system application.

Acquaint combines both forward and backward chaining with an inference-control algorithm. This algorithm is one of the most important criteria that distinguish one expert-system shell from another. An inference engine controls how reasoning begins, how it proceeds, and how it concludes. Generally, Acquaint's inference engine combines both backward and forward chaining in a consultation, but you can control the degree to which a system forward-chains.

In Acquaint, you can determine a session's beginning point in two ways: with forms and formulas or with collection rules. If you use forms to input information, the system will usually activate forward chaining. This works properly only if no collection rules exist in the knowledge base. Generally, if they do exist, they are supplied as the first rules in the system and reference many other rule groups. The evaluation of a collection rule is not finished until all the rule groups that it calls have been processed. Therefore, if you wish, you can temporarily bypass any forward chaining and

continued

QSP SUPER MICRO 286 AT™



- Runs all major software including Novell Network, Microsoft Word, Lotus 1-2-3, Dbase III plus, Flight Simulator, Auto cad, Microport Unix C etc.
- Norton Utility rating at 9.2
- 1 Year limited warranty
- Extended warranty available
- Quantity discounts available

- ZERO WAIT STATE
- 1 MB high speed (120NS) DRam on board
- 6/8 MHz (10 MHz opt.)
- Licensed Phoenix BIOS
- Built-in 2 serials & 1 parallel port
- Reset button & turbo mode LED
- Hold up to 5 1/2ht drives
- Clock/calendar w/battery backup & rechargeable AA battery set mounted
- 200 Watt power supply
- Setup software
- Hard cover User's Manual

***** ALL FOLLOWING MODELS WITH AN IBM™ COMPATIBLE ENHANCED KEYBOARD *****
 ** OTHER CONFIGURATION CALL FOR PRICES.

MODEL 1	\$1345.00	MODEL 2	\$1449.00	MODEL 3	\$1944.00	MODEL 4	\$2049.00
Above configuration + - 1.2 MB floppy drive - WD H/F disk controller		MODEL 1 + - Hercules compatible - monographic w/printer port - Mono monitor		MODEL 1 + - EGA card (16 colors, 640 x 350 Res.) - EGA monitor		MODEL 2 + - Seagate 30MB high speed hard disk (39MS)	

QSP EGA CARD \$199

- On Board 256K display memory
- Compatible with IBM EGA, CGA, MDA
- 16 Colors. 640 x 350 res.
- Runs all software supporting IBM EGA card



EGA MONITOR \$420
 BUY BOTH FOR ONLY \$599

QSP TURBO XT™ \$389

- 4.77/8 MHz KB switchable
- 256K on board expandable to 640K
- 360K Floppy drive and controller
- 150 Watt power supply
- Slide in case and AT style keyboard
- Legal ERSO BIOS
- Runs all major software



PLEASE CALL FOR PRICES
 ON OTHER CONFIGURATIONS

MODEMS: - Hayes compatible

- Internal 300/1200 BAUD w/software. \$99
- Internal 2400 BAUD \$215
- External 300/1200 BAUD \$99



DRIVES:

- 40 MB Miniscribe (28MS) \$679
- 30MB Seagate ST 238 w/controller \$455
- 20MB Seagate full ht for AT \$495
- 30MB Seagate full ht for AT \$615
- 40MB Seagate full ht for AT \$679
- 20MB Seagate 1/2ht w/controller \$355
- 360K floppy drive \$79
- 1.2 MB Teac floppy drive \$125
- 20MB cassette back up \$550
- 60MB streaming tape back up \$725

MONITORS:

- NEC MULTISYN CALL \$389
- Casper 12" mono w/wivel base \$89
- Tatung 12" mono (IBM quality) \$99
- RGB color monitor \$285

SPECIALS:

- Mini I/O for XT/AT \$59
- Floppy Controller 2/4 dr. \$29/34
- 150 watt power supply 110/220v \$49
- 200 watt power supply 110/220v \$95
- XT slide-in case w/speaker \$38
- AT slide-in case \$85
- PC DOS 3.2 \$80
- MS DOS 3.2 + GW BASIC \$80
- MS DOS 3.1/GW BASIC \$45/\$30
- Monographic card w/printer port \$55
- Memory Expansion card (to 576K) WOK \$129
- Logimouse w/software \$89

NEW PRODUCTS!!

SPEEDCARD 286

Change Your PC/XT to an AT™!

\$299

- 80286/8088 Microprocessor switch selectable (80287 opt.)
- 8K cache memory • Half size
- 7.5 times faster than PC/XT
- 8 MHz clock speed



SUNTEK MONOPAK XT/AT™ \$105



- Hercules compatible
- Monographics + mini I/O all in one slot
- SUNTEK 3MB DOALL MULTIFUNCTION CARD FOR AT/XT \$210
- Lotus/Intel/Microsoft EMS
- Parallel, Serial, Game Ports
- Clock Calendar (XT)

386 AT™ MONO SYSTEM

- Intel 32-bit 80386 CPU, 16 MHz clock speed
- 512K interleaved 32-bit RAM on board
- Intel 2MB memory expansion card
- 8 expansion slots
- Built-in 1 parallel, 1 serial port
- Socket for 80387
- 220 watt power supply
- 1.2 MB FDD and HD/FD controller
- 30MB hard disk
- Monographic card w/printer port
- 101 key enhanced keyboard
- Amber monitor

\$4750

SUNTEK MEMOPLUS XT/AT™

WITH 0K \$99/109

WITH 2MB \$289/299



- 2MB (120NS 256K DRam) Lotus/Intel/Microsoft EMS
- Compatible w/3.2 version
- Software includes EMS driver, RDISK, Spool utilities



SALES (408) 435-8222

Technical Support (408) 435-7483, 780 Montague Expy., Ste. 207 San Jose, CA 95131

No Surcharge for MasterCard or VISA. Fulltime 1099 Purchase Order Welcome. Dealer and Corporate Inquiries Welcome. IBM, Intel, Teac and Hercules are registered trademarks of their respective companies. PC AT, PC XT and 80286 are trademarks of Intel Corporation.

OFFICE HOURS:

M-F - 8:00-5:00 PM

SAT - 9:00-5:00 PM

3/2 DATA SWITCH

\$110⁰⁰

CONTROLS DATA FLOW BETWEEN PRINTERS & PCs

Via West's new 3/2 Data Switches put you in control without the bother of recabling. At the touch of a button you can direct data among three PCs and two printers, or three printers and two PCs.

Over 22 other Data Switches available to direct data between computers, printers, modems, plotters, terminals and networks for all types of computer systems. We also offer a full line of cables and connectors. Custom orders are welcomed.

All orders shipped freight collect. Add \$4/Unit for post-paid delivery. Checks, Visa, MasterCard accepted. Arizona residents add 7% tax. Dealer inquiries invited.

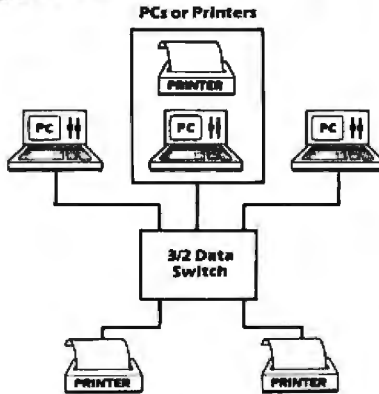

make the system evaluate all the specified rules.

If you don't use forms to enter information at the start of a session, the reasoning process in Acquaint will begin with backward chaining by default, because forward chaining needs facts to work on, and the system may not have any yet. The backward chainer is usually initiated by an ASKNOT rule or an ASKFIRST rule. First, it takes the conclusion of a rule as a hypothesis to be proven; then it chains to the premises of the rule, to other rules that can prove the premises, and so on, until it proves the rule. During this process, Acquaint may ask you for facts it will use to try to prove rules when it begins forward-chaining. The forward chainer itself doesn't ask you any questions; it uses only internal means to prove as much as it can by all the facts it has. When it exhausts all its possibilities, it returns control to the backward chainer to examine a new hypothesis.

Unprocessed hypotheses are selected from the AGENDA, the list of rules, in order of their importance. To determine this order, or priority, Acquaint uses an evaluation function that estimates the probability that a given rule will have a positive outcome. The criteria used in making this estimate are the number of premises of a rule that are known, the degree of certainty by which the premises are known, and the amount of evidence that is still missing.

QAIN: For Users

On the main menu, START begins executing the knowledge system that is loaded. EXPLAIN, DIALOG, and INFO are the three major modes of the user-interface program: EXPLAIN interprets questions, rules, and conclusions; DIALOG conducts consultation sessions; and INFO lets you BROWSE through various parts of the knowledge system.

On the EXPLAIN menu, the WHY option lets you ask Acquaint why it asked a particular question. The system responds with the reasoning chain that led to the question, which you can then BROWSE through if you wish. When the system has reached a conclusion, you can use the HOW option to see the reasoning involved. (You can also use it following the INFO option on the main menu.) If Acquaint reaches a conclusion by a series of rules, it will display the names of those rules in the BROWSE menu, and you can select them for display one at a time. The TRACE option lets you inspect all the rules in a given context or all available rules; you can select them in the same way from the BROWSE menu. The AGENDA option lets you see the list of rules Acquaint cur-

continued

The Real World Runs on Real Time.

Modern intelligent systems require real time response and high efficiency. That's why OS-9/68000 has been the designer's choice in thousands of the most demanding real-life applications.

OS-9 is very compact, highly adaptable, and fully ROMable. It's C source code compatible with Unix, and it's supported by a wide range of outstanding software tools, including graphics and networking options.

Many leading suppliers of 68000 and 68020 based systems offer ready-to-run OS-9 packages for their products. Or you can use a Microware PortPak to install OS-9 on your own custom hardware.

When microseconds count, you can count on OS-9.

OS-9/68000™—The Emerging Standard.

microware

Microware Systems Corporation
1866 N.W. 114th Street • Des Moines, Iowa 50322
Phone 515-224-1929 • Telex 910-520-2535

FORTRAN PROGRAMMERS

LCS ANNOUNCES F77L LAHEY FORTRAN VERSION 2.20
WE JUST MADE OUR TOP RATED FORTRAN LANGUAGE SYSTEM BETTER.

"Lahey's F77L FORTRAN is the compiler of choice. It's definitely a 'Programmer's FORTRAN,' with features to aid both the casual and the professional programmer . . . F77L compiled the five files in a total of 12 minutes, which was 4 times as fast as MS FORTRAN and an astounding 6 times as fast as Pro FORTRAN..."

—Editor's Choice PC Magazine

HERE ARE JUST A FEW OF THE REASONS WHY F77L IS THE COMPILER OF CHOICE:

- Full Implementation of the ANSI 77 Standard
- Clear and Precise English Diagnostics
- Fast Compilation—outruns everything on the market
- Long Variable Names—Up to 31 Characters
- Powerful Multi-Featured Source On-Line Debugger
- COMPLEX*16, LOGICAL*1 and INTEGER*2
- Popular Extensions for easy porting of mainframe and mini computer programs (Including NAMELIST)
- IEEE Standard Floating Point
- Recursion—allocates local variables on the stack
- Compatibility with popular third party software
- Arrays and COMMONS greater than 64K
- Unmatched Technical Support with an on-line bulletin board

NEW FEATURES WITH VERSION 2.20:

- Cross reference and source listings
- Allocation maps of COMMON variables and arrays
- In-line comments
- IMPLICIT NONE compiler option
- Faster Execution
- Source On-Line Debugger (SOLD) includes:
Trace Execution; No Relinking required;
On-screen Listing; No effect on code size

Call about our New F77L development tools:
Lahey Profiler Mathematical Functions Library Overlay Linker



It is more than just features that make F77L an outstanding product; it is the years of experience behind the software. At Lahey Computer Systems, we have been developing FORTRAN compilers since 1967 and we are committed to keeping F77L the industry leader.

When *PC Magazine* selected our version 1.35 as the Editor's Choice among PC FORTRANs, we were pleased but not completely satisfied—we knew we could improve the product. F77L Version 2.20 increases our lead over the competition. F77L's precise diagnostics, advanced debug package, helpful user screens and comprehensive manual make it a complete and easy to use high productivity tool.

When evaluating any software package, an important factor to consider is the value of your time. F77L saves you time and

money the moment you start using it. Our FORTRAN Language System has the key features you need to increase productivity and get the job done. Other PC FORTRANs may be cheaper than F77L, but none are less expensive to use.

F77L—THE PROGRAMMER'S FORTRAN

Price: \$477.00

System Requirements: MS-DOS or PC-DOS (2.0 or greater),
256K math coprocessor (8087-80287)

TO ORDER OR FOR MORE INFORMATION:
702-831-2500



Lahey Computer Systems, Inc.
P.O. Box 6091, Incline Village, NV 89450
Telex: 9102401256

International Representatives:

Canada: Barry Mooney & Assoc., Tel. (902)6652941 • England: Grey Matter Ltd, Tel. (0364)53499 • Switzerland: DST Comp. Services, Tel. (022)989188
Denmark: Ravenholm Computing, Tel. (02)887249 • Australia: Comp. Transitions, Tel. (03)5372786 • Japan: Microsoft Inc., Tel. (03)8138222

MS-DOS & MS FORTRAN are trademarks of Microsoft Corporation. Pro FORTRAN refers to IBM PC Professional FORTRAN by Ryan McFarland

PROM/PAL PROGRAMMING?

From \$250.00

Finding a Low-Cost PROM or PAL* programmer is only half of the battle. Finding a company that won't desert you when you need support or service is the other half.

Logical Devices Products cost you less because we offer the best price performance ratio in the market, and because once you buy our products you will experience less down time and more reliable operation than most other units. In addition you get features that were evolved from our years of experience of serving people who program chips.

We offer a wide range of products from dedicated programmers to universal software driven models.



GANGPRO-8 production programmer. 8 EPROMs to 27512 with RS-232 option.

PROMPRO-8X universal portable. RS-232. Programs PROMs/PAL*s/Micros

PALPRO-2X Low Cost PAL* only programmer. Dedicated, RS-232 unit.

SHOOTER Low cost EPROM only programmer. RS-232, Stand-Alone.

PC-PRO IBM PC plug-in EPROM card 2716-27512

ALLPRO pin driven software based universal unit, programs every imaginable fuse programmable IC.

CAST boolean software/silicon compiler for PLDs. JEDEC output

UV ERASERS FROM \$49.95

All products carry 90 day Warranty & 14 day Money Back Guarantee

**CALL 1-800-331-7766
LOGICAL DEVICES INC.**

USA 305-974-0967
ENGLAND 44 272 277323
FRANCE 39.54.91.13

*PAL IS A REGISTERED TRADEMARK OF MONOLITHIC MEMORIES INC.

APPLICATION REVIEWS

Acquaint 2.4F

Type

Frame-based knowledge-development system and expert-system tool

Company

Lithp Systems BV
P.O. Box 65
1120 AB
Landsmmeer
The Netherlands
011-31-2908-4623

Format

Two 5¼-inch floppy disks

Computer

IBM PC, XT, AT, or compatible with a minimum of 256K bytes of RAM running MS-DOS 2.0 or higher with one floppy disk drive

Language

muLISP

Documentation

Acquaint User's Manual

Price

\$4000

rently intends to try, in the order of their estimated importance. The QUESTIONS option shows the recorded results of all questions asked of the user so far, and the QUIT option returns you to the main menu.

The BROWSE window shows all the INFO items you can select. Most are self-explanatory. The INFO RULES option asks you for a search pattern. You can press Return if you want to see a list of all the rules in the BROWSE window. A similar approach is used for concepts and contexts. If at any point during a consultation you decide you want to see what is currently known, you can select the INFO CONCEPT option and look at a given concept or concept group to see what the system knows about it. If you select INFO CONCEPT, QAINTE provides you with a list of all the concepts from which you can choose.

KAINTE: For Developers

The application-development environment consists of the KAINTE.EXE program and an additional utility program, COMTOEXE, which converts .COM files to .EXE files. The menu of options is located in the upper right corner of the

screen, as it is in QAINTE. KAINTE's RE-STORE option lets you compile the expert system from a text file into LISP code that QAINTE can execute. The DUMP option writes an expert system to disk after you have compiled it, and the ERASE option initializes the KAINTE program so that you can load another knowledge system. INFO enters the BROWSE facility to inspect various elements in the knowledge base. Acquaint also includes a text editor, QEDIT.EXE, to create the knowledge-base file.

Acquaint has an interface to muLISP that lets you use the language's standard functions and call them from within rules. For example, DefConcept RES-MAN DO: ((BAND1 + BAND2) * EXPT (BAND3 10)] is a line from an Acquaint application that lets you enter the color bands of a resistor and find out its resistance and tolerance.

EXPT is a muLISP function that calculates an exponential expression, in this case, BAND3¹⁰. Such functions significantly expand the capabilities of Acquaint. Writing the functions that take advantage of this interface is not necessarily a trivial task, however; you will need to use the documentation for both muLISP and Acquaint internals.

What Acquaint Won't Do

Earlier versions of Acquaint were unable to create iterative loops based on user input. Some expert systems need this ability so the user can fill in information in a list of indefinite size. For example, let's say you are building a knowledge system to advise a company's managers about their organization. You, as the knowledge engineer, may have no idea how many departments there are or how many people are in each department, but you want to ask the same set of questions of each department.

In a list-processing language like LISP, with each iteration of the list of questions you can append the answers to another list of indefinite size. With version 2.4F of Acquaint, you can use the interface to muLISP to write these kinds of functions, but it may not be easy. In particular, you will need to know Acquaint's windowing environment so you can ask the user questions and receive answers. Otherwise, your functions won't know how to print their questions on the screen.

Multiple-choice questions are also limited. You can ask the kind in which the response is the reentry of the full item listed, but Acquaint doesn't support answering with the number of your choice, at least not as a built-in feature. I would like to see concepts that have lists as

continued

Who says you need hardware to speed up your PC?

Personal computers, like automobiles and yachts, are much more rewarding when they're operating at high speed.

And, as with cars and boats, there's more than one way to get your PC moving.

You can, for example, buy an expensive piece of hardware with "turbo" or "accelerator" in its name.

Or you can buy an affordable piece of software with "Norton" in its name.

Because the same Peter Norton who brought you the indispensable Norton Utilities™ now brings you the Norton Commander.™

And what is the Norton Commander?

It's a power user's PC control program that lets you cruise through your data with the greatest of ease.

While taking the hard work out of working with a hard disk.

Directory assistance. With the Norton Commander at your command, you can see your way through a sea of data faster than you can say "point and shoot."

A compact pair of pop-up directory windows put your files—and a fleet of file management functions—at your fingertips.

THE NORTON COMMANDER



THE QUICK AND EASY HARD DISK MANAGER.
LETS YOU TAKE CHARGE OF YOUR COMPUTER.



Point and shoot operation. Quick disk navigation. Menu control. Instant data

execution. A control program for power-users from Peter Norton.

For the IBM® PC and compatibles.

TOPS IN ITS CLASS.
PROMISES A NEW LEVEL
OF CONVENIENCE FOR
MS-DOS USERS!
Infoworld

nudge of a mouse.
Automatic pilot.

Running your programs is a breeze. Especially when you take advantage of our custom user menus.

Or, if you want to take a convenient shortcut, just point to your data and fire away.

The Norton Commander will find and run the **matching** program. **Automatically.**

How much memory does it take to work all of these wonders?

As little as 10K.

So it's no wonder the *Infoworld* Review Board found the Norton Commander so memorable.

"Tops in its class," they said. "Loaded with useful features" that provide "a new level of convenience for MS/DOS users."

"The more we used it, the more we liked it."

You will, too.

Unless, of course, you'd rather not operate in the fast lane.

Peter Norton

COMPUTING

You can list your files any way you like them—by name, extension, size or date.

You can scroll through them or page through them.

Or use the special speed-search command to find them even faster.

You can also inspect, edit, move, rename, delete, copy and whip your files into shape—at the stroke of a key or the

values as a built-in feature. I would also like to see concept functions include list-processing functions to manipulate these lists in various ways, based on user inputs.

An Effective Tool

Acquaint's frame-based knowledge-development system has a simple hierarchical class structure that allows multiple but limited property inheritance by subclasses. One unique characteristic is its forms feature, which allows experienced

users of expert-system applications to enter all their answers on a template at one time, rather than when the system asks for them.

Acquaint is one of the first IBM PC expert-system tools to use a frame-based approach to knowledge processing, allowing it to partition the knowledge base into structured rule sets that constitute distinct search spaces. Since you can keep the search within the bounds that are set by context frames, you can develop potentially huge, structured knowledge

systems without suffering from increasing inefficiencies.

Acquaint's three most attractive qualities are that it has surprisingly good speed performance for an interpreted LISP application (a subjective but not uneducated point of view); it can build large, efficient, partitioned knowledge bases; and you can configure each expert-system application with its own dedicated run-time package so the application's users don't have to pay a license fee to Lithp Systems for Acquaint. ■

Zoomracks II

Tyler Sperry

Zoomracks from Quickview Systems is a text-database manager distinguished by a unique visual interface. Unlike traditional database programs with numeric capabilities, Zoomracks is designed to organize character-based records of variable length, such as correspondence or research notes. Though basically a note organizer, the program can also handle related tasks, like simple word processing and calculations.

The program is currently available in two versions, Zoomracks I (\$79.95) and Zoomracks II (\$119.95). Zoomracks I lacks two capabilities of Zoomracks II: the ability to handle more than one printing format and the ability to save macros in disk files. Both versions of the program are available for the Atari ST series and the IBM PC and compatibles. I reviewed Zoomracks II on an Atari 520ST equipped with 512K bytes of RAM, two floppy disk drives, a color monitor, and a mouse. The package will run on a 520ST or 1040ST with a minimum of 512K bytes of RAM and a single floppy disk drive, and you can use it without a mouse.

The Zoomracks View

The feature that most clearly distinguishes Zoomracks from similar programs is its user interface. The program was designed by Paul Heckel, author of *The Elements of Friendly Software Design* (Warner Books, 1984), and Zoomracks reflects his concerns about a friendly interface.

Zoomracks' file-handling interface uses the metaphor of time cards in a vertical rack. Cards stored this way typically reveal the top line of information on each card, which permits quick visual searches. The time-card metaphor is

faithfully implemented in Zoomracks: Each database file is displayed as a rack of cards, with each card, or record, displaying the line of text contained in the first field of that record. This display lets you quickly scan a screen's worth of cards in a glance.

While not traditional, the Zoomracks display is easy to use in organizing material. Cards can contain up to 27 fields, and each field can hold up to 250 lines of text, with up to 80 characters per line. By displaying just the first line of information in a card, you can hide information in a manner similar to an outline processor.

Zoomracks lets you open and display up to nine files at once (assuming you have sufficient memory to hold them all). Normally, you wouldn't expect to view more than one or two files at a time, since a normal screen is only 80 characters wide. This is where a Zoomracks feature called SmartZooms comes in handy: By displaying text in a compressed mode (i.e., with some vowels and other characters deleted), it's possible to display several files at the same time.

Using the cursor keys or a mouse, you can quickly select and display individual cards or move between different files. Options are shown by a series of menus displayed at the bottom of the screen. To access the menus and submenus, you can use the mouse, Alt-key commands, or single-key commands. Once you've selected a menu, you use single-key commands to choose options. Virtually every menu uses the same key for entry and exit. Pressing the *Q* key once, for example, takes you to the menu for quitting the program; pressing *Q* again takes you out of the menu. An accidental keystroke merely toggles you in and out of a menu. The most common actions, like changing

the view of a card, are also available via function keys.

Despite the metaphor of time cards, the menus, and the mouse, Zoomracks' interface is not for everyone. It generates a rather quick polarity response: Some people take to it immediately, while others find it awkward to manipulate. Beginners will find the menu system reassuring and simple to use, but more experienced users who want to bypass the menus may find the command-structure shifts between function-key and Alt-key combinations cumbersome. Also, when you enter the program's editor, the traditional WordStar Control-key assignments are available when you edit a field; you cannot use these commands, however, when viewing a field. Finally, some of the commands—Alt-E for entering the "extra" submenu, for example—are non-intuitive. The upshot is that with all these different types of commands, it can be difficult to remember which ones pertain to the part of the program in which you're currently working.

A Standard Editor

Compared to the program's interface, Zoomracks' editor is more standard. Editing a card's field is easy: You simply select the card and field you want to edit and press a function key. In the editing mode, a number of commands follow the familiar WordStar Control-key conventions. The editor supports standard functions, such as searching and paragraph formatting, as well as extras, like the ability to insert the current date and time.

The editor is supplemented by print formatting with output forms. Each file has an associated output form that contains information such as headers, footers, and how each field will be printed, such as centered or flush-left. You change output forms, which consist of a series of formatting commands and field names, with the editor.

The combination of text editor and output forms is quite effective for applica-

continued

How to process documents instead of words.



Ho hum, your word processor enables you to process words. But today, when you're creating long, complex documents, you often have to process much more. Graphics, equations, columns, tables, etc.

Lotus Manuscript™ is a complete document creation system that can handle documents from 1 to 800 pages. Manuscript can mix text and graphics on the same page, graphics from Lotus® 1-2-3®, Symphony® and Freelance® Plus. It can also import spreadsheets and charts, plus diagrams and scanned images.

With our Integrated Outliner you can collapse a document to navigate the outline, or move any size section with just a few keystrokes.

You can globally format an entire Manuscript document, or format by sections.

Manuscript's Document Compare feature highlights changes between revisions for foolproof proof-reading.

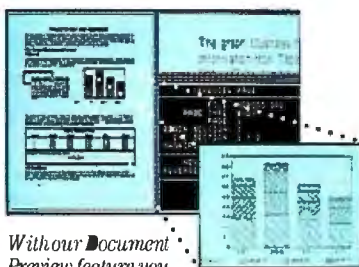

With our Document Preview feature you can see how any page will look before it's printed. Zoom capability lets you take a closer look at graphics and equations.

Also, Manuscript automatically sizes and generates math equations as well as Greek symbols, diacritical marks and brackets.

Our powerful Print Formatter gives you control over the look of your document, from position and size of graphics, to fonts, point sizes and more.

Manuscript also takes full advantage of

today's printing technology, from dot-matrix to laser, including PostScript® printers.

Manuscript is designed to work on most IBM® PCs and compatibles*. Its familiar 1-2-3 interface makes it easy to use. And our Manuscript evaluation kit makes it easy to try. For \$10.00, you'll get a presentation disk, working software, and a tutorial manual. To get your evaluation kit, call 1-800-

345-1043, ask for lot #YD-1450.

Or, for more information, see your authorized Lotus Dealer, or write Lotus Development Corp., 90 Annex, Atlanta, GA 30390-0370.



Lotus Manuscript™

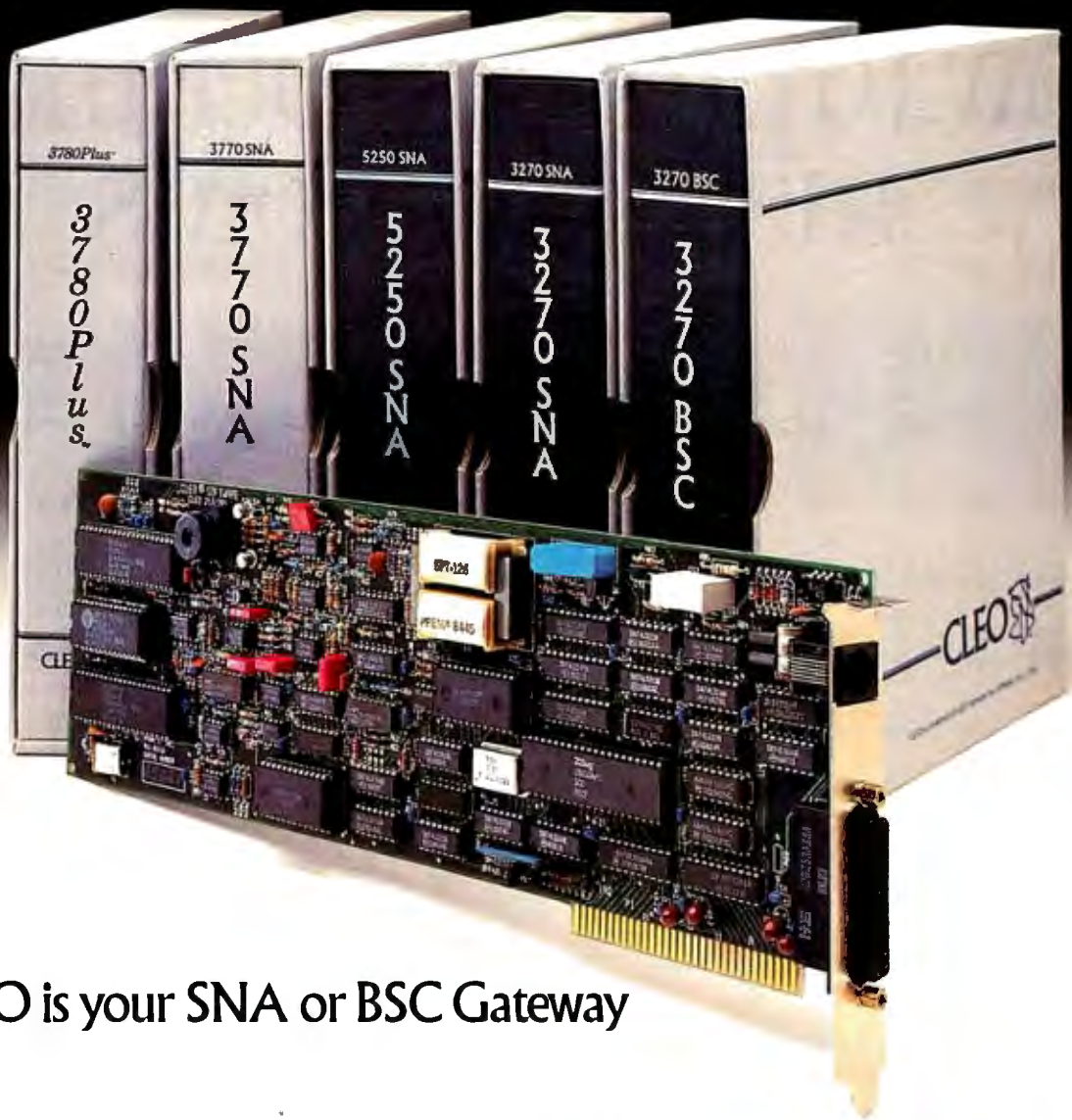

CLEO is your SNA or BSC Gateway

CLEO Software products allow microcomputers to communicate with IBM minicomputers and mainframes, and to emulate their workstations. CLEO products have been providing REMOTE communications between micros and mainframes since 1981. Over 44,000 CLEO users worldwide are running on all major brands of micro computers; the largest number of these users run CLEO software on IBM Personal Computers and NETBIOS LANs.

The qualifier REMOTE is a key factor distinguishing CLEO products from traditional emulators. All of the models contain full emulation of all the equipment at the remote site: the modem, the cluster controller, and the terminals.

Software features:

- PC/XT/AT compatible
- Stand-alone or NETBIOS LAN operation
- Supports Bisync or SDLC links
- 3780 and 3270 protocols install for operation in 19 different countries
- Application program interface
- Point-to-point or multi-drop selection
- Auto-dialing with selected modems

Call for information on how one of our 5 hardware models will solve your communication problem.

- V.26/212AT/201 internal modem (2400 baud)
- V.26/201 internal modem (2400 baud)
- V.27/208 internal modem (4800 baud)
- SNA/BSC synchronous LAN gateway
- SNA/BSC stand-alone synchronous gateway

Distributors:

Benelux, Scandinavia
31(71)899202
Canada
514-737-3631
(Western Canada)
800-361-1210
(Ontario, Quebec and
Maritimes)
800-361-3185

Colombia, S.A.
2875492
France
46 87 33 66
Germany, Austria,
Switzerland
49(2823)18408
Italy
039 636191
Mexico
596-1825

Peru, S.A.
234-464
UK
44(1)2420012
0800-898404
U.S.A.
(800) 433-CLEO
(2536)
In Michigan
(313) 540-4600

CLEO Software
1639 North Alpine Road
Rockford, IL 61107
(815) 397-8110
Telex 703639

CLEO 

tions like mailing lists and printing three-up labels. It's also adequate for simple correspondence. However, Zoomracks cannot be seriously considered as a word processor. Missing features include printer-configuration options, underlining, boldfacing, italics, and other character-formatting options.

Design Quirks

You might expect the mouse to be heavily used in Zoomracks, a product designed to be the essence of user-friendly software, but this is not the case. In Zoomracks, mouse support is limited. You can use the mouse to select cards and racks to view and select menu items, but that's about it. You can also use the mouse to scroll through a rack of cards and "zoom" a card to fill the screen, but you have to go back to the cursor keys to scroll through the contents of the card you just pulled up. The mouse is not implemented in the program's editor; according to Quickview Systems, the editor will make use of the mouse in the next version of Zoomracks, planned for release later this year.

In addition, you must be careful to position the mouse precisely when using it to examine the Zoomracks file directory; placing the mouse inaccurately when activating the directory results in the creation of empty files. Also, if you're tempted to turn off the menu at the bottom of the screen, don't do it while using the mouse. The menu is simply rendered invisible, not disabled, and attempts at selecting a card at the bottom of the screen can result in unexpected menu choices.

Another problem concerns file handling. Zoomracks' user's manual claims the program can display pictures stored in the DEGAS format. Unfortunately, Zoomracks doesn't use the Atari's GEM interface or Alert boxes to select pictures for viewing. To view a DEGAS file, you type the file's name into a blank field and press a function key.

You won't run into trouble with this procedure if you've written down the name of the file you want to view, but if you haven't jotted down the filename, you may run into problems. Since you must enter the exact filename to view the file and the Zoomracks directory displays only those files that have the .ZRX extension, you're effectively forced out of the program to find out what's on your disk. In addition to making importing files a nuisance, Zoomracks' file-handling makes folder use awkward. You can open folders only from the Atari's Desktop, not from within the program.

When I tried to load a sample DEGAS file, Zoomracks refused, claiming that displaying a high-resolution picture requires a monochrome monitor, which I

didn't have installed. However, the file that Zoomracks rejected was a medium-resolution color picture that another program was able to display without difficulty.

Speed and Memory

For small applications that you normally associate with a card-file program, Zoomracks is certainly fast enough. I performed benchmark tests using a dummy database that consisted of 1000 records, numbered 1000 through 1999 in the first field. The other three fields contained dummy text strings of 32 characters each. The result of sorting the first field from reverse order was 36.3 seconds. Searching for the last record took 7.2 seconds.

You should note that Zoomracks is designed to handle ASCII text, and sorting is limited to ascending order. Sorts performed on numeric fields will thus lead to interesting results (e.g., 1, 10, 2, 3, ...) unless you manually pad the fields with leading zeroes.

The speed of Zoomracks in the benchmarks is largely due to the program's use of RAM-based operations instead of disk accesses. Thus, while it took only 7 seconds to search through the benchmark file, it took 55 seconds to load the file from the floppy disk—the program also sorts the file when loading it.

The speed gained through the program's RAM-based operations must be weighed against the RAM requirements for your application. Zoomracks cannot handle any file or collection of files larger than the amount of available RAM.

Moreover, this brings up other memory considerations. Experienced Forth programmers accustomed to having the functions of an editor, an assembler, and a compiler in 50K bytes or so will be surprised to find that Zoomracks, written in Forth and assembly language, weighs in at 227K bytes. When you add the RAM needed for the video display, the TOS operating system, and any desk accessories you've installed, the half-megabyte of memory on an Atari 520ST suddenly seems cramped. For example, I could not load the 114K-byte benchmark file until I had stripped my boot disk of several desk accessories.

Applications requiring less than 100K bytes of file storage should pose no problems. If your database is going to exceed 100,000 characters, however, it would be wise to consider dividing the database into different files or switching to an Atari 1040ST with a full megabyte of RAM.

Macros, Math, and Manuals

Zoomracks includes a macro capability that enables you to record a sequence of

Zoomracks II

Type

Text-database manager

Company

Quickview Systems
146 Main St., Suite 404
Los Altos, CA 94022
(415) 965-0327

Format

One 3 1/2-inch floppy disk; not copy-protected

Computer

Atari 520ST or 1040ST with 512K bytes of RAM and one floppy disk drive; mouse supported, but not required

Language

Forth; assembly language

Options

\$19.95 each for Business and other Starter Kits

Documentation

200-page user's manual; function-key template; command-reference card

Price

\$119.95; Zoomracks I costs \$79.95; an upgrade from the previous release of Zoomracks (the Premier version) to Zoomracks I is \$14.95; to Zoomracks II, \$49.95; versions are also available for the IBM PC and compatibles for \$119.95.

commands and link it to a single key. To replay the commands, you press a function key and then the assigned key. This capability goes a long way toward easing some of the awkwardness of the user interface. Instead of moving through a maze of menus to create and date-stamp a blank form, for example, you can assign the whole procedure to a single macro. You are limited, however, to 27 macros.

Zoomracks also includes some mathematical capabilities, which are limited to the basic arithmetic functions. These functions are certainly adequate to handle everyday applications like invoices and such, but not for complex number crunching. The program cannot, for example, automatically sum columns, although you can program a macro to perform this function.

The Zoomracks user's manual is tutorial in nature, generally well written, and indexed. The package also includes a

continued

OUR PLUG-IN CARDS GIVE YOU PLUG-IN CONTROL.

Your IBM PC/XT/AT or compatible can control any IEEE-488 instrument.



You can:

- Plug-in to BASIC, C, FORTRAN, or Pascal.
- Use HP-IB plotters, printers, and instruments.
- Spend less time programming.
- Call (617) 273-1818 and put us to the test.

Complete hardware and software solutions for just \$395.



Capital Equipment Corp.
99 South Bedford Street
Burlington, MA. 01803

How to tackle a 300 page monster.

Turn your PC into a typesetter.

If you're writing a long, serious document on your IBM PC, you want it to look professional. You want MicroT_EX. Designed especially for desktop publishers who require heavy duty typesetting, MicroT_EX is based on the T_EX standard, with tens of thousands of users worldwide. It easily handles documents from smaller than 30 pages to 5000 pages or more. No other PC typesetting software gives you as many advanced capabilities as MicroT_EX.

So if you want typesetting software that's as serious as you are about your writing, get MicroT_EX. **Call us at 617-944-6795** to order or for more information.* Order with a 60-day money back guarantee.

MicroT_EX™ from Addison-Wesley

Serious typesetting for serious desktop publishers.
*Dealers, call our Dealer Hot Line: 800-447-2226
(In MA, 800-446-3399), ext. 2643.

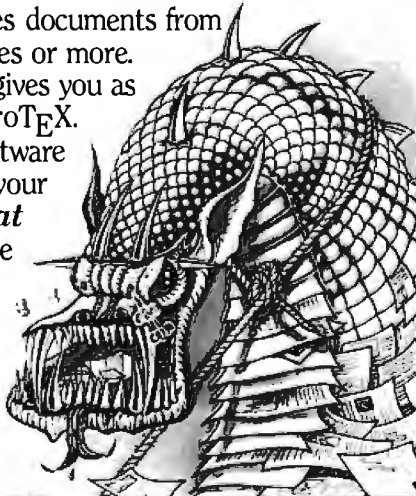

Zoomracks is fast enough for small applications because of its RAM-based operations. But you'll have to weigh its speed against its memory requirements.

function-key template, a double-sided command-reference card, and an on-line help file, but no reference manual.

Quickview Systems provides good user support, especially considering that it's a small company. There is no toll-free number for assistance, and it might take a couple of hours to get a return call if no one is immediately available. The chances are excellent, however, that when you talk with people at the company, they will be knowledgeable and helpful.

As additional support, Quickview Systems sells Starter Kits for Zoomracks. These kits, which sell for \$19.95, contain a set of templates and macros for various applications. The Business Starter Kit, for example, contains templates for invoicing, phone logs, and so on. Sales, mailing list, accounting, and other kits are also available.

Best for Simple Filing

The final judgment on Zoomracks will depend on your planned application. If you're intrigued by the card-rack metaphor and have modest database requirements, Zoomracks is certainly worth investigating. There are some nonintuitive commands and bugs in the current version of the program, but, despite all that, it still gives you a useful tool for organizing and manipulating text data.

For demanding applications, however, none of the program's functions—text editing, database handling, and calculating—are sufficiently strong to compete head-to-head with a dedicated application program. Few word-processing programs, for example, are unable to handle simple underlining. As a working writer, I'd consider Zoomracks worthwhile for notes and simple correspondence only. For larger projects, such as this review, I'm quite happy to stick with my IBM PC compatible and a standard word processor. ■

Tyler Sperry (P.O. Box 7189, Redwood City, CA 94063) is a freelance author.

HARDCORE SOFTWARE

Stop fooling around. It's time to get hardcore about software. With Microsoft.

We'll give you all the resources you want. Tens of millions in R&D funding. Along with one of the most elementary tools for thinking—a door, which leads to your own private office. All backed by management that truly *does* speak your language, because they probably helped write it.

We're serious about software design. If you are, too, then apply right now for one of these opportunities.

Software Design Engineers

We're working on everything from compilers, operating systems, and networking to sophisticated graphics, powerful productivity software and more. You could be, too, if you have programming experience and a background that includes micro's, "C", 8086, UNIX*/XENIX®, or MS-DOS®.

There are opportunities to work with our teams in systems, applications, or languages.

If you qualify, Microsoft offers you an opportunity to live and work where the quality of life is high and the cost of living is low—the beautiful Pacific Northwest. Along with amenities such as a health club membership, workout facilities and parcourse, plus an array of benefits.

To apply, please send your résumé in confidence to:

Human Resources, Dept. HC/SW-0687BYTE,
MICROSOFT CORPORATION, 16011 N.E.

36th Way, P.O. Box 97017, Redmond,

WA 98073-9717. We are an equal
opportunity employer. And no phone
calls, please. If we like what we see,
we'll call you.



MICROSOFT®

©1987, Microsoft Corporation

*UNIX is a trademark of AT&T Bell Laboratories.

XENIX and MS-DOS are trademarks of Microsoft Corporation.

COMPUTER WAREHOUSE

CALL TOLL FREE **1-800-528-1054**

FREE FEDERAL EXPRESS

Air Express Shipping

See Details Below

NOW

BEST PRICES

No Charge for Bank Cards

HARDWARE

PRINTERS

Alps All Models	Call
Brother All Models	Call
Citizen MSP-10	\$269
MSP-15	\$359
MSP-20	\$309
MSP-25	\$459
Premier35	\$445
120 D	\$169
Diablo D-25	\$469
635	\$759
Diconix 150	\$299

EPSON

All Printer Models	Call
Hewlett-Packard LaserJet II	\$1829
NEC	
3510, 3550	\$729
8810, 8850	\$1059
P6	\$429
P7	\$619
P9	\$1129

OKIDATA

All Printer Models	Call
Panasonic 1080 I	\$189
1091 I	\$245
1092 I	\$319
1582	\$385
1585	\$465
3131	\$229
3151	\$389

STAR MICRONICS

All Printer Models	Call
Toshiba 321 SL	Call
341E Parallel	\$669
351 Model II	\$899
Laser Printer	Call

MONITORS

Amdex All Monitors	Call
NEC Multisync	\$549
Multisync Plus	Call
Multisync Graphic Board	Call
Princeton Graphics	Call
VIDEO TERMINALS	
Qume 101 Plus Green	\$315
101 Plus Amber	\$315
Wyse 30	\$285
50	\$359
75	\$565
Wyse 85	\$425

MODEMS

Anchor Automation	
Signalman Express	\$185
Practical Peripherals	
Practical 1200 Baud	\$124

HAYES

All Modems	Call
Prometheus All Models	Call
US Robotics Courier 2400	\$335
Password 1200	\$149
Microlink 2400	\$335
Ventel	Call

DISK DRIVES

Iomega Bernoulli 10 meg	\$865
Bernoulli 20 meg	\$1199
Bernoulli 40 meg	\$1729

SEAGATE

20 meg w/Western I/O	\$339
Other Models	Call

DISKETTES

Maxell MD2 (Qty 100)	\$82.50
M2S	\$60
Sony MD/2 (Qty 100)	\$80

COMPUTERS

PANASONIC

Business Partner	\$719
Sr. Partner	\$969
Exec. Partner	\$1299
Other Models	Call

TOSHIBA

T-1100 Supertwist	\$1399
T-3100	\$2799

FCC Approved



\$389

MIT SYSTEMS Turbo PC/XT

256 Memory, One 360K Brand Name Floppy Drive + 135 Watt Power Supply, Slide Case, AT Style Keyboard + 8 MHz Clock Speed, (Keyboard Selectable), 8 Expansion Slots

BOARDS

AST	
Six-Pack Plus	\$149
Other Models	Call
ATI EGA Wonder	\$245
Hercules Color Card	\$149
Graphic Card	\$179
Graphic Card +	\$185
Intel Above Board PS/PC (1110)	\$239
Above Board AT (2010)	\$315
Above Board PS/AT (2110)	\$345
Above Board PC 1010	\$210
NEC Multisync Graphic Board	Call
Orchid Tiny Turbo 286	\$399
Turbo EGA	\$449
Paradise Five Pak	\$99
Autoswitch 350	\$299
Autoswitch 480	\$355
Plus Development	
Plus Hard Card 20 Megabyte	\$609
Quadram Quad EGA+	\$295
Tec Mar Graphics Master	\$409
Captain No Memory	\$109
EGA Master	\$239
EGA Prosync	\$335
Video-7 Vega Deluxe	\$315
Vega Enhanced Graphics Adapt	\$279

COPIERS

Canon

«PC»



Canon PC-25 \$929

SOFTWARE

IBM PC and 100% Compatibles

TRAINING

Flight Simulator	\$27
PC Logo	\$69
Typing Instructor	\$27
Typing Tutor III	\$27
MS Learning DOS	\$27

LANGUAGES

C Compiler (Microsoft)	\$249
Fortran Compiler (Microsoft)	\$249
Macro Assembler (Microsoft)	\$83
Pascal Compiler (Microsoft)	\$165
Quick Basic 2	\$55
Turbo Jumbo Pack	\$159
Turbo Pascal w/8087 & BCD	\$55
Turbo Database Tool Box	\$38
Turbo Prolog	\$54

PROJECT MANAGEMENT

Harvard Total Project Manager II	\$282
Microsoft Project	\$218
Super Project Plus	\$269
Timeline 2.0	\$235

COMMUNICATIONS

CompuServe Starter Kit	\$19
Crosstalk XVI	\$88
MS Access	\$137
Mirror	\$38
Remote	\$88
Smartcom II	\$79

INTEGRATIVE SOFTWARE

Enable 2.0	\$329
Framework II	\$395
Smart Software System 3.1	\$409
Symphony	\$449
Ability	\$55

GRAPHICS

Chartmaster	Call
Diagram Master	Call
Energraphics 2.0	\$269
In-A-Vision	\$259
Microsoft Buss Mouse 6.0	\$103
Microsoft Chart	\$163
Microsoft Serial Mouse 6.0	\$115
Newsroom	\$31
PC Buss Plus Mouse	\$99
Click Art Personal Publisher	\$59
IMSI Mouse w/Dr. Halo II	\$92
PC Mouse	\$89
Printmaster	\$29
Signmaster	Call
Turbo Graphix Tool Box	\$38

WORD PROCESSORS

Leading Edge Word Processor	\$25
Leading Edge W/P w/Spell & Mail	\$59
Lightening	\$55
Microsoft Word 3.11	\$175
Multimate Advantage	\$255
Wordstar w/Tutor	\$162
Wordstar Pro Pack 4.0	\$233
PFS: Professional Write	\$89

Word Perfect (Ver.4.2) \$195
Wordstar 2000 + 2.0 \$278

SPREADSHEETS

Lotus 1-2-3	Call
Multiplan 3.0	\$108
Spreadsheet Auditor 3.0	\$82
VP Planner	\$47
Supercalc 4	\$269

MONEY MANAGEMENT

Dollars & Sense w/Forecast	\$92
Tobias Managing Your Money	\$105

UTILITIES

MS Windows	\$55
Copy II PC	\$19
1 DIR Plus	\$46
Fastback	\$84
Norton Utilities 4.0	\$48
Printworks	\$36
Sidekick (Unprotected)	\$47
Travelling Sidekick	\$39
Sideways 3.1	Call
Superkey	\$39
Xtree	\$25
SQZ	\$46

DATA BASE MANAGEMENT

Clipper	\$375
Cornerstone	\$53
dBase II	\$289
dBase III Plus	\$395
Extended Report Writer	\$149
KnowledgeMan II PromoPack	\$319
Quickcode Plus	\$138
QuickReport	\$138
Relief	\$82
DB-XL	\$82
PFS: Professional File	\$112

R-Base 5000 System V \$349

Many other titles available.

Inquiry 70 for MS DOS Products. Inquiry 71 for all others.

CWF-487

Order Line Hours: Mon-Fri 7:00 a.m.-6:00 p.m.

Saturday 9:00-1:00

Alaska Orders: Call (602) 468-1731

Order Processing: (602) 224-9345

10:00 a.m.-3:00 p.m. Mon-Fri

COMPUTER WAREHOUSE

Order Line: 1-800-528-1054
Order Processing: 602-224-9345
2222 E. Indian School Rd.
Phoenix, Arizona 85016

* No Charge for VISA and MasterCard • You Pay the Ground Shipping — We Pay the Air • Ground Shipping & Handling \$6.00 • Free Air applies ONLY to orders up to 10 lbs. & Over \$50 • All products carry a manufacturer's warranty. All Guarantees, rebates, trial period privileges & promotional programs are handled by the manufacturer only • NO APO, FPO, or international orders, please • Call before submitting PO Numbers • Personal and Company Checks Will Delay Shipping 3 weeks • Prices, Terms & Availability Subject to Change Without Notice • Add 3% for COD Orders • We Do Not Guarantee Machine Compatibility • All Sales Are Final



Kernel

**Computing at Chaos Manor:
Puttering with Yin and Yang** 281
by Jerry Pournelle

**According to Webster:
Processor Wars**..... 297
by Bruce Webster

**Focus on Algorithms:
Run-Length Encoding** 317
by Dick Pountain

**Applications Only:
AI, AI, Oh!**..... 321
by Ezra Shapiro



Microprocessor Development Dreams Come True!

On-Line Help menus,
Command Glossary,
and Word List.

Windows can be used
to view source files,
previous traces,
and more.

Symbol translation
or source code
line display.

Screen displays scroll off
into history buffer –
can be viewed later.

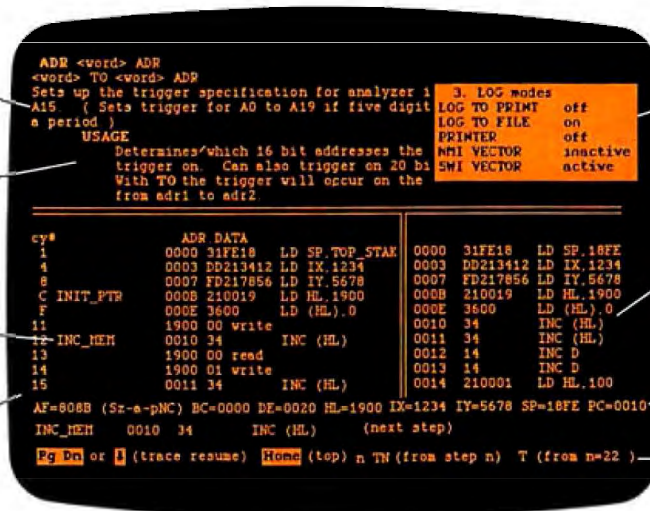

Pop-up Mode
Selection panel
called by soft key.

Disassembly of code
in memory can be
compared with trace in
adjacent window.

Symbolic debug
register display.

Context sensitive
prompt line.

NEW UniLab II™: FOUR INSTRUMENTS IN ONE!

Here are all the development tools you ever dreamed of integrated into one PC-controlled system:

- An Advanced 48-Channel Bus State Analyzer
- An 8/16-Bit Universal Emulator
- A Built-In EPROM Programmer
- An Input Stimulus Generator

The synergy of these instruments that were designed together to work together saves you time and money. All UniLab II commands and menus are seamlessly integrated into a single, super-efficient working environment.

An Integrated Software Environment, too!

Imagine being able to split your screen and look at real-time program traces and the source code that produced them at the same time! Then go to the On-Line Help or pop-up Mode Panels instantly.

If you see something on a trace that doesn't look like last time, you can hold it in one window while you scroll back through your previous displays.

If you set a breakpoint and single-step you can then go back to using the analyzer without missing a beat. You can even execute a DOS batch file from UniLab to edit, assemble, and link, then automatically load the new program and symbol table. UniLab uses the full power of the PC.

Find bugs fast with Hardware-assisted Debugging

The traditional way to look for bugs is to single-step through suspect parts of the code until you catch it in the act. This requires a lot of guessing and wasted time.

With UniLab's built-in analyzer you eliminate the guesswork. Just describe the bug symptom as a trigger, and let the UniLab hardware search

for it as your program runs in real time. UniLab will show you a trace of the program steps leading up to the symptom, almost like magic.

A friendly user interface

UniLab lets you use commands or menus – or a mixture of both. An on-line manual, soft-key help screens, a glossary of commands and their parameters, with full-screen writeups are also at the ready.

Reconfigure for any 8 or 16-bit processor in seconds

Thanks to our unique approach to emulation, changes between processor types require only cable and diskette changes. At last count, we specifically support over 120 microprocessors.

Bonus! The built-in EPROM Programmer and Stimulus Generator are simply icing on the cake.

Affordable capability

How much does all this superior capability cost? A lot less than our less able competitors, and probably a lot less than you expect. Our products are sold with a Money Back Guarantee, and our crack team of Applications Engineers is standing by if you need help. Get the full story on the amazing UniLab II and how it can liberate your development projects, today.

ACTION COUPON

Send me info on UniLab II and your No-Risk 10-Day Evaluation!

Name: _____ Title: _____
Company: _____
Address: _____
City: _____
State/ZIP: _____
Tel.: _____ Ext. _____

UniLab II™

Universal Development Laboratory



Orion Instruments, Inc.

ORION

702 Marshall Street
Redwood City, California 94063

CALL TOLL FREE: 1-800-245-8500

In California (415) 361-8883



Puttering with Yin and Yang

Jerry Pournelle

A computerized oracle advises Jerry to do some random reporting

I think they're trying to kill me: they've got me on the road more than I'm at home. I got back from the Seybold Conference on Desktop Communications with barely enough time to write last month's column, then I was off to the American Association for the Advancement of Science meeting in Chicago. After that, I managed a week with Larry Niven working on *The Moat Around Murcheson's Eye*, our sequel to *The Mote in God's Eye*; then off to Boston and the tenth anniversary meeting of the Boston Computer Society, and a drive up to BYTE headquarters in Peterborough. Back home just in time to go to Sacramento for the fourth annual meeting of Contact, the group that brings together hackers, anthropologists, and science fiction writers.

I returned Sunday night, and on Monday went to AppleWorld, where they announced the (fantastic!) Mac II and Mac SE; and Monday evening I headed to Seattle for the second annual conference on CD-ROMs.

Of course, much good will come of all this travel. Eventually I'll have a lot to report, but for now it has cut severely into my tinkering time at Chaos Manor. So: shall I try to extract some serious conclusions from the AAAS meeting and CD-ROM conference? Or just putter around, grabbing things at random, and reporting what I think?

The Oracle

There's one way to find out. I'll consult the *I Ching* on Zelda, the Zenith Z-248 AT clone.

I've written about this before, but for those who don't remember, the *I Ching* or *Book of Changes* is an ancient Chinese oracle. The Baen Software's program called Electric Dragon offers the Richard Wilhelm (Princeton University Press) translation, considered one of the best.

The *I Ching* is not a mere fortune-telling device, although it's used for divination. You can think of it as a mental exer-

cise. One Chinese writer said, "Common minds use *I Ching* to predict the future. Sages use it to understand the present." *I Ching* is supposed to explain what is happening to you and recommend what the superior person should do. Carl Jung, among other intellectuals, took it seriously, and I'm always amazed at how appropriate to the question asked the *I Ching* meditations seem to be.

You needn't believe in the *I Ching* to use it. It's better than flipping coins, because while it certainly gives answers, you have to give some thought to what the oracle tells you.

So. Let's consult it about this column.

Hexagrams

The *I Ching* consists of 64 figures called hexagrams; each has six lines. A line can be yin (yielding, or broken) or yang (firm, unbroken), and each can be fixed or moving. A line moves to become its opposite. You consult the oracle by generating a hexagram one line at a time; if you get one or more moving lines, in effect you have generated two hexagrams, since one will become the other.

Since each line has two characteristics (yin/yang, fixed/moving), we need two random but not equal probability numbers to generate each line. The classical method involves yarrow stalks. There is a simple method of tossing three coins (all heads is moving yang, two heads is fixed yang, etc.), but the Electric Dragon program has the computer generate the hexagram one line at a time and displays it on-screen with the interpretations.

I went through the procedure and got the fourth hexagram, "Youthful Folly." The interpretation is, "Youthful Folly has success. It is not I who seek the young fool; The young fool seeks me. At the

first oracle I inform him. If he asks two or three times, it is an importunity. If he importunes, I give him no information."

There were no moving lines. This hexagram doesn't invite you to repeat the question. It seems a clear enough answer to me. It's short-shrift time at Chaos Manor.

Truly Portable

One consequence of traveling about the country was lots of opportunities to test Zebediah, the Zenith Z-181 laptop portable PCompatible.

I love that machine. True, it's easier to write on the NEC PC-8201 when seated in an airplane; the Z-181 is a bit awkward to hold, at least if you're my size and crammed into a tourist-class seat. If you're shorter or in first class, it's no problem. Either way you'll be able to see the screen fine: the blue backlit screen is readable in all light conditions. Incidentally, I keep hearing about restrictions on using portable computers on airplanes, but I have yet to have any of the aircrews do more than admire the Z-181.

Once on the ground, you have a full, fast IBM PCompatible.

I took Zeb down to the AAAS newsroom to log on to BIX and send some items into Microbytes. Zeb was the hit of the newsroom: I think at least three colleagues decided to buy one.

Meanwhile, the NEC MultiSpeed arrived. This is also a fast, full PCompatible machine, lighter than the Zenith and somewhat smaller. Like the Zenith, it has two 3½-inch floppy disk drives, comes with a full 640K bytes of memory, and has provision for a 300/1200-baud internal modem. Unlike the Zenith, it has a handle. It doesn't come with a case, but it will fit nicely into the Ciao! bag I bought

continued

Jerry Pournelle holds a doctorate in psychology and is a science fiction writer who also earns a comfortable living writing about computers present and future.

Even More Power & Flexibility

BRIEF 2.0



BRIEF easily conforms to your editing preferences and style, ensuring you are truly comfortable and productive.

Straight from the box, BRIEF is as much editor as most people will ever need — thanks to features like the real Undo, flexible windowing, and unlimited file size.

But BRIEF's hidden power is in its exclusive macro language. Customize BRIEF to include the commands and features YOU desire. It's fast and easy.

Users and industry press alike unanimously praise BRIEF. "Recommended." — Jerry Pournelle, Byte 12/86.

Now BRIEF 2.0 adds:

Basic Features

- Setup Program for easy installation and configuration. (Requires no macro knowledge).
- Increased speed for sophisticated operations like Undo and Regular Expression Search.
- All new documentation WITH tutorial on the Macro Language.
 - Command line editing (move cursor, add & delete characters, specify parameters).
 - Expanded Regular Expressions, with matching over line boundaries.
 - More block types, with marking by character, line or column.
 - Reconfigurable indenting for C files (supports most indenting styles).
 - Enhanced large display support, including wider displays.
 - Optional borderless windows.

- Windows

- Multi-level Undo

- Edit many files at once.

- File size limited only by disk space.

- Automatic language sensitive indentation.

- EGA and Hercules Plus 43-line support

- Compile & find errors within BRIEF.

And much, much more!

Try BRIEF (\$195) for 30 days — if not satisfied get a full refund.

If you already own BRIEF, call for update info.

CALL 800-821-2492

In MA 617-659-1571

Solution Systems

335-B Washington St.
Norwell, MA 02061

Requires an IBM PC, AT or compatible with 192K.

for the NEC PC-8201.

The MultiSpeed comes with considerable built-in software. There's a built-in help feature activated by a special key, and also a Popup hot key that gives you many SideKick-type features, including a notebook. The Popup feature has a filer that lets you store and browse through the equivalent of 3 by 5 cards. It has an outliner, a phone dialer, and a bunch of other stuff. The whole thing is so impressive that I'm going to see if I can find similar utilities for the Z-181.

In other words, the MultiSpeed has some very fine features indeed.

The MultiSpeed also has two fatal flaws. Fatal for me, anyway.

First, I can't see the screen very well. I had to turn on the fluorescent lights at 5 p.m. on a spring day in Los Angeles. There's a contrast adjustment, but it doesn't do a lot of good for me. The MultiSpeed screen isn't as bad as the old Hewlett-Packard portable was, but it's not good either. The screen alone would be enough to make me prefer the Z-181 by a lot; I've never been anywhere that I couldn't see Zeb's backlit screen. Of course, I pay for that in battery time: the Z-181 goes three to five hours on a charge, while the MultiSpeed advertises five to seven and has two weeks' worth of nonoperational backup even if the main power fails. That's a feature I wish Zenith had built into their machines.

Second, the MultiSpeed keyboard is just plain lousy. There is the usual IBM-spawned Backslash key between the Z and the Shift key. Then there's the silly Squiggle key between the quotation marks and Return. Between them I can't type with the MultiSpeed flat on a desk, much less on my lap.

Both the MultiSpeed and the Z-181 have too many keys between Home key and Backspace, of course, and the Z-181 has that darned Squiggle where I'd want Return; but the Z-181's Return key is oversize and thus easy to find. The MultiSpeed, for no sane reason, has a narrowed Return key and an oversize]] key in the way.

Now, I may be overly sensitive to keyboard layout. I make a living writing, and I want the best tools I can get. Alas, no computer company in history (with the notable exception of TI) has ever allowed a touch-typist to be in on keyboard design. Instead, they use some genius who pecks at the keyboard with one or two fingers and couldn't care less where the keys are placed. I suppose it's just something we have to endure.

Anyway, between the semivisible screen and the wretched key layout, I find the MultiSpeed hard to use.

continued

What is a Best Western?



The right place at the right price.

Make reservations at any Best Western, see your travel agent, or call toll-free
1-800-528-1234



"World's largest chain of independently owned and operated hotels, motor inns and resorts"

THE PROGRAMMER'S SHOP

helps save time, money and cut frustrations. Compare, evaluate, and find products.

RECENT DISCOVERY

UI Programmer - Quickly generate dBASE User Interfaces, prototypes. Use supplied templates or create own. Pop-up help, bounce bar menus, screen forms. II, III, FoxBASE+, Quicksilver, Clipper. PC \$ 295

AI-Expert System Dev't

Arity Combination Package PC \$ 979
 System - use with C MS \$ 229
 SQL Dev't Package MS \$ 229
 Auto-Intelligence PC \$ 749
 Expertcach - Powerful, samples PC \$ 349
 Exsys PC \$ 309
 Runtime System PC \$ 469
 Insight 2+ MS \$ 379
 Intelligence/Compiler PC \$ 749
 Texas Instruments:
 PC Easy PC \$ 435
 Personal Consultant Plus PC \$2589
 Personal Consultant Runtime PC \$ 85
 Turbo Expert-Startup(400 rules)PC \$ 129
 Corporate (4000 rules)PC \$ 359

AI-Lisp

Microsoft MuLisp 85 MS \$ 159
 PC Scheme LISP - by TI PC \$ 85
 TransLISP - learn fast MS \$ 89
 TransLISPPLUS
 Optional Unlimited Runtime \$ 150
 PLUS for MSDOS \$ 179
 Others: IQ LISP (\$239), IQC LISP (\$269)

AI-Prolog

APT - Active Prolog Tutor - build applications interactively PC \$ 65
 ARITY Prolog - full, 4 Meg
 Interpreter - debug, C, ASM PC \$ 229
 COMPILER/Interpreter-EXE PC \$ 569
 Standard Prolog MS \$ 77
 MacProlog Complete MAC \$ 269
 MicroProlog - Prof. Entry Level MS \$ 85
 MicroProlog Prof. Comp./Interp. MS \$ 439
 MPROLOG P550 PC \$ 175
 Prolog-86 - Learn Fast MS \$ 89
 Prolog-86 Plus - Develop MS \$ 229
 TURBO PROLOG by Borland PC \$ 69

Editors for Programming

BRIEF Programmer's Editor PC Call
 EMACS by UniPress Source: \$929 \$ 299
 Epsilon - like EMACS, full
 C-like language for macros. PC \$ 149
 KEDIT - like XEDIT PC \$ 99
 Lattice Screen Editor - multiwindow, multitasking Amiga \$ 89 MS \$ 109
 Micro Focus Micro/SPF PC \$ 139
 PC/EDT - macros PC \$ 229
 PC/VI - by Custom Software MS \$ 109
 Personal REXX PC \$ 99
 PMATE - power, multitask PC \$ 119
 SPF/PC - fast, virtual memory PC \$ 139
 Vedit MS \$ 107
 Vedit PLUS MS \$ 139

FEATURE

Turbo C by Borland, ANSI Compiler supports 6 models including tiny and huge, has floating point, interactive editor, Make. Speed development PC \$ 69

Inquiry 249

Compare Products Use Product Specialists

The Programmer's Shop is much more than the supplier of the largest selection of programmer's software. Trained programming consultants will answer your questions. Ask "product specialists" about Cross Assembler, Translators, Debuggers, or compilers.

Our Services:

- Programmer's Referral List
- Compare Products
- Help find a Publisher
- Evaluation Literature FREE
- BBS - 7 PM to 7 AM 617-740-2611
- Dealers Inquire
- Newsletter
- Rush Order
- Over 700 products
- National Accounts Center

AZTEC C86 - Commercial PC \$499
 C86 PLUS - by CI MS Call
 Datalight C - fast compile, good code, 4 models, Lattice compatible, Lib source. Dev'rs Kit PC \$ 77
 Datalight Optimum - C MS \$ 99
 with Light Tools by Blaise PC \$168
 Lattice C - from Lattice MS \$275
 Let's C Combo Pack PC \$ 99
 Let's C PC \$ 59
 Microsoft C 4.0- Codeview MS \$275
 Uniware 68000/10/20 Cross Compiler MS Call
 Rex - C/86 by Systems & Software - standalone ROM MS \$695
 Wizard C MS \$299
 Rom Development Package MS \$259

C-terp by Gimpel - full K & R MS \$229
 C Trainer - by Catalytix PC \$ 89
 INSTANT C - Source debug, Edit to Run-3 seconds, .OBJs MS \$379
 Interactive C by IMPACC Assoc. PC \$209
 Run/C Professional MS \$159
 Run/C Lite MS \$ 89

C Libraries-General

Blackstar C Function Library PC \$ 79
 C Essentials - 200 functions PC \$ 75
 C Function Library MS \$109
 C Tools Plus (1 & 2) - Blaise PC \$125
 C Utilities by Essential PC \$129
 C Worthy Library - Complete, machine independent MS \$249
 Entelekon C Function Library PC \$119
 Entelekon Superfonts for C PC \$ 45
 Greenleaf Functions-portable, ASM \$139
 LIGHT TOOLS by Blaise PC \$ 69

Atari ST & Amiga

We carry full lines of Manx, Lattice, & Metacomco.

Call for a catalog, literature and solid value

800-421-8006

THE PROGRAMMER'S SHOP

Your complete source for software, services and answers

5-B Pond Park Road, Hingham, MA 02043
 Mass: 800-442-8070 or 617-740-2510 4/87

RECENT DISCOVERY

NET-TOOLS - Access NETBIOS-compatible network systems from Microsoft C, Pascal, FORTRAN, Assembler, Lattice C. Full Source, No Royalties PC \$129

Clipper compiler PC Call
 dBASE II MS \$329
 dBase III Plus PC \$429
 dBASE III LanPack PC \$649
 DBXL Interpreter by Word Tech PC \$139
 FoxBASE+ - single user MS \$349
 Quick Silver by Word Tech PC \$499

dBase Tools for C PC \$ 65
 dBrief with Brief PC Call
 DBC ISAM by Lattice MS Call
 dBX Translator to C MS \$319
 dFlow - flowchart, xref MS Call
 Documentor - dFlow superset MS Call
 Genifer by Bytel-code generator MS \$299
 QuickCode III Plus MS \$249

Fortran & Supporting

50:More FORTRAN PC \$ 99
 ACS Time Series MS \$399
 Forlib+ by Alpha MS \$ 59
 MS Fortran - 4.0, full '77 MS \$279
 No Limit - Fortran Scientific PC \$115
 PC-Fortran Tools - xref, pprint PC \$179
 RM/Fortran MS Call
 Scientific Subroutines - Matrix MS \$139

BTRIEVE ISAM MS \$185
 BTRIEVE/N-multiuser MS \$455
 Flash-Up Windows PC \$ 79
 GSS Graphics Dev't Toolkit PC \$375
 HALO Graphics PC \$209
 Development Package MS \$395
 Informix - by RDS PC \$639
 Informix 4GL-application builder PC \$789
 Informix SQL - ANSI standard PC \$639
 Opt Tech Sort - sort, merge MS \$ 99
 PANEL MS \$215
 Pfinish - by Phoenix MS \$229
 PolyLibrarian by Polytron MS \$ 79
 PolyBoost - speed I/O, keyboard PC \$ 69
 PVCS Corporate-source control MS \$319
 QMake by Quilt Co. MS \$ 85
 Report Option - For Xtrieve MS \$109
 Screen Sulptor PC \$ 95
 SRMS - source control MS \$109
 VXM - multi-env. link MS \$ 75
 Xtrieve - organize database MS \$199
 ZAP Communications - VT 100 PC \$ 89

FEATURE

Personal COBOL by MicroFocus- Develop, test, debug, execute ANSI '74 code. Full-screen editor, syntax checker, Animator, forms/ screen generator, help. Compatible with Level II. PC \$169

Note: All prices subject to change without notice. Mention this ad. Some prices are specials. Ask about COD and POs. Formats: 3" laptop now available, plus 200 others. UPS surface shipping add \$3 item.



CAD

SOFTWARE & PRINTERS

PRINTERS & LASERS

CITIZEN	PANASONIC
1200 \$172	10811 \$185
MSP-10 \$259	10911 \$239
MSP-15 \$355	10921 \$289
MSP-20 \$295	1592 \$379
MSP-25 \$445	3131 \$228
OVERTURE 110 CALL	3151 \$355
PREMIERE 35 \$429	TOSHIBA
TRIBUTE 224 CALL	321 SL CALL
H-P Laser Jet 500+ \$3690	341 E \$649
JOL CALL	351 II \$888
	351 C \$1079

CHIPS

64K, 256K, 8087, 80287 CALL

MONITORS & TERMINALS

AMDEK CALL	THOMPSON
GOLDSTAR \$70	UltraScan \$598
TTL \$229	VERTICOM
RGB \$269	CD-5 \$1998
RGB HI-RES \$269	OTHERS CALL
HITACHI CALL	VIKING 1 \$1619
MITSUBISHI CALL	VIKING 10 \$3380
1371A DIAMOND SCAN CALL	VMI CALL
OTHERS CALL	WYSE
NEC MultiSync \$539	30 \$282
SIGMA DESIGNS	50 \$356
15" 1664x1200 w/card \$1590	75 \$559
19" w/card \$1890	85 \$424
SONY MultiScan CALL	700 \$679
TAXAN CALL	Others CALL

AUTOCAD

Tutorials, Add-Ons for Arch., Eng., Construction, Civil, Piping, Mapping, etc., AOE-3 CALL
--

SOFTWARE

500+ Others CALL	Lotus 123 \$309
ACAD CALL	MathCad \$199
BookMark \$49	MicroSoft Word 3.11 \$339
CPA- for Lotus 123 \$289	MSDOS 3.2 w/Basic \$69
Clipper \$365	NewViews \$489
eBase III+ \$379	Paradox \$369
Dratrix 1+ \$179	PathMinder (Editor's Choice) \$39
Dr. Halo II (Hd. qty.) \$25	Perspective 3D \$139
EasyCad \$279	PFS: First Choice \$82
Enable 2.0 \$311	PFS: Professional Write \$99
FastCad \$1298	PFS: Professional File \$120
Framework II CALL	PFS: Professional Plan \$119
Generic Cadd 3.0 \$55	R: Base 5000 Sys V \$349
Generic w/dot \$68	Silk \$209
Generic options CALL	Tas-Books \$79
Harvard Presentation	Ventura Publishing \$499
Graphics II \$194	VersaCad Libraries CALL
Harvard Professional	WordPerfect 4.2 \$192
Publisher CALL	

DIGITIZERS & PLOTTERS

CALCOMP	HITACHI
1043 GT CALL	Tiger 1111C \$469
1043 GT \$6890	JDL 850 CALL
Digitizers CALL	MITSUBISHI Digitizers
ENTER \$659	Gralnet-01 8x12 \$260
Sweet-p 600 \$559	Gralnet-02 13x16 \$392
GTCO CALL	NICOLET-BRUNING
HOUSTON INST.	900 A/E \$6495
DMP 41/42 \$2333	NUMONICS CALL
DMP 51/52 \$3330	SUMMAGRAPHICS
DMP 52MP \$3757	Summa 12x12 \$349
DMP 56A \$4259	Others CALL
MP options CALL	

COMPUTERS

AST 286 CALL	TOSHIBA
COMPAC CALL	T1100+ \$1339
CORDATA CALL	T3100 CALL
IBM CALL	T3100 Battery Pak \$379
NEC Multispeed \$1359	WYSE 286 \$1699
Sperry IT (AT)	Zenith Laptop CALL
Enhanced 44 Meg \$2599	

BOARDS & NETWORKS

ARTIST CALL	NEC GB-1 \$359
ARISTOCADS CALL	PARADISE
ATI	AutoSwitch (560 model) \$259
Graphic Solutions \$169	AutoSwitch 350 \$279
EGA Wonder \$237	AutoSwitch 480 \$359
G/NET CALL	PHOTON CALL
GENDA SuperEGA CALL	SIGMA DESIGNS
HERCULES	EGA 350 AutoCard \$199
Color \$139	EGA 480 AutoCard \$289
Graphics Plus \$171	Color 400 (non-interface) \$299
InColor \$359	VERTICOM CALL
INTEL	VIDEO 7
Above Board AT \$311	Vega Deluxe \$319
Above Board PS/AT \$344	Others CALL
InBoard 386/AT \$1436	

MODEMS & DRIVES

HAYES	SEAGATE
1200B w/soft \$319	ST225 20 w/WD Card \$335
2400 w/soft \$539	ST238 30 w/Card \$399
2400B w/soft \$489	US ROBOTICS
MODEM 1200B w/soft \$98	Courier 2400 E \$359
	MicroLink 2400 \$339

MOUSE & ACCESSORIES

LogiTech	MicroSoft Mouse w/Paint \$115
Logimouse \$68	PC Mouse/Optimouse
Logimouse Bus \$89	w/Halo II \$98
	Tilt & Swivel Stand \$29

M.H.I. WAREHOUSE

5021 N. 20th Street #10281 • Phoenix, AZ 85064
TOLL FREE with card • 800-955-1134
Hours: 9-5 MT M-F 9-2 SAT

Prices reflect cash discount and are subject to change without notice. Compatibility products not guaranteed. All returns are subject to a restocking charge. Purchase orders are welcome and C.O.D.s are subject to 2% plus shipping.

CHAOS MANOR

That's a real pity, because there are some good ideas in this machine. In fact, they're good enough to give it another try. Roberta Pournelle doesn't find the screen hard to see at all, even with her contacts instead of spectacles. I'm going to let her carry it for a month and report again.

Moving Data

One real problem with a portable is getting data from it to your regular computer. You can use Zenith's PCXFER program (see last month's report), but it's god-awful slow and not easy to set up the proper cable. You can use Traveling Software's DOS for the Radio Shack 3 1/2-inch disk, but that's a bit awkward too.

A better way is The Brooklyn Bridge from White Crane Systems. This comes with 5 1/4- and 3 1/2-inch disks and a cable that can connect to either a PC or an AT at one end and your portable at the other. When you're done, the big machine is entirely slaved to the small one (or vice versa). The remote machine's disk drives appear to be additional drives on the local equipment. You transfer files—programs or data—by using the DOS Copy command in the normal way. You can also get at the other machine's printer.

The Brooklyn Bridge isn't particularly fast, but it's faster than PCXFER. It has to be installed by editing your CONFIG.SYS file and rebooting. That turns out to be easy. The instructions are clear, and I don't think it took me more than 15 minutes from opening the package to transferring the files between Zebediah and Zelda. It's certainly the most painless file transfer program I've used. Recommended.

WordStar 4.0

It came as a bundle of disks in an unmarked package, with dire warnings of what would happen to me if I let the secret out early. I understand Wayne Rash got his copy from someone driving by and handing it to him as he walked down the street. In other words, MicroPro went to incredible lengths to prevent WordStar 4.0 from getting out before they were ready to release it.

The result wasn't good enough to woo me away from WordPerfect, but it's darned good. If you use WordStar—especially if you use WordStar but hate WordStar 2000—you'll love this. WordStar 4.0 incorporates all the nifty new features of NewWord and adds a bunch of updates of its own. It still has some problems. For one thing, it won't reformat a paragraph without your telling it to. On the other hand, it's fast enough, and it can print rings around most of its competition. No question about it: version 4.0 moves

WordStar up to 1987 and makes it competitive again.

WordStar has always been everyone's second-favorite text editor. If you have many outsiders using your equipment, it's important to have a copy: everyone knows, or should know, how to use WordStar. It has plenty of add-ons, including a good spelling checker and mail merge program, and they're easy to use.

It's nice to see they're bringing the old girl up to date again.

A First Look

One of my biggest problems is memory: I keep several memory-resident programs in Zelda; so many, that programs like Symantec's Q&A, which would normally be my favorite database and might even win me over to its word processor, won't work unless I dump my memory-resident programs, change my AUTOEXEC.BAT file so it won't bring them in again, and reboot. Since I don't really like doing that, I hardly ever use Q&A.

I have the same problem with Ashton-Tate's Framework, which seems a very nice program, but which wants just about all my memory.

There are several possible remedies for this. One, I'm told, is the Cheetah 386 board and a program they furnish. This will, they say, give me the equivalent of a bunch of PCs, one of which can be filled with memory-resident programs, another running Q&A, a third doing Framework, and so forth. It all sounds wonderful, but I don't yet have it.

Then at the Seybold Conference on Desktop Communications, Terry Meyer gave me a demonstration of Quarterdeck's DESQview, which is a windowing system that's supposed to let you use a RAM disk as virtual memory. The notion is that you open a DESQview window and run a program in that; when you want to do something else, you invoke DESQview with its "hot key" and open a new window; you can run another program in there. Understand, both programs are still running, and you can jump back and forth as you like. All the programs have plenty of memory, because DESQview can create virtual memory by swapping in and out of RAM disk, or even your hard disk.

It sounds great, and the demonstration looked wonderful, so it was with some sense of high anticipation that I installed DESQview. The installation instructions in the manual are simple enough to follow. The result was utter disaster.

It was probably my fault. The DESQview manual is pretty long, and I didn't read all of it. I did follow their instructions, and where I had doubts I tried to look things up in the index.

The first disaster was caused by my memory-resident programs. You can invoke DESQview just fine with SuperKey and SideKick in memory, but if you then try to run a program—say, Crosstalk—the computer goes off into the Bit Zone, and nothing you can do, short of turning it off, will bring it back.

Fine, thought I. Since SideKick is supposed to run under DESQview, and DESQview has its own macro program so you don't need SuperKey, I'll just eliminate all the memory-resident programs and start over.

I also read the fine print and discovered that if DESQview hasn't been told to do otherwise, it swaps your programs and data in and out of the root directory of your hard disk. Clearly I wanted to tell it to use the RAM disk for that, so I ran the Setup program.

This one tells you it has a "beginner" mode and an "advanced" mode. I figured I better stick to "beginner." Wrong. Beginners can't specify which disk to swap in and out of. Run Setup again and tell it I'm "advanced." Now reboot without memory-resident programs.

This time DESQview was able to run Crosstalk, and I was able to connect to BIX. It wasn't easy, though: DESQview has a default window size that's pretty small. If you do things right, you can rush in and change that to be the full size of the screen for Crosstalk before the modem times out. If you don't change the window size, you won't be able to see the Crosstalk command line, and commands you type won't get to Crosstalk.

Alas, when you then make connection with your called number, the window does something funny, and the command line vanishes again even though you've now made the window as large as it can get. I could get my command line back by invoking the DESQview resize function, making the window smaller, and then expanding it again; but it was a definite pain in the posterior. Meanwhile, BIX was jerky: DESQview was apparently monitoring the input and doling it out to the screen in little packets.

I had other problems. When I tried to run SideKick, I managed to lock up the machine so that it had to be turned off to recover. Another time I got some really mysterious numbers that looked like a core dump.

Now clearly I am doing something wrong. People I respect, including Andy Seybold, run DESQview and like it a lot. It has got decent reviews. It must work better than I have been able to make it work, and indeed, inspection of the rather complete—if not optimally organized—manual reveals some clues about what may be going wrong. Also, they tell

me DESQview 2.0, out about when you read this, will have fixed several of the problems I found.

I'm going to keep trying; I've reason to believe the results will be worth it. Meanwhile, I do advise anyone contemplating DESQview to budget considerable time for study and installation. More next month.

A Few DOS Discoveries

At last count there were 37 computers around Chaos Manor, and while I suppose a majority of those run PC-DOS in

one form or another, there are plenty of examples of other systems. After all, I still write my books on an ancient CP/M system.

Consequently, I'm continually discovering things about DOS that many users have long known.

For example, there is a minimum size to disk files no matter how little you put in them. On the Z-248 under DOS 3.1, that happens to be 2048 bytes; meaning that 20 tiny batch files will take up at least 40K bytes of disk space. This isn't much

continued

When You're Looking for Answers, Come to the Library

10 MHz AT Compatible System

Complete Monographic System with Monitor and Display card

- Mono Monitor
- Hercules compatible card
- 67% faster than IBM AT
- 8/10 MHz switchable
- 512KB memory
- W.D. HD/floppy controller
- 1.2MB TEAC floppy drive
- Fully IBM compatible BIOS
- CMOS clock/calendar
- 200 watt power supply
- AT style keyboard
- Operation Manual
- Set up Utility Software
- SI Rating 103

\$1249

Runs Xenix™ Auto Cad Novell Network

EGA System
with EGA monitor and EGA card

\$1659

Basic System
without Mono monitor and Video card

\$1129



8 MHz Turbo XT System

Fully IBM compatible

- 8088-2 8 MHz CPU
- 4.77 & 8 MHz keyboard selectable
- 360K floppy drive
- Floppy drive controller
- 256K memory expandable to 640K
- Option Math Co-processor
- 150W power supply
- Keyboard

\$399

FCC Class 'B' approved
One Year Warranty



\$365

Seagate 20MB Subsystem

- ST-225 Drive
- Controller
- Cable and hardware
- Software and Manual

20MB ST-4026 \$549
30MB ST-4038 \$599
40MB ST-4051 \$699
80MB ST-4086 \$1125

- Cable, rails
- Software and manual

AT Multifunction

\$175

- Up to 2MB memory
- Selectable memory addressing
- Serial/Parallel/ Game ports
- Software

Everex Modem

\$128

- Half-size
- 300/1200 BAUD
- Fully Hayes comp
- BITCOM communications software
- 2400 BAUD CALL

EGA Card

\$228

- Fully IBM EGA comp
- Color/Mono display
- 16 colors from a palette of 64
- 640 x 350 high resolution graphics
- 256K Display memory

Mini I/O Card

\$59

- Parallel/Serail
- Clock/calendar
- Half-size card
- Cables
- With Game port \$69

Wangtek 60MB Tape Backup

INT \$727 EXT \$827

- Backup SMB in 1 minute
- Image/file by file
- Mounting hardware
- Software and Tape

COMPUTER LIBRARY

Sales (415) 659-8784

Tech Support (415) 659-8887

42624 Christy St.
Fremont, CA 94538

Quantity Discounts Available

Terms: We accept MasterCard VISA (2% surcharge), DOD's (Contract Funds) and Company/Institutional (PO's). California residents add 7% sales tax. For returns and repairs, call for RMA number. 15% restocking fee charged on unauthorized returns. Prices are subject to change without notice. BitCom, Hayes, Hercules, and IBM are registered trademarks of their respective companies.

Others:

- AT Multifunction \$175
- AT 3MB Memory Expansion card \$165
- AT HD/Floppy controller \$94
- PC Multifunction \$139
- Multifunction/Mono card \$498
- Expansion chassis \$33
- Floppy controller \$229
- EVEREX Edge \$69
- DOS 3.1 \$75
- 150 W power supply \$175
- Keyboard AT/XT CALL
- Mono/Color/EGA monitor \$280
- TEAC 20MB Tape backup \$80
- Hercules compatible \$98

Inquiry 67

JUNE 1987 • BYTE 285

of a problem if you have a 30-megabyte hard disk, but it can be a real pain for those who have to run off floppies.

A little trick I've recently learned involves buffers. PC AT machines like Big Kat, the Kaypro 286i, and Zelda are so much faster than ordinary PCs that you tend to accept what they give without thinking of improvements; but the other day I noticed that if I asked for the directory of a disk area that had a lot of files, I'd first get smooth scrolling, and then suddenly the system would change modes, putting up one item at a time and clicking the disk head like mad.

"Some kind of buffer problem," I thought, and recalled I'd heard of a "buffers" command in DOS. I looked into my CONFIG.SYS file, and sure enough, nothing about buffers. Then I looked up "buffers" in Chris DeVoney's *Using PC-DOS* (Que Books, 1986). The discussion was enlightening.

CP/M had a command processing area and a temporary file area, or TPA. The disk buffer area, where disk information was stored prior to being used by the system, was in the CP/M reserved area, and while it might be modified when you set up the system, it wasn't anything the casual user could change. DOS, how-

ever, lets you set aside any number of 528-byte buffers and change that any time you care to reboot the system. As soon as I put `BUFFERS = 20` into the `CONFIG.SYS` file, the machine began showing me truly enormous directories without the hunt-and-peck click/clack I'd got before. It also speeded up other disk I/O jobs.

I'm sure I haven't set aside enough buffers yet, and when I get a little time ahead I intend to experiment.

Meanwhile, those who, like me, never quite learned DOS would do well to look at some books beyond "how to use it" guides. One useful book is Jonathan Kamin's *The MS-DOS Power User's Guide* (Sybex, 1986). I've never been fond of the term "power user" (nor do I know what one is), but this book does have a good discussion of how to organize disk files, how to use batch files, and how to customize your screen.

Van Wolverton's *Supercharging MS-DOS* (Microsoft Press, 1986) is even more useful and a great deal more complete. It's also denser and a bit harder to read, although any interested user should get through it with no real problems.

Wolverton and Kamin overlap about 80 percent, but it's actually worth having

both books, since their approaches are somewhat different.

Sometimes We Win One

Last month I reported on the difficulties I'd had setting the CompuPro ARCNET PC board to its proper address.

I've just received the new CompuPro documents for that board. Mark Garetz, marketing vice president, says, "You'll note that we've taken your advice and made the section on setting the node number much easier to comprehend. It now has decimal numbers and a picture of each switch for all 255 possible node numbers."

It does, too. We just got a new AT&T 6300 Plus, with color monitor, and I set it up for Roberta; installing the network (we gave the 6300 Plus a network ID of 63, naturally) was a snap. Since WordPerfect 4.2 works *fine* with the network, we can now trade files back and forth. I love it.

ExperTelligence Common LISP

One of the most impressive booths at the Mac Faire was ExperTelligence's. Its expert-system artificial intelligence programs weren't finished, but they were startling. I spent an hour at that booth.

continued



**Nothing Should
Come Between
Mainframe Mag Tapes
and Your dBASE or Lotus
Except**

Telebyte Tape Drives

TDX Mag 9-track 1/2" Tape Systems from Telebyte provide faster, error-free downloading of mainframe data into your PC. You control the start-stop tape drive either from the keyboard or with Telebyte's exclusive Dataverter software for faster file transfer — the equivalent of a 720,000 bit/second datalink.

Telebyte TDX tape drives are available at either 45 or 75 ips, feature dual density (800/1600 bpi) storage and back up processed files at 2 MB/minute (up to 10 times faster than other 9-track drive systems) as a bonus.



Enter data into dBASE® and Lotus® with no user programming. You do it in two easy steps because Telebyte's exclusive **Dataverter runs under both DOS 2.0 and Xenix™**. Dataverter will automatically convert packed, zoned and unsigned decimal field files, as well as labeled tapes, from EBCDIC to ASCII. The tape system is also supported by software languages in your PC, including C, BASIC, Fortran, Cobol, etc.

Only Telebyte offers such mainframe standards of reliability and IBM-compatible tape drive quality for so little money.

TELEBYTE
TECHNOLOGY, INC.

GSA Contract Number GS00K86AGS5301

1-800-835-3298

Telebyte Technology, Inc. • 270 E. Pulaski Road • Greenlawn NY 11740 • (516) 423-3232

dBASE® is a registered trademark of Ashton-Tate, Inc.; Lotus® is a registered trademark of Lotus Development Corporation; IBM™ is a registered trademark of International Business Machine Corporation; Xenix™ is a registered trademark of MicroSoft.

Add the Reader,

ORIGINAL



DISPLAY



subtract the work.



Having an office system capable of reading text, graphics and photographs is no longer a luxury. It's a necessity.

The addition of the Reader to your present system will virtually eliminate the need to retype or recreate documents and images. The

Reader can scan continuous tone images, such as photographs, by converting them to 128 shades of grey and transfer them to your system. Imagine multiplying your graphic scanning ability to a point where you can reproduce photos or graphics in vivid detail. The applications are countless. And with the Reader's 30 page capacity it can feed up to 4 pages of text a minute. Accurately and automatically.

Standard features allow you to read pages directly into word processing programs such as Wordstar® 2000, Multimate™, XyWrite™ III, Word Perfect™, DisplayWrite™ III and Microsoft® Word. Features for filing and editing are provided in an easy to use format. The

Reader also offers a multitude of interfaces to the most popular page make-up and graphic editing programs available. Unique software architecture permits the addition of new typestyles and features to your system without the worry of hardware obsolescence or costly

upgrading.

Consider the possibilities. Words and pictures reproduced into a polished, professional appearance you never dreamed affordable. So total up the time and effort you spend at your system, then add the Reader and subtract the work.

Yes, I am very interested in the IOC Reader. Please send me more information.

Name _____

Address _____

City _____ State _____ Zip _____

Phone _____

Mail to or call: Intelligent Optics Corporation
 4 Heritage Park Road, Clinton, CT 06413 Telephone (203) 669-3650

INTELLIGENT OPTICS CORPORATION

Names indicated by TM or ® are trademarks of their respective manufacturers.

One product they do have finished is LISP for the Mac.

LISP is an odd language. The name comes from "list processing," although detractors say it's an acronym for "lots of insane stupid parentheses." LISP can be learned from books, but the easiest way is to hang around people who use it. The second easiest way is to bang away at a machine that speaks LISP. However you learn it, you will very likely believe it is incomprehensible and that anyone who knows the language is not merely odd, but weird. Eventually, though, if you keep at it long enough you will have an aha! experience, and the language will begin to make sense. (LISP haters say that you'll then have gone as mad as the others.)

Despite the fact that LISP is one of the oldest of the higher-level languages, it has not only stayed around but has grown in popularity. Philippe Kahn likes to advertise Prolog as the language of artificial intelligence, but in fact most AI applications—at least on big machines—are done in LISP.

LISP has never caught on as a development language for small computers, for the good reason that it's a memory hog. John McCarthy, the Stanford University

professor who wrote LISP in 1956, says it doesn't get interesting until you have a megabyte of memory, and it's not *really* interesting until you have 6 to 8 megabytes. Few micros have either the hardware or software to address that much memory—although Apple's Macintosh II has the potential.

In the past, the most interesting LISP for micros was Metacomco's Cambridge LISP for the Stride Micro 68000 computer line. Now, though, we have Expertelligence Common LISP for the Macintosh.

Expertelligence Common LISP is complete and professional enough to use for program development, and indeed, many Expertelligence AI programs are being written in it. You get a full Common LISP, lots of examples on how to use it, and plenty of tools to help convert from the Pascal way of thinking to "the LISP experience." The documents are professional and well laid out. In many ways, Expertelligence Common LISP can serve as a model on how to publish a language.

That's the good news. The bad news is the price: \$995. Expertelligence Common LISP is probably worth the cost for someone with a good programming ap-

plication, but the price is far too high for those who just want to bang around learning the language. They do offer a crippled educational version—no stand-alone programs, no Mac Toolbox access—but it's for universities only, and still costs \$195.

Pascal didn't really take off until Borland brought out Turbo Pascal and sold it at a price low enough that any interested computer owner could afford to try writing Pascal programs. I doubt LISP will ever take off the way Pascal did, but it sure isn't going to until we have a lower-cost version.

I really wish Expertelligence would rethink those prices.

Speed of Light

Last year I reviewed Lightspeed C. At the time this was a program I'd seen in a small booth at the West Coast Computer Faire, and Think Technologies, the publisher, was a pretty small outfit.

Since then Lightspeed C has become the standard C compiler for the Macintosh. Some C enthusiasts say there isn't even a second place. It comes with compiler, linker, libraries, examples, a manual that could serve as a model for others, and up-to-date bug corrections. The li-

continued

Exercise Your Subroutines



Jeff Zurkow, President
of Avocet Systems

... On Our Simulator.

Microprocessor development tools that won't torpedo your budget.

Test microprocessor code on your PC or VAX—without burning EPROMs or buying special hardware. Avocet's AVSIM simulator/debuggers give you full screen symbolic debugging that easily handles the deepest I/O and interrupt situations. And AVSIM's crashproof software simulation traps bugs that can sink hardware debuggers. AVSIM is even better when you use it with our AVMAC cross-assemblers—fast, professional products that come complete with Avocet's advanced linker, librarian, and cross-referencer.

Proven reliable in hundreds of development projects, AVSIM and AVMAC are available for most popular microprocessors. The Avocet convoy also includes AVPROM and AVPAL programmers, TRICE in-circuit emulators, and other low-cost high-performance development tools. We're sure you'll find Avocet your best line of defense against slipped schedules and high development system costs.

Try before you buy. And we'll ship in 48 hours or less.

When you order from Avocet, we'll also include a complete demo package for the AVMAC and AVSIM of your choice. Try the demo for thirty days—if you aren't completely satisfied we'll refund your purchase price, less \$35.00 for the demo package, which is yours to keep.

Come aboard with Avocet. Our crew is experienced, knowledgeable and helpful. After all, you know the old saying, "Accept no substitutes." Avocet Systems Inc., 120 Union St., P.O. Box 490, Rockport, ME 04856.

AVOCET
SYSTEMS, INC.®

Call 800-448-8500
or 207-236-9055
TLX 467210 AVOCET CI
FAX 207-236-6713

THE PROGRAMMER'S SHOP

Offers a 31 Day Money Back Guarantee on any product in this ad. Call Today.



SAPIENS SOFTWARE CORPORATION
REAL ARTIFICIAL INTELLIGENCE

S A P I E N S V 8 A VIRTUAL MEMORY MANAGER FOR THE PC

Sapiens V8 is a virtual memory manager for C programmers on the IBM PC. The unique design of the virtual memory paging storage scheme makes it an invaluable tool for C programmers. With an 8 mg. workspace and stack and heap libraries Sapiens V8 solves the problems and hazards of stack and heap overflow.

Sapiens V8 brings the power, speed and complexity of a main-frame virtual memory manager to the PC. Sapiens V8 virtual memory manager emulates a 80386 memory management system and is fully implemented in software. It is not dependent on add-on boards or special chips.

- Provides 8 mgs. virtual memory workspace
- Fast: less than 10% speed overhead
- Advanced software emulation of 64-bit architecture
- Virtual stack and heap: multiple return values, stack frame management. (vmalloc()).

System requirements: Hugemodel C compiler (Microsoft, Lattice, Aztec). V8 uses 22-128 Kb core. Hard disk recommended.

List: \$300 Ours: \$259

PVCS *The Most Powerful & Flexible Source Code Revision & Version Control System*

The POLYTRON Version Control System (PVCS) allows programmers, project managers, librarians and system administrators to effectively control the proliferation of revisions and versions of source code in software systems and products. PVCS is a superb tool for programmers and programming teams. (A special LAN version is also available.) If you allow simultaneous changes to a module PVCS can merge the changes into a single new revision. If the changes conflict, the user is notified. Powerful capabilities include: Stores and retrieves multiple revisions of text; Maintains a complete history of revisions to act as an "audit trail" to monitor the evolution of a software system; Maintains separate lines of development or "branching"; Provides for levels of security to assure system integrity; Uses an intelligent "difference detection" to minimize the amount of disk space required to store a new version. Requires DOS 2.0 or higher. Compatible with the IBM PC, XT, AT and other MS-DOS PCs.

	Sug. Retail	Prog. Shop
Personal PVCS		
—For single-programmer projects	\$149	\$129
Corporate PVCS		
—For larger, multiple-programmer projects	\$395	\$359

Call POLYTRON at (503) 645-1150 for pricing on larger networks



High Quality Software Since 1982

WANT TO ADD WINDOWS, ICONS, FONTS, FAST GRAPHICS, DIALOG BOXES, PROCESS MANAGEMENT, AND DEVICE INDEPENDENCE

TO YOUR IBM PC PROGRAMS?

If you have ever wished that you could develop stunning Macintosh-like programs on the IBM PC without the overhead of an enormous operating environment like Windows or GEM, then you need the **SYNERGY DEVELOPMENT TOOLKIT, from Matrix Software.**

Using a memory resident runtime module only 20K in size (versus as much as 300K for Windows), you can develop applications with: overlapped and tiled windows; pull-down menus with half intensity options and automatic sizing; fast graphics function calls to draw shapes, lines, boxes, and create intricate fill patterns in both regular and irregular areas; have full device independence (drivers for numerous devices, including CGA, EGA and Hercules are included); sophisticated text input and output, with fonts in different styles and sizes; full keyboard support (your programs won't need a mouse!) and powerful mouse support; and process management calls to efficiently manipulate system resources.

The Toolkit has gateways to support the following languages:

- Turbo Pascal
- Microsoft & Lattice C
- Basic
- IBM/MS Pascal
- Macro Assembler
- dBASE II/III Compilers

In addition, the Toolkit includes a powerful collection of tools including a graphics resource editor for developing your own icons and fonts.

NEW! The Toolkit also includes a free copy of Synergy Layout, a revolutionary software development tool that dramatically increases your productivity by actually generating bug-free source code in Macro, C, and Turbo Pascal.

For further information, contact Matrix Software at (617) 567-0037.

Synergy Desktop

List: \$69.95 Ours: \$63

Development Toolkit

List: \$395 Ours: \$349

Call Today for FREE detailed information or try Risk-Free for 31 days.

800-421-8006
HOURS: 8:30 A.M. - 8:00 P.M. E.S.T.

5-B Pond Park Road, Hingham, MA 02043
Mass: 800-442-8070 or 617-740-2510 4/87



nd they work. The links so fast you an integrated en- re of a number of you're interested

in C for the Macintosh, this is the program to get.

They also have a Lightspeed Pascal. I've had little time to do anything with it, but given the quality of their C, I can't think it won't be a winner. The manual looks well-organized and very complete, and the one program I wrote compiled at least as fast as a comparable C program. Maybe faster. I can't wait to get some time to play with this. I'd also like to see what it can do on the Mac II.

Guide

Some years ago Ted Nelson proposed Project Xanadu, a "hypertext" system. The concept involved linking, on-line and in real time, just about every bit of knowledge in the world and adding to it as new knowledge was generated.

Xanadu is an ongoing project, although incomplete; but the hypertext notion has caught on. Guide, a new product for the Macintosh, is a bold step in that direction. I suppose it's hardly a coincidence that Ted Nelson is a consultant to

OWL International, Guide's publisher.

The notion behind hypertext is to link audio, photographs, drawings, maps, motion pictures, and every other form of information into a seamless whole that can be accessed through an indexing system that looks for ideas, not specific words and text. While Guide can't quite do that—not on a Macintosh, anyway—it can link a number of information forms. Guide is a word processor, outline processor, and information linker.

Most of the programming for OWL is being done in Edinburgh, Scotland, which probably explains why its suite at the CD-ROM conference was stocked with single-malt whiskey. When I asked about the notorious Scottish weather, Robie McLaren, product manager, said, "Och, it keeps the programmers inside and working. Now if we could only keep them away from the whiskey." Having been to Edinburgh, I quite understand.

The key notion behind Guide is the "button," which is merely a live area on the screen. When you discover a button and click the mouse, you get action of one kind or another. Guide lets you control those actions: generally something pops up onto the screen, either in an overlay across the original display or in a special

window somewhere. The result can be an annotated calendar, text with live footnotes, annotated graphs and drawings, or indeed about anything you can imagine doing on a Macintosh. You can write a guidebook with the ability to click on any place name and get a map. Those maps could have buttons, allowing you to zoom down to any level desired.

In addition, I have seen a program written with Guide that takes you on a guided tour of a videodisc; as you click various items on the computer screen, the relevant portions of the videodisc are found and displayed on a TV screen.

I can imagine Guide being used to make special indexes and guided tours through CD-ROM disks. The only real limit to the way the information can be organized is the designer's imagination. The program works smoothly, it's easy to use, and unique so far as I know. If you do presentations, or you're just interested in organizing information, you'll want to look at Guide. Highly recommended.

MacNosy Version 2

The Apple people are almost speaking to Steve Jasik again. Some of them are even polite.

continued

NEW RELEASE

3 MEGA BYTE AT-286 SYSTEM

W/"PARADISE" COMPATIBLE EGA CARD

NEW RELEASE

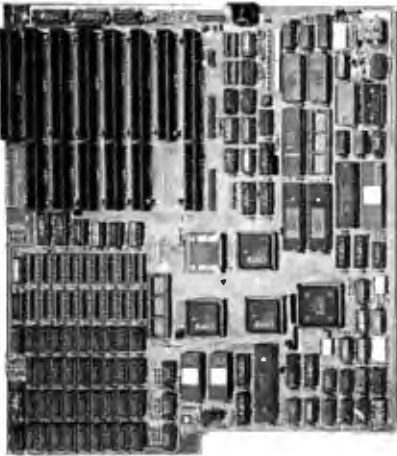

← TURBO AT-286 w/3MF Motherboard

- 80286 CPU
- 6, 8, 10 MHz
- Phoenix BIOS
- On Board Rechargeable Battery
- On Board Serial/Parallel/Game Port
- 3MB Memory Capacity On Board
- 80287 Socket Ready
- Chip Technology VLSI Chip Set

TURBO AT-286 System →

- 80286 CPU
- Phoenix BIOS
- 640K On Board Up To 3 MB
- Slide in Case w/220W Power Supply
- 6/8, 6/10 Dual Speed (Keyboard Selectable)
- 1.2 MB or 360K Floppy Drive
- Western Digital WA-2 Controller
- AT Type Keyboard
- Hardware Reset Ready
- Serial/Parallel/Game Port



WAYTRON INT'L, INC.
 (Manufactured for WiseTEK)
 513 Valley Way
 Milpitas, CA 95035
 TEL: (408) 263-1237
 FAX: (408) 263-1870

We also have TURBO XT (4 LAYER), MINI AT (XT Size)

Distributors, Dealers, Education, Corporation, VAR, OEM Welcome

AT and XT are the registered trademark of International Business Machines.

MICRONIC INT'L CORP.
 108 E. 16th Street
 New York, NY 10003
 TEL: (212) 529-4699
 FAX: (212) 529-9926

SPRING COMDEX BOOTH #4925

Think You Need an AT?

The Next Generation in IBM PC Speedup Boards



Make Your IBM PC Faster Than an AT in Just 5 Minutes!

	IBM PC	IBM AT	BREAKTHRU 286	
Clock speed in MHz (IBM PC is 4.77)	4.77	6	8	12
Empty Loop	1	1.99	3.34	5.15
Integer add from memory	1	3.35	4.41	6.02
Integer multiply from memory	1	6.06	6.55	8.3
Floating point without coprocessor	1	3.33	4.42	5.76
Prime number test	1	1.95	2.85	3.7
Lotus 123 macro (640K)	1	2.64	3.69	4.62
Lotus 123 macro (256K)	1	1.77	3.54	4.38
Norton System Information Test	1	5.73	7.34	10.2
PRICE			\$395	\$595
	speedup		purchased separately	

In every case but clock speed the numbers indicate how many times faster a test is performed than on a regular IBM PC

* All but Norton SI are the PC magazine Labs public domain benchmark tests.

We are excited about our three speedup products. You probably know about our Lightning disk access speedup software that was awarded PC Magazine's Best of 1986 award (see box). After the smashing success of Lightning, in late '86, we

But, no speedup board cuts disk access time in half

LIGHTNING

software can - \$89.95 or FREE w/Breakthru

"Lightning is almost mandatory..." - Steve Manes, PC Magazine Best of 86 review

Lights with the DOS - always ready as a background program to accelerate disk access. You do nothing - everything is automatic. Programs that frequently access the disk (hard or floppy) are made instantly up to 2 to 4 times faster. Uses a principle greatly enhanced from mainframe technology called caching. Fully exploits Above Board memory.

LIGHTNING is the standard against which all our competition measures itself because we achieve universal compatibility with other software. Data is never lost. Order LIGHTNING separately or get it free with your Breakthru 286 board.

guaranteed the Breakthru 286 board to be literally the most advanced, fastest, most feature-rich board available. The runaway success it has enjoyed truly proved that assertion. Now we go ourselves one better with the Breakthru 286-12. This new board has the clock speed cranked up from 8 to 12 MHz for speeds up to 10.2 times faster than an IBM PC. It is 50% faster than an 8MHz IBM AT, and up to a whopping 1,000% faster than a regular PC.

HERE'S WHY THESE TWO BOARDS ARE SO SPECIAL.

First, they install so easily. A half-slot card to give up more, unlike competing

products it works in the Compaq Portable and most clones. Easy diagrams show how you just place the card in an open slot, remove the original processor and connect a single cable. There is no software required. From that moment you are running faster than an AT.

Second, they are advanced. The BREAKTHRU 286 replaces the CPU of the PC or XT with an 80286 microprocessor that is faster than the one found in the AT. Has a 80287 math coprocessor slot for numeric intensive applications. A 16K cache memory provides zero-wait-access to the most recently used code and data. Speed switching software allows you to drop back to a lower speed on the fly for timing sensitive applications.

Third, you have full compatibility. All existing system RAM, hardware, and peripheral cards can be used without software modification. Our boards operate with LAN and mainframe communication products and conform to the Expanded Memory Specification (EMS). Software compatibility is virtually universal.

Faster and smarter than an AT - PCSG guarantees it.

Fourth, these are the best. There are several other boards on the speedup market. We at PCSG have compared them all, but there simply is no comparison. Many cards offer only a marginal speedup in spite of their claims and others are just poorly engineered.

We are really excited about these products. PCSG makes the unabashed statement that the BREAKTHRU 286 card represents more advanced technology than boards by Orchid, Quadram, P.C. Technologies, Phoenix...we could go on. Breakthru 286 is undisputedly the turbo board with the biggest bang for the buck. And we include FREE the \$89.95 acclaimed Lightning software. Call today 'our credit card or COD instructions and we will ship your card the very next day.

Think Again.

DON'T TAKE OUR WORD FOR IT. USE EITHER BREAKTHRU 286 SPEEDUP BOARD FOR 60 DAYS. IF YOU ARE NOT TOTALLY SATISFIED SIMPLY RETURN IT FOR A FULL REFUND.



Inquiry 236

PERSONAL COMPUTER SUPPORT GROUP

11035 Harry Hines Blvd. • Suite 206 • Dallas, Texas 75229 • (214) 351-0564



THE MODEM FOR PEOPLE WHO TAKE THEIR ACT ON THE ROAD.



When you travel with your portable computer, make sure your communications go with you. The WorldPort 1200™ Portable Modem is the only modem you need, whether you travel across the country or around the world.

While most portable computers offer an optional modem of some type, only the WorldPort 1200 gives you all the features required for true portability. Features like battery-powered, Hayes™ Command Set compatibility, Bell and CCITT standards, direct and acoustic cups interface for 300 and 1200 bps, and compact size.

Equally at home on your desktop, the WorldPort 1200 works with virtually any computer with a RS-232C serial port. No more of those dedicated internal modems that can only be used with one computer.

The WorldPort 1200. At only \$199, you can't afford to leave home without it.

For more information or your nearest dealer, contact us today.



Hayes is a registered trademark of Hayes Microcomputer Products, Inc.

Jasik's MacNosy was the first program that let hackers explore the innards of their Macintosh ROM set. It's a powerful disassembler, easy to use if you know something about assembly language, and it will let you look into ROMs, system files, and in general any Macintosh programs that intrigue you. You can, if you're ingenious, use it to remove copy protection, find traps, search source code for specific references, and generally go wandering about inside programs.

Version 2 comes with the Debugger, Jasik's version of DDT (Dynamic Debugging Tool) for the Mac. (Incidentally, the original DDT was apparently written at MIT by the Model Railroad Club.) Debuggers let you watch what's happening inside a program as it runs; they're not a lot of use to people who aren't trying to get a fundamental understanding of how programs work. If none of this makes sense, apologies: debuggers are mostly useful to hackers.

Jasik's Debugger isn't complete, but he has a good update policy. If you do or want to do program development on the Macintosh, you need MacNosy with the Debugger. Recommended.

T/Maker is an odd company, in that it doesn't sell its most famous product. The original T/Maker was written by Peter Roizen who, having decided he didn't want to be involved in running a company any longer, took his product and went away, leaving this perfectly good publishing outfit to be run by his sister Heidi.

WriteNow

One of the T/Maker Company's products is WriteNow for the Macintosh. This is a straightforward text editor/word processor, distinguished by having about the clearest manual I've ever seen. The explanation on how to use a word processor starts with the assumption that you don't know much—indeed, anything at all—about writing with computers. It then takes you through creating text, editing it, and saving it; after which it begins a new section on spelling checkers, footnotes, and advanced features.

WriteNow is the product of a cast of thousands. It was originally suggested by Steve Jobs, and indeed is owned by his Next Inc. The manual was written by Caroline Rose and Lisa Kelly. There are programming credits to Jobs, Andy Hertzfeld, Bob Bowen, and many others.

With all that connection to the old Mac team, it's no wonder that WriteNow is very "Macintoshy"; that is, it makes full use of the mouse and other Mac special features, like graying out icons that aren't applicable at present. It also doesn't have many "command key" commands, which some will find a virtue. I personal-

ly think it's a defect. When I write, I like to fiddle with text. I try new words and phrases to see what they look like. Insert stuff here and delete it there. I want easy and fast commands, like WordStar's Control-t to delete a word and WRITE's Control-y to delete to end of line. I don't want to have to drag the mouse to mark a word or phrase, then hit Backspace to kill it.

On the other hand, some people like that a lot. One day, I hope, most programs will have both approaches: easy-to-learn features involving icons and the mouse and easy-to-use features involving command keys. I suspect the Mac II, with its function keys, will do just that.

The best way to describe WriteNow is that it looks like MacWrite had died and gone to heaven: it does what MacWrite does, and does it faster and more reliably. Then it adds features like footnoting and multiple column printing, and packages the whole thing with a clear, complete, and well-indexed manual.

I suppose there are more elegant word processors, but this one is easy to learn, easy enough to use, and not very expensive. Recommended.

Modems and Communications

For the past two years, I've used OmniTel's Encore 1200 PC modem card in Lucy Van Pelt, then Big Kat, and now in Zelda. It has always worked fine. My son Alex runs a bulletin board from the companion stand-alone model; it gets a lot of use without complaints. OmniTel modems are rugged, reliable, and simple. They can be addressed to ports 1 through 4 with no difficulty, and they're as Hayes-compatible as modems can get.

I've finally had my first difficulties with my two-year-old Encore 1200. What happens is that it dials the number, and I hear the ring, answer, and carrier; but the modem refuses to believe that it has heard the carrier and finally times out. When it does that, it is sometimes hard to make it hang up.

The proper communications software would let you overcome that problem by manually commanding the modem to go listen to that carrier, whether detected or not; but alas, Crosstalk, which used to come with OmniTel's internal modems (they now come with BitCom), doesn't have that capability. Indeed, Crosstalk doesn't even want to let you control your phone and modem. As an example, suppose you want to dial a local access number on a hotel phone, then **quickly plug** the cord into the modem and connect.

No go. If you set up Crosstalk with all the correct data, stop-bit, and baud-rate parameters, and leave the "number to

continued



Newbury's solution to The Great American Printer Hang-up.

We've taken all the wrinkles out of paper handling.

Now you can have reliable paper handling for more high-speed, dot matrix printing time. Newbury Office Systems Printers (OSP) are designed to more than match the capabilities of your Personal Computer — whether your application is word processing or financial modeling, using shared resources or local area networks.

Set-ups and change-overs have never been easier with our 3-way paper handling.

In addition to speedy printing, Newbury gives you a new standard in 3-mode convenience and flexibility. We've integrated a unique, automatic paper-feed mechanism that is fast and reliable. It features self-registration auto-feed for single sheets. Simply snap in an interlocking paper cassette for faster automatic sheet-feeder applications. Or, snap in the interlocking tractor option with single belt and gear for true alignment of continuous forms.

Newbury offers more things for more offices.

Even at speeds of 200 cps, noise levels are quieted to less than 50 dBA. For print quality that is truly outstanding Newbury offers 9, 12 or 18-wire OSP models. All feature high-speed printing thru-put with Newbury's exclusive 3-line look-ahead logic, low-mass, high-efficiency printheads, and fast-line advance. And when you're ready for color, you have it by just inserting a clip-in color ribbon cartridge.

Inquiry 208 for End-Users.
Inquiry 209 for DEALERS ONLY.

Document after document, Newbury delivers faster thru-put rates and a total-feature-package that just makes more sense for more offices.

Get more details immediately.

Newbury Data

A member of the ORI Group

Europe's Leading Peripherals Manufacturer

NewburyData, Inc. U.S. Headquarters

2200 Pacific Coast Hwy., Suite 208
Hermosa Beach, CA 90254

Phone: **So. West** 213/372-3775, **No. West** 415/254-8350,
No. East 617/273-2161, **So. East** 512/834-7746

For OEMs and Distributors Only.

- Rush details on Newbury's OSP Printers.
- Send info on Newbury's 8850/300 lpm serial dot matrix printer.
- Send info on Newbury's model 8933 240 cps Text Processing Printer.
- Send data on Newbury's 3.5" /50MB and 5.25" /65 to 380MB high-performance Disk Drives.

Name _____
Company _____
Address _____
City _____ State _____ Zip _____

dial" field blank, when you tell Crosstalk to connect, it gives an error message. How dare you dial the number yourself! Crosstalk insists on doing the dialing for you, even though that may be terribly inconvenient.

That's a real pity, because I often find myself in situations in which I want to take control of the modem and do something that isn't in the books. I am told there are a number of communications programs more flexible than Crosstalk. I certainly intend to try them in the future.

Meanwhile, I'm about to replace my Encore 1200 with the Encore 2400HB internal modem. The 1200, incidentally, is still covered by OmniTel's two-year warranty. It has also been overtaken by technology; whereas my 1200 takes a full slot, the new versions of both the Encore 1200- and 2400-baud modems take only a

short (half) slot.

The Encore 2400HB is a beautifully made board. Up to now I've never needed 2400-baud capability, nor had any way to test it. I understand they're setting up a 2400-baud BIX line Real Soon Now. I can hardly wait. Meanwhile, I'm angling to get another Encore 2400HB for my associate, Barbara Clifford, so we can try long-distance file transfer.

Incidentally, the internal modem in my Z-181 portable is also made by OmniTel, and I've never had a bit of trouble with it.

We have had some terrible problems with line noise causing interference on the Zenith Zoom modem for PClones. That modem has a built-in Demon Dialer, which is an interesting feature; but it looks as if the software used is critical. Noise that would upset me, but not faze the Encore, seems to cause the Zenith

Zoom to hang up. More on that when I know more.

Winding Down

I'm out of space, and my desk is still covered with stuff I haven't mentioned. I have a full report on the Okidata printer line from Alex, who's been using them at Workman and Associates. Incidentally, Workman reports that a 68000 code generator for FTL Modula-2 is just about done; they'll have FTL Modula-2 for the Atari ST well before the end of the year.

There's MindWrite, a word processor and outline generator for the Mac. New refinements of Q&A. Tornado Notes, one of the niftiest little memory-resident programs I've ever seen. On that score, I have to mention how useful Living Videotext's Ready! has been: whenever I get a notion for this column, I can jot it down in Ready! regardless of what I may have been doing beforehand.

The minor book of the month is by James H. Reynolds, *Computing in Psychology* (Prentice-Hall). This is a discussion of the influence of the computer revolution on academic psychology, with material on models of mind, using computers to generate test scores, and such.

The major book of the month is Marvin Minsky's *The Society of Mind* (Simon and Schuster). Marvin originally invited me to collaborate on this book through the old ARPANET, but the mechanical and scheduling difficulties were too great. That's just as well, because I'm not sure I'd have had anything to contribute. *The Society of Mind* is a tour de force; if you've ever wondered how machines can think, or for that matter how you think, you can't fail to get insights from this book. You may not always agree with Minsky—I certainly don't—but you can't ignore what he says. I don't lightly label a book "important." This one is.

The game of the month is *The Uninvited*, from Mindscape, for the Macintosh. It has a really neat user interface combined with difficult puzzles: as if you had combined Wizardry and Zork.

We're less than halfway into 1987 and already we've got the Atari 2000, the Mac II, and other exciting stuff. I won't tell you how I know which ones will be important, but if you'll excuse me, I have to go generate a hexagram . . . ■

Jerry Pournelle welcomes readers' comments and opinions. Send a self-addressed, stamped envelope to Jerry Pournelle, c/o BYTE, One Phoenix Mill Lane, Peterborough, NH 03458. Please put your address on the letter as well as on the envelope. Due to the high volume of letters, Jerry cannot guarantee a personal reply.

Items Discussed

DESQview 1.3\$99.95 Quarterdeck Office Systems 150 Pico Blvd. Santa Monica, CA 90405 (213) 392-9701	MacNosy 2.0\$90 Jasik Designs 343 Trenton Way Menlo Park, CA 94025 (415) 322-1386
Electric Dragon\$34.95 Baen Software 260 Fifth Ave. New York, NY 10001 (212) 532-4111	NEC MultiSpeed\$1995 NEC Home Electronics (U.S.A.) Inc. Personal Computer Division 1255 Michael Dr. Wood Dale, IL 60191 (800) 323-1728
Encore 1200HB\$195 Encore 2400HB\$399 OmniTel Inc. 5415 Randall Place Fremont, CA 94538 (415) 490-2202	The Brooklyn Bridge\$129.95 White Crane Systems 6889 Peachtree Industrial Blvd. Suite 151 Norcross, GA 30092 (404) 454-7911
ExperTelligence Common LISP\$995 ExperTelligence Common LISP II\$1195 ExperTelligence Inc. 559 San Ysidro Rd. Santa Barbara, CA 93108 (805) 969-7874	The Uninvited\$49.95 Mindscape 3444 Dundee Rd. Northbrook, IL 60062 (800) 221-9884
Guide\$134.95 OWL International Inc. 14218 Northeast 21st St. Bellevue, WA 98007 (206) 747-3203	WordStar 4.0\$495 MicroPro International Corp. 33 San Pablo Ave. San Rafael, CA 94903 (415) 499-1200
Lightspeed C\$175 Lightspeed Pascal\$125 Think Technologies Inc. 135 South Rd. Bedford, MA 01730 (617) 863-5595	WriteNow\$175 T/Maker Company 1973 Landings Dr. Mountain View, CA 94043 (415) 962-0195

RUN LOTUS®, RUN.



Put Lotus on Paper Up to 6 Times Faster, Put a \$100 Rebate in Your Pocket.

If you use Lotus software to run your business, here's something you can really use: an IBM-compatible MICROLINE® 292 or 293 personal printer.

Thanks to a special driver program written exclusively for the 292/293, you can print all your correspondence quicker. See your spreadsheets sooner. And get crisp, clean black graphics in as little as 1/6 the time it would take you on a comparable IBM or Epson® printer.

Which means that whenever you're working with Lotus 1-2-3®,

	OKIDATA ML 292/293	IBM PROPRINTER	EPSON FX-286	EPSON EX-800
LOTUS SYMPHONY (PGS. TEXT/2 HRS.)				
NEAR-LETTER-QUALITY TEXT	273	109	91	135
LOW RESOLUTION	139	61	60	68
HIGH RESOLUTION	73	12	12	12

Symphony®, or 1-2-3 Report Writer™ you'll get a lot more done in a lot less time.

What's more, when you buy your 292/293 before June 30, you'll also

get an easy-to-use extra: a \$100 rebate direct to you from OKIDATA.

So before you walk another spreadsheet through your present printer, run to your nearest OKIDATA dealer. Or call 1-800-OKIDATA, EXT. 23 for the name of the dealer nearest you.

Then let your printer run faster - so you don't have to.

OKIDATA
an OKI AMERICA company

We put business on paper.

The OKIDATA model 2921 and 2931 printers have successfully passed compatibility testing with Symphony Release 1.1 and Release 1.2, 1-2-3 Release 2.0 and Release 2.01, and 1-2-3 Report Writer using an IBM Personal Computer with PC-DOS 3.1. Drivers for the appropriate OKIDATA printer must be installed. Work-done test conducted by OKIDATA. Documentation available upon request.
Registered Trademarks: OKIDATA, MICROLINE (U.S. Trademark), Oki America, Inc., Marque déposée de Oki America, Inc., Lotus, Lotus Development Corp.; IBM, International Business Machines Corp.; Epson, Epson Corp.
Rebate offer good from April 1 through June 30, 1987.



Inquiry 212



USE THE BRAINS YOUR IBM WASN'T BORN WITH.

Right at your fingertips in CompuServe's IBM® Forums.

In the **IBM New Users Forum** you'll swap ideas with other new PC users, learn to use Forum features, and pose even basic questions to PC experts.

Our **IBM Junior Forum** gives PCjr® users a reliable source for tips on software, hardware, telecommunications, games and other interests.

In the **IBM Software Forum** you'll trade tips with other IBM PC and AT users on utility software, word processing, DOS and other operating systems.

Visit the **IBM Communications Forum** for advice on the features and compatibility of communications software and hardware, PC Bulletin Boards, micro-mainframe interfaces and more.

The **IBM Hardware Forum** addresses hardware topics of all types, plus product updates and announcements.

Easy access to free software, including FREE uploads.

- Download first-rate, non-commercial user-supported software and utility programs.
- Upload your own programs free of connect time charges.
- Take advantage of CompuServe's inexpensive weeknight and weekend rates (when forums are most active, and standard online charges are just 10¢ per minute).
- Go online in most major metropolitan areas with a local phone call.
- And receive a **\$25.00 Introductory Usage Credit** with purchase of your CompuServe Subscription Kit.

Information you simply can't find anywhere else.

Use the *Forum Message Board* to send and receive electronic messages, and pose specific questions to other IBM and compatible owners.

Join ongoing, real-time discussions in a *Forum Conference*.

Search our unparalleled *Forum Data Libraries* for free software, user tips, transcripts of online conferences and more.

Enjoy other useful services like:

- **Popular Computer Magazines**—electronic editions, for your reading pleasure. Including *Dr. Dobb's Journal* and *Computer Language*.
- **Other CompuServe Forums**—supporting LOTUS® products like *Symphony™* and *1-2-3.™* Borland International®, Ashton-Tate®, Digital Research®, MicroPro®, Microsoft®, Software Publishing® and others.

All you need is your IBM or IBM-compatible computer and a modem ...or almost any other computer.

To buy your Subscription Kit, see your nearest computer dealer. Suggested retail price is \$39.95. To receive our free brochure, or to order direct, call 800-848-8199 (in Ohio, call 614-457-0802). If you're already a CompuServe subscriber, type GO IBMNET (the IBM Users Network) at any ! prompt to see what you've been missing.

CompuServe®

Information Services, P.O. Box 20212
5000 Arlington Centre Blvd., Columbus, Ohio 43220

800-848-8199

In Ohio, Call 614-457-0802
An H&R Block Company

Inquiry 63



Processor Wars

Bruce Webster

*Bruce's swan song
includes looks at the Mac II and
Professional Pascal*

Boy, when it rains, it pours. As I mentioned last month, the Access 386 showed up on my doorstep. A week or so later, an Apple IIGS appeared—the one that Apple had lent to BYTE. And a week after that, I found myself in Cupertino, looking at the latest generation of Macintoshes. Things are definitely heating up around here, and I'm scrambling to keep up on everything. This month, I've got my thoughts on the new Macs, some hands-on experience with a 386-based system, and a look at the best Pascal compiler I've ever seen, along with the usual odds and ends. So let's get started.

The Macintosh II

Sitting next to me is the June 1977 issue of BYTE, predating the issue you're holding by exactly 10 years. On pages 14 and 15 is an ad for the Apple II with the headline, "You've just run out of excuses for not owning a personal computer." I can close my eyes and remember just how badly I wanted that computer, but as an undergraduate student with a wife and child, I couldn't come up with the bucks. (I settled for an HP-67 calculator, which I still have.) And the price (over on page 17) was so incredibly low: A 48K-byte Apple II—without monitor, RF modulator, disk drives, or even a cassette tape deck—was just \$2638 (and that included free shipping and the famous brown vinyl Apple carrying case).

That 48K-byte Apple II came with 8K bytes of ROM, had a 40-character by 24-line uppercase-only text display, and included two graphics modes: low-resolution (40 by 48, 16 colors) and high-resolution (280 by 192, 6 colors, sort of). It was definitely hot stuff. Throw in two disk drives (140K bytes each) with a controller at \$890 and the famous Sup'r'Mod RF Modulator at \$29.95, and you're looking at a total system price of around \$3560.

It's now 1987, and the cost of that Apple II in today's dollars, adjusting for the inflation of the last 10 years, is about \$6800. What can \$6800 buy from Apple now? How about a Macintosh II with 1 megabyte of RAM, an 800K-byte disk drive, and a keyboard for \$3898. Add the following: a 3½-inch internal 800K-byte disk drive at \$299; a Mac internal 20SC hard disk at \$999; a Mac II video card (with expansion) at \$648; and a high-resolution RGB monitor at \$999. That's a grand total of \$6843.

For a little more than the price (adjusted for inflation) I would have paid in 1977 for that 48K-byte system, I can now get a Macintosh II with a 15.67-megahertz 68020 processor, 1 megabyte of RAM on a 32-bit data path, a 68881 floating-point coprocessor, 170K bytes of ROM (the rest of the 256K-byte ROM is empty), six NuBus expansion slots, two 800K-byte 3½-inch disk drives, a 20-megabyte internal hard disk, and a 640 by 480

RGB display with 256 colors out of a palette of more than 16 million colors.

Ten years do indeed make a difference.

What do I think of the Macintosh II? Hard to say, since I

have yet to spend any appreciable length of time working on one (and believe me, I hope to remedy that as soon as possible). But here are my thoughts, based on notes I took during my daylong visit to Apple and conversations I've had since the Mac II was officially announced.

My overall impression is that Apple did as many things right on the Macintosh II as they did wrong on the original Macintosh. The original Mac was a closed box with lots of drawbacks and arbitrary limitations. It was not designed to be easily or cheaply expanded (remember Apple's \$1000 upgrade to 512K bytes?), but it had insufficient resources to support the operating system and user interface built into it.

Yet there were some significant breakthroughs in that user interface, significant enough that everyone from IBM on down has tried to find ways to incorporate them in the systems they produce. The IBM PC may be the most widely copied piece of hardware, but the Mac user interface—despite the grumblings and over the protests of the "real men don't use icons" camp—is the user interface most manufacturers would love to have on their systems.

The Mac II has the best of both worlds. It has the Mac system software and user interface, but it also has the wide-open architecture of the Apple II and the IBM PC. In fact, the Mac II appears to be about as wide open as a box can get. Motherboard memory is expandable to (theoretically) 128 megabytes, if you assume that 16-megabit chips will ever be produced. You can also stick memory in the slots, getting up to 2 gigabytes there. I don't know that anyone will ever actually upgrade a Mac II that far, given the problems of chip density, cost, and air conditioning. On the other hand, the thought of upgrading an Apple II to 1 megabyte seemed ridiculous 10 years ago, especially in light of RAM prices (\$600 for 16K bytes). Yet I have 1.25 megabytes of RAM on the IIGS sitting over in the corner, using 256K-bit chips that currently cost less than \$3 each, meaning that you pay about \$25 per 256K bytes of RAM.

Third-party firms have leapt right into the open architecture. For example, AST announced a 4-megabyte expansion card, and National Semiconductor announced one that—with a motherboard/daughterboard combination—can hold up to 16

continued

Bruce Webster, a consulting editor for BYTE, can be reached c/o BYTE, P.O. Box 1910, Orem, UT 84057, or on BIX as bwebster.

Introducing

Quaid Analyzer

the tool
that created
CopyWrite

Now you can debug your own programs with a professional quality debugger - the one that unraveled every form of copy-protection used on the PC.

With the Quaid Analyzer, you can:

- See occurrences of any interrupt, with its meaning shown on the screen.
- View memory as text or instructions, scrolling as easily as you do with an editor.
- Run until a memory location or I/O port is changed.
- Protect your hard disk from accidental destruction.
- Analyze software without the source, even when it uses countermeasures to thwart tracing.
- See all stages of the boot load.

We kept the Quaid Analyzer off the market to avoid helping publishers with copy-protection. Now that copy-protection is gone, we can sell it to you.

The Quaid Analyzer is a software tool occupying 100K bytes. It runs on any IBM PC and most MS-DOS systems without hardware modification.



Call (416) 961-8243

Quaid Analyzer \$99 U.S.

All orders shipped at our expense within a day. All major credit cards accepted.

or return coupon to:
45 Charles St. East
Third Floor, Dept. 605
Toronto, Ontario. M4Y 1S2

Payment method MC-Visa-Amex-Diners-Check

Card No. _____

Expiry Date _____

Name _____

Address _____

City/State _____

Phone No. _____

Signature _____



Quaid Software Limited

Ask about Disk Explorer the program that takes over where Quaid Analyzer leaves off.

ACCORDING TO WEBSTER

megabytes. Setting aside one slot for the video interface, you could then expand your Mac II to 80 megabytes. Of course, that would cost you somewhere around \$21,000 for the chips alone, assuming you could get 1-megabit chips for \$30 a pop. But, hey, it's nice to know you could do it, right?

Could someone actually use 80 megabytes of RAM on a desktop computer? Yes. I have a friend, Jay Ekstrom, who specializes in building text-retrieval systems. One product he helped develop, EveryWord, has the entire King James version of the Bible in compressed format and will retrieve and display—very quickly—all verses containing a given word or set of words. He says that he'd love to have a computer with 50 to 100 megabytes of RAM on it, so that he can pull large amounts of text (20 to 40 megabytes) into memory for compression and index generation.

Of course, it'll be a while before anyone hangs more than, say, 10 or 20 megabytes on a Mac II, simply because the uses for that much memory have not been developed—yet. Also, too much RAM upsets the “golden triangle” of balance between processor power, memory, and mass storage. However, the growing capacity of hard disks (Apple is offering an internal 80-megabyte hard disk for the Mac II) and the advent of optical disk storage should restore things to balance.

Another bright move on Apple's part was removing the video hardware from the motherboard. Some of you may remember my criticizing IBM many months ago for having done the same thing on the IBM PC and may feel that I'm being hypocritical. But there's a big difference: IBM did not have QuickDraw in ROM. Also, it didn't have the Window Manager, or the Menu Manager, etc., etc., etc. For that matter, IBM didn't have much of anything in ROM, especially in the way of graphics: The result was that the third-party software companies had to decide which graphics standards to support—CGA, EGA, Hercules, and/or PGS—and then modify their code accordingly.

Not so on the Mac II. The enhanced version of QuickDraw—which includes true color support, not the rather primitive stuff in the original QuickDraw—lets developers not concern themselves too much about the exact resolution of the display. If you want to stick with Apple's video board, that's fine. If you want the 1024 by 768 RGB monitor and video card from SuperMac—which still gives you 256 colors out of 16 million—you can get that instead. And if you want the 1664 by 1200 LaserView monochrome display from Sigma Designs, you can go that route.

Most important: If you want all three on the same Mac II, working simultaneously, you can have it. In fact, you could hook up to six displays (one per slot) to the Mac II, and the displays will all work together, much as the Mac screen and the Radius FPD did (as I described last month). Ironically, this gives the Mac a capability that I used on the Apple II while developing software for it: running a text screen off an 80-column card while viewing color graphics via the composite video port. With two displays on a Mac, you can—in theory, I haven't done it yet—test and debug code on one monitor while viewing the output of that program on another.

Another plus: self-configuring expansion hardware. As on the Amiga, the Mac II requires cards for its slots to configure themselves. They can do this based on information actually given by the slots. I hadn't thought about this much until I tried to add RAM to the Access 386 machine; now I remember just what a pain hardware expansion can be. How many of you have had to wrestle with configuring multiple parallel ports on an IBM PC (or clone)?

Speaking of which, there's been a certain amount of hoopla over the third-party coprocessor boards for the Mac II (and Mac SE) allowing you to run MS-DOS software. Given the cheap

continued



USING THE WRONG LANGUAGE CAN BE MURDER. SPEAK SMALLTALK/V.



Let's talk languages. Programming languages like Turbo Pascal, C or Basic can be killers. To many, they're foreign, complex, and generally intimidating. Mistakes can be deadly.

With Smalltalk/V, you have an elegantly simple solution that puts the power and majesty of

a major AI programming language on your PC or compatible. It makes no difference if you're an experienced programmer or just getting started. Smalltalk/V gives you an easy-to-use and flexible programming tool.

This is the same language used by leading software companies for their new product development. There are sound reasons for this. Smalltalk/V offers a totally integrated programming environment using the premier object-oriented language. You use natural language rather than complex programming codes. It puts Macintosh-type graphic features on a PC including overlapping windows, bit-mapping, pop-up menus, and a mouse interface. More than mere window dressing, Smalltalk/V delivers fully interactive windows that are easy to build and quick to modify.

But don't just take our word on it. Hear what the experts have to say:

"This is the real thing folks. A super Smalltalk like this turns your PC into a hot workstation. It's fantastic... Highly recommended."

John Dvorak
Contributing Editor
PC Magazine

"The tutorial provides the best introduction to Smalltalk available."

Dr. Andrew Bernat
AI Expert Magazine

"Smalltalk/V is the highest performance object-oriented programming system available for PCs."

Dr. Piero Scarulli
Chief Scientist
Olivetti Artificial
Intelligence Center

Today, thousands of professionals, scientists and engineers are using Smalltalk/V to solve both simple and expert problems. Giving them a new dimension in computer applications for their PC.

Put new life into your PC by calling toll free 1-800-922-8255 and ordering Smalltalk/V today. Smalltalk/V by Digitalk, Inc., 9841 Airport Blvd., Los Angeles, CA 90045. (213) 645-1082.

\$99.95

Smalltalk/V comes with 10 starter applications including Prolog and each Application Pack adds several more. All source code is included. Supports 640 x 480 color graphics with color extension pack.

Smalltalk/V requires DOS and 512K RAM on IBM PC/AT/PS or compatibles and a CGA, EGA, Toshiba T3100, Hercules, or AT&T 6300 graphic controller. A Microsoft compatible mouse is recommended. Not copy protected.

Turbo Pascal is a trademark of Borland International. IBM, IBM PC/AT/PS are trademarks of International Business Machines Corporation. Macintosh is a trademark of Apple Computer, Inc.

TO ORDER CALL 1-800-922-8255 TODAY.

60-DAY MONEY-BACK GUARANTEE*
Send check, money order, or credit card information to: Digitalk, Inc., 9841 Airport Boulevard, Los Angeles, CA 90045.

Credit Card VISA Mastercard
Card number: _____
Expiration date: _____
Name: _____
City/State/Zip: _____

Smalltalk/V	\$99.95
RS-232 Communications Application Pack	\$49.95
EGA/VGA Color Extension Pack	\$49.95
"Goodies" Application Pack	\$49.95

SPECIAL OFFER:
Smalltalk/V and all 3 packs only \$199.95
Shipping and handling (Outside North America) \$15.00

California residents add applicable sales tax
TOTAL \$ _____

*Unconditional 60-day money-back guarantee. Simply return to Digitalk, Inc. and your refund will be immediately forwarded to you.



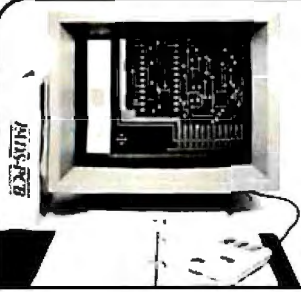

**350 Plus IC
High Performance
Printed Circuit
Board CAD
for
\$975.00!!**

All the features of Engineering Workstation CAD, on XT or AT Personal Computers—and at an affordable price!

- 1 mil data base, 32" x 32" area, up to 30 layers & 250-350 IC's
- Automatic and Interactive Placement aids, including Dynamic Rubberbanding, Connection Length Measurement, Auto Part Swapping, and other aids
- Interactive Routing on any grid from 1 mil upwards, i.e., 5, 10, 15, 20, 25, 50, etc. Thru, Blind and Buried Vias of Standard and Micro size. Filled tracks and pads at the CRT. Fine Line Design—2 tracks between IC's. Track Segment thickening. Angles at 90, 45 and 1 degree.
- Auto Routing (optional)
 - Auto Air Gap Checking
- 2-D Documentation capability
 - TTL/CMOS Library included
- Full SMD and Analog Board design supported
- Post Processing to matrix printer, wet ink plotter and Gerber (optional)
- Our many years of practical board design and CAD experience have created the board designer's IDEAL system—NOT a programmer's concept of what the designer needs!!

PADS-PCB \$975.00
Different options available
Demo disk with manual \$50.00

CAD Software, Inc.

P.O. Box 1142, Littleton, MA 01460 (617) 486-9521

price of MS-DOS clones, I don't see this as a large selling point; that is, I don't expect thousands of people to go out and buy a Mac II or Mac SE because they can then spend a thousand or two more to get it to run MS-DOS software. I do see it, however, as a way around the requirements at many corporations that their computers be able to run MS-DOS software.

What makes far more sense is the effort by Apple and third-party folks to facilitate data transfer between MS-DOS 5 1/4-inch disks and the Mac. All most folks want to do anyway is to copy their Lotus 1-2-3 files over to Excel, or their Word 3.0 files back and forth between the two machines. You're probably best off buying a cheap MS-DOS clone and the MS-DOS disk option for the Mac II (or SE). That way, you've got two different machines to use, but you can transfer information between them with relative ease.

Additional cheers have come from the Unix community over Apple's planned support of A/UX, a version of Unix for the Mac II. I am not an ardent supporter of Unix, but I suspect this option will open a lot of doors, especially in universities and scientific/engineering environments. As it currently stands, there will be little communication between the Mac OS and Unix, though I expect that to change. However, Unix will be able to access the ROM Toolbox routines, which again will give the Mac II a marketing edge over many other 68020-based workstations.

At this point in time, I have no real negative comments about the Mac II; that'll probably take some hands-on experience. My closest thing to a complaint is that the video-card approach to graphics tends to block page flipping, since the only graphics RAM is that on the card itself. I suspect, though, that some video cards will let you expand memory beyond what the corresponding display requires, so that you can have multiple screen images on a single card and quickly switch between them.

Some have said that the Mac II is what the Macintosh should have been three years ago. I disagree. The Mac Plus is what the original Mac should have been back in January 1984. The Mac II is what the Lisa should have been four years ago . . . except, of course, that neither the 68020 nor the 68881 was available back then. RAM was a lot more expensive, as were high-resolution RGB monitors. But the general architecture and approach are what the Lisa should have had; if that had been the case, this system might have been named the Lisa II.

(Somewhat off the subject: Do you think Apple will ever release a Mac III? Given the still-prevalent negative impressions of the Apple III, which ultimately—once the bugs were out—was an excellent machine, I doubt it. Maybe a Mac IIe, with a 68030 processor, but I don't think we'll ever see a Mac III.)

What does the Mac II compete against? Mostly the likes of DEC, Sun, Apollo, HP, and other firms that produce high-powered individual workstations. Most of those workstations start at \$10,000 and climb rapidly when you add little things like hard disks, extra memory, or color displays. But the Mac II has a critical advantage over these other systems: software. Hundreds of well-written, useful, and (most important) relatively inexpensive software packages for the Mac are on the market, and many (if not most) of them will run on the Mac II. Can you run Excel on a Sun 3? Or Helix on an Apollo? Or Word 3.0 on a MicroVAX?

The Macintosh II isn't a computer for the rest of us, any more than the Apple II was 10 years ago. It's a computer for pioneers, tinkers, hardware junkies with deep pockets, and power users who want to see just how far they can push the hardware and software. And because of its wide-open architecture, the Mac II is a computer that could easily be around in some form a decade from now. Even at its premium price, the Mac II will do well; I'm sure that Apple will sell as many as it can make for some

continued

ALL IN ONE

**RPTI-NET™ PC LAN Comes With
NETBIOS Emulator, Novell's NetWare
Driver.**



COMDEX
SPRING 87
BOOTH 4966

Configuration Specifications (IEEE802.3 Standard)

- * Protocol: CSMA/CD
- * Topology: Distributed Bus
- * Data Rate: 10 Mega Bits/Sec
- * Addressable Users: 1024 Maximum
- * Computer Interface: IBM PC/XT/AT and Compatibles
- * Cabling System: Ethernet Thick Cable (External Transceiver) or RG-58 A/U Coaxial Cable (Internal Transceiver)
- * Distance: Ethernet Thick Cable
2500 Meters (8250 Ft) with Repeater
RG-58 A/U Coaxial Cable
1500 Meters (5000 Ft) With Repeater
- * Operating Systems: PC/MS-DOS 3.1 or 3.2

Network Software System Supported

- * IBM PC Network Program (With On-board NETBIOS Emulator)
- * Novell's Advanced NetWare 86/286/SFT (With Advanced RPTI-NET's NetWare Driver)
- * RPTI-NET Network Utilities
- * RPTI-NET Disk Server
- * RPTI-NET Classroom/Screen Monitor

R.P.T. INTERGROUPS INTERNATIONAL LTD.
2nd Fl., No. 280, Sec. 4, Chung Hsiao E. Rd., Taipei Taiwan, R.O.C.
Telex: 12219 RPTI Cable: "RPTI" Taipei
Fax: 886-2-7412946 Tel: 886-2-7713366 (20 lines)

U.S.A. DISTRIBUTOR: BROADTECH CORP.
TEL: (714) 773-1820 FAX: (714) 773-5554

IBM PC/XT/AT, PC Network Program, MS-DOS, Advanced NetWare are trademarks of IBM Corp., Microsoft Corp., Novell, Inc.

It's ironic. These days, modems bring the world to you at the speed of light. But for all their awesome speed and power, these high-performance machines just sit there on your desk like a low-tech toaster.

But now, we're introducing the Migent Pocket Modem. It's 100% Hayes-compatible, so it works with virtually any PC: IBM, Apple, or whatever. It runs at both 300 and 1200 bps. It has a full set of Hayes AT commands. A 28-character non-volatile memory. Remote ring and tone sensing. Busy and dial tone monitoring. And even dual phone jacks.

But that's where all similarities end. The whole modem is smaller than a 3" x 5" card and works on a 9 volt battery or AC power. So you can put it in your shirt pocket or briefcase, and take it home, on the road, or anywhere else you need your PC.

The Migent Pocket Modem. If you'd like to know more, send in this coupon or call **800-633-3444**, Dept. 303, and ask for Alexis. We'll send you full information and the name of your nearest dealer. But in the meantime, you may be wondering why this modem isn't beige like the rest. Because we think it's about time a high-powered information machine looked like one.

Please send me more information about the Migent Pocket Modem. And send me the name of the dealer in my area.

NAME _____

ADDRESS _____

CITY _____

STATE _____

ZIP _____

PHONE _____

MIGENTTM

Send to: Migent, Inc., 865 Tahoe Blvd., Call Box 6, Dept. 303, Incline Village, Nevada 89450-6062. Attn: Alexis

Registered trademarks: Apple, Apple Computer; Hayes, Hayes Microcomputer Products; IBM, International Business Machines. Trademark: Pocket Modem, Migent.

Inquiry 354 for End-Users. Inquiry 355 for DEALERS ONLY.



THE MIGENT POCKET MODEM.TM
A STATE-OF-THE-ART INFORMATION MACHINE THAT LOOKS LIKE ONE.

IF YOU STILL USE PAPER FORMS TRY FORMMANAGER II!

Name: John Smith Date: 07-15-86
 Address: 111 Board Way
 City: San Francisco
 State: CA Zip: 94111

Prod No	Description	Price	QTY	Total
122-333-33	Gadget	10	100	100000
233-33-33	What is that	1	40	4000
				104000

Data file: C:\pfr.dat F1 Help Page 1 of 1 Record # 12

MEET FORMMANAGER II. It can help automate your paper office. More than a data manager, FormManager II lets you generate forms and organize them easily. You simply lay out your forms on the screen and fill in the data. FormManager II can calculate the tax due, total amount or even set up conditional calculations. More than 26 mathematical functions are included.

FormManager II can print on pre-printed forms or just print on any plain paper. With a laser printer, you can even use different fonts on the same page.

HERE ARE SOME HIGHLIGHTS:

- Generate or use dBase III™ data files.
- Lay out forms on the screen with Forms Editor.
- Use the cursor keys to move from field to field.
- Fill in data easily with error checking.
- Print on pre-printed forms.
- Print on any plain paper with lines and boxes.
- Sort, search and modify any data records easily.
- Do complex calculation or even conditional statements.
- Report writer summarizes all your records.

ONLY \$99

Attention, MS FORTRAN, PASCAL, C Programmers, Forms Designer programming tool can save you time and effort producing professional screen forms. Don't struggle with the formatted I/O for screen data entry. Just use our Forms Editor to lay out the forms and call our library routines to do the job.

Comes with Forms Editor, runtime library, sample programs and library source code for PASCAL and C.

Only **\$275.**

To Order Call 408-263-2197

bit BIT Software, Inc.
 P.O. Box 360619
 Milpitas, CA 95035

dBase III is a trademark of Ashton-Tate, Inc.
 FormManager and Forms Designer are trademarks of BIT Software, Inc.

ACCORDING TO WEBSTER

time to come. Perhaps the highest accolade I can give it is this: The next computer I pay for out of my own pocket will almost certainly be a Mac II.

The Macintosh SE

The Macintosh SE is the Mac Plus completely redesigned. The only thing the same is the CRT. The case has roughly the same design, but with a number of changes. The motherboard has been redesigned. One PAL chip takes the place of 19 chips; and an expansion "slot" (pin-out, actually) eliminates the gymnastics that third-party hardware manufacturers have had to go through to expand the Mac Plus. There's room enough inside for two 800K-byte drives, or an 800K-byte drive and a 3 1/2-inch hard disk. ROM has been expanded to 256K bytes, though only about 170K bytes is actually being used now.

The Mac SE is a good addition to the Macintosh line, especially given the hot sales of the Mac Plus over the past 6 to 8 months. It gives a more open architecture to those who want it, without the heavy investment in hardware that a Mac II requires. And it still has the small footprint of the original Macintosh. I foresee the Mac Plus dropping in price and the Mac SE selling heavily into the current Mac Plus market.

It's hard for me to get terribly excited about the Mac SE. It's a good machine and represents the next logical filler between the Mac Plus and the Mac II. But I wouldn't buy a Mac SE. Not that there's anything wrong with it; I'd just rather save my pennies and aim for a Mac II, to get something that I can be using and that will still be selling years from now.

The Access 386

I feel funny talking about the Access 386. I've used this system—in fact, I'm using it to type these very words—for more than a month, and yet I don't have a whole lot to say about it except for this: I'm going to hate to see it leave.

What is it? Well, it's a fairly large system that has a 16-MHz 80386 processor, 640K bytes of RAM, a 30-megabyte hard disk, a 1.2-megabyte floppy disk drive, a high-resolution color monitor with EGA board, a RAM expansion board, and enough parallel and serial ports to choke a switch box. The 386 uses a full 32-bit data bus, and the whole system screams along. It's a big change from my previous MS-DOS system: a Compaq portable (the original model), with two 360K-byte drives, 640K bytes of RAM, and a 4.77-MHz 8088.

How does it perform? Table 1 shows some simple bench-
continued

Table 1: Timings for Turbo Pascal running on an Access 386 system (16.57-MHz 80386) and a Compaq portable (4.77-MHz 8088). The Sieve test executes 50 iterations of the Sieve of Eratosthenes; the Sort benchmark initializes and sorts a list of 10 names 500 times; the IMAT benchmark multiplies two 50 by 50 integer matrices; the RMAT test multiplies two 50 by 50 real matrices; and the Reals test performs floating-point arithmetic in a loop. (All times are in seconds.)

Test	Access 386 System		Compaq Portable	
	compile time	run time	compile time	run time
Sieve	0.8	7.8	4.3	70.2
Sort	0.9	16.2	5.0	117.9
IMAT	0.9	3.5	4.4	38.2
RMAT	1.0	9.7	4.9	86.5
Reals	0.8	9.4	3.9	67.6

Get a new handle on your business with SBT.



Now you can handle up to 254 users, all working in the same data files, with the SBT MultiNet Database Accounting Library. The accounting software written in dBASE III PLUS.

So whether your business is large or small, you can grow to the limits of the most advanced PC networks available.

When you want that special report, or your business needs something we didn't think of, you can quickly and easily modify our programs to meet your needs exactly (because our dBASE source code is included **absolutely free**).

And if you don't have time to make the changes yourself, there's a nearby consultant who can make them for you.

So if your company has two users or two hundred and fifty, you can add customers, update records, and have as many people enter orders as it takes to keep your business growing.

Isn't it nice to know there's software you can't outgrow? The SBT MultiNet Database Accounting Library.

Now you can get a new handle on your business.

Call today for our demo disk and brochure.

THE SBT DATABASE ACCOUNTING LIBRARY.

dProfessional	Time & Billing	\$395
dOrders	Sales Order Processing	\$295
dInvoice	Billing/Inventory Control	\$295
dStatements	Accounts Receivable	\$100
dPurchase	Purchase Order	\$295
dPayables	Accounts Payable	\$395
dPayroll	Payroll/Labor	\$395
dLedger	General Ledger/Finance	\$395
dAssets	Asset/Depreciation	\$295
dProject	Project/Job Accounting	\$395
dProperty	Tenant/Unit Management	\$395
dMaterials	Material Requirements	\$395
dMenu/Backup	Menu/Backup	\$ 65

MultiNet versions \$200 additional per module

Call today for the name of the SBT consultant in your area.

One Harbor Drive
Sausalito, CA 94965 (415) 331-9900
Telex 9102404708



EE DESIGNER™
CAECAD Integrated Software Package for
IBM PC, XT or AT

\$975

At only \$975, no electrical engineer can afford to be without this end-to-end circuit design, simulation and PCB layout tool. You can pay up to 15 times more and still not get all the features offered by EE Designer—Schematic Capture... Circuit Simulation... PCB Layout. 30 day money back guarantee. Full purchase price refunded if not completely satisfied. Call 1-800-553-1177 today to order your package. Bank cards welcome.

VISIONICS CORPORATION
343 Gibraltar Drive
Sunnyvale, CA 94089

marks run on two machines: a Compaq portable (4.77-MHz 8088) and the Access 386. This is exactly the same object code in both cases. As you can see, there's a fair difference in speed between the systems . . . on the order of 5 to 10 times.

That speedup appears in using applications as well. Word processing is great, as is spelling checking. Program development with systems like Personal Pascal and Microsoft C becomes painless, despite large library files and multiple-pass compilers. Everything performs faster, and significantly so. It's much like switching from a regular Macintosh to a Levco Prodigy 4 (or a Mac II).

This is my first time using an EGA display . . . and I like it. The text is crisp and clear, and yet I can get high-quality graphics on it. The 43-line display option worked fine with CodeView but wouldn't work with the version of Brief I have; I don't know exactly where the problem is.

Unfortunately, the documentation is poor: sketchy, incomplete, wrong in many places, with too many spelling and punctuation errors. As I said, this is definitely not a system for the novice.

All in all, despite the high performance, this system—at least the one I got—is still a little undercooked. In fact, I suspect this unit is not an "off-the-shelf" system, but one of the early models that still has a few bugs in it. Like the problem with the memory card . . .

RAM in the Thick of It

I don't know why I tend to start projects like this around midnight, when my chances of getting any kind of technical help are at best slim. You see, my former wife got her Macintosh (our old, original, 3-year-old Mac that we bought three weeks after Apple announced it) upgraded to a Mac Plus, and in the process, I got back the Levco Monster Mac upgrade we had purchased a few years ago. The Levco upgrade was also an oldie—a beta version, in fact, that had been soldered into the motherboard—and I didn't figure it was worth much on the open market. I knew Apple wouldn't want me to install it in the Mac Plus I have on loan from them, so I decided to cannibalize it for RAM. After all, it had 1.5 megabytes of 256K-bit chips on it.

My first upgrade target was actually the IIGS. The IIGS RAM expansion card that Apple had included had only 256K bytes of RAM on it, so I quickly filled it up to a full megabyte (giving the whole system 1.25 megabytes). That upgrade was quick, easy, and best of all it worked, letting me set up a large RAM disk.

Since I still had 0.75 megabyte of RAM left, I decided to do the same to the Access 386. The Access comes with a RAM card named the Challenger. The Challenger can hold up to 2 megabytes (using 256K-bit chips); with a special daughterboard, it can double that. And since the Access 386 is set up to handle two Challengers, you could (in theory) get 8.5 megabytes of RAM on the system (the main system motherboard comes with 512K bytes).

I had been a little disappointed when I saw at boot-up that the Access had only 640K bytes of memory. So when I got the Levco board back, I decided to move some RAM over to beef things up a little. Getting into the machine was a bit tedious, if not particularly difficult: putting the monitor on the floor, unplugging enough cables to swing the back panel around, removing five screws, sliding the whole case forward. There were just three cards in the slots: the floppy/hard disk controller, the EGA (a custom version from Advanced Logic Research), and the Challenger. It took just a few seconds more to unfasten the card and extract it from its slot.

Mistake #1: Before I started messing with the RAM card, I neglected to write down the current DIP-switch settings. There

continued

**SUPERIOR PRICE/
PERFORMANCE VERSION**

OPC, a leading manufacturer of Computers & Telecommunication equipments in Korea, the best to meet any customer's needs. We export CRT Display Terminal, Hard Disk Drives, Key-Phone System on an OEM basis.



OPC Oriental Precision Company Ltd

HEAD OFFICE
SUNNYVALE OFFICE
TOKYO OFFICE

MICROMINT'S Gold Standard in Single Board Computers & Controllers

SB180FX — \$409.00 Single Board Computer

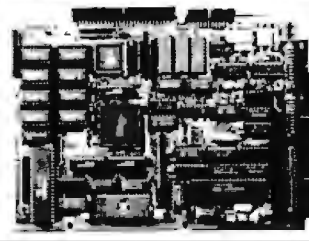

- SB180FX TECHNICAL SPECIFICATIONS**
- 6MHz 64180 CPU in a 60pin IC package
 - Separate 2nd instruction set
 - Interrupt Acknowledgment timer
 - 16K Bytes of RAM w/ refresh
 - 2 channel DMA Memory Access Controller
 - 2 channel asynchronous Serial Communication Interface
 - 2 channel 16-bit programmable timer
 - 12 interrupts
 - Dual bus interface to RAM and ROM
 - 144 MHz 9214Mbit and 128Kbit system operation
 - 128Kbit dynamic RAM onboard
 - Memory externally expandable to a 1Mbyte RAM
 - 512Kbit 28K 9214 128K 9214 512K 9214 1Mbit 28K 512K 9214 1Mbit
 - Full function ROM BIOS
- SOFTWARE COMPATIBILITY**
- IBM PC, XT, AT
 - DOS 2.00, 3.00, 3.10
 - CP/M 2.2, 3.0
 - MS-DOS 2.00, 3.00

SB180FX-1 SB180FX - 6.144 MHz computer board populated w/ 256K bytes RAM, 8K byte ROM monitor, without SCSI chip. Add \$50.00 for 9 MHz \$409.00

SB180FX-1A-30 SB180FX-1A computer board. System software including DOS, CP/M, and ROM monitor sources, and BIOS for SCSI hard disk. Stepped on five 5/8" 5.25" format 5.25" disks \$599.00

SB180 — \$299.00 Single Board Computer

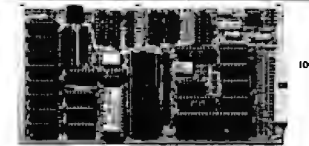

OEM
100 QUANTITY
PRICE
\$195.00

- FEATURES**
- 6MHz 64180 CPU (260 instruction supersets), 256K RAM, 8K monitor ROM with device test, disk format, read header
 - Mini/Micro floppy controller (1.44, 5.25, 8" drives), single/double density, 1/2 sided, 401780 track 5 1/4", 5 1/4", and 8" drives)
 - Measures 4" x 7 1/4", with mounting holes
 - One Centronics printer port
 - Two RS232C serial ports (175-19200 baud with console port, auto baud rate select)
 - Multiple disk formats supported
 - Menu-based system reconfiguration
 - Speed upgrade to 9.216 MHz available

SB180-1 SB180 - 6.144 MHz single board computer w/256K bytes RAM and ROM monitor. Add \$50.00 for 9 MHz \$299.00

SB180-1-20 Same as above w/CP/M, DOS, BIOS and ROM sources \$399.00

COMMB180-5 SCSI Hard Disk Interface \$150.00

GT180 — \$395.00 Graphics Display System

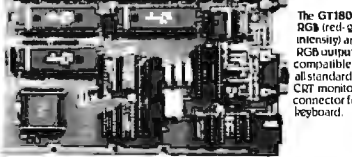

The GT180 has both TTL RGB (red-green-blue intensity) and analog RGB outputs, is totally compatible with virtually all standard and multiscan CRT monitors, and has a connector for an IBM PC keyboard.

- The GT180 offers these features:
- Advanced graphics controller provides intelligent link between computer and user
 - Only 3 1/2" x 8" - plugs back on either an SB180 or SB180FX computer
 - High resolution at a low cost: 640 x 480 with 16 of 4096 colors
 - Hardware drawing commands: LINE, RECTANGLE, POINT, POLY, POLYGON, CIRCLE, ELLIPSE, ARC, FILL, RECTANGLE, PAT. T, PATTERN, WINDOW, and COPY to name but a few
 - Automatic translation of logical X-Y coordinates to physical frame buffer addresses
 - Fast drawing speed of 2 million pixels per second
 - Provides full program table: horizontal/vertical screen and window screen
 - Fully supported by GT180 Graphics Toolbox written in Modula-2

GT180-1 Graphic Display Expansion Board (TTL RGB only) \$395.00

GT180-2 Graphic Display Expansion Board (TTL RGB and Analog RGB) \$449.00

SB180 Software and Accessories

- SB180-U Uniform Disk Format Conversion Software \$ 69.95
- SB180-MOD1 Turbo Modula 2 \$ 69.00
- SB180-MOD2 Turbo Modula 2 w/Graphic Toolbox \$ 89.00
- SB180-CASE Four half height 5 1/4" drive enclosure w/ power supply mounting brackets and hardware for the SB180 or SB180FX \$197.00
- SB180-CABLE Set of 4 cables for keyboard, timer, disk and printer \$ 79.00

BCC52 — \$199.00 BASIC 92 Computer/Controller

The MICROMINT BCC52 Computer/Controller is a stand-alone single board microcomputer which needs only a power supply and terminal to become a complete system programmable in BASIC or machine language. The BCC52 uses the Intel 8092AH BASIC microprocessor which contains a ROM resident 8K byte floating point BASIC interpreter. It contains sockets for up to 48K bytes of RAM/EPROM, an "intelligent" 2704/28 EPROM programmer, 3 parallel ports, a serial terminal port with auto baud rate selection, a serial printer port.

BCC52* Basic 92 Computer/Controller \$199.00

OEM 100 QUANTITY PRICE: \$148.00

*NOW AVAILABLE IN INDUSTRIAL TEMPERATURE RANGE - CALL FOR INFORMATION

BCC25 & BCC53 LCD & Multi Function Expansion Board

The MICROMINT BCC53 expansion board provides the user with up to 64K bytes of memory expansion, 8 additional 8 bit parallel I/O ports, and a 60 Hz crystal controlled time base. The BCC53 is bus compatible with the entire line of MICROMINT BASIC language controllers.

BCC53 Multi Function Expansion Board w/8K \$160.00

The Micromint BCC25 LCD Accessory Board adds a 4 x 80 or 8 x 10 LCD graphics or alphanumeric display and parallel ASCII keyboard to a BCC52 system.

- BCC25-4 4 x 80 LCD \$159.00
- BCC25-8 8 x 40 LCD \$229.00
- BCC22K Parallel encoded ASCII keyboard \$ 79.00

BCC11 Basic Controller



- Features:**
- Uses 28 single chip microcomputer
 - On board tiny basic interpreter
 - 2 on board parallel ports & serial port
 - 6 interrupts (4 external)
 - Just connect a CRT and write control programs in Basic
 - 6K Bytes of RAM or EPROM memory on board
 - Baud rates: 10-9600 bps
 - Data and address bus available for 56K memory and I/O expansion
 - Consumes only 1.5 watts at +5, +12 & -10V

BCC11* BASIC System Controller \$159.00

*NOW AVAILABLE IN INDUSTRIAL TEMPERATURE RANGE - CALL FOR INFORMATION

BCC40 Smartpower I/O Expansion Board

The MICROMINT BCC40 SMARTPOWER I/O Expansion Board provides on/off control and monitoring of eight 115-230 VAC or 5-18VDC lines up to 16 SMARTPOWER I/O boards may be used in a system for a total of 64 inputs and 64 outputs.

BCC40 SMARTPOWER I/O Expansion Board (with no power modules) \$ 159.00

BCC40/OUT SMARTPOWER BOARD w/8 Output Modules (specify AC or DC) \$ 249.00

BCC40/IN SMARTPOWER BOARD w/8 Input Modules (specify AC or DC) \$ 229.00

Auto refresh, change of state interrupt, and Real Time Clock functions provided with BCC52/41

BCC13 & BCC30 A/D Converters

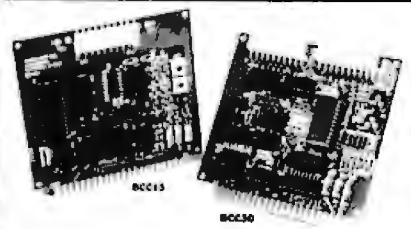

MICROMINT'S BCC13 is an eight channel 8 bit A/D board designed for unipolar (0 to 10 vdc) or bipolar (-5 to +5 volts) analog signals and converts data at 10,000 samples per second.

BCC13 8 Bit, 8 channel A/D Board \$129.00

MICROMINT'S BCC30 is an 8 channel differential or 16 channel single ended 12 bit plus sign A/D Converter Board for signals in a bipolar range of -5 to +5 volts converted at up to 10,000 samples per second.

BCC30 12 Bit, 16 channel A/D Board \$197.00

BCC08 & BCC09 I/O Expansion & RS232 Converter

BCC08 Serial I/O Expansion Board \$149.00

BCC09 RS-232 to 28pin Converter \$55.00

BCC52 & BCC11 Software and Accessories

- BCC52-ROM A ROM A Utilities-BASIC extensions \$ 49.95
- BCC52-ROM B ROM B and Utilities \$100.00
- BCC52/41 BASIC extensions and Assembler \$ 54.00
- BCC52-CLK-CLK SMARTIME BCC52 Clock and ROM C \$ 69.00
- BCC52-BK-CLK SMARTIME BCC52 Clock w/8K RAM and ROM C \$ 79.00

MOTHER BOARDS

- MB02 5 Slot mini-mother board (not compatible with CCG, CCG9) \$69.00
- MB06 6 Slot full mother board (compatible with CCG/CCG9) \$85.00
- MB44 4 pin gold card edge connector \$6.00

CARD CAGES

- CC01 10 Inch Card Cage for one MB06 \$59.00
- CC09 10 Inch Card Cage for two MB06 \$79.00

POWER SUPPLIES

- UPS11 Universal Heavy Supply—used for single board applications \$A @ 5V, 3A @ +12V and 1A @ -5V \$19.00
- UPS03 Standard Power Supply—designed for 2 or 3 board application \$A @ 5V, 3A @ +12V, 1A @ -12V \$60.00
- UPS05 Heavy Duty Switching Power Supply—designed for a 2 or 3 board system \$A @ 5V, 3A @ +12V, 1A @ -12V \$79.00
- UPS10 Heavy Duty Switching Power Supply—used for an entire BCC system \$A @ 5V, 7A @ +12V, 3A @ -12V \$69.00
- UPS21 550 Watt Interlocking Power Supply—used for EPROM programming on the BCC52 \$19.00 +1¢ @ 2¢ @ 3¢ @ 4¢

BCC22 Term-Mite Smart Terminal



Why pay \$500 or more for a smart terminal? The TERM-MITE ST offers you all of the following on a single board (less than 1/2 the price):

- Dimensions 4" x 6 1/2"
- 128 displayable characters
- 24 lines x 80 characters
- Separate transmit & receiver baud rates (10-19,200bps)
- CRT refresh at 50-60 Hz
- Supports scanned and encoded keyboards
- 11 Graphic characters
- 25th line reverse video status display
- 21 escape functions
- 11 control functions
- Directly drives composite video or separated sync monitor
- All functions are firmware controlled. Source code available

EDITING FEATURES: typeover, clear to screen to space or null, erase to end of page, erase to end of line, absolute cursor addressing

VIDEO ATTRIBUTES: reverse video, blinkiness, double height, double width, underline, blink and blank characters

BUS CONFIGURATION: MICROMINT BCC compatible or no bus connection necessary for stand-alone operation with parallel keyboard.

BCC22 TERM-MITE Smart Terminal Board \$99.00

PARALLEL Encoded ASCII Keyboard \$ 79.00



To order call
1-800-635-3355

for technical information 1-(203)-871-6170
TELEX: 643331

Micromint, Inc.
4 Park Street
Vernon, CT 06066



AT LAST: Professional Typesetting Capability For PC Users

With **PC \TeX** [™] the best-selling full implementation of Professor Don Knuth's revolutionary typesetting program **\TeX** .

FINEST Typeset Quality Printing From:
dot matrix laser phototypesetter

$$\sum_{i=1}^{\infty} \frac{1}{i} \begin{pmatrix} a_{11} & \dots & a_{1n} \\ a_{21} & \dots & a_{2n} \\ \vdots & \ddots & \vdots \\ a_{m1} & \dots & a_{mn} \end{pmatrix} \int_{-\infty}^{\infty} e^{-x^2} dz$$

WIDEST Range Of Output Device Drivers:

- Epson FX, LQ
- HP LaserJet*
- Toshiba
- Apple LaserWriter
- Corona LP-300*
- APS-5 phototypesetter
- Screen preview, with EGA or Hercules card

MOST COMPLETE Product Offering:

PC \TeX (not copy protected) includes the following:

- Our specially written *PC \TeX Manual*, which enables you to start using \TeX right away.
- Custom "macro packages" that provide formats for letters, manuals, technical documents, etc.
- The \LaTeX document preparation system, a full-featured macro package for preparing articles, books, reports, etc., and \LaTeX User's Manual.
- $\AMS\text{-}\TeX$, developed by the *Amer. Math. Society* for professional mathematical typesetting.

Site licenses, volume discounts, and interfaces to PC Paintbrush, PC Palette, FancyFont and Fontrix are also available.

PRICED FROM ONLY \$249.00!

(Printer drivers and interfaces additional.)

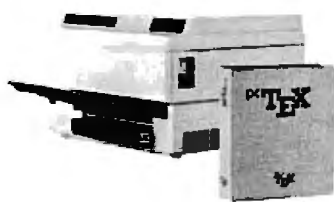

Laser printer,
fonts & software
from \$2995.00

For IBM PC/XT, AT or compatible, DOS 2.0 or higher, and 512K RAM. Hard disk required for printer drivers and fonts.
*HP LaserJet and Corona require additional interface boards.

For more information call or write:

Personal \TeX , Inc.

12 Madrona Avenue, Mill Valley, CA 94941 (415) 388-8853

This ad, with space for the photograph, produced by PC \TeX . Typeset on the Epson FX80, the Corona LP-300 laser printer, and the Autologic APS-5 phototypesetter.

\TeX is a trademark of the American Mathematical Society. Manufacturers' product names are trademarks of individual manufacturers.

ACCORDING TO WEBSTER

was already one bank of RAM in it (512K bytes, according to the manual), so I started removing chips from the old Levco board and carefully inserted them in bank #2 of the Challenger, doing a pretty good job of avoiding the bent pin syndrome.

I got all 18 chips in (512K bytes of RAM with parity checking), set the DIP switches on the card according to the book, put things back together, plugged the power cable back in, and powered up. I got a message from the system that the memory configuration it remembered (in battery-backed RAM) wasn't the same as it was reading in. Fine, I thought, that makes sense; and so I changed it and rebooted. Same problem still. Made a few other changes. Same problem.

After a stretch of this, I went back through the manual carefully and found a section about jumpers on the motherboard. Sure enough, there was one that I had to switch. I did so. Still the same problem. I went back, double-checked the docs, and found a loose-leaf update of that section, with new switch settings for the Challenger. I changed the DIP switches, put things together again, and rebooted. Same problem.

I spent the next hour or two trying out different combinations of switches. None of them worked. For that matter, I couldn't even get back to the 640K-byte setting I had; the system was recognizing only the 512K bytes on the motherboard.

It was somewhere around here that I realized mistake #2: I hadn't looked closely at the first bank of RAM. Instead of having 256K-bit chips (as the manual claimed), it had 64K-bit chips. A light went on. That's why the Access (prior to my expansion) had only 640K bytes—512K bytes on the motherboard and 128K bytes on the Challenger. There was undoubtedly a DIP-switch setting for 64K-bit chips, but it was certainly not any of the ones I had been using.

Next step: I carefully removed the 64K-bit chips and moved the 256K-bit chips down to bank #1. I now went back and tried the various combinations of jumpers and switch settings. No success. So I finally pulled all my 256K-bit chips and put the 64K-bit chips back in . . . at which point I realized mistake #1. My memory of how the switches had been set before I started was obviously faulty, since I couldn't get back to the 640K-byte system I had before I started. It ultimately took a call to Advanced Logic Research to get things straightened out. Moral: If you're going to use the cutting edge of technology, you might get bloodied in the process.

Product of the Month: Professional Pascal

So you've got an 80386-based system, and you want to write some programs for it. What are you going to use? You could use any of the regular MS-DOS compilers available, but they're not going to make any use of the 386's extended instruction set or, more important, extended addressing. What's a programmer to do?

Enter Professional Pascal from MetaWare. The name is appropriate: This is possibly the most professional Pascal compiler I've ever seen. The language has been heavily extended, and in all the right ways. Yes, it does fully support the ANSI standard, but it doesn't stop there. One of MetaWare's advertising blurbs says they're "halfway to Ada," and I like the half they chose.

First off, Professional Pascal completely implements the ANSI standard for Pascal. In fact, you can use a compiler directive to turn off all non-ANSI extensions, so that you have an exact implementation of ANSI-standard Pascal. I don't know why you'd want to do a foolish thing like that; perhaps it's good to have just in case. But you'll probably want the extensions.

Oh, the extensions. As many of you know, I'm a fan of Pascal. It was not my first language—I learned it about 7 years ago, after having programmed in a number of other languages—but

continued

LIGHTFAX 96

COMDEX/Spring '87

June 1-4, 1987
Georgia World Congress Center
Atlanta, GA West Hall Booth 2845

Let your PC talk to 2 millions Facsimile machines around the world

- An interface card that turns your IBM PC, XT, AT or compatibles into Image Communication System.
- It transmits ASCII, Graphics or ASCII + Graphics files directly from your PC.
- It can operate in BACKGROUND Auto-stores incoming FAX.
- The receiving Fax images can be converted into ASCII files by using OCR software.
- Extra scanner port for you to read images or scan other files.
- Compatible with the popular HP LaserJet, LaserJet+, Cordata LP 300, 300X, laser printer, or the low cost Epson FX series dot-matrix printers or compatibles.
- The JOURNAL records in details in DATE, TIME, DURATION, PAGES, RESULT (OK or Fail) to monitor day by day activity for both transmitting and receiving.
- Intelligent Data/Voice switching to hold conversations between fax transmissions.
- LIGHTFAX command set for third party software developers to create special applications.
- Auto calling to take the advantage of late-night or holiday discount phone rates.

LIGHTFAX-96S

(Stand alone version with RS232 interface).

- It has same great features as LIGHTFAX 96 with RS 232 interface.
- The size is so small it can fit inside of your suitcase.
- Compatible with most of the Personal Computer equipped with RS 232 port, such as IBM PC, XT, AT, Macintosh, Macintosh Plus or Portable Computers from IBM, Compaq, Zenith.. etc..

MODEM

FEATURES	MODELS	1200	*1200H	1200C	*1200HC	2400	*2400B	2400C	*2400BC
Auto-dial, auto-answer		*	*	*	*	*	*	*	*
Auto-speed selection		*	*	*	*	*	*	*	*
Call progress detection		*	*	*	*	*	*	*	*
Adaptive dialing		*	*	*	*	*	*	*	*
Latest Hayes AT command set		*	*	*	*	*	*	*	*
2 year warranty		*	*	*	*	*	*	*	*
Volume control-external switch		*	*	*	*	*	*	*	*
User friendly 'help' menu		*	*	*	*	*	*	*	*
CCITT V.23				*	*	*	*	*	*
CCITT V.22 bis				*	*	*	*	*	*
CCITT V.22		*	*	*	*	*	*	*	*
CCITT V.21		*	*	*	*	*	*	*	*
Bell 103/212A		*	*	*	*	*	*	*	*
Automatic selection between Bell and CCITT		*	*	*	*	*	*	*	*
Automatic data/voice switching		*	*	*	*	*	*	*	*
Manual data/voice switching				*	*	*	*	*	*
Synchronous operation				*	*	*	*	*	*
Auto fall back				*	*	*	*	*	*
2 sets of 33 digits stored phone number				*	*	*	*	*	*

*: Internal modem card for IBM PC.XT.AT.



LIGHTSPEED TECHNOLOGY INC.

8/F-10, No. 746, Min Shen E. Rd., Taipei 10580, Taiwan, R.O.C.
Tel: (02) 713-4586. Telex: 14217 LIGHTSPD. Fax: (02) 716-1024.
Bulletin Board: 886-2-7161147 (300, 1200, 2400 bps 8 bit φ parity).

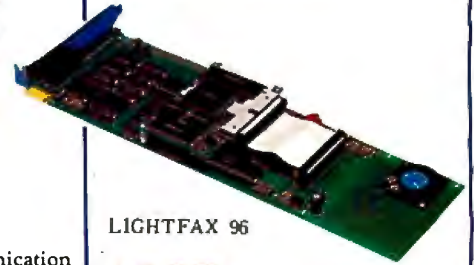

LIGHTFAX 96

\$995

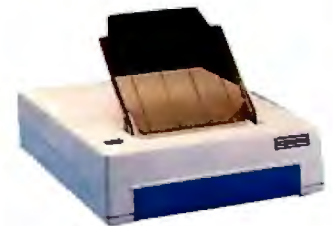

LIGHTFAX 96 WITH LIGHTSCAN 200C (64 GREY LEVEL)

\$2095



SOUTH AFRICA
TRENCOMP
TEL: (011)786-2706

DENMARK
SEI-IMPORT
TEL: (08) 139611

ITALY
MAGNETO PLAST S.R.L.
TEL: (045) 504491

SINGAPORE & MALAYSIA
OHIO SCIENTIFIC COMPUTERS
TEL: (65) 2939700 / 2923308

THAILAND
OFFICE & DATA PRODUCTS CO., LTD.
TEL: 235-9020

SWEDEN
TAD GRUBER CONSULTING AB
TEL: (46) 08-85 46 59

USA
TEL: (714) 891-7218

CANADA
PATCH COMPUTERS
TEL: (604) 2734408

JAPAN
SHOWA SYSTEM LABORATORY CO., LTD.
TEL: (03) 361 7131

WEST GERMANY
MICRO PRODUCTS INTERNATIONAL
TEL: 49-241-59031

NETHERLANDS
MAC-GG
TEL: (31)2159-19922

NEW

EGA2001

- 640 x 480
- 132 COLUMNS
- HERCULES® ON EGA
- AUTO SWITCHING !
- TERMINAL EMULATION SUPPORT

LIST

\$369

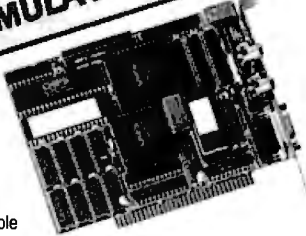

- Hercules Mode on EGA/CGA Monitor
- 100% CGA (Color Graphics) Compatible
- 100% EGA Compatible
- 640 x 480 High Resolution Graphics
 - Windows®, AUTOCAD® Drivers Available
- 132 x 25/44 on Mono/EGA Monitor
 - Lotus 123® Drivers Available
- Absolutely NO Game Mode Diskette Required
- VT100, VT220 & Tektronix Emulation Support
- 256 KB Display RAM ■ FCC Class B
- One Year Warranty ■ Made in U.S.A.

PRICE/PERFORMANCE LEADER

OEM, VAR, Distributors and Dealers Please call



1977 O'Toole Ave., Suite B105
San Jose, CA 95131
(408) 435-0707

Hercules, Windows, Autocad, IBM and Lotus are registered trademarks of their respective companies.

Also from AHEAD:

EGA2001/PLUS for Mainframe/PC Communications

- IBM® 3270 Mod 2, 3, 4, 5 & S3G
- 80 x 66 text mode for desktop publishing

AMPRO LITTLE BOARD/PC™

Miniature IBM® PC/XT® Compatible Single Board Computer

SCSI Bus Interface
(Hard Disk, etc.)

768k RAM

Parallel Printer Port

2 RS232C Serial Ports

Speaker, Keyboard Ports

PC Bus Connector

Mounts on a 5.25" Drive
(5.75" x 8.0" x 1.0")

Floppy Disk Controller

Math Co-Processor

Up to 128K EPROM

4 Mode Video Controller Option
(Monochrome, Hercules, CGA, High Resolution CGA)

CMOS Surface-Mount ASIC Design Requires Only 3 Watts

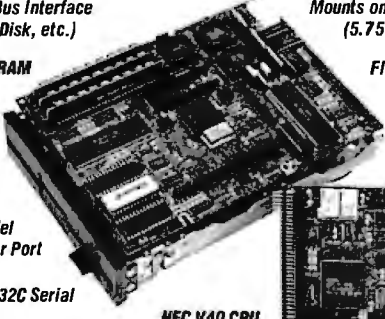

NEC V40 CPU

Drives, enclosures and power supplies available

Basic configuration includes 256K SIMM RAM, BIOS, floppy controller and 2 serial ports (less SCSI chip) . . . \$495. Fully populated with SCSI, 768K RAM . . . SCALL.

Little Board/PC Development Kit - Fully populated board, floppy drive, power supply and 2 slot enclosure with cables . . . SCALL.

For further information and technical assistance on our complete line of microcomputers and accessories, please contact:



DISKS PLUS

Microcomputers and Accessories

DISKS PLUS, INC.
356 Lexington Drive
Buffalo Grove, IL 60089-2312
Telex: 650 249 2139 MCI UW
(312) 537-7888

ACCORDING TO WEBSTER

I've since written more than 100,000 lines of Pascal code, so I know it pretty well, and I'm aware of its strengths and its deficiencies. For me, reading through the extensions manual was like getting every single thing I'd asked Santa for, and then some. MetaWare has incorporated many of the best features of Ada, C, Mesa, and Modula-2, while retaining the basic flavor and strengths of Pascal.

What kinds of extensions? There are a number of little, but useful, ones: extra data types, like Cardinal, LongInt, LongReal, and ExtReal; strings with up to 64K characters and sets with up to 64K elements; additional operators, like or else and and then, which give you "short-circuit" Boolean evaluation; additional built-in functions, like Min(), Max(), Highest(), and Lowest(); additional control commands, like Exit, Halt, and Cycle; and end-of-line comment statements.

These are nice, but some are found in most Pascal compilers. What really sets Professional Pascal apart are the more serious language extensions. Compound statements with internal declarations are permitted, as shown in listing 1.

As you can see, this lets you declare variables (and data types and constants) within a begin . . . end block. The scope of those variables is the block in which they are defined, so they exist only for the portion of the program where they're needed.

Of even greater interest is the "iterator" construct. If you want to create a for loop with a special range of values, you can define an iterator—something like a special function—that yields the list of values for the loop. For example, what if you wanted a loop where the index variable went through the squares? You could use the code shown in listing 2a. The Yield() statement gives the next value for the loop; the loop itself terminates once the iterator exits (either through a Return statement or simply by reaching the end of the iterator). A loop using this iterator might look like listing 2b.

This loop would now execute with X taking the value of the first 100 squares (1, 4, 9, . . . , 10,000).

You can also define your own binary operators in Professional Pascal. For example, if you want to define the operator +* to return the sum of the squares of two real values, you could use the code shown in listing 3. Professional Pascal will recognize the name +* as an operator and will let you use it in infix fashion:

Z := X +* Y;

In Professional Pascal, you can use any function name in infix fashion, simply by preceding it with a percent sign. Or you can use it in postfix notation by preceding it with an exclamation point. Say, for example, you defined the function GCD, which returns the greatest common denominator of two integers:

```
function GCD(I, J : Integer) : Integer;
...
end; { of func GCD }
```

continued

Listing 1: A source code fragment in Professional Pascal, showing its ability to declare variables local to a begin . . . end block.

```
for Indx := 1 to 100 do declare
var
  ISqr : Integer;
begin
  ISqr := I*I;
  WriteLn(I:6, ' ', ISqr:10)
end;
```

IBM PERSONAL SYSTEM/2 TAPE BACKUP... ANOTHER FIRST FROM MOUNTAIN.

Mountain Computer delivers again by manufacturing the first tape backup system for the new IBM® Personal System/2™ computers (Models 30, 50 & 60). These are the same reliable high-performance drives backing up the IBM XT,™ AT™ and most compatibles. And all come network-ready!

Mountain's new low-cost FileSafe™ Tape Series 4000 is the first to incorporate the new industry standard QIC 40 hardware and

QIC 109 software (which we helped develop) that now make high-performance tape backup not only highly reliable—but easily affordable.

INTERNAL AND EXTERNAL: 40MB.

The FileSafe Series 4000 family delivers 40-megabytes, formatted, in one internal and two zero-footprint external configurations. Featuring advanced automatic error correction code for unparalleled reliability, it lets you secure and transport your data in inexpensive, pocket-sized cassettes.

All versions include Mountain's latest generation of powerful, automatic and easy-to-use menu-driven tape backup software that is relied on daily by thousands of professional, business and government systems users worldwide.



ONE-YEAR WARRANTY IS STANDARD.

As a leading innovator in tape backup for desktop computers, Mountain backs the Series 4000 with a 12-month limited warranty featuring "Ready Replacement" within the first six months, and our 10-year track record of responsive support.

RELIABLE BACKUP YOU CAN AFFORD.

The race for first is over. Ask for Mountain's affordable FileSafe Tape Series 4000 at leading computer stores everywhere. Call or write today for more information and the name of your nearest Mountain dealer.



Mountain.
THE PEAK OF PERFORMANCE
1-800-458-0300 (in Calif., 1-800-821-6066)

Mountain Computer, Inc., 360 El Pueblo Road, Scotts Valley, CA 95066, (408) 438-6650, TWX 910-598-4504, FAX 408-438-7623.

Mountain products are distributed and sold worldwide. Call or write for the name of the dealer or distributor nearest you.

*registered trademarks and ™ trademarks of Mountain Computer, Inc. and International Business Machines Corp. ©1987 Mountain Computer, Inc.

Inquiry 200

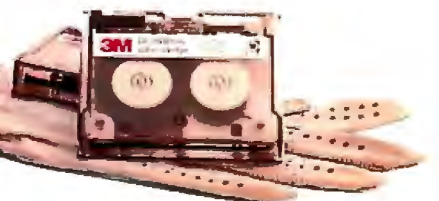

UX-BASIC+™

The profitable way to program on XENIX.™

PC/AT DEVELOPMENT SYSTEM \$595

UX-Basic+ is the choice of industry leaders like IBM, AT&T and Siemens as well as thousands of professional programmers.

UX-Basic+ provides

- powerful structured business Basic
- C-ISAM™ routines for Informix™ compatibility
- direct access to XENIX system calls
- Native Code Compiler for highest performance (available as part of the Performance System, \$795)

UX-Basic+ is available under XENIX on the IBM, Compaq, and other PC/AT compatibles as well as on a wide range of UNIX systems.



HCR Corporation

130 Bloor Street West
10th Floor
Toronto, Ontario
Canada M5S 1N5

Telephone (416) 922-1937
Telex 06-218072 HCR TOR
Fax (416) 922-8397

UX-Basic+ is a trademark of UX Software Inc. XENIX is a trademark of MicroSoft Corp. UNIX is a registered trademark of AT&T in the USA and other countries. C-ISAM and Informix are trademarks of Informix Software Inc.

COMPETITIVE EDGE SPEED SHOP SINCE 1980

1421 E. GOLDSMITH, PLYMOUTH, MI 48170
(313) 451-0665

16 MHz 386 SYSTEM

\$3295.

1024K, 40MB HD, 1.2 MB FLOPPY, FDC/HDC, 2 SERIAL, 1 PARALLEL PRINTER PORT, 8 SLOTS, MSDOS 3.1, KEYBOARD, TRW ON SITE SERVICE. COMPATIBLE WITH IBM AT(r).

20 MHz 386 SYSTEM

\$3795.

12 MHz AT COMPATIBLE

\$849.

640K ON MOTHERBOARD, CASE, POWER SUPPLY & KEYBOARD SETUP PROGRAM.

OPTION A 1.2 MB FLOPPY & HD/FD CONTROLLER	\$300.
HI-SPEED MONO CARD	\$ 99.
HI-SPEED EGA CARD	\$325.
NEC GB-1 EGA CARD	\$399.
20MB HD 65 ms	\$299.
30MB ST4038 39 ms	\$575.
40MB HD 28 ms 6053	\$699.
70MB HD 28 ms 6085	\$995.
FLAT SCREEN AMBER MONITOR	\$119.
EGA MONITOR 640 x 350	\$425.
NEC MULTI-SYNC	\$569.
72MB TOSHIBA 25 ms	\$1095.
80MB ST4096 28 ms	\$1095.
112MB 25ms NEWBURY 1140	\$2295.
231MB MAXTOR HD 28 ms	\$5495.

8MHz AT COMPATIBLE

\$695.

512K ON MOTHERBOARD, CASE POWER SUPPLY & KEYBOARD, SETUP PROGRAM.

OPTION A 1.2 MB FLOPPY & HD/FD CONTROLLER	\$300.
OPTION B STD COLOR CARD	\$99.
CE EGA CARD	\$229.
STD COLOR MONITOR	\$309.
CE EGA MONITOR	\$425.

ADD HARD DRIVES & MONO PRICES FROM ABOVE

XT COMPATIBLE 20MB, MONO CARD & MONITOR 640K

\$1195.

XT COMPATIBLE 20MB, STD COLOR CARD & CRT 640K

\$1369.

12 MHz BASIC XENIX SYSTEM, 640K, 30MB HD, 3 USER

\$2595.

INCLUDES XENIX RUN TIME, MONO CARD & MONITOR PRINTERS, SLAVES, NOVELL, XENIX, DOS AVAILABLE

AT IS A REGISTERED TRADEMARK OF INTERNATIONAL BUSINESS MACHINES. XENIX IS A TRADEMARK OF MICROSOFT.

ACCORDING TO WEBSTER

The following three statements would all be allowable and would operate identically:

- C := GCD(A,B);
- C := A %GCD B;
- C := (A,B) !GCD;

By the way, functions in Professional Pascal can return just about any data type, including records, sets, and arrays.

I ran some simple benchmarks, to compare Professional Pascal and Turbo Pascal. All compilations and executions were done on the Access 386, off the hard disk. In every case but the Sort benchmark, the same source code was used by both compilers; different implementations of the string data type (the use of parentheses instead of brackets to specify maximum string length) forced me to make one minor change.

Table 2 shows the results of the tests. As you can see, Professional Pascal produced code that was smaller in almost every case and that was as fast or faster in every case but one. However, the run-time support was greater, resulting in .EXE files that were bigger—usually much bigger—than the .COM files produced by Turbo Pascal. (Source code for these benchmarks can be found in the ask.webster conference on BIX.)

The documentation is extensive (around 600 pages), complete, well-organized, and well-written. It's divided into three major sections: Programmer's Guide, which tells how to use the compiler and gives the nitty-gritty, machine-specific details; Programmer's Primer, which is a comprehensive (240 pages) explanation of the Pascal implementation; and Language Extensions Manual (180 pages), which explains all the extensions that have been added. Additionally, there are the usual small sections listing new features, 386-specific information, and so on.

Professional Pascal takes up a lot of disk space and memory; you should at least have a hard disk and 512K bytes of RAM. An

continued

Listing 2: This example of Professional Pascal code shows how you can use the iterator operator (a) to create a nonstandard index in a for loop (b).

```
(a)
iterator NextSquare(First,Last : Integer) : Real;
begin
  while First <= Last do begin
    Yield(First*First);
    First := First + 1
  end
end; { of iterator NextSquare }

(b)
for X in NextSquare(1,100) do begin
  ...
end;
```

Listing 3: Professional Pascal also lets you define new operators; this operator (defined as +*) will return the sum of the squares of two real values and can be used in infix notation.

```
function +*(V1,V2 : Real) : Real;
begin
  +* := (V1*V1) + (V2*V2)
end; { of func +* }
```



When it comes to choosing the best monitor, you can't get more serious than the Princeton *HX-12E*.

The *HX-12E* switches automatically from CGA to EGA for complete IBM compatibility at the best value. And Princeton delivers performance to meet your immediate needs today. And every day. Right away.

But that's just part of how serious we are. At Princeton Graphic Systems, we believe the best monitor is still the monitor with the best picture.

The *HX-12E* sets the image standard with the finest dot pitch (.28mm) to

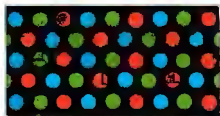

IBM Model 5154 .31mm dot pitch, NEC Multisync .31mm dot pitch, Princeton HX-12E .28 mm dot pitch.

create the sharpest, clearest and most colorful image of any monitor in its class. It's a difference you can see, and it's the difference that gives Princeton the visible edge.

So the next time you're wondering who's got the best monitor, take a look at the Princeton *HX-12E*. It's where you'll find the finest components matched to the highest engineering standards for uncompromising performance and value. And we simply can't picture it any other way. And that's no fooling.

PRINCETON
GRAPHIC SYSTEMS
THE VISIBLE EDGE

601 Ewing Street, Bldg. A, Princeton, New Jersey 08540 (609) 683-1660 Ext. 89

installation batch file does all the dirty work for you. For example, the compiler alone, when installed and ready to go, is more than 660K bytes in size.

If I have one major complaint, it is (as it is so often) that the package costs too darn much: \$895. And you don't even get an editor with it (Turbo Pascal serves well as one). It's a shame that a language implementation this outstanding will never get much distribution, because most programmers are going to be willing to get by with compilers that cost much less (and do much less).

There are also some minor complaints with this, the 386 version, but they all stem from the lack of hardware and a standardized operating system for the machines that have made it out to the market. For example, the current version requires you to have the 386/ASM-386/Link package from Phar Lap Software; you use the linker (LINK386) to link your object modules and a special program (RUN386) to actually run your .EXE file. Together, Professional Pascal and RUN386 support what is known (somewhat humorously) as the "Small" memory model: one code segment and one data segment. Of course, on the 80386, each segment can be 4 gigabytes long, so it's not really very small. The current version of RUN386 (1.1e) limits the load size of the program to 640K bytes, though it gives full memory range to both the data and code segments.

What if you're not developing for the 386-based systems? You can get an MS-DOS version of Professional Pascal for the same price. What if you don't like Pascal? MetaWare also sells a C compiler (called High C) for 386-based systems.

Microsoft C

The other language I've been playing with during the past month has been Microsoft C, version 4.0, for MS-DOS. This version

doesn't generate 386 code, but it's a solid, fast compiler that works nicely indeed on the Access 386.

What can I say about the compiler itself? It supports five different memory models (small, compact, medium, large, and huge), three different calling sequences (cdecl, pascal, and fortran), several different processors and coprocessors (8088/8086, 80186, 80286, 8087, and 80287), and lots of library functions. It has several utilities, including MAKE. It has voluminous documentation (three volumes), that is well-written and well-organized.

Its biggest plus is CodeView, a source-level, window-and-menu-oriented debugger. With CodeView, you can pull up your programs; single-step through them; watch the values of different variables, register, and memory locations change; and in short do whatever you need to debug your code.

You really need a hard disk to use Microsoft C effectively. It is possible to get by with two floppy disk drives, but I sure wouldn't recommend it. Heck, you can buy a hard disk for your PC for about what you'd pay for this compiler, so you should invest in the hardware to make the software really pay off.

If my comments seem brief, it is because I don't feel especially qualified to judge C compilers (I consider myself to be pretty much a C novice). I know the language moderately well but have not written enough C code to know what to look for (or not look for) in a C compiler. However, I found Microsoft C and CodeView easy to use. It's my choice for MS-DOS C development for the time being.

C on the PC

Speaking of Microsoft C, I've grumbled before about my inability to find a good introductory text on C. I own close to a dozen

Table 2: Timings for Turbo Pascal and Professional Pascal on an Access 386 (using the internal hard disk).
See table 1's caption for a description of the benchmarks.

Test	Turbo Pascal		Professional Pascal	
Sieve	compile:	0.8 secs	compile/link:	26.4 secs
	code:	368 bytes	code:	304 bytes
	data:	8240 bytes	data:	8253 bytes
	.COM:	11,753 bytes	.EXE:	25,682 bytes
	run:	7.8 secs	run:	4.0 secs
Sort	compile:	0.9 secs	compile/link:	27.0 secs
	code:	816 bytes	code:	550 bytes
	data:	208 bytes	data:	415 bytes
	.COM:	12,200 bytes	.EXE:	19,942 bytes
	run:	16.2 secs	run:	5.1 secs
IMAT	compile:	0.9 secs	compile/link:	33.9 secs
	code:	848 bytes	code:	568 bytes
	data:	15,040 bytes	data:	15,054 bytes
	.COM:	12,239 bytes	.EXE:	42,844 bytes
	run:	3.5 secs	run:	2.8 secs
RMAT	compile:	1.0 secs	compile/link:	33.9 secs
	code:	896 bytes	code:	630 bytes
	data:	25,040 bytes	data:	20,054 bytes
	.COM:	12,284 bytes	.EXE:	57,972 bytes
	run:	9.7 secs	run:	23.0 secs
Reals	compile:	0.8 secs	compile/link:	28.4 secs
	code:	304 bytes	code:	312 bytes
	data:	80 bytes	data:	69 bytes
	.COM:	11,694 bytes	.EXE:	26,496 bytes
	run:	9.4 secs	run:	2.8 secs

C texts, not one of which really does a good job of presenting C in a clear, logical, orderly fashion. Maybe that's a problem with the effect C has on the minds of these authors, but whatever the reason, it has been a continuing source of frustration.

Well, the frustration has ended. Robert Lafore, whose book *Assembly Language for the IBM PC & XT* I praised last year, has written the best tutorial on C I have read: *Microsoft C for the IBM*, put together under the auspices of the Waite Group and available at \$24.95 from Howard W. Sams & Co. Mitch Waite was kind enough to send me galley proofs of the book, and I worked through it, page by page. My thought on reading it was, "Why hasn't anyone written a C text like this before?"

Lafore covers all the topics you'd expect him to: data types, control structures, functions, pointers, arrays, structures, and files. He also covers several that you wouldn't expect: CGA and EGA graphics, serial ports, modems, separate compilation, and memory models. The emphasis is on using C to make your machine (IBM PC or compatible) actually do something.

If you want to learn C—even if you don't know much about programming—get *Microsoft C for the IBM*, along with a good C compiler, and work through the book. It focuses on Microsoft C, but you could easily use other compilers (Let's C, Instant C, Ecosoft C, and so on). The book is the important part; you won't regret buying it.

Updates

The folks at Access Associates, who manufacture the Alegra memory-expansion box for the Amiga, have now released their 2-megabyte version, thanks to the decreasing cost and increasing supply of 1-megabit chips. The cost for the 2-megabyte version is \$475.

I received the Microsoft Word 3.0 upgrade (for the Macintosh) a few weeks back. I was a bit reluctant to change at first, fearing bugs and/or features that would end up causing problems. However, once I started using it, I got hooked. The faster response (especially when repaginating), the new features (including some borrowed from MacWrite), and the overall performance won me over. I still prefer to do my major word processing using NewWord, especially since I've got the Access 386 to play with for the time being. I may switch over to the Mac for major word processing once I get a Mac II, but probably not before then.

The Hackers Corner

Some months back, I wrote about the International font for the Macintosh created by Dr. Paul Rapoport, who teaches at McMaster University. Paul recently sent me his latest efforts. He's made some improvements to the International font (now called International Roman). But he has also created three new fonts: International Greek, International Cyrillic, and International Phonetic.

The International Greek font has already proved helpful. I recently decided to revive the Greek I had learned back in college, using the Mac to transcribe portions of the New Testament for later translation. The Symbol font was woefully inadequate, since it had none of the accents, breathings, or other marks (iota subscript, etc.). A search through my disk files turned up the International Greek font, which I then installed. To my delight, I found it had everything I needed, right down to correct Greek punctuation; for example, it typed " ; " (the ancient Greek question mark) when I pressed the " ? " key.

continued

ARE YOU STUCK?

Stuck with PL/I applications running only on mainframes or minis?

Language Processors, Inc., an innovator in compiler technology, has your solution: a PL/I compiler that rescues your applications from aging mainframes and from proprietary architecture minis.

LPI-PL/I allows you to retain your present PL/I investment by letting you port the applications to just about any UNIX or XENIX-based computer.

LPI-PL/I is a true compiler that produces fast and compact machine code. You can select from several levels of optimization (local, global or machine dependent) to produce efficient applications. And our LPI-DEBUG lets you test and debug programs in PL/I, not machine language.

LPI-PL/I is just one of an entire family of compilers. The LPI family allows you to develop every subprogram of an application in the LPI language best suited for the job, and then execute cross-language calls between the subprograms. You choose the language—we will supply the compiler—with the support that made us stand above the crowd.

Copyright 1987 by Language Processors, Inc. LPI and LPI Logo are trademarks of Language Processors, Inc. The companies mentioned above own numerous registered trademarks.

And next time you buy a computer, you won't be stuck—LPI languages will be on it.

LPI-PL/I is a full implementation of ANSI PL/I X3.74-1981 General Purpose Subset. It is compatible with DG and Prime implementations of PL/I and has extensions for compatibility with mainframe and DEC implementations. Some of these extensions are: SELECT, BYTE, LEAVE, %REPLACE.

Available on MC680X0-based computers, such as Altos, Apollo, Arete, AT&T, CT, NCR, Sun and Unisys.

NEW: on AT&T 3B2, 3B5 and 3B15 Series computers.

NEW: on Intel 80386-based computers.

Call the LPI Retail Group now to order, or send the coupon. Prices start at \$995 for 80386 machines.

I need more information on LPI-PL/I for the following computers:

Name _____ Title (or attach your business card) _____

 Language Processors, Inc.
400-1 Totten Pond Road
Waltham, MA 02154
Telephone: 617-890-1155
Telefax: 617-890-5633
Telex: 951-671

The Language Source

LPI: PL/I, COBOL, RPG II, BASIC, FORTRAN, PASCAL, C, DEBUG

SWITCHING POWER SUPPLY

1 For PC-AT 220W



3 For PC-XT 135W, 155W



2 For BABY AT 200W

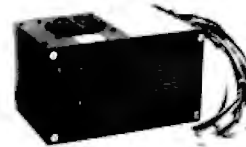

4 For TV GAME a. +5V/7A, +12V/1A, -5V/1A
b. +5V/10A, +12V/1A, +5V/1A



CHUNG YU ELECTRONICS CO., LTD.
P.O. BOX 30-535 TAIPEI, TAIWAN, R.O.C.
FAX, 002-886-02-3971968 TLX, 24451 CYELEC
TEL, 002-886-02-3918100, 3414596

Items Discussed

Access 386 \$4000 and up
Advanced Logic Research
10 Chrysler
Irvine, CA 92718
(714) 581-6770

Alegra Memory Box (2-megabyte version).....\$475
Access Associates
491 Aldo Ave.
Santa Clara, CA 95054
(408) 727-0256

Macintosh SE..... \$2900
Macintosh II \$4000 and up
Apple Computer Inc.
20525 Mariani Ave.
Cupertino, CA 95014
(408) 996-1010

Microsoft C, Version 4.0\$495
Microsoft Word for the Mac, Version 3.0.....\$295
Microsoft Corp.
P.O. Box 97017
Redmond, WA 98073-9717
(206) 882-8088

Professional Pascal for the 80386.....\$895
High C for the 80386.....\$895
MetaWare Inc.
903 Pacific Ave., Suite 201
Santa Cruz, CA 95060-4429
(408) 429-6382

386/ASM-386/Link.....\$495
Phar Lap Software Inc.
60 Aberdeen Ave.
Cambridge, MA 02138
(617) 661-1510

For more information, contact Dr. Paul Rapoport, Dept. of Music, McMaster University, 1280 Main Street W, Hamilton, Ontario, Canada L8S 4M2.

The Queue Is Flushed

Well, teammates, this is my last According to Webster column for BYTE. A certain software company wants me to write some manuals for them and has offered me more money than I care to refuse. To avoid questions about conflict of interest, I've agreed to step down. It has been a fun two years, and I am immensely grateful to Phil Lemmons for giving me the chance to write it. My single biggest regret in leaving this column is that I won't be able to get to all the products I have yet to cover; to those whose products will get skipped, my apologies. I'll still be writing for BYTE, doing Programming Projects and System Reviews. Thanks to all of you for your kind words, encouragement, and criticisms over the past two years. Be good, never bias a MOS-FET above the source drain, and I'll see you on the bit stream. ■

Thanks to Frank Boosman and Eric Zocher of Silicon Beach Software; Tom Pennello at MetaWare; Rick Russell at BYU; and Mitch Waite at the Waite Group.

Only \$995

FEMAP

Easy to use
Finite Element Modeling
on the IBM PC

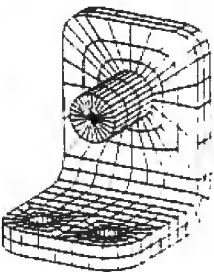

- Unique User-Friendly Interface
- Full 3-D Mesh Generation Capability
- Extensive Graphics
- Not Copy Protected
- Interfaces
 - MSC/NASTRAN, pal
 - ANSYS and PC/linear
 - Neutral File, PATRAN

FREE Brochure

FEMAP'S unique user-friendly interface provides a powerful tool for constructing 2-D and 3-D models, using a full range of elements, coordinate systems, loads and constraints. A working demo version is available with full documentation, for \$65.



Enterprise Software Products, Inc.

P.O. Box 264 • Harleysville, PA. 19438 • (215) 256-1829

FEATURES STANDARD WITH US, OTHERS DON'T EVEN OFFER AS OPTIONS.



Take our ARC Turbo 12,
for example.

Take its speed. The fastest
off-the-shelf AT™ compati-
ble you can buy. (12.5 MHz,
50% faster than IBM.™)

Take the ARC Turbo 12's
exclusive MIPS Meter,
which gives you a digital
read out of the actual
number of millions

of instructions per second
currently being processed.

And take ARC's
unmatched reliability. Which
is what you'd expect from
one of the fastest growing
computer manufacturers.

We back our equipment
with a two-year limited
warranty, the longest in the
industry. Each
unit also comes

with 90 days of Free on-site
service. And our technical
support Hot Line gives you
direct access to our expert
staff.

Ask your ARC Author-
ized Dealer for all the
details. (For a list, call
800-654-6151.)

It's a fast world. With
ARC, it won't pass you by.



ARC American
Research
Corporation
In California: (213) 265-0835.

THE ULTIMATE REFERENCE FOR THE ULTIMATE SPREADSHEET

- Provides 892 pages of detailed Lotus® 1-2-3® information packed into one handy desktop reference.

- Covers every command, function, and procedure for 1-2-3® Release 1A and Release 2.

- ▶ Includes special coupons offering substantial savings on many popular add-on products, including Reflex,™ Sideways, and Note-It.™



NEW from Osborne/McGraw-Hill

1-2-3®: THE COMPLETE REFERENCE

BY MARY CAMPBELL

Columnist for IBM® PC Update, Absolute Reference, and CPA Journal

Here's an essential reference for both 1-2-3 beginners and seasoned pros!

All 1-2-3 commands, functions, and procedures are thoroughly explained and demonstrated in "real-world" business applications. You'll learn practical techniques as well as time-saving 1-2-3® tricks.

And you can quickly pinpoint the answers you need because this book is clearly organized by task. **1-2-3®: The Complete Reference** has all the details on:

- Printing
- Macros
- Graphics
- Data Management
- Extending 1-2-3 with Report Writer™ and other software
- And much, much more.

1-2-3®: The Complete Reference... Undoubtedly indispensable for 1-2-3 computing.

\$22.95, A Quality Paperback, ISBN # 0-07-881005-1, 892 Pages

Other titles in **The Complete Reference** series include:

- dBASE III PLUS™: The Complete Reference
- DOS: The Complete Reference
- C: The Complete Reference

AVAILABLE at bookstores and computers stores EVERYWHERE.

Or Call Osborne/McGraw-Hill Toll-Free at 800-227-0900. In California Call 800-772-2531.

(Available in Canada through McGraw-Hill Ryerson, Ltd., Scarborough, Ontario, Phone: 416-293-1911.)



Osborne McGraw-Hill
2600 Tenth Street, Berkeley, CA 94710



Run-Length Encoding

Dick Pountain

Compress data by replacing repeating items with a count and one item

A few years ago, it seemed that data compression on personal computers might become a redundant art. The price of memory (both solid-state and disk) was going down so fast that compressing data hardly seemed worth the trouble. Such naive optimism has had to yield, however, to advances in telecommunications. The increasing use of on-line systems like BIX makes data compression desirable; you can cut down on your phone bills if the software you download is compressed with ARC (a public domain archiving utility) or a similar system.

At the same time, disk drive manufacturers have discovered a relatively inexpensive way to increase both the capacity and the speed of their products: By compressing data "on the fly" with a custom chip, you can fit more on a disk with less head movement. The same chip expands the data when it is read. A large percentage of the next generation of microcomputer Winchester drives will undoubtedly have such run-length-limited hardware as a part of their design.

Many algorithms are used to compress data, ranging from the very simple to the highly complex, and their efficiency varies according to the nature of the data in question. The simplest of these algorithms, *run-length encoding*, finds runs of repeating items in the data and replaces those runs with a count of the original number of items and a single item. It's a commonsense idea we use regularly in everyday life; for example, we say, "please get me three pints of milk at the store" rather than "please get me a pint of milk and a pint of milk and a pint of milk at the store."

Three's a Crowd

Run-length encoding is easy to implement in a program, but it can be applied at different levels. Moreover, it is efficient for only certain kinds of data, namely, those in which many repeating runs occur. For example:

It's utterly useless for compressing ASCII text data, which typically contains only the occasional double letter or repeated space.

In this case, we accomplished no data compression at all, as the count takes up as much space as the letter it replaces. Run-length encoding shouldn't be applied to runs of one (which would nearly double [i.e., `ldlolulbille`] the size of the sentence) or two items.

Binary data is a different matter. On a bit-mapped graphics system, for example, the screen data contains many long runs of adjacent pixels with equal values, representing blocks of the same color. These can be run-length-encoded for storage and communication. (Some graphics-file formats for the Macintosh already exploit run-length encoding.) In fact, since only two possible values are present, a 0 and a 1, it is sufficient to record the count alone, with alternate counts referring to 0 and 1 alternately. For example, a black patch on a single scan line of the screen might look like figure 1a and be encoded as in figure 1b.

This scheme treats the screen data as a continuous stream of bits, regardless of byte or word boundaries. However, you need to do a lot of "bit-twiddling" to extract the bits from a stream of bytes or words. In addition, corruption (or loss) of a single byte in the encoded data totally destroys the decoded image. Hard disk encoding systems also treat the data as a bit stream, but they use a custom VLSI chip to perform bit extraction and error checking.

An Easier Way

I've recently been playing with a much simpler scheme for run-length-encoding

IBM PC color-text screens. I've written a program that uses a mouse to "paint" text-mode screens on the color graphics adapter, employing a wide range of colors achieved by *dithering*, using the extended

ASCII characters 176 through 178. (Dithering means getting the effect of extra colors by putting pixels of different colors next to each other; for example, if you alternate red and green pixels, the resulting color looks like yellow. It isn't a "true" color, because if you look at it closely, you can see the individual red and green pixels—but it does look like yellow. By using all the possible combinations of ASCII 176, 177, 178, foreground and background colors, you can create 120 new "false" colors in text mode.)

The resulting screens are attractive and colorful, but they occupy 4K bytes of memory each. By using run-length encoding, you can usually squeeze them down to 300 to 1000 bytes, making it feasible to include them in the code of a program, for example, as help screens.

An IBM color-text screen (in 80-character by 25-line mode) consists of two thousand 16-bit word values. The 2 bytes in each word contain the color and text data. The first byte represents a color attribute; the second, a character code. Dumping one page of the color-adapter memory to a file in this manner produces a 4000-byte file. Run-length-encoding this data compresses all the areas representing solid blocks of color or repeated characters (like a box frame), although it doesn't do much for English text.

The first design decision you must make is what length of runs you want to encode. As you can see, it is folly to en-

continued

Dick Pountain is a technical author and software consultant living in London, England. He can be contacted c/o BYTE, One Phoenix Mill Lane, Peterborough, NH 03458.

code "runs" of one and no help to encode runs of two. This means that the encoded file will include two different kinds of data items: those representing a single uncoded value and those depicting the count/value pair for a run of values. An expansion program must be able to distinguish between these two different cases. In the example sentence, I cheated by using a sentence composed only of letters while the counts were digits. This method would not have worked if the sentence had contained some digits.

The Escape Route

The accepted method for making this distinction is to choose one special escape character that cannot represent a data value but indicates that the two values following it are a count/value pair. For example, you could encode the sequence in figure 2a using # as an escape character (see figure 2b). This reduces the overall compression achieved—you need three items to encode any run (one for the #

sign itself) instead of two. You should exclude runs of one or two, or you may increase the size of your encoded text.

An escape character must be unique, a bit combination that will never appear in the data. Therefore, encoded files must not themselves be encoded. The algorithm for run-length encoding using an escape character is shown in pseudocode form in listing 1. [Editor's note: *The algorithms discussed in this and future Focus on Algorithms columns will be expressed both in pseudocode and in a programming language. The pseudocode uses control structures similar to those in Pascal or C, as well as the following conventions: Variable names begin with a capital letter; a right arrow indicates an I/O operation; a left arrow indicates an assignment to a variable. Parts of the pseudocode may be described in plain English words; these descriptions will be in lowercase.*]

I decided on a more economical scheme. Since an IBM PC screen con-

tains 2000 words of data, you can express any possible count in 11 bits ($2^{11} = 2048$). Thus, if you make the escape indicator only 5 bits instead of 8, you can squeeze both the count and the escape indicator into a single 16-bit word, 2 bytes. Any word whose most significant 5 bits are equal to the escape indicator is treated as a count, and the next word contains its value. With this method, encoding runs of two incurs no space penalty—but achieves no compression. Leaving them in simplifies the program logic since you only need to treat singletons (runs of one) differently. This scheme never leads to an increase in the size of the color-screen data; in the worst case, it stays the same.

I chose F800 hexadecimal as my escape indicator (all 5 top bits set to 1); therefore, I can't use a screen containing an attribute byte with these bits turned on. This attribute corresponds to a high-intensity, blinking, foreground character on a white background; I think I can live without that combination. Listing 2 contains Compress, a procedure in Turbo Pascal that condenses a screen into a file, using this compression scheme. For reasons of space, I omitted the checks I normally perform when opening files.

The Rest of the Story

Compressing screens is only half the story. You must be able to read the file of condensed data into an array in memory and then be able to expand the data in this array back onto the screen upon request. Since I wanted the compressed data to become part of a program—rather than to be read in at run time—I chose to store it in a Turbo Pascal typed-constant array. Compress outputs the condensed data as ASCII text, enclosed in parentheses and separated by commas, rather than as binary information. You can include this array directly into your source text, declaring it in the form `const pic1: array[0..367] of integer = (24631, 31234, ...)`; Life is simpler if you keep a count of the total number of data items you have after compression is complete (367 in the example) and write this count as the last item in the condensed file.

An expansion procedure, Expand (see listing 3), reads the elements in the compressed array, extracts the count whenever it recognizes the escape indicator, and puts that number of attributes/characters into screen memory in sequence. To make the expansion as fast as possible, I used a memory-fill routine instead of a loop for this purpose. Regrettably, Turbo Pascal has a FillChar routine for bytes but none for words, so I wrote FillW (see listing 3) as an in-line machine code procedure. [Editor's note: *Listings 2 and 3 are available in Turbo Pascal 3.0*

(a) 00000000000000000011111111111100000000000000000000000000000000

(b) 18 15 28

Figure 1: (a) A section of the bit-map data for a single scan line of a screen containing a black patch on a white background. (b) The encoded data from (a). Since only 0s and 1s exist in binary data, you need to show only the count.

(a) 1111112333333333344445

(b) #7 1 2 #9 3 #5 4 5

Figure 2: (a) A sequence of numeric data without any encoding. (b) The same data shown in (a) encoded with escape characters, count/value pairs, and singletons. This format describes the sequence of data as containing seven 1s, a single 2, nine 3s, five 4s, and a single 5.

Listing 1: A pseudocode listing of the algorithm for run-length encoding.

```

Program Encode
  item from input -> Current
  REPEAT
    Runlength <- 0
    REPEAT
      item from input -> Next
      Runlength <- Runlength + 1
    UNTIL Next NOT = Current OR no more items
    IF Runlength > 1
      THEN (escape character, Runlength) -> output
    ENDIF
    Current -> output
    Current <- Next
  UNTIL no more items
    
```

Listing 2: *The Compress procedure written in Turbo Pascal. This procedure will compress a screen into a file using the value F800 hexadecimal as an escape indicator and the remaining 11 bits of data in a 16-bit word for the count. The second 16-bit word will contain the value.*

```

procedure Compress;

const escapechar = $F800;
      scrnseg = $B800;
      scrnsize = 4000;

var OutputFile: Text;
      OutputFileName: string[80];
      runlength,currentword,nextword,scrnofs,items: integer;

begin
  OutputFileName := paramSTR(1);
  Assign(OutputFile, OutputFileName);
  Rewrite(OutputFile);
  write(OutputFile, '(');
  items := 0;
  scrnofs := 0;
  currentword := MemW[scrnseg:scrnofs]; {read word from screen memory}
  scrnofs := scrnofs + 2;
  repeat
    runlength := 0;
    repeat
      nextword := MemW[scrnseg:scrnofs];
      scrnofs := scrnofs + 2;
      runlength := runlength + 1;
    until (nextword <> currentword) or (scrnofs > scrnsize);
    if runlength > 1
    then begin
      runlength := escapechar or runlength;
      write(OutputFile,runlength, ',',currentword, ', ');
      if (items mod 12) >= 10
      then writeln(OutputFile);
      items := items + 2
    end
    else begin
      write(OutputFile,currentword, ', ');
      if (items mod 12) >= 11
      then writeln(OutputFile);
      items := items + 1
    end;
    currentword := nextword
  until scrnofs > scrnsize;
  write(OutputFile, '*** ',items, items ***);
  Close(OutputFile);
  writeln('Compressed data written to ',OutputFileName)
end;

```

source code for the IBM PC and compatibles on disk, in print, and on BIX as COMPRESS.PAS and EXPAND.PAS, respectively; see the insert card prior to page 321 for details. They are also available on BYTENet; see page 4.]

In the process of writing Expand, I discovered a neat trick. If I reserved a second special attribute indicator (in addition to the escape indicator) and called it *transparent*, I could leave parts of the screen unaltered by incrementing the destination pointer without writing any data.

I chose 07FA hexadecimal (a white dot on a black background); areas of the original screen (before compression) painted with this character appear transparent to the background after expansion, letting you design pop-up windows. This is a simple form of cursor addressing that costs nothing at expansion time.

To overcome Turbo Pascal's array-parameter weakness, which lets you pass only one size of array to a given procedure, Expand takes the address of the

continued



Precision Data Products™
POLY PACK 5¼"
DISKETTES
(From Leading Mfr.)

- Blank Jackets
- WP Tabs
- Envelopes
- Made in USA
- 100% Error Free
- Lifetime Warranty



36¢
Each

Sold in Lots of 100 Only

SALE!

SONY POLY PACK
3.5" DISKETTES

SS 135TPI \$1.10 Each
 DS 135TPI \$1.23 Each

Sold in lots of 50 only.

Minimum Order \$25.00. S & H: Continental USA \$4.00/100 or fewer disks. Reduced shipping charge on larger quantities. Foreign orders, APO/FPO, please call. MI residents add 4% tax. Prices subject to change without notice. Hours: 8:30 AM - 7:00 PM ET.



Precision Data Products™
 P.O. Box 8367, Grand Rapids, MI 49518
 (616) 452-3457 • Michigan 1-800-632-2468
 Outside Michigan 1-800-258-0028

Inquiry 243

9-Track Tape Subsystem for the IBM PC/XT/AT



Now you can exchange data files between your IBM PC and any mainframe or mini-computer using IBM compatible 1600 BPI 9-Track tape. Unit can also be used for disk backup. Transfer rate is up to 4 megabytes per minute on PCs and compatibles. Subsystems include 7" or 10 1/2" streaming tape drive, tape coupler card and DOS or XENIX compatible software. Prices start at \$2,995.



9621 Irondale Ave., Chatsworth, CA 91311
 Telephone: (818) 882-5822

Inquiry 261

PROFESSIONAL CIRCUIT LAYOUT

with CYA



Panel size to to 32"
 Up to 16 Layers
 Unlimited Complexity
 1 mil (.001") database
 Revision Control

OUTPUT TO:
 Photoplotters
 Penplotters
 Drilling Machines

IMPORT FROM:
 Gerber (RS-274)
 AutoCAD (opt.)

Requires EGA or compatible.

\$286.00
 202 G Street Suite 2
 Antioch, CA 94509
 (415) 754-3879



Inquiry 116

DYNAMIC RAMS

1Mbit	100ns	\$19.00
41256	100ns	\$ 3.75
41256	120ns	\$ 2.60
✓41256	150ns	\$ 2.40
4464	150ns	\$ 3.25
✓4164	150ns	\$ 1.20

PROCESSORS		E PROMS	
8087-2	8MHz \$147.00	27C12	250ns \$ 8.98
8087	8MHz \$107.00	27C256	250ns \$ 5.50
80287-6	8MHz \$169.00	27256	250ns \$ 4.75
80287-5	8MHz \$259.00	27428	250ns \$ 3.60
V-20	8MHz \$ 12.75	27C64	200ns \$ 4.50
V-30	8MHz \$ 12.75	2764	250ns \$ 3.25
STATIC RAMS		2732A	250ns \$ 4.25
6264L-16	150ns \$ 2.95	8050	(P/N: In stock)

I.C. EXPRESS

15358 Valley Blvd., City of Industry, CA 91746
Phone: 818-369-2688 (Mon-Fri • 8-5)

ORDER TOLL FREE
(800) 892-8869 • (800) 882-8181

Outside California Inside California
CALL FOR CURRENT PRICES & VOLUME DISCOUNTS.
Price Shown Inc. Cash + MasterCard/VISA add 3% more
Prices are subject to change. Minimum order \$1000
California residents must add 5% sales tax
Shipping & Handling: UPS Ground \$5.00 (over 1 lb)
ALL MERCHANDISE IS 100% GUARANTEED

Inquiry 135

XEMAG[®]

PROTECTION SERVICES

XEMAG's new Cloaking Device
Protection for IBM PC's

- Protects against all known software and hardware copiers.
- Install/Uninstall for hard disk systems.
- Allows a predetermined number of protected back-up copies.
- Easy menu driven installation onto your software.
- Protections for all formats.
- Division of **INDEX Corp.**

1-800-367-6217

Inquiry 344



Storage and Retrieval of Documents, Catalogs, Manuals on CD-ROM

With Online's Image Compression and Expansion Systems, Local Area Network, and Laser Printer Output, we provide complete digitizing, retrieval software, and hardware solutions.

CALL OR WRITE FOR FURTHER INFORMATION
ONLINE COMPUTER SYSTEMS, INC.
Department OPC-81
20251 Century Boulevard
Germantown, Maryland 20874
(800) 922-9204 or (301) 428-3700
Telex: 3746439 FAX: (301) 428-2903
OEM and Dealer Inquiries are Invited

Inquiry 362

Listing 3: The FillW and Expand procedures written in Turbo Pascal.
Expand takes the compressed data generated by Compress and reverses the process. It recognizes the escape indicator, notes the count, and places that number of characters into screen memory. FillW is a memory-fill routine used by Expand instead of a loop to increase the speed of the expansion.

{Fill <count> words of memory starting at <seg:ofs> with the 16-bit value <word>}

```
procedure FillW(seg,ofs,count,word: integer);
begin
```

```
  inline
  ($B / $86 / seg /      {MOV AX, seg}
  $8E / $C0 /           {MOV ES, AX}
  $8B / $BE / ofs /     {MOV DI, ofs}
  $8B / $86 / word /    {MOV AX, word}
  $8B / $8E / count /   {MOV CX, count}
  $FC /                 {CLD}
  $F3 / $AB)           {REPZ STOSW}
```

```
end;
```

```
procedure Expand(sroofs, picsize: integer);
```

```
const escapechar = $F800;      {binary 1111100000000000}
      transparent = $07FA;
      scrnseg = $B800;         {start segment of video RAM}
```

```
var sreptr, destptr, data, runlength, i: integer;
```

```
begin
  sreptr := 0;
  destptr := 0;
  while sreptr < picsize * 2 do
  begin
    data := MemW[Cseg:sroofs+sreptr];      {fetch next word}
    sreptr := sreptr + 2;
    if (data and escapechar) = escapechar {test top 5 bits}
    then begin                             {it's a count word}
      runlength := data xor escapechar;    {unpack count part}
      data := MemW[Cseg:sroofs+sreptr];   {fetch next word}
      sreptr := sreptr + 2;
      if data = transparent                {color is transparent}
      then destptr := destptr + (2 * runlength) {so just bump pointer}
    else begin
      FillW(scrnseg, destptr, runlength, data); {fill screen memory}
      destptr := destptr + (2 * runlength)
    end
  end
  end
  else begin                             {it's a singleton}
    MemW[scrnseg:destptr] := data;
    destptr := destptr + 2
  end
  end
end
end;
```

array, found by the OfS() function, and the size of the array as parameters; indexing must be done at a low level with MemW. You can expand a screen with a simple call to this procedure, for example, expand(ofs(pic1), 367);.

Words versus Bits

In principle, you can easily modify these procedures to compress IBM PC screens in either of the high-resolution graphics modes. However, compression will be

less than optimal since runs of pixels in the picture cross word boundaries, and a program that examines only words will miss many runs (or encode them as several runs). A true high-resolution compression utility needs to treat the screen as a bit stream, which means decomposing bytes using the bit-wise logical operators; it is likely to be slow. You can also modify these programs to form the basis of a communications protocol for transmitting color text over public phone lines. ■

June Sale-a-bration of Savings on EPSON® and APPLE!

EPSON

EQUITY™ I

Starter System

Complete system includes: Epson Equity I computer w/256K memory expandable to 640K, single disk drive, serial & parallel ports, monitor and software.

Suggested Retail Price \$1243.00

\$699

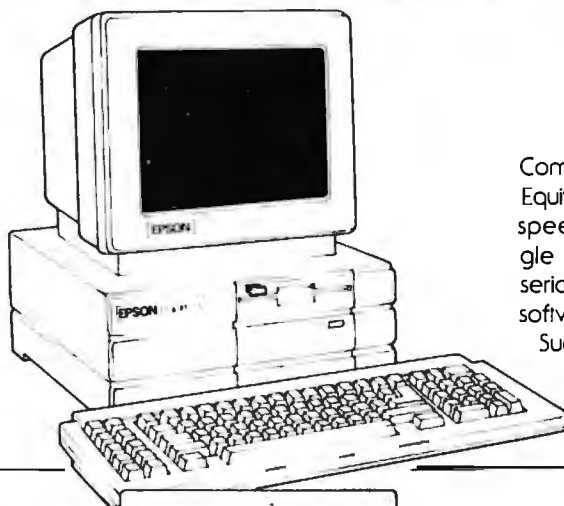

EPSON

EQUITY™ II

20 MB HD System

Complete system includes: Epson Equity II computer w/NEC V30 dual speed processor, 640K memory, single disk drive, 20Mbyte hard drive, serial & parallel ports, monitor and software.

Suggested Retail Price \$2495.00

\$1299

NEW Apple Macintosh SE

The New Apple® Macintosh™ SE includes all the features you want and need: Super Performance, two 800K disk drives, two serial ports, one SCSI interface port, and an expansion slot to plug-into special accessories and the world of MS-DOS software.

Suggested Retail Price \$2769.00

COME IN

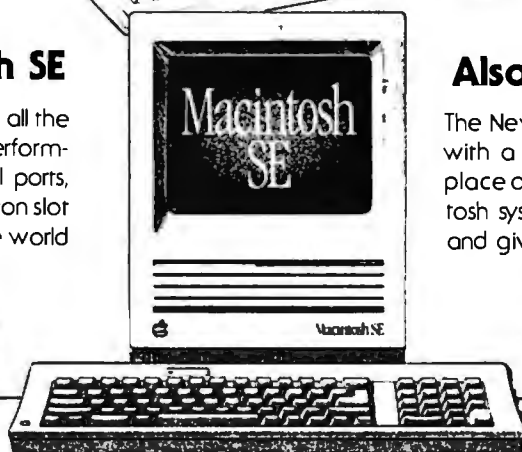

Also with 20Mb Hard Disk

The New Apple Macintosh SE is also available with a large capacity 20Mbyte hard disk in place of one of the floppy drives. Both Macintosh systems operate with speed and grace and give you The power to be your best.™

Suggested Retail Price \$3569.00

COME IN

Apple IIgs™

Apple IIgs systems feature fast 16-bit data processing, 256K memory expandable to more than 1 Mbyte, eight expansion slots inside, and the most impressive graphics and sound available.

Suggested Retail \$995.00

COME IN

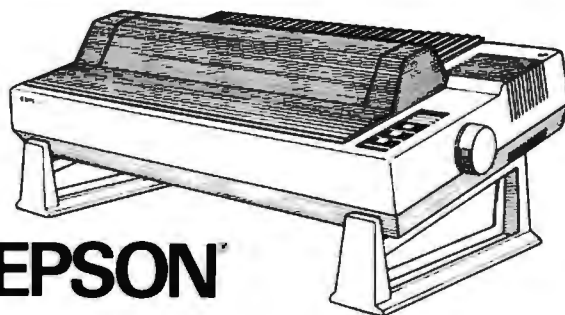

EPSON®

with **FREE Printer Stand**

- | | | |
|---|---|--|
| <p>LX86 \$219
 FX86e \$359
 FX286e \$499</p> | <p>LQ800 \$499
 LQ1000 \$689
 LQ2500 \$999</p> | <p>EX800 \$449
 EX1000 \$569
 GQ3500 \$1495</p> |
|---|---|--|



PRIORITY ONE ELECTRONICS

Chatsworth

21622 Plummer St.

(818) 709-5464

Costa Mesa

462A East 17th St.

(714) 646-8981

Burbank

1033 Hollywood Way

(818) 843-2500

Irvine

18241 McDermott

(714) 660-1411

San Jose

542 W. Trimble Rd.

(408) 435-7300

APPLE AND EPSON COMPUTERS

NOT AVAILABLE BY PHONE OR MAIL ORDER

Apple and the Apple logo are registered trademarks of Apple Computer, Inc. Apple IIgs, and Macintosh are trademarks of Apple Computer, Inc. The power to be your best is a trademark of Apple Computer, Inc. Epson is a registered trademark of Seiko Epson Corp. Equity is a trademark of Epson America, Inc.

"Satisfaction Guaranteed"

Professional Capability for

Because your business needs require sophisticated, state of the art technology, you should take the opportunity to get a new handle on your business with MAS COMPUTING SYSTEMS.

MAS 286 based portable and desktop configurations will provide you with what no other computer system can; a powerful, reliable, and thoroughly tested product, supported by a capable team of production engineers, technical assistance staff, qualified sales personnel, and a strong management team.

The MAS 286 based systems combine the best in advanced technology to afford you more than just a computer, but an advanced scientific tool to simplify age old problems. A choice of 8MHz, 10MHz, or 12MHz 80286 CPU provides more speed and performance than either the IBM XT, the IBM AT or most other compatible systems. The 1Mb on board RAM also provides an ample amount of memory space for most sophisticated software, such as AutoCAD, Lotus, Word Perfect, dBase III or any other specialized software package to meet your individual needs. Your choice of 3½ or 5¼ inch floppy disk drives, a 20Mb up to 160Mb hard disk drive, tape back up system, modem and much more allow you to expand your system and its capabilities. The MAS 286 based system can provide you with all networking abilities such as Novell, Xenix, Multilink and more.

Whether using it for business or personal use, the MAS 286 based system enables you to achieve more than you ever imagined possible.



Professional Use

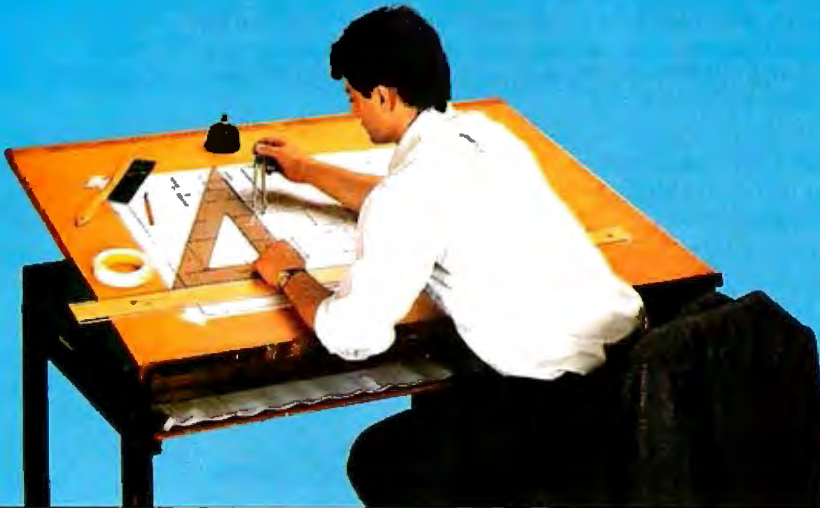

MAS DESK TOP SERIES

MAS 800 AT Computing System \$2,799.00

- 10MHz "0" wait state, 1Mb memory
- 30Mb fast access hard disk drive
- Enhanced graphics adaptor and monitor

MAS 200 TURBO AT Computing System . . \$1,199.00

- 8MHz, 640K memory
- 20Mb hard disk drive
- Monochrome graphics adaptor
- Clock, calendar, serial and parallel game ports
- High resolution monochrome monitor

Color System \$1,499.00

MAS 100 XT Computing System \$ 899.00

- 4.77MHz, 640K memory
- Two 360K floppy disk drives
- Clock, calendar, serial and parallel game ports
- High resolution monochrome monitor

Color System \$1,099.00

MAS PORTABLE SERIES

MAS 8000 AT Portable System \$2,199.00

- 10MHz, 1Mb memory
- 20Mb hard disk drive
- 1200 baud internal modem
- Monochrome graphics adaptor

30Mb System \$2,499.00

MAS 2000 TURBO XT Portable System . . . \$1,599.00

- 8MHz, 640K memory
- 20Mb hard disk drive
- 1200 baud internal modem
- Monochrome graphics adaptor
- Clock, calendar, serial and parallel game ports

MAS 1000 XT Portable System \$1,099.00

- 4.77MHz, 640K memory
- Two 360K floppy disk drives
- Monochrome graphics adaptor
- Clock, calendar, serial and parallel game ports

Call us for pricing on custom configurations to meet your system requirements. Quantity pricing available. OEM inquiries welcome. One year warranty on all parts, 90 days labor. For more information please call us at 213-306-3804.

IBM XT/AT, AutoCAD, Lotus, WordPerfect, dBase III Plus, Novell, Xenix, and Multilink are respective trademarks of International Business Machines, Autodesk Inc., Lotus Development Corp., WordPerfect Corp., Ashton-Tate, Novell Inc., Microsoft Inc., and The Software Link, Inc.

M
A
S

Systems

4077 GLENCOE AVENUE • MARINA DEL REY, CALIFORNIA • 213-306-3804

Inquiry 438

JUNE 1987 • B Y T E 320B-3

TAPENET™

The Reel Thing in Mainframe to PC Connections.

In today's Information age, sharing data between your mainframe and your PCs is an essential link. With TAPENET, users will have access to virtually any mini or mainframe by being able to write or read 9 or 7 track,

Industry standard tapes in densities of 200/556/800/1600/6250 bpi. TAPENET consists of an IDT tape subsystem that features the LEO intelligent PC tape controller for the IBM-PC/XT/AT and compatibles including the new 386 PCs. LEO is a state-of-the-art tape controller that features a dedicated microprocessor, on board ram for buffering, has external cable connectors for easy installation and cabling, and does not require any PC DMA resources.

Documentation is extensive and includes step-by-step installation instructions and a programmers guide with coding examples and BIOS rom source codes.

IDT offers a complete DOS software package of user friendly window software utilities with help screens that will enable you to move data between your PC and your mainframe. Included are: file transfer utilities for both IBM labeled or unlabeled tapes in ASCII or EBCDIC, format and dump utilities, and a comprehensive backup/restore utility. IDT also has software support for XENIX and PICK operating systems.

IDT manufactures both magnetic tape drives and controllers offering a single vendor solution for your data interchange requirements and a full time customer support group that is ready to help with any questions you may have. IDT also has subsystems for GPIB, RS-232, SCSI, DEC, VME, and Multibus.



For more information call:

1-619-587-0555

5340 Eastgate Mall • San Diego, CA 92121

(619) 587-0555 • TWX: (910) 335-1610

FAX: (619) 587-0160

Regional Offices:

Eastern: (609) 596-4538 • Western: (714) 968-8082

*DOS/XENIX/PICK/IBM are registered trademarks of Microsoft/PICK/IBM respectively.



Inquiry 436

Important TIPS* for BYTE Subscribers: Receive Product Information 10 Days Earlier!



IDENTIFICATION CARD

John Sample

785432189

See Reverse Side

All you need is a touch-tone telephone and your subscriber I.D. number. See instructions facing the Reader Service cards in the back of this issue for outrageous time-saving opportunities!

*BYTE's Telephone Inquiry Processing Service

SETTLING FOR A TABLET CAN BE A SIZEABLE MISTAKE

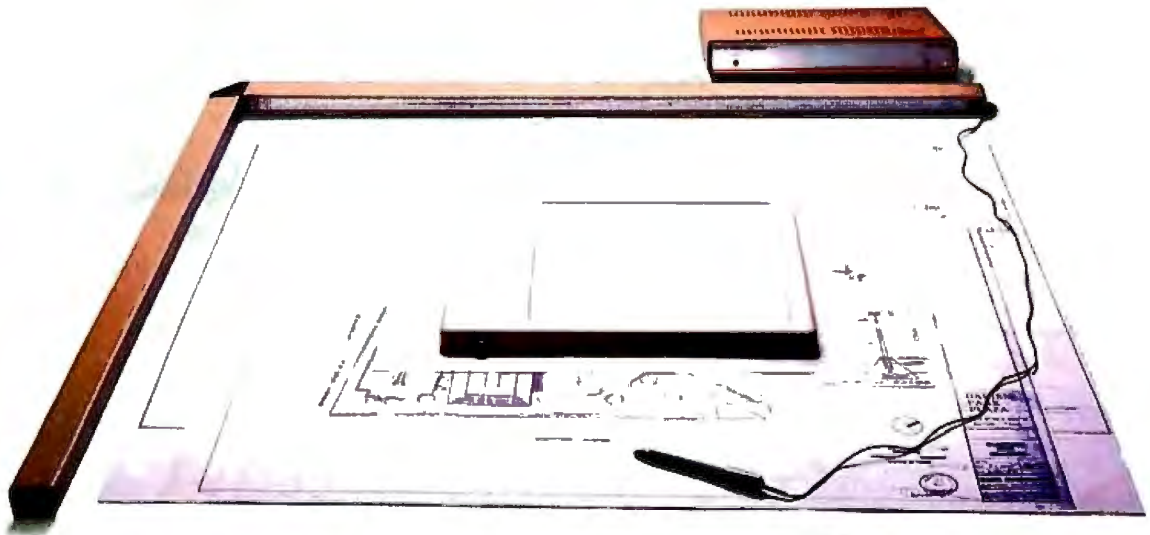

A sizeable mistake because a sonic digitizer from Science Accessories will give you more active area than any comparably priced tablet. And, due to its unique technology, it doesn't restrict you to one specialized work surface. Now with the GP-7 Mark II you really have room to work. Its active area has been increased to 26" x 20" (\$1315.00). This new model, along with the GP-8 (\$3525.00) with active area up to 60" x 72" —the large format digitizing champ, are both IBM-PC compatible. So don't settle for digitizing on a postage stamp; open up your work area with a Science Accessories' sonic digitizer.

All our digitizers, including the three-dimensional model GP-8-3D, come complete with stylus or cursor and power supply. Every model features RS-232 as standard output (parallel and 2-way communications and .005 resolution optional). OEM versions available. Ask about "Easy Digit" start-up software. Directly supported by AutoCAD.

For more information, call Skip Cleveland **(203) 255-1526**. Ask for your free copy of "A Guide to Sonic Digitizers."

SAC® SCIENCE
ACCESSORIES
CORPORATION

A Leader in Digitizer Technology since 1969
970 Kings Highway West • Southport, CT 06490 • (203) 255-1526 • Telex 964300



PARTS SUPPLIERS

- For Computer Service
- For System Installers
- For Electrical Contractors

Flat Telephone Cable for Modems and Telephone

Cable manufactured to tough specifications required by most telephone companies. Available in four, six or eight conductors.

	1M	5M
4-Conductor	\$32.50/M	\$30.00/M
6-Conductor	\$42.50/M	\$40.00/M
8-Conductor	\$53.50/M	\$47.00/M

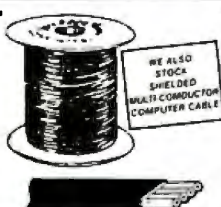

PATCH PANELS

Patch Panels provide a centralized point to organize cables. These sturdy panels are 19" long for rack mounting. Cut outs are for DB-25, DB-15, DB-9, and COAX BNC connectors. FOR DB-25 CONNECTORS, connectors not included.

16 POSITION	\$19.95
32 POSITION	\$24.95
48 POSITION	\$34.95
64 POSITION	\$39.95

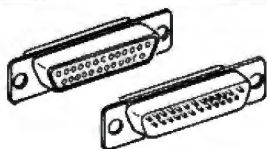

D-Sub-Miniature Connectors

Industry Standard Connectors for: Data Cables - Computer Systems - Peripherals

	1-9pcs	10-24pcs	25-49pcs	50-99pcs	100-999pcs
DB-9P Plug	.69	.49	.39	.35	.32
DB-9S Socket	.72	.54	.42	.39	.35
DB-15P Plug	.85	.65	.51	.47	.43
DB-15S Socket	.97	.77	.60	.55	.50
DB-25P Plug	.97	.77	.60	.55	.44
DB-25S Socket	.97	.77	.60	.55	.44

BNC CONNECTORS & ADAPTORS

BNC CRIMP	BNC TWIST-ON	BNC SPLICE	BNC "T"
10-49 50-99 100-999	.89 ea. .64 ea. .59 ea.	10-49 50-99 100-999	1.10 ea. .99 ea. .90 ea.
	79¢ each		1⁶⁹ each
		10-49 50-99 100-999	.92 ea. .85 ea. .78 ea.
			99¢ each
			10-49 50-99 100-999
			2.30 ea. 2.12 ea. 1.95 ea.
			2⁶⁹ each

Twin-ax Cable SPECIAL LOW PRICES

1-3,000'	*199/m
4-10,000'	*185/m
10,000-up	*165/m

In Stock Now!

Twin-ax Connectors

10-49 50-99 100-999	2.90 ea. 2.65 ea. 2.45 ea.
	3²⁹ each
10-49 50-99 100-999	3.69 ea. 3.35 ea. 3.09 ea.
	3⁹⁹ each

D-Connector to Modular Plug Adaptors

Allows use of low-cost and flexible 4, 6 or 8-wire telephone wire for interconnection of RS-232 devices.

6 Contact to 1-9	\$3 ⁹⁵
DB-25 Connector 10-49	\$3 ⁶⁵
8 Contact to 50-99	\$3 ³⁵
DB-25 Connector 100 up	\$2 ⁹⁵



ALSO 9 PIN & 15 PIN D-CONNECTOR AT SAME PRICE

PHONE OR WRITE FOR OUR CATALOG 1-(800)-992-3191

We Ship via UPS anywhere in U.S.

We Welcome Commercial Accounts

EAGLE ELECTRONICS

1233 E. Colorado Blvd.
(818) 244-3191

Established 1963

Glendale, CA 91205
(213) 245-2338

14" DISPLAY MONITORS



CTX 1400

- 14" TTL Monochrome
- 1000 Lines Resolution
- Swivel Tilt Base
- Green or Amber CRT
- Flat Screen Display

OEM, Distributor, Dealer Inquiries Invited.

CTX INTERNATIONAL, INC.

20768 Carrey Road, Walnut, California, USA 91789
(714) 595-6146 FAX (714) 595-6293 TELEX 322049

14" RGB COLOR DISPLAYS

TWO YEAR WARRANTY!

CGA: Resolution 640 x 200
CTX 1410 .42 Dot Anti Glare
CTX 1411 .38 Dot Black CRT
CTX 1421 .31 Dot Anti Glare



EGA: Resolution 640 x 200 / 640 x 350
CTX 1422 .31 Dot Anti Glare

SPECIAL

PRODUCT: CTX 1421LP - Long Persistence
720 x 480, .31 Dot CRT
CTX 1424 .39 - Hi-Res 640 x 400
24 KHZ, .39 Dot CRT
CTX 1424 .31 - As Above With .31 Dot

NOTE: All Color Displays Have Green and Amber Text Switch.



ALPS	
ALQ 218	429
ALQ 318	629

NEC	
MULTI-SPEED	
BEST PRICE	

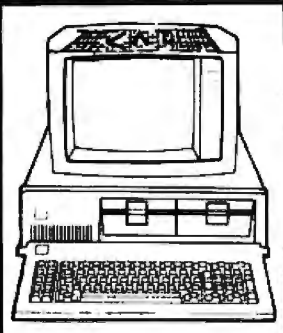

TOSHIBA LAPTOPS	
T 1100+ & T 3100	
BEST PRICE	

HERE MOS CO

NEC	
P6-Parallel	419
P7-Parallel	589

NEC MULTISYNC	
+ NEC GB-1	859
+ Vega Deluxe	839

SEAGATE	
20 Mb Complete Kit	319
30 Mb Complete Kit	369

MITSUBISHI AUM-1371	
Diamond Scan	549
+ ATI EGA Wonder	779

SONY MULTISCAN	
+ Quad ProSync	929
+ Paradise 480	969

TAPE BACKUP	
20 Mb XT or AT	359
40 Mb XT or AT	459

DICONIX 150	
Inkjet Portable Printer	
Parallel	299

★ NEW LOWER PRICES ★ COMPARE & SAVE ★

PRINTERS	
ALPS PRINTERS	
ALQ 200 Color, Narrow	
18 pin, 200/100 cps	\$429
24 pin, 200/120 cps	489
ALQ 300 Color, Wide	
18 pin, 200/100 cps	629
24 pin, 200/120 cps	689
P2000 9 pin, 250/125 cps, Wide	
Ser & Par w/Tractor	689
P2100 18 pin, 400/200 cps, Wide	
Ser & Par w/Tractor	1129
P2400 Color, Wide w/Tractor	
18 pin, 250/125 cps	929
24 pin, 360/180 cps	979
ALPS Buffer Kits, Fonts, Tractors	
Sheet Feeds, Ribbons & 18 pin/24 pin	
upgrade kits	CALL
CITIZEN Printers	
120 D	189
MSP 10	279
MSP 15	369
MSP 20	309
MSP 25	459
Premiere 35	459
Tribute 224	699
Sheet Feed: MSP 10/15/20/25	220
Sheet Feed: Premiere 35	390
DICONIX 150 InkJet Portable	
Parallel	299
Custom Short Cable Available	
NEC Printers	
P5XL Color - Par	999
P6 - Par	419
CP6 Color - Par	519
P7 - Par	599
CP7 Color - Par	689
Bi-Di Tractor for P5	180
Uni-Di Tractor for P2/P6	60
Bi-Di Tractor for P2/P6	160
Bi-Di Tractor for P3/P7	170
Bi-Di Tractor for P5	180
Cut Sheet Feeder for P5	350
Cut Sheet Feeder for P2/P6	230
Cut Sheet Feeder for P3/P7	290
OKIDATA 192 PLUS	
193 PLUS	499
PANASONIC	
1080 i	199
1091 i	259
1092 i	329
1592	399
1595	479
TOSHIBA 321	
NEW 321 SL	CALL
KENSINGTON Printer Stand	
With Printer	10
Limited Time Offer	

DRIVES	
* All Drives Shown Are Internal *	
FUJITSU/TEAC/TOSHIBA	
360k 1/2 Ht Black (PC/XT)	\$89
360k 1/2 Ht Grey (AT)	99
1.2 Mb 1/2 Ht (AT)	119
TOSHIBA 3.5" 720k	119
MINISCRIBE Hard Drives	
20 Mb Int 1/2 Ht w/Cont	339
30 Mb Int 1/2 Ht w/Cont	399
40 Mb Full Ht (AT)	599
70 Mb Full Ht (AT)	869
PLUS HARD DRIVE ON CARD	
Limited Time Offer	
20 Mb HardCard	595
286 Upgrade Kit	CALL
SEAGATE	
HARD DRIVES	
PC/XT 1/2 Ht w/Western Digital	
(WD) controller, cables, manual	
software and one year Warranty	
20 Mb Complete Kit	319
30 Mb Complete Kit	369
30 Mb Full Ht (AT)	519
40 Mb (AT) 1/2 Ht w/partitioning	
software (\$80 value)	585
80 Mb (AT) Full Ht w/partitioning	
software (\$80 value)	999

MONITORS	
MDS Genius 402 Full Pg Text &	
Graphics Display w/cont	1299
MITSUBISHI	
XC-1409 CGA	319
XC-1410 EGA	449
XC-1430 EGA	499
AUM-1371 Diamond Scan	549
With ATI EGA Wonder	779
With NEC GB-1	879
With Quad EGA ProSync	879
With Vega Deluxe	859
NEC MultiSync 1401	529
With ATI EGA Wonder	759
With NEC GB-1	859
With Quad EGA ProSync	859
With Vega Deluxe	839
SONY 1311CR-13" Trinitron Color	
Remote TV & RGB Monitor	399
SONY Multiscan 1302	599
With ATI EGA Wonder	829
With NEC GB-1	929
With Paradise AutoSwitch 480	969
With Quad EGA ProSync	929
With Vega Deluxe	909
TAXAN	
635 (640x400)	419
With Taxan Graphics 555SP	569
650 (720x400)	479
With 557 Gold Card	699
660 (640x350) 12"	499
With Sigma/Taxan 400	899
760 (640x350) 14"	499
Limited Time Offer	
With 560 Auto Switch	629
TAXAN 770 MultiVision	549
With 557 Gold Card	829
With ATI EGA Wonder	779
With NEC GB-1	869
With Quad EGA ProSync	869
With Vega Deluxe	849
840 (720x400) 16"	799
With 557 Gold Card	1069
With Sigma 400	1199
New 860 EGA 16"	CALL

DISPLAY CARDS	
ATI EGA Wonder	\$239
GENOA SuperEGA	349
SuperEGA HiRes	CALL
HERCULES New InColor Card	339
NEC Multisync GB-1	339
PARADISE AutoSwitch 480	379
QUADRAM QuadEGA ProSync	339
TAXAN 555SP Color w/Par Port 169	
557 Gold Card - EGA	299
TAXAN 560 AutoSwitch - Same as	
Paradise AutoSwitch	279
VIDEO-7 Vega Delux	319
MICROSOFT Windows	80
With Any EGA Card	65

BACKUP	
ALLOY Internal Tape Backup	
1/2 Ht - Uses Floppy Controller	
w/software & 1 Cartridge	
20/25 Mb for PC/XT or AT	359
40 Mb for XT or AT	459
ARCHIVE Internal Tape Backup	
1/2 Ht - Uses Floppy Controller	
w/software & 1 Cartridge	
40 Mb for PC/XT	459
40 Mb for AT	499
EVEREX Tape Backup	
20 Mb Internal	579
20 Mb External	669
60 Mb Internal	799
60 Mb External	899
60 Mb Ext w/QIC Cont	949
Extra QIC Controller	129
Extra Backup Cartridges	CALL

MODEMS	
EVEREX Internal 1/2 Card	
Hayes Compatible w/software	
1200 Bd	\$99
2400 Bd	199
HAYES 1200B w/smartcom II 319	
1200 Ext	369
2400B w/smartcom II	569
2400 Ext	599
MIGENT pocket Modem	CALL
PRENTICE POPCOM 1200 Int	249
POPCOM 1200 Ext	249
POPCOM Int w/PFS: Access	299
POPCOM Ext w/PFS: Access	299

KEYBOARD/MOUSE	
IBM PC Original Keyboard	\$149
KEYTRONIC 5151 PC/XT	159
5151 for AT	179
I M S I Mouse w/Dr Halo II	79
Optimouse Ser w/Dr. Halo II	109
Optimouse Bus w/Dr Halo II	139
LOGITECH C7 Ser w/Plus	79
C7 Ser w/Logipaint	99
C7 Ser w/Dr Halo II	99
BUS w/Logipaint	99
MICROSOFT Mouse	
Serial/Bus	119/109
MOUSE SYSTEMS PC Mouse	
Ser w/New PopUp Menu	99
PC Mouse Ser w/Dr Halo II	109
Bus + w/Designer PopUp Menu	109
SUMMAGRAPHICS	
Summa Mouse serial w/Pad	85

CHIPS ETC	
64k RAM set of 9	\$15
256k RAM Set of 9	30
8087-3 PC/XT 5 Mhz	109
8087-2 PC/XT 8 Mhz	139
80287-3 AT 6 Mhz	159
80287-8 AT 8 Mhz	259
80287-10 AT 10 Mhz	299
Inboard 386/AT Coprocessor	399

POWER	
REPLACEMENT POWER SUPPLIES	
With 4 pwr/drive connectors	
150/200 Watts	\$69/99
COMPUTER ACCESSORIES	
Power Director P2/P15	\$89/99
DATASHIELD	
300 Watts Backup	369
350 Turbo Backup	499
500/800 Watts Backup	599/699
NEW Solid State 3" High UPS	
SS 400 Watts UPS	699
SS 700 Watts UPS	899
KENSINGTON Masterpiece	99
Masterpiece Plus	119
NEW Masterpiece Remote	119
MINUTEMAN	
250/300 Watts Backup	299/469
500/1000 Watts Backup	599/1199

LASER PRINTERS	
LASER CONNECTION	
Post Script PSJet Printer	3699
PS Jet (Adds Post Script) to H-P	
Canon, QMS Kiss Lasers	1999
NEW QUADLASER-LS1100	3199
3 DAY AIR EXPRESS	
TO WESTERN EUROPE	

FEDERAL EXPRESS	
Available	
POLICY: Min order \$50. Prices & availability subject to change. Shipping charges vary. Prices reflect discount for advance payment. Personal/company checks take 3 weeks to clear. Add 1% (Min \$5) for COD. 2% for Discover, MC & Visa and 4% for Amex. COD requires cash or cashier check. No showroom, demos or walk-in sales. Open acct PO min order \$1000. call for requirements & special prices. All sales final. Refused shipments subject to a 20% charge (Min \$50). Not responsible for compatibility.	
FOR ADVANCE PAYMENT OR PICKUP, PLEASE CALL FIRST FOR WORKORDER #.	

COPIERS	
CANON P-25	899
SHARP Z-50	599
Cartridges	CALL

FAX MACHINES	
AT&T 3510 D	\$1999
CANON FaxPhone 10	1599
SHARP FO 200	1399
SHARP FO 620	1199
FAX Paper	CALL
COD American Express	
Discover MC VISA	

MICROBEST 714-897-2100

12605 HOOVER STREET, GARDEN GROVE, CA 92641 PLEASE REFER TO AD # BSC 792

**COMES THE
MOST VERSATILE & POWERFUL
COMPUTER...**



**THE LEADING EDGE®
INFINITE MEMORY
SYSTEM™**

- Fully configured Leading Edge Model "D"™ personal computer
- 360K Floppy drive
- One Leading Edge™ Infinite Memory Drive™ featuring Bernoulli technology (40 ms ave access time)
- Two 20MB removable Leading Edge™ Infinite Memory Cartridges™
- Complete documentation

LIST \$1995

CALL FOR BEST PRICE

**INTRODUCING TECHNOLOGY SO
ADVANCED,
IT'S AFFORDABLE.**

**ATARI®
520ST**

**BUILT FOR HOME &
BUSINESS**

- 68000 Microprocessor
- 512K memory
- CPU with RF modulator
- Single-sided disk drive (360K)
- Mouse
- Monochrome monitor

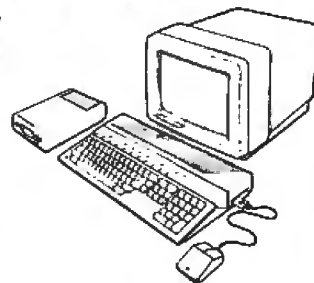

COLOR SYSTEM

\$799

\$499

**ATARI®
1040ST™**

**BUILT FOR BUSINESS,
ENGINEERING &
EDUCATION**

- 68000 Microprocessor
- 1 MB memory
- CPU with built-in double sided drive (720K)
- Mouse
- Monochrome monitor

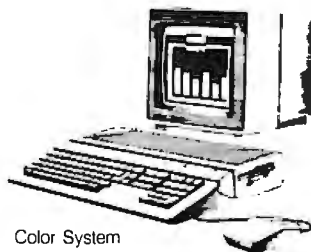

Color System

\$995

\$849

- ★ ATARI ST comes standard with parallel & serial ports. MIDI I/O ports, game port & mouse port
- 20% off ST software (except Antic)
- Desktop Publishing software in stock Publishing Partner \$119.95
- DAC Easy Accounting software \$79.95
- 1200 B modem \$99.00



LEADING EDGE™

DUAL SPEED MODEL "D"™

- 4.77 MHz & 7.16 MHz
- Complete 2 floppy system
- Hi-res TTL monitor
- Printer with cable
- 10 disks & paper
- Software



\$1170 or **\$44.56/month**
3 yr. financing

OPTIONAL UPGRADES:

- LEADING EDGE 1200B MODEM \$100
- 30MB HARD DISK W/INSTALLATION \$475
- 20MB HARD DISK W/INSTALLATION . . . \$375
- COLOR MONITOR UPGRADE . . . \$225

Price includes printer, monitor, keyboard, parallel & serial port, clock/calendar, MSDOS, GW-BASIC, word processor, cable, accessory

Leading Edge and logo and Model "D" are registered trademarks and Leading Edge, Infinite Memory System, Infinite Memory Drive, Infinite Memory Cartridge are trademarks of Leading Edge Products, Inc. Bernoulli Technology is a registered trademark of Iomega Corp. MS-DOS and GW Basic are registered trademarks of Microsoft Corp.



LEADING EDGE
AUTHORIZED RETAIL DEALER

90 days same as cash financing upon credit approval

(818) 282-6110 • (818) 282-4592

INFOTRONICS COMPUTERS

315 EAST MAIN STREET, ALHAMBRA, CA 91801

Inquiry 435

MON-FRI: 10 AM-7 PM • SAT 10 AM-6 PM • CLOSED ON SUNDAYS



EX-1000

- 9 PIN DOT MATRIX
- COLOR CAPABILITY
- 300 CPS (DRAFT)/60 CPS (NLQ)
- PARALLEL & SERIAL

\$544

**EPSON
PRINTER**



LQ-800

- 24 PIN LETTER QUALITY
- 180 CPS (DRAFT)/60 CPS (LQ)
- 7K BUFFER
- PARALLEL & SERIAL

\$475



GQ-3500

- NEW LASER PRINTER
- 6 PAGE PER MINUTE
- 300 DOTS PER INCH
- 470 KB INTERNAL BUFFER

\$ BEST

IC CARD

HP LASER JET PLUS™
OR DIABLO™
630 EMULATION

\$ CALL

**BLUE CHIP BY HYUNDAI
COMPUTER**

- 8088 MICROPROCESSOR
- 512K RAM
- 360K FLOPPY DRIVE
- PARALLEL/SERIAL PORTS
- 6 EXPANSION SLOTS
- 130 W POWER SUPPLY
- HI-RES HERCULES GRAPHIC CARD
- DOS 3.2 **\$579**
- BLUE CHIP HI-RES GREEN MONITOR \$79

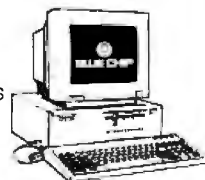

CLONE MASTER

AT CLONE \$1269

640K, 6 & 10 MHZ, 1.2 MB FLOPPY
WD-2 CONTROLLER, AT KEYBOARD
MONO GRAPHIC CARD & MONO MONITOR

COLOR TURBO XT V-20, 1MB RAM 360K FLOPPY 150 W POWER SUPPLY AT KEYBOARD COLOR CARD RGB MONITOR \$845	PC/XT CLONE 640K RAM DUAL FLOPPY 150 W POWER SUPPLY AT KEYBOARD MONO CARD MONO MONITOR \$595
--	--



COLOR
OPT. KIT
\$75

MODEL	PERFORMANCE	PRICE	MODEL	PERFORMANCE	PRICE
HS-80	LETTERJET, PORTABLE	\$219	LQ-800	180/60 CPS, 24 PIN, 80 COL	\$475
HI-80	PLOTTER, 80 COL	CALL	LQ-1000	180/60 CPS, 24 PIN, 136 COL	\$654
LX-86	120/16 CPS, 9 PIN, 80 COL	\$189	LQ-2500	324/108 CPS, 24 PIN, 136 COL	\$968
FX-86E	240/48 CPS, 9 PIN, 80 COL	\$344	EX-800	300/60 CPS, 9 PIN, 80 COL	\$414
FX-286E	240/48 CPS, 9 PIN, 136 COL	\$484	EX-1000	300/60 CPS, 9 PIN, 136 COL	\$544

EPSON PRINTER RIBBON, STAND, TRACTOR, CUT SHEET FEEDER IN STOCK!

C M LAB (818) 282-9403

P.O. BOX 7148, ALHAMBRA, CA 91802-7148
MANUFACTURER / DISTRIBUTOR

CALL FOR VOLUME
DISCOUNT

SAME DAY SHIPPING

MON-SAT 9 A.M.-6 P.M.
(PACIFIC TIME)

Inquiry 446

PARTS & PERIPHERALS (Qty. 25 +)

TURBO 640 K MOTHERBOARD	\$89
MONO CARD & PRINTER PORT	\$52
COLOR GRAPHIC CARD	\$44
MULTI-FUNCTION CARD	\$70
I/O CARD	\$60
PARALLEL CARD	\$15
SERIAL CARD	\$22
DUAL GAME PORT	\$15
AB SWITCH FOR PRINTER	\$30
6' PRINTER CABLE	\$ 6

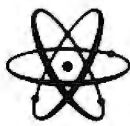

Compusat

Computer Services Advanced Technology

Call: (213) 676-4766

COMPUSAT BASIC XT	\$399	COMPUSAT COMPLETE XT	\$699	COMPUSAT AT	\$1269	TRUE IBM XT	\$1299
<ul style="list-style-type: none"> • 4.77 Mhz • 256k RAM • One 360k Drive • XT/AT Keyboard • 8 Expansion Slots • 150W Power Supply 		<ul style="list-style-type: none"> • 4.77/8 Mhz • 640k RAM • One 360k Drive • XT/AT Keyboard • 8 Expansion Slots • 150W Power Supply • Clock/Calendar • Parallel/Serial/ Game Port • Monochrome Card • Samsung Monitor 		<ul style="list-style-type: none"> • 6/10 Mhz • 512k RAM • One 1.2M Drive • XT/AT Keyboard • 8 Expansion Slots • 200W Power Supply • Clock/Calendar • Parallel Port • Monochrome Card • Samsung Monitor 		<ul style="list-style-type: none"> • 256k RAM • One 360K Drive • 20MB Hard Drive 	
						NEW	
						IBM SYSTEM 2 MODEL 30	
						<ul style="list-style-type: none"> • 8086 Microprocessor • 8 Mhz, 640k memory • EGA, CGA, MGA (Built-in) • Two 3.5" 790k Drives • One 3.5" 720k w/20MB Hard 	
w/Samsung Monitor	\$549	Two Drive System	\$749	40 MB System	\$1799	CALL FOR BEST PRICING	

DRIVES

Fujitsu 360k.....	\$ 85
TEAC 360k.....	89
10MB w/controller.....	269
20MB w/controller.....	359
30MB w/controller.....	409
30MB (AT).....	549

HAYES COMPATIBLE MODEMS

2400 Baud.....	\$239
1200 Baud.....	99

MONITORS

Color RGB (Hi-Res).....	\$289
SAMSUNG	
Flat-Screen (Mono)....	\$ 99
CD-1452 (EGA).....	399
PRINCETON	
Max-12 (Mono).....	\$169
HX-12E (EGA).....	499
TAXAN	
T124 (Mono).....	\$119
T720 (RGB).....	349
NEC Multisync.....	549

TOSHIBA T1100 + LAPTOP PORTABLE \$1599

640K RAM, dual 3.5" drives, Batteries, Serial/parallel ports, Composite/RGB video ports, 80x25 LCD display

NEC MULTISPEED LAPTOP PORTABLE \$1499

640K RAM, dual 3.5" drives, 4.77/9.45 Mhz, LCD Display

COMPUTER TRAINING CLASSES

We offer the same training programs that are used nationwide at such places as, Ohio State University, Monsanto Corporation, Nellis AFB, F.E. Warren AFB, and even the U.S. Navy. We have courses in MS-DOS, LOTUS-123, DISPLAYWRITE, and WORDSTAR. Call or write for complete course descriptions and schedules.

OUR COURSES INCLUDE:

- An easy to read and understand workbook
- Visual aids to help make learning easier
- "Hands-On" experience at your own terminal
- 15% corporate discounts

AVAILABLE COURSES:
MS-DOS • LOTUS-123 • WORDSTAR • DISPLAYWRITE

Here at Compusat we meet the demand for comprehensive, professional personal computer training. Sign up today!

PRINTERS

CITIZEN	
MSP-10.....	\$289
Premier 35.....	475
EPSON	
LX-86.....	\$239
LQ-800.....	529
LQ-1000.....	689
LQ-1500.....	895
OKIDATA	
ML192.....	\$379
ML193.....	549
ML292.....	559
TOSHIBA	
P321.....	\$459
P341E.....	768
P351.....	999
SEIKO	
MP 180.....	\$159

MS-DOS

3.2 w/GWBASIC.....	\$75
3.1.....	35

TERMS:
WE ACCEPT PURCHASE ORDERS, CASH, CHECK, MONEY ORDERS AND MAJOR CREDIT CARDS. PRICES ARE SUBJECT TO CHANGE AND DO NOT INCLUDE SALES TAX.



Call: (213) 676-4766

Visit our newest location:

12824 Inglewood Ave. / Hawthorne, CA 90250



Compusat
Computer Services Advanced Technology

WordPerfect Now Easy To Learn

*Hands On Learning
Holds Interest, Saves
Time and Money*

"It's amazing" says one manager at an east coast pharmaceutical company, "employees using the learning disks get so involved they stay after hours. You just can't walk away from it". A patent lawyer liked it so much he bought a copy for his mother.

Novices Become Experts

WordPerfect users need help getting started. The All-Hands-On Learning Disk is a private tutor for WordPerfect users: it provides complete, in depth training in all WordPerfect's capabilities.

Learn By Doing It Right

The Learning Disk works directly with WordPerfect. It is not a simulation. By doing real work correctly the first time, learning time is dramatically reduced, while retention is improved by as much as 300%.

The Best Way to Learn

PC Magazine calls the Learning Disk "more thorough, more interesting, & more enjoyable than the others." It's the fastest and best way to learn WordPerfect. And the training experts who designed the disk are so confident of its effectiveness that we offer a **30 day Money Back Guarantee**. Order now. Send in the coupon below or call

800-537-0040.

Network versions and site licenses are available. Please call for more information.

Send the All Hands On WordPerfect Learning Disk for WordPerfect version 4.1 or 4.2 for \$79 plus \$3 shipping/handling.

Name _____

Company _____

Address _____

City _____ State _____ Zip _____

Phone _____

Check enclosed Visa MC

Card # _____

Expiration Date _____

CALL 800-537-0040

Hands On Learning Corporation
Three Courthouse Lane - Dept. B6
Chelmsford, MA 01824

Career Advancement



Hands On Learning Corporation can teach you C from your TV screen

Learn C by Video

*Acclaimed Video Course Speeds Learning And
Boosts Earnings — Now Available for Rent*

"It's fantastic!" says Barry Pronk, now a systems programmer at a Miami optical firm. "I couldn't afford \$1000 for a week-long C course, and most books on C left me cold. But the C Video Workshop, helped me to round out my programming background."

The Developers Choice

C Language is the choice of software developers around the world who like its power and portability. But new C programmers often hit snags getting up to speed because C can be tricky to learn.

Learn at Home or Work

Now finally, the All-Hands-On C Video Workshop makes it possible for you to *learn C language at home or at work, quickly, economically, and enjoyably*. The All-Hands-On C Video Workshop contains six one hour modules that capture the essence of a 5-day C Language course. You will learn all features of C from operators and expressions through pointers and structures.

The Corporate Standard

The C Video Workshop is in use at hundreds of corporations like DEC, IBM, and Lotus. They find it to be the most comprehensive C course ever, and the first video package programmers like enough to finish. "This production is educational *and* fun to watch. Other video courses just left our staff yawning.", says one training manager.

Great Student Materials

Previously only available for sale, the Workshop is now offered for use by individuals on a *rental* basis. Tuition for the Workshop is \$99.95. The tuition includes the rental of the course for two weeks, and a set of student materials containing Learning to Program in C by Dr. T. Plum, the C Video Workbook and the C Video WorkDisk - all of which are yours to keep. Order now!

Call 800-537-0040 or send in the coupon below.

Purchase option also available - call for more information

Send me the All-Hands-On C Video rental kit in VHS or Beta format. The tuition is \$99.95 plus \$12 shipping/handling and includes two week tape rental plus student materials (Student materials are mine to keep).

Name _____

Address _____

City _____ State _____ Zip _____

Phone _____

Check enclosed Visa MC

Card Number _____

Expiration Date _____

Hands On Learning Corporation
Three Courthouse Lane
Dept. B5
Chelmsford, MA 01824

Buy dBASE III+ Get dBook Free!

\$394



**Buy the World's Best Selling Relational Data Base
from your Best Software Source, and get your choice
of one of these books, absolutely free!**

Advanced Programmer's Guide Featuring dBASE III and dBASE II

By Luis Castro, Jay Hanson and Tom Rettig
Suggested List Price \$28.95

A technical reference for intermediate and advanced programmers familiar with dBASE®. Authored by the Ashton-Tate® Software Support Center and independent dBASE consultants. Contains over 650 pages on debugging techniques, subroutines, structured programming, terminal codes, reserved words, and much more. Consistently hailed as the most comprehensive dBASE programming book available.



dBASE III PLUS Programming: Tips and Techniques

By Cary N. Prague and James E. Hammitt
Suggested List Price \$19.95

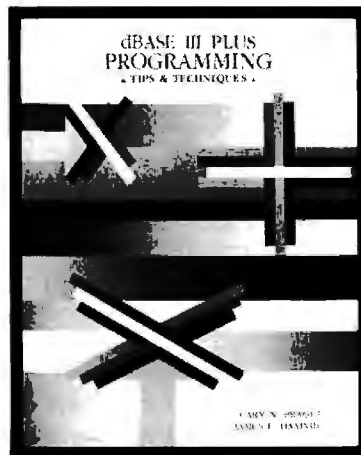

Filled with programming routines, applications tips, and techniques, this is an ideal book for new users of dBASE III PLUS as well as dBASE veterans. Look for tips and techniques on dBASE III PLUS commands, database management, menu systems, screen programming, applications development methods, and more.

•To Order Call Toll Free 800-227-4587•

•For Information On Corporate Accounts Call 800-872-2667 (US) • 800-225-9273 (CA)•

800-SOFTWARE

•940 Dwight Way, Berkeley, CA 94710 • 415-644-3611•
•11645 Wilshire Blvd., Los Angeles, CA 90025 • 213-820-8009•

Ashton-Tate, dBASE, dBASE II, dBASE III and dBASE III PLUS are registered trademarks of Ashton-Tate

Limited Edition **BYTE** Collector Prints

#A



Intelligent Reflections

#B



Storage Space



Technological Breakthrough

#C



Number Crunching

#D

Popular *Byte* cover artist Robert Tinney proudly offers these flawless art prints, each individually signed and numbered, and part of an edition strictly limited to 1000 prints. Each is printed on 16" x 20", museum grade acid-free stock to ensure brilliance and flexibility for decades to come. The color separations for these sumptuous prints are made *directly from the original paintings*, helping to guarantee accurate reproduction. Robert Tinney himself personally inspects, signs and numbers each individual print, along with a Certificate of Authenticity which certifies the number limit and the destruction of the press plates.

The price of these beautiful limited editions is just \$55, or \$45 each if you order two or more. Your prints will be shipped flat via UPS Blue Label (2-day delivery), and carry an unconditional 30-day guarantee. VISA, MasterCard or AmEx orders may call 1-504-272-7266 daytime or evenings. Order now!

ORDER FORM

Send me the following Prints at \$55, or \$45 each for 2 or more.

QTY	Title and #	Amount
_____	_____	\$ _____
_____	_____	\$ _____
_____	_____	\$ _____
\$4 postage & handling (\$15 overseas)		\$ _____
Total		\$ _____

- I have enclosed check or money order to Robert Tinney Graphics.
 Please send my prints C.O.D. (UPS — include street address).
 Bill my VISA MasterCard American Express account.

Card No.: _____ Expires: _____

Name: _____

Address: _____

City: _____ State: _____ Zip: _____

- Please send me your FREE color brochure.



ROBERT TINNEY GRAPHICS
 1864 N. Pamela Dr.
 Baton Rouge, Louisiana 70815

Limited Edition **BYTE** Covers

Captivating 16" x 20" Prints
 of *Byte*'s most popular covers!

Imagine your favorite *Byte* covers as exquisite limited edition prints, attractively exhibited in your office or study! Only 1000 (or less) of selected *Byte* covers are issued every year, and each is personally inspected, signed and numbered by artist Robert Tinney.

The color separations for these fine prints are made *from the original paintings*, thus ensuring the utmost in color fidelity. The printing stock is a museum quality acid-free paper produced especially for its permanence. Accompanying each beautiful art print is a Certificate of Authenticity, also bearing Tinney's personal signature, which certifies the edition limit and the destruction of the press plates.

Prices for these investment quality prints are extremely reasonable: only \$55 for prints such as you see pictured here (\$45 each for two or more), and even less for smaller prints also available. If you would like to consider an investment in one or more of these marvelous pieces, use the coupon below to send for our free color brochure. Or call 1-504-272-7266 daytime or evenings.



Shown here is Print #A, "Intelligent Reflections," in a double mat and metal frame (not included).

Yes! Send me your FREE color brochure.

Name: _____

Address: _____

City: _____ State: _____ Zip: _____

ROBERT TINNEY GRAPHICS
 1864 N. Pamela Dr.
 Baton Rouge, LA 70815 

COMPUTE WHILE YOU PRINT!

PrintQ®

FINALLY, A REAL MAINFRAME PRINT SPOOLER FOR YOUR IBM PC OR COMPATIBLE

If you spend part of your PC time running applications. Part of it printing. And a lot of time waiting...

Imagine a program that prints up to 10,000 pages while you run applications.

PrintQ does that. And more.

It's the first really complete print spooling subsystem for your PC. And your biggest time saver ever!

HOW PrintQ WORKS

Run your application programs as usual, but instead of stopping after the print command, keep right on computing! PrintQ intercepts the documents bound for the printer, spools them to disk, then prints them according to your commands.

NOT COPY PROTECTED

For users of IBM, PC, AT, XT, PCjr and most IBM compatibles.

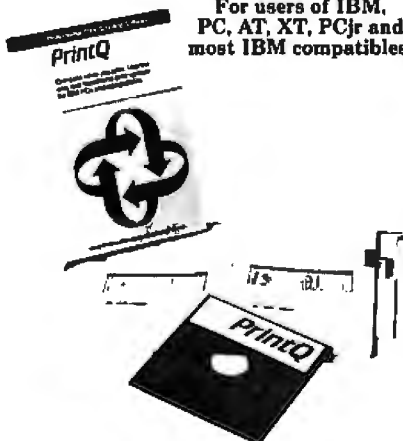

Dealer Inquiries Invited
Corporate Licensing Available



"Pop up" status display lets you monitor and control document printing at any time.

WITH PrintQ YOU CAN...

- Re-start printing from any page.
- View documents on screen with or without printing.
- Print up to 255 copies automatically.
- Save reports for reprinting.
- Minimize form changes. PrintQ groups similar documents.
- Print in order of priority.
- Simplify forms alignment.
- Work while printer is down.
- Copy reports to ASCII files.
- Control from within a batch file.
- Use any printer (including laser).
- No program modifications required.

...AND MUCH MORE.

"Using PrintQ could become very addicting, and users may never want to go back to ordinary printing again."

— PC Week

FULLY GUARANTEED

Use PrintQ. If you're not convinced PrintQ saves time, increases productivity and enhances printer function, return it within 30 days for a full refund.

Order now and you'll receive the PrintQ disk, complete easy to understand documentation, and the Quick Start Card which will have you reaping the benefits of PrintQ in seconds.

Call toll-free or mail the coupon to order now.

1-800-346-7638

In New Jersey Call **201-584-8466**

Same day shipping on phone orders

SDI Software Directions, Inc. 1572 Sussex Turnpike, Randolph, NJ 07869

YES. Rush me PrintQ for just \$89, which includes postage and handling (Canada — add \$10; Foreign — add \$20). If I'm not convinced PrintQ saves time, increases productivity and enhances printer function, I'll return it within 30 days for a full refund.

Name _____
 Company _____
 Address _____
 City _____ State _____ Zip _____
 Checkenclosed. Visa MasterCard AmEx.
 Acct. No. _____ Exp. date _____
 Signature _____ Phone# _____

BY 6/87

NJ residents add 6% sales tax.

IBM is a registered trade mark of International Business Machines Corporation.



TURBO XT

\$419

- 256K MEMORY (EXPANDABLE TO 640K)
- ONE 360K FLOPPY
- 150 WATT POWER SUPPLY
- AT STYLE CASE W/SPEAKER
- 4.77/8 MHZ CLOCK SPEED
- 8 EXPANSION SLOTS
- AT STYLE KEYBOARD
- HARD DRIVE, POWER, TURBO LED'S



SOFTWARE

WORD PROCESSING	
DISPLAY WRITE IV	\$335
MICROSOFT WORD 3.1	250
MULTIMATE/AOVANTAGE	239/299
PFS PROFESSIONAL WRITE	115
WORD PERFECT	209
WORDSTAR/PRO PAK	179/239
WORDSTAR 2000/2000 PLUS	245/289
DATABASE MANAGEMENT	
d BASE III PLUS	\$409
KNOWLEDGEMAN/2	309
PFS PROFESSIONAL FILE	145
PARADOX	395
R: BASE 5000/SYSTEM V	235/359
REFLEX	95
DATABASE MANAGEMENT ADD-ONS	
CLIPPER	\$349
EXT. REPORT WRITER	179
GENIFER	225
QUICKCODE III	149
QUICK REPORT	145
QUICKSILVER	379
SPREADSHEET/INTEGRATED	
ABILITY	\$69
ENABLE	345
FRAMEWORK II	419
LOTUS 1-2-3	319
MIRCROSOFT MULTIPLAN	119
PFS FIRST CHOICE	95
SUPERCALC IV (NEW)	225
SYMPHONY	449
SPREADSHEET ADD-ONS	
HAL	\$109
LOTUS REPORT WRITER	99
QUICKCODE FOR 1-2-3	85
SIDEWAYS	45
SPREADSHEET AUDITOR	95
GRAPHICS	
CHARTMASTER	\$215
DIAGRAM MASTER	195
ENERGRAPHICS (NEW)	309
FREELANCE PLUS	349
HARVARD PRESENTATION	249
MAP MASTER	229
SIGN MASTER	149
CAD/CAM	
GENERIC CAD	\$79
PRO DESIGN II	179
FIRST CAD	39
LANGUAGES	
(MS) BASIC COMPILER	\$255
(MS) C COMPILER (4.0)	279
(MS) COBOL COMPILER	425
(MS) FORTRAN COMPILER	279
LATTICE C COMPILER	249
(MS) MACRO ASSEMBLER	97
(MS) PASCAL COMPILER	183



IMSI MOUSE

\$89

- OPTI-MECHANICAL
- 3 BUTTON • 200 D.P.I.
- MICROSOFT COMPATIBLE
- BUNDLED W/DR. HALO II

MORE SOFTWARE

LANGUAGES (Cont'd)	
(MS) QUICK BASIC	67
TURBO C/BASIC	75/75
TURBO PASCAL (PLUS BCD & 8087)	59
PROJECT MANAGEMENT	
HARVARD TOTAL 2	LOW PRICE CALL
MICROSOFT PROJECT	\$239
SUPER PROJECT PLUS	299
FINANCIAL	
MANAGING YOUR MONEY	CALL
DOLLARS N' SENSE	\$107
ACCOUNTING	
COMPUTER ASSOCIATES	LOW PRICE CALL
OPEN SYSTEM (3.0)	419
MISC/UTILITIES	
CARBON COPY	\$139
CONCURRENT PC DOS	169
COPY II PC	35
CROSSTALK XVI	99
FASTBACK	95
MICROSOFT WINDOWS	67
NORTON COMMANDER	49
NORTON UTILITIES	55
PC DOS 32/MS DOS 3.2	85
REMOTE	149
SIDEKICK/TRAVELING SIDEKICK	55/49
SMART COM I	89
SUPERKEY	45

SYSTEMS

AT COMPATIBLE 8 MHZ	FROM	\$900
AT & T 6300	FROM	1299
COMPAQ DESKPRO 286/386		
PORTABLE II & III		CALL
IBM XT	FROM	\$1050
IBM AT 68	FROM	2500
IBM AT 339	FROM	4200
NEC MULTISPEED PORTABLE		1395
TOSHIBA 1100 PLUS		CALL
TOSHIBA 3100		2895
AST 286	AS LOW AS	1550

MODEMS

HAYES	CALL
MIGENT POCKET MODEM	CALL
US ROBOTICS 1200 INT	\$109
US ROBOTICS 2400 INT	189
ANCHOR AUTOMATION 1200 INT	109
ANCHOR AUTOMATION 1200 EXT	119

PRINTERS

HP LAZERJET II	\$1795
EPSON FX86	399
EPSON 286E	549
TOSHIBA EX800/1000	CALL
TOSHIBA P321/P321 SL	509/529
TOSHIBA P351	975
CITIZEN MSP 10/15	295/395
NOW FREE PRINTER CABLE W/PURCHASE	

MONITORS

MITSUBISHI EGA	CALL
NEC MULTISYNC	\$575
PRINCETON GRAPHICS	CALL
SONY EGA	CALL
TAXAN	CALL

DRIVES

FUJITSU 360K DS/DD	\$85
IRWIN 110 10MG TAPE BACKUP	319
IRWIN 120 20MG TAPE BACKUP	419
SEAGATE ST 225 W/CONTROLLER	339
SEAGATE ST 238 W/CONTROLLER	399
SEAGATE 4038	535
SEAGATE 4051	CALL
TEAC 360K DS/DD	99

POLICY: Add 3% (minimum \$7.00) shipping and handling. Larger shipments may require additional charges. Personal and company checks require 3 weeks to clear. For faster delivery send cashier's check or bank money order. Add 3% for COD deliveries. California residents add 6 1/2% sales tax. All prices are U.S.A. prices and are subject to change and all items are subject to availability. Defective software will be replaced with the same item only. Hardware will be replaced or repaired at our discretion within the terms and limits of the manufacturer's warranty. We cannot guarantee compatibility. All sales are final and returned shipments are subject to a restocking fee. IBM, Compaq, AT & T, Toshiba and NEC are trademarks of their respective companies.

STORE HOURS:
 MONDAY - FRIDAY 10 - 6 SATURDAY CALL
ORDER LINE HOURS:
 MONDAY - FRIDAY 8 - 6 SATURDAY CALL
STORE ADDRESS:
 20655 S. WESTERN AVE., #104
 TORRANCE, CA 90501

WE CARRY TOO MANY ITEMS TO LIST, PLEASE CALL FOR A QUOTE ON ANY ITEM.
(213) 618-8864

OUTSIDE CALIFORNIA CALL 800-482-3325

Now You Can Too.



EXTRA! EXTRA! combines the solid AT-level performance of the **KAYPRO 286i** and laser-jet **PAGE PRINTER II** with **Ventura Publisher** – the proven leader in desktop publishing software.

Get the extra advantage with EXTRA! EXTRA! from Kaypro. The only desktop publishing system that's complete, integrated and turn-key ready. Polished, professional documents produced quickly and at a fraction of the cost of printing and graphic design. EXTRA! EXTRA! Desktop Publishing. Learn all about it at your authorized EXTRA! EXTRA! Kaypro dealer.

KAYPRO[®]
COMPUTERS
The Future's Built In

KAYPRO
Lease-Link

Kaypro's Commercial Leasing

Ask about...



Kaypro's Revolving Charge Plan



made in U.S.A.

San Diego
Phase 5 Computers, Inc.
940 University Avenue
619-298-0705
Inquiry 439

San Diego
Byte & Floppy Computers, Inc.
9870 Hibert Street
619-271-0611
Inquiry 428

San Bernardino
Computer Nook
965 South "E" Street
714-381-3446
Inquiry 431

Garden Grove
Computer Applications
12792 Valley View
714-891-2001
Inquiry 430

La Crescenta
Basic Computers
3132 Foothill Blvd.
818-957-4515
Inquiry 427

Trademarks: IBM, AT, International Business Machines, Inc.; Ventura Publisher, Ventura Software, Inc.

**There's One More
Computer
Program
You
Need**

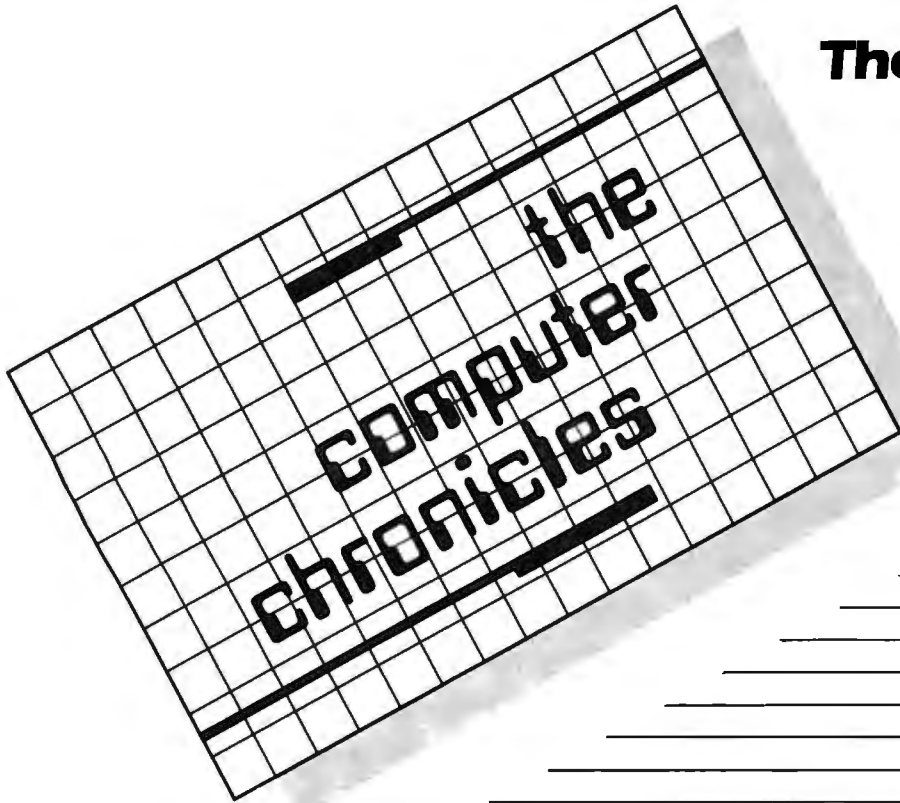

THE COMPUTER CHRONICLES, THE ONLY NATIONAL TELEVISION SERIES AIMED AT COMPUTER USERS, OWNERS, EDUCATORS AND COMPUTER INDUSTRY PROFESSIONALS. NOW IN ITS FOURTH SEASON ON PUBLIC TELEVISION.

CO-HOSTED BY GARY KILDALL AND STEWART CHEIFET, WITH COMMENTATOR GEORGE MORROW, THE COMPUTER CHRONICLES KEEPS YOU UP-TO-DATE ON THE EVER CHANGING WORLD OF COMPUTING.

THE COMPUTER CHRONICLES, PROGRAMMED WEEKLY BY COMPUTER PROFESSIONALS FOR COMPUTER USERS.



The Computer Chronicles is funded by **Leading Edge** and McGraw-Hill's **BYTE** magazine.

LEADING EDGE



Gary Kildall



Stewart Cheifet



George Morrow

TOPICS THIS SEASON INCLUDE:

EDUCATIONAL SOFTWARE • RISC • UTILITIES
DESKTOP PUBLISHING • GUIDE TO MACROS
RAM RESIDENT SOFTWARE • ON-LINE DATA BASES • MODEMS
PROJECT MANAGEMENT SOFTWARE • CD-ROMS
ARTIFICIAL INTELLIGENCE • PERSONAL CAD

PLUS...

RANDOM ACCESS

A WEEKLY NEWS SEGMENT DESIGNED TO KEEP YOU INFORMED ABOUT THE LATEST DEVELOPMENTS IN THE COMPUTER INDUSTRY.

The Computer Chronicles on PBS is a co-production of WITF/Harrisburg and KCSM/San Mateo.

BYTE LISTINGS YOUR WAY!

It's easy. Now there are three ways to get source-code listings that go with BYTE articles—on disk, in print or on line.

LISTINGS ON DISK

BYTE listings on disk are right for you if you want to compile or run programs quickly. Disks are now available by annual subscription as well as individual orders. BYTE offers listings in 11 popular disk formats.

LISTINGS IN PRINT

This print supplement contains source-code listings described in the issues of BYTE.

LISTINGS FROM BIX

(BYTE Information Exchange) By joining BIX, you can download BYTE source-code listings at standard BIX rates. See BIX informational ad listed in Reader Service index in this issue.



FOR DIRECT ORDERING CALL TOLL FREE: 800-258-5485

Call: M-F, 8:30 a.m. to 4:30 p.m. Eastern Time

(603-924-9281 for New Hampshire residents)

For credit card orders only.

ON DISK

Please send me single disks in the format checked for the following 1987 issues:

- | | |
|-----------------------------------|---------------------------------------|
| <input type="checkbox"/> January | <input type="checkbox"/> August |
| <input type="checkbox"/> February | <input type="checkbox"/> September |
| <input type="checkbox"/> March | <input type="checkbox"/> October |
| <input type="checkbox"/> April | <input type="checkbox"/> November |
| <input type="checkbox"/> May | <input type="checkbox"/> December |
| <input type="checkbox"/> June | <input type="checkbox"/> IBM PC Issue |
| <input type="checkbox"/> July | |

Disks of listings for December 1985 and all 1986 issues are available at the prices stated at the right. Please mark the appropriate format and note the issue date below.

Month _____
Year _____

	IN USA:		OUTSIDE USA:	
	Single Month (one disk)	Annual Subscription (13 disks)	Single Month (one disk)	Annual Subscription (13 disks)
5 1/4 inch: <input type="checkbox"/> IBM PC <input type="checkbox"/> Apple II <input type="checkbox"/> Kaypro 2 CP/M <input type="checkbox"/> Tandy Mod 4 <input type="checkbox"/> MS-DOS 8 Sector <input type="checkbox"/> TI Professional	<input type="checkbox"/> \$8.95	<input type="checkbox"/> \$69.95 (Save \$46.40)	<input type="checkbox"/> \$10.95	<input type="checkbox"/> \$89.95 (Save \$52.40)
3 1/2 inch: <input type="checkbox"/> Apple Macintosh <input type="checkbox"/> Atari ST <input type="checkbox"/> Amiga <input type="checkbox"/> HP 150 <input type="checkbox"/> IBM PS/2	<input type="checkbox"/> \$9.95	<input type="checkbox"/> \$79.95 (Save \$49.40)	<input type="checkbox"/> \$11.95	<input type="checkbox"/> \$99.95 (Save \$55.40)
8 inch: <input type="checkbox"/> CP/M	<input type="checkbox"/> \$9.95	<input type="checkbox"/> \$79.95 (Save \$49.40)	<input type="checkbox"/> \$11.95	<input type="checkbox"/> \$99.95 (Save \$55.40)

IN PRINT

1987 Annual Supplement Subscription Rates

IN USA:
only \$18.00
(Save \$9.80)

OUTSIDE USA:
only \$21.00
(Save \$10.80)

1987 Supplement Issues

IN USA:

- January through March 1987 for only \$6.95.
- April through June 1987 for only \$6.95.
- July through September 1987 for only \$6.95.
- October through December 1987 for only \$6.95.

OUTSIDE USA:

- January through March 1987 for only \$7.95.
- April through June 1987 for only \$7.95.
- June through September 1987 for only \$7.95.
- October through December 1987 for only \$7.95.

1986 Supplement Issues

IN USA:

- January through June 1986 for only \$8.95.
- July through September 1986 for only \$6.95.
- October through December 1986 for only \$6.95.
- 1986 Annual Subscription for only \$18.00 (Save \$4.85).

OUTSIDE USA:

- January through June for only \$9.95.
- June through September for only \$7.95.
- October through December for only \$7.95.
- 1986 Annual Subscription for only \$21.00 (Save \$4.85).

COMBINED DISK AND PRINT SUBSCRIPTION

Bundled together, giving you the convenience of disk-based source-code plus the ease of reference of print.

	IN USA:	OUTSIDE USA:
	Annual Subscription (13 disks & 4 Issues)	Annual Subscription (13 disks & 4 Issues)
5 1/4 inch: <input type="checkbox"/> IBM PC <input type="checkbox"/> Apple II <input type="checkbox"/> Kaypro 2 CP/M <input type="checkbox"/> Tandy Mod 4 <input type="checkbox"/> MS-DOS 8 Sector <input type="checkbox"/> TI Professional	<input type="checkbox"/> \$84.95 (Save \$59.20)	<input type="checkbox"/> \$104.95 (Save \$69.20)
3 1/2 inch: <input type="checkbox"/> Apple Macintosh <input type="checkbox"/> Atari ST <input type="checkbox"/> Amiga <input type="checkbox"/> HP 150 <input type="checkbox"/> IBM PS/2	<input type="checkbox"/> \$94.95 (Save \$62.20)	<input type="checkbox"/> \$114.95 (Save \$72.20)
8 inch: <input type="checkbox"/> CP/M	<input type="checkbox"/> \$94.95 (Save \$62.20)	<input type="checkbox"/> \$114.95 (Save \$72.20)

JUNE 1987

Name _____
 Address _____
 City _____ State _____ Zip _____
 County or Parish _____ Country _____
 Credit Card # _____
 Exp. Date _____ Signature _____ Date _____

- Check enclosed
- MasterCard
- VISA
- U.S. Funds enclosed (If ordering from outside the U.S. please remit in U.S. funds drawn on a U.S. bank. Thank you.)

Please allow 4-8 weeks for delivery.



FOLD
HERE

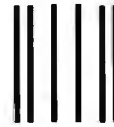

NO POSTAGE
NECESSARY
IF MAILED
IN THE
UNITED STATES

BUSINESS REPLY MAIL
FIRST CLASS MAIL PERMIT NO. 10 PETERBOROUGH, NH

POSTAGE WILL BE PAID BY ADDRESSEE

BYTE Listings

One Phoenix Mill Lane
Peterborough, NH 03458-9990

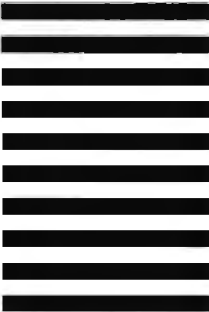

FOLD
HERE



AI, AI, Oh!

Ezra Shapiro

VP-Expert is an inexpensive expert-system program that actually works

I was originally going to title this month's column "Mostly MS-DOS" because two of the three products evaluated run on IBM PC-compatible machines, and I haven't been finding much of note in the DOS world to rave about recently. But the first package, VP-Expert, is classy enough to deserve its own headline. Maybe I'll use that "Mostly MS-DOS" head when I start getting tons of programs that take advantage of the real power of the Intel 80286 and 80386, but I'm not holding my breath.

AI for Everyone

For a while there, if you bought an expert system development package, you had to have it delivered by armored truck; programs started at two grand a pop and went from there through the roof. The more expensive products threw in a week or two of training for your personal knowledge engineer, but that was little solace. You couldn't fool around with artificial intelligence unless you were a reviewer, a LISP or Prolog programmer, or a multimillionaire. True, AI techniques were incorporated into programs like Symantec's Q&A and Lotus Development's HAL, but you were kept pretty far away from the guts of the programs.

VP-Expert (Paperback Software, \$99.95) strikes me as the first development package that has a chance to gain widespread public acceptance for microcomputer expert systems. The company has enough marketing and distribution muscle to get the product into circulation (muscle that earlier efforts have lacked), and VP-Expert is inexpensive enough to be purchased as an experiment. And it seems to be as powerful as competitive products costing thousands of dollars more.

So what exactly is an expert system? It's a collection of rules for analyzing data in much the same way a human expert would interpret it. An expert system is designed with a specific goal in mind,

like diagnosing a malfunctioning computer or suggesting the appropriate wine to drink with dinner. You enter what you know about a problem, and the expert system matches your information against its rules. If it can guide you to a solution, it does so, but it's "smart" enough to ask for more pieces of the puzzle if what you've provided is incomplete or inconclusive. The rules are merely a list of logical operations of the IF . . . THEN . . . ELSE sort, but you can build an intricate tree out of simple syllogisms.

The heart of VP-Expert is a backward-chaining inference engine capable of 20 levels of recursion. In a run-time session, you give it the particulars of a situation. The program starts with the first variable you fed in and tests it against the rules to see if it can match its goal; if it reaches a dead end, it backs up and tries again with a new branch of rules. This process continues with each variable until the program reaches a conclusion.

VP-Expert is something between a programming language and an application. You develop your rules with what is essentially an abbreviated language, with reserved words, variables, block procedures, and even a semicolon at the end of every line. However, you don't have to worry about file handling, I/O, or the actual interface; in that regard, VP-Expert is a lot like dBASE. You've got a built-in editor (though you can write your code with a program editor or a word processor in nondocument mode), a debugger that drops you back to the offending line if it spots a syntax error, and several forms of program tracing. When you're executing an expert system, you can stop the engine and ask it why it's doing something, and it will display the rule in question. You can even have it prepare a visu-

al display of the route it took to reach a conclusion, in either text or graphics.

The program interfaces nicely with VP-Planner, Paperback's spreadsheet, and VP-Info, the firm's database manager. VP-Expert can also make use of data files that follow either the .WKS (Lotus 1-2-3) or the .DBF (dBASE II or III) file format.

Therein lies much of VP-Expert's strength. If you can write generalized rules for your expert system, you can keep your specifics in a database or spreadsheet, thereby breaking your expert system into a "rule base" and a "knowledge base." When the expert data changes or grows, you don't have to worry about recoding your entire rule structure; you can just edit your database. And as VP-Expert itself can modify an external knowledge base, you can build a system that "learns": If you enter a set of conditions outside the program's experience, it can query you for more information and build the new case into its knowledge base.

VP-Expert gives you more latitude than one definite answer per question. "Plural variables" let the engine list all the possibilities that fit your query rather than stopping after it hits the first match in the knowledge base. You can also attach a "confidence factor" from 1 to 100 to any rule or variable, either in the expert system itself or as part of your run-time query. A high confidence factor indicates absolute certainty; the lower the factor, the less definite the conclusion.

VP-Expert will compute the overall confidence factor for any answer it generates, so you're not bound into a completely deterministic system. Although

continued

Ezra Shapiro is a consulting editor for BYTE. Contact him at P.O. Box 170040, San Francisco, CA 94117. Because of the volume of mail he receives, Ezra, regretfully, cannot respond to each inquiry.

If constructing an expert system from scratch strikes you as too much work, VP-Expert has a shortcut method of creating a rule base.

confidence factors are not true probabilities—they're merely a statistical representation of likelihood—you can get a good feel for the applicability of any answer the program derives.

If constructing an expert system from scratch strikes you as too much work, VP-Expert has a shortcut method of creating a rule base. You can develop a table of examples using the editor (or a program that generates pure ASCII, .DBF, or .WKS files) and have VP-Expert induce a set of rules from the data. You'll find that you have to edit the resulting rule base—to rephrase the questions the program asks the user at run time, format nice-looking menus, and so on—

but you can avoid having to develop the basic logic.

The documentation that comes with VP-Expert is top-rate. I read 200 pages of it before loading the program for the first time, and I found it to be as good a tutorial as I've seen in a while. There's also a full command-by-command reference section that makes terrible reading but is extremely useful when you're trying to use the product. There are quite a few examples of small systems on the disk, keyed to the tutorial. If you want to see an example of a big system, the package's help program is nothing but an expert system developed with VP-Expert. You can dissect and modify it if you like.

That's about it for the product description. I spent a couple of weeks playing with VP-Expert, and it performed exactly as advertised. The interface was clean, and I had no trouble running the sample files and building little expert systems of my own. However, I had neither the time nor the presence of mind to construct a large expert system, which is the real test of a program like this. I suspect that the use of database and spreadsheet files will make large systems possible, and also rather quick, but I can't make that claim from personal experience.

I do wish Paperback had included even more examples on the disk and a section in the manual suggesting possible uses for the program. This is a class of software unfamiliar to me, and I would have appreciated more guidance. My only objection to the program is that many of the sample expert systems deal with food choices; I kept wanting to leave the computer and go fix myself a snack.

The \$99.95 buys you a copy-protected disk; another \$10 (plus a signed license agreement) gets an unprotected disk. If you develop an expert system you'd like to sell to the world, you can purchase unlimited distribution rights to a run-time version of VP-Expert for \$500. Copies of the run-time program can be had for \$10 to \$4, depending on quantity, so you can run your expert system on several machines within your company. The run-time package includes an encryption utility, so nosy users can't mess with either your program or your data files; a welcome measure of security.

I am extremely curious to see what people do with this product. Will they construct expert front ends for traditional databases? Develop and market true expert systems? Or will they just let it gather dust on retailers' shelves? I have

THIRD GENERATION PROGRAMMERS FROM GTEK

GTEK MODEL 9000 (E)EPROM/MPU PROGRAMMER

If time is money, then let us save some for you. The new model 9000, using its quick pulse algorithms, can program a 2764 in 10 seconds. The 9000 offers higher performance than the competition has even begun to think about. Baud rates to 57,600. Supports thru 1024K standard, 8 meg worldwide parts with adapter, Cypress proms, mpu's. NO personality modules. As with our other programmers, RS-232, ASCII data formats, and flexible handshaking make the model 9000 compatible with virtually any computer.

Introductory price \$749

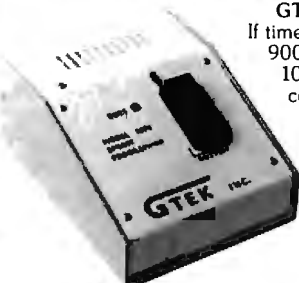

MODEL 7228 (E)EPROM/MPU PROGRAMMER

The standard by which other programmers are judged. With thousands in the field, the time proven 7228 has become our most popular programmer. Intelligent algorithms standard. Programs a 2764 in one minute. Supports devices thru 512K, mpu's, eeproms, cmos. NO personality modules.

price \$599.



MODEL 7965 GANG (E)EPROM/MPU PROGRAMMER

The 7965 can program eight 2764's in one minute using intelligent algorithms. Standard support thru 512K, eeproms, cmos, mpu's. A must for production environments. Available in stand alone configuration for \$ 979 or with RS-232 interface for \$1099

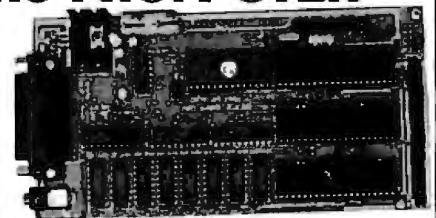

Single Board Computer Model 2010

- 64 to 256K bytes data or program ram.
- Use 2764 or 27512 eeprom or eeprom program memory.
- Uses single ended 9V @ 500 ma supply.
- Use 8031, 8032, 8751, 8752 mpu.
- 40 BIT programmable I/O lines.
- Expansion interface connector.
- Baud rates to 57,600 baud.
- Built in 5 volt regulator.
- Built in rom monitor.
- Small — 3.5 x 7 inches.
- 8052AH basic option with EEprom

ONLY \$299.00 WITH MANUAL

NEW "PX, XT, AT" PRODUCT

8 PORT RS232 BOARD — Completely DOS compatible. Satisfaction guaranteed. Call and ask about this new board.

\$495.00

GTEK

DEVELOPMENT HARDWARE & SOFTWARE

Drawer 1346, Bay St. Louis, MS 39520 U.S.A.

MS & Technical Support 1-601-467-8048; TELEX 315814 (GTEK UD)

INC. ORDER TOLL FREE 1-800-255-GTEK (4835)

GTEK, PALASM, CPM, MS-DOS, PC-DOS, ISIS, TRSDOS, & CPEmulator are registered trademarks

absolutely no idea. Is the world ready for low-cost AI? Time will tell.

Paint Wars

Well, I should have known. When I wrote in my February column that GraphicWorks and SuperPaint are complementary products that are both worthy successors to MacPaint, I had a sneaking hunch that they'd become head-to-head competitors eventually. Sure enough, the two products are now borrowing from each other like crazy. If this keeps up, they'll be identical before too long, and you'll have to base your decision on price and support rather than on features.

Right now, they're still leapingfrogging each other—one package gets ahead for a few months, then a new version of the other jumps out in front. All this is happening so quickly that I doubt I'll be able to keep up, and my lead time is relatively short; I write these columns only about three months before they appear in print. So I'm hesitant to say anything extreme about my beta version of **GraphicWorks 1.1** (Mindscape, \$79.95) because SuperPaint is bound to catch up soon.

I like version 1.1. As before, you get all the standard MacPaint features in an object-oriented environment. You can create your artwork piece by piece. When you overlay the pieces into a finished arrangement, you don't lose what's underneath the way you do with a bit-mapped paint program like MacPaint. You can reposition to your heart's content. There's that incredible variable airbrush tool, and overlaid objects can be masked in wonderful ways.

This release adds a long list of spiffy features to the product. You get the four precious ClickArt modification tools: free rotation (one of the biggest lacks in version 1.0), slant, perspective, and distort. You now get four palettes of patterns, including laser grays, Imagewriter II colors, and spaces for your own creations. GraphicWorks can import TIFF (Tag Image File Format) files from optical scanners and can edit at laser-printer resolution. Context-sensitive tool palettes change depending on the type of object you're manipulating, which ends a lot of confusion.

Nice rulers have been added, with sharp position arrows and a choice of dimensions. GraphicWorks can now import and export PICT data. Imported PICT files (like those from MacDraw) can be scaled but not edited; GraphicWorks objects exported via the clipboard move as PICT images rather than as bit maps, for cleaner scaling in their new home. A novel command lets you build objects as QuickDraw primitives; the major result of this is faster printing.

The product is faster than its predecessor, particularly with complicated documents. I no longer had the feeling that I was always ahead of the program. The high-resolution editing was easy to access and no problem to use, though I still get a bit lost trying to figure out appropriate scaling for printing to my QMS laser printer. Laser printing also seemed to be much quicker with this version. I still wish that the snap grid was more flexible and that it could be displayed in the painting areas instead of only on the background page, but the rulers are a big help for precision.

My favorite aspect of this package is still the airbrush, which can be set in 1-pixel increments from 1 to 96 pixels in diameter. The new contextual menus are quite good, and I had little trouble using the program even though they've added so many new features.

Once again, I'm impressed, but I cannot suppress the thought that this continuing quest for power is antithetical to the original purpose of MacPaint. MacPaint was limited, and hence very frustrating for the dedicated graphics professional, but it was intuitive, simple, and *fun*. It was the program you used to show off

continued

Items Discussed

GraphicWorks 1.1 \$79.95
Mindscape Inc.
3444 Dundee Rd.
Northbrook, IL 60062
(312) 480-7667

StarFixer \$29.95
Hard/Soft Press
P.O. Box 1277B
Riverdale, NY 10471
(800) 222-9409 (orders only)

SuperPaint \$99
Silicon Beach Software Inc.
9580 Black Mountain Rd., Suite E
San Diego, CA 92126
(619) 695-6956

VP-Expert \$99.95
Paperback Software International
2830 Ninth St.
Berkeley, CA 94710
(415) 644-2116

**High text.
Low cost.**

The Hercules® Text Card is perfect for word processing, spreadsheet and database management for 5 big reasons.

1. It has all the functionality of the IBM Monochrome Display Printer Adapter (MDA) Card.
2. It's fully compatible with all monochrome text software.
3. The Text Card features a parallel printer port.
4. It's Hercules quality in a half size card.
5. It comes with our usual two-year warranty.

And you can get all this at a perfectly reasonable price.

For the name of the dealer nearest you call
1-800-532-0600 Ext. 602
(in Canada 1-800-323-0601
Ext. 602)

Hercules Computer Technology
2550 Ninth Street
Berkeley, California 94710
Ph: (415) 540-6000 Telex: 754063
Trademark/Owner: IBM/IBM, Hercules/Hercules



Inquiry 127 for End-Users.
Inquiry 128 for DEALERS ONLY.

your Mac, and you could learn to use it in 10 minutes. GraphicWorks is getting to be a heavy-duty tool. That's fine if you're serious about your art, but what if you just want to have a good time? Maybe its designers should take a long look at Microsoft Word's "short menu" mode and see if they could give GraphicWorks a two-level interface, so that Mac graphics could again be fun for the rest of us.

WordStar Forever

WordStar 4.0 is supposed to arrive any day now, and I'm hoping I'll like it. The

announced list of features is long and commendable, so I've got my fingers crossed. However, if it isn't up to snuff, I've got my answer.

I'm having a delightful time with **StarFixer** (Hard/Soft Press, \$29.95 plus \$2 for postage), which I nominate as the best utility product ever for WordStar 3.3x. I admit those are pretty strong words, but this collection of programs is brilliant, even if the concept is so obvious that you'll wonder why nobody ever thought of it before.

Every grizzled WordStar user has had

to sweat through MicroPro's installation program. It takes forever, and when you're done, the Backspace and Delete keys still don't work correctly. Either you heave a resigned sigh and live with WordStar's oddities, or you learn about patching the program with a debugger (I include in this the "secret" patching commands within the installation program). Ever since MicroPro stopped giving away its technical reference notes as a freebie, WordStar patchers-to-be have had to scour the bulletin boards for tip sheets on the program's internals. The whole process could be a nightmare.

Those days are gone. StarFixer is a patching program that lets you modify almost anything you'd care to change in WordStar. What's more, it looks like WordStar, and most of its commands are similar to those of WordStar. When you enter a command, StarFixer patches your WS.COM. You proceed through the program as if you were preparing to edit a document: setting the margins, line spacing, and tabs; changing the help level; and so on. Only you're changing the defaults within WordStar itself. If you can use WordStar, you can use StarFixer.

You can also do something about WordStar's annoyances, like the Backspace/Delete problem, the length of time it takes to display menus and warnings on the screen, and that obnoxious sign-on message. A companion program, KeyFixer, lets you reconfigure your function keys and the numeric keypad and even add 10 shifted function keys. Other goodies in the package include batch files that will run Debug and install WordStar for a 42- or 43-line display on an enhanced graphics adapter monitor and RescueWS, a program that will grab an accidentally abandoned file out of memory after you've exited from WordStar.

These programs don't do everything (Did you know that it used to be a 1-byte patch to change WordStar from an MS-DOS to a CP/M-86 program?), but they come pretty darn close. And let's not forget the documentation, which is a treat to read even if you have no interest in running the utilities.

Steve Manes and Paul Somerson, who wrote StarFixer, are becoming the gurus of WordStar. As Ward Starr and Mel Murch, they were the authors of the wonderful *Underground WordStar*, a compendium of tips, tricks, and folk wisdom about their favorite word processor. When you buy StarFixer, they throw in an expanded revision of that classic. Its breezy, irreverent style should serve as a lesson to the authors of all computer documentation.

Do I like this program? Take a wild guess. ■

HIGH
POWER



Microstat®

WITHOUT THE HIGH PRICE

Microstat® has been the most popular statistics package for microcomputers since we introduced it in 1978. In the past three years, Microstat has been requested by name on more military contracts than any other statistics package. When it comes to coverage, ease of use, accuracy, and value, Microstat is unbeatable. Just some of its features include:

- Data Management Subsystem for file creation and management.
- Data Transformations (use existing variables to create new ones)
- Hypothesis Testing (Mean and proportions)
- Three types of ANOVA
- Simple, Multiple, Stepwise Multiple Regression (Can process files larger than memory)
- 11 Nonparametric Tests
- Factorials, Permutations, Combinations
- Batch or Interactive Operation

- Does not require a hard disk to use
- Read external files (e.g., Lotus, dBaseII, ASCII)
- Descriptive Statistics
- Scatterplots
- Correlation Analysis
- Time Series
- 8 Probability Distributions
- Crosstabs and Chi-Square
- Frequency Distributions
- User's Manual

Microstat is available for MSDOS, PC DOS, CP/M80, CP/M86. The price is \$375.00. Multiple copy discounts and cost-effective site licenses are available. To order, call:

1-800-952-0472 (orders)

1-317-255-6476 (info)

ECOSOFT, INC.
6413 N. College Ave.
Indianapolis, IN 46220



InfoWorld
Software Report Card

MICROSTAT
ECOSOFT

Functionality: Unacceptable
Documentation: Poor
Ease of Use: Fair
Error Handling: Good
Support: Excellent

Reviewed March 18, 1981





ECOSOFT

Every month, BIX users (also known as BIXen), leave thousands of messages on BIX. These messages ask and answer questions, solve problems, and express often strongly held opinions. The Best of BIX is a look at some of the most interesting messages. This month's contributions come from the Macintosh, Amiga, and Atari conferences. If you'd like to join the BIX community, see the advertisement on page 337.

Macintosh..... 325
Atari ST 332
Amiga 334

MACINTOSH

Not surprisingly, Apple's introduction of the Macintosh SE and the Macintosh II has generated some lively discussion on BIX. The following threads include comments from BYTE Technical Editor Tom Thompson (coauthor of the SE/II preview in the April BYTE). Author Larry Loeb is writing a review of the SE, which will appear in a future issue. Here, you'll see his initial reactions after receiving the SE for review. There's a lively discussion of why the SE doesn't use a 68020 processor, plus questions and answers about Mac II memory expansion.

MACINTOSH SE, FIRST REACTIONS

macintosh/mac.se #2, from tom__thompson (Tom Thompson, BYTE Magazine), Tue Mar 3 08:37:27 1987.

We were able to acquire a Mac SE so that we could handle questions concerning it. We've had a day to examine it before sending it out for a thorough evaluation by Larry Loeb. Here's what we can report so far:

1) If you're going to get one of these puppies, MAKE SURE YOU ORDER A KEYBOARD. Apple has unbundled the keyboard from the machine, so you can pick from two types of keyboards. A good idea, but somebody should make sure you at least get a keyboard, because our SE arrived without one. Since the SE gets its keyboard I/O through the Apple Desktop Bus, using a regular Mac keyboard is out. To be fair, it might have been a logistics snag. Apple did FedEx us one that arrived the next day. It doesn't seem as solid as the old Mac keyboards. I'm a keyboard "banger" (as opposed to a typist), and I'm afraid some day this thing might cave in on me.

2) Using "Get Information," I obtained the following version numbers for the system files:

- System - 4.0
- Finder - 5.4
- Scrapbook - 2.1
- Imagewriter driver - 2.5
- LaserWriter driver - 3.3
- Laser Prep - 3.3

3) The control panel devices are broken down into separate units that the control panel summons up, apparently to provide device independence in future machines. There was no 16-MHz option anywhere in the control panel settings.

4) You now have a Restart and Shutdown option in the special menu on the Finder. Restart is the old shutdown option (the

machine reboots) and Shutdown preps the machine for powering down (closes files, etc.). Activating Shutdown blacks the screen, and you get a dialog box stating that the machine can safely be turned off.

5) The cooling fan sounds louder than I remembered during the Apple visits, but my memory. . .

6) Beepinit works OK with the SE. I installed the Road Runner "beeps" as the SysBeep with no problem. It's got a 68000, so things should be compatible, but remember the size of the ROMs has doubled.

macintosh/mac.se #3, from lloeb (Larry Loeb), Tue Mar 3 09:56:50 1987. A comment to message 2.

The mouse is different, too. It slopes down to the cord and isn't as boxy as the standard Mac mouse.

Sucking an 800K disk onto the hard disk took under 2 minutes.

I'm NOT giving it back.

macintosh/mac.se #4, from jamurphy (Joe Murphy), Tue Mar 3 12:06:32 1987. A comment to message 3.

Some questions. . .

A) It has a straight 7.8-MHz 68000, correct?

B) Does it still have the external drive connector? If so, does that mean more than two floppy drives are supported?

C) Is there an external jack for video, or is that only supported through the expansion card? (You need a card for an external monitor.) If so, will we see color video boards for the Mac SE?

D) Finally, if the clock is on the motherboard and will last 7 years, does that mean there is no way to replace it? Are they saying that in 7 years nobody will be using the Mac SE? (In other words, that this machine has a 7-year life span?)

The Mac 512KE is gone, what about the Mac Plus? Its days are definitely numbered.

macintosh/mac.se #5, from lloeb, Tue Mar 3 12:14:44 1987. A comment to message 4.

1) Yes.

2) The external disk drive connector is there. Dunno about supporting more than two drives, though.

3) No external video output.

4) Dealer will have to unsolder and DISPOSE of the lithium battery, which is considered hazardous waste material.

5) I have a functional Plus (hacked Mac, 1 meg with fan). I don't see its days numbered at all. I think there will be a lot of 512K-to-1-meg upgrading going on as the software that won't run on the 512K becomes more prevalent.

continued

macintosh/mac.se #7, from frankb (Frank Boosman), Tue Mar 3 12:59:01 1987. A comment to message 4.

The Macintosh 512KE is not gone. It is still being sold, and at the same price as before the announcements. The Macintosh Plus is still around, too, and again at the same price.

It's very possible that Apple might drop the 512KE this year, but they seem committed to the Plus remaining as an entry-level Macintosh.

macintosh/mac.se #8, from reviews6 (Joel West), Tue Mar 3 13:47:46 1987. A comment to message 7.

They have to keep the Plus, and probably the 512KE as long as they sell. Since they don't have clones to help them out, they must keep the entry-level buy-in price low, to allow universities and individuals to be able to buy SOMETHING, even if the price is less than optimal.

I think, having seen their announcement, that the Plus will remain until Apple decides to drop the price of the SE down into the Plus's range and use it as the entry-level machine. I don't expect a big glut of Pluses on the market - particularly with Apple's new SIMM (Single Inline Memory Module) memory upgrade - since they can be expanded using SCSI peripherals, and because everyone now needs an extra Plus around the office to be a filesaver.

I agree, the 512KE's days are numbered, but as long as they sell, Apple might as well continue to amortize their original Mac (128) tooling investment. Their main goals for 1987 would seem to be:

1. Standardize the 800K/HFS media.
2. Standardize the 128K ROM.
3. Standardize a new System (probably 4.1).
4. Ensure that all software runs on the new machines.

The 512KE doesn't hurt them, since it can meet 1, 2, and 3, and the lack of SCSI should be transparent to applications. 512K is still enough to do useful work, although MPW 2.0 will probably require a Plus or bigger.

Finally, in case you missed it, all Pluses are now shipping in gray, but I believe (I haven't seen one) the 512KE remains in beige. I think that says something about long-term plans.

MORE REACTIONS FROM THE REVIEWER

macintosh/mac.se #19, from lloeb, Wed Mar 4 13:05:00 1987.

It's been 24 hours since I ripped open the box. Time enough to look up and say "Is it good for you, too?"

It's a good thing Apple does not bundle the keyboard with the SE, because the one they sell now is not - ummmm - to my taste. (Sounds better than "It rots!" - no?) The space bar is too short, there's not enough tactile feedback on the keys. I keep mashing them into the circuit board without trying. Needs to be stiffer.

For the last year, my idea of a wonderful system was a Plus with an internal MicahDrive. It was fast, furious, and didn't bomb. Which, given the then-state-of-the-SCSI Manager, was a wondrous thing. The guy who did the software for that drive was sometime-BIXer Steve Brecher. The point is that the HD 20 SCSI in this beast works as fast as that. Apple has cleaned up the SCSI, true. But the elegance of how the drive is integrated into the rest of the system shows art. I wonder if Steve Wozniak did the drivers?

I still don't know what the Control key (not Open-Apple/CMD/Cloverleaf) does. KeyCaps isn't much help there. Matter of fact, there's this big arrow key on the top for Reset that doesn't make sense to me either. I think it works on the ADB stuff.

It's noisy. Steve Jobs wasn't totally wrong on this one folks. My machine has a system-saver fan on it that lets you know it's there, but it's unobtrusive. This one sounds like the noise the rocket ships make on Buster Crabbe-vintage Buck Rogers serials. Sort of a droning buzz that is starting to annoy me.

Nothing from the Loeb Archives has crashed on it so far with the exception of Psion chess. I'm still checking why. Maybe it needs its own system with it or a custom resource.

The guided tour that comes with it is cute, using the MacroMindTour engine. Great for that in-store demo, as it subtly shows off with animation and sound what the Mac concepts are. Should make a lot of novices look at a character-generated screen and say, "Why can't *that* one do what the Mac can?"

The 4.0 system seems rock solid. My favorite TMON tricks won't crash it. 4.0 was sent to developers in the last week (my copy was mangled; this happen to anyone else?), and 4.1 will show up with the II. We will THEN have a universal installation disk for all machines. I guess the Installer scripts will selectively patch and install for a specific machine. As supplied now, it's over 400K (!), so 800K drives are recommended before use.

68020 DEBATE

macintosh/mac.se #36, from rpierrehumbert \ (Raymond Pierrehumbert), Mon Mar 9 23:31:34 1987.

Why, oh why didn't Apple put a 68020 in there? The new expandability of the SE is okay for those of us using the Mac for floating-point number crunching, since it at least allows the addition of a coprocessor, but the 68000 will never come close to the power of the 68020 (and it doesn't work as gracefully with its coprocessor, either). Given the numerous cheap 68020 upgrades to the Mac Plus that claim backward compatibility (e.g., the Novy Systems board), it seems like it wouldn't have been so hard for the SE to have been designed around a 68020. Sure, the Mac II has a 68020, but it's expensive, big, and not portable. Has Apple forgotten the rest of us?

macintosh/mac.se #37, from lloeb, Tue Mar 10 09:07:53 1987. A comment to message 36.

No, they are leaving that niche for the third-party people like Levco. They are going to have enough headaches (Apple, that is) just supporting the II.

macintosh/mac.se #40, from reviews6, Tue Mar 10 13:19:56 1987. A comment to message 37.

Everyone keeps complaining, "Why isn't an SE a Macintosh II?"

Give me a break. Do you put a 302 Heml in a Chevette? If you want to go fast, Chevrolet will gladly sell you a Camaro or a Corvette. If you want luxury, their sister division has many different Cadillacs to choose from. If you want something small and cheap, you don't get fast.

I don't like the price of the Macintosh II (as someone who has to pay for one). But because of the 68020's power and additional costs, a 68020-based machine will be a high-end product for at least 2 years, more expensive by at least \$1K than a 68000 box. And if I'm going to have that kind of horsepower, I might as well shell out the additional \$500-\$1K for the expandability so I can extend the life of the machine indefinitely, add new peripherals, and so on.

continued

New! In•a•Vision is Compatible with AutoCAD

FREE AutoCAD Translator
Limited Offer

Complex Drawing Made Easy

We created In•a•Vision just for you. The engineer who needs more productive drafting support. The designer who needs versatility for alternate ideas or quick revisions. The architect who needs to manage a variety of working drawings. And the businessman who needs first-class presentation materials as well as detailed flow charts and organization charts.



Point. Click. Draw.

Now all you do to create complex technical drawings, systems designs, blueprints, diagrams, illustrations, and proposals is point, click and draw. With In•a•Vision's mouse support, windowing, icons,

and pull-down menus, you produce drawings more quickly, accurately and efficiently than ever before. In•a•Vision's advanced technology includes many features not found on comparable systems costing thousands more. For example, you can pan around in a user-definable drawing space up to 68" x 68" and zoom in on specific areas for



greater detail. Scale, rotate and dimension symbols, fill an area with your choices of pre-defined colors and patterns, as well as draw lines with multiple styles and widths. Other features include overlays, predefined and user-definable page sizes, rulers, grids, and templates to speed popular applications.

Multi-tasking in a PC-based CAD system.

In•a•Vision uses multi-tasking to enable you to continue drawing while printing hard copies or edit multiple drawings simultaneously.

FREE AutoCAD Translator from MICROGRAFX!

When you purchase In•a•Vision we'll give you a free copy of our new AutoCAD™ translator. The Micrografx AutoCAD TRANSLATOR (retail value \$100) bi-directionally transforms all drawing attributes including colors, line styles, overlays, fonts, views and object hierarchy. (Send



proof of purchase and your registration card to Micrografx and we'll return your free translator*.)

We're confident you'll agree — In•a•Vision will make your complex drawing tasks simple and make you more productive. Satisfaction guaranteed.

TO ORDER CALL: 800-272-3729

Demo disk** or brochure available to qualified customers. In Texas or for customer support, call (214) 234-1769.

MICROGRAFX, Inc., 1820 North Greenville Avenue, Richardson, Texas 75081.

Inquiry 184



(Most popular graphics cards, plotters, and printers supported.)
Microsoft Windows-compatible. Call for specific operating environment requirements.

*Offer good only on purchases after January 1, 1987

**Demo requires MS Windows. Full demonstration system for users without Windows available for \$49.00.

MICROGRAFX™
The Picture of Success.

AutoCAD is a trademark of Autodesk INC.

In•a•Vision, Micrografx AutoCAD TRANSLATOR, and MICROGRAFX are trademarks of MICROGRAFX, Inc.

Microsoft is a trademark of Microsoft, Inc.

The SE is the size it is because they wanted to keep a similar form factor; hence, one slot. If I had an SE, I would be torn between a 68020 board, a large-screen display, or IBM compatibility (8086+ floppy controller), so, clearly, one slot is not enough for long.

macintosh/mac.se #42, from tom__thompson, Tue Mar 10 16:49:36 1987. A comment to message 40.

My current feelings about the SE:

If you've already got a Mac, upgrade it as far as you can take it (to a Plus).

If you don't own a Mac, and have the bucks, get an SE. It has the better power supply, the slot, the improved bus bandwidth, and—most important—a better SCSI interface.

If you've really got to have the power of the Mac II, then money will be no object and you'll get the Mac II anyway.

This is **not** to knock the Mac SE (right, Larry?). See the don't-own-a-Mac statement above for confirmation.

macintosh/mac.se #43, from lloeb, Tue Mar 10 17:39:01 1987. A comment to message 42.

If you want most of a II without the color and limited expansion, but cheaper, get an SE and an accelerator board. And an internal hard disk.

macintosh/mac.se #44, from alf (Eric Klein), Tue Mar 10 20:08:46 1987. A comment to message 40.

I agree that it would have been ridiculous to have put the 68020 in both machines. If both machines had the 68020 chip, there really wouldn't be any big differences between the machines, except that one computer had one slot and the other had six. But Apple should have put a 12-MHz 68000 chip in the SE. This would help differentiate it from the Plus. Instead, Mac Plus sales will rapidly fade away because the main difference between the two machines is that one has no slots and the other has one slot. I don't understand why Apple underpowered the SE, unless they are trying to get us to spend the extra money on the II. (If this is their strategy, then I must admit that it will work over the long run.)

macintosh/mac.se #45, from lloeb, Tue Mar 10 20:37:29 1987. A comment to message 44.

A 12-MHz 68000 (or for that matter any clock cycle other than the standard one) probably would mean some current software wouldn't run. The clock speed on the SE **is** different, BTW. That's one of the ways they get the 75 percent CPU cycle, but they divide it down differently to get the standard Mac clock.

I think Apple wants to sell a lot of SEs to those people who are starting to think seriously about Macs in business and haven't bought Pluses. They can get a faster box and expand to MS-DOS through the port (and get those SEs **bought** by companies or institutions that have an MS-DOS fixation) while retaining Mac ease of use.

Scully has called the SE a "trojan computer." (One is tempted to make jokes about market penetration. . .) It will be easier for these machines to come in the front door of an MS-DOS shop.

macintosh/mac.se #46, from reviews6, Tue Mar 10 22:23:19 1987. A comment to message 44.

Everything I've seen suggests that Apple wanted the SE to be as compatible as possible. (Does it run Dark Castles? That indicates whether it has the alternate screen buffer.) This

allows them to introduce new technology and even kill the old machines without breaking everything in sight. After the HFS problems, Apple seems to be both pushing and pulling on compatibility. Pulling by desperately testing new machines with old software and building tons of compatibility kludges in the new machines just so badly written software will run.

(Also, to be fair, a lot of software was written before Apple had done their job on documentation, like the book *Inside Macintosh* and the Tech Notes, so the odds were stacked against the developer getting anything right.)

They are pushing by taking many of those problems discovered by its room full of testers and telling us what not to do anymore. That big mailing in late February was great, containing many specific problem descriptions (rather than vague, holier-than-thou admonishments) that can only help in writing better software.

But, as Larry noted, a 12-MHz 68000 would have reduced the number of programs that ran. I think it was a very shrewd move by Apple. Their new big seller will be compatible with all the old software, so their customers will be happy, but there will be enough IIs out there that developers will hear about those incompatibilities quickly and loudly enough. (Those of us frustrated by slow compiles will probably be among the first to buy the IIs, thus the developer may break his own software first.)

After a year of 68020 compatibility patch releases and speed calibrations, Apple could introduce a 68020 (68010 or 12-MHz 68000) as their baseline machine, replacing the SE at MacWorld 1988 without breaking everything.

macintosh/mac.se #54, from nz__mhamel (Michael Hamel), Wed Mar 11 22:58:26 1987. A comment to message 46.

Er - what software wouldn't run at 12 MHz? And if it wouldn't, why does it work on the SE? I mean, Apple tells us to rely on software loops for timing, so are people doing this?

In my humble opinion, Apple should have made the 68000 in the SE run at, say (just off the top of my head), 11.7504 MHz.)

macintosh/mac.se #55, from reviews6, Thu Mar 12 01:48:45 1987. A comment to message 54.

I can't win at Dark Castles at 8 MHz, and I certainly couldn't at 12. Also, some dastardly copy-protection code is left.

Until Apple published a timing-loop calibration constant, the only way to do stuff smaller than 1/60 second (the Time Manager is buggy) was a DBA loop, which is directly proportional to the clock speed rather than clock time.

macintosh/mac.se #57, from tom__thompson, Thu Mar 12 08:30:31 1987. A comment to message 55.

Also, a number of hardware components, such as the Integrated Woz Machine and the video display, use the 8-MHz clock for their operations. Boosting the clock rate would break hardware as well as software. The same is true of the Mac II. It's no surprise that the clock rate is double the conventional Mac's clock rate and that there are a lot of divider circuits on the motherboard.

macintosh/mac.se #48, from Irozier (Laurence Rozier), Tue Mar 10 22:27:31 1987. A comment to message 44.

Given the current street pricing for the Plus, I don't think that the SE will swing a large percentage of sales away from the Plus for at least a year (at least in the L.A. area).

continued

"WINNING COLOR...AND IT CAME OUT OF A SHARP COPIER."

This is an unretouched copy made by Sharp's new full-color copier.

LeRoy Neiman

Sharp's new full-color business copier, with its advanced technology, makes all others seem obsolete.

It captures all the vibrance of the LeRoy Neiman original. That's winning color—color that's alive.

And it can reproduce your business documents with the same astonishing results. From layouts to computer graphics.

It also enlarges, reduces, copies slides and makes transparencies. All in winning full-color at a surprisingly low price.

See an authorized Sharp dealer for a demonstration. You'll wonder how you ever got along without it.

For more information, call 1-800-BE-SHARP, or mail coupon.



FREE! A 20" x 30" poster of LeRoy Neiman's "Winning Color" when you visit an authorized Sharp dealer for a full-color copier demonstration.



SHARP
FROM SHARP MINDS
COME SHARP PRODUCTS™

BY

Mr. James MacKenzie
General Manager, Copier Division
Sharp Electronics Corp.
Sharp Plaza, Mahwah, N.J. 07430
Please send me more information on Sharp's full-color copier.

NAME _____

TITLE _____ PHONE _____

COMPANY _____

ADDRESS _____

CITY _____ STATE _____ ZIP _____

macintosh/mac.se #50, from tom__thompson, Wed Mar 11 10:22:36 1987. A comment to message 44.

The slot in the SE is *not* a NuBus slot (as is the case with the Mac II). Both the SE and the Mac slots use the same Eurocard C connector, but don't make the mistake of thinking they're electrically identical. Also, the card must lie flat in the bottom of the SE, while it stands upright in the II.

macintosh/mac.se #53, from ccawfor (Chris Crawford), Wed Mar 11 21:19:27 1987. A comment to message 50.

At the SEF meeting the other night, somebody asked Scott Knaster what the technical designation for the bus on the SE is. Scott hardly blinked before shooting back, "Apple Macintosh SE Bus." There you have it, the official designation.

macintosh/mac.se #60, from rpierrehumbert \, Thu Mar 12 22:10:49 1987. A comment to message 44.

There is no good reason why a 68020 machine should cost that much more than a 68000 machine, since the chip price is such a small part of the total system cost. In short, the difference in price between a 68020 and a 68000 isn't much more than the difference between a turbo-charged Corvette engine and a Chevy V-6 (I say this not knowing anything much about car engines). Eric Klein's argument seems to be that Apple had to deliberately degrade the performance of the SE so that it would not compete with the II. I hope this is not what Apple is really doing to us. After all, Big Blue tried it with the PCjr (Let them eat chicklets!), and it didn't work.

macintosh/mac.se #38, from Irozier, Tue Mar 10 09:23:04 1987. A comment to message 36.

I've heard that Motorola wasn't ready to raise 68020 production to the level required for the SE. Price may also have been a factor, since the decision to go with the 68000 must have been made some time ago.

macintosh/mac.se #39, from lloeb, Tue Mar 10 10:42:38 1987. A comment to message 38.

Apple at one point shipped a machine to developers that was an SE with an 020 in it. Dunno if it was a marketing or technical decision, but Levco and others will give the SE owner the power of the 020/881 combo at probably a cheaper overall system price than a II.

macintosh/mac.se #58, from rpierrehumbert \ Thu Mar 12 22:03:09 1987. A comment to message 39.

But even if Levco can give you an 020/881 board to put in the SE, won't you be still limited by the 16-bit bus to memory and the basic 8-MHz clock?

macintosh/mac.se #59, from lloeb, Thu Mar 12 22:10:37 1987. A comment to message 58.

According to the Levco press release:

The 020 runs at 16 MHz and there is a 32-bit "internal memory-expansion bus for running additional high-speed memory modules, and a 16-bit I/O-expansion bus for connecting additional devices such as high-resolution monitors."

Looks like you get all the good stuff and none of the bad if you increase memory on the board rather than in the SE.

MACINTOSH II COLOR CAPABILITIES

macintosh/mac.ii #4, from cheath (Charlie Heath), Tue Mar 3 02:55:14 1987.

What *is* the color capability for the display card? I heard 16 colors. What are the color options? Are the color boards byte-per-pixel? What hardware blitting capabilities do they have?

macintosh/mac.ii #5, from tom__thompson, Tue Mar 3 08:13:30 1987. A comment to message 4.

The color card comes equipped with 256K bytes of memory giving it 4 bits per pixel (16 colors). You can expand this to 512K for 8 bits per pixel and 256 colors. If byte-per-pixel means "all color bits in one byte," the answer is yes (Apple calls this "chunked"). There's a special chip called the TFB that handles the display, but I don't know if you'd call it a blitter. The video-card documentation never mentioned blitting.

macintosh/mac.ii #6, from reviews6, Tue Mar 3. 12:47:26 1987 A comment to message 4.

The Macintosh II Video Card Expansion Kit, as listed, expands the standard display to support 256 colors instead of 16 colors.

And of course the number of colors is determined by the video card and the ability of the display to render those colors.

macintosh/mac.ii #7, from frankb, Tue Mar 3 13:04:53 1987. A comment to message 4.

There are no hardware blitting capabilities on the Macintosh II. Everything is still done in software. However, Apple has made it easy for third-party developers to integrate graphics coprocessors into their cards—especially the TMS34010, upon which the II's transfer modes are based—and has stated in materials sent to developers that they themselves were working on such a product.

Of course, said graphics coprocessors would be invisible to the system and applications. No modifications to applications software would be needed.

MAC II MOTHERBOARD MEMORY

macintosh/mac.ii #14, from alf, Thu Mar 5 18:54:44 1987.

I read that a Mac II can hold 8 megabytes of memory on its motherboard. Does this translate to 32 megabytes of memory with megabit chips?

macintosh/mac.ii #15, from bvanantwerp, Thu Mar 5 19:59:35 1987. A comment to message 14.

I believe that is with 1-megabyte chips.

macintosh/mac.ii #16, from reviews6, Fri Mar 6 03:25:50 1987. A comment to message 15.

The announcement suggests that the II uses the same 1-megabit SIMMs as are available for the Plus & SE.

macintosh/mac.ii #17, from tom__thompson, Fri Mar 6 10:37:22 1987. A comment to message 16.

There are two banks of memory on the Mac II motherboard. Using 256K-DRAM chips, that's a total of 2Mb. (Note that the base Mac II configuration comes with only one bank populated, or 1Mb.) As the memory density increases over the years, you can add more memory to the Mac II motherboard, like so:

continued

INTERESTED IN

HOT

NEW SOFTWARE TRENDS?

Look for BYTE's special issue "Application Software Today" at your favorite newsstand on June 17th.

BYTE announces the first "Application Software Today" issue—a special extra issue which will be sent to BYTE subscribers and be available on newsstands June 17, 1987.

In "Application Software Today", the BYTE editors will explore general software issues as well as take a comprehensive look at the most important application programs today. There will be feature articles discussing trends in

application software as well as comparative reviews where BYTE reviewers choose some of the best examples of a particular genre.

**REMEMBER:
"APPLICATION
SOFTWARE TODAY"
WILL BE ON SALE AT
YOUR NEWSSTAND
JUNE 17. BE THERE!**

BYTE 

- Learn how tomorrow's application software programs will help you cope with macro languages, conflicts among terminate-and-stay-resident programs, networking, and graphics.
- Learn about natural language front ends, telecommunications packages, unique spreadsheets, database management software models, criteria for picking accounting software, and more!

Don't miss out on this important issue. Copies will be on sale at B. Dalton and Waldenbooks as well as major newsstands and other bookstores.

1-Mbit chips --- 4Mb/8Mb where: memory bank 1/memory bank 2
 4-Mbit chips --- 16Mb/32Mb
 16-Mbit chips --- 64Mb/128Mb

Obviously, we don't have 4- or 16-Mbit chips yet, but the potential is there. Conceivably, you could add memory via NuBus, but then you've got to go through a number of additional bus cycles to access memory—meaning your best bet is to put it on the motherboard.

As an additional note, memory speeds on the new Macs have improved. To wit:

Old Mac and Mac Plus -	200-nsec memory
Mac SE	- 150-nsec memory
Mac II	- 120-nsec memory

Even with the faster memory, the Mac II uses two wait states for memory access: one wait state for address translation through the hardware memory mapper (HMMU) or 68851 (PMMU) and one wait state for memory.

macintosh/mac.ii #19, from rz__mhamel, Fri Mar 6 18:05:56 1987. A comment to message 17.

Interesting. Sun's 3-Series workstations get away with one wait state, I think. Also *my* Mac Plus seems to have 120-nsec chips in it. Nice to know they aren't needed. . .

macintosh/mac.ii #20, from alf, Fri Mar 6 19:07:56 1987. A comment to message 17.

How can you fit a 1-Mbit chip in the same spot that was meant for a 256K chip? I know it's possible, but I can't figure out how it's done. Also, it's interesting that the Mac II uses such slow memory. The memory in this Mac goes for \$96.84 (at \$2.69 apiece, assuming one chip per 256K for parity checking) without any quantity discounts. This is a very small amount of money compared to the high cost of this computer. At least 100-nsec chips should have been used; who needs wait states?

macintosh/mac.ii #21, from tom__thompson, Fri Mar 6 19:47:48 1987. A comment to message 20.

As I understood it, the only way to eliminate the wait state was to use something with a 60-nsec access time. Shows how fast that 68020 is booking, doesn't it?

macintosh/mac.ii #24, from rz__mhamel, Sat Mar 7 18:09:27 1987. A comment to message 21.

It looks as though Apple is going for a conservative design, as usual. My 68020 book indicates you have around 120 nsec total from valid address to data wanted on a 16-MHz 68020. Add two wait states and that's 240 nsec. If the RAM takes 120, there's certainly plenty of time for memory management, buffer delays, etc. . .

The difference between five cycles to read memory (including the ROM, I presume?) and three cycles to fetch from the cache means there will be some incentive on this machine to keep those loops inside 64 longwords. Another job for the compiler writers, eh?

macintosh/mac.ii #34, from skraegeloh (Stefan Kraeglo), Tue Mar 10 17:52:05 1987. A comment to message 24.

Actually it's 115 nsec from Axx valid to data wanted. Unfortunately, that's not a very useful specification. If you use dynamic RAM, you've got to start the access by asserting /RAS. Which, of course, you can do only if you know when a cycle will start. So what you were really looking for is the time /AS

valid to data wanted, which is 85 nsec worst case (at 16 MHz). But then /AS is *not* the only way to tell the "start of an external cycle" (hint, hint for those of you with a data book). In fact, I've built a 16-MHz 68020 card (for the VME bus) using 80-nsec dynamic RAMs and featuring *no wait states*. By the way, these RAMs (IMS2800) were developed by Immos and are now manufactured by IMC. They are available down to 60-nsec access time! I've heard Compaq uses these RAMs in their 386 PC.

macintosh/mac.ii #35, from alf, Tue Mar 10 20:09:31 1987. A comment to message 34.

Actually, the Compaq 386 uses 100-nsec (static) RAMs, which is a little conservative. On the interesting side, guess what type of RAMs Compaq now uses in ALL their 80286-based machines? Also 100-nsec RAMs. Why Compaq uses the same speed RAMs in their 16-MHz 80386 machines as their 12-MHz 80286 machines beats me. But with their replacement of their 8-MHz 80286 machine line with 12-MHz machines (with no price increases) they have become the technological leader of the PC-compatible industry. So maybe they aren't so conservative after all.

ATARI

In the Atari section this month you'll find some thoughts on how widespread the use of hard disks is in the ST community. Then there's a discussion on upgrading 1040 RAM to 2 megabytes.

HARD DISK PREVALENCE

atari.st/main #1802, from davjon (David Jones), Thu Mar 5 21:16:26 1987.

Does anyone have any idea how many ST users out in the big wide world have hard disks? Is it worth making special provisions for them in software packages (aside from the usual copy-protection gripes)?

atari.st/main #1803, from sprung (Ron Sprunger), Thu Mar 5 22:28:20 1987. A comment to message 1802.

You might ask Supra how many they have out. I think they are becoming very popular - I have three. I was recently asked by a dentist friend to help him set up his ST, and he had a Supra 20-meg. I believe that any program that doesn't run conveniently on a hard disk will be in for a *lot* of criticism - these machines are powerful, and a substantial percentage of users will be on hard disks.

To be convenient on a hard disk, a program should be able to run from any directory while residing in any other directory. The user ought to have a way to tell the program where to look for its resources and where to put its results. In addition (and extremely important if used for serious purposes), if I execute it from e:\ron, and my wife executes it from f:\judy, we each ought to be able to exercise it on the files in our respective directories. I get royally griped with programs that dictate where resources and output go or that have a system specification for output. Output should go to the current directory, but provision should be made for system specification, if desired by the user.

atari.st/main #1805, from tsikes (Terry Sikes), Fri Mar 6 04:49:05 1987. A comment to message 1802.

I don't have a figure, but it seems to me that as hard disk prices go down and the ST is viewed more as a serious machine, many more people will have them. Supporting hard disks should be straightforward as far as software development goes, except

continued

BYTE T-Shirts



TWO NEW
DESIGNS!

Those fantastic Byte covers—and boy, do they look great on this stylish, ¾ sleeve T-shirt from Robert Tinney Graphics!

The colored sleeves and neckline vividly complement the full-color design.

And don't mistake this for a rubbery patch that cracks and peels off after a few washings. This is true four-color process: the permanent inks are silk-screened into the fabric, resulting in a beautiful, full-color image that lasts!

You'll also appreciate the shirt itself: a heavyweight cotton/polyester blend which combines tough washability with the cool, soft comfort of cotton. Each Byte T-shirt is priced at only \$12.50 (\$11.50 each for 3 or more). Be sure to include shirt size: **C**—(child 10-12), **S**—(34-36), **M**—(38-40), **L**—(42-44), and **XL**—(46-48). Most orders shipped within a week.



#T1—Computer Engineering

#T2—Software Piracy

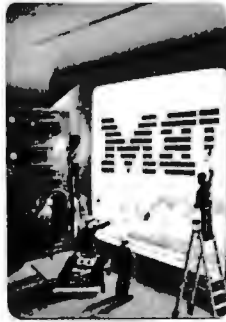

#T3—Inside IBM

#T4—Future Past



#T5—Breakthrough

Send the following T-shirt(s) at \$12.50 each, or \$11.50 each for 3 or more. I have included \$2 for shipping & handling (\$5 overseas).

QTY.	#	TITLE	AMOUNT
			\$
			\$
			\$
			\$
			\$
			\$
			\$
			\$
			\$
			\$
		Shipping & handling (see above)	\$
		TOTAL	\$

Please send your COLOR brochure

- I have enclosed U.S. check or money order.
 C.O.D. (via UPS—stateside orders only)
 VISA MasterCard American Express

Card #: _____

Expires: _____ Signature: _____

Ship my shirt(s) to:

Name: _____

(Business): _____

Add : _____

City: _____

State: _____ Z. _____

mail this coupon to:
Robert Tinney Graphics
 1864 North Pamela Dr.
 Baton Rouge, Louisiana
 70815

For VISA, MasterCard or American Express orders, or for more information

Call 1-504-272-7266



for copy protection. However, you can always use the same copy-protection scheme as usual on your floppy, and use it as a key disk (like Habawriter).

1040 MEMORY UPGRADE

atari.st/main #1918, from jimomura (Jim Omura), Tue Mar 17 18:46:59 1987.

Has anybody upgraded a 1040ST to 2 megs? I'm starting to feel a need for a 2-meg machine.

atari.st/main #1921, from wes.peters (Wes Peters), Wed Mar 18 05:13:57 1987. A comment to message 1918.

Two megs is a little tricky to do. The machine (actually the MMU) is set up to address 1 or 2 banks of 256K-bit or 1-megabit chips. You could easily do 2 megs on a 520ST by switching to 1-megabit chips, but to do 2 megs on a 1040 (or any >1-megabyte configuration using 256K chips) would involve grabbing individual bits off the chip address lines when either RAS or CAS is strobed (while storing the lower bits in a FIFO), using the high-bit lines to select one of several banks of 256K chips, and then generating your own strobes while latching the stored addresses on the address line. Messy, very messy. On the other hand, if you replace your 256K chips in your 1040 with 1-megabit chips, which is fairly simple, you get 4 megs. . . Neat, huh?

atari.st/main #1922, from jim_kent (Jim Kent), Wed Mar 18 11:57:09 1987. A comment to message 1921.

Do you have to do any software fixes for the 1040 to recognize the 4 megs?

atari.st/main #1923, from jimomura, Wed Mar 18 12:13:49 1987. A comment to message 1921.

OK, anybody got a part number for the 1-meg chips? Also, any other jumpering or trace cutting, etc.?

atari.st/main #1924, from alexl. (Alex Leavens), Wed Mar 18 16:26:23 1987. A comment to message 1923.

1) No software changes are necessary; the machine will recognize the 4 megs automatically. 2) 1-meg chips have a different pin-out and 2 more pins than 256K chips do, so you'll have to do a *lot* of work to upgrade.

atari.st/main #1926, from wes.peters, Thu Mar 19 04:29:31 1987. A comment to message 1923.

Yeah, 411M believe it or not. . . . try Microprocessors Unlimited; I think they advertise in BYTE and I know they do in *The Computer Shopper*. As Alex mentioned, the 1-megabit chips have more pins and a different pattern than the 41256s, so you'll have to create a daughterboard to hold the new chips. Other than that, it should just be a matter of bringing the extra address line and the extra (unused) RAS and CAS signals from the MMU. I haven't looked at loading resistors for this yet, so don't run off and try it unless you have a real competent digital engineer or a disposable ST handy.

AMIGA

The highlights of this month's Amiga conference begin with an extensive discussion on the accuracy of timing on the Amiga. From there a BIXer receives help on a "crashing CloseWindow" problem. We finish up with some thoughts on task priorities under AmigaDOS.

TIMER GRANULARITY

amiga/softw.devlpmt #3904, from tjeffries (Tom Jeffries), Sat Mar 7 02:02:34 1987.

There was some discussion here several months ago about the granularity of timing on the Amiga. (Actually, if I remember right, the discussion was on hardware, but bear with me; I have a software question.) The company I work for is considering porting its main program to the Amiga but was concerned because it looked difficult to get timing more accurate than 16 milliseconds, and we need accuracy to about 1 millisecond.

I have two questions: Someone did come up with a solution based on using the timer, but it looked as though you couldn't use the blitter and that timer at the same time. Does ordinary text require the blitter? In other words, can a non-graphics-intensive application take over the timer that the blitter uses? (I think it was timer B, but I'd have to look it up.)

Second, I just ran across a reference in some code that seems to indicate that the "SendIO(&timerio)" routine accepts arguments in seconds and microseconds. Does that mean I could get timing accurate to some number of microseconds (obviously, less than 1000 microseconds), or is it just an overambitious structure element name?

amiga/softw.devlpmt #3905, from cheath (Charlie Heath), Sat Mar 7 02:19:25 1987. A comment to message 3904.

Normal text would use the blitter, and it can chomp considerable amounts of time even if you have another task running at a higher priority, once the text has started. I recently had to get a program running with a 50-microsecond window of accuracy, and I couldn't do it without disabling interrupts during the timed intervals. For 1-millisecond accuracy, you probably would not have to disable interrupts, but you might have to do some tricks. Does the text absolutely have to be displayed while the timing is active? How much processing occurs at the 1-millisecond intervals?

amiga/softw.devlpmt #3907, from tjeffries, Sat Mar 7 13:20:18 1987. A comment to message 3905.

I don't need lots of processing, I just need to keep track, in 1-millisecond increments with a reasonable degree of accuracy. Could I use the timer that the blitter uses? Hmm. . . if I understand what you are saying, it sounds like I would have to avoid large amounts of text being written. Do you have any idea how long it takes to write a single character to the screen?

amiga/softw.devlpmt #3910, from cheath, Sat Mar 7 17:20:10 1987. A comment to message 3907.

Text speed for single-character I/O is roughly 3 ms per character with standard text routines and roughly 1 ms per character with FastFonts installed.

If all you need is an accurate accounting of time, you can get that down to a resolution of a few microseconds using the vertical-blank counter registers. It takes a bit of calculation to get that into time format, maybe 20 microseconds of conversion in assembler. You'd also need a VBlank interrupt handler - they're pretty easy to install with RKM documentation.

amiga/softw.devlpmt #3911, from tjeffries, Sat Mar 7 17:30:32 1987. A comment to message 3910.

Thanks cheath, that's exactly what I need. BTW, why so slow printing text to the screen? The 68000 alone can do a lot of work in 1 millisecond; I would have expected the blitter to make things even faster.

continued



The "first-to-nineteenth-floor" \$158,300 disk drive decision.

Today, in the office elevator, Dave Dodge, Electronics Engineer, and Pete Doyle, Information Systems Specialist, will firm up their disk drive selection for a major microcomputer purchase that they are making for their company. The buying decision is theirs because they are "Power Users" of computers at work and at home.

Dave and Pete read BYTE, the broad-based micro magazine for the computer "Power Reader." Due to their authority and technical expertise, BYTE readers have tremendous clout in their companies' micro-related purchases. During the next 12 months, BYTE subscribers with technical titles like Dave's and Pete's will buy or

influence their companies' average purchases of \$710,097 for hardware, supplies, peripherals and software! It's a fact...the BYTE reader is *the* "Power Buyer."

About 90% of BYTE subscribers buy or influence their companies' micro-related purchases. In terms of buying influence, our "Dave Dodge" and "Pete Doyle" typify the average BYTE reader with a technical job title according to the *1986 Hardware and 1987 Software Purchasing Influence Studies.*

Are you putting the "Power of BYTE" to work for your micro products? To find out how...call your BYTE Advertising Sales Consultant today.

BYTE means business.



BYTE

THE SMALL SYSTEMS JOURNAL

One Phoenix Mill Lane
Peterborough, NH 03458
(603) 924-9281

JUNE 1987 • BYTE 335



amiga/softw.devlpmt #3912, from cheath, Sat Mar 7 20:23:40 1987. A comment to message 3911.

The main problem is that there is a lot of setup to work in layers, and setup for the blitter. The setup is the same whether you do one character at a time or if you do a whole line of 80 characters. If you set up your own display screen and manage it with your own direct-to-screen text routines, you could probably do single-character I/O about 50 times as fast, maybe more if you really get pushy. Note that the 3-millisecond time is for straight text rendering - if you go through the console device, it'll be a bit slower!

amiga/softw.devlpmt #3913, from tjefries, Sat Mar 7 21:25:35 1987. A comment to message 3912.

That's more in line with what I would expect: 50 times faster for a direct-to-screen routine. Ah, well, the advantages of modern technology. The info you've given me looks good in terms of getting project approval from the higher-ups. Most likely you're going to have to put up with still another programmer asking umptillion questions as I learn the Amiga!

amiga/softw.devlpmt #3906, from grr (George Robbins, Commodore Business Machines), Sat Mar 7 03:48:30 1987. A comment to message 3904.

Did you just need to measure elapsed time or to cause an event to happen at a precise instant? If the latter, do you need to perform any functions between the reference event and the next event or just wait for it to happen?

amiga/softw.devlpmt #3908, from tjefries, Sat Mar 7 13:24:48 1987. A comment to message 3906.

It would suffice to have an accurate measure of elapsed time kept in a variable someplace. It would also work to have an event happen at a precise instant, but, yes, there would be other things happening in the meantime. With less fancy operating systems we've just set up a little interrupt routine, but I'm not sure how to do that on the Amiga without getting into trouble. There's probably a way, and I'm hoping somebody here has figured it out. Thanks.

amiga/softw.devlpmt #3909, from grr, Sat Mar 7 16:02:39 1987. A comment to message 3908.

Each 8520 has a "time of day" binary counter. One runs off a nominal 60-Hz tick signal, the other runs off the 15+ kHz horizontal frequency. It is possible that you could read the second 8520, but I'm not sure how it is set up and whether it free runs or the software messes with it. . .

CRASHING CLOSEWINDOW

amiga/softw.devlpmt #3914, from cmcmanis (Charles McManis), Sat Mar 7 21:41:11 1987.

I have a mysterious one: Every so often my code crashes when it calls the CloseWindow() routine. The window is a vanilla Intuition window with about 12 gadgets in it. I do play with the gadget list a bit, but everything is stable when I go to close the window. And it doesn't happen all the time! (Especially when my diagnostics are spitting things to the screen or printer).

Late news from Usenet: *DO NOT USE Delay(0)* in your programs. It can cause the disk activity going on in other tasks to get confused. A couple of people have trashed disks with the Handl program and the 2.05m version of Matt's shell.

Back to the window problem, when it crashes the Guru is an 810. . . 5. in my code, backtraced to the CloseWindow() call, which claims the free list is corrupt. Since I have a version of Snoop built into my program, I know that it didn't free anything untoward. Of course, it is right after a FreeRemember call (my stuff), so maybe the FreeRemember routine returns before EXEC has freed all of the memory? Sorry for the rambling, but this is like the *last* bug and it is making me crazy!

amiga/softw.devlpmt #3915, from cheath, Sun Mar 8 00:13:59 1987. A comment to message 3914.

Most likely something got corrupted before, and it's just the CloseWindow() call that springs the trap. Hard to guess what, but since you say you do a lot with gadgets, that sounds like a good place to start looking.

amiga/softw.devlpmt #3918, from cschepner (Carolyn Schepner, Commodore Business Machines), Tue Mar 10 11:39:18 1987. A comment to message 3915.

I had a similar problem with my Palette program. Every time I ran it, Avail showed I had GAINED memory, and after several runs I'd guru with (I think) memory list corruption.

The problem was caused by deallocation of my dynamically created color chip gadgets PRIOR to CloseWindow(). When I moved the deallocation after CloseWindow(), the problem disappeared.

amiga/softw.devlpmt #3919, from cmcmanis, Tue Mar 10 14:07:53 1987. A comment to message 3918.

Does CloseWindow() try to deallocate Gadgets on the window's gadget list? I went back to the original Lattice 3.10 libraries and that seemed to cure it for me, but I am still not comfortable with the fix. I will try moving around the deallocates and the CloseWindow() call and see if that helps at all.

amiga/softw.devlpmt #3923, from cschepner, Thu Mar 12 18:08:26 1987. A comment to message 3919.

CloseWindow() frees the system gadgets attached to the window. If you have some of your own gadgets added to the list, I imagine they had better be either Removed or valid when Intuition scans the list for system gadgets.

AMIGADOS SYSTEM TASK PRIORITIES

amiga/tech.talk #942, from tholloway (Tim Holloway), Thu Mar 5 22:44:56 1987.

Why are the system tasks in AmigaDOS at such low priorities? I'm running DACP and SPOOLer at priority 4, SPOOLprinter(s) at priority 3, and microEMACS as an ongoing task at priority 2. It's getting pretty crowded here. I'd think that having the DOS tasks at somewhere around 50 to 100 would be a lot better, and still leave room for animation and sound above them.

amiga/tech.talk #944, from cheath, Thu Mar 5 22:53:35 1987. A comment to message 942.

Can't you run at negative priority?

amiga/tech.talk #949, from jim__kent (Jim Kent), Fri Mar 6 19:09:39 1987. A comment to message 944.

Geez, I usually do animation at priority 0 to leave room for the sound and the disk. Don't want to lock out the root-block update of the disk for anything.

continued

Six great reasons to join **BIX** today

- **Over 140 microcomputer-related conferences:**

Join only those subjects that interest you and change selections at any time. Take part when it's convenient for you. Share information, opinions and ideas in focused discussions with other BIX users who share your interests. Easy commands and conference digests help you quickly locate important information.

- **Monthly conference specials:**

BIX specials connect you with invited experts in leading-edge topics—the IBM PS/2 family, OS/2, and more. They're all part of your BIX membership.

- **Microbytes daily:**

Get up-to-the-minute industry news and new product information by joining Microbytes.

- **Public domain software:**

Yours for the downloading, including programs from BYTE articles and a growing library of PD listings.

- **Electronic mail:**

Exchange private messages with BYTE editors and authors and other BIX users.

- **Vendor support:**

A growing number of microcomputer manufacturers use BIX to answer your questions about their products and how to use them for peak performance.

What BIX Costs. . How You Pay

ONE-TIME REGISTRATION FEE: \$25

Hourly Charges: (Your Time of Access)	Off-Peak 6PM-7AM Weekdays Plus Weekends & Holidays	Peak 7AM-6PM Weekdays
BIX	\$9	\$12
Tymnet*	\$2	\$6
TOTAL	\$11/hr.	\$18/hr.**

* Continental U.S. BIX is accessible via Tymnet from throughout the U.S. at charges much less than regular long distance. Call the BIX helpline number listed below for the Tymnet number near you or Tymnet at 1-800-336-0149

** User is billed for time on system (i.e., 1/2 Hr. Off-Peak w/ Tymnet = \$5.50 charge.)

BIX and Tymnet charges billed by Visa or Mastercard only.

BIX HELPLINE

(8:30 AM-11:30 PM Eastern Weekdays)

U.S. (except NH) and Canada—1-800-227-BYTE
Elsewhere (603) 924-7681



We'll
Send
You a

BIX User's Manual and Subscriber Agreement
as Soon as We've Processed Your Registration.

JOIN THE EXCITING WORLD
OF BIX TODAY!

JOIN BIX RIGHT NOW:

Set your computer's telecommunications program for full duplex, 8-bit characters, no parity, 1 stop bit OR 7-bit characters, even parity, 1 stop using 300 or 1200 baud.

Call your local Tymnet* number and respond as follows:

Tymnet Prompt

Garble or "terminal identifier"
login:
BIX Logo—Name:

You Enter

a
bix <CR>
new <CR>

After you register on-line, you're immediately taken to the BIX learn conference and can start using the system right away.

FOREIGN ACCESS:

To access BIX from foreign countries, you must have a packet switching account with your local Postal Telephone & Telegraph (PTT) company. From your PTT enter 310600157878. Then enter bix <CR> and new <CR> at the prompts. Call or write us for PTT contact information.

BIX

ONE PHOENIX MILL LANE
PETERBOROUGH, NH 03458
(603) 924-9281

amiga/tech.talk #946, from Inoland (Les Noland), Fri Mar 6 02:39:44 1987. A comment to message 942.

I was very curious about the same thing. I would have suspected that the system tasks would all be at quite high priorities with a fair spread between those priorities chosen to allow for future system tasks. It really surprised me to find them crowded together with such low numbers. It shouldn't be too much trouble for user tasks, since it is now possible to set the priority of a CLI (and, correspondingly, that of processes launched from it) and negative numbers are available, though the lack of sufficient room between the system tasks (and the problem of tasks launched from the Workbench) might make things a bit tight for someone wanting to get creative with task priorities.

By the way, where is this SPOOLer of which you speak? Home grown?

amiga/tech.talk #948, from jdow (Joanne Dow), Fri Mar 6 12:53:15 1987. A comment to message 946.

print spooler == "run type <filename> to prt:"

amiga/tech.talk #950, from Inoland, Sat Mar 7 03:32:05 1987. A comment to message 948.

Not quite my idea of a print spooler. A print spooler should spool all printer output, regardless of source (e.g., any application that opens a printer file would have its output **spooled**). Sure would make life easier with some of these programs that demand to hang onto the printer whether they are using it or not.

amiga/tech.talk #955, from afinkel (Andy Finkel, Commodore Business Machines), Mon Mar 9 18:07:01 1987. A comment to message 948.

I posted a print spooler, based entirely on a CLI script a while ago. (I did it purely as an exercise, to see what the AmigaDOS scripts could do.)

amiga/tech.talk #956, from Inoland, Tue Mar 10 00:57:41 1987. A comment to message 955.

Yes, I've seen your print spooler but it still doesn't quite match my definition of a print spooler. It's useful, but not what I'm looking for.

amiga/tech.talk #966, from tholloway, Sat Mar 14 17:39:37 1987. A comment to message 956.

The Ami Project spooler is a true spooler. It consists of a spool-control program and one or more printer program tasks (that's right, one OR MORE!) Think of it as a mini-JES2, if you will. It maintains a set of queues to match idle printers to print requests, and vice versa.

amiga/tech.talk #963, from tholloway, Sat Mar 14 17:24:06 1987. A comment to message 946.

The default priority is zero. Supposedly, good little Amiga programs run between -5 and +5. Rather tight, even so. There's more room on the low side, since the only low-priority system tasks I know of are the validators, but the DEFAULT is zero, so dumb users (me included) are likely to get surprises if applications assume that somebody launched them at low priorities. The SPOOLer was covered in issue #4 (I think) of *Ami Project* magazine. Corrected and enhanced version (including source) is available on Casa Mi Amiga BBS at (904) 733-4515.

amiga/tech.talk #969, from Inoland, Sat Mar 14 20:14:04 1987. A comment to message 966.

Zounds! Time to place a call to the Casa Mi Amiga BBS, methinks! Thanks for the info on the spooler.

amiga/tech.talk #954, from afinkel, Mon Mar 9 18:05:20 1987. A comment to message 942.

If two tasks have the same priority, EXEC gives time slices in a round-robin manner. This eases things considerably. Also, the priorities could be changed in the future. (uh oh, I hear the sound of a worm can opening. . .) ■

AC/FORTRAN™ **AMIGA**

Mainframe quality, full feature **ANSI FORTRAN 77** compiler includes: **Debugger**, Linker, Library Manager, Runtime Library, **IEEE** math, and **C** interface. Supports **Complex** numbers, **Virtual** arrays, **Overlays** and Dynamic Linking. Not copy protected. Available now. \$295. Turbo Amiga version also available.

AC/BASIC™

From the authors of **Microsoft BASIC** compiler for Macintosh, comes **AC/BASIC** for the Amiga. Companion compiler to the **Amiga BASIC** interpreter, has more features and includes a **Debugger**, includes **BLOCK IF**, **CASE** statement, and **STATIC** keyword extensions and executes up to **50x** fast r. **AC/BASIC** is the new **BASIC** reference for **MIPS8000** based personal computers. Not copy protected. \$295.

Telephone orders welcome

abs:ft

Scientific Engineering Software
 268 N. Woodward, Royal Oak, MI 48072 (313) 549-7111
 Amiga trademark of Commodore Amiga
 Microsoft trademark of Microsoft Corp.

ATARI

Inquiry 4

American Semiconductor

THE BARE XT-AT TURBO SYSTEMS

FROM **\$399**

FREE SOFTWARE WITH PURCHASE
 386 CLONES AVAILABLE!

WHOLESALE PRICES
 MINIMUM \$50 ORDER

80287, 80287 (8088), DRAM	Modems: 1200, 2400, 4800 Baud
64K, 256K, EPROMS	Monitors from \$79: Color, EGA
Hard Drives	Monochrome
Hard Drive Kits from \$199	Printers: Okidata, Epson, Diablo...
ATs from \$999	Floppies

CREDIT NOW AVAILABLE
 *ON SELECTED ITEMS

TO ORDER TOLL FREE CALL
1-800-237-5758, EXT. 815
1-800-825-SAVE

Inside Florida 813-961-9444	Import/Export 813-961-5584	D.C. Area 301-933-3523
--------------------------------	-------------------------------	---------------------------

Prices subject to change. Add 3.55% for VISA/MC purchases.
 16520 N. Florida Ave., Lutz, Florida 33549

5 YR. WARRANTY

Inquiry 19

"D" SIZE PLOTTER
 \$1495⁰⁰



\$2295⁹⁹ RETAIL

Model PC 34/36 Pen Plotter:
 (415) 795-0956 **ZERICON**

655 John Muir Drive • Suite 416
 San Francisco, CA 94132

NEWS RELEASE

Inquiry 345

THE BUYER'S MART

A Directory of Products and Services

THE BUYER'S MART is a monthly advertising section which enables readers to easily locate suppliers by product category. As a unique feature, each BUYER'S MART ad includes a Reader Service number to assist interested readers in requesting information from participating advertisers.

RATES: 1x—\$475 3x—\$450 6x—\$425 12x—\$375
Prepayment must accompany each insertion. VISA/MC Accepted.

AD FORMAT: Each ad will be designed and typeset by BYTE. Advertisers must

furnish typewritten copy. Ads can include headline (23 characters maximum), descriptive text (250 characters maximum), plus company name, address and telephone number. Do not send logos or camera-ready artwork.

DEADLINE: Ad copy is due 2 months prior to issue date. For example: October issue closes on August 1. Send your copy and payment to THE BUYER'S MART, BYTE magazine, 70 Main Street, Peterborough, NH 03458. For more information call Mark Stone at BYTE 603-924-3754.

ACCESSORIES

...SOFTWARE PUBLISHING...

GDS offers a wide variety of services that will help get your software to the market. Address your needs with GDS.

- IBM style cloth/vinyl 3-ring binders/slips.
- Labels, sleeves, disk pages, bulk diskettes.
- Disk duplication with 100% verification.
- Shrink wrapping and product assembly.
- Quick turn-around.

A well packaged product can make the difference in making a sale. Call us now! VISA/MC.

GLENCO DEVELOPMENT SYSTEMS(312) 392-2492
3920 Ridge Ave., Arlington Hts., IL 60004

Inquiry 650.

COMPUTER PROTECTION

- UPS • LINE CONDITIONERS • ISOLATORS
- MODEM PROTECTORS
- AC POWER INTERRUPTERS

— HUNDREDS OF HINTS & PRODUCTS —
FREE CATALOG 1-800-225-4876

ELECTRONIC SPECIALISTS, INC.

171 So. Main St., P.O.B 389, Natick, Mass 01760
1-800-225-4876

Inquiry 651.

DATA CABLES & PARTS

EIA RS232-C Data Cables - standard, extended distance, Teflon Assemblies. Also Centronics (parallel), Coaxial (RG59U, RG62A/U, Dual Wang, Twin-axial), Ethernet, Ribbon, IBM, DEC Compatible cables, AB switches, connector parts, bulk cable; tools & hardware (wall plates). Send for Catalog.

Communication Cable Co.

POB 600-B, Wayne, PA 19087
215-644-1900

Inquiry 652.

FREE CATALOG

Thousands of parts and new surplus electronic parts at super low prices. FAST ORDER PROCESSING AND SHIPPING (95% of all orders shipped within 48 hours).

CALL OR WRITE FOR A FREE CATALOG. . .

ALL ELECTRONICS CORPORATION

POB 20406, Los Angeles, CA 90006-0406
1-800-826-5432

Inquiry 653.

Self-Inking Printer Ribbon

For users of Okidata and other open spool ribbon printers. Controlled Printout Devices are a new kind of printing ribbon that re-ink themselves, and will last 15 times longer than the ribbon you are now using. For further information please call or write.

CONTROLLED PRINTOUT DEVICES, INC.

POB 869, Baldwin Rd., Arden, NC 28704
(704) 684-9044

Inquiry 654.

ACCESSORIES

INTERFACES and CABLES!

For most major computers and printers
TecTrans

6925 Rosemead Blvd. #24, San Gabriel, CA 91775
(818) 285-3121 or (818) 799-4570

Inquiry 655.

BAR CODE

BAR CODE MADE EASY

PERCON® E-Z-READER® keyboard interfaces and multi-user RS-232 models make it easy to add bar code to virtually any computer/terminal WITHOUT SOFTWARE MODIFICATION. Immediate shipping. Two year warranty. Bar code printing software available. Call for details on fast, accurate, easy data entry. Substantial reseller discounts.

PERCON®

2190 W. 11th St., Eugene, OR 97402
(503) 344-1189

Inquiry 656.

DATA INPUT DEVICES

Bar Code & Magnetic Stripe Readers for microcomputers & terminals, including IBM, DEC, AT&T, CT, Wyse, Wang. All readers connect on the keyboard cable & are transparent to all software. Low cost bar code print programs & magnetic encoders are also available.

TPS Electronics

4047 Transport, Palo Alto, CA 94303
415-856-6833 Telex 371-9097 TPS PLA

Inquiry 657.

BAR CODE READERS

PC/XT/AT Bar Code Reader attaches as 2nd keyboard, reads bar codes as keyed data. External No Slot Model—\$385 or Internal Slot Model \$339. RS-232 model—\$399. Rugged metal case & wand, reads UPC/EAN, 2 of 5, Code 39, etc. Dealers welcome. Same-day, free shipping. 30 day \$ back guarantee.

Worthington Data Solutions

130 Crespi Court, Santa Cruz, CA 95060
(408) 458-9938 See our ad on page 120

Inquiry 658.

BIG TEXT and BAR CODE PRINTING

Print Labels with Large Text and/or bar codes on PC with Epson/Okidata/IBM ptrs. Text to 1"x1" reads at 50 ft. Bar codes 39, 1 2 of 5, UPC/EAN, MSI, MIL-STD, AIAG. Flexible format/size, Color, Reversals. Menu driven \$49-\$299. OR print from ANY program (BASIC, dBASE) \$179-\$239. Lasers too!

Worthington Data Solutions

130 Crespi Cour., Santa Cruz, CA 95060
(408) 458-9938 See our ad on page 120

Inquiry 659.

BAR CODE

READ & PRINT BAR CODES

Internal unit (short-card for IBM PC/XT/AT/compatibles) or RS-232 Dual Port unit: both work with all keyboards and software. Includes stainless steel wand or LASER gun. User-friendly Bar Code and Text printing software with format/size flexibility.

Seagull Scientific Systems

601 University Ave., Suite 150, Sacramento, CA 95825
(916) 386-1776

Inquiry 658.

BUSINESS OPPORTUNITIES

EATEN ANY GOOD CHIPS LATELY?

We eat, drink, and sleep hardware and love describing the results. We're looking for others who have built unique projects and can write articles about them. If you've got a great project ready for a chapter in our book, write us now. We're already in the business and we pay top dollar!

Microservices

67 Scott Drive, South Windsor, CT 06074

Inquiry 659.

WANTED:

Instrumentation consultants in all parts of the U.S. We want to refer potential clients to local consultants for PC-based instrumentation solutions.

Respond to:

P.O. Box 9565, New Haven, CT 06536.

Inquiry 660.

FREE LIST

100 P.C. BUSINESSES

Personal Computer Owners can earn \$1000 to \$5000 monthly selling simple services performed by their computer. Work at home - in spare time. FREE list of 100 best services to offer. Write:

A.I.M.B.X

P.O. Box 60369, San Diego CA 92106-8369

Inquiry 661.

CAD/CAM

FASTCAD

Written in assembler for maximum speed, this full featured package has user definable simultaneously active windows. Menus are easy to customize. Automate complex or repetitive tasks thru macros and scripts. Floating point math gives the user precision and near infinite zoom.

EVOLUTION COMPUTING

437 S. 48th St., Suite 106, Tempe, AZ 85281
602-967-8633

Inquiry 662.

THE BUYER'S MART

COMMUNICATIONS

MULTI-USER BBS (FOR IBM PC AT) TEAMate — a mainframe quality BBS. A mini CompuServe. Full screen cursor-controlled interface, topic outline structure, public and private topics, audit trails, xmodem, integrated mail, content retrieval and more. MS-DOS, XENIX and UNIX versions.

MMB Development Corporation

1021 No. Sepulveda Blvd., Suite K, Manhattan Beach, CA 90266
(213) 545-1455

Inquiry 663.

EasyComm™

Easy to use general purpose communications program for PC-PC-Data Base phone line communications. "Better than Crosstalk at 1/4 the price!" say EasyComm users. Send and receive files in "batches," by XMODEM, XON-XOFF TEXT, 1200 or 300 baud, even unattended. STATUS displayed at all times, context-sensitive "help," much more.

SPECIAL \$49 + \$2 SH

CalSOFT (805) 497-8054 VISA, MC
2859 Agoura Rd., Suite 143, Westlake Village, CA 91361

Inquiry 664.

COMPUTER INSURANCE

COMPUTER INSURANCE

Call toll free for information and immediate coverage

- BUSINESS COMPUTERS
- HOME COMPUTERS
- COMPUTERS OVERSEAS
- COMPUTERS YOU LEASE
- COMPUTERS YOU LEASE TO OTHERS

SAFEWARE,

The Insurance Agency Inc.

1-800-848-3469 IN OHIO (614) 262-0559

Inquiry 665.

CROSS ASSEMBLERS

INCREDIBLE ASSEMBLER BARGAIN!

Turn your PC into a complete development system with our introductory offer. You will get 5 cross-assemblers for less than the price of one! RUSH YOUR INQUIRY.

FOR JUST US \$50 YOU WILL GET:

Z80ASM For Z80 microprocessor family
96XASM For 8096 microcontroller family (MCS-96)
85XASM For 8080/8085 microprocessors
51XASM For 8051 microcontroller family (MCS-51)
48XASM For 8048 microcontroller family (MCS-48)

LEAR COM COMPANY

2440 Kipling Street, Suite 206, Lakewood, CO 80215
(303) 238-2506

Inquiry 666.

ASSEMBLERS & TRANSLATORS

Over 20 high quality, full function, fast relocatable and absolute macro assemblers are available immediately. Source language translators help you change microcomputers. Call for info about MS/DOS, CPM80, ISIS versions.

RELMS™

P.O. Box 6719

San Jose, California 95150

(408) 265-5411

TWX 910-379-0014

Inquiry 667.

CUSTOM SOFTWARE

CUSTOM SOFTWARE

To your specifications!

Specializing in: BIT-slice microprogramming applications and design.

High-level: MS/DOS based 'C'.

Documentation: Other than well-commented listings is OPTIONAL for an additional fee.

E & J Enterprises, Inc.

P.O. Box 817, Henderson, Nevada 89015

Inquiry 668.

DATA/DISK CONVERSION

DISK AND TAPE CONVERSIONS

High quality conversion services for Dedicated Word Processors, Mini and Microcomputers. Over 600 3 1/2", 5 1/4", and 8" formats. Also 800-1600BPI tape. Included: Wang, NBI, CPT, DEC, Vydec, Lanier, GS/6, Xerox, IBM Sys/34/36/38/5520, Mac, Victor, TRS, Apple, NSTAR, IBM PC/AT, HP, and most of the other microcomputers. We can convert directly into word processing software such as: DW3, WP, MS/WRD, WS, Samna, MM, PFS, and many others.

DATA FORMATS, INC. (408) 972-1830

Inquiry 669.

INTERCHANGE HEWLETT PACKARD FILES ON IBM PC

IBM PC to HP File Copy allows IBM PC's and compatibles to read and write files written by Hewlett Packard Series 70, 80, 200, 300, 1000, 9000 computers. Call for data sheets, config diagram, pricing. Oswego Software Inc. specializes in HP disk file copying, program translators.

Oswego Software Inc.

507 North Adams Street, Oswego, Illinois 60543 USA
(312) 554-3567 TELEX 858757

Inquiry 670.

Disk/Disk • Tape/Disk • OCR

Over 1,000 formats! 3 1/2, 5 1/4, or 8 inch disks; 9 track mag tape; 10 MB Bernoulli cartridge. Data base and word processor translation. Specialists in Government Sensitive Data. Call for free consultation.

Computer Conversions, Inc.

We take the hassle out of data conversion . . .
9580 Black Mtn. Rd., Ste J, San Diego, CA 92126
(619) 693-1697

Inquiry 671.

CONVERSION SERVICES

Convert any 9 track magnetic tape to or from over 800 formats including 3 1/2", 5 1/4", 8" disk formats & word processors. Disk to disk conversions also available. Call for more info. Introducing OCR Scanning Services.

Pivar Computing Services, Inc.

165 Arlington Hgts. Rd., Dept. #B
Buffalo Grove, IL 60089 (312) 459-6010

Inquiry 672.

DEMOS/TUTORIALS

INSTANT REPLAY II

Build Demos, Tutorials, Prototypes, Presentations, Music, Timed Keyboard Macros, and Menu Systems. Includes Screen Maker, Keystroke/Time Editor, Program Memorizer, and Animator. Rec'd Great Reviews! Simply the BEST. Not copy protected. No royalties. 60 day satisfaction money back guar. IBM and Compatib \$149.95 U.S. Chk/Cr. Crd. Demo Diskette \$5.00

NOSTRADAMUS, INC.

3191 South Valley Street (ste 252)
Salt Lake City, Utah 84109 (801) 487-9662

Inquiry 673.

DOCUMENTATION

COMPUTER ASSEMBLY MANUALS

BIG BLUE SEED for IBM™ BUILDERS: Parts list, placement diagrams, instructions for assembling 75 bare cards. Now includes 640K, Turbo & AT MinIBds. \$17.95. **APPLE™ BUILDERS NEED APPLE SEED:** Instructions for assembling 85 Apple-compatible bare cards including the popular 6502 II+ and IIe MinIBds. \$14.95. Both for \$30. Bare cards available. Check/MO/ISA/MC.

NuScope Associates*, Dept B

P.O. Box 790 • Lewiston New York • 14092
*A Division of Kosmic MicroTech Inc.

Inquiry 675.

DOCUMENTATION

DOCUMENTATION

When they ask about your manual . . . Do you politely change the subject? No more! Give them documentation you can be proud of, at a cost you can afford. Fixed price contract, professional quality, quick turnaround.

Call today for a free estimate.

DOCUMENTATION-BY-MAIL

20370 SW 84 Avenue • Miami, FL 33189

(305) 253-2317

Inquiry 676.

DUPLICATION SERVICES

1/4" TAPE CARTRIDGE DUPLICATION

ALSO:

Disk duplication
Custom software binders
Custom diskette labels & sleeves
Complete packaging and assembly

West Coast Telecom

503-292-9357

Inquiry 677.

BLANKET SERVICES

Diskette duplication • Packaging • Stocking/Drop shipping • 48 hour delivery • SUPERLoK copy protection • No mastering fee • No charge for standard labels •

Star-Byte, Inc.

713 W. Main St., Lansdale, PA 19446

215-368-1200

800-243-1515

Inquiry 678.

SOFTWARE DUPLICATION

• One Stop Shopping • Technical Support
• Custom Packaging • Drop Shipping
• Copy Protection • Fast Turn-around
• Competitive Pricing

SATISFACTION GUARANTEED

800-222-0490 NJ 201-462-7628

MEGAsoft

P.O. Box 710, Freehold, NJ 07728

Inquiry 679.

FLOW CHARTS

STRUCTURED FLOW CHART

NSchart creates Nassi-Shneiderman (structured) flowcharts from a simple PDL. Keywords define structures & text strings appear in the chart. Easy to create, even easier to revise! Automatic chart sizing, text centering. Translators from many languages available. For Mac and IBM PC.

SILTRONIX, INC.

P.O. Box 82544, San Diego, CA 92138

1-800-637-4888

Inquiry 679.

HARDWARE

ADDCARD PUTS 8 SLOTS IN THE 5 SLOT IBM-PC FOR ONLY \$79.00.

Fits inside system • 100% IBM Compatible • Uses existing motherboard • Visa/MC/COD • Call or write for orders or brochure:

1-800-231-4310 Ext. 768 / 313-562-9768

Merak Ind. • 8704 Edna • Warren MI 48093

Inquiry 680.

THE BUYER'S MART

HARDWARE

68020 COMPUTERS

Up to 14.5 Mbyte RAM, 256K ROM, 30 users, DMA floppy and SASI (SCSI), calendar/clock w/bat. backup, timer, real time multi-tasking, multi-user op. sys., basic, assembler, screen editors, spreadsheets. Fits PC type cabinet. Mem. Prot. option, more.

From \$2195.00.

Other 68XXX computer systems from \$995.00.

AAA Chicago Computer Center

120 Chestnut Lane - Wheeling, IL 60090
(312) 459-0450

Inquiry 681

HARDWARE

INDUSTRIAL STRENGTH COMPUTER

Has optimum features for monitor + control applications 16 Chan A/D * 8 Opto INs * 8 HiDrive OUTs * 48 Prog I/O Lines 3 RS232/422 Ports * 4 Timers * Watchdog * 90K Memory * 5.25x8.0 Options: Resident FORTH 79 OS with Target Compiler Editor, Assembler, and Auto Load/Start: 5 MHZ 8085 4 Chan D/A * Battery Backed Clock/RAM * Networking. E-PAC 1000 \$229. E-PAC 2000 \$399.

EMAC INC.

PO Box 2042, Carbondale IL 62902
(618) 529-4525

Inquiry 687.

HARDWARE

FOR SALE

CIE multibus 6807/30 computers c/w 20meg, 512K, 68,000 CPU, 1 floppy, 4 SP, 1P port, tape interface (3 slots), 19" rack style, c/w rails, regulus O.S., \$4,850. Cdn. Unused. 10 only.

CALL:

(613) 966-6248

Inquiry 693.

HARDWARE/ADD-ONS

HARD DISK DRIVES FOR IBM

PC's & AT's

TOSHIBA

• 86 MB HARD DRIVE • 22 ms average access time Perfect for IBM XT or AT computers, 129 MB with RLL controllers. **SPECIAL \$995.00**

Call GSK Enterprises

(206) 820-1815 or (800) 827-5677
12514 130th Lane N.E. Kirkland, WA 98034

Inquiry 694.

68000/68020 SUPERMICROS

68000 from \$1495 68020 from \$2195
Up to 30 Serial Ports, 14.5 Mbyte RAM, Hard & Floppy Drives w/DMA, Real-Time Clock with Battery backup. Price includes Software: OS9/68000 or OS9/68020 Op Sys Basic09, C Compiler, Word Processor, Spreadsheet, Disk Backup & Communications Programs and much more.

Frank Hogg Laboratory

770 James St., Syracuse, NY 13203
315/474-7856 Telex 646740

HAVE YOU BUILT A CIARCIA DESIGN?

Designer kits at experimenter prices:
• Serial EPROM Programmer, BYTE Oct/86, \$89
• BASIC-52 Computer, BYTE Aug/85, \$169
• Serial Video Digitizer, BYTE June/87, \$99
• Grayscale Video Display, BYTE May/87, \$99
• Trainable IR Controller, BYTE Mar/87, \$54
More Kits available

Call CCI

4 Park Street, Suite 12, Vernon, CT 06066
(203) 875-2751

Inquiry 689.

CHIP CHECKER

• 74/54 TTL + CMOS • 8000 National + Signetics • 14/4000 CMOS • 14-24 Pin Chips • 9000 TTL • .3" + .6" IC widths Tests/identifies over 650 digital chips with ANY type of output in seconds. Software updates will be offered as new chips become available. IBM compatible version \$259. C128 + C64 version \$159.

DUNE SYSTEMS

2603 Willa Dr., St. Joseph, MI 49085
(616) 983-2352

Inquiry 683

Cleans up your line power!

Isobar protects computer from damage caused by high voltage spikes and AC line noise. It prevents errors, malfunctions, false computer printouts and disc skips, plus audio and video hash. Isolated filter banks isolate the outlets to prevent equipment interaction! 3-way spike protection! Free catalog.

Indus-Tool

730 W. Lake St., Chicago, IL 60606
Phone 312-648-2191

Inquiry 689.

APPLE COMPATIBLE PRODUCTS

16 RAM/80 Column Boards, 64K \$39. 256K \$109. 512K \$139. 1.0MEG \$238. 256K-1.0MEG includes XME PLUSWORKS Sfrw. II + 80 Col Bd \$49. IIe Keypad w/16 Keys \$39. II + Ie Cooling Fan w/surge protect \$29.95. Add \$3 Shipping. Write for complete list.

NEXO DISTRIBUTION

914 East 8th St., Ste. 109, National City, CA 92050
(619) 474-3328

Inquiry 695.

SAVE Direct Manufacturer XT/AT Compatible Wholesaler

XT Clone Bare Bone (case, 150WPS, 640K) \$295
XT Complete System (above + 2) Fujitsu Drives \$695
Hi-res Monitor, Mono Graphic Card, Keyboard, Zpp. 1sp. RTC
AT Clone Bare Bone (case, 200WPS, 512K, Phoenix Bios, 80286 610 Mhz) \$695
AT Complete System (above + 1.2MB, FID Controller, Hi-res Monitor, Mono Graphic Card, Keyboard, Zpp. 1sp. RTC) \$1195

Dealer inquiries invited Complete Computer Accessories/Peripherals

DAR HAN CORP. Visa/MC/AE Accepted

908 E. Main St., Alhambra, CA 91801
(818) 570-0398 or 284-2142
G/Net Advanced Network Available

Inquiry 684.

molecular™

SUPER MICRO 8 200MB HARD DISK UPGRADE

Upgrade Supermicro 8 with 5.25" Hard Disk, 66.6 MB per drive, up to 3 drives for a total of 200MB

DIGITAL PRO INCORPORATED

422 Equitable Bldg. II, Ortigas Ave.,
San Juan, MM, Philippines

TEL (2)-721-0658, TLX 27763 AQP PH

Inquiry 690.

NEW VOICE SYNTHESIZERS!

"The Parrot" for IBM Compatibles. It learns your words and never forgets. \$129.95. "Super Talker" for Commodore 64/128. \$79.95. "Super Talk" for Adam. \$99.95. All hardware includes software. Adam programs too! Order now or SASE for free catalog. Specify computer(s).

THE TALKING PEOPLE

1932 Carmania Lane, Huntington Beach, CA 92646
(714) 968-8355 Dealer inquiries invited.

Inquiry 696.

SANYO 550/555 USERS

TURBO BOARD-7.2 MHZ \$ 95.00
20 MEG EXTERNAL HARD DISK SYSTEM \$675.00
SANYO VIDEO BOARD (ORIGINAL) \$174.95
RS-232 BD. \$ 49.95
HARD DISK CONT W/CABLES & SOFT (ST-508) \$249.95
768K MEM, CLK, & EXPANSION BD.
(FREE RAMDISK, SPOOLER, & SOFTVIDEO-RUNS
IBM PROGRAMS) \$199.95

TAMPA BAY DIGITAL

1807 Gulf-to-Bay Blvd., Clearwater, FL 33575
813-443-7049

Inquiry 685.

NEW/USED APPLES & STUFF

MACINTOSH \$800. + up

Imagewriters 1 \$275

Apple II+ & IIE — Call

Macintosh Motherboards \$150 & up

We buy, sell, & horse-trade — Apple, IBM.

SHREVE SYSTEMS

845 Lark Ave., Shreveport, LA 71105
318-865-6743 4-9 p.m. C.S.T. VISA/MC

Inquiry 691.

MEMORY CHIPS

41256-150ns 2.30	8087-8mhz 145.00
41256-120ns 2.55	80287-6mhz 182.00
4164-150ns 90	27512 4.45
NEC V-20.8mhz 8.50	27256 4.45

SPECIAL

Speed up kit turns 4.7mhz XT up to 8mhz 35.00 includes, V-20, hardware, reset and speed switch.

WOOD & ASSOC.

fax (512) 331-9437 phone (512) 331-4865
call for volume pricing or unlisted items. subject to change.

Inquiry 692.

EPROM/EEPROM PROG. \$250

Programs 2716-27512, 25xx and 68764/66 eproms via RS-232. Also 874x micros and 28xxA & 52Bxx EEPROMs. Automatic baud rate select, built in help menus, no personality modules!

16 BIT I/O MODULE \$75

Low cost control via RS-232. Expands to 512!

INTELLITRONICS

P.O. Box 3263, Tustin, CA 92680
(714) 669-0614

Inquiry 686.

Z80™ / HD64180/CP/M™ CO-PROCESSORS

Plug-in co-processors for PC, PCAT.
Blue Thunder Z80 co-processors
6-mhz \$249.95 10-mhz \$399.95
12.5-mhz \$599.95

HD64180 co-processors \$295 and up
All co-processors with CP/M emulator. Software only emulator ZS1M only \$99.95.

Z-WORLD 408-980-1678

2065 Martin Ave. #110, Santa Clara, CA 95050
See Ad Page 74.

Inquiry 346.

THE BUYER'S MART

HARDWARE/GRAPHICS

HOUSTON INSTRUMENTS PLOTTERS
Houston DMP-40/41&42: A-B/C-D-size \$966/\$2577
Ioline LP3700 A-E size, 1 pen \$3317

DIGITIZERS
Summagraphics MM1201, pow. cable \$374
GICO MD7-1212 complete \$516
Hitachi HDG-1111C Tiger II w/stylus \$646

GRAPHICS BOARD/MONITOR COMBOS
Orchid TurboEGA & NEC Multisync \$1099
Artist 1 & Mitsubishi 19" monitor (C6922L/PAG) \$3588
Large corp. & institutional PO's accepted O.A.C.

ARDEN SYSTEMS, INC. (213) 479-6707 ext. 29
12335 Santa Monica Bl. #240, Los Angeles, CA 90025

Inquiry 699.

HARDWARE/PERIPHERALS

LOAD CELL INPUT & CONTROL
Local/remote control of plant processes via multi-drop bus from single serial port; compatible with all computers. Basic software included.

- Load cell input • 8 channel AC output •
- 24 channels AC/DC input/output •
- Count up/down/metered pump control •

SCALE-TRON INC.
P.O. Box 424, Lachine, Quebec, H8S 4C2 Canada
(514) 634-7083

Inquiry 700.

HELP WANTED

SOFTWARE ENGINEER
Design, test, develop, modify and evaluate computer software systems and applications for proprietary hardware built around microprocessor chips. Develop and maintain applications and/or systems software including CAD systems for VLSIC in "C" and the UNIX operating systems environment. Evaluate future high performance computer systems, design systems engineering and human computer interface, coordinating software development. Languages: C, UNIX-SHELL PROGRAMMING, ASSEMBLER. Some projects are performed on client sites at various geographic locations. 40 hours per week. 9 to 5. \$33,000 per year.
(Continued... see ad below)

Inquiry 701.

Must have BSEE and one year experience as a research/teaching assistant. Education to include computer architecture, software engineering, VLSIC design, computer algorithm design and analysis, and human computer interface. Experience to include the following projects: CAD (Computer Aided design) for VLSIC (Very Large Integrated Scale Integrated Circuits) using C and UNIX SHELL PROGRAMMING LANGUAGES; and, Design and Development of a Microprocessor chip. Send resume to:
Illinois Department of Employment Security
401 S. State St., 3-S, Chicago, IL 60605
Attn: L. Boksa, Ref. No. 6675-B.
An employer paid ad. *UNIX is a registered trademark of AT&T.

Inquiry 701

LAPTOP COMPUTERS

\$699 COMPLETE LAPTOP SYSTEM
Choose the new 24K Tandy 102 or 64K NEC 8300 laptop computers & combine it with our 3 1/2" disk drive, Sardine word processor and Random House dictionary (on a ROM chip) and even a carrying bag—all for just \$699—and less than 6 pounds! Add our IBM or Macintosh disk connection software for only \$49. Other accessories include a 2 lb. printer for \$99 or a 1200 baud 6 oz. battery-operated modem (Hayes compatible) for only \$179. FREE laptop catalog.
Traveling Software, Inc.
19310 North Creek Parkway, Bothell WA 98011
1-800-343-8080 (206) 483-8088

Inquiry 702.

MAILING LIST PROGRAMS

ROCKET MAIL
Flexible list manager, organizes multiple lists. 17 fields including UPS zone, help windows at field levels. Print labels 1, 3, 4 across. Indexed by last name, zip code, record number and status. IBM's & compatibles w/384K, DOS & hard disk. \$49.50.
Hooper Consultants
Rt. 3, Box 101-A, Double Springs, AL 35553
205-486-4669

Inquiry 703.

PROGRAMMER'S TOOLS

FREE PRICE GUIDE

Call or write for our FREE comprehensive price guide containing hundreds of languages, utilities and books specifically for IBM personal computers and compatibles. We're the world's leading independent dealer of programmer's development tools because we provide sound advice, low discount prices, fast delivery, FREE domestic shipping and no hidden charges.
Programmer's Connection 800-336-1166 USA
216-877-3781 OH & AK (Collect)
136 Sunnyside St. 800-225-1166 Canada
Hartville, OH 44632 9102406879 Telex

Inquiry 704.

DO YOU WRITE SOFTWARE?

EZ-INSTALL helps you CLEANLY distribute software applications or products to users! Get control—stop messing with .BAT files. Check available disk, memory, file sizes, time stamps, drives, directories, DOS versions, etc. "Bullet-proof" installation routines can be yours! Only \$69! (M/C, VISA).

The Software Factory, Inc.
15301 Dallas Pkwy, LB 44, Dallas, TX 75248
(214) 480-0835

Inquiry 705.

Modula-2

REPertoire is an integrated DBMS, window/forms/menu generator, multi-window text editor, and expression evaluator designed specifically for M2. Only \$89 with full (600K) source code and 320p printed manual. Complete manual for this and many other M2 tools available on free demo disk. MCVISA/AMEX/PO/COD.

PMI 4536 SE 50th, Portland, OR 97206
(503) 777-8844; BIX: pmi

Inquiry 706.

PUBLIC DOMAIN

RENT SOFTWARE \$1/DISK

Rent Public Domain and User Supported Software for \$1 per diskfull or we'll copy. IBM, Apple, C-64, Sanyo 550 and Mac. Sampler \$5. VISA/MC. 24 hr. info/order line. (619) 941-3244 or send #10 SASE (specify computer) Money Back Guarantee!

FutureSystems
Box 3040 (T), Vista, CA 92083
office: 10-6 PST Mon.-Sat. (619) 941-9761

Inquiry 707.

THE BEST OF THE BEST!

Public Domain & User Supported Software for IBM PC or compatible. Word Processing, Database, Spreadsheets, Utilities, Games, Accounting, etc! 60 disk package \$205.00, or rent 2 wks. \$75.00. Info & Super Sampler Disk \$6.50, Deluxe Word Processor \$6.50, both \$12.00. MCVISA

BLUE CIRCLE GROUP, INC.
5253 Chicago Ave. S, Minneapolis, MN 55417
(612) 823-4111

Inquiry 708.

PUBLIC DOMAIN SOFTWARE

Over 3000 disks covering PC/MS-Dos, CP/M, Macintosh, Atari and Amiga. Priced from \$6/disk by mail or download by modem from our 19 remote systems. (300-9600 baud. 600+ Megabytes online) for flat annual charge of \$50 (US). Fast service, shipped around the world. Call or circle inquiry #710 for our FREE 40 page minicatalog of highlights.

CANADA REMOTE SYSTEMS LIMITED
(1-800-387-1901) (1-416-231-2383)

Inquiry 709.

PUBLIC DOMAIN

ZULIA®

Run Color Graphics Programs in Your Monochrome Graphic Computer

For IBM PC or compatible • Includes several programs

MICRO-BOARD

P.O. Box 424, Elmwood Park, New Jersey 07407 USA
\$29.50 plus S&H, Foreign order add \$5.00 for shipping. NJ add 6% sales tax. Send \$1.00 for a full PD Software catalog.

Inquiry 710.

PUBLICATIONS

A D A

Code Reference Handbook with examples and easy-to-read descriptions. Attractive desk size copy. ONLY \$14.95!

- Easy to follow markers
- Pre-defined language attributes described
- Text I/O • Direct I/O • I/O exceptions

MJ Needham Software
Box 231178, San Diego, CA 92123
619-542-1643

Inquiry 711.

SOFTWARE ACCOUNTING

dBASE BUSINESS TOOLS

- General Ledger • Purch Ord/Inventory
- Accounts Recvbl. • Accounts Payable
- Order Entry • Job Costing
- Sales Analysis • Job Estimating

\$99 EA. + s&h w/dBASE 2, 3 or 3+ SOURCE CODE

dATAMAR SYSTEMS Cr. Crd/Chk/COD
6809-B Convo Court
San Diego, CA 92111 (619) 223-3344

Inquiry 714.

TIME & BILLING

400 clients/20 partners/80 job & 40 out of pocket categories/20 areas of practice/fixd fee or hourly/more! Prints billing/statements/aged rec's/more! Free phone support. \$149 (VISA/MC/AMEX). MS-DOS/CPM-80. Other original software.

FREE catalogue.
MICRO-ART PROGRAMMERS
614 Alameda Padre Serra, Santa Barbara, CA 93103
(805) 962-0922 (24 hours)

Inquiry 715.

SOFTWARE A.I.

NEW INTEGRATED ENVIRONMENT AI FOR THE IBM PC

TOPSI IS A FULL VERSION OF OPS5 WHICH RUNS UNDER MS-DOS, UNIX OR CP/M. A FAST, EFFICIENT EXPERT SYSTEM DEVELOPMENT TOOL.

PROTOTYPING: \$125 PRODUCTION: \$250
PROFESSIONAL: \$375 SHIPPING. ADD \$5

DYNAMIC MASTER SYSTEMS
POB 566456, Atlanta, GA 30356
(404) 565-0771 Telex #282923

Inquiry 716.

SOFTWARE BASIC

COMPILED BASIC TOOLS

We now carry a complete line of libraries and tools for Compiled BASIC in addition to our FINALLY series. Get our catalog of top brand products for Compiled BASIC, by calling 1-800 423-3400 (9:00 AM to 8:00 PM EST)

KOMPUTERWERK, INC.
851 Parkview Blvd., Pittsburgh, PA 15215
PA & AK call (412) 782-0384

Inquiry 717.

THE BUYER'S MART

SOFTWARE/BASIC

OPEN SYSTEMS/BBx BASIC "Development Environment"

A Window overlay Environment with programmed function keys to provide the following features: **ONLINE HELP Interface** - contextual and indexed - **Quick ERROR Help key**, **ASCII/BBx/ASCII PROGRAM CONVERTER** - use your own text editor. **DOS Interface**, **WORKSPACE Status**, and much more.

Demo Disk: \$10 U.S. (refundable on package purchase)
Package: \$250 U.S. Money Orders only, payable to:

Marshall H. Goodman Software Ltd.
c/o CIC Computer Information Centre
571 Adelaide Street East, Toronto Ontario, Canada M5A 1N8
(416) 947-9486

Inquiry 718.

SOFTWARE/BUSINESS

dFELLER Inventory

Business inventory programs written in modifiable dBASE source code.

dFELLER Inventory \$150.00

Requires dBASE II or III, PC-DOS/CPM

dFELLER Plus \$200.00

with History and Purchase Orders

Requires dBASE III or dBASE III Plus (For Stockrooms)

Feller Associates

550 CR PPA, Route 3, Ishpeming, MI 49849
(906) 486-6024

Inquiry 719.

THE EXECUTIVE™ VERSION 2.4

Organize yourself! The Executive integrates a customizable rolodex with activities by name, auto-dialing, calculator, calendar with alarm & word processing with inside calculations. Mail merge your rolodex entries. 140 p. user manual. 30 day guarantee. \$79

EXECUTIVE MASTERY SOFTWARE

P.O. Box 578-C, Concord, CA. 94520

orders
(415) 680-0202 (800) 682-2860

Inquiry 720.

DATA ENTRY SYSTEM

Heads-down data entry with two-pass verification for the PC/XT/AT & compatibles. Loaded with features like: Auto dup & skip, verify bypass, range checks, & table lookups. Fully menu driven only \$395.
Call for free 30 day trial period.

COMPUTER KEYES

21929 Makah Rd., Woodway, WA 98020
(206) 776-6443

LP88 — SPREADSHEET LP

Our best-selling menu-driven linear programming system now solves problems with 1000 constraints and 5000 variables up to 30 times faster. New version reads/writes Lotus worksheets. Use 1-2-3/Symphony as a matrix generator or post processor. Many other features including interactive and batch operation, spreadsheet-style display, equat on processor, problem-based storage, file I/O, Simtex restart, report generator, sensitivity analysis. IENews says: "The flexibility and features of this program are a bargain at its low price." \$149 with 6087 support and 100-page manual. \$29 for working demo and mini-manual.

EASTERN SOFTWARE PRODUCTS, INC.

P.O. Box 51328, Alexandria, VA 22309
(703) 360-7600

Inquiry 722.

LOGIC TREES

provide decisive advantages over spreadsheets: formulas and results on the same graphics; probability functions (explained by reviewer's guide). IBM PC or compatible for \$45.

MAYBESO INC.

6638 Monero Drive
Rancho Palos Verdes, CA 90274

Inquiry 723.

SOFTWARE/BUSINESS

PC-Write™ Shareware Ver. 2.71

Fast, full featured word processor/text editor for IBM PC. With spell check, screen clip, mailmerge, split screen, ASCII files, macros. Easy to use. Supports 400 printers - LaserJet+ and PostScript. Software, User Guide, and Tutorial on 2 disks for \$16. Try it, then register with us for only \$89 and get User Manual, 1 year tele-support, newsletter and 2 upgrades. 90-day guarantee. VISA/MC.

Quicksoft (206) 282-0452 CALL TODAY!
219 First N., #224J, Seattle, WA 98109

Inquiry 724.

ARTlease System

Lease management software for cycling paintings, objet d'art, etc. Includes inventory management, exchange scheduling, batched billing, cash flow projections, aging, P & L statements and more. Real time access for fast customer service. Runs on MS-DOS, 520K RAM, Monochrome Monitor \$395.00

WindhamWoods Publishing

P.O. Box 314, Windham, NH 03087
(603) 893-2667 VISA/MC (800) 537-5002

Inquiry 725.

DATA FORM

CREATE your own form for DATA ENTRY
GREAT FOR custom sales and purchase orders, bank loan packages, ledgers, etc. This product mixes data entry formats with numeric verification, word processing with/without line limits, tables, defaults, calculations.

COMPOSE DATA SERVICES

P.O. Box 247, Midway City, CA 92655
PC/compatibles \$39.95 + \$3.00 s&h + 6% CA tax

Inquiry 726.

SOFTWARE/CHURCH

PowerChurch Plus™

Fast, friendly, reliable church administration system. Full fund accounting, mailing lists, membership, contributions, attendance, word processing, accts. payable, payroll, multi-user support, and much more - all for \$495 complete. Demo version, \$10

F1 SOFTWARE

P.O. Box 3096, Beverly Hills, CA 90212
(213) 854-0865

Inquiry 727.

ROMAR CHURCH SYSTEMS™

Membership-61 fields plus alternate address; labels, letters, reports any field(s). Offering-256 funds; optional pledge; statements; post to 255 x/year. Finance-GIL with budget, up to 500 sub-totals & 99 depts; month & YTD reports anytime for any month. Size 2000 people/floppy; 25000/10 meg. Ad too short! Write!

Romar Church Systems, Attn: BMB

P.O. Box 4211, Elkhart, IN 46514
(219) 262-2188

Inquiry 728.

Church Package

Parishioner Time, Talent and Treasure System program is written in modifiable dBASE source code.

- Contributions • Disbursements • Ledger
 - Names with mailing labels
 - Personal information database.

Requires dBASE II or III, PC-DOS/CPM-80 \$200.

Feller Associates

550 CR PPA, Route 3, Ishpeming, MI 49849
(906) 486-6024

Inquiry 729.

SOFTWARE/ENGINEERING

SIMULATION WITH GPSS/PC™

GPSS/PC™ is an IBM personal computer implementation of the popular mainframe simulation language GPSS. Graphics, animation and an extremely interactive environment allow a totally new view of your simulations. Simulate complex real-world systems with the most interactive and visual yet economical simulation software.

MINUTEMAN Software

P.O. Box 1711Y, Stow, Massachusetts, U.S.A.
(617) 897-5662 ext. 540 (800) 223-1430 ext. 540

Inquiry 731.

ELECTRONIC CIRCUIT ANALYSIS

ECA-2 is a PC based high performance analog circuit simulator w/AC, DC, Transient, Fourier, Worst Case and Monte Carlo analysis. ECA-2 will handle circuits of approx. 500 nodes and 2500 components. In addition to value and tolerance, the component parameters include Bandwidth, Temperature Coefficient, Delay, Phase Angle and continuous or piecewise non-linearities. Includes component sweeping for optimization. Demo disk available. ECA-2 \$675. One year update service \$120.

TATUM LABS

1478 Mark Twain Ct., Ann Arbor, MI 48103
(313) 663-8810

Inquiry 732.

Classical Controls Analysis Program

Powerful, sophisticated stability analysis tool for XT, AT and Compatibles. S-plane, Z-plane, W-plane. High resolution Bode, Nichols, Nyquist, root locus and time response plots. Build system models from block diagrams using transfer function databases. Interactive, menu-driven, easy-to-learn user interface. Solves up to 50 equations. Analyze 60th order transfer functions. Mainframe power at PC price.

LEWIS ENGINEERING SOFTWARE

P.O. Box 55-BV, Andover, MA 01810
(617) 975-5509

Inquiry 733.

Affordable Engineering Software

CALL OR WRITE FOR FREE CATALOG
Circuit Analysis • Root Locus • Thermal Analysis • Plotter Drivers • Graphics • Signal Processing • Filter Design • Report Proof-reader • Transfer Function Analysis • PC/MSDOS • Macintosh • CP/M, VISA/MC.

BV Engineering • (714) 781-0252

2200 Business Way Suite 207, Riverside, CA 92501

Inquiry 734.

SOFTWARE/GENERAL

WOULD YOU LIKE TO KNOW?

Your I.Q.? Memory Level? Response Time? Coordination? Visual Perception?

Expand your mind with **MENTOR™**—software that lets you explore your hidden talents. 58 psychometric exercises, incl. 25 I.Q. tests.

IBM PC/Compatibles • 256K • \$49.95 • VISA/MC

Heuristic Research, Inc.

3112-A West Cuthbert Ave., Midland, TX 79701
800-443-7380 (In TX, collect 915-694-5936)

Inquiry 735.

QUICK BASE CONVERSION

- Arbitrary Base Calculator: $x / + -$ and MOD in any base, any length. \$49.95 + \$4.00 S&H.
- 3-D Perspective Processor: Realistic view from any angle, any distance. \$99.95 + \$4.00 S&H.
- Both require IBM PC (256K up).

bp-Coding Systems

2445 University Heights Ave., Boulder, CO 80302
telephone (303) 442-1943 • facsimile (303) 442-1967

Inquiry 736.

THE BUYER'S MART

SOFTWARE/GENERAL

SongWright III

Music Processor for IBM Compatibles
Prints quality lead sheets, songs, scores with text and symbols, multiple staves; transposes to any key, plays tunes. Screen graphics editor; IBM/Epson/Star printers. Send \$49.95, \$2 s&h or write for free sample output.

SongWright Software

Route 1, Box 83, Lovettsville, VA 22080
(703) 822-9068

Inquiry 737.

GREAT SOFTWARE, CHEAP!

Absolutely smashing User Supported Software \$4.95 per disk. PC-Outline, AutoMenu, PC-Key Draw, PC-DeskTeam, PC-Write 2.7, Poster-Banner, DOSamatic, utilities galore, games, much more! Money-back guarantee. IBM PC, PC Jr, or compatibles. FREE CATALOG.

SHAREWARE EXPRESS

31877 Del Obispo, Suite 102M, San Juan Capistrano, CA 92675

Inquiry 738.

SMALL BUSINESS & HOME

Loans/Sav'g/Calculator/Cost Schedule/Help Access List & Search. Files: Create, Read, Add Data-Charge Accts. Budget, Inventory, Tally, Auto Phone, Payroll. Invoice Sales/Ser./Payments/Rtns. Check/Bank SImts. Text-File. Sorts. Instrs. List Code-Basic. IBM & Compatible. 256K. Add'l... APTS Rental File + \$5.
\$39.95 + \$5 S/H COD/M.O./Csh-Chk.

CALC-DATA, INC. 800-247-7893
305-456-0417
460 Tamarind Dr., Hallandale, Fla. 33009

Inquiry 739.

SOFTWARE/GRAPHICS

If You Could See In 4D

You'd get six viewing axes instead of three, and familiar 3D objects would wrap or skew. Now you can see this with 4D Graphics Lab. Tired of flatland? Head for higher ground as you explore the fourth dimension by computer. Rotate 4D and 3D objects in real time or slowly define new objects too. Order today for \$44.44 plus \$4 S&H, CA add \$2.89 tax. For Compaq, IBM PC, compatibles CGA or 256K EGA

4D GRAPHICS LAB
Suite 537, 12021 Wilshire Blvd., Los Angeles, CA 90025
(213) 479-4792

Inquiry 740.

GRAPHICS PRINTER SUPPORT

AT LAST! Use the PrtSc key to make quality scaled B&W or color reproductions of your display on any dot matrix, inkjet, or laser printer. **GRAFPLUS** supports all versions of PC or MS-DOS with IBM (incl. EGA), Tecmar, and Hercules graphics boards. \$49.95.

Jewell Technologies, Inc.
4302 SW Alaska St., Suite 207, Seattle, WA 98116
(206) 937-1081

Inquiry 741.

FORTRAN GRAPHICS LIBRARY

MicroGlyph/SciPlot™ provides (MS/IBM PRO/F77L) FORTRAN graphics on any IBM PC/XT/AT. Features lin/log axes, labels, Hershey fonts, hi res plots on (IBM/Epson/Apple Laser-Writer) printers, or graphics on (IBM Color/EGA/Hercules/Mono/Tecmar/GM) displays. \$89.95 plus \$3.00 shipping.

MicroGlyph Systems
P.O. Box 474, Lexington, MA 02173

Inquiry 742.

SOFTWARE/GRAPHICS

LAND SURVEYS

L-PLOT... A Metes & Bounds program to plot/print plats of Any scale—Any description—use Any measurement! Calc. areas, error of closure, plots multi titles. IBM/compat with monographics, CGA or EGA capability. \$190. \$15 working demo. Visa/MC/chk.

LAN/SCAN, INC.

P.O. Box 6863, Abilene, TX 79608
(214) 824-6419

Inquiry 743.

H-GRAPHICS

Hercules Graphics Toolkit for IBM PC and compatibles

Full *Hercules Graphics* support from: BASICA, GWBASIC, Quick BASIC, PASCAL, C, CLIPPER, and other languages 38 functions for drawing, text, windows, screen dumps et c. etc. "Easy Graphics" PC User (UK) 3/87 only \$80 inc. air freight. Send for brochure and review reprint.

Laboratory Software Ltd.

2 Ivy Lane, Broughton, Aylesbury,
Bucks, HP22 5AP England. (0)296 431234

Inquiry 744.

PC TECHNICAL GRAPHICS

TEKMAR is a graphics library for the EGA or Tecmar Graphics Master. Similar to PLOT-10, includes WINDOW, VIEWPORT, AXIS. Support for HP, HI plotters. Curve fitting, complete plotting program. Log, semi-log, multi-axis, 3-D, contours. Jerry Pournelle (Aug 86 Byte): "As good as any I have ever seen..." Demo disks, literature available.

Advanced Systems Consultants
21115 Devonshire St. #329, Chatsworth, CA 91311
(818) 407-1059

Inquiry 745.

FORTRAN PROGRAMMER?

Now you can call 2-D and 3-D graphics routines within your FORTRAN program.
GRAFMATIC: 75 callable routines for screen output. \$135.
PLOTMATIC: Pen plotter driver. \$135.
For the IBM PC, XT, AT and compatibles. We support a variety of compilers, graphics boards and plotters.

MICROCOMPATIBLES
301 Prelude Drive, Dept. B
Silver Spring, MD 20901
(301) 593-0683

Inquiry 746.

SOFTWARE/INVENTORY

SUPER RETAILER™ Is HERE!

Find out why over 500 purchases a second are made on the finest point of sale program. Ultra-flexibility-cash, returns, credit, debts... Control your bus. Keep track of your money. Inventory module - \$99. Become a Super Dealer. Modules for acting integrate automatically. 60 Day Money Back Guarantee. VISA/MC. IBM & compats.

PMC
100 East 2nd Street, Mineola, NY 11501
800-DIAL-PMC in NY 516-294-1400

Inquiry 747.

SOFTWARE/LABELING

LARGE TEXT—LABELS and FORMS

Print big text labels readable at 50 ft. Uses IBM PC with Epson/Okuli/IBM printer. 13 text sizes to 1.2" x 1.0". Color, Reversals, Bar Codes, File Input. Any Size, Flexible Format. Easy Menu Driven - \$279. Also from dBASE, Basic, Wdstr, Lotus, ANY program —\$239. Fast, Easy, 30 day Money Back Guarantee.

Worthington Data Solutions
130 Crespi Court, Santa Cruz, CA 95060
(408) 458-9938
See our ad on page 120

Inquiry 748.

SOFTWARE/LANGUAGES

Super 8 Cross Assembler

Full feature Zilog-compatible two pass absolute cross assembler provides TEK or Intel Hex output at over 8,000 lines per minute. Resident debugger/monitor included free. Z-80 CP/M only, \$150.00 (most 5.25" formats). Super8 FORTH available.

Tinkertronics

96 E. Broad Street, Bergenfield, NJ 07621
(201) 384-1596

Inquiry 748.

Minnesota SNOBOL4 Language

Powerful string & data handling facilities. Interpreter compatible with mainframe SNOBOL4. 32K strings, 32 bit integers, 8087 for float & large memory model. Sample pgms include ELIZA. For > 128K IBM PC & DOS or equivalent. Definitive "green" book by Griswold et al available.
Guide + 5 1/4" SSD diskette..... \$44.95
Guide + diskette + "green" book..... \$59.95
"Green" book only..... \$26.95
Postpaid in USA. In NY add tax. VISA/MC (914) 271-5855

BERTIS INTERNATIONAL
POB 441, Millwood, NY 10546

Inquiry 749.

FORTRAN UTILITIES

CROSS-REFERENCE UTILITY: Mainframe grade symbol x-ref listing for variables, subprogram calls and labels. Variable map shows type, length, alloc, scope, usage tag, etc. All FORTRAN 77 compilers. \$49.95 + \$2.50 S&H.
UTILITY LIBRARY: Assembly language routines for screen, cursor, keyboard, time, sound, etc. MS/IBM and IBM Pro/ROM FORTRAN compilers. \$39.95 + \$2.50 S&H.
IBM PC with DOS 2.0+. VISA/MC/MO/check (2 wks)

PJN INTERNATIONAL
P.O. Box 201363, Austin, TX 78720
(512) 258-1235

Inquiry 750.

CBTREE FOR C PROGRAMMERS

B-tree ISAM driver written completely in 'C' to K & R standards. Supports multiple keys, variable key lengths, fixed or variable length data records. Easy to use sample programs and quality documentation. Fast, Flexible, Efficient. Source code and no royalties for only \$99 plus shipping.

PEACOCK SYSTEMS, INC.
2108-C Gallows Rd., Vienna, VA 22180
(703) 847-1743

Inquiry 751.

SCREEN PROGRAM GENERATOR

SPG I creates BASIC program code quickly and easily. Design your screen directly and SPG I will generate the BASIC program code to handle the display and input of data. Controls use of color, editing, graphics, cursor movement and function keys. Generated code easy to modify / merge / compile. IBM PC & compatibles 128K.
\$49.95 + \$3 S&H (CA+tax)

Treebeard Software
5901 Warner Avenue, Suite 428, Huntington Beach, CA 92649
(714) 840-6939

Inquiry 752.

NS32000 MODULA-2 COMPILER

Fast Program Development System for use with MODULA-2 application programs enables you to write entire PC/M-based NS32000 target programs in MODULA-2. INLINE code procedure as well as data-types LONGINT, REAL, LONGREAL supported. Complete w/"System" module (runtime support) in source form. Requires IBM-PC or Compatible with free 1/2 card slot. No debugger or programmer included as yet. U.S. \$1995

ALOIS SCHÖNBÄCHLER
Frieschützgasse 14, CH-8004 Zürich, Switzerland
41-1-241-0514

Inquiry 753.

THE BUYER'S MART

SOFTWARE/SCIENTIFIC

ORDINARY/PARTIAL DIFFERENTIAL EQN SOLVER

FOR THE IBM PC & COMPATIBLES

MICROCOMPATIBLES INC.
301 Prelude Dr., Silver Spring, MD 20901
(301) 593-0683

Inquiry 754.

CROSS ASSEMBLERS for VAX VMS and PC/MS DOS

Faster Version 2.1 Now Available
Relocatable Macro Cross Assemblers,
Linkers, Librarians
Targeted to almost all Microprocessors
ENERTEC, INC.

BOX 1312, Lansdale, PA 19446
215-362-0966 **MC/VISA**

Inquiry 755.

DATA ACQUISITION AND ANALYSIS ON PC'S

MEASURE for Data Acquisition directly to Lotus 123 • FOURIER
PERSPECTIVE II advanced Digital Signal Analysis • PRIME FAC
TOR FFT subroutine library. Call from Turbo Pascal, C, Fortran, Basic.
Up to 65,520 data points. 2D interface available. Rectangular FFT's
now possible in a multitude of dimensions. • TURBO PASCAL
scientific engineering tools from Quim-Curia • 2 & 3D scientific graphic
packages with plotter support from Golden Software. • MATHCAD
by Mathsoft creates & edits equations. • 8087 Math Coprocessors,
all varieties • Data Acquisition & Control Boards from Metrabyte.
LOW prices — FREE Customer Service — Satisfaction GUARANTEED

ALLIGATOR TECHNOLOGIES
P.O. Box 11386, Costa Mesa, CA 92627
(714) 722-1842

Inquiry 756.

PlotIT® Interactive Graphics & Statistics

Create scientific, analytical and business graphs the way you want.
• 36 graph types including 3-dimensional.
• 50 statistical functions supplied.
• Can display standard error bars on graphs.
PC version \$550. Mainframe versions also.
In United States: In Europe:

Gracen Services, Inc. **ICS**
4832 Okemos Rd. Kronberger Strasse 27
Okemos, MI 48864 D-6000 Frankfurt 1, FRG
(517) 349-4900 (069) 724-0927
Telex: 4 189686 ics d

Inquiry 757.

forMath® text-formatter

• Equations, matrices, ratios, integrals, diagrams
• Macros, fonts, Greek/math symbols
• Hyphenation, secn/eqn/ref numbering
• Indexes, table of contents, footnotes
• Dot-matrix, daisywheel, laser printers, all monitors
\$400. \$50 for demo

SHANTHA SOFTWARE INC.
50 West 97th St. Room 11N, New York City 10025
(212) 222-SNIP
Touchtone toll free: 950-1088-walt-FORMATH

Inquiry 758.

SCI-GRAF and SCI-CALC

SCI-GRAF produces huge three graphs thru easy menus or linkable C libraries. Supports log scales, error bars, screen and printer output.

SCI-CALC is a pop-up calculator with complete expression editing, scientific, statistical, and logic functions.

Prices start at \$79.95.

Microcomputer Systems Consultants
32 West Anapamu, Suite 190, Santa Barbara, CA 93101
(805) 963-3412

Inquiry 759.

SOFTWARE/SCIENTIFIC

COMPLEX — POP UP SCI CALCULATOR

COMPLEX is everything sci. calculator can hope for plus complex algebra, integer & bit manipulation, Boolean Logic, Polynom. eqn., FFT, graphics, curve fitting, and an extensible language. Comes with free DISKUTIL software. \$59.95 (or \$120 for Turbo Pascal source and Turbo-Linker software).

SoftTech Inc.

14640 LaBelle, Oak Park, MI 48237
1-313-544-8544

Inquiry 760.

MATRIX CALCULATOR

Linear Programming, Eigen Analysis, Solution of System of Eqns., Statistics, Multilin Regression, Diff Eqns, and more. Flexible, Programmable commands. Needs 8087. Comes w/Free DISKUTIL software. \$59.95 (\$120 w/Turbo Pascal source and Turbo-Linker software).

SoftTech Inc.

14640 LaBelle, Oak Park, MI 48237
1-313-544-8544

Inquiry 761.

KALMAN FILTERING

PC filter/smoothen. Covariance and regression analyses, error budgets, unlimited data set size + much more. Executable \$250. Source code available.

Bierman & Associates

4419 Coldwater Cyn Suite J, Studio City, CA 91604
(818) 761-7082

Inquiry 762.

SOFTWARE/SORT

OPT-TECH SORT/MERGE

Extremely fast Sort/Merge/Select utility. Run as an MS-DOS command or CALL as a subroutine. Supports most languages and filetypes including Btrieve and dBASE. Unlimited filesizes, multiple keys and much more! MS-DOS \$149. XENIX \$249.

(702) 588-3737

Opt-Tech Data Processing
P.O. Box 678 - Zephyr Cove, NV 89448

Inquiry 763.

SOFTWARE/TOOLS

LET'S TALK PHONETICS

When files are crowded with names, what a relief to locate individuals by phonetic. Added to your code. PHONKEY converts names to 16 bit phonetic keys for you to store. Compare them with that of target name, et voila! \$69.95 + s/h. See our ad in Byte-bits section.

SYBIS INC.

1600 St. Martin Blvd. E., Tower A, Suite 610,
Laval, Quebec, Canada H7G 4R8
(514) 662-2227

Inquiry 764.

SCREEN MASTER

For business professionals, programmers and home users

Create demos, prototypes, tutorials, w/384 color combinations & animation. Capture screens from programs. Design menus instantly. Enhance high level languages w/23 utilities. Run-time module for distribution. Simple enough for anyone — complex enough for any job.

GENESIS DATA SYSTEMS

5403 Jonestown Road, Harrisburg, PA 17112
(717) 652-1200

Inquiry 765.

SOFTWARE/TOOLS

SCREEN MANAGER

SAVE TIME! Powerful Screen Designer and Data Entry Manager increases your productivity! Interfaces to most languages. BASIC, C, FORTRAN, COBOL, PASCAL, PLM86, ASSEMBLER. Not a Code Generator! No Royalties. \$79. Visa/MC
FREE DEMO DISK

The West Chester Group
P.O. Box 1304, West Chester, PA 19380
(215) 644-4206

Inquiry 767.

STATIONERY

Deluxe PC Stationery

Letterheads in continuous forms w/invisible perforated edges plus matching window or regular envelopes in watermarked quality Classic Laid paper. Numerous colors of ink & paper available utilizing many standard formats & type styles or supply your own, all at very low prices & fast delivery. Call for free samples, prices & info, or write:

PerFORMS Press

8456 Lofton, Cordova, Tenn 38018
(800) 624-2961 (Tenn: 901-756-7010)

Inquiry 768.

STATISTICS

SAS*-like Power on a 256K PC

BASSBase runs many SAS programs on a 256K 2 floppy PC. BASSStat adds an expanded stat pack. BASSView gives a true windowing environment. Cks/MC/Visa. SAS a SAS Institute TM. BASSBase-\$95 If ordered by 6/30/87 BASSBase/BASSView-\$149 BASSBase/BASSStat-\$159 BASSBase/Stat/View-\$199

BASS Institute Inc.

P.O. Box 349, Chapel Hill, NC 27514
919-489-0729 BB: 919-489-9665(N,8,1)

Inquiry 769.

STATISTICS CATALOG!

If you need statistics for IBM PC or Apple II, call us and let our technical advisors help you find the statistics programs you need. Write or call now to get a FREE catalog of statistics and quality control software.

HUMAN SYSTEMS DYNAMICS

9010 Reseda Blvd., Ste. 222
Northridge, CA 91324
(800) 451-3030 (818) 993-8536 (CA)

Inquiry 770.

PRO ☆ CAST

FORECAST SALES, INVENTORIES, etc.

Complete time series analysis — trend, seasonality, exponential smoothing, Box Jenkins, and more. Great graphics! Exchange data with other programs. \$150. 30-day m/b guarantee. Demo \$10. IBM-PC or compatible.

FLEMING SOFTWARE

P.O. Box 528 • Oakton, VA 22124 • (703) 591-6451

Inquiry 771.

StatPac Gold™

StatPac Gold is the high-powered statistics and forecasting package that delivers! It's fast, flexible, easy to use and dependable. Time-tested and loaded with features. It's all here! Unlike any other. Get the facts! Call now for your FREE brochure.

1-800-328-4907

Walonick Associates, Inc.

6500 Nicollet Ave. S., Minneapolis., MN 55423
(612) 866-9022

Inquiry 772.

THE BUYER'S MART

STATISTICS

STATISTIX™

\$75 - Satisfaction guaranteed

A comprehensive, powerful, yet easy-to-use statistical analysis system for IBM PC/XT/AT's, Apple II's, and MS DOS machines. Clear 200p manual. Write for information.

NH ANALYTICAL SOFTWARE

801 West Iowa Ave., St. Paul, MN 55117

(612) 488-4436

Inquiry 773.

NUMBER CRUNCHER STAT SYS

Menu-driven. Multiple & stepwise regression, ANOVA, time series, discriminant cluster and factor analysis, principal components, scatter plots, histograms, t-tests, contingency tables, non-parametrics. Import export data. Spreadsheet, sort, join, merge. \$79. IBM PC/Macintosh. Quantity discount.

NCSS-B

865 East 400 North, Kaysville, UT 84037

801-546-0445

Inquiry 774.

RATS! Version 2.1

Best selling econometrics program. Over 4000 copies sold. OLS, 2SLS, logit, probit and much more! Forecasting with ARIMA, VAR. Exponential smoothing. Model simulations. Support for daily/weekly data. High-quality graphics to screen, plotter, printer. \$200-\$300. VISA/MC. Demo available.

VAR Econometrics, Inc.

P.O. Box 1818, Evanston, IL 60204-1818

(312) 864-8772; (800) 822-8038

Inquiry 775.

PC SCA STATISTICAL SYSTEM (IBM PC or compatible)

Developed under the advisory direction of world renowned statisticians, PC SCA is the *only* statistical software encompassing forecasting, time series analysis, quality control and improvement, and general statistical analysis. Prices range from \$195 to \$695 (depending on capabilities.)

Scientific Computing Associates

Lincoln Center, Suite 106; 4513 Lincoln Ave.

Lisle, Illinois 60532 (312)-960-1698

Inquiry 776.

P-STAT®

Full mainframe package for PC/XT/AT & compatibles. Statistics, data & file management, data display, report writing and survey analysis all in one. 4GL programming language, online HELP & EDITOR, command or menu driven. \$95 demo and site license available. Standard PC package \$695.

P-STAT, Inc. (609) 924-9100

471 Wall Street, P.O. Box AH, Princeton, NJ 08542
Telex: 466452

Inquiry 777.

UTILITIES

CONCURRENT DOS BACKUP

BackPack™ runs like BACKUP/RESTORE and supports DOS and CP/M media as well as users. Backs up and restores up to 1000K/min. on an AT and 360K/min. on an XT. Supports release 4.1. Also available on CP/M-80 and CP/M plus. \$150.

Bright Light, Inc.

520 Fellowship Rd. #C301, Mt. Laurel, NJ 08054

(609) 778-0772

Inquiry 778

UTILITIES

SOURCE CODE LIBRARIAN & REVISION CONTROL SYSTEM

TLIB™ keeps ALL versions of your program in ONE compact library file, even with hundreds of revisions. • 5 times faster than SCCS • LAN compatible • Free public domain MAKE (with source) by L. Dyer MS/PC-DOS 2.x & 3.x. \$99.95 + \$3 S&H VISA/MC

BURTON SYSTEMS SOFTWARE

POB 4156, Cary, NC 27511

(919) 469-3068

Inquiry 779.

PADLOCK/PADLOCK II DISKS

PADLOCK furnishes the user with a method for providing protection against unauthorized duplication from DOS commands \$99. PADLOCK II disks come preformatted with finger-print and serialization. PADLOCK II disks offer superior protection. Ask about our HARD DISK protection with uninstall capability. MC/VISA.

GLENCO ENGINEERING

3920 Ridge Ave., Arlington Hts., IL 60004

(312) 392-2492

Inquiry 780.

ATs DON'T NEED 360KB DRIVES

The 1.2MB drive has long been known to READ but NOT reliably WRITE on 360KB floppies. With "CPYAT2PC" 1.2MB drives CAN reliably WRITE 360KB floppies saving a slot for a second hard disk or backup tape. "CPYAT2PC" (Not Copy Protected) offers the preferable SOFTWARE SOLUTION! ONLY \$79 + \$4 S/H VISA/MC/COD UPS B/R

MICROBRIDGE COMPUTERS

655 Skyway, San Carlos, CA 94070

Order toll free 1-800-821-0851 x777

415-593-8777 (CA) 212-334-1858 (NY)

TELEX EZLNK 62873089 Dealer inquiries invited

Inquiry 781.

Recover deleted files fast!

Disk Explorer now includes automatic file recovery. You type in the deleted file's name, Disk Explorer finds and restores it. Disk Explorer also shows what's really on disk; view, change or create formats, change a file's status, change data in any sector. MS-DOS \$75 U.S. Check/Credit card welcome.

QUAID SOFTWARE LIMITED

45 Charles St. E. 3rd Fl.

Toronto, Ontario, Canada M4Y 1S2

(416) 961-8243

Inquiry 782.

Protect your hard disk data!

Second Chance protects hard disk data files by making fast reliable backups. Second Chance is from Quaid Software, the makers of CopyWrite, so you can count on the same reliability, speed and ease of operation you're used to with CopyWrite. MS-DOS \$75 U.S. Check/Credit card.

QUAID SOFTWARE LIMITED

45 Charles St. E. 3rd Fl.

Toronto, Ontario, Canada M4Y 1S2

(416) 961-8243

Inquiry 783.

UTILITIES

InlineTools 2.0

Assembly programming in Turbo Pascal is easy with IT. Just write assembly code as comments, and let IT append inline machine code for you instantly. No more DEBUG and MASM. Write at ease DOS calls, and critical statements in tight and fast assembly, as illustrated in IT manual. \$69 + \$4 s/h..

Jou Laboratories

P.O. Box 460969, Garland, TX 75046

214-495-8862

BIX: jou

Inquiry 783.

FILE GENIE™

File Genie™ is a file conversion system which gives you the necessary tools to easily analyse and convert any file to a new structure. Ideal for re-structuring unusable data or word processing files. Search and replace in multiple files using "wild card" file descriptions. MS/PC-DOS. \$69.95 M/C VISA

TEAM AUSTIN, INC.

6809 Conroy Ct., San Diego, CA 92111

USA 800-822-0852

(In CA) 800-822-0853

Inquiry 784.

PRINTER! CACHE! RAMDISK!

PRINT-matic (\$16) sends predefined control codes to any printer from within applications AND allows you to change fonts while printing. WARP-TEN (\$16) is a programmable disk cache that speeds up your PC disk accesses. RAMbak (\$16) automates the saving of new or changed RAM disk files to floppy disks and/or hard disk subdirectories. PC, XT, AT, compatibles with 256K DOS 2.0+. (MN Res. + 6%). MCP

Software Brewing Company

P.O. Box 12094, St. Paul, MN 55112

612-636-2727

VISA/MC/CHK

Inquiry 785.

PAL FOR SIDEKICK!

Personal Appointment Locator automatically shows coming appointments, searches your file, maintains to-do list, automatically repeats appointments, examines multiple files. Resident alarm too! Only \$49.95. Cheap at twice the price!

PAL SOFTWARE

Ste. 12B 110 Green St., New York, NY 10012

212-334-9172

1-800-541-0900

(In CA.) 1-800-334-3030

Inquiry 786.

WRITE BETTER SOFTWARE

Add high level features to any assembler for any micro with our ASSEMBLY LANGUAGE PRE-PROCESSOR. Supports "begin," "while," "repeat," "until," "if," "switch," and other constructs as efficiently as hand-coded assembler. Checks program integrity and eliminates bugs. Create manuals with tables of content from comments in your programs with our DOCUMENT EXTRACTOR. Call for more info. Pre-processor \$29.95. Document Extractor \$19.95. BOTH for \$39.95. Includes manual.

HADDICK & HADDICK

P.O. Box 1586, Mexia, TX 76667 817-562-3444

Inquiry 787

WORD PROCESSING

HEBREW / GREEK / ARABIC

Russian and European Languages. Full featured, multi-language word processor supports on-screen foreign characters with no hardware modifications. \$350 (dot matrix) or \$500 (laser) + \$5 s/h. Or send \$15 + \$4 s/h for demo. Req. 512K/graphics

Gamma Productions, Inc.

710 Wilshire Blvd., Suite 609, Santa Monica CA 90401

(213) 394-8622

Inquiry 788.

HANDS OFF™ PC SECURITY

- Locks Hard Disk. - Restricts Floppy Use.
- Protects Subdirectories.
- Normal Use of DOS Commands and Application Software.
- IBM PC, XT, AT and True Compatibles.
- DOS V2.0 and Higher. Hard Disk System.
- Keep Other People's HANDS OFF Your System

- \$89.95

VISA/MC

SYSTEM CONSULTING, INC.

314 Canterbury Dr., Pittsburgh, PA 15238

(412) 963-1624

Inquiry 782.

PC Network / THE NATION'S LARGEST COMPUTER PRODUCTS MAIL ORDER COMPANY!

THE™ EGA + CARD

100% IBM™ EGA/CGA/MGA compatible. Perfect for high resolution graphics, printer port w/256K standard.

\$165⁰⁰*
(3.56) Shipping Wholesale Price



THE™ MULTI 384

100% AST™ compatible. Capable of 0-384K additional memory, w/R232 ser/par/game port, clock/calendar. w/OK

\$67⁰⁰*
(2.50) Shipping Wholesale Price



THE™ 2MB RAM CARD

Meets Lotus™/Microsoft™/Intel™ specs. RAMdisk, print spooler, software included. w/OK.

\$99⁰⁰*
(2.00) Shipping Wholesale Price



THE™ MULTI I/O

100% AST™ I/O compatible w/serial, parallel and game ports standard, second serial port optional.

\$60⁰⁰*
(2.50) Shipping Wholesale Price



THE™ PC ➔ Difference!

256K, upgradeable to 640K RAM, w/360K Disk Drive, Turbo Speed, "AT" Style Keyboard



"THE™ PC+ is well built and has enough company support behind it to make it a very attractive alternative to higher priced competition."

"THE's™ "bottom line? The PC+ is a highly compatible clone worthy of consideration..."

PC WORLD

"...the unit quickly became the preferred computer in our office, which has several name brands as possible alternatives..."

Computer Dealer



"...Computer Magazine Reader Poll..."



CERTIFIED 100% IBM COMPATIBLE

\$444⁰⁰*
(9.50) Shipping

Ask about our Custom Configurations

*MEMBERS PAY WHOLESALE + 8% OR LESS AND GET 14-30 DAY SOFTWARE RENTALS AND CATALOG

THE™ BEST BUYS in Modems

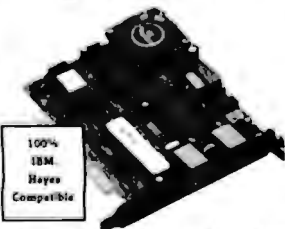

THE™ 1200 COMM INTERNAL
Features auto answer, dial/re-dial, built-in speaker w/volume control and FREE software.

\$88⁰⁰*
(2.50) Shipping Wholesale Price

THE™ 2400 COMM INTERNAL
\$197⁰⁰*
(4.20) Shipping Wholesale Price



"...THE™ modems offer a lower-priced alternative to the Hayes product with no apparent sacrifice in quality."
May 12, 1987

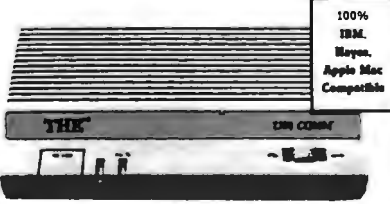

THE™ 1200 COMM EXTERNAL
With the same features as the internal modems these are perfect add-ons for IBM, Apple and other systems.

\$119⁰⁰*
(2.57) Shipping Wholesale Price

THE™ 2400 COMM EXTERNAL
\$220⁰⁰*
(4.75) Shipping Wholesale Price

THE™ Disk Storage Units



20MB Hard Disk Subsystem

1/2 Height Hard Disk w/controller card, cables and manual.

Wholesale Price

(7.50) Shipping



THE™ 20MB Hard Disk on a Card
3.5" 20MB Hard Disk and Controller on a single card.

Wholesale Price

\$375⁰⁰*
(8.10) Shipping

MON.-FRI. 8am-7pm (CST) SAT. 9am-5pm
PERSONAL COMPUTER NETWORK
320 West Ohio Street, Chicago, Illinois 60610-9934

*PC Network Members pay just 8% above the wholesale price, plus shipping. AD prices reflect a 3% cash discount. Minimum shipping \$2.50 per order. International orders call for shipping & handling charges. Money orders, personal and company checks please allow 10 working days to clear. All prices subject to change without notice. Products subject to availability.

(800) 621-SAVE

Validation # B367

(For Orders, Membership and Advice!) In Illinois (312) 280-0002

For Customer Service & Order Status: (312) 280-1567



1 YEAR WARRANTY on PARTS and LABOR
45 DAY MONEY BACK GUARANTEE

PC Network

THE NATION'S LARGEST COMPUTER PRODUCTS MAIL ORDER COMPANY

PAY WHOLESALE SOFTWARE AND GET

The World's #1 Supplier of Everything for the Program Developer

Arity Expert System Development Package	\$235.00*	Central Point Copy II PC	\$20.00*	Microsoft Cobol Tools	\$186.66*	Ryan McFarland Cobol BX Runtime	\$189.00*
Arity File Interchange Toolkit	37.00*	Compview Vedit	95.00*	Microsoft Basic Interpreter for Xenix	193.80*	Ryan McFarland Cobol Network Full System Ver 2.1	799.00*
Arity Prolog Compiler and Interpreter	650.00*	Compview Vedit + w/windowing capabilities	145.00*	Microsoft Basic Compiler	219.30*	Ryan McFarland Cobol Network Runtime Ver 2.1	339.00*
Arity Prolog Interpreter	275.00*	Fifth Generation Fastback w/50 DS/DD Diskettes	85.00*	Microsoft C Compiler	244.00*	Softcraft Brievie Ver. 3.0	175.00*
Arity SQL Development Package	235.00*	Human Edge Software Expert Edge	374.25*	Microsoft Cobol Compiler	386.58*	Softcraft Xtrieve	156.00*
Arity Screen Design Toolkit	37.00*	Lattice C-Compiler 3.1	250.00*	Microsoft Fortran Compiler Xenix	319.26*	Softcraft Xtrieve	109.00*
Arity Standard Prolog	70.00*	Lattice C-Sprite Debugger	115.00*	Microsoft Fortran Compiler PC	263.92*	Softcraft Xtrieve Network Version	249.00*
Blaize Async Manager for C or Pascal	115.00*	Lattice C-Code Smorgasbord	82.00*	Microsoft MULISP, MUMATH or MUSIMP	183.60*	Softcraft Xtrieve or Brievie, Network Version	419.00*
Blaize C Tools/Tools 2 Combo Pack or C Tools Plus	115.00*	Lattice Sidetalk	79.00*	Microsoft Macro Assembler 4.0	86.39*	Softlogic Solution Disk Optimizer Double DOS, Cubit	28.00*
Blaize C Tools or Pascal Tools	85.00*	Lattice DBC/III Library	137.00*	Microsoft Pascal Compiler for Xenix	400.25*	Software Channels Alice	59.00*
Blaize C Tools 2 or Pascal Tools 2	65.00*	Lattice RPG-III Compiler	410.00*	Microsoft Pascal Compiler for PC	158.10*	Software Garden Dan Bricklin's Demo Program	55.00*
Blaize Exec Programmer Chainer	65.00*	LogiTech LogiMouse +	89.00*	Microsoft Sort Facility	117.00*	STSC APL Plus/PC System	370.00*
Blaize Pascal Tools/Tools 2 Combo	115.00*	LogiTech LogiMouse + w/PC Paint	117.00*	Microsoft Programmer's Tool Kit for Windows	295.00*	STSC Stographics	520.00*
Blaize Runoff	35.00*	LogiTech LogiMouse + w/Generic CAD	139.00*	MLI Disk Mechanic	40.00*	STSC Pocket APL	69.00*
Blaize Turbo Async + or Power Tools +	65.00*	LogiTech LogiMouse + w/Reflex	145.00*	Morgan Computer Professional Basic	70.00*	Summit Software Better Basic	119.40*
Blaize View Manager w/Source for C or Pascal	185.00*	LogiTech LogiMouse + w/Reflex CAD & PC Paint	158.00*	Morgan Computer Trace 86	77.50*	Summit Software 8087 Math Module	59.00*
Borland Reflex Turbo C or Turbo Basic	54.00*	LogiTech Module 2/86 Compiler	55.00*	Peter Norton Norton Utilities 4.0	45.00*	Summit Software Runtime System	150.00*
Borland Reflex and Workshop Bundle	80.00*	LogiTech Module 2/86 Compiler w/8087	85.00*	Peter Norton Norton Utilities Advanced Edition	70.75*	True Basic Algebra, Trig, Pre-Calculus & Calculus	27.00*
Borland Reflex Workshop	39.00*	LogiTech Module 2/86 Compiler w/512K	142.00*	Peter Norton Norton Commander	33.00*	True Basic Async Com Lib or Brievie Interface Lib	17.00*
Borland Turbo Database or Editor Toolbox	36.50*	LogiTech Module 2 Runtime Debugger	48.42*	Phoenix PFinis, PFix 86 Plus, or PForce	219.00*	True Basic Developer's Toolkit or Chippendale	27.00*
Borland Turbo GameWorks or Graphics Toolbox	39.00*	LogiTech Module 2 Source Package	79.00*	Phoenix PLink-86 Plus	290.00*	True Basic Discrete Math, Form Lib or Probability	27.00*
Borland Turbo Lightning	52.00*	LogiTech Module 2 Translator, Utilities Pkg or Window	35.00*	Phoenix PMail or PTeC	119.00*	True Basic Hercules Graphics Support Lib	27.00*
Borland Turbo Pascal w/8087 & BCD Support or Prolog	53.00*	Micro Focus CoGraphics	199.00*	Phoenix Pro-C	160.00*	True Basic PC Basic Converter Library	27.00*
Borland Turbo Tutor	21.25*	Micro Focus CoMath	150.00*	Phoenix PForce for Lattice C or Microsoft C	210.00*	True Basic Sorting Searching or String Lib	27.00*
Borland Word Wizard	39.00*	Micro Focus Forms-2	245.00*	Ryan McFarland Fortran 77 Compiler	327.00*	True Basic True Basic	89.94*
Borland Word Wizard and Turbo Lightning Bundle	81.00*	Micro Focus Micro/SPF	140.00*	Ryan McFarland Cobol Full Development	520.00*	Wordtech Systems Hot C Compiler	59.00*
Borback, Inc. 1 DIR +	42.50*	Micro Focus Multiuser Runtime for PC Net	400.00*	Ryan McFarland Cobol Runtime	150.00*	Wordtech Systems DBXL	80.00*

MICROSOFT. WORD 3.1



Latest Version. Now Includes Spell Checker and Thesaurus

\$180.50*
(Shipping \$3.90)

MICROSOFT. WINDOWS

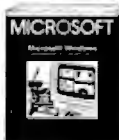

Work on Several Projects at Once, Easily Move and Consolidate Info

\$55.08*
(Shipping \$2.50)

MICROSOFT. QUICK BASIC



Compiler Compatible w/BASICA Programs & Runs Them 10X Faster

\$55.08*
(Shipping \$2.50)

America's Favorite Business Software For the IBM and Compatibles



Lotus 1-2-3
Lotus Spreadsheet

\$295.00*
(Shipping \$4.37)

DBase III +
Ashton-Tate Database

\$385.00*
(Shipping \$8.33)

Word Perfect
Satellite Software Word Processor

\$185.00*
(Shipping \$4.00)

ORCHID

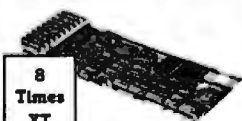

8 Times XT Speed!

286E

w/1MB of RAM, Expandable to 2 Socketed for 80287, PC/XT/AT Compatible, 2.5 Times AT Speed!

\$650.00*
(Shipping \$14.94)

AST



Advantage

128K, 1.5MB 1 Ser/1 Par Port Optional Game and Second Serial Port

\$325.00*
(Shipping \$7.02)

PARADISE



Autoswitch EGA

\$336.00*
(Shipping \$7.26)

Modular Graphics Card **\$219.00***
(Shipping \$4.73)

DISKETTES GUARANTEED FOR LIFE!

Brand Name Diskettes available in boxes of 10 or bulk packs of 50

5 1/4" DS/DD

\$7.95*

Box of 10

.44*

Box of 50

5 1/4" QD

1.2MB

\$16.25*

Box of 10

3 1/2" DS/DD

Free Flip & File

\$17.00*

Box of 10

NEC



P6/CP6

216 CPS Draft 72 CPS Letter Quality

\$415.00*
(Shipping \$8.96)

OKIDATA



Laserline 6

6 Pages per minute, 300 dots per inch, 15 fonts (Requires Identity)

\$1380.75*
(Shipping \$29.82)

EPSON



FX286E

132 CPS Letter Quality Mode, 200 CPS Draft Quality Mode

\$479.00*
(Shipping \$10.35)

BEST BUYS in Chips

64K Memory Upgrade Kits (9 Chips)

\$775*

Intel 8087 Math Co-Processor

\$105.00*

256K Dynamic RAM Chips ea. \$2.90*

128K AT Mother Board Chips
Intel 8087 8Mhz Co-Processor
Intel 80287 8Mhz Co-Processor

ea. \$3.90*
155.00*
235.00*

ALL CHIPS ARE GUARANTEED FOR LIFE

+8% OR LESS FOR HARDWARE AND 14-30 DAY SOFTWARE RENTALS!!!

Inquiry 224

THE™ BEST "AT" CLONE IN THE BUSINESS POWER, PRICE, PERFORMANCE

THE™ 286/10 ➔
Model I Base System
With 1.2MB Floppy Drive,
Floppy/Hard Disk Controller

\$915⁰⁰*
(Shipping \$19.77)

THE™ 286/10 ➔
Model II Base System
1.2MB Floppy Drive
Floppy Hard Disk/Controller
42MB, 28MS Hard Drive

\$1,495⁰⁰*
(Shipping \$32.29)



THE™ 286/10 ➔
Base System
Norton Index SI 10.3

Speed: 6 or 10 Mhz, Keyboard
or Toggle Switch Selectable

Memory: 512K Standard
Expandable up to 1MB
on Motherboard

Phoenix BIOS
84 Key "AT" Keyboard
200 Watt Power Supply
Full Size "AT" Case



\$690⁰⁰*
(Shipping \$16.91)

Hard Disk D

30MB Internal
Hard Disk

\$445⁰⁰*
(Shipping \$9.62)

71MB Internal
Hard Disk, 28MS

\$799⁰⁰*
(Shipping \$17.26)

80MB Internal
Hard Disk, 28MS

\$899⁰⁰*
(Shipping \$19.42)

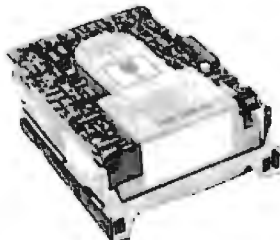

42MB "AT" Hard Drive

\$550⁰⁰*
(Shipping \$11.45)

PRINCETON



\$445⁰⁰*
(Shipping \$9.62)

HX-12
Color RGB

\$369⁰⁰*

MAX-12E
TTL/RGB

\$138⁰⁰*

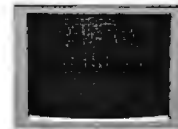

\$489⁰⁰*
(Shipping \$10.76)

12" Amber TTL

\$85⁰⁰*

13" RGB Color

\$275⁰⁰*

14" EGA w/
Tilt Swivel

\$435⁰⁰*



MULTISYNC

13" High Res
(800 x 560), RGB Monitor
w/Cables

\$530⁰⁰*
(Shipping \$11.45)

SEE WHY OVER 250,000 HAVE JOINED, MAKING US THE NATION'S #1 SOURCE FOR EVERYTHING IN COMPUTING

- Wholesale + 8% Pricing
- 10 Day Returns On Hardware
- 400 Page Catalog
- Quarterly Newsletter
- Periodic Catalog Updates
- 24 Hour Bulletin Board w/10,000 Downloadable Shareware Titles
- 1000 + Software Title Rental Library

PC Network

320 West Ohio Street Chicago, IL 60610-9934

(800) 621-SAVE

Validation Code B367

Our knowledgeable sales consultants are on duty:

Mon.-Fri. Sat.
8am-7pm (CST) 9am-5pm

In Illinois Call (312) 280-0002

Customer Service and Order Status (312) 280-1567
Mon.-Fri. 8am-4:30pm

CALL TOLL FREE (800) 621-SAVE

In Illinois Call
(312) 280-0002

YES! Please enroll me as a member in the PC NETWORK™ and send my catalog featuring thousands of computer products, all at just 8% above DEALER WHOLESALER PRICES. I will also receive "THE PRINTOUT", a special periodic update on merchandise at prices BELOW even those in my wholesale catalog and all the other exclusive, money saving services available to Members. I am under no obligation to buy anything. My complete satisfaction guaranteed. Please (✓) all boxes that apply:

•Basic Membership 1 Year 2 Year •Special V.I.P. Membership 1 Year 2 Year
 With 14 Days Rental \$8 \$15 With 30 Days Rental \$15 \$25
 Business Software Rental Library \$25 add'l. per yr. BOTH Business and Game
 Games Software Rental Library \$10 add'l. per yr. Software Rental Libraries \$30 add'l. per year

Bill My Credit Card: VISA MasterCard American Express

Validation # **367**

Account Number:

□□□□□□□□□□□□□□□□ Exp. Date: mon. _____ yr. _____

Check or Money Order Enclosed for \$ _____

Name _____

Address _____ Apt. No. _____

City _____ State _____ Zip _____

Telephone: () _____

My Computer(s) is: IBM IBM XT IBM AT Apple II Macintosh Other _____

Signature _____

(Signature required to validate membership)

Copyright© 1986, PC NETWORK, INC.

RENT BEFORE YOU BUY—Members are eligible to join the NETWORK'S Business and Game Software Rental Libraries and evaluate products for a full 14 Days (Regular Membership) or 30 Days (VIP Membership) to see if they meet their needs. The Network's rental charges are far less than other software rental services—just 20% OF THE MEMBER WHOLESALER PRICE. Rental titles are available in IBM, Apple and Mac.

QNX SPECIALISTS

We provide computer products for the QNX user. All products sold by us have been tested in our offices and will work with QNX in both multi-user and network mode.

All of Quantum's fine products	\$call
----- SOFTWARE -----	
T&T: IS screen/menu development pkg	\$ 295
IS with source	\$ 595
T&T: Teach Authoring & Course Dev	\$ 295
Btree balanced tree file mgr	\$ 250
Sculptor 4gl Database by mpd	\$ 995
ZIM dbm: Ultimate flexibility	\$1195
WPro Word Processing	\$ 149
VAS Spread Sheet	\$ 214
DASNET Wide Area Network nodes	\$ 40
----- HARDWARE -----	
ARCNET bds for QNX network	\$call
Omega Bernoulli Box w/ driver	\$call
QNX terminals: Kintron XT-7 PC	\$ 695
Keynote PC	\$ 750
RS232 multi-port serial boards	\$ 395

Consultants available. Call us.

T&T Ask about our specials!

T&T Computer Products
Post Office Box 33213
Tulsa, Oklahoma 74153
(918) 663-1879
QNX is a registered mark of Quantum

Inquiry 319

Serial ← ||||| → Parallel

NEW!

Convert What You Have To What You Want!

• RS232 Serial	• Centronics Parallel
• 9 Baud Rates	• Handshake Signals
• Latched Outputs	• Compact 3 1/2" x 4 1/2" x 1 1/2"

No longer will your peripheral choices be limited by the type of port you have available! Our new High Performance 700 Series Converters provide the missing link. Based on the latest in CMOS technology, these units feature full baud rate selection to 19.2K, with handshake signals to maximize transfer efficiency. Detailed documentation allows simplified installation. Order the Model 770 (SerPar) or Model 775 (ParSer) Today!

Buyer Products Coming Soon! **INSURANCE** only \$89.95
Connector Option \$12.00
CA Residents 6% tax
UPR Shipping \$3.00

2704-C Johnson Dr.
Post Office Box 3717
Ventura, California 93008

CALL (805) 658-7466 or 658-7467
For FAST Delivery

Inquiry 313

Beat the limits!

Vfeature™
DELUXE

Software for hard disks

- DOS partitions to 1 GIGABYTE
- Spans two drives in one bootable partition
- Supports big drives on AT and XT
- Secures data

GOLDEN BOW SYSTEMS

\$120
\$3 shipping/handling
California orders add 6%

2870 Fifth Avenue
Suite 201
San Diego, CA 92103
619/298-9349

Inquiry 120

Powerful Spreadsheet Meets Full-Featured Word Processor

BOXCALC 1000 is a combination spreadsheet/word processing program that lets you mix figures with text easily in the same document. All on one disk!

Stop fighting fixed rows and columns. **BOXCALC 1000** lets you put text and calculation boxes anywhere you wish.

Simple or complex box formulas with full replication and conditional processing help make your calculations easy, yet powerful. And you get word processing with fast insert-delete, word-wrap, search & replace, block moves, and much more.

For IBM PC/XT/AT or compat. 256K. With detailed manual and easy-start instructions for \$139. Send orders (VISA, MC, Check) or info requests to: Cotton Software, Inc., 2325 Anderson Rd., Suite 364, Covington, Ky. 41017. Or call (506) 727-1600.

Inquiry 76

Sure it's insured?

SAFWARE® Insurance provides full replacement of hardware, media and purchased software. As little as \$39/yr. covers:

- Fire • Theft • Power Surges
- Earthquake • Water Damage • Auto Accident

For information or immediate coverage call:
1-800-848-3469
In Ohio call 1-614-262-0559

SAFWARE

SAFWARE, The Insurance Agency Inc.

Inquiry 272

PC/XT USERS!

- COGTREE Utilities by Cogitate \$129.95
- LYNC by Norton-Lamber... \$199.95
- DATAFLEX by Data Access... Varies
- RMICOBOL by Ryan/McFarland Varies
- Universe by Omnitrend... \$ 98.50
- Blue MacI by Cogitate... \$599.00
- CadPower+ by Trilex... \$995.00
- Softext Teaching Aids... \$ 95.00
- PrintSet by Cogitate... \$ 79.95
- CogITAPE by Cogitate... CALL!!
- Anti-Static Products... Varies
- Uninterruptible Power Backups... Varies
- TeleVideo Software... CALL!!

COGITATE

"A Higher Form of Software"
24000 Telegraph Road
Southfield, MI 48034
(313) 352-2345/Telex 386581

VISA/MASTERCARD ACCEPTED
Dealer Inquiries Welcomed

Inquiry 55

SAVE TIME
with
FORMATTED DISKS
"Ready to use in your IBM PC or compatible."

Nashua
48c
3M
each
qty 100

ALF formats brand-name factory certified disks, and double-checks them for defects. You save the time and hassle of formatting disks yourself, and pay no more than for ordinary blank disks!

CALL TODAY TOLL-FREE
1-800-321-4668
in Colorado, 303-234-0871

ALF 1315-F Nelson St. Denver, CO 80215

Inquiry 12

NEW LOWER PRICES

SIBEC II

- 8052AH BASIC V1.1 CPU
- iSBX* expansion connectors
- Prototyping area
- Five 8 bit input/output ports
- PROM programmer
- Expansion connectors

CALL TODAY 603/469-3232
\$228 (100+ \$159)

Binary Technology, Inc.
MAIN ST. • P.O. BOX 67 • MERIDEN, NH 03770
603/469-3232

*iSBX is a trademark of the Intel Corporation

Inquiry 272

Addmaster Specialty Printer
Forty-Column Alphanumeric Printer
ideal for applications such as security systems, fire alarm systems, point-of-sale, data logging and others.

- RS232 interface.
- Prints 40 characters alphanumeric.
- 5 x 7 Dot-Matrix.
- Compact 10-1/2" x 10" footprint.
- 120 VAC 60 Hz.
- Single or Two-ply 3875 in paper.
- Validation slot for multi-part forms.
- 80 cps speed (2 lps).
- 8K buffer (additional RAM optional).

ADDMASTER CORPORATION
2000 S. MYRTLE, MONROVIA, CA 91016-7116
(818) 358-2395 TELEX 674770

Inquiry 5

Compu\$ave

Call Toll Free: 1-800-624-8949

BOARDS

ATI EGA Wonder . . . 252	NEC GB-1 . . . 325
AST Rampage 286 . . . 425	Paradise 480 . . . 369
Chauffeur HT . . . 185	Taxan Gold . . . 299
Genoa Super EGA . . . 295	Video 7 EGA . . . 189
Orchid Jet 386 . . . 869	Vega Deluxe . . . 319
Quadram Quadlink . . . 323	Vermont 8820 . . . 1292
Alloy Or Advanced Digital Slave Boards . . .	SAVE
Artist t 1024 × 768 (Interlaced) . . .	1395
ATI Graphics Solution . . .	172
Tal/tree J Laser Plus AT . . .	439
Tecmar EGA Master 800 . . .	395
Aristocad/Hercules/Number 9/Persyst . . .	CALL
Sigma/STB/Tseng/Verticom/Vutek . . .	CALL

MONITORS

Amdek 1280W/Card . . . 689	Amdek 410 . . . 152
Mitsubishi 6922 . . . 2125	Aydn 8856P . . . 2895
NEC Multisynch . . . 542	IC 19" EGA . . . 1399
Taxan Multivision . . . 545	Taxan 840 . . . 815
Thomson 450A . . . 165	PGS LM300 . . . 495
Wyse 700W/Card . . . 699	Zenith 1220 . . . 99
Micro Vitek Auto-Synch:19" . . .	1695
Sigma Laserview 15"/1200 × 1664 . . .	1395
Casper/Hitachi/Magnavox/Sperry/Teeco . . .	CALL

IMAGE SCANNERS

AST/Scan Turbo (Macintosh) . . .	1745
Datacopy Model 730 . . .	1395
PGS LS-300 With PC Paint & Adapter . . .	729
PGS LS-300 With OCR Soft. & Adapter . . .	995

COMPUTERS

AT&T 6300/1 Dr . . . 1245	AST Model 80 . . . 1535
Sharp PC7000A . . . 1249	AST Model 90 . . . 1919
Sharp PC7100 . . . 1899	AST Model 120 . . . 2289
Zenith 181 . . . CALL	AST Model 140 . . . 2675
Cordata AT: Portable & Disc / 20M Drive . . .	2195
Cordata CS4200: 640K/1 Drive . . .	1329
Packard Bell AT: 640K/30M Drive . . .	1945
Packard Bell AT: 640K/44M Drive . . .	2125
Panasonic Business Partner: 2 Drives . . .	845
Panasonic Business Partner: 20M Drive . . .	1139
Panasonic Bus. Partner 286: 30M Drive . . .	2039
Sperry IT: 1M/44M Drive . . .	2799
Toshiba 1100 + & 3100 Portables . . .	SAVE
Wyse 286: 6&10 MHz/1.2M Drive . . .	1495
Wyse 286: 6&10 MHz/20M Drive . . .	1895
Wyse 286: 6&10 MHz/30M Drive . . .	2195
Wyse 286: 6&10 MHz/40M Drive . . .	2395
Wyse + Turbo: 640K/2 Drives . . .	1019
Wyse + Turbo: 640K/20M Drive . . .	1465
Altos/Corvus/ATT/NEC/Televideo/Others . . .	CALL

TERMINALS

Adds 3220 . . . 479	Altos III . . . 559
Freedom I Turbo . . . 429	Ampex 220 . . . 399
IBM 3164 Color . . . 895	Wyse 30 . . . 285
Kimtron K17 . . . 412	Wyse 50 . . . 359
Televideo 905 . . . 285	Wyse 60 . . . 405
Televideo 955 . . . 395	Wyse 85G . . . 425
Hazeltine/Liberty/Link/Quame/Zenith . . .	CALL

PLOTTERS

Houston 51/52MP . . . 3765	Houston 41/42 . . . 2345
Houston PC595 . . . 499	Houston 51/52 . . . 3345
Houston PC695 . . . 585	Houston 56A . . . 4195
Calcomp 1041GT . . . 5295	Roland 885 . . . 1195
Cal. Plotmaster . . . 4145	Roland 880 . . . 879
Enter SP1000 . . . 3095	Roland 980 . . . 1159
Ioline 4000 . . . 4245	Roland 990 . . . 1625
Gould/Hewlett-Packard/Numonics . . .	CALL

DIGITIZERS

Calcomp 44 × 60 . . . 4995	GTCO: All . . . CALL
Hitachi 11 × 11 . . . 575	Kurta Penmouse . . . 185
Hitachi 15 × 15 . . . 1195	Kurta 8.5 × 11 . . . 299
Houston TG1011 . . . 499	Kurta 12 × 17 . . . 699
Houston TG1017 . . . 599	Kurta IS . . . CALL
Houston TG8036 . . . 2895	Summa 12 × 12 . . . 375
MS BUS Mouse . . . 109	Summa 12 × 18 . . . 659
Summa Mouse . . . 79	Numonics 36 x48 3149
Many Other Models And Mice . . .	CALL

MODEMS

Prometheus 2400G . . . 249	Hayes 1200 . . . 348
Ven-Tel 2400i . . . 295	Hayes 1200B . . . 309
Ven-Tel 2400 + . . . 372	Hayes 2400 . . . 559
Zoom 1200XL . . . 225	Hayes 2400B . . . 479
Anchor Volksmodem 12/ External & PC . . .	99
Anchor Lighting 2400/ External . . .	295
Mignet Pocket Modem: 1200 (#1 Rated) . . .	149
Prentice PopCom 150: 1200 (#1 Rated) . . .	CALL
Racal Vadic 2400-VP: (#1 Rated) . . .	398
Codex/Novation Rixon/UDS/Other Models . . .	CALL

PRINTERS

Alps ALQ-224 . . . 495	Alps ALQ-324 . . . 699
Citizen Premier 35 . . . 442	Citizen 120D . . . 168
Citizen MSP15 . . . 355	Citizen MSP20 . . . 305
Citizen MSP25 . . . 455	Diconix 150 . . . 309
Citizen Tribute . . . 639	Fujitsu 2400 . . . 819
Panasonic 1080i . . . 188	NEC P660 . . . 425
Panasonic 1091i . . . 244	NEC CP660 . . . 525
Panasonic 1092i . . . 318	NEC P760 . . . 595
Panasonic 1592 . . . 384	NEC CP760 . . . 689
Panasonic 1595 . . . 462	NEC P9XL . . . 1195
Toshiba 321 SL . . . 529	Okidata: All . . . CALL
Data So./Diablo/Juki/Star/Televideo/TI . . .	CALL
Buffers/Cables/Sheet Feeders . . .	LOW PRICES
Stands/Switch Boxes/Tractors . . .	LOW PRICES

LASER PRINTER HEADQUARTERS

Data Prod 1230 . . . 2599	AST Turbo . . . 3295
Genicom 5010 . . . 2365	Canon LBP-A1 . . . 1795
Oki. Laserline 6 . . . 1425	CIE LIPS-10 . . . 2345
TI Omni 2115 . . . 5895	NCR Laser . . . 1925
Toshiba Page 12 . . . 2495	Qume Laser . . . 2195

DISK DRIVES

Mountain 30M Card . . . 599	Apple Drives . . . 112
Priam 130M Drive . . . 2095	Miniscribe 40M . . . 589
Seagate 20M Kit . . . 325	Miniscribe 80M . . . 889
Seagate 30M Kit . . . 382	Seagate 4038 . . . 545
Toshiba 3.5" Kit . . . 115	Seagate 4096 . . . 945
Plus Development Harcard 20 . . .	599
Alloy/I OMEGA/Irwin/Maxtor/Maynard . . .	CALL
Rodime/Sysgen/Talgrass/Teac/Techna . . .	CALL

**HOURS: MON-FRI 7AM-6PM/SAT 9AM-2PM
IN ARIZONA CALL (602) 437-4855**

CompuSave: 4207 S. 37th St., Phoenix, AZ 85040 Prices Reflect Cash Discounts And Are Subject To Change Without Notice. Major Credit Cards And Selected PO's Are Accepted. We Cannot Guarantee Compatibility. CompuSave Is A Division Of Adlanko Corporation.

THE UNBEATABLE PRICES!

2 SPEEDS TURBO SYSTEM FULLY IBM PC/XT COMPATIBLE 4.77/8MHZ



- 640K on Board RAM
- 2 Floppy Disk Drives
- Disk Controller Card
- 150W Power Supply
- FCC Type Slide Case
- 'AT' Style Keyboard
- 8 IBM I/O Slots
- 8088-2 Micro Processor
- 8087 Co-Processor Socket
- 4.77 MHZ/8MHZ Clock Selectable
- Monitor and Display Card Not Included

Fully Assembled and Tested **\$499⁰⁰**
(Other Options and Configurations Available, Please Call.)

PINECOM AT SYSTEM 30 M. HARD DISK WITH MONITOR



- 6/10 MHZ Clock Selectable
- 80286 CPU
- 1. D.S.D.D. Floppy Drive
- 200 Watts Power Supply
- Hard Disk/Floppy Disk Controller
- 512K RAM Expandable to 1 MGB
- Clock Calendar w/Battery Backup
- 'AT' Style Keyboard
- 30 M. Hard Disk w/Controller
- Monochrome Graphic Card
- Parallel Printer Port
- Monochrome Amber Monitor

Fully Assembled and Tested **\$1399⁰⁰**



pinecom™

SPECIAL SALE ITEMS

20M Hard Disk (ST-225) with controller	\$380 ⁰⁰
30M Hard Disk (ST 4038) For AT	\$590 ⁰⁰
Internal modem 300/1200 BPS Hays compatible	\$115 ⁰⁰
External modem 300/1200 BPS Hays compatible	\$115 ⁰⁰
EGA color card support EGA, MGA, CGA	\$230 ⁰⁰
EGA color card TAXAN 560 (Paradise)	\$265 ⁰⁰
EGA color monitor TAXAN 760 14"	\$495 ⁰⁰
Color Graphic Adapter with printer port	\$65 ⁰⁰
Monochrome Graphic Card with printer port	\$65 ⁰⁰
Logitech Mouse C7 Plus with software	\$75 ⁰⁰
Copy II PC option Board (Copy Card)	\$95 ⁰⁰
4 serial ports for XT (all selectable)	\$92 ⁰⁰
4 serial ports for AT (all selectable)	\$135 ⁰⁰
IMAGE ACE II Video Capture Card	\$250 ⁰⁰
2M multifunction card for AT	\$150 ⁰⁰
2 MGB RAM expansion card for XT (OK)	\$147 ⁰⁰
SAMSUNG 12" Amber monochrome TTL monitor	\$85 ⁰⁰
SAMSUNG 12" Green monochrome TTL monitor	\$85 ⁰⁰
TTX 14" RGB Color monitor (1410)	\$300 ⁰⁰
1.2 M Floppy disk controller for XT/AT	\$50 ⁰⁰
Joystick with 3 buttons for IBM	\$180 ⁰⁰
Game port card (for 2 joysticks)	\$180 ⁰⁰
Surge protected power strip (6 outlets)	\$180 ⁰⁰
Eprom writer card with software	\$110 ⁰⁰
BTC 5339 Enhanced keyboard XT/AT 12F.key	\$78 ⁰⁰
IBM logo Floppy disk drive 360K half height	\$65 ⁰⁰
Citizen printer 120D 80 col. 120 cps. NLO	\$199 ⁰⁰
Citizen daisywheel printer PERMIERE 35	\$460 ⁰⁰
COSMO World 2600 daisywheel printer 26 cps	\$230 ⁰⁰

Inquiry 240

Send One Dollar For Our New Catalog

PINE COMPUTER INC.
9690 Telstar Ave., Suite 204
El Monte, CA 91731

Phone: (818) 575-1882
Telex: 5106017376 PINECOM
Business Hours 9 - 6, Mon. - Sat.

Computer Valley

1290 Oakmead Parkway • Suite 111 • Sunnyvale, California 94086
800-225-8216 (ORDERS ONLY) 408-739-3400 (CA Residents-Information)

MANAGED BY ENGINEERS FROM SILICON VALLEY

PACT-386-16 (16 mhz 80386 cpu pc)
 IDEAL FOR CAD/CAE/CAM/CAT Workstations

- Standard 2 MB Memory Expandable to 16 MB
- On Board 2 Serial 1 Parallel Ports
- Supports RAM-BIOS
- On Board Socket for 80287
- Zero Wait State Optional
- Two 32 Bit, Four 16 Bit, Two 8 Bit Bus
- 101 Keys Enhanced Keyboard
- FORTRON® 230 Watt Power Supply UL/CSA Listed
- 5 Drives Capacity Heavy Duty Cabinet
- 1.2 MB TEAC Floppy Drive
- Western Digital Controller
- 40 MB High Speed Hard Drive
- DOS 3.2/GW Basic

\$3,950

PACT-286-8
 (8 mhz Zero Wait State)

\$1,125

- IBM AT Compatible
- 6/8 mhz 0 Wait State, Norton S/I 9.2
- 512K Installed, Expandable to 1 MB On Board Memory
- 1.2 MB Floppy Drive
- Floppy and Hard Disk Drives Controller
- 230 Watt (max.) UL/CSA Listed Power Supply
- Maxi Switch Keyboard
- Optional 2 Serial and 1 Parallel Port
- DOS 3.2 GW Basic
- Clock/Calendar with Battery Back Up
- Optional Math Co-Processor 80287-8
- Optional 5 Half-Height Drives Capacity Chassis
- One Year Warranty



PACT-286-10
 (10 mhz One Wait State)

\$1,195

*Same features as PACT-286-8 with 10 mhz clock speed, with 640K memory installed.

PACT-286-12

\$1,650

- IBM PC AT Compatible
- 6/12 mhz Dual Clock Speed
- 640K Expandable to 1 MB On Board Memory
- 1.2 MB Floppy Drive
- Floppy/Hard Disk Drive Controller
- Maxi-Switch AT Keyboard
- 230 W (max.) UL/CSA Listed Power Supply
- DOS 3.2, GW Basic
- One Year Warranty

UPGRADE OPTIONS

(Discount Price for the Purchase With System Only)

- Hercules® compatible monographic card w/printer port . . . \$ 65.00
- Monochrome monitor . . . \$ 85.00
- 20MB hard disk drive kit . . . \$359.00
- 360K floppy drive . . . \$ 85.00
- XT serial/parallel/clock/game port (for PC XT only) . . . \$ 55.00
- 8087-2 (8 mhz) . . . \$159.00
- 80287-8 . . . \$235.00
- 80287-10 . . . \$295.00
- 20MB hard disk drive only . . . \$295.00
- 30MB hard disk drive only . . . \$585.00
- 20MB tape back-up kit (teal) . . . \$495.00
- EGA card & EGA monitor . . . \$590.00
- Enhanced keyboard . . . \$ 75.00

BEST SELLING PC ADD-ON'S AND PERIPHERALS

VIDEO ADAPTORS

- Monographics, Hercules Compatible . . . \$ 79.00
- Colorgraphics Adaptor . . . \$ 79.00
- EGA Card, IBM Compatible . . . \$ 199.00
- HEGA Card, IBM, Hercules Compatible . . . \$ 219.00

MULTIFUNCTION MEMORY EXPANSION BOARD (OK Installed)

- 640K Memory Exp. Card (XT) . . . \$ 59.00
- 2MB Memory Exp. Card (XT, EMS) . . . \$ 129.00
- 640K Multifunction Card (XT) . . . \$ 129.00
- 3MB Memory Exp. Card (AT) . . . \$ 155.00
- 2 MB Multifunction Card (AT) . . . \$ 175.00

I/O BOARD

- XT - I/O w/Floppy Controller . . . \$ 95.00
- AT - I/O w/Floppy Controller . . . \$ 95.00

PRINTERS

- PANASONIC DOT MATRIX
- KX-P10801 120 cps, NLQ . . . \$ 209.00
 - KX-10911 180 cps, 32 cps NLQ . . . \$ 269.00
 - KX-1092 180 cps/33 cps NLQ . . . \$ 345.00
 - KX-1595 240 cps/51 cps NLQ . . . \$ 449.00
 - KX-1595 240 cps/51 cps NLQ . . . \$ 559.00
 - KX-P3131 17 cps Daisywheel . . . \$ 295.00
 - KX-P3151 22 cps LQ Parallel Printer . . . \$ 449.00
- C. ITOH
- Riteman Blue Plus, 140 cps . . . \$ 179.00
 - Riteman 15, 160 cps, 15" Wide Carriage . . . \$ 419.00
 - TTX PRESS 80, Thermo Printer . . . \$ 89.00

MONITORS

- MONOCHROME, TTL
- Casper w/Swivel Base, Amber . . . \$ 99.00
 - Tatung . . . \$ 129.00
 - Samsung Amber . . . \$ 99.00
- COLOR, RGB
- Tatung-1360f . . . \$ 335.00
 - Bright! . . . \$ 319.00
- EGA
- Tatung-1380F . . . \$ 449.00
 - Casper . . . \$ 429.00
 - Taram - S.V. 76 . . . \$ 469.00
 - NEC Multisync . . . \$ 619.00

DISK DRIVES

- FLOPPY DRIVES
- Teac FD-55BV, 360K Floppy . . . \$ 92.00
 - Teac FD-55GFV, 1.2MB Flopp: . . . \$ 129.00
 - Chino 1.2MB Floppy . . . \$ 119.00
- HARD DRIVE, SEAGATE
- ST-225 w/controller & . . . \$ 369.00
 - ST-4026 Drive Only . . . \$ 519.00
 - ST-4038 Drive Only . . . \$ 619.00
 - ST-4051 Drive Only . . . \$ 699.00
 - ST-4096 Drive Only . . . \$1,290.00

TAPE BACK-UP DRIVE

- Teac 20MB Internal . . . \$ 499.00
- Teac 20MB External . . . \$ 599.00
- Teac 45MB Internal . . . \$ 629.00
- Teac 45MB External . . . \$ 739.00

MODEMS

- 1200 Baud Internal . . . \$ 109.00
- 2400 Baud Internal . . . \$ 239.00
- 1200 Baud External . . . \$ 149.00
- 2400 Baud External . . . \$ 349.00

DOS 3.20 W/G. W. BASIC . . . \$ 85.00

MATH CO-PROCESSOR

- 8087 (5 mhz) . . . \$ 105.00
- 8087-2 (8 mhz) . . . \$ 152.00
- 80287-6 (6 mhz) . . . \$ 174.00
- 80287-R (8 mhz) . . . \$ 245.00
- . . . \$ 295.00

- Prices subject to change without notice.
- Hercules is a trademark of Hercules Computer Technology.
- IBM XT, AT is a trademark of International Business Machines.

TERMS:

- Shipping and handling charge starting from minimum \$6.00 each shipment.
- 15% restocking charge is required for non-authorized return merchandise.

TIMELINE INC.

20 MILLION I.C.'S IN STOCK!
Minimum I.C. Order: \$200.00

Continental U.S.A (800) 872-8878	Order Desk (800) 223-9977	Inside California (213) 217-8912	L.A. & Technical Info (213) 217-8912	OEM INQUIRIES WELCOME
--	-------------------------------------	--	--	------------------------------

EGA PACKAGE

INCLUDES: EGA CARD, MONITOR, SOFTWARE & CABLES

FEATURES:

RESOLUTION
CGA: 640x400
EGA: 640x400
PGA: 640x480
COLOR

ALSO:

\$699.00
MONITOR
Hercules: 720x350 13" Viewing Area
Autoswitch Matrix pitch: 0.31mm
Parallel Printer Port Addressability: 640x480

(Varies with Software package. Maximum is EGA Colors or 16 out of 64)

PGA Monitor
Alone: \$450.00

Multitech 504 CP/M SYSTEM

Includes: (2) 96tpi DRIVES 780A MICROPROCESSOR
Ports: Centronics parallel, Two serial Single board, 64K
Just add a Terminal!
Comes with all software & manuals: Magic Worksheet, Word Right, Analyst NAD (Name and Address System) Q30RT
\$199.00
Unit Without Software: \$150.00



THEY'RE BACK!
But only 30 are left. Act now, they'll go fast!

QUME IBM COMPATIBLE FLOPPY DRIVE

QUME TRACK 142

-DS/DD BELT DRIVE
-360K
-5 1/2" 1/2 HEIGHT



\$65.00

12" COMPOSITE MONITORS

Amber, Green and B&W
Reconditioned and fully Tested. **\$49.95**

TANDON TM55-4 96tpi DS/DD 5 1/4" Floppy Drive: \$69.00

FULL HEIGHT WANGTEK Model 5099EG24 60 Mb Tape Backup: \$249.00

ASTEC 65 WATT SWITCHING POWER SUPPLY: \$29.00

LASERS

0.5mW to 10mW - Power supplies available
Please call for information.



1490 W. ARTESIA BLVD., GARDENA, CA. 90247
Continental U.S.A. Inside California L.A. Area & Technical Info
(800) 872-8878 (800) 223-9977 (213) 217-8912
Prices subject to change without notice.
FOREIGN ORDERS REQUIRE SPECIAL HANDLING
15% Restocking fee for returned orders



Minimum Order: \$25.00. Shipping & handling charges via UPS Ground: \$.50c/lb. UPS Air: \$1.00/lb. Minimum Charge: \$4.00. We accept cashiers checks, MC or VISA. No personal check COD's. Items reflect 5% cash or check discount. California residents add 6 1/2% sales tax. We are not responsible for typographical errors. All merchandise subject to prior sale. Phone orders welcome.

JOIN PC CLUB AND SAVE

Become a member of PC CLUB and buy quality products at incredibly low prices! These are not closeouts, not liquidations, not discontinued items, but state-of-the-art computer products custom designed for PC CLUB. Join now and take advantage of our summer special. Membership is free with any purchase in the month of June. Regular membership is \$10. per year.



PC FAX

Image Communications System. Converts PC into FAX machine. Converts ASCII or graphics files and transmits to any G3 FAX machine in the world at 9600 baud. Receives FAX and converts to ASCII.

\$995

1200 bps



MODEMS

Hayes compatible external. Fully featured. Auto answer, auto dial with call progress detection. RS232C interface.

\$99

2400 bps



PGA GRAPHICS

Half card. Fast, advanced, high resolution. PGA, EGA, CGA, MDA, & Hercules compatible. Clock speed up to 16MHZ. Supports Multisync, Multiscan, Multimode monitors.

\$199

\$299



DATA SELECTORS

	Serial - RS 232C	Parallel - Centronics
2-WAY\$23.99	2-WAY\$24.99
3-WAY\$27.99	3-WAY\$29.99
4-WAY\$31.99	4-WAY\$34.99



CABLES

Serial - RS 232C **\$6.99** Parallel - Centronics **\$7.99**



"Call Me!"
TOLL FREE
(800) PC CLUBS
(800) 722-5827

Terms: Shipping and Handling: add \$5.00 (UPS ground). Minimum Order: \$20.00. C.O.D. Orders: add \$3.00 (cashier's check or money order only). Pre-Pay Personal Checks: allow 2 weeks to clear. CA Residents: add 6.5% sales tax. 15 Day Money Back Guarantee. Prices subject to change.



19201 - D Parthenia Street, Northridge, California 91324

For Information Call **(818) 993-0754**

All products listed are respective of their trademarks.

Major Credit Cards Accepted

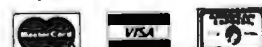

A 68000 PERSONAL COMPUTER FOR ONLY \$199⁰⁰



The Sinclair QL includes Word Processing, Database, Spreadsheet, Business Graphics and Incredible Color Graphics built in. Also built in QDos and Super Basic.

QL, software, monochrome monitor **\$249⁰⁰**
 QL, software, RGB color monitor **\$399⁰⁰**
 NLQ serial printer **\$249⁰⁰**
 Plus shipping & handling

- 128K RAM Expandable to 640K to meet most personal computing needs.
- Two built in microdrives
- Two RS232 serial ports, two joystick ports, TV and RGB outputs.
- Four blank microdrive cartridges with up to 100K storage each—included.
- An easy-to-use full size keyboard.
- The advanced 68008 microprocessor for multiple, simultaneous screen display and running of multiple programs at the same time.

Price and availability subject to change

603-357-1800

A⁺ Computer Response
 69B Island St.
 Keene, NH 03431
 Telex 2946407 Via MCI/WUI

UNIVERSAL EPROM PROGRAMMER KIT FROM \$95!!

- * On board power supply, 110/220 VAC;
- * Menu selection; No personality modules;
- * Built in monitor for easy I/O debugging;
- * User friendly softw; Full tech. support
- * Detailed 50 page manual with schematics;
- * Quick pulse algorithm: 27256 under 60 sec
- * All 24/28 pins to 27011 & CMOS E(E)PROMS
- * Micros: 8741, 2, 8748, 48H, 49, 49H & CMOS
- * Auto baud RS232 to 19.2k; Free PC drivers
- * Offset/split Hex, Binary, Intel & Motorola 8, 16 & 32 bit files; Cased unit \$495!

B&C Microsystems
 355 W. Olive Ave., Ste. 103, Sunnyvale, CA 94086
 * Ph 408-730-5511; 800-642-7617 Visa & MC

Inquiry 44

PRINTER STANDS AND TRAYS

- Efficiency in feeding paper forms
- Greater air-circulation
- Fits all popular 80/132 column printers
- Stock immediately available

Grand Union
 Micro Systems
 P.O. Box 1880
 Fallbrook, CA 92028
 (619) 723-0882 • 800-344-6934

Inquiry 123

AMT
APPLIED MICRO TECHNOLOGY
 IMPORTER - EXPORTER
 P.O. BOX 24783, LOS ANGELES, CA 90024
 800 458-0070 (NA)/213 474-0070 (CA)
 TLX: 263220 AMT UR

OMEGA
 BERNOULLI TECHNOLOGY

20+20 **\$1895**
 Single 20 **\$1334**
 10+10 **\$1569**
 Single 10 **\$995**
 Tri-pac 10/20 **169/184**
 Interface pc2/pc2B **\$149/195**

FREE CARTRIDGE PER SYSTEM

IBM COMPAG
 All electronic components and computer parts. International orders welcome.

Inquiry 363

UPS - DEPOT

WE SPECIALIZE IN PRODUCTS THAT CORRECT AC POWER PROBLEMS SUCH AS HIGH VOLTAGE, LOW VOLTAGE, CITAL POWER FAILURE, LINE NOISE, LINE TRANSIENTS OR ANY COMBINATION OF THE ABOVE. WE DISTRIBUTE UPS-TECH, MINUTEMAN, EMERSON AND RITE DELTEC PRODUCTS, AMONG OTHERS

STAND-BY POWER SYSTEMS
 FROM 200 VA TO 2 KVA
UNINTERRUPTABLE POWER SYSTEMS
 FROM 1 KVA TO 45 KVA
AC LINE CONDITIONERS
 FROM 500 VA TO 3 KVA
SURGE PROTECTORS WITH EMI/RFI FILTER
 4 OUTLETS AND 6 OUTLETS

"COMPARE THESE INTRODUCTORY PRICES"

- UPS-TECH STAND-BY 500 VA \$ 499 00
- UPS-TECH CONTINUOUS TYPE UPS 1 KVA \$1,499 00
- UPS-TECH VOLTAGE REGULATOR 500 VA \$ 379 00
- SURGE PROTECTOR WITH EMI/RFI FILTER 6 OUTLETS \$ 35 00

DEALER INQUIRIES WELCOMED
 * EXPORT PRICES

CASH PRICES INDICATED. ALL ITEMS CARRY MANUFACTURERS GUARANTEE. SHIPPING AND HANDLING CHARGES ARE SEPARATE. FLORIDA RESIDENTS ADD 5% SALES TAX. PRICES SUBJECT TO CHANGE W/O NOTICE.

UPS-DEPOT 1-800-648-2334/(305) 591-2640
 FAX (305) 386-6859 • TELEX 910 240 1044
 8725 N W 18 TERR, SUITE 100, MIAMI FL 33172
 ALL TRADEMARKS ARE REGISTERED WITH THEIR RESPECTIVE COMPANIES

Inquiry 8

8051 PASCAL

- MS-DOS Cross Compiler
- Generates ROMable HEX files
- Separate Compilation Includes Linker
- Two Memory Models
 On Chip RAM
 External RAM
- Access to BITS, PORTs, SFRs
- Interrupt Routines
- Compact Run Time Package
 Source Included
- Assembler Compatible
- Only \$395 Complete

SCIENTIFIC ENGINEERING LABORATORIES
 104 Charles Street, Suite 143
 Boston, MA 02114 Tel 617 262 3903

Inquiry 276

ROSE DATA SWITCHES

SHARE computers, printers, any parallel or serial device. ELIMINATE cable swapping. INEXPENSIVE way to network. COMPATIBLE with all computers.

Businesses, Schools, Homes

WE ALSO OFFER:
 Data Buffers, Line Drivers, Modems, Protocol Converters, Parallel - Serial Converters, Cables, Computers, Printers, Disk Drives, and more.

AUTOMATIC - CARETAKER is ideal for a business or school to share a printer or modem among many computers. Operation is fully automatic with no software required.
 Parallel or Serial 4 channels - \$295 8 channels - \$395

MANUAL - HARDSWITCH is operated with the flip of a switch. 2:2 and 2:4 models allow simultaneous communication.
 Serial 1:2 - \$59 1:4 - \$ 99 2:2 - \$109 2:4 - \$169
 Parallel 1:2 - \$79 1:4 - \$139 2:2 - \$119 2:4 - \$199
 LED and spike protection on serial models add \$20.

CODE ACTIVATED - PORTER connects one computer to multiple peripherals. A software code selects the peripheral.
 Parallel or Serial 4 channels - \$295 8 channels - \$395
 Buffer option 64K - \$100 256K - \$250

REMOTE - TELEPATH connects multiple computers to multiple peripherals. A selector at each computer or terminal chooses up to 4 peripherals and displays busy status.
 4:4 - \$495 4:8 - \$795 selector - \$39.

Give a Rose to your computer

ROSE ELECTRONICS (713) 933-7673
 P.O. BOX 742571
 HOUSTON, TX 77274
 MCI & VISA Accepted. Dealer inquiries invited.
CALL US FOR ALL YOUR INTERFACE NEEDS

Inquiry 278

PC-XT COMPATIBLE

AT COMPATIBLE

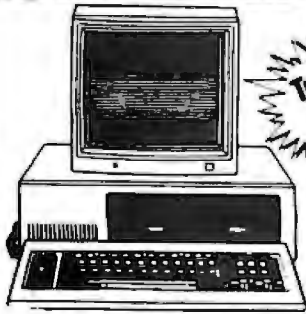

- CAT[™] 640
BASE SYSTEM**
256K (Optional 640K)
- 150 watt pwr. supply
 - AT Style Keyboard
 - 4.77 or 8MHz Keyboard Selectable
 - Floppy Disk Controller
 - 360K 1/2 HT Drive
 - 8087 Socket

\$39800

The CAT[™] 640 is compatible with all software written for the IBM[™] PC. It also runs your software twice as fast as the IBM[™] PC. It runs at 8 megahertz clock rate. More power for expansion. The 150 w. power supply has 8 expansion slots. The keyboard is an 'AT' style standard.

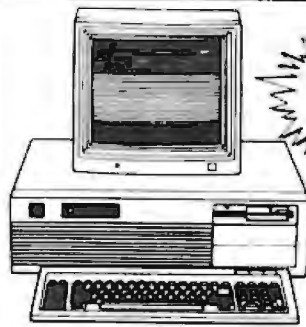

- CAT[™] 286
BASE SYSTEM**
512K Ram (1024K Optional)
- 200 watt Pwr. Supply
 - AT Style Keyboard
 - 6 or 10MHz Keyboard Selectable
 - Clock Calender
 - 1.2 Meg Floppy Drive
 - Western Digital Harddrive/Floppy Controller

\$97600

THE CAT[™] 286 is a 'AT' compatible system, running all software written for the IBM[™] AT. The CAT[™]286 runs at an impressive but not expensive 10MHz.

OPTION A
Base System plus:
Monochrome
Graphics Card
Monochrome
Graphics Monitor
Parallel Port
\$54700

OPTION B
Base System plus:
Color Graphics Card
Color RGB Monitor
Parallel Port
\$73800

OPTION C
Base System plus:
Mono. Graph. Card
Monochrome
Graphics Monitor
Parallel Port
20 Meg Hard Drive
\$87900

OPTION A
1.2 Meg Floppy
Mono. Graphics.
Card & Monitor
Parallel Port
All Harddrives 33Mil.Sec.
30Meg 40Meg
159900 179900

OPTION B
1.2 Meg Floppy:
Color Graphics
Card & Monitor
Parallel Port
All Harddrives 33Mil.Sec.
30Meg 40Meg
178700 198700

OPTION C
1.2 Meg Floppy:
EGA Interface Card
EGA Hi Res Monitor
Parallel Port
All Harddrives 33Mil.Sec.
30Meg 40Meg
204300 224300

ALL CAT[™] SYSTEMS COME WITH A 15 DAY MONEY BACK GUARANTEE (Less Shipping Charges)
ALL CAT[™] SYSTEMS COME WITH 1 YEAR WARRANTY, PARTS & LABOR
ALL CAT[™] SYSTEMS ARE FCC CLASS B APPROVED

SPRING CLEARANCE SALE

Seagate
HARDDRIVES
ST 225 w/cont 20 Meg . . . **328⁰⁰**
ST 238 w/cont 30Meg . . . **388⁰⁰**
ST 251 1/2HT 40 Mil Sec. 40Meg. **578⁰⁰**
1 Yr Warranty
479⁰⁰

**ATASI 40MEG
HARDDRIVE**
• Model 3046
• 30 MS
• 1 Yr Warranty
Qty 1 **479⁰⁰**
Qty 3 **459⁰⁰**
Qty 5 **449⁰⁰**

**Tandon 10MEG
HARDDRIVE**
1/2 HT
• w/controller cables
• 1 Yr Warranty
\$21900

**IRWIN
TAPE BACKUPS**
10Meg Internal **268⁰⁰**
20Meg Internal **378⁰⁰**
40 Meg Internal **478⁰⁰**
All come with
Software & 1 Cassette

intel
CO PROCESSORS
8087-3 5MHz **99⁰⁰**
8087-2 8MHz **148⁰⁰**
80287-6 6MHz **178⁰⁰**
80287-8 8MHz **248⁰⁰**
80287-10 10MHz **288⁰⁰**

**6 Month
Warranty**
**MEAD
Products
MONITORS**
12" TTL Amber Hires 720X368 **79⁰⁰**
14" RGB Color Med res 640X200 **258⁰⁰**
13" EGA 640X350 **368⁰⁰**
All monitors come with Tilt/Swivel Base

EPSON
Lx86 Ex1000
Fx86E LQ800
Fx286E LQ1000
Call for Pricing

**MiniScribe
HARDDISK**
• 28 MS
• 6 Month Warranty
40 Meg 71 Meg
619⁰⁰ 845⁰⁰

MS DOS
2.1 w/G-W Basic **47⁰⁰**
3.1 w/manuals **34⁰⁰**
3.2 w/G-W Basic **77⁰⁰**

**SEVEREX™
MODEMS**
1200 Baud Internal **98⁰⁰**
1200 Baud External **98⁰⁰**
Made by Franklin
All come w/software and are
Hayes Compatible

**AMDEK
MONITORS**
• 410A
• Green - Amber or White
\$15900

MEMORY CHIPS
64K 15ONS Set of 9 **\$15⁰⁰**
256K 15ONS Set of 9 **26⁰⁰**

We also have available: AMDEK IBM ATi brother (PC COMPATIBLE ACCESSORIES) Hayes HERCULES EMMI Microsoft MITSUBISHI ELECTRONICS NEC Panasonic TRINITY RODIME Shugart star TAXAN WESTERN DIGITAL

800-654-7762
SALES
7AM—6PM PST
702-294-0204
Customer Service • Order Status
9AM—4PM PST
Inquiry 179



1000 Nevada Highway • Unit 101
Boulder City, Nevada 89005

NO SURCHARGE
TERMS:
MC • VISA • Wire Transfer
C.O.D. • Cashiers Check • A.E. add 4%
Purchase Orders • Money Orders
Personal Checks

SHIPPING:
UPS • Federal Express

SAVE MONEY **EPROM PROGRAMMER**

APROTEK 1000 ONLY

\$265.00

COMPLETE WITH PERSONALITY MODULE



117 AC POWER-RS-232 CONNECT
-6 BAUD RATES - HANDSHAKE TO HOST
ALLOWS READ, WRITE, VERIFY & COPY

Comes complete with IBM-PC, Apple, or CPM (Specify Computer) Driver Program on Disc.

Programs the following 5 Volt 24 or 28 pin devices: 2716 series through 27512, 25xx series, 68764 plus others. Please Specify Personality Module desired with order. Additional Personality Modules only \$15.00 ea. Full 1 year warranty.

TO ORDER: CALL 1-800/962-5800 OR WRITE APROTEK
1071 A AVENIDA ACASO Add
CAMARILLO, CA 93010 \$4.00 Shipping-USA
Info: (805) 987-2454 VISA or MC Add 3%
We Accept Govt., School & Large Corp. P.O.s

Inquiry 23

ChinaStar® II
MULTILINGUAL
WORD PROCESSOR
多國語文文書處理

- For IBM PC, XT, AT or compatible with 256KB RAM
- Multilingual — Chinese, Japanese, Russian and Greek
- Lotus 1-2-3, dBASE III,..... compatible
- Demo and Chinese word puzzle disks available

JHL RESEARCH, INC.
JHL
(714) 827-7420

2552 W. Woodland Dr., Anaheim, CA 92801
Fax: (714) 952-4716 • Telex: 350481 IBC

Inquiry 149

PUBLIC DOMAIN SOFTWARE

Thousands of useful programs available for most computers from user group libraries.

User Group Libraries	Rent	Buy
IBM PC Blue 220 Disks	\$230	\$450
Capitol-IBM 45 Disks	50	105
Sanyo UG MSDOS 80 Disks	85	225
Amiga 50 Disks	65	200
Atari ST 55 Disks	75	220
Macintosh 85 Disks	90	255
CP M UG 92 Disks	45	249
SIG M UG 270 Disks	175	330
CBM 64 Gold 50 Disks	105	150
Apple DOS 120 Disks	130	200

MASTER CARD • VISA • DINERS

Rental is for 7 days with 3 days grace for return. Use credit card, no deposit! Call for free catalog or send Disk for free Directory of programs. Specify Computer!

PUBLIC DOMAIN SOFTWARE
INTEREST GROUP INC.
2400 Santa Rita
Las Vegas, Nevada 89109
702 732-0169
800 527-3744

BBS NUMBER
(702) 794-3665

Inquiry 252

Tune-up your hard disk

Vopt™
IBM, DRG, ANZA

FAST — EFFICIENT

Vopt organizes your hard disk into contiguous files for fast, efficient, time-saving use! Initial organization averages under 5 minutes; daily runs average under 1 minute!

CONVENIENT
Run it from your autoexec.bat file!

SAFE

Vopt's contiguous files are easier to recover if accidentally deleted! Vopt's speed allows files to be moved one-at-a-time, rather than taking chances on disk reliability. Detects and maps bad sectors.

GOLDEN BOW SYSTEMS

\$49.95
Add \$3 for S&H
California Residents add 6% Sales Tax

2870 Fifth Avenue
Suite 201
San Diego, CA 92103
619/298-9349



Inquiry 121

Incredible!

64K Printer Buffer
with cable

\$69 Plus \$3 shipping & handling

30-day money back guarantee plus 1-year warranty

Limited Offer-Order Today

Works with any standard Centronics parallel interface • Reset button • Multiple copy repeat function • Auto diagnostics • Self-test

Order by Check/MO or VISA/MC/AX

Call Toll Free
USA: 800-533-8049
CA: 800-624-5628

CENTRAL COMPUTER PRODUCTS

330 Central Avenue • Fillmore, CA 93015



Inquiry 50

9-TRACK MAG. TAPE SUBSYSTEM
FOR THE IBM PC/XT/AT AND...



For information interchange, backup and archival storage, IBEX offers a 9-track, IBM format-compatible 1/2" magnetic tape subsystem for the IBM PC, featuring:

- IBM format 1600/3200 and 800 cpi.
- Software for PC-DOS, MS-DOS.
- Also for DEC, VAX, VME, S-100, RS-232, IEEE 488.

IBEX

IBEX COMPUTER CORP.
20741 Marina St.
Chatsworth, CA 91311
(818) 708-8100
TWX 910-493-2071

Write, phone or TWX for information

Inquiry 133

DiskMASTER™
The Ultimate Diskette Value ...

Discover the Difference ...

2 FOR 1 LIFETIME WARRANTY

- * Performance exceeds ANSI specifications by 62.5%
- * Each diskette 100% tested and certified error free
- * 65% clipping level * Over 10 million passes per track
- * Reinforced Hubs (DS-DD only) * Tyvek® sleeves
- * W/P tabs and ID labels

.49 Made in U.S.A. **1.09**

5 1/4" - 48 TPI DS-DD DS-HD 96 TPI IBM-AT Compatible

Simply top Brand-Name Quality
Call For Best Prices

BULK 32¢ + 6¢ FOR TYVEK

CENTECH
Nashua **3M**

1-800-233-2477 1-801-561-0092
199 Cottage Ave., Sandy, Utah 84070

Inquiry 64

NEW!



SafeSkin™
KEYBOARD PROTECTOR

Remains in place during keyboard use. Prevents damage from liquid spills, dust, ashes, etc. Fits like a second skin, excellent feel. Available for: IBM-PC, AT, Apple (all), Compaq, Model 100, NEC 8201, C64, Zenith 150, DEC, Kaypro, KB5151, AT&T 6300, WYSE 50 and many others. Send \$29.95, check, M.O., Visa & MC include exp. date. Specify computer type. Dealer inquiries invited. Free brochure avail.

Merritt Computer Products, Inc.
4561 S. Westmoreland, Dallas, Texas 75237
(214) 339-0753

Inquiry 181

DATA SWITCHES



- High quality rotary switch
- Gold plated contacts
- All pins switched
- Fully shielded metal case
- Anti-skid feet
- Female connectors
- Ninety day warranty

RS232 TYPE (25 PIN)

#38610	TWO POSITION	27.95
#38615	FOUR POSITION	39.95
#38650	X-TYPE	43.95

CENTRONICS TYPE (36 PIN)

#38640	TWO POSITION	28.95
#38695	FOUR POSITION	42.95
#38655	X-TYPE	45.95

AUTO SWITCH

#38710	FOUR POSITION	148.50
#38760	EIGHT POSITION	196.85

WE ALSO CARRY CABLES, PRINT BUFFERS & MANY OTHER ACCESSORIES

Please call or write for our free catalog

DALCO ELECTRONICS
(513) 435-1058

P.O. BOX 494 FRANKLIN, OH 45005 MC/VISA Accepted Mail Orders Please Add \$3.00 For Shipping

Inquiry 85

FOLKS DOWN IN TEXAS DON'T LIKE PAYIN' BIG BUCKS ESPECIALLY FOR IBM-PC SOFTWARE SO WE SELL IT FOR ONLY \$6.00!

OVER 600 DISKS FULL OF IBM-PC COMPATIBLE PUBLIC DOMAIN AND USER SUPPORTED SOFTWARE.

APPLICATIONS

- GENEALOGY ON DISPLAY (#90)
- GENEALOGY - FT (#240) From Pine Cone software.
- LABELMAKER (#146) Our favorite label file and maker. Menu driven.
- FAMILY HISTORY (#361) Family history, ancestor and descendant charts. Sample programs.
- FORM LETTERS (#388) LOTS of samples of the most commonly used business letters. Modify!
- PC-SPRINT (#507) Detailed instruction on how to double your computer's speed for less than \$50.00.
- MSDOS-CPM/80 INTERFACE (#561) CPM lovers! This program allows you to transfer information between and emulate CPM and MSDOS.
- NAME GRAM/BREAK DOWN/FOREWARD (#477) Discover the words inherent in your phone number, do great anagrams.
- THE WORLD DIGITIZED (#494, 495, 496) A cartographer's dream. Locate and display over 100,000 locations.
- 100 LETTERS (#300) Most commonly used from letters, and business applications at your fingertips.

COMMUNICATIONS

- QMODEM (#310) Without a doubt the fastest and best communications software you can buy at any price.
- PC-TALK (#116) The classic "Freeware" communication program.
- RBBS (#212) Become a SYSOP and start a bulletin board.
- FIDO NET (#333) Bulletin Board System. Perhaps the easiest to run.
- PROCOMM (#499) Communication software that makes a hacker's dream come true.

DATABASE

- VCR dBASE (#493) Keep track of those favorite VCR tapes that you never can seem to find when you want them.

DATABASE PROGRAMS

- PC-FILE (#5) Perhaps the granddaddy of user supported database programs from Jim Button.
- NEWBASE (#238) Menu driven database for the beginner.
- PC-DBMS (#383) A relational database management system that provides on-line help and screen editing functions.
- CREATOR (#339) Create, report and sort makes this a super database management system.
- MAIL MASTER (#481) Easily sort, index, and list your multiple mailing data bases.

EDUCATION

- EQUATOR (#249) A teaching tool for math, science and finance
- PC-TUTORIAL (#403) A first course in computer usage covering various aspects of MS-DOS. Good!
- PC-PROFESSOR (#105) Learn Basic the easy way. One of the best tutorials on BASIC.
- PC-DOS HELP (#254) Type "help" for the DOS command you forgot.
- PC PROMPT (#558) Fascinating on line memory resident DOS helper that also supports BASICA, ED-LIN, DEBUG, and TURBO PASCAL.
- PC-SPRINT (#507) Tutorial on how to triple your PC's speed.

FINANCIAL

- PC-CHECK MANAGER (#275) Keeps multiple checkbooks in balance.
- TAX FILE DBS (#295) Tax record keeping system that saves you money on April 15.
- PORTSWORTH PACKAGE (#101) Evaluates your ever-changing stock portfolios.
- PC-GENERAL LEDGER (#237) An exceptional accounting system. Used by some CPA's.
- LOAN AMORTIZATION (#399) For output to screen or printer. Lots of on-line help.
- MR. BILL (#469, 470) Prepare invoices, client report, audit trail, etc.
- (3) ANALYTIC CALC (#430-432) 3 disk set. Complete spreadsheet, database, graphics, word processor - fassst!
- (2) PC ACCOUNTING SYSTEM (#559, 560) General purpose ledger system that includes payroll, depreciation, accounts receivable/payable, inventory, processing 1099's and a good general ledger.
- PC-PAYROLL (#565) Handle all payroll problems with this complete menu-driven payroll system. Includes taxes, reports, forms, etc.
- (2) SALESEYE (#501, 502) Never let another prospect or lead get away! Prints memos and letters as well.

GAMES

- TOP GAMES (#274) The most requested arcade type games.
- ARCADE GAMES (#293) Another goodie bag of top arcade games.
- PC JR GAMES (#354) Games that will work only on PC JR. Combat, Dungeons and Dragons, Global Thermonuclear War.
- MISC GAMES (#390) Good selection of educational, adventure, and arcade games.
- PINBALL RALLY (#557) You asked for it! Here are three pinball games that vary in complexity, PINBALL, RAIN, TWILZON2.
- DND (#567) Dungeons and Dragons, this uses text characters instead of graphics.
- REFLEX POINT (#487) Self styled action game similar to ROBOTECH cartoon series.

GRAPHICS

- PC-KEY DRAW (#344-345) A small CAD system. Lots of demonstration files.
- PC-PICTURE GRAPHICS (#136) Drawing package allows you to zoom, color, and store pictures.
- PC-GRAPH (#418) Allows user to create graphics from PC-File report files.
- PRESENT (#471) Professional slide shows are a snap with the advanced graphic features of this program. Includes a screen "capture".

LANGUAGE

- CHASM (#10) Cheap assembler with tutorial
- XLISP (#148) Lisp language interpreter.
- PROLOG & UNIFORTH (#417) Complete with editor and documentation.
- ESIE (#398) Build and generate an expert system in a flash.
- P-BASIC (#381) BASICA work-a-like for clones, etc.
- TINY PASCAL COMPILER BUILDER (#540) Learn to create your own Pascal Compiler and language compiler/includes tutorial.

- SCREENCODE (#503) Build your screen applications and watch SCREENCODE generate the code for DBASE II and III, BASIC, and more.
- VISIBLE PASCAL COMPILER (#510) Watch your program step through its routines as you learn to program it in PASCAL.
- EXTENDED BATCH LANGUAGE (#124) Makes the PC do menial tasks you never thought possible.

MATH AND STATISTICS

- EPISTAT (#88) Statistical analysis of small to medium signed data samples.
- STAT-TOOLS (#509) (1 of 2) Do single size experiments, studentized ranges, calculate the size of specific sample sizes.
- STAT-TOOLS (#509) (2 of 2) Do calculations that require the entry of original observations, exact randomization tests, mean squares, etc.

MUSIC

- PC-MUSICIAN (#127) Compose music on your PC, save and play again.
- PIANO MAN (#279) Play your keyboard like a piano.

PRINTER UTILITIES

- SIDEWAYS (#265, 411) Prints text sideways on an Epson printer.
- SETPRTR (#79) Sets up Epson print from a menu.
- PRINTER UTILITIES (#411) Smorgasboard of utilities and tools.
- EPSON PRINTER UTILITIES (#326) Spool, set up routines all designed for Epson codes.
- BANNER (#386) Make long banners with large letters. Includes MS-FORTRAN source codes.
- WSMX80 (#526) Allows Word Star to print more ways than you imagined on an Epson/Compatible printer. Useful for mathematical and scientific notation.

SPREADSHEET TEMPLATES

- PC-CALC (#199) Fabulous 123 work-a-like from the author of PC-File.
- (2) LOTUS 1-2-3 TEMPLATES AND MACROS (#406, 414) Why spend hours writing your macros when these are ready made? Modify them yourself.

TEXT PROCESSING TOOLS

- WORDSTAR AIDS (#375) Collection of the most useful utilities for the Wordstar user.
- PC OUTLINE (#414) Create and collapse and outline. Great for plans, essays, etc.
- PC-STYLE (#505) Better than your high school English teacher! Analyzes your writing ability.
- POLYGLOT & LETTERFALL (#542) Two educational programs to match sentences, words, and definitions. O&A's. Typing tutor is great!
- SIDE WRITER (#523) Print your text files sideways. Allows the 132 column barrier to be broken. Great for large spread sheets.

UTILITIES

- GINACO (#66) Polished routines written in basic for any beginner or expert. We love it!
- ULTRA-UTILITIES (#133, 245) Recover lost files, modify sectors, etc. Like Nortons.

- SYSMENU (#250) Build a menu driven menu system. Excellent for hard disks.
- PC-DESKMATES (#405) Better than Sidekick and all of the rest of the memory resident desktop utilities.
- ALIGN (#217) Disk Alignment tool. Needs Cats Eye.
- TOP UTILITIES (#273) All of the most requested utilities on one disk.
- UNPROTECT (#414) Various routines to disconnect protection schemes
- PATCHES (#376) Make back up copies of some of the most popular commercial programs with this collection.
- DOSMATIC (#498) Fabulous task-switching and menuing utility that allows several programs to run at once.
- PC-TOOLS (#536) Lots of useful utilities with both EXE and "C" source code. BROWSE, DUMP, MERGE, WORD COUNT, ROFF, GREP, etc.
- DBS-KAT (#537) Diskette cataloging system for archival purposes. Database can hold up to 9,999 diskettes and 16,000,000 files.
- STILL RIVER SHELL (#481) An enhancement of the PC-DOS working environment. Faster and uses Key Commands.
- PC-PROMPT (#558) The on-line mode makes this memory resident utility tops. Great for beginners and advanced users alike.

WORD PROCESSING

- PC-WRITE (2) (#78) A & B Our most popular full featured word processor that is actually faster than Wordstar. Now with spelling checker.
- DICTIONARY (#378) Dictionary type spelling checker.
- PC TYPE (#455) Jim Button's contribution to a full fledged word processor.
- (2) NEW YORK WORD (#528, 529) Powerful word processor that creates keystroke macros, split screen editing, mail merge and more. Watch out Micro-Soft.



Please
Enclose
Check
With
Order

TOTAL # _____ x \$6 = _____

DISK DIRECTORY _____ x \$6 = _____
(Explanation of all files & programs)

OTHER _____

SUBTOTAL _____

TEXAS RESIDENTS ADD 6 1/8% TAX _____

SHIPPING AND HANDLING _____
(1 @ \$1.00 and 50¢ for each additional disk)

LONE STAR
SOFTWARE

No COD's or Purchase Orders • U.S. Funds Only
Foreign Orders add \$5.00 to all Shipping/Handling
We Warranty All Disks Against Defects In Duplication

SHIP TO: _____

CHARGE MY: _____

MASTERCARD VISA

CARD NO. _____

EXPIRATION DATE _____

SIGNATURE _____

2100 Hwy. 360, Suite 1204, Grand Prairie, Texas 75050, (214) 647-1010 ©1987 LONE STAR SOFTWARE, INC.

Super Star™ Diskettes at Super Low Prices!

Super Star diskettes:
HIGH CLIP (65%+) LIFETIME WARRANTY
American made...not cheap imports.

**Sure, you can buy a cheaper diskette,
but that's exactly what you'll get.**

5.25" DISKETTES:

DSDD .38 ea.
DSDD96TP1 .52 ea.
DSDD HD 1.00 ea.

3.5" DISKETTES:

SSDD 1.16 ea.
DSDD 1.40 ea.

(Super Star disks
sold in multiples of 50 only)

BASF, Athana, Goldstar, color diskettes
and more at discount prices

1-800-621-6827

(In Illinois, 1-312-256-7140)

Visa/MasterCard \$35 min.
Dealer and International Inquiries Welcome

DISK WORLD!, Inc.

629 Green Bay Rd., Wilmette, IL 60091

Inquiry 93



9 TRACK TAPE SYSTEM

FOR IBM PC/XT/AT



- Mainframe to PC Data Transfer
- High Speed Backup
- All Software, Complete System
- Service and Support, easy Installation

call **(818) 343-6505** or write to:
Contech Computer Corp.
P.O. Box 153 Tarzana, Calif. 91356

CONTECH

Inquiry 73

TERMINAL EMULATIONS

**NEW SOFTERM PC,
RELEASE THE LEADER IN EXACT
TERMINAL EMULATIONS**

* OVER 30 EMULATIONS

- * KEYBOARD MACROS
- * HOTKEY
- * VIRTUAL DISK CAPABLE
- * SCRIPT FILES
- * KEYBOARD TRANSLATE
- * MULTITASKING

- * CAPTURE FILES TO DISK OR PRINT
- * FILE TRANSFERS WITH 7 PROTOCOLS
(I.E. KERMIT-SERVER, HAYES, XMODEM, ETC.)
- * CONCURRENT AND BACKGROUND
COMMUNICATIONS AND MORE!!!

A COMPLETE EMULATION & COMMUNICATION
PACKAGE

SEIFTRONICS
800/225-8590
CALL FOR INFORMATION
(303)593-9540 TELEX 450236



Inquiry 286



NEW 1.2MB ROMDISK PC ENHANCED

- Non volatile diskette emulators to 1.2MB for the IBM PC/XT/AT and compatibles
- Standard EPROM models to 1.2MB and cassette models using either EPROM or SRAM technology to 786K
- Develop programs on a diskette and simply copy to ROMDISK
- On-board EPROM programmer and utilities provided to copy a Master Diskette and program the EPROMs using fast programming algorithm (180K/min)
- Read modes for autobooting and using up to four ROMDISKS per computer
- Solid state speed and reliability-operation at RAM speeds in environments hostile to diskettes
- Short card format fits half size card chassis

**CURTIS, INC. 10 Anemone Cr.
St. Paul, MN 55110
612/484-5064**

*IBM is a registered trademark of IBM Corporation

Inquiry 81



Add complete VT220 workstation capability to your PC/XT/AT with ZSTEM™ software and 220 layout keyboard.

PowerStation™-220 \$289

SEE US AT SPRING COMDEX

KEA Systems Ltd.
#412 - 2150 West Broadway
Vancouver, B.C. Canada V6K 4L9
Support (604) 732-7411
TELEX 04-352848 VCR
Order Toll Free (800) 663-8702
30 day money back guarantee. MC/VISA

Inquiry 154

ICs PROMPT DELIVERY!!!

SAME DAY SHIPPING (USUALLY)
QUANTITY ONE PRICES SHOWN for APRIL 26, 1987

		OUTSIDE OKLAHOMA		NO SALES TAX
DYNAMIC RAM				
1Mbit	1000Kx1	100 ns		\$28.50
51258	256Kx1	100 ns		6.95
4464	64Kx4	150 ns		3.50
41256	256Kx1	100 ns		4.35
41256	256Kx1	120 ns		3.50
41256	256Kx1	150 ns		3.25
4164	64Kx1	150 ns		1.30
EPROM				
27512	64Kx8	200 ns		\$10.50
27C256	32Kx8	250 ns		5.15
27256	32Kx8	250 ns		4.85
27128	16Kx8	250 ns		4.10
27C64	8Kx8	150 ns		4.85
2764	8Kx8	250 ns		3.75
STATIC RAM				
62256	32Kx8	120 ns		\$12.95
6264LP-15	8Kx8	150 ns		2.95

64Kb MOTHERBOARD UPGRADE: Zenith 150, IBM PC/XT, Compaq Portable & Plus, hp Vectra
 8087 5 MHz \$115.00
 80287-8 8 MHz \$250.00

OPEN 6 1/2 DAYS, 7:30 AM-10 PM. SHIP VIA FED-EX ON SAT
SUNDAYS & HOLIDAYS. SHIPMENT OR DELIVERY VIA U.S. EXPRESS MAIL

SAT DELIVERY INCLUDED ON FED-EX ORDERS RECEIVED BY THU 5PM EST 4 hrs FR P.D. \$12.25

MasterCard VISA or UPS CASH-COD
Factory New, Prime Parts
MICROPROCESSORS UNLIMITED, INC
74 000 S. Federal Ave.
BEGGS OK 74421
(918) 267-4961

No minimum order. Please note that prices are subject to change. Shipping & insurance extra. Add \$1 for packing materials. Orders received by 8 PM CST will usually be shipped the next morning, via Federal Express Standard. Add \$8.00 for guaranteed next day Priority One - \$13.00 Air Mail.

8087 5 MHz \$115.00
80287-8 8 MHz \$250.00

Inquiry 197

6809

Single Board Computer



6809 MPU, 2 serial ports, 4 parallel ports,
 RAM, EPROM, real-time clock, watchdog
 timer, 44-pin 4.5" x 6.5" PCB
EXPANSION MODULES: RAM, EPROM, CMOS
 RAM/battery, analog I/O, serial I/O,
 parallel I/O, counter/timer, IEEE-488,
 EPROM programmer, floppy disks,
 cassette, breadboard, keyboard/display.



WINTEK

Wintek Corp.
1801 South Street
Lafayette, IN 47904
317-742-8428



Inquiry 339

ENHANCED VT220 \$150



The most complete VT220 emulation available for your PC/XT/AT or compatible.

- HIGH PERFORMANCE to 38.4K BAUD
- TRUE DOUBLE HIGH/DOUBLE WIDE
- TRUE 132 COLUMN MODE ON MOST EGA'S
- COLOR EXTENSIONS/DOWNLOADABLE FONTS
- SOFTKEY/MACROS, DOS ACCESS
- XMODEM/KERMIT FILE TRANSFERS plus many more extensions!

ZSTEMpc™-VT220Emulator \$150.
 EGAmate™ option for true EGA 132 column \$39
 ZSTEMpc™ - 4014 option \$99
 ZSTEMpc™ - VT100 Emulator \$99

KEA Systems Ltd.
#412 - 2150 West Broadway
Vancouver, B.C. Canada V6K 4L9
Support (604) 732-7411
TELEX 04-352848 VCR
Order Toll Free (800) 663-8702
30 day money back guarantee. MC/VISA

Inquiry 155

PC + MIDI = MUSIC

It's a simple equation. To plug your PC or PC-compatible into the modern world of music-making, use the complete line of MIDI software and hardware from VOYETRA TECHNOLOGIES.

- SEQUENCER PLUS: 65-track total MIDI recorder/editor.
- CONVERSION PLUS: file converter for music notation programs.
- PATCH MASTER: network organizer and sound librarian.
- OP-4001: PC/MIDI interface card.

"I've never seen a more powerful, easy-to-use music and recording system... bug-free."
(PC COMPANION)

For more information contact VOYETRA TECHNOLOGIES, Dept. PC, 426 Mt. Pleasant Avenue, Mamaroneck NY 10543, or call (914) 698-3377.

Inquiry 332

RS-232

Communications Board

- For IBM-PC/XT/AT & comp.
- Dual RS-232C interface
- Optional software supports COM1, COM2, COM3, COM4
- Jumper selectable interrupts

Fast Delivery
QUA TECH, INC.
 478 E. Exchange St. Akron OH 44304
 (216) 434-3154 TLX: 5101012726

Inquiry 255

- For IBM & Compatibles
- Flexible and Inexpensive
- Money Back Guarantee
- Free Technical Support

Fast Delivery
QUA TECH, INC.
 478 E. Exchange St. Akron OH 44304
 (216) 434-3154 TLX: 5101012726

Inquiry 257

RS-422

Communications Board

- For IBM-PC/AT/XT and compatibles
- Dual RS-422/RS-485 interface
- Differential drivers to 4000 ft.

Fast Delivery
QUA TECH, INC.
 478 E. Exchange St. Akron OH 44304
 (216) 434-3154 TLX: 5101012726

Inquiry 259

WAVEFORM SYNTHESIZER

- For IBM-PC/XT/AT and compatibles
- Generates user-definable signal
- Up to 2000 points per envelope

\$795.00
QUA TECH, INC.
 478 E. Exchange St. Akron OH 44304
 (216) 434-3154 TLX: 5101012726

Inquiry 256

- Single channel async communication board for IBM PC/XT/AT
- Software selectable to be RS/422/485, 232 or Current Loop
- Selectable Address & Interrupt

QUA TECH, INC.
 478 E. Exchange St. Akron, OH 44304
 (216) 434-3154 TLX: 5101012726

Inquiry 258

- GPIB controller board for IBM PC/XT/AT
- Control up to 14 Devices
- User friendly Software Commands
- DMA Transfer to 200K byte/sec.

\$345.00 including software
QUA TECH, INC.
 478 E. Exchange St. Akron, OH 44304
 (216) 434-3154 TLX: 5101012726

Inquiry 260

maxe

FLOPPY DIS

5 1/4" HIGH DENSITY	Packed 10 Per Box		
	2 box	5 box	10 box
	14 ⁹⁵	13 ⁹⁵	13 ⁵⁰

Packed 10 Per Box		
2 Box	Box	10Box
12 ⁵⁰	11 ⁵⁰	10 ⁹⁵
14 ⁹⁵	14 ⁵⁰	13 ⁹⁵

Disks	Data	
	DC 100A	12.95
S-Side	DC 1000	12.95
D-Den	DC 300A	16.60
	DC 300 XL	19.55
D-Side	DC 300XLP	19.85
D-Den	DC 600A	22.00
S-Side		8" Disks
96tpi	EAD	S-Side 15 ⁴⁰
	CLEANERS	S-Side 18 ⁹⁵
D-Side		D-Den 18 ⁹⁵
96tpi		D-Side
HIGH DEN.	12 ⁷⁵ EA.	
	30 Cleanings	

Printer (Data) Switch \$39/up
Dealer Price available

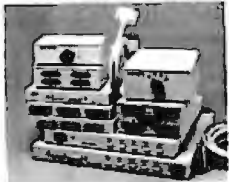

- *Metal case
- *Fully shielded
- *Push button (2 layer PC board or rotary switch)
- *Beige color
- *1 year warranty

CABLE (Lifetime warranty) \$9/up

- UL approved, molded, double shielded, beige color
- D type connector with thumb screw (screwless)

Switch box	Cable
2 way switch \$39/\$45	Printer cable 6'9"/12'
2 way cross \$55/\$69	\$9/\$12/\$15
4 way switch \$55/\$69	Modem cable 3'6' \$7/\$9
Power center/DB 25	Centronic cable 6'10' switch/swivel base \$89 \$12/\$15
Serial cable, Drive cable & extension cable available	

RS232 Miniature \$6/up
RS232 Break-out box \$59

JACO Computer Products
Tel: (408) 746-2000

989 E. California Ave
Sunnyvale, CA 94086

Inquiry 142

DATAFLEX™

- Multi-user Database!
 - Powerfull!
 - Multiple Operating System Compatibility!
 - Attractive Dealer Pricing!
 - Full Dealer Support!
- Dataflex is a trademark of Data Access
Dealer Inquiries Invited

COGITATE

24000 Telegraph Road
Southfield, Michigan 48034 USA
(313) 352-2345

Inquiry 56

SCR The Smart Cash Register

- Cash Register/Point of Sale/Inventory
- 100% dBASE III data files
- Import into 1-2-3, Accounting, and most other programs
- Interface to Bar Code, Receipt Printer, Cash Drawer, Register

WE CARRY ALL HARDWARE, TOO!!!

ORDER NOW
(915) 837-7180
SCR — Box 714
Alpine, TX 79831

Inquiry 277

EPROM PROGRAMMER
\$349

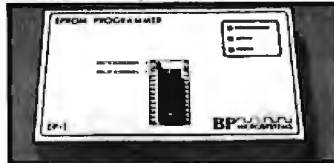

The EP-1 is a great value, here's why:

- IBM PC Software included or RS-232 to any computer
- ASCII Command driven operation. All intelligence in unit
- Reads Programs. Copies over 150 types from 2716 to 27512
- Optional Intel microcontroller programming head
- Menu-driven Chip Selection: No Personality Modules
- Fast, Slow, Quick-Pulse Programming Algorithms
- Intel (8080 & 8086), Motorola, Tekhex, Straight Hex Files
- Splits Files by Base Address and Odd/Even (16 bit systems)
- Gold Textool ZIF IC socket
- Generate & Set Checksums
- Over-Current Protection
- 8 Baud Rates 300 to 38,400
- Full One-Year Warranty
- 5, 12.5, 21.25V Programming
- U.V. Erasers from \$34.95
- Same Day Shipment

BP MICROSYSTEMS

10681 Haddington, #190 / Houston, TX 77043
(713) 461-9430 (800) 225-2102

Inquiry 375

MAXELL BULK DISKS

5 1/4" DS/DD 59¢

3 1/2" DS/DD 1.29

5 1/4" DS/HD 1.59

Price based on quantity of 300 includes sleeves, labels and tabs.

800-222-0490
In NJ 201-462-7628

- 24 Hour Shipment •

MEGASoft

P.O. Box 710, Freehold, NJ 07728
Full service duplication facility

Inquiry 180

Electronic Data Translation Services

Use your data among mainframes, minis, micros, dedicated word processors, and typesetters!

We offer translation of the logical elements of data in addition to conversion of physical parameters, NOT just dumping or ASCII transfer from one medium into another. For example:

- Translation of the control characters and formatting features of stand-alone or microcomputer-based word processors.
- Database restructuring—Even from your word processors' File and List Managers.
- Spreadsheet translations—formatting, cell referencing codes, and formulas.
- State and federal compliances—Magnetic media and file-structure conversions.

ADAPSO member

CompuData Translators, Inc. 6565 Sunset Blvd.
Suite 301, Hollywood, CA 90028 (213) 462-6222

Inquiry 61



Flow Charting II+
The New Plus for Fast Flowcharting

FLOW CHARTING

is new! It's now Flow Charting II+, with more speed

- + more functions + more printing options;
- 10 text fonts; 26 shapes;
- Line mode can stop at a shape;
- Backspace key can erase a line to its origin;
- Free text entry anywhere, or select auto-centering;
- Vertical or horizontal printing; one chart or multiple charts.

Used by Fairchild, Bechtel and more than 500 other major corporations. Edit quickly and accurately — even major edits — with Flow Charting II+, the Specialist.

See your retail store or call:

PATTON & PATTON

Software Corporation
800/672-3470, ext. 897 California
800/538-8157, ext. 897 National
408/629-5044 International

Inquiry 220

DATA ACQUISITION TO GO
INTERFAC FOR ANY COMPUTER
FREE IBM SOFTWARE



Connects via RS-232. Fully IBM compatible. Built-in BASIC. Stand alone capability. Expandable. Battery Option. Basic system: 16 ch. 12 bit A/D, 2 ch. D/A, 32 bit Digital I/O. Expansion boards available. Direct Bus units for many computers.

(201) 299-1615

P.O. Box 246, Morris Plains, NJ 07950

ELEXOR

Inquiry 101

DCB ! not only a printer buffer!
THIS IS THE MOST SOPHISTICATED
PRINTED BUFFER - MULTIPLEXOR - SWITCH

WITH TWO SEPARATE INPUTS (SERIAL AND PARALLEL) AND TWO SEPARATE OUTPUTS (SERIAL AND PARALLEL) CAN BE USED LIKE STANDARD BUFFER... WITH ANY INPUT TO ANY OUTPUT... BUT ALSO YOU CAN CONNECT 2 COMPUTERS TO 1 PRINTER, OR 1 COMPUTER TO 2 PRINTERS, OR 2 COMPUTERS AND 2 PRINTERS... AND MORE... 1 COMPUTER TO 3 PRINTERS OR 3 COMPUTERS TO 1 PRINTER
HIGH CAPACITY - 64 KB TO 256 KB AND - 256 KB TO 1 MB (MODELS A AND B) PAUSE, COPY AND RESET FUNCTIONS SERIAL PORTS WITH 7 OR 8 BITS WORD LENGTH, 1 OR 2 STOP BIT, PARITY, XON/XOFF, DTR, RTS

DCB-A-04K \$ 195 DCB-B-256K \$ 255 ¹

¹ Power supply and parallel cables are included

ALSO, WE HAVE THE MOST COMPLETE DATA CONVERTER UNIT CONVERTS RS232 SERIAL TO CENTRONICS PARALLEL OR VICE VERSA, JUST BY MOVING JUMPERS BAUD RATE AND PROTOCOL FULLY PROGRAMMABLE FROM 180 TO 19200 BAUDS INCLUDES: DTR, RTS, XON/XOFF, PARITY, etc

DCU \$ 80 ¹

¹ Power supply and cables NOT included

serial ↔ parallel
bi-directional converter



INTECTRA Inc. - Dept. 232
2029 TERMINAL BLVD
MOUNTAIN VIEW - CA 94045
(415) 967-8818 TX 345545

Inquiry 101

S-100™

"THE PC PEOPLE"

10th Anniversary Specials

PC COMPATIBLE SYSTEMS



**AST
Premium
286™**

AST PREMIUM/286 - Model 140 with 44 Mb 28 mSEC Drive, 10MHz 80286 with 11.5 Norton, 1Mb 100nSEC RAM, Serial & Parallel Ports, Clock/Cal, RT-Style Keyboard, 3-G Plus Card with EGA-CGA-HGC and 256K RAM, MS-DOS, GW-BASIC..... **\$69/mo.***

* 1 to 5 year leases available to qualified businesses. This ad produced on an AST Premium Publisher.

INDETECH

5170 Integrator System w/80286 8 MHz CPU, 512K-1 Mb RAM, 12 Expan. Slots, 238W P/S, up to 5 HH Drives, Novell Non-Ded. 286 Compatible, 1 yr warranty... **\$798**

TATUNG

80286-10MHz 640KRAM, 1.2 Mb Floppy, 20 Mb Hard Drive, 210W P/S, S & P Ports, Mono Monitor, MS-DOS 3.2, GW-BASIC, Diagnostics..... **\$2,195**

WYSE

WYPC-286 10 MHz 640K S, P, 1.2 Floppy..... **\$1,688**
WYPC-286-85 w/96 Mb 28 mSEC Hard Disk... **\$2,649**

NETWORKING

CONSULTATION AND INTEGRATION QUESTIONS??

CALL OUR EXPERT SALES & TECH STAFFS!!
NOVELL ADVANCED NETWORK STARTER KITS AND SERVERS.....CALL

3-User Network Special --- **\$177/Mo.***

NOVELL

Server/Work Station:

INDETECH 6/8MHz 286, 12 slots, 238W P/S, S & P Ports, Monitor, 360K Fpy, 1 Mb RAM, 44Mb H.D.

NOVELL Non-Dedicated Network 286

ARCNET 4-Port Passive Hub

3 ARCNET Cards and Cables to 100 Feet Each.

2 EasyData SUPERturbo XT 640K, 10MHz,

8088-1, 360K Floppy and "AT-Style" Keyboard,

"FCC" Approved. *3-Amber Monitors Included. *

** A COMPLETE NETWORK **

RETAIL..... **\$ 9,258**

NOW ONLY..... **\$ 5,388**

* Leasing available to qualified businesses.

Inter-Continental Micro

MS-CPS-PC PC/XT/AT SLAVE CPU CARD and Graphics Terminal with Software to Install in Novell Environment..... **\$1,095**

ARCNET COMPATIBLE 1/2 CARD..... **\$279**

ARCNET 8-PORT Active Hub..... **\$449**

ARCNET 4-PORT Active Hub PC/Card..... **\$225**

ARCNET 4-PORT Passive Hub..... **\$ 39**

6-PAK Premium/256K While They Last and Going Up!..... **\$199**

RAMPAGE-256..... **\$275**

RAMPAGE-AT..... **\$395**

RAMvantage 512K-2 Mb..... **\$259**

ADVANTAGE..... **\$329**

3G-PLUS 256K, HGC, CGA, EGA. **\$295**



The ALL "NEW" BBC! EasyData SUPERturbo XT

"AT-Style" Case and Keyboard, 8088-1, 120nSEC RAM 640K, 150W P/S, Mono/Herc/Printer Card, 360K Floppy & 12" Tilt 'n' Swivel Amber Monitor. All FCC Approved with one year parts and labor warranty..... **\$ 588.00**

Same as above w/Color/Graphics/Ptr Card & 14" Tilt 'n' Swivel, Hi-Res COLOR Monitor... **\$ 789.00**

Same as above w/Color Card, Serial, Parallel, Game Ports, Clk/Cal, Dual Floppies & 14" Tilt 'n' Swivel Color Monitor..... **\$ 929.00**

20Mb Seagate and controller..... **\$ 329.00**

MONITORS & TERMINALS

TATUNG® ONE YEAR WARRANTY AND 30 DAY D.O.A. SWAP-OUT!

CM-1365 RGB 13" 5-Color Text----QTY 5..... **\$319**
CM-1380F EGA 13" 640x350 G/A Switch..... **\$439**
SUPREME EGA 256KEGA,HGC,CGA,MDA,132 \$229
MM-1222A Green/Amber Hi-Res Mono TTL..... **\$ 95**
MM-1422 Dual Frequency 14" Green/Amb..... **\$139**
NEC MULTISYNC Monitor..... **\$CALL**
SAMSUNG EGA Tilt 'n' Swivel, 14" Monitor..... **\$379**
SAMSUNG 14" Tilt 'n' Swivel Color Hi-Res..... **\$269**
SAMSUNG 12" TTL Tilt 'n' Swivel..... **\$ 85**



WYSE 30..... **\$325**
WYSE50..... **\$389**
WYSE 60..... **\$459**

PRINTERS & PLOTTERS

brother

HR-20 20 CPS Daisy Wheel-Auto Load..... **\$339**
HR-40 40 CPS Daisy Wheel with built-in Tractor and Cutsheet Feeder with "Paper-Park"..... **CALL**
HR-60 "Looks Like a 635, Works Like a 635, Costs Like a Brother!"..... **CALL**
M-1109 100/25 CPS P & S with Tractor..... **\$189**
M-1509 180/45 CPS P & S with Tractor..... **\$343**
M-1709 240/50 CPS P & S with Tractor, Epson/Printer Compatible, "Paper Park"..... **\$444**
M-1724 "Look Out Toshiba! The Competition has Arrived!"..... **CALL**

Xerox/Diablo 635 with I/F..... **\$775**
Citizen..... **CALL**
OTC OT700E 200 Lines/minute..... **\$1,395**
OTC OT850XL 240 Lines/minute..... **CALL**
Hanzon Buffer 64-256K, S-S, S-P, P-P, P-S..... **\$195**



DMP 56A..... **NEW! CALL**
ScanCad..... **NEW! CALL**

LASER PRINTERS

OKIDATA LASERLINE 6
Ricoh Engine, 6 Pages per min.
128K RAM (expands to 512K)
Perfect for Text Intensive
Applications..... **\$ 1,598!**



H. P. LASERJET Plus Series 2..... **\$ 2,149**
CORDATA LP-300 Laser Printer..... **\$ 2,249**
PCPI LASER I MAGE 2000 - Ricoh Engine, 8 Pages per min, 1.5 Mb RAM, 300x300 DPI (full page)\$ **2,859**
XEROX 4045 LASER 512K RAM S & P Interface, 10 pages per min..... **\$ 3,695**
AST TURBOLASER Ricoh Engine, 10 pages per min, 300x300 DPI, Fast Graphics..... **\$ 3,259**

POWER SYSTEMS & ACCESSORIES

P-15 MONITOR BASE with 5 A/C Plugs Noise, Surge and Modern Protected, Disk Storage..... **\$ 75**
POWERSAVERS mfg by TOPAZ - SineWave UPS, 400, 800, 1000W Models..... **FROM..... \$495**

SCIENTIFIC SOLUTIONS

IEEE 488..... **\$239** IEEE 488 s/w..... **\$ 65**
DADIO Board..... **\$239**
Lab Master..... **FROM..... \$649**

S-100 BUS PRODUCTS

CPRO RAM-16 64K Static for 80286 CPU..... **\$ 79**
Brackets for CompuPro Drive Cabinet..... **\$ 25**
CompuPro RAM 22-256K Static..... **\$388**
CompuPro Interfacer-3 8-Serial Ports..... **\$388**
Macrotech MSR-II 0-3 Mb..... **\$219**
Intercontinental Micro Systems
MS-1000 Runs PC-DOS Programs Includes Graphics Terminal and Software..... **\$995**

DRIVES

20 Mb PC Subsystem with ST-225 & Ctrl..... **\$329**
30 Mb PC Subsystem with ST-238 & Ctrl..... **\$398**
Fujitsu 5.25" HH 48 TPI Floppy Drive..... **\$ 85**
Irw in 20Mb Tape Internal..... **\$469**
Micropolis 1325 85 Mb 28 mSEC..... **\$ 1,139**
Maxtor XT-1140 140Mb 28 mSEC..... **\$ 2,499**
Maxtor XT-2190 190Mb 28 mSEC..... **\$ 2,769**
Mitsubishi 2896 HH 8" Floppy Drive..... **\$425**
Mitsubishi MF501 48TPI... **\$ 89 / MF504 96TPI. \$115**
Quantum Q540 43 Mb F.H..... **\$699**
SMS Sigen i60 Internal 60Mb Tape System..... **\$695**
Seagate ST-251 H.H..... **\$569**
Seagate ST-4051 F.H..... **\$598**
Seagate ST-4096 28mSEC 96Mb..... **\$888**
Teac FD-55-BV 48TPI Floppy Drive..... **\$ 89**

MODEMS

ProModem 1200B with Mirror Software..... **\$119**
CTS 2424 ADH ASYNCH/SYNCH (Hayes)..... **\$269**
CTS 2424 AMH Class4 MNP Error Correct..... **\$349**
CTS Half-Pak 24 1/2 Card..... **\$219**
U.S. Robotics 212A "Hayes Compatible"..... **\$ 95**
EasyData Modems with PC-Talk.
EasyData 1200 Internal Half Card..... **\$ 88**
EasyData 2400 Internal Full Card..... **\$178**
Hayes compatible and more!

800-528-3138 Orders Only 602-991-7870 Customer Service

S-100 DIV./696 CORP. 14455 NORTH 79TH ST. SCOTTSDALE AZ 85260 TELEX 9103806778 SONEHUND

Advised prices are cash paid only. For qualified payment terms calculate additional charges in the following way: P.O.'s an IAM Express - .85, MC/VISA - .97, C.O.D.'s - .99 (\$5 min. fee) APO's accepted. Shipping \$4 1-5 lbs. Tax Arizona residents only. All return's subject to restocking fee or credit towards future purchases. All prices and availability subject to change without notice.



COMP-CASE High quality hard case designed to hold your IBM for short trips, i.e. office to home, school to home, audits, equipment demos, etc. Features lift off lid, key locks, padded handle, attache case looks.

IB501 Holds PC or XT and Kbd. reg. \$429 now \$99
 IB502 Holds Mono Monitor reg. \$-99 now \$75
 IB503 Holds Color Monitor reg. \$419 now \$90

also available:
TRAV-L-CASE Heavy duty transport case designed for airline travel. Features steel corners, aluminum edges, double locks, lined with foam.

T5010 Holds PC, XT, or AT and Kbd. \$269

Computer Case Co.
 3947 Danford Sq. Columbus, OH 43220
 1-800-848-7548 (Ohio 614-876-1784)

Inquiry 65



6805/6305 SINGLE CHIP MICROCOMPUTER DEVELOPMENT SYSTEMS

Two systems allow the IBM PC/XT/AT to be used as a complete development system for the MOTOROLA 6805 series single chip microcomputers. Model MCPM-1 supports the MC68705P3, P5, U3, U5, R3, & R5 chips. Model MCPM-2 supports the MC1468705F2 & G2 cmos versions. Both systems are priced at \$495 and include a cross assembler program, a Simulator/Debugger program and a programming circuit board with driver software. A system is also avail. for the HITACHI 63705 ZTAT micro.

THE ENGINEERS COLLABORATIVE
 P.O. Box 53, West Glover, VT 05875
 (802) 525-3458

Inquiry 103

PC-WRITER T.M.

IBM PC GRAPHICS & LETTER QUALITY
 Enhancement for Okidata ML82A/83A Dot Matrix Printers

- Plug-in module easily installs in printer
- Draft (120 cps) & Letter Quality (30 cps)
- Elite character pitch
- Front panel access to all features
- Emulation of IBM PC Graphics printer
- Superscripts / subscripts
- Foreign / scientific characters
- Works with original green key in graphics mode
- Prints and displays screen characters and bold drawing symbols exactly as they appear on display (double line as well as single line box symbols)

ASK ABOUT OK-WRITER™ Okidata graphics for \$99 with many of above features

RAINBOW TECHNOLOGIES, INC.
 17971-E Skypark Circle, Irvine, CA 92714
 (714) 261-0228 Telex 386078
 UK Distributor: X-DATA (0753) 72331

Inquiry 264

Get the whole story on graphics terminal emulation.



To find out more about software that lets your PC emulate TEKTRONIX™ 4105/6/7/9 and DEC VT100™ terminals, call or write:

GRAFPPOINT
 4340 Stevens Creeks Blvd., Suite 280,
 San Jose, CA 95129 (408) 249-7951

Inquiry 122

IEEE 488 (GPIB/HPIB)

- Controllers
- Buffers
- Converters
- Extenders
- Interface Boards

for PCs, Macintosh, HP plotters, instruments, printers, etc.

Call or send for your FREE Technical Guide

IoTech (216) 439-4091

23400 Aurora Road
 Cleveland, Ohio 44146

Inquiry 141

ENCLOSURE POWER



- * Floppy's, Hard Disk, Optical Disk, Tape Drive, or any Combination
- * Custom Design with Injection Molding Front
- * Superb Quality and Pricing
- * Prompt Delivery

JMR ELECTRONICS, INC.
 The Power Source Behind The Drive
 1855 1/2 Parthenia Street, Northridge, California 91324

Outside CA (800) 635-5555
 CA (818) 993-4801

Inquiry 150

TRI STATE COMPUTER
 160 BROADWAY, NEW YORK, NY 10038
 (Bet. Maiden Lane and Liberty St.)
 (212) 349-3134 • Open weekdays 9-6, Sunday 10-4
CALL TOLL FREE ORDERS ONLY 1-800-221-1926

MC & VISA ACCEPTED
 NO ADDITIONAL CHARGE



IBM AT 30 MB Hard Drive 256K 1.2 Drive Seagate 4038
IBM AT Keyboard \$2749.95
IBM XT 256K-1.360K Drive Enhanced Keyboard \$899.95
 As Above with 20 MB . . . \$1249.99
AT&T 6300
 640K-1360K Drives, monitor with Keyboard \$1199.95
 As Above with 20 MB . . . \$1599.95
LEADING EDGE Model D Original 20 MB System w/monitor \$1299.95
LEADING EDGE™ Dual Floppy \$999.95
PANASONIC BUSINESS PARTNER XT FX 600 256K expandable to 640K 1-360K Drive, 20 MB HD \$1099.95

TOSHIBA T3100 in stock \$2699.95
TOSHIBA T1100 Plus with 640K NEW SCREEN . . . \$1449.95
BROOKLYN BRIDGE . . . \$99.95
ZENITH Z 181 in stock \$1699.95
 NEC multi-speed Laptop \$1349.95

SPECIAL PRICE EPSON EQUITY I 256K 1-360K drive, with monitor & video card, DOS & BASIC, parallel & serial ports . . . \$599.99
 1-360K, 1-20 MB Hard Drive \$899.99
EPSON EQUITY II 640K/360K Drive 20 MB Hard Drive w/mono-monitor \$1299.95
 w/color-monitor \$1549.95

FACSIMILE FAX MACHINE Canon FAX Phone #10 . . . \$1144.99
 XEROX Model #7010 . . . \$1799.99

PRINTERS

IBM Pro Printer XL	\$509.95
IBM Pro Printer	\$339.95
Epson LX 88	\$164.95
Epson FX 88E	\$104.95
Epson FX 288E	\$429.95
Epson LQ 800	\$419.95
Epson EX 800	\$364.95
Epson EX 1000	\$489.95
Epson LQ 1000	\$599.95
Epson LQ 2500	\$829.95
Panasonic KXP 10801	\$159.95
Panasonic KXP 10911	\$209.95
Panasonic KXP 10921	\$264.95
Panasonic KXP 1592	\$319.95
Panasonic KXP 1595	\$369.95
Panasonic KXP 3151	\$229.95
Panasonic KXP 3151	\$359.95
OKI ML 182	\$274.95
OKI ML 182 Plus	\$315.95
OKI ML 292a	\$369.95
OKI ML 293a	\$499.95
OKI ML 183 Plus	\$479.95
Toshiba P321 PIS	\$389.95
NEC P6	\$389.95
Toshiba P341E	\$629.95

LASERS

Toshiba 351 Model 2	\$799.95
NEC P7	\$539.95
Silver Reed EXP 800	\$619.95

NEW HP Laser Jet, Series II
 HP Laser Jet 500 Plus . . . \$3179.95

SOFTWARE

Bank Street Writer	\$49.95
Doc Easy Accounting	\$39.95
D Base 3 Plus	\$349.95
Fast Back	\$89.95
Flight Simulator	\$32.95
Framework II	\$369.99
Lotus 123 version 2.01	\$289.99
Managing Your Money 3.0	\$104.95
Microsoft Windows	\$59.95
Microsoft Word	\$249.95
Multimate 3.3	\$199.95
Multimate Advantage	\$239.95
Word Perfect 4.2	\$189.95
Word Perfect Library	\$49.95
R Base Systems 5	\$329.95
Inset II	\$59.95

Software Carousel	\$34.95
Print Shop	\$34.95
Sideways	\$39.95
Turbo Lightning	\$59.95
Reflex	\$84.95
Carbon Copy	\$119.95
Superkey	\$39.95
Prolog	\$54.95
Laser-Income Tax	\$39.95
Travelling Sidekick	\$42.95
Think Tank	\$99.95

PLUS 20 MB HARD CARD \$549.95

IBM AT 339 compatible 10MHZ 1.2 Drive 640K 20MB Drive \$1349.95

MODEMS

Everex 1200B	\$95.99
Everex 2400B	\$179.99
1200 External	\$129.99
2400 External	\$299.99



Inquiry 317

All items subject to availability and price changes. Mail and phone orders C.O.D., MC and VISA, S&H extra. Not responsible for typographical errors. All systems fully tested and installed by Tri State Computer. Printer price w/purchase of cable only. Special to BYTE readers — Full Size Printer Stand \$12.95

The Amazing A-BUS

NEW

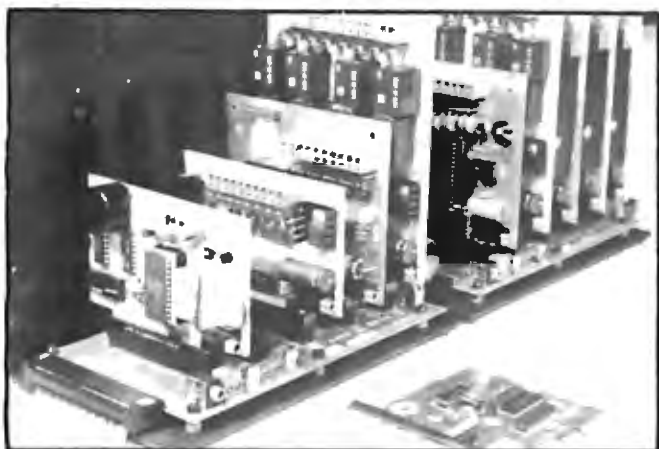

An A-BUS system with two Motherboards
A-BUS adapter (IBM) in foreground

Plug into the future

With the A-BUS you can plug your PC (IBM, Apple, TRS-80) into a future of exciting new applications in the of control, monitoring, automation, sensing, robotics, etc.

Alpha's modular A-BUS offers a proven method to build your "custom" system today. Tomorrow, when you are ready to take another step, you will be able to add more functions. This is ideal for first time experimenting and teaching.

A-BUS control can be entirely done in simple BASIC or Pascal, and no knowledge of electronics is required!

An A-BUS system consists of the A-BUS adapter plugged into your computer and a cable to connect the Adapter to 1 or 2 A-BUS cards. The same cable will also fit an A-BUS Motherboard for expansion up to 25 cards in any combination.

The A-BUS is backed by Alpha's continuing support (our 11th year, 50000 customers in over 60 countries).

The complete set of A-BUS User's Manuals is available for \$10.

About the A-BUS:

- All the A-BUS cards are very easy to use with any language that can read or write to a Port or Memory. In BASIC, use INP and OUT (or PEEK and POKE with Apples and Tandy Color Computers)
- They are all compatible with each other. You can mix and match up to 25 cards to fit your application. Card addresses are easily set with jumpers.
- A-BUS cards are shipped with power supplies (except PD-123) and detailed manuals (including schematics and programming examples)

Relay Card

RE-140: \$129

Includes eight industrial relays. (3 amp contacts. SPST) individually controlled and latched. 8 LED's show status. Easy to use (OUT or POKE in BASIC). Card address is jumper selectable.

Reed Relay Card

RE-156: \$99

Same features as above, but uses 8 Reed Relays to switch low level signals (20mA max). Use as a channel selector, solid state relay driver, etc.

Analog Input Card

AD-142: \$129

Eight analog inputs. 0 to +5V range can be expanded to 100V by adding a resistor. 8 bit resolution (20mV). Conversion time 120us. Perfect to measure voltage, temperature, light levels, pressure, etc. Very easy to use.

12 Bit A/D Converter

AN-146: \$139

This analog to digital converter is accurate to .025%. Input range is -4V to +4V. Resolution: 1 millivolt. The on board amplifier boosts signals up to 50 times to read microvolts. Conversion time is 130ms. Ideal for thermocouple, strain gauge, etc. 1 channel. (Expand to 8 channels using the RE-156 card).

Digital Input Card

IN-141: \$59

The eight inputs are optically isolated, so it's safe and easy to connect any "on/off" devices, such as switches, thermostats, alarm loops, etc. to your computer. To read the eight inputs, simply use BASIC INP (or PEEK).

24 Line TTL I/O

DG-148: \$65

Connect 24 input or output signals (switches or any TTL device) to your computer. The card can be set for: input, latched output, strobed output, strobed input, and/or bidirectional strobed I/O. Uses the 8255A chip.

Clock with Alarm

CL-144: \$89

Powerful clock/calendar with: battery backup for Time, Date and Alarm setting (time and date); built in alarm relay, led and buzzer; timing to 1/100 second. Easy to use decimal format. Lithium battery included.

Touch Tone® Decoder

PH-145: \$79

Each tone is converted into a number which is stored on the board. Simply read the number with INP or POKE. Use for remote control projects, etc.

A-BUS Prototyping Card

PR-152: \$15

3/8 by 4 1/2 in. with power and ground bus. Fits up to 10 I.C.s

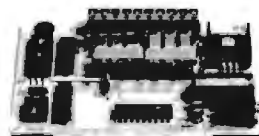

ST-143

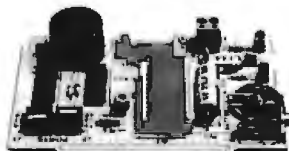

C1-144

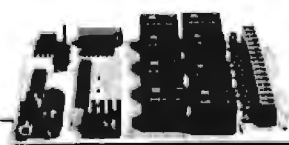

RE-140



IN-141

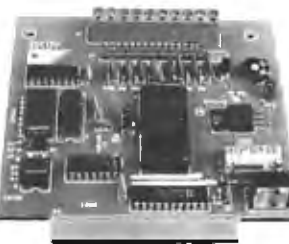

AD-142

Smart Stepper Controller SC-149: \$299

World's finest stepper controller. On board microprocessor controls 4 motors simultaneously. Incredibly, it accepts plain English commands like "Move arm 10.2 inches left". Many complex sequences can be defined as "macros" and stored in the on board memory. For each axis, you can control: coordinate (relative or absolute), ramping, speed, step type (half, full, wave), scale factor, units, holding power, etc. Many inputs: 8 limit & "wait until" switches, panic button, etc. On the fly reporting of position, speed, etc. On board drivers (350mA) for small steppers (MO-103). Send for SC-149 flyer.

Remote Control Keypad Option RC-121: \$49
To control the 4 motors directly, and "teach" sequences of motions.

Power Driver Board Option PD-123: \$89
Boost controller drive to 5 amps per phase. For two motors (eight drivers).

Breakout Board Option BB-122: \$19
For easy connection of 2 motors. 3 ft. cable ends with screw terminal board.

Stepper Motor Driver ST-143: \$79

Stepper motors are the ultimate in motion control. The special package (Stellar) includes everything you need to get familiar with them. Each card drives two stepper motors (12V, bidirectional, 4 phase, 350mA per phase). **Special Package: 2 motors (MO-103) + ST-143: PA-181: \$99**

Stepper Motors MO-103: \$15 or 4 for \$39

Pancake type, 2 1/4" dia. 1/4" shaft, 7.5°/step, 4 phase bidirectional, 300 step/sec, 12V, 36 ohm, bipolar, 5 oz-in torque, same as Airpak K82701-P2.

Current Developments

Intelligent Voice Synthesizer, 14 Bit Analog to Digital converter, 4 Channel Digital to Analog converter. Counter Timer, Voice Recognition.

A-BUS Adapters for:

IBM PC, XT, AT and compatibles. Uses one short slot.	AR-133...\$69
Tandy 1000, 1000 EX & SX, 1200, 3000. Uses one short slot	AR-133...\$69
Apple II, II+, IIe. Uses any slot.	AR-134...\$49
TRS-80 Model 102, 200. Plugs into 40 pin "system bus"	AR-136...\$69
Model 100. Uses 40 pin socket (Socket is duplicated on adapter).	AR-135...\$69
TRS-80 Mod 3, 4, 4 D. Fits 50 pin bus. (With hard disk, use Y-cable)	AR-132...\$49
TRS-80 Model 4P. Includes extra cable. (50 pin bus is recessed).	AR-137...\$62
TRS-80 Model I. Plugs into 40 pin I/O bus on KB or E/I.	AR-131...\$39
Color Computers (Tandy). Fits ROM slot. Multipak, or Y-cable.	AR-138...\$49

A-BUS Cable (3 ft, 50 cond.) CA-163: \$24

Connects the A-BUS adapter to one A-BUS card or to first Motherboard. **Special cable for two A-BUS cards: CA-162: \$34**

A-BUS Motherboard MB-120: \$99

Each Motherboard holds five A-BUS cards. A sixth connector allows a second Motherboard to be added to the first (with connecting cable CA-161: \$12). Up to five Motherboards can be joined this way to a single A-BUS adapter. Sturdy aluminum frame and card guides included.

Add \$3.00 per order for shipping.
Visa, MC, checks, M.O. welcome.
CT & NY residents add sales tax.
C.O.D. add \$3.00 extra.
Canada: shipping is \$5
Overseas add 10%



ALPHA Products

242-B West Avenue, Darien, CT 06820

Technical info: (203) 656-1806
Orders only
Except in CT 800 221-0916
Connecticut orders: (203) 348-9436
All lines open weekdays 9 to 5 Eastern time

Get Into Animation
Video Production
NOW!

ATTN: TARGA USERS

Find out about
the many options that
will turn your TARGA board
into a more versatile system.

Bring to life your TARGA images with dazzling motion and other spectacular effects. With the **CRAYON 2.5D ANIMATION** Program, any TARGA board with all its colors, can produce Broadcast quality animation to any videotape format.

Easy to learn, easy to use, and very fast, **CRAYON 2.5D ANIMATION** uses TIPS so there's no additional paint program to buy or learn.

Call: JANE JENKINS for brochure, demo-tape, and manual.

CRAYON COMPUTER CORPORATION

756 N. La Cienega Blvd., L.A., CA 90069
(213) 657-2322 Fax (213) 657-5658

Inquiry 77

UNITS	A	B	C	D	CMD TOTALS
READS	14	17	53	87	2734 0 104 2751
WRITES	3	7	95	1413	0 95 1413
TOTALS	14	17	0	182	4147 0 196 4164
OTHERS	0	0	5	0	0 0
MEMORY	10	0	259	0	269 319

The "WIZ" is a DISK I/O acceleration program for the IBM PC family which can unleash your disk-bound programs to run up to 10 times faster by caching thru RAM.

DISK WIZARD™ "WIZ" FEATURES

- Disk data write caching makes the WIZ at least twice as fast as the competition.
- A pop-up screen displays statistics in color for each disk unit.
- Supports up to 24 mb of cache in any mix of: Normal, EMS, or AT extended RAM.
- The WIZ will optionally cache floppy data, so your floppy only PC can really go!

Performance PC

2538 E. Terrace, #A, Anaheim CA 92806

\$59.95 (714) 666-2238 \$59.95

Plus \$3 S/H-Calif. res. add 6% tax - Int. orders add \$5

Inquiry 231

Let's talk PHONETICS

Is it **Laurie** or **Lawry**
or **Lowery** or **Lowry** or...

How does it spell exactly?
It **NO** longer matters with
PHONKEY

- Compact, easy to use phonetic coding module. Efficient even with files of 250,000 names.
- A call to PHONKEY analyses person's names and returns a 16 bit code that you store as a phonetic key to retrieve your data. At query time, compute the target name code, then retrieve all data with the same code. Easy enough?
- Interfaces with most MS-DOS programming languages (BASIC, FORTRAN, Pascal, Asm).
- Comes with a 1,300 names file and programs to test the accuracy of the algorithm.
- Create your own files and see the results.

\$69.95 Add \$5 for shipping and handling
VISA MC COD accepted

30 day money-back guarantee. NOT copy protected

SYBIS INC.

1600 St-Martin Blvd E., Tower A, Suite 610
Laval, Quebec, Canada H7C 4R8 (514) 662-2227

Inquiry 300

PC ← TCP/IP → UNIX

Networking for the IBM PC, AT, and compatibles with the ARPA TCP/IP protocol family, including Berkeley 4.2 enhancements.

- File transfer: *ftp, rcp, tftp*
- Remote login: *telnet, rlogin*
- Electronic mail: *smtplib, mail*
- Remote printing: *lpr*
- Remote execution: *rexec, rsh*
- Information: *finger, whois*

Requires 256K, 1 floppy, and one:

- Ethernet from 3COM, BICC, Excelan, Interlan, National Semiconductor, or Ungermann-Bass
- Token Ring from Proteon
- X.25 from Scope
- Serial line with IBM async port

Binary \$400; site licenses, programming libraries, and VARs available.

ftp Software, Inc.

P.O. Box 50
Kendall Square Branch
Boston, MA 02142
(617) 854-1711

Inquiry 366

Turn Your IBM PC
Or Compatible Into A

Hi-Res Video Character Generator

Video Overlay Board
\$1,695 or \$89/mo.
(Includes Software)

Video Technologies

The Company That Makes Professional Video Productions Affordable

Video Technologies

412 Wharf St. • Lake St. Louis, MO 63367 • 314-625-2404

Inquiry 329

P-tral
BASIC to Pascal

\$179

TRANSLATOR

Translate your BASIC source programs to Pascal source. P-tral, now available for the IBM PC and compatibles, will translate MS-BASIC/BASICA to Turbo Pascal (Req Dos 2.0 or later w/ANSI.SYS).

Also available for the Apple II series (incl. IIGS) and converts Applesoft to Apple Pascal.

(212) 206-6490 / 924-0576
WOODCHUCK INDUSTRIES
340 WEST 17TH STREET (#2B)
NEW YORK, NY 10011

Inquiry 342



REAL WORLD I/O Affordable Access To The Real World For PC/XT/ATs

Software programmable gains of 1,10,100. Utilizes a highly stable A/D converter. Excellent accuracy and high noise immunity. 7 digital I/O lines. Ideal for lab/industrial automation. **\$239**

AD100 • Single channel version of AD500 with 10 digital I/O lines. Same programmable gain and high noise immunity. Useful for transducers. ATE, education. **\$149**

DG24 • Digital I/O board with 24 TTL I/O lines configurable in software. 8255 PPI based. **\$95**

X840 • Extender board and cable for above boards. Includes easy connect terminal strip and prototype area. **\$49**

Software examples in Pascal, BASIC, Forth and Assembly.

Complete documentation and money back guarantee.

Real Time Devices, Inc.

rted

1930 PARK FOREST AVENUE
P.O. BOX 906
STATE COLLEGE, PENNSYLVANIA 16804

(814) 234-8087

Inquiry 266

PC SOFTWARE

Public Domain & User Supported

PC-Stack (Stack Trend Analysis) **\$600 Ea.**
DiskTool (Disk modification utility)
PC-Tickle (Disk calendar/reminder)
PC-Write 2.7 (Word processor with spell checker)
Imageprint (Better quality from Epson/Oki data printers)
Landing Party (Adventure with your favorite characters)
PC-Accounting (2 disks-single entry accounting)
Ham Radio #1/RTTY/ASCII, Sat location, and more!
FT-ETC Genealogy (Produces several types of charts)
Symphony WKS #1 (Bank, Insurance, & Medical Applic.)
123 Macros (A lot of 123 macros!)
PC-Prompt (Memory resident DOS help utility)
Mr Bill (2 disks-Professional Time Billing)
Label Master Mail List Management System
Misc. Games (Quarterback, Babes, Flightmare, Soviet & More!)

Try a Six-Pac

any six disks only \$29.95
(all orders add \$3.00 shipping & handling)
(credit card orders welcome, \$10.00 min. please)
Call or write for FREE catalog.

The above programs were written for the IBM-PC & PC-jr. will run on some compatibles. Be certain of compatibility before ordering.

Soft/Plus Research
759 S. State St., Ste. 109

Ukiah, CA 95482

(707) 462-3118

(800) 843-3882

Inquiry 290

Motion Control & Data Acquisition



on your IBM PC or Apple II
and all compatibles

Smart 2 Axis Motion Controller: For many types of motors & encoders. New I.C. (from HP) allows changes & monitoring on the fly. Optically isolated. SOFTWARE \$400.

Four Axis Stepper Driver: With SOFTWARE & motor for instant automation. \$95.

Fast A/D Board: With programmed gain, 650 KHz, 4 inputs \$220. Complete Scope hardware & SOFTWARE \$500. Also: 12 Bit A/D, Relay Driver, Real Time Clock. Circuit developers Project Book \$25.

How do you do it? Use our Local Applications Bus, LAB 40. One host adapter (\$150) supports up to 8 boards, like those above, on a 50 ft. ribbon cable.

Please call (415) 755-1978 for free literature.

Computer Continuum

75 Southgate Ave., Suite 6
Daly City, CA 94015

(415) 755-1978

Inquiry 300

ACP Has It All!!

CLOSEOUTS! SUPPLY LIMITED!

SHARP PC5000 Laptop	\$199.00
3M DC100A Data Cartridge	12.85
3M DC300A Data Cartridge	14.85
256K Intelligent Buffer	169.00
Quadboard II w/64K	89.95
Rixon 1200 Baud Modem (int.)	88.00
STB R10 w/64K	89.95
STB Super Res 400 Color	249.95
Orchid PC Turbo 186 w/128K	99.00
Orchid PC NET Blossom w/64K	195.00
Q&A IBM Software/New Vers.	249.00
6 Slot IBM Expansion Box	149.95
MacLion Database (400K) Mac	11.88
Data Products 8050C	
Color Printer (OEM)	595.00
AST I/O Plus/XT	59.95
Persyst SB-III Multi-I/O	119.95
Persyst EG-8 EGA Card	159.95
Persyst Mono or Color Combo	99.95
Bernoulli Dual 20Mb (refurb)	1499.00

WHILE STOCK LASTS!

IF YOU DON'T SEE WHAT YOU NEED...CALL US!!

IBM® COMPATIBLE CARDS



Largest Selection!!

A210 Color/Printer/Graphics	\$ 69.00
A240 Mono/Printer/Graphics	79.00
A250 Mono/Printer/Graphics/132 col.	59.00
A261 Mono/Graphics/Printer-Short Card	68.00
A271 EGA/256K RAM-Short Card	169.00
A272 EGA Genoa Compatible	269.00
A320 384 Multifunction Card-OK RAM	89.95
A340 Multifunction/Floppy	89.95
A350 640K RAM Card-OK RAM	59.00
A410 Floppy Card-2 Drives	29.00
A410 Floppy Card-4 Drives	39.00
A510 Parallel/Serial/Optional Serial	59.95
A520 Parallel Card	35.00
A530 Serial Card	49.00
A610 AT 2Mb Multi-function-OK	89.95
A620 AT 3Mb RAM Card	89.95
A630 AT Parallel/Serial/Optional Serial	59.00
A640 AT Floppy/Hard Controller	199.00
A650 AT I/O Card-Ser/Par/Clk	55.00
A950 AT Motherboard-DK	399.00
A960 XT Motherboard-DK	99.00
A970 XT Turbo Motherboard-DK	119.00
A980 AT Mini Motherboard	399.00

AST

AT Advantage/6MHz/1.5Mb	\$489.00
AT Advantage/6MHz/3 Mb	699.00
Rampage AT/6MHz w/OK	299.00
Rampage AT/6MHz w/512K	359.00
Rampage AT/6MHz w/2Mb	549.00
Preview I/O 6MHz XT/AT	169.00
AST-3G PLUS "EGA"	188.00
Sixpack Premium w/256K	299.00
Sixpack Premium EGA	599.00
Sixpack PLUS/OK	169.00

SPECIAL! SPECIAL! SPECIAL! SPECIAL!

Knight Security Software	149.00
COMBO PLUS/64K	69.00
5251/11	579.00
5251/12	499.00
5251/11 Plus	649.00

COMPUTERS

Zenith Z-148 Bundle	\$94.00
Zenith Z-181 Laptop	1749.00
Zenith Z-158 XT Bundle	1499.00
Advanced 286 6/10 MHz AT	1288.00
AST Premium AT	CALL
AST Turbo Laser	3995.00

DCA

Irma	\$789.00
------	----------

HARDWARE

HAYES (2 Yr. Warranty)

1200 RS-232 External	\$366.00
1200B w/SMARTCOM I (INT.)	344.00
2400 RS-232 External	569.00
2400 w/SMARTCOM II (INT.)	499.00
Migent Pocket Modem	149.00
Capelronic Wall Mount 1200	119.00
Cross Talk XVI	149.00
Hayes Compatible (Ext.)	98.00
Hayes Compatible (Int.) 1200B	98.00
Hayes Compatible (Ext.) 2400B	239.00

HERCULES

Hercules Color Card \$186.00
NEW! NEW! NEW! NEW! NEW!
Hercules Plus Graphics 239.00

INTEL (5 yr. Warranty)

Above Board PC/XT 64K	CALL
Above Board AT 128K	CALL
Inboard 386/AT	1488.00

KEYTRONICS

5150 Keyboard	\$159.95
5151 Deluxe Keyboard	189.95
5153 Deluxe Keyboard w/Touchpad	285.95
PC Jr. Numeric Keypad	29.95

Advanced Keyboards

ACP 5150 Keyboard	58.95
ACP 5151 Deluxe Keyboard	79.95
ACP 5160 AT/XT Keyboard	66.95
ACP 5152 XT/AT Keyboard	79.95

MEMORY

64K (9) 150ns	\$ 9.95
64K (9) 120ns	11.95
256K (9) 150ns	26.95
256K (9) 120ns	32.95
256K (9) 100ns	39.95
1Mb Chip 100ns	Ea. 33.95

CO-PROCESSOR

8087	\$105.00
8087-2	145.00
80287-6	165.00
80287-8	260.00
80287-10	449.00
V20-8MHz	9.95

MICROSOFT

Microsoft Mouse	\$139.00
Microsoft Bus Version	155.00

MOUSE SYSTEMS

(3 Yr. Warranty)

PC Mouse w/Paint Plus	\$138.00
PC Mouse w/Ready & Paint	148.00
ACP Mouse w/Keyboard	SALE! 99.00

QUADRAM

Silver Quadboard PC/XT	\$129.95
Liberty PC/XT OK	169.00
Liberty 2 Mb	408.00
Quadprint PC/XT Accelerator	199.95
Quad EMS I/O + 256K	339.00

PRINTERS

BROTHER

M2024L (24 Pin)	Sale \$699.00
M1109 100CPS	189.00
M1409 45 cps NLO	358.00
M1509 45 cps NLO	489.00
M1709 50 cps NLO	589.00

EPSON (3 Yr. Warranty)

EX 800 250 cps/50 cps NLO	\$499.00
EX 1000 Wide Carriage	679.00
FX86E 160 cps NLO	388.00
FX286E 160 cps Wide	529.00

TOSHIBA

P321 "3 in 1" 24 Pin LQ Printer	\$479.00
P341E 24 Pin/216 cps	659.00
P351-C Color	1195.00
P351 Model 2	1075.00
T1100 & T3100	CALL

LIMITED SPECIAL!

8 PEN PLOTTER

Roland's DXY-800 Flatbed X-Y Plotter, including Parallel/Serial Interface.

IBM Compatible	NOW ONLY \$499.00
DXY 101 Pen Plotter	299.00

EGA SPECIALS

EGA Monitor plus Upgrade Card	\$519
NEC Multisync plus EGA Card	\$749

SUPER AT VALUE

SHOWN WITH OPTIONAL MONITOR AND SECOND DISK DRIVE



SUPER SALE!
\$1166.

List \$2995.00

100% SATISFACTION GUARANTEED!

MONITORS

Amdek 310A TTL	\$155.00
NEC Multisync	599.00
Princeton MAX-12 TTL	179.00
Samsung TTL IBM Green/Amber	88.00
TECO CGA Monitor	299.00
TECO EGA Monitor	399.00

TAXAN

760 EGA Monitor 14"	\$550.00
660 EGA Monitor 12"	540.00
560 EGA Card w/Autoswitching	299.00

SPECIAL! SPECIAL! SPECIAL! SPECIAL!

560 EGA Plus	
EGA Monitor 660 or 760	749.00

MORE EGA...

Advanced EGA/256K/Short Card	\$169.00
ATI EGA Wonder	289.00
Genoa EGA	319.00
Paradise Autoswitch	349.00
Quad EGA Plus/Quadram	299.00
RIX EGA Paint	59.00

PGA SPECIALS

IBM Professional, Limited Quantity IBM PGA Card, Regular \$2995.00	SALE \$995.00
--	---------------

HARD DISC CARDS

Filecard 20 Western Digital	\$479.00
Filecard 30 Western Digital	588.00
10 Mb Drive only	149.00
21 Mb XT Subsystem WD	388.00
21 Mb XT Subsystem CMI/Tandon	366.00
21Mb XT Subsystem Seagate ST225	388.00
30 Mb XT Subsystem Seagate ST238	499.00
30 Mb AT Drive (40MS.) ST4038	469.00
40 Mb AT Drive (40MS.) NEC 5046	599.00

CALL FOR HIGHER STORAGE DRIVES!

3-1/2" DRIVES HARD DISKS

10 Mb 3-1/2" Drive/Rodine equiv.	\$188.00
20 Mb 3-1/2" LaPine LT200	299.00
30 Mb 3-1/2" LaPine LT300	359.00

BEST BACK-UP!

Use the same back-up device we use at ACP

AlphaMicro VCR Backup Card	\$399.00
AlphaMicro VCR	899.00

DISK DRIVES

ACP IBM Drives DS	\$ 69.95
Toshiba FD04403 3-1/2" w/Kit	129.00
Toshiba ND040 PC/XT 360K	95.00
Toshiba ND04E-G AT 360K	105.00
Toshiba ND08DE-G 1.2Mb	129.00
TEAC FD-55B	99.00

DISKETTES (BOX OF 10)

DS/DD for PC/XT (40tpi)

• ACP Generic	\$ 6.00
• Verbatim Datalife	14.95
• Maxell MD-2	14.95
• Fuji	14.95
DX/Hi-Density for AT (96tpi)	
• Verbatim	26.95
• Maxell	26.95
• Fuji	26.95
SS/DD for Apple II/etc.	
• Verbatim/Maxell/Fuji	12.95
• Macintosh/IBM Conv. 3-1/2"	
• Maxell MI-2DD	26.95
• Fuji MF-2DD (135tpi)	26.95

MORE ACCESSORIES...

Flip-Soff (holds up to 75 disks)	14.00
ACP 5-1/4" Disk Holder	9.00
ACP 3-1/2" Disk Holder	12.00
Head Cleaner 5-1/4" or 8"	9.00
PERFECT COMPUTER CARE Kit	19.95



SHOWN WITH OPTIONAL MONITOR

SUPER VALUE!
\$588.

Advanced PC/XT

...over 4000 Satisfied Customers!

Manufactured by Toshiba. This is the finest IBM compatible manufactured today...we can prove it!

- FCC/UP Approved
- Serial/Parallel/LCD
- Mouse & Keyboard
- 256K easily expandable to 640K
- 10Mb Hard Disk/ Add \$300.
- (1) 360K Floppy
- Composite Video
- RGB Color Graphics
- 20Mb/ Add \$401.

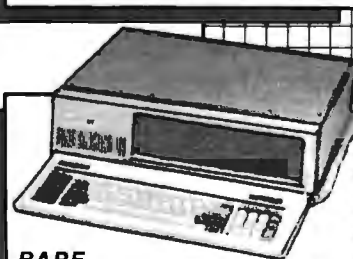

BARE BONES PRICE!!
\$299.

Advanced 8 MHz XT Turbo

- 4.77/8MHz Switchable
- 0K. expandable to 640K
- XT/AT Deluxe Keyboard
- Phoenix BIOS
- Runs all Major software written for IBM
- Zinc-lined FCC Case
- 150W Power Supply
- 90 DAY WARRANTY

Advanced Computer Products Inc.

TOLL FREE

800-854-8230

CA Residents 714-558-8813

OUR POLICY

- No Surcharge for VISA or Mastercard. Inquiry 7
- Volume purchasing agreements available.
- Orders subject to availability. • Supply limited on certain items.
- Pricing subject to change without notice.
- ACP Retail Store pricing may vary. Not responsible for typos.

Mail Order: P.O. Box 17329 Irvine, CA 92713

Retail: 1310 B E. Edinger, Santa Ana, CA 92705

CORPORATE BUYERS - CALL
GILLES, PHIL, MIKE or DAVE

DISK-KING®

DEALER/OEM's WELCOME!

WHY RISK THE UNKNOWN...when you can get premium quality disks from the Leader and Inventor of magnetic media...for less!!

- *100% tested & certified at 65% or higher clipping level*
- * 10 mil sturdy jacket * LIFETIME WARRANTY *

5.25" Diskettes: **3M/BASF**
Color Disk No-Logo

DS-DD-48 TPI	49	43
DS-DD-RH-48 TPI		52
DS-HD-96 TPI for AT	1.39	1.05

3.5" Diskettes:

DS-135 TPI	1.49	1.20
------------	------	------

All 5.25" diskettes are supplied with Tyvek® sleeves, color-coded ID labels, w/p tabs. Pre-packaged in plastic library case for \$1.50 extra per box. Color Disk in 14+ different colors to choose from or Rainbow assortment. Private labeling & Software duplication services available. Made in the USA



SS-DD-RH	*bonus product & rebate inside while supplies last.	DS-DD-RH
.79*	5.25"/148 TPI-10/bx.	.85
1.15	3.50"/135 TPI-10/bx.	1.69
DS-HD-96 TPI for the "AT"-10/bx.		1.79
DC-1000	DC-300XLP	18.75
DC-2000	DC-600A	20.65
3M Blackwatch® Tape 2400' w/seal from		11.95 min. 10 reels
3M Headcleaning Kit for 5.25"		6.99

BASF

*FREE!
Color-Coded Modular Flexy Files a \$19.95 value!

5.25" DS-DD SB-10/BX	.75
5.25" DS-DD in *Minidex/60	.79
5.25" DS-HD for the "AT" SB-10/BX	1.49
3.50" DS-135 SB-10/BX	1.49
3.50" DS-135 in *Microdex/25	1.69
5.25" DS/DD 96 TPI SB-10/BX	1.29
8.00" DS/DD x 1024 SB-10 BX	1.89
BASF Computer Tapes-2400' w/seal fr.	10.95
BASF 3480 Chrome Tape cartridge from	9.95

Nashua BULK

DISKETTES 5.25" DS/DD

5.25" DS-DD 10/bx	.54	As low as .33 qty 1000+
5.25" DS-HD 10/bx	1.45	Certified 100% 39¢(100)
3.50" DS-HD 10/bx	1.45	Error-free. Exceed ANSI 36¢(500)
5.25" DS-DD96TPI 10/bx	1.29	specs. Lifetime warranty. USA made. TYVEK® sleeves. Labels & w/p tabs

RIBBONS STORAGE

Epson MX/RX/FX70/80/95	2.59	3M Discover 50	6.99
Epson MX/RX/FX 100/185	3.49	3M D/Defender070 w/kye	13.95
Epson LQ1000	3.99	3M Data Defender050	13.95
Epson LQ1500	4.59	Amaray Media Mate 50	8.90
Diskdata Twin Spool	1.09	Amaray Micro Mate 3	8.70
Okidata 182/192/193	3.99	Plastic Library Case	1.50
Apple ImageWriter	2.75	Micro Disk Minder 36	8.70
IBM Proprietary	2.99		
Brother HR 15/25 M/S	3.99		
Panasonic KXP	4.99		
NEC 3500 M/S	3.99		

ACCESSORIES

500 1000
055 039

TERMS: Minimum order \$35.00 or case lot Qty less than case lot add 10%. VISA, Mastercard, AMEX, C.O.D., Prepaid 2% cash discount. PO's on net 30 basis from recognized institutions & corporations. No sales tax outside Utah. SHIPPING: \$4.00/100 or fewer disks APO/FPO, AK, HI, PR & CN \$9.00/100 or fewer disks for air-freight plus insurance. Reduced shipping charges on larger quantities. Overseas order, please call for exact freight charges & terms.

TELEX - 9102404712
Toll-Free Order Line: 1-800-523-9681
Inquiries Line: 1-801-942-2273

DISK-COTECH

DISKCO TECHNOLOGIES, INC.
2034 E 7000 So Salt Lake City, Utah 84121
Hours: 8 AM-6PM (Mtn. Time)-Half day Saturday

TURBO 10MHz 1MB AT/XT



OPEN 7 DAYS

TURBO AT \$1,199 \$1,899 w/ SEAGATE -- 4039 30MB HAFES SMART SCREEN AMBER MONITOR • INTEL 80286/10 MHz • ONE MB 20NS RAM ON BOARD • PHENIX 2.0 BIOS • HERCULES EMULATION GRAPHICS CARDW PARALLEL, SERIAL PORTS • OPERATES MS-DOS, PC-DOS, XENIX, UNIX ON BASIC • 8 SLOTS • VIO CONTROLLER 2FD2HD • ENHANCED KEYBOARDW LEGS • 200 WATTS POWER • 1.2 MB 1540 FLOPPY • ON BOARD CLOCK/CALENDAR • HARDWARE RESET • 8029 SOCKET • OPTIONAL EGA OR COLOR • OPTIONAL 4" W/ VERT SWIRE OR 12 MHz • FULLY SET UP TESTED • MANUALS • ONE YEAR PARTSLABOR

TURBO XT \$699 \$999 w/ SEAGATE 20 MB & ONE FLOPPY HAFES AMBER MONITOR • INTEL 8086/2 OR NEC V20 OPTIONAL 10MHz 33% FASTER THAN IBM PC • BULK ON BOARD • FULLY COMPATIBLE BIOS • HERCULES EMULATION GRAPHICS CARDW PARALLEL PORT • OPERATES MS-DOS, PC-DOS ON BASIC • 8 SLOTS • BULK 10 CARD, 2 FD CONTROLLER, 2 SERIAL, 2ND OPT'L PARALLEL, CAVE, CLOCK/CALENDAR, BATTERY, RAM DISK, PS/200, AT KEYBOARDW LEGS • 80 WATTS • 1 W/30K RUFUS DRIVES • 8097 SOCKET • MANUALS • FULLY SET UP TESTED • ONE YEAR PARTSLABOR

PORTABLE XT/AT SYSTEMS ALSO AVAILABLE
PCPRO SYSTEMS INC.
800-451-5279
135 W 26TH ST, 8TH FL. NEW YORK, NEW YORK 10001 (212) 627-4485
699 S WARNER ST, STE. 294 HUNTINGTON BEACH, CA 92642 (714) 491-5279

Inquiry 225

RS-232C/422A USERS: BI-DIRECTIONAL CONVERTER for EXTENDED USE

Convert RS-232C to RS-422A and/or RS-422A to RS-232C only \$49.95



Guaranteed satisfaction. Bi-directional, first-quality, versatile converter. Extends cable lengths up to 4,000 feet! Bit rates up to 90K Baud. (Two B & B RS-422C/DN Converters can extend your RS-232C capability up to 4,000 ft.)

Includes male DB25P connector for RS-232C and includes female DB25S connector for RS-422A. No handshake interconnection.

Requires 12V DC at 100 ma. Optional power supply available for only \$14.95.

Order Direct from Manufacturer TODAY and SAVE! SAME-DAY SHIPMENT! MONEY-BACK GUARANTEE!

Request our FREE catalog listing B & B ELECTRONICS' comprehensive line of RS-232C interface and monitoring equipment.

*Terms: Visa, MC, cash orders postpaid. P.O.'s from qualified retail firms accepted. IL residents add 6 1/4% sales tax.

B & B electronics MANUFACTURING COMPANY

1502F Boyce Memorial Drive • P.O. Box 1008 • Ottawa, IL 61350

Phone: 815-434-0846

Inquiry 43

IBM PC:* Relay Control Card

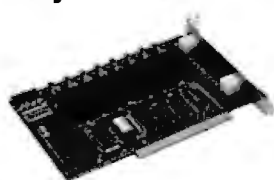

Control All Types Of Electrical/Electronic Devices

- Motors & Heaters
- Solenoids & Lamps
- Security Devices
- Temperature Controls
- Fans/Blowers
- Energy Controls

Fully Addressable (Basic Program Available on Walk-Thru Disk)

8 1 Amp Solid State Contacts
40-280 VAC Switching

ORDER NOW
Type 8603 \$149.00
Fuses and LED Indicators Optional

*Registered Trademark of IBM Corp



42 Pleasant Street Stoneham, MA 02180 (617) 438-5300

Inquiry 99

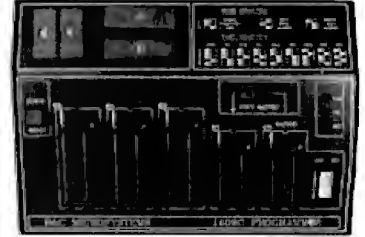

UNIVERSAL EPROM PROGRAMMER \$495!!

- Built in timer eraser optn; foam pad area
- Menu selection; No personality modules
- User friendly softw; Complete help menu
- Direct tech. support; Full 1 yr. warranty
- Stand alone duplication & verify;
- Quick pulse algorithm: 27256 under 60 sec
- All 24/28 pins to 27011 & CMOS E(E)PROMS
- Micros: 8741, 2, 4, 8, 9, 51, 52, 55, 9761 & CMOS
- Auto baud RS232 to 19.2k; Free PC drivers
- Orset/split Hex, Binary, Intel & Motorola 8, 16 & 32 bit files; Kits from \$95!

B&C Microsystems

355 W. Olive Ave, Sta. 103, Sunnyvale, CA 94086
• Ph 408-730-5511; 800-642-7617 Visa & MC

Inquiry 45

100MHz Logic Analyzer Card

For PC/XT, PC/AT Monochrome & Color Card Systems \$1199

- 24 Channels at 25KHz - 25 Mhz
- 6 Channels at 100 Mhz
- Internal Clock up to 100Mhz
- External Clock up to 25Mhz
- Threshold Voltage TTL, ECL, or variable from -10 to +10V
- All New Version 2.0 Software
- Available as separate card or as complete portable PC System.



PAL/EPROM Programmer Card For PC/XT/AT Systems



- Programs 20 and 24 Pin MM, NS, TI PALs
- Programs Eproms from 2716 to 27512 and 27512A
- Software Functions Include: Read, Write, Verify, Protect, Edit, Print, and File Save and Load of Program.
- All Software included

\$399

CALL NOW FOR ORDERS AND TECHNICAL INFORMATION (201) 994-6669
Link Computer Graphics, Inc. 4 Sparrow Dr., Livingston, NJ 07039

Inquiry 163

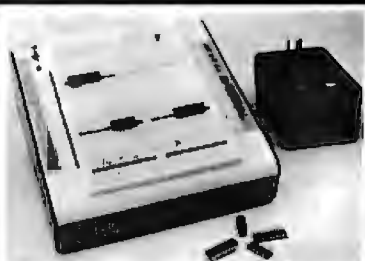

DESIGN & TEST CIRCUITS USING IBM PC

The Personal Protosystem is a multi-purpose interface for the IBM PC. Inexpensive enough for data acquisition and control, but useful for much more. Perfect for prototyping and educational applications.

- 2 ADCs • 2 DACs • 32 TTL I/O Bits
- 4 MHz Clock • 3 Programmable Counter/Timers.

\$595 Software and power supply included.

For details call or write:
Ajida Technologies, Inc.
613 Fourth Street
Santa Rosa, CA 95404
(707) 545-7777
Telex: 910-240-2206

Inquiry 11

California Digital

17700 Figueroa Street • Carson, California 90248



FOUR PEN COLOR PLOTTER **\$159**

The manufacturer has asked us not to publish their name. But this four color plotter was produced by one of the World's largest makers of computers. The 410 color plotter will connect to the serial port of virtually any micro-computer. Simple ASCII commands direct one of the four color pens to draw circles, arcs or ellipses on paper or transparency material up to 11 by 17 inches. The plotter is capable of producing the full upper and lower case alphabet along with seven international character sets. Text can be printed horizontal, vertical or diagonal in sizes from 1/16 to 6 inches.

Enlargements or reductions are achieved through elaborate firmware. Pen travel is four inches per second with .004" pen resolution. Standard pens are available in an assortment of 32 different colors and widths.

The ideal plotter for architecture, CAD engineering or graphic design. At \$595 it was a great buy, at \$159 its a steal. Support packages for specific computers available. Manual only \$15 refundable upon purchase of plotter

OTHER PLOTTERS AVAILABLE:

Hewlett Packard • Houston Instruments • Roland Sweet P • CalComp... please call for prices.



\$2495
\$759

80 Character Daisy Wheel Printer

These Fujitsu Daisy Max 830 were manufactured for Motorola's Computer Division. The purchase order was canceled and Fujitsu was forced to liquidate these 80 character per second daisy wheel printers at "fire sale" prices.

Features: bullet proof construction, serial RS-232 interface, Diablo 630 wheels and commands, programmable line spacing in increments of 1/96" and column spacing of 1/120". The printer is also capable of underlining, boldoverprint, shadowprint, centers and justifies along with vector plotting.

Factory suggested price of the Daisy Max 830 was \$2495, while supplies last California Digital is offering this liquidated special at only \$759. Also available: tractor and sheet feeders.

COLOR GRAPHICS TERMINAL

\$3985
\$659



The Lear Siegler 7107 color graphics terminal is both DEC (VT-100 / VT-51) and Tektronix (4010/4014) compatible. The terminal offers a palette of 4,096 colors with a resolution of 640 by 480 pixels on a 13 inch non-glare black screen. Horizontal pan and image zoom, to 16 times original size, are standard features of this color graphics terminal. The 7107 is the ideal terminal for CAD/CAM applications.

NOW YOUR COMPUTER CAN READ!

Omni-Reader... the first optical character reader designed and priced for the small computer

\$179

COPY:

• Manuscripts • Contracts • Articles • Forms • Invoices

APPLICATIONS:

• Mailing Lists • Editing • Data Base Management • Transferring Information between incompatible systems



Users a standard RS-232 serial port hookup to interface easily with your computer



HEWLETT PACKARD LASER JET II **\$1895**

New from Hewlett Packard the LaserJet Series II. More features than the LaserJet but at a much lower price.

Standard on the Series II is 512 Kbyte memory expandable to 4 Megabytes, both serial and parallel ports. List price \$2495 California Digital price \$1895. Memory upgrade, type fonts and toner cartridges available.

Other Laser Printers available:

Te as Instruments • Okidata • Apple • Ricoh • Qume • AST Research • QMS • Xerox • Canon • Quadram • Centronics • CIE C.toh • DataProducts



\$35

We have them again... The Remex 480 was a sell out two years ago but we located an additional 10,000 units and are offering these 2/3 height IBM/PC compatible 360K/Byte drives at only \$35 each at quantity two.

\$85

The Mitsubishi 4851 was probably the best 360 K/Byte drive ever produced. The production cost was too high and Mitsubishi discontinued the product. Quantity two \$85 each.

\$115

The Panasonic 475 is jumper selectable between 96 TPI format and 1.2 Megabyte as used in the IBM AT computer. Suggested price of the 475 is \$189 but California Digital located a computer manufacturer that had to liquidate stock making available 1000 of these choice drives. Quantity two \$115 each.



Bernoulli Box was \$3540 now only **\$1595**

The Bernoulli Box by Iomega, features 10 and 20 megabyte removable cartridges, and delivers reliability, expandability, transportability, security and speed in one versatile subsystem. It lets you transfer megabytes of information safely and swiftly for primary or backup storage. Or combine several software programs onto a single cartridge for easy switching from one to another.

Reliable... the Box has incredible resistance to shock and vibration completely eliminating the possibility of head crash.

Expandable... grow at your own pace by adding inexpensive cartridges. When security is essential, don't lock up your system... just lock up the cartridges.

The Bernoulli Box delivers performance that often exceeds the best of hard disk speed and the convenience of floppy disks. At these prices don't be caught wishing you had one after a loss of irreplaceable data.

	List	Our Price
10+10 Meg.	A2210H \$3450	1595
20+20 Meg.	A2220H 4540	2095
Bootable Controller		255
10 Meg. Cartridge		79
20 Meg. Cartridge		49



Smarteam 2400 Baud **\$289**

The Smarteam 2400 offers all the features of the Hayes Smart Modem 2400 for a fraction of the price. Now is your opportunity to purchase a 2400 baud modem for only \$289.

Also available: The Smarteam 1200 at only \$139



U.S. Robotics \$189
2400 Internal

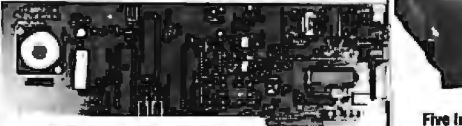

The US Robotics Micro 2400 modem is one hundred percent Hayes compatible, auto dial, auto answer, auto everthing. A super value at only \$189



\$99

This 300/1200 baud modem matches design specs of Bell 212A and for all practical purpose those of the Hayes Smart Modem. The Avatec brings you reliable data transmission for only \$99.

OTHER MODEMS AVAILABLE:

Hayes • Universal Data • Fujitsu • Promethea • Anchor • US Robotics



Seagate \$459
30 MEGABYTE WINCHESTER HARD DISK KIT



Five Inch Winchester Disk Drives

SEAGATE	each	hw +
225 20 Meg. 1/2 Ht.	319	299
236 30 Meg. RLL	369	359
4026 25 M. 35mS.	659	629
4051 51 M. 35mS.	759	739
FUJITSU 2242 55 M. 35mS.	1399	1329
FUJITSU 2243 86 M. 35mS.	1899	1819
RODIME RD-202E 27 Meg.	659	629
RODIME RD-283E 40 Meg.	695	659
RODIME RD-204E 53 Meg.	995	859
CONTROL DATA 94155-85 M	1829	1779
MAXTOR XT1140 140 Meg.	2595	2529
TOSHIBA MK5670 M. 30mS.	1789	1729
TANDON 502 10 Meg.	419	379

• Winchester Controllers for IBM/PC •
 XEBEC 1220 with floppy controller 229
 DTC 5150CX 139
 OMTI 5520 half card 129
 OMTI 5527 RLL controller 159
 ADAPTEC 2070 RLL controller 179
 ADAPTEC 2010A 159
 WESTERN DIGITAL WD/1002Wx2 119
 • SCSI/SASI Winchester Controllers •
 XEBEC 1410A 5 1/4" foot print 219
 WESTERN DIGITAL 1002-05E 5 1/4" 289
 OMTI 20L 119
 • Winchester Accessories •
 Installation Kit with manual 10
 Winchester enclosure and supply 139
 Dual 20/34 cable set 25
 Switching power supply 49

	One	Two	Ten
REMEX 480 3/4 height for PC	39	35	call
MITSUBISHI 4851 360K/Byte	89	85	82
MITSUBISHI 4853 96 TPI.	99	95	82
MITSUBISHI new 501 half ht.	129	119	109
MITSUBISHI 504A AT comp.	169	159	155
TEAC FD55BV half height	109	99	89
TEAC FD55FV 96 TPI, half ht.	119	109	105
TEAC FD55GF for IBM AT	169	159	155
PANASONIC 455 Half Height	109	99	89
PANASONIC 475 1.2 Meg./96	119	115	109
Switching power supply			49
Dual enclosure for 5 1/4" drives			59



SONY \$139

The Sony 53W is a 3 1/2 inch double sided double density disk drive. The drive can be connected to your existing floppy controller but will require MS/DOS 3.2 to properly operate in the PC and compatibles. The 53W is similar to the drive being used in the PC portable.

Shipping: First five pounds \$3.00, each additional pound \$5.00. Foreign orders: 10% shipping, excess will be refunded. California residents add 6 1/2% sales tax. • COD's discouraged. Open accounts extended to state supported educational institutions and companies with a strong "Dun & Bradstreet" rating.

TeleFax
(213) 217-1951

TOLL FREE ORDER LINE
(800) 421-5041
TECHNICAL & CALIFORNIA
(213) 217-0500



Worldwide • Since 1974

• QUALITY COMPONENTS • COMPETITIVE PRICING • PROMPT DELIVERY

Mail Order Electronics • Worldwide
Jameco
ELECTRONICS

COMMODORE COMPATIBLE ACCESSORIES



HESWARE 300 Baud Modem

FOR VIC-20 AND C-64

• Connects directly to User Port • Manual Answer/Dial • Function keys defined for convenience • Includes Midwest Micro Associates communication software.

CM-1 (For VIC-20 and C-64) ~~\$34.95~~ \$24.95

External Power Supplies

CPS-10 (For C-64) \$39.95
CPS-128 (For C-128) \$59.95

RS232 Interface

Allows connection of standard serial devices.
JE232CM (For VIC-20, C-64 & C-128) . . . \$39.95
*Operation with the C-128 in 64 mode only.

TRS-80/TANDY COMPATIBLE ACCESSORIES

E-X-P-A-N-D TRS-80 MEMORY

All kits come complete with documentation

TRS-80 MODEL 4, 4P & 4D 64K/128K EXPANSION
TRS-64K-2 \$7.95
Expands Model 4 from 16K-64K or Model 4 (Gate Array Version), 4P and 4D from 64K-128K

TRS-64K-2PAL \$14.95
Expands Model 4 (Non-Gate Array Version) from 64K to 128K

TRS-80 MODEL 100 8K EXPANSION
M1008K \$19.95 ea. or 3 for \$54.95

ZUCKERBOARD

TANDY 1000 Expansion Memory Half Card

Expand the memory of your Tandy 1000 (128K Version) to as much as 640K. Also includes DMA controller chip.

TAN-EM256K Includes 256K RAM \$ 99.95
TAN-EM512K Includes 512K RAM \$119.95
TAN-C Plug-In/Clock option chip (only) \$39.95

NEW! 20Meg Hard Disk NEW!

T20MB 20MB Hard Disk Drive Board for Tandy 1000. \$579.95

SX20MB 20MB Hard Disk Drive Board for Tandy 1000SX. \$589.95

TANDY 1000 Multifunction Board with Clock Calendar

Expand the memory on your Tandy 1000 (128K Version) to as much as 640K. Complete with an RS232 port, clock/calendar, RAM Disk Printer Spooler and on-board DMA controller chip.

MTAN-256K Includes 256K RAM \$179.95
MTAN-512K Includes 512K RAM \$199.95

NEW! Multifunction Board for TANDY 1000SX NEW!

M256K Includes 256K RAM. \$189.95

UV-EPROM ERASER

Erases all EPROMs. Erases up to 8 chips within 21 minutes (1 chip in 15 minutes). Maintains constant exposure distance of 1". Special conductive foam liner eliminates static build-up. Built-in safety lock to prevent UV exposure. Compact - 9.00" L x 3.70" W x 2.60" H. Complete with holding tray for 8 chips.

DE-4 UV-EPROM Eraser. \$69.95
UVS-11EL Replacement Bulb. \$19.95
NCF-2 Cond.Foam 12x24x1/2 Hard Blk. \$ 8.95

NOW YOU CAN BUILD AN IBM PC/XT COMPATIBLE!

IBM Compatible Kit No. 2

IBM-64K(2)	64K RAM Chips (18) . . .	\$ 19.90
KB5160	AT Style Keyboard	\$ 59.95
IBM-FCC	Floppy Controller Card	\$ 34.95
IBM-Case	Flip-Top Case	\$ 39.95
IBM-MCC	Monochrome Card	\$ 59.95
IBM-PS	Power Supply	\$ 69.95
FD55B	TEAC 5 1/4" Disk Drive	\$109.95
IBM-MON	12" Monochrome Monitor . . .	\$ 99.95
IBM-MB	Motherboard	\$109.95

(with Zero-K RAM - incl. BIOS-ROM)

FREE! QUICKSOFT PC WRITE WORD PROCESSING SOFTWARE INCLUDED!

Weight: 48 lbs. *Regular List \$604.50*

IBMSP2 (Includes 9 items above) \$529.95

ADDITIONAL ADD-ONS AVAILABLE!

RS232HC	RS232 Serial Half Card	\$ 29.95
EM-100	Expansion Memory Half Card (without RAM) . .	\$ 59.95
IBM-ICB	Integrated Color Board w/Printer Port.	\$ 99.95
IMFC	Multifunction 0-384K RAM (without RAM) . . .	\$109.95
PM1200B-2	1200/300 Baud Half Card Modem without software. . .	\$129.95
PM1200B-2S	1200/300 Baud Half Card Modem with MirrorSoftware . .	\$159.95
IBM-EGA	Enhanced Graphics 256K Video RAM	\$229.95
TTX-1410	14" RGB Color Monitor.	\$289.95
IBM-20MBK	20MB Hard Disk Drive, Controller & Cable. . . .	\$429.95

IBM is a registered trademark of IBM Computers

NEW PRODUCTS!

NEW! Logitech Mice

IBM PC/XT Compatible

CTBASE	C7 Mouse with 3.1 Software.	\$84.95
C7PLUS	C7 Mouse w/PLUS Pkg. Software.	\$94.95
C7BUS	C7 Mouse w/Bus Brd. & PLUS Pkg. Swr.	\$119.95

IBM PC/XT/AT Compatible Keyboard

NEW! AT Style Layout

• Tactile touch keyswitches • AT style layout • Switch selectable between PC/XT or AT • Illuminated Caps Lock, Num Lock and Scroll Lock indicators • Low profile design • 8 1/2 foot cord • Manual included • Size: 18" L x 7 1/4" W x 1 1/2" H

KB5160. \$59.95

IBM PC/XT Compatible Enhanced Keyboard

• Enhanced PC/XT keyboard (equiv. to Keytronic™ 5151) • Separate cursor and numeric keyboard • Typewriter style layout makes it easier to learn! • LED indicators • Manual included • Color: off-white • Size: 20" L x 8 1/2" W x 1 1/2" H

IBM-ENH. \$79.95

Turbo 4.77/8MHz Motherboard

IBM PC/XT Compatible

• 75% faster than the IBM PC while in the turbo mode • Turbo Mode selectable through either software or hardware • Expandable to 640K (comes w/zero-K) • DTK/ERSO BIOS included

TURBO. NEW! \$129.95

APPLE COMPATIBLE ACCESSORIES

Jameco ELECTRONICS Parallel Printer Card for Apple II, II+ and IIe

• Intelligent interface to most dot matrix graphics printers
• Centronics standard
• Advanced text printing

JE880 Parallel Printer Card. \$49.95
JE883 64K Buffer for JE880 \$69.95 \$59.95
JE8803 JE880 and JE883 \$109.90 \$99.95

Jameco ELECTRONICS Extended 80-Column Card for Apple IIe

• 80 Col./64K RAM • Doubles amount of data your Apple IIe can display as well as its memory capacity • Ideal for word processing • Complete with instructions

JE864 \$59.95

Additional Apple Compatible Products Available

Jameco ELECTRONICS JE310 Fiber Optics Experimenter Kit

NEW! • Educational device gives students and engineers hands-on experience with fiber optic technology • Step by step instructions includes transmitter & receiver circuits boards, as well as all nec. IC's, cables & connectors

JE310 Fiber Optic Kit. \$19.95

Jameco ELECTRONICS JE450 Solderless Proto-Type Builder

• Provides user with quick and efficient system for breadboarding electronic circuits • Components & wire leads can be quickly inserted and removed without soldering or de-soldering • 3 regulated power supplies: 5V @ 1A, +5V to +15V @ .5A, -5V to -15V @ .5A • Power: 120VAC, 60Hz fused

NEW!

JE450 Solderless Proto-Type Builder . . . \$119.95

IBM Compatible! DISK DRIVES

Documentation Included

FD55B Teac 5 1/4" DS 1/2-H (IBM PC/XT) . . . \$109.95
JU-455 Panasonic 5 1/4" DS 1/2-H (IBM PC/XT) \$109.95
JU-475 Panasonic 5 1/4" DS 1/2-H (IBM AT) . . . \$119.95

DATA BOOKS

30003	National Linear Data Book (82)	\$14.95
30009	Intersil Data Book (86)	\$ 9.85
30013	Zilog Data Book (85)	\$14.95
30032	National Linear Supplement (84)	\$ 6.95
210830	Intel Memory Handbook (87)	\$17.95
230843	Intel Microsystem Hndbk. Set (87)	\$24.95

MUFFIN/SPRITE-STYLE FANS

MUF60. \$9.95
Torin Industries (4.68" sq. 60 cfm)
SU2A1. \$8.95
EG&G Rotron (3.125" square, 20 cfm)

\$20 Minimum Order - U.S. Funds Only
Shipping: Add 5% plus \$1.50 Insurance

California Residents: Add 6%, 6 1/2% or 7% Sales Tax
We reserve the right to substitute IC manufacturers.

Data Sheets - 50¢ each
Prices Subject to Change

Send \$1.00 Postage for a FREE Seasonal Flyer
FAX 415-592-2503
6/87



Send \$1.00 Postage for a FREE 1987 CATALOG
Telex: 176043

1355 SHOREWAY ROAD, BELMONT, CA 94002 • PHONE ORDERS WELCOME 415-592-8097 ©1987 Jameco Electronics

JADE COMPUTER



Continental U.S.

(800) 421-5500

Inside California

(800) 262-1710

Technical Support

(213) 973-7707

F.C.C.
APPROVED



\$398 IBM COMPATIBLE TURBO SYSTEMS

XT TURBO

- 640K of RAM
- 7 MHz Turbo Mode
- Deluxe Keyboard
- 8 Expansion Slots

\$398

286 TURBO

- 640K of RAM (1 MB Motherboard)
- 8 MHz 80286
- 1.2 MB Disk Drive
- AT-Style Keyboard/Case
- 8 Expansion Slots

\$998

12 MHz 286

- 1 MB of RAM
- 12 MHz 80286
- 1.2 MB Disk Drive
- AT Style Keyboard
- 8 Expansion Slots

\$1488

18 MHz 386

- 512K of RAM
- 18 MHz 80386
- 1.2 MB Disk Drive
- AT Style Keyboard
- 8 Expansion Slots

\$3988

CALL FOR SPECIAL PRICES ON SYSTEM PACKAGES

HARD DISK DRIVE



Hard Disk, Controller (PC) and Cables

\$199

- 10 MB Internal Kit _____ \$199
- 20 MB Internal Kit _____ \$369
- 30 MB Internal Kit _____ \$398
- 30 Megabyte AT Kit _____ \$499
- 40 Megabyte AT Kit _____ \$699

IBM PC-XT

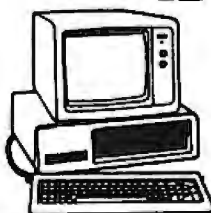

\$998

640K, Two 360K Drives

- 10 MB add \$190
- 20 MB add \$340
- 30 MB add \$398

NO-SLOT CLOCK

Real time clock/calendar for your IBM PC-XT, Clone or Apple II+, IIe or IIc.

\$49

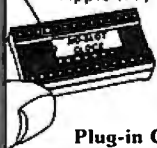

- Uses No Slot
- 20 Year Battery
- Includes Software

Plug-in Clock Board for PC...\$49

3 1/2" DISK DRIVE

FOR YOUR PC/XT/AT
720K Disk Drive for Mass Storage or for Down Loading to your Lap-Top Computer. Requires DOS 3.20

\$149

HEWLETT-PACKARD LASER JET II

- New Improved Model
- 512K RAM up to 4 MB
- 8 Page Per Minute
- 300 DPI Graphics

\$1798

List Price \$2495

DISK DRIVE FOR YOUR APPLE

AS LOW AS **\$119**



- 20 MB hard disk _____ \$799
- IIc 1/2 high disk drive _____ \$119
- IIe 1/2 high disk drive _____ \$119
- IIe, II+ disk drive _____ \$129
- IIe 64K, 80 column card _____ \$49
- II+ 80 column card _____ \$119
- Grappler printer card _____ \$89
- II+ 16K RAM card _____ \$39
- 1 MB RAM card w/OK _____ \$129
- II+, IIe printer card & cable _____ \$49
- II+, IIe cooling fan _____ \$59

1200 BAUD MODEM

- Internal 1200 Baud Card with software _____ \$99
- External 1200 Baud _____ \$119
- Internal 2400 Baud Card with software _____ \$199
- Hayes 1200B internal card w/o software _____ \$329
- Hayes 1200B internal card w/Smartcom II _____ \$359
- Hayes Smartmodem 1200 _____ \$389

\$99



- Hayes 2400B internal card w/Smartcom II _____ \$549
- Hayes Smartmodem 2400 _____ \$589

MICROSOFT MS-DOS 3.20

Including GW-BASIC Supports 3 1/2" Drive

\$88

DELUXE KEYBOARD DRAWER

Ball-Bearing Slides with Ergonomic Palm Rest

\$48

HIGH RESOLUTION MONOCHROME FLAT SCREEN

Amber or Green Monitor with Free Tilt-N-Swivel Base

\$98

MicroSpeed Fast 88 7 MHz Turbo Board For Your Turbo

\$99

EPSON PLOTTER

FOUR PEN/FOUR COLOR

\$198

LIST PRICE \$599

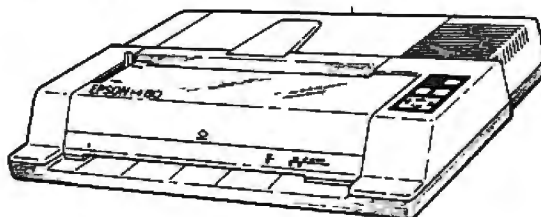

"The Epson HI-80 is the final choice. It makes a name for itself at the low end of the price scale (\$599) and the top end of the performance scale." PC MAGAZINE

- 4 waterbase pens _____ \$5
- 4 oil base pens _____ \$5
- 100 sheets coated paper _____ \$5
- 10 sheets overhead transparency film _____ \$6
- Top rated business graphics software package for PC _____ \$29
- Parallel PC cable _____ \$19

- Fast - 9 inch per second
- Accurate - .1 mm step size
- Four Pen/Four Color

- Automatic Pen Capping
- Standard Parallel Interfacing
- Accepts Paper or Transparencies
- One Year Epson Warranty

EPSON PRINTER

\$199

LIST PRICE \$299

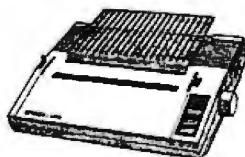

TRACTOR OR SHEET FEEDER \$29

LX-86, FX-86e/286e, EX-800/1000, LQ-800/1000/2500
IN STOCK, CALL FOR LOW LOW PRICES

360K DISK DRIVE

Built By Alpine Electronics to IBM Specifications, same as Qume 142

\$65⁹⁵

LIST PRICE \$199



10-99 100+
\$62⁵⁰ \$59⁸⁰

- 360K
- 48 TPI
- Double density
- Double-sided
- Half Height

HI-RES RGB MONITOR

\$289

LIST PRICE \$699

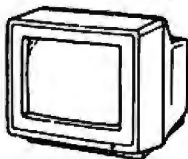

- 640 x 240 Non-glare Tube
- 16 color, .39 mm Dot Pitch

HARD DISK ON A CARD

21 MB CARD

\$398

- 21.3 MB Formatted
- Lowpower

30 MB CARD

\$498

- Head Park Zone
- Plated Media
- Light 2.4 Lbs.

EGA PACKAGE

\$569

LIST PRICE \$998

Hi-res EGA video card...\$199
Hi-res EGA monitor...\$399

- Dual Mode Monitor
- Non-glare .31 mm Dot Pitch
- 640 x 350, 640 x 200
- EGA, CGA, MDA & HGA
- 100% IBM Compatible
- 256K of Video RAM

OPTI-MOUSE

The Best Mouse For Your PC!

\$99

LIST PRICE \$220

* Add \$9 For DR.HALO

MICROSOFT MOUSE

\$129

ISO-BAR

Industrial quality surge suppression circuitry & built-in noise filter

- 6 socket, 1 filter ISO-BAR _____ \$44
- 4 socket, 2 filter ISO-BAR _____ \$59
- 8 socket, 4 filter ISO-BAR _____ \$69
- 200W standby power supply _____ \$269
- 450W standby power supply _____ \$399
- 675W standby power supply _____ \$599
- 1000W standby power supply _____ \$899

Multifunction Boards

- 384K Seven Pak w/OK _____ \$89
- 384K Seven Pak w/384K _____ \$139
- AST Six Pak Plus 64K _____ \$159
- AST Six Pak Plus 384K _____ \$229
- Magic I/O par, serial, clock _____ \$69
- Magic I/O-AT parallel,serial _____ \$68
- 576K Half Card w/OK _____ \$59
- 576K Half Card w/576K _____ \$129

Monochrome & Color Monitors

- Samsung Flat Screen green _____ \$99
- Samsung Flat Screen amber _____ \$99
- Amdek 410
- amber, green or white _____ \$179
- PGS MAX 12e amber _____ \$159
- NEC Multi-Sync 800 x 560 _____ \$559
- PGS HX-12 640 x 240 _____ \$439
- PGS HX-12e 640 x 350 _____ \$529

PC or AT Video Boards

- Hercules Color Graphics _____ \$159
- Jade Color Graphics _____ \$89
- Hercules Mono Graphics Plus _____ \$199
- Jade Monochrome Graphics _____ \$99
- Paradise AutoSwitch EGA _____ \$359
- Video 7 Vega EGA _____ \$299
- Jade EGA Plus _____ \$199

JADE COMPUTER

4901 W. Rosecrans Ave. Box 5046
Hawthorne, CA 90251-5046



Prices at our six store locations will be higher.
We accept cash, checks, credit cards or purchase orders from qualified firms and institutions. Minimum prepaid order \$15.00.

PLACE ORDERS TOLL FREE!

Continental U.S.A. (800)421-5500

Inside California (800)262-1710

Ca. & Tx. residents add sales tax. Prices & availability subject to change without notice. Shipping & handling charges via UPS Ground 50c/lb. UPS Air \$1.00/lb. Minimum charge \$3.00.

1200B MODEM \$99.95

FOR IBM W/
SOFTWARE

2400B MODEM \$199.95

BARGAIN HUNTERS CORNER
NEW FROM RIM ELECTRONICS

NICKEL EXPRESS \$69.95

PC/XT SPEED UP KIT

- * INCREASE THE SPEED OF YOUR PC BY 67% OR MORE!
- * SIMPLE NO-SLOT INSTALLATION
- * SOFTWARE OR HARDWARE SPEED SELECTION
- * 8 MHz V20 PROCESSOR & SOFTWARE INCLUDED
- * SELECT FOR 3 TURBO FREQUENCIES
- * EXTERNAL RESET SWITCH
- * OPTIONAL 8088 8 MHz PROCESSOR AVAILABLE

Certain early PCs may not run at 8 MHz; these machines may be switched to one of the slower speeds:
6.86 MHz=40% 7.37 MHz=55% 8.0 MHz=67%

SPECIAL ENDS 7/31/87

PAGE WIRE WRAP WIRE PRECUT ASSORTMENT

IN ASSORTED COLORS \$27.50

100ea: 5.5", 6.0", 6.5", 7.0"
250ea: 2.5", 4.5", 5.0"
500ea: 3.0", 3.5", 4.0"

SPOOLS

100 feet \$4.30 250 feet \$7.25
500 feet \$13.25 1000 feet \$21.95

Please specify color:
Blue, Black, Yellow or Red

EXTENDER CARDS

IBM-PC \$29.95
IBM-AT \$39.95

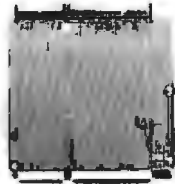

WIRE WRAP PROTOTYPE CARDS

FR-4 EPOXY GLASS LAMINATE
WITH GOLD-PLATED EDGE-CARD FINGERS



IBM-PR2

IBM

BOTH CARDS HAVE SILK SCREENED LEGENDS
AND INCLUDES MOUNTING BRACKET

IBM-PR1 WITH +5V AND GROUND PLANE \$27.95
IBM-PR2 AS ABOVE WITH DECODING LAYOUT \$29.95

S-100

P100-1 BARE - NO FOIL PADS \$15.15
P100-2 HORIZONTAL BUS \$21.80
P100-3 VERTICAL BUS \$21.80
P100-4 SINGLE FOIL PADS PER HOLE \$22.75

APPLE

P500-1 BARE - NO FOIL PADS \$15.15
P500-3 HORIZONTAL BUS \$22.75
P500-4 SINGLE FOIL PADS PER HOLE \$21.80
7060-45 FOR APPLE IIe AUX SLOT \$30.00

SOCKET-WRAP I.D.™

- * SLIPS OVER WIRE WRAP PINS
- * IDENTIFIES PIN NUMBERS ON WRAP SIDE OF BOARD
- * CAN WRITE ON PLASTIC; SUCH AS IC #

PINS	PART#	PCK. OF	PRICE
8	IDWRAP 08	10	1.85
14	IDWRAP 14	10	1.95
16	IDWRAP 16	10	1.95
18	IDWRAP 18	5	1.95
20	IDWRAP 20	5	1.95
22	IDWRAP 22	5	1.95
24	IDWRAP 24	5	1.95
28	IDWRAP 28	5	1.95
40	IDWRAP 40	5	1.95

PLEASE ORDER BY NUMBER OF PACKAGES (PCK. OF)



FRAME STYLE TRANSFORMERS

12.6V AC CT	2 AMP	5.95
12.6V AC CT	4 AMP	7.95
12.6V AC CT	8 AMP	10.95
25.2V AC CT	2 AMP	7.95

25 PIN D-SUB BENDER CHANGERS \$7.95



SWITCHING POWER SUPPLIES

PS-IBM \$89.95

- * FOR IBM PC-XT COMPATIBLE
- * 135 WATTS
- * +5V @ 15A, +12V @ 4.2A
- * -5V @ .5A, +12V @ .5A
- * ONE YEAR WARRANTY



PS-IBM-150 \$79.95

- * FOR IBM PC-XT COMPATIBLE
- * 150 WATTS
- * +12V @ 5.2A, +5V @ 16A
- * -12V @ .5A, -5V @ .5A
- * ONE YEAR WARRANTY

PS-IBM/150

PS-130 \$99.95

- * 130 WATTS
- * SWITCH ON REAR
- * FOR USE IN OTHER IBM TYPE MACHINES
- * 90 DAY WARRANTY

PS-130

PS-A \$49.95

- * USE TO POWER APPLE TYPE SYSTEMS, 79.5 WATTS
- * +5V @ 7A, +12V @ 3A
- * -5V @ .5A, -12V @ .5A
- * APPLE POWER CONNECTOR

PS-A

PS-1550 \$34.95

- * 75 WATTS, UL APPROVED
- * +5V @ 7A, +12V @ 3A
- * -12V @ 250ma, -5V @ 300ma

PS-1550

CAPACITORS

TANTALUM

1.0µf	15V	.35	47µf	35V	.48
6.8	15V	.70	1.0	35V	.45
10	15V	.80	2.2	35V	.65
22	15V	1.35	4.7	35V	.85
.22	35V	.40	10	35V	1.00

DISC

10µf	50V	.05	680	50V	.05
22	50V	.05	.001µf	50V	.05
27	50V	.05	.0022	50V	.05
33	50V	.05	.005	50V	.05
47	50V	.05	.01	50V	.07
68	50V	.05	.02	50V	.07
100	50V	.05	.05	50V	.07
220	50V	.05	.1	12V	.10
560	50V	.05	.1	50V	.12

MONOLITHIC

.01µf	50V	.14	.1µf	50V	.18
.047µf	50V	.15	.47µf	50V	.28

ELECTROLYTIC

RADIAL		AXIAL			
1µf	25V	.14	1µf	50V	.14
2.2	35V	.15	10	50V	.16
4.7	50V	.15	22	16V	.16
10	50V	.15	47	50V	.20
47	35V	.18	100	35V	.25
100	16V	.18	220	25V	.30
220	35V	.20	470	50V	.50
470	25V	.30	1000	16V	.60
2200	16V	.70	2200	16V	.70
4700	25V	1.45	4700	16V	1.25

DATARASE EPROM ERASER \$34.95

- * ERASES 2 IN 10 MINUTES
- * COMPACT-NO DRAWER
- * THIN METAL SHUTTER PREVENTS UV LIGHT FROM ESCAPING



1/4 WATT RESISTORS

5% CARBON FILM ALL STANDARD VALUES FROM 1 OHM TO 10 MEG. OHM

10 PCS	same value	.05	100 PCS	same value	.02
50 PCS	same value	.025	1000 PCS	same value	.015

RESISTOR NETWORKS

SIP	10 PIN	9 RESISTOR	.69
SIP	8 PIN	7 RESISTOR	.59
DIP	16 PIN	8 RESISTOR	1.09
DIP	16 PIN	15 RESISTOR	1.09
DIP	14 PIN	7 RESISTOR	.99
DIP	14 PIN	13 RESISTOR	.99

SPECIALS ON BYPASS CAPACITORS

.01 µf	CERAMIC DISC	100/\$5.00
.01 µf	MONOLITHIC	100/\$10.00
.1 µf	CERAMIC DISC	100/\$6.50
.1 µf	MONOLITHIC	100/\$12.50

WISH SOLDERLESS BREADBOARDS

PART NUMBER	DIMENSIONS	DISTRIBUTION STRIP(S)	TIE POINTS	TERMINAL STRIP(S)	TIE POINTS	BINDING POSTS	PRICE
WBU-0	.38 x 6.50"	1	100	---	---	---	2.95
WBU-T	1.38 x 6.50"	---	---	1	630	---	6.95
WBU-204-3	3.94 x 8.45"	1	100	2	1260	2	17.95
WBU-204	5.13 x 8.45"	4	400	2	1260	3	24.95
WBU-206	8.88 x 9.06"	5	500	3	1890	4	29.95
WBU-208	8.25 x 9.45"	7	700	4	2520	4	39.95

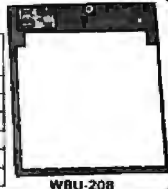

LITHIUM BATTERY

AS USED IN CLOCK CIRCUITS

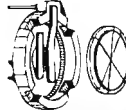

3 VOLT BATTERY \$3.95
BATTERY HOLDER \$1.49

MUFFIN FANS

3.15" SQ. 14.95 3.63" SQ. 14.95
3.18" SQUARE 16.95

6' LINE CORDS

2 conductor .39 3 conductor .39
3 conductor w/female socket 1.49

EMI FILTER \$4.95

2 VOLUME SET IC MASTER

THE INDUSTRY STANDARD

\$129.95



Visit our retail store located at 1256 S. Bascom Ave. in San Jose, (408) 947-8881

JDR Microdevices

110 Knowles Drive, Los Gatos, CA 95030

Toll Free 800-538-5000 • (408) 866-6200

FAX (408) 378-8927 • Telex 171-110

PLEASE USE YOUR CUSTOMER NUMBER WHEN ORDERING

TERMS: Minimum order \$10.00. For shipping and handling include \$2.50 for UPS Ground and \$3.50 for UPS Air. Orders over 1 lb. and foreign orders may require additional shipping charges - please contact our sales department for the amount. CA residents must include applicable sales tax. All merchandise is warranted for 90 days unless otherwise stated. Prices are subject to change without notice. We are not responsible for typographical errors. We reserve the right to limit quantities and to substitute manufacturer. All merchandise subject to prior sale.

COPYRIGHT 1987 JDR MICRODEVICES

Inquiry 147

THE JDR MICRODEVICES LOGO IS A REGISTERED TRADEMARK OF JDR MICRODEVICES. JDR INSTRUMENTS AND JDR MICRODEVICES ARE TRADEMARKS OF JDR MICRODEVICES. IBM IS A TRADEMARK OF INTERNATIONAL BUSINESS MACHINES. APPLE IS A TRADEMARK OF APPLE COMPUTER.

EGA CARD AND MONITOR NOW ONLY \$569!

CRT MONITORS FOR ALL APPLICATIONS



CASPER EGA MONITOR

- EGA & CGA COMPATIBLE
- SCANNING FREQUENCIES: 15.75 / 21.85 KHz
- RES: 640 x 200 / 350
- 31mm DOT PITCH, 25 MHz
- 16 COLORS OUT OF 64
- 14", BLACK MATRIX SCREEN

\$399.95



CASPER RGB MONITOR

- COLOR/GREEN/AMBER SWITCH ON REAR
- DIGITAL RGB-IBM COMPATIBLE
- 14" NON-GLARE SCREEN
- RESOLUTION: 640H x 240V
- 39mm DOT PITCH
- CABLE FOR IBM PC INCLUDED

\$299.95



SAMSUNG MONOCHROME

- IBM COMPATIBLE TTL INPUT
- 12" NON-GLARE AMBER, LOW DISTORTION SCREEN
- RESOLUTION: 720H x 350V
- ATTRACTIVE CASE WITH SWIVEL BASE
- ONE YEAR WARRANTY

\$119.95



FORTRONICS MONOCHROME

- IBM COMPATIBLE TTL INPUT
- 12" NON-GLARE SCREEN
- VERY HIGH RESOLUTION: 1100 LINES (CENTER)
- 25 MHz BANDWIDTH
- CABLE FOR IBM PC INCLUDED
- AMBER OR GREEN AVAILABLE

\$99.95

TILT & SWIVEL MONITOR STAND \$12⁹⁵ WITH POWER CENTER \$39⁹⁵

DISK DRIVES FOR APPLE COMPUTERS

**AP-150
\$99.95**



- 1/2 HT, DIRECT DRIVE
- 100% APPLE COMPATIBLE
- SIX MONTH WARRANTY

**AP-135
\$129.95**

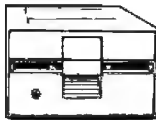

- FULL HT SHUGART MECHANISM
- DIRECT REPLACEMENT FOR APPLE DISK II
- SIX MONTH WARRANTY

**DOUBLE
SIDED!**

**MAC535
\$249.95**

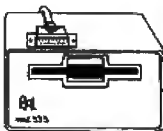

- 3.5" ADD-ON DISK DRIVE
- 100% MACINTOSH COMPATIBLE
- DOUBLE SIDED 800K BYTE STORAGE
- HIGH RELIABILITY DRIVE
- HAS AUTO-EJECT MECHANISM
- FULL ONE YEAR WARRANTY

**AD-3C
\$139.95**

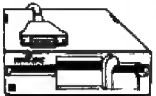

- 100% APPLE IIc COMPATIBLE, READY TO PLUG IN, W/ SHIELDED CABLE & MOLDED 19 PIN CONNECTOR
- FAST RELIABLE SLIMLINE DIRECT DRIVE
- SIX MONTH WARRANTY

DISK DRIVE ACCESSORIES

- FDD CONTROLLER CARD **\$49.95**
- IIc ADAPTOR CABLE **\$19.95**
- ADAPTS ST. STANDARD APPLE DRIVES FOR USE WITH APPLE IIc

KB-1000 \$79.95

CASE WITH KEYBOARD FOR APPLE TYPE MOTHERBOARD

- USER DEFINED FUNCTION KEYS
- NUMERIC KEYPAD W/ CURSOR CONTROL
- CAPS LOCK
- AUTO-REPEAT



KEYBOARD-AP \$49.95

- REPLACEMENT FOR APPLE II KEYBOARD
- CAPS LOCK KEY, AUTO-REPEAT
- ONE KEY ENTRY OF BASIC OR CP/M COMMANDS

JOYSTICK CB-10 \$19.95

- SET X-Y AXIS FOR AUTO CENTER OR FREE MOVEMENT
- FIRE BUTTON FOR USE WITH GAME SOFTWARE
- ATTRACTIVE, SOLID, PLASTIC CASE
- INCLUDES ADAPTOR CABLE FOR IBM, APPLE II, IIc, ATARI & VIC 20/64



POWER STRIP \$12.95

- UL APPROVED
- 15A CIRCUIT BREAKER

APPLE COMPATIBLE INTERFACE CARDS



EPROM PROGRAMMER

- DUPLICATE OR BURN ANY 27xx SERIES EPROM (2716 TO 27128)
- MENU-DRIVEN SOFTWARE
- HIGH SPEED WRITE ALGORITHM

RP-525 \$59⁹⁵



16K RAMCARD

- FULL 2 YEAR WARRANTY
- EXPAND YOUR 48K MACHINE TO A FULL 64K OF MEMORY
- CAN BE USED IN PLACE OF THE APPLE LANGUAGE CARD

RAM-CARD \$39⁹⁵



IC TEST CARD

- QUICKLY TESTS MANY COMMON ICs
- DISPLAYS PASS OR FAIL
- TEST 4000 & 74HC SERIES CMOS, 7400, 74LS, 74L, 74H & 74S

IC-TESTER \$129⁹⁵

MOLDED INTERFACE CABLES

6 FOOT, 100% SHIELDED, MEETS FCC



- IBM PARALLEL PRINTER CABLE **9.95**
- CENTRONICS (MALE TO FEMALE) **15.95**
- CENTRONICS (FEMALE TO MALE) **14.95**
- MODEM CABLE (FOR IBM) **7.95**
- RS232 SERIAL (MALE TO FEMALE) **5.95**
- RS232 SERIAL (MALE TO MALE) **5.95**
- KEYBOARD EXTENDER (COILED) **7.95**
- APPLE II JOYSTICK EXTENDER **4.95**

G. ITOH RITEMAN II PRINTER



- 160 CPS DRAFT, 32 CPS NLQ
- 9 x 9 DOT MATRIX
- SUPPORTS EPSON/IBM GRAPHICS
- FRICTION AND PIN FEEDS
- VARIABLE LINE SPACING AND PITCH

\$219.95

- IBM PRINTER CABLE **\$8.95**
- REPLACEMENT RIBBON CARTRIDGE **\$7.95**

SWITCH BOXES

ALL LINES SWITCHED, GOLD PLATED CONNECTORS, QUALITY SWITCHES

2 WAY \$39.95

- CONNECTS 2 PRINTERS TO 1 COMPUTER OR VICE VERSA

AB-P (CENTRONICS PARALLEL)

AB-S (RS232 SERIAL)



3 WAY \$99.95

- CONNECTS 3 PRINTERS TO 1 COMPUTER OR VICE VERSA

SWITCH-3P (CENTRONICS PARALLEL)

SWITCH-3S (RS232 SERIAL)



NASHUA DISKETTES

NASHUA DISKETTES WERE JUDGED TO HAVE THE HIGHEST POLISH AND RECORDED AMPLITUDE OF ANY DISKETTES TESTED (COMPARING FLOPPY DISKS, BYTE 9/84)

- N-MD2D DS/DD 5 1/4" SOFT **\$9.90**
- N-MD2F DS/QUAD 5 1/4" SOFT **\$19.95**
- N-MD2H DS/HO 5 1/4" FOR AT **\$24.95**
- N-FD1 SS/DD 8" SOFT **\$27.95**
- N-FD2D DS/DD 8" SOFT **\$34.95**

BULK DISKETTE SALE

5 1/4" SOFT SECTOR, DS/DD W/TYVEC SLEEVES & HUB RINGS

\$990 690^{ea} 590^{ea}
BOX OF 10 BULK QTY 50 BULK QTY 250

DISKETTE FILES

- 5 1/4" DISKFILE HOLDS 70 **\$8.95**
- 3 1/2" DISKFILE HOLDS 40 **\$9.95**



Seagate

5 1/4" HARD DISK DRIVES

- ST-225 HALF HT 20MB 65ms **\$275**
- ST-238 HALF HT 30MB 65ms (RL) **\$299**
- ST-251 HALF HT 40MB 40ms **\$599**
- ST-277 HALF HT 60MB 40ms (RL) **CALL**
- ST-4038 FULL HT 30MB 40ms **\$559**
- ST-4096 FULL HT 80MB 28ms **\$1195**

1/2 HEIGHT FLOPPY DISK DRIVES

- 5 1/4" TEAC FD-55B DS/DD **\$109.95**
- 5 1/4" TEAC FD-55F DS/QUAD **\$124.95**
- 5 1/4" TEAC FD-55GFV DS/HD **\$154.95**
- 5 1/4" MITSUBISHI DS/HD **\$129.95**
- 3 1/2" TOSHIBA KIT DS/DD **\$149.95**

KIT INCLUDES MOUNTING HARDWARE TO FIT 5 1/4" & FACEPLATES FOR AT & XT

DISK DRIVE ACCESSORIES

- TEAC SPECIFICATION MANUAL **\$5.00**
- TEAC MAINTENANCE MANUAL **\$25.00**
- 1/2" HT MNTG HARDWARE FOR IBM **\$4.95**
- MOUNTING RAILS FOR IBM AT **\$4.95**
- "Y" POWER CABLE FOR 5 1/4" FDDs **\$2.95**
- 5 1/4" FDD POWER CONNECTORS **\$1.19**

DISK DRIVE ENCLOSURES WITH POWER SUPPLIES

- CAB-25V5 DUAL SLIMLINE 5 1/4" **\$49⁹⁵**
- CAB-1FH5 FULL HT 5 1/4" **\$69⁹⁵**
- CAB-23V8 DUAL SLIMLINE 8" **\$209⁹⁵**
- CAB-2FH8 DUAL FULL HT 8" **\$219⁹⁵**



BUILD STEVE GIARGIA'S INTELLIGENT EPROM PROGRAMMER

AS SEEN IN BYTE, OCT. 85

- STAND-ALONE OR RS-232 SERIAL OPERATION
- MENU SELECTABLE EPROM TYPES—NO CONFIGURATION JUMPERS
- PROGRAMS ALL 5V 27XXX EPROMS FROM 2716 TO 27512
- READ, COPY OR VERIFY EPROM
- UPLOAD/DOWNLOAD INTEL HEX FILES
- PROGRAMMER DRIVER USER MODIFIABLE

ONLY \$199

KIT INCLUDES PCB AND ALL COMPONENTS EXCEPT CASE & POWER SUPPLY

EGA CARD AND MONITOR NOW ONLY \$569!

QUALITY IBM COMPATIBLE MOTHERBOARDS

FROM MODULAR CIRCUIT TECHNOLOGY

TURBO 4.77 / 8 MHZ \$129.95

JDR PART #: MCT-TURBO

- 4.77 OR 8 MHZ OPERATION WITH 8088-2 & OPTIONAL 8087-2 CO-PROCESSOR
- DYNAMICALLY ADJUSTS SPEED DURING DISKETTE OPERATION FOR MAXIMUM THROUGHPUT AND RELIABILITY
- CHOICE OF NORMAL / TURBO MODE OR SOFTWARE SELECT PROCESSOR SPEED

STANDARD 4.77 MHZ \$109.95

JDR PART #: MCT-XTMB

- 8088 CPU, OPTIONAL 8087 CO-PROCESSOR & EXPANSION SLOTS
- EXPANDABLE TO 640K ON-BOARD MEMORY (0K RAM INSTALLED)
- ALL ICs SOCKETED - HIGHEST QUALITY PCB
- ACCEPTS 2764 OR 27128 ROMS

BOTH WITH FREE MCT BIOS!

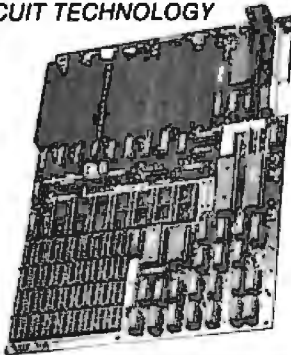

FARADAY FDD CONTROLLER

JDR PART #: FAR-FDD

- SUPPORTS UP TO 4 INTERNALLY MOUNTED FDDs
- IBM COMPATIBLE, INTERFACES TO 360K OR 720K USING DOS 3.20
- INCLUDES CABLE FOR 2 DISK DRIVES

\$24.95

IBM COMPATIBLE FLOPPY DISK DRIVE

JDR PART #: FDD-360

GOOD QUALITY DRIVES BY MAJOR MANUFACTURERS SUCH AS QUME, TANDON & CDC

- 5 1/4" HALF HEIGHT
- 360K STORAGE CAPACITY
- DS/DD
- 48 TPI

\$69.95

IBM STYLE COMPUTER CASE

AN ATTRACTIVE STEEL CASE WITH A HINGED LID. FITS THE POPULAR PC/XT COMPATIBLE MOTHERBOARDS



- SWITCH CUT-OUT ON SIDE FOR PC/XT STYLE POWER SUPPLY
- CUT-OUT FOR 8 EXPANSION SLOTS
- ALL HARDWARE INCLUDED

\$34.95

SLIDE TYPE CASE \$39.95

BUILD YOUR OWN 256K XT COMPATIBLE SYSTEM

XT MOTHERBOARD	\$109 ⁹⁵
PRO-BIOS (A \$20 VALUE) FREE!	
256K RAM	\$26 ⁹⁵
130 WATT POWER SUPPLY	\$89 ⁹⁵
FLIP-TOP CASE	\$34 ⁹⁵
KEY TRONIC™ KEYBOARD	\$49 ⁹⁵
360K DRIVE	\$68 ⁹⁵
FARADAY CONTROLLER	\$24 ⁹⁵
MONOCHROME ADAPTOR	\$49 ⁹⁵
FORTRONICS MONITOR	\$98 ⁹⁵

TOTAL: \$536.15

IBM COMPATIBLE KEYBOARDS



MCT-5150 \$59.95

- "5150" STYLE KEYBOARD
- FULLY IBM COMPATIBLE
- LED STATUS INDICATORS FOR CAPS & NUMBER LOCK
- LARGE, EASY TO REACH SHIFT & RETURN KEYS
- 83 KEY TYPEWRITER LAYOUT



MCT-5151 \$79.95

- REPLACEMENT FOR KEY TRONIC™ KB-5151 KEYBOARD
- SEPARATE CURSOR & NUMERIC KEYPAD
- CAPS LOCK & NUMBER LOCK INDICATORS
- IMPROVED KEYBOARD LAYOUT



MCT-5060 \$59.95

- IBM AT STYLE LAYOUT
- SOFTWARE AUTONSENSE FOR XT OR AT COMPATIBLES
- EXTRA LARGE SHIFT & RETURN KEYS
- LED INDICATORS FOR SCROLL, CAPS & NUMBER LOCK
- AUTO REPEAT FEATURE



MCT-5339 \$89.95

- IBM ENHANCED STYLE LAYOUT
- SOFTWARE AUTONSENSE FOR XT OR AT COMPATIBLES
- 12 FUNCTION KEYS
- EXTRA LARGE SHIFT & RETURN KEYS
- LED INDICATORS FOR SCROLL, CAPS & NUMBER LOCK
- AUTO REPEAT FEATURE
- SEPARATE CURSOR PAD

EASYDATA MODEMS

All models feature auto-dial/answer/redial on busy, Hayes compatible, power up self test, touchtone or pulse dialing, built-in speaker, PC Talk III Communications software, Bell Systems 103 & 212A full or half duplex and more.

INTERNAL

EASYDATA-12H \$99.95

1200 BAUD HALF CARD

EASYDATA-12B \$119.95

1200 BAUD 10" CARD

EASYDATA-24B \$199.95

2400 BAUD FULL CARD

EXTERNAL

NO SOFTWARE INCLUDED

EASYDATA-12D \$119.95

1200 BAUD

EASYDATA-24D \$219.95

2400 BAUD

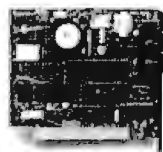

DISPLAY CARDS

FROM MODULAR CIRCUIT TECHNOLOGY

MCT-EGA

\$179.95

100% IBM COMPATIBLE, PASSES IBM EGA DIAGNOSTICS

- COMPATIBLE WITH IBM EGA, COLOR GRAPHICS AND MONOCHROME ADAPTORS
- TRIPLE SCANNING FREQUENCY FOR DISPLAY ON EGA, STANDARD RGB OR HIGH RESOLUTION MONOCHROME MONITOR
- FULL 256K OF VIDEO RAM ALLOWS 640 x 350 PIXELS IN 16 OF 64 COLORS
- LIGHT PEN INTERFACE



MCT-CG

\$49.95

COMPATIBLE WITH IBM COLOR GRAPHICS STANDARD

- SHORT SLOT CARD USES VLSI CHIPS TO INSURE RELIABILITY
- SUPPORTS RGB, COMPOSITE MONOCHROME & COLOR AND AN RF MODULATOR OUTPUT
- 320 x 200 COLOR GRAPHICS MODE
- 640 x 200 MONO GRAPHICS MODE
- LIGHT PEN INTERFACE

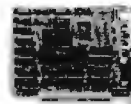

MCT-MGP

\$59.95

COMPATIBLE WITH IBM MONOCHROME AND HERCULES GRAPHICS STANDARDS

- SHORT SLOT CARD USES VLSI CHIPS TO INSURE RELIABILITY
- PARALLEL PRINTER PORT, CONFIGURABLE AS LPT1 OR LPT2
- 720 x 348 GRAPHICS MODE
- LOTUS COMPATIBLE
- CAN RUN WITH COLOR GRAPHICS CARD IN THE SAME SYSTEM

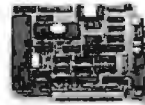

MCT-MG

\$79.95

COMPATIBLE WITH IBM MONOCHROME AND HERCULES GRAPHICS STANDARDS

- SERIAL PORT OPTION
- PARALLEL PRINTER PORT
- 720 x 348 GRAPHICS MODE
- 80 x 25 TEXT MODE
- LOTUS COMPATIBLE
- SELECTABLE TO RUN ALONG WITH COLOR GRAPHICS CARD IN THE SAME SYSTEM



MG-SERIALOPTIONAL SERIAL PORT \$19⁹⁵

MCT-MONO

\$49.95

ANOTHER FANTASTIC VALUE FROM JDR!

- IBM COMPATIBLE TTL INPUT
 - 720 x 348 PIXEL DISPLAY
- PLEASE NOTE THIS CARD WILL NOT RUN LOTUS GRAPHICS AND DOES NOT INCLUDE A PARALLEL PORT

EPROM PROGRAMMERS

FROM MODULAR CIRCUIT TECHNOLOGY

MCT-EPROM

\$129.95

PROGRAMS 27xx AND 27xxx SERIES EPROMS UP TO 27512

- SUPPORTS VARIOUS MANUFACTURERS FORMATS WITH 12.5, 21 AND 25 VOLT PROGRAMMING
- MENU-DRIVEN SOFTWARE ALLOWS EASY MANIPULATION OF DATA FILES
- SPLIT OR COMBINE THE CONTENTS OF SEVERAL EPROMS OF DIFFERENT SIZES
- READ, WRITE, COPY, ERASE CHECK AND VERIFY WITH EASY ONE KEY SELECTION
- INCLUDES SOFTWARE FOR STANDARD HEX AND INTEL HEX FORMATS

4 GANG PROGRAMMER \$189⁹⁵

10 GANG PROGRAMMER \$299⁹⁵

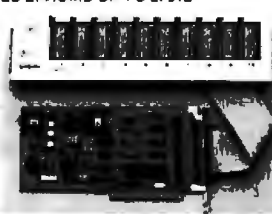

MCT PRODUCTS CARRY A ONE YEAR WARRANTY

COPYRIGHT 1987 JDR MICRODEVICES

1200B MODEM \$99.95 FOR IBM W/
SOFTWARE

2400B MODEM \$199.95

MULTIFUNCTION CARDS

FROM MODULAR CIRCUIT TECHNOLOGY

MCT-MF \$79.95

ALL THE FEATURES OF FAST'S SIX PACK PLUS AT HALF THE PRICE!

- 0-348K DYNAMIC RAM USING 4164s
- INCLUDES SERIAL PORT, PARALLEL PRINTER PORT, GAME CONTROLLER PORT AND CLOCK/CALENDAR
- SOFTWARE FOR A RAMDISK, PRINT SPOOLER AND CLOCK/CALENDAR



MCT-ATMF \$139.95

ADDS UP TO 3 MB OF 1 BIT RAM TO THE AT

- USER EXPANDABLE TO 1.5 MB OF ON-BOARD MEMORY (NO MEMORY INSTALLED)
- FLEXIBLE ADDRESS CONFIGURATION
- INCLUDES SERIAL PORT, PARALLEL PORT
- OPTIONAL PIGGYBACK BOARD PERMITS EXPANSION TO 3 MB

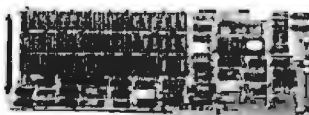

ATMF-SERIAL 2nd SERIAL PORT **\$249.95**
MCT-ATMF-MC **\$299.95**
PIGGYBACK BOARD (ZERO K INSTALLED)

MCT-MIO \$79.95

A PERFECT COMPANION FOR OUR MOTHERBOARD

- 2 DRIVE FLOPPY DISK CONTROLLER
- INCLUDES SERIAL PORT, PARALLEL PORT, GAME PORT AND CLOCK/CALENDAR WITH BATTERY BACK-UP
- SOFTWARE FOR A RAMDISK, PRINT SPOOLER AND CLOCK/CALENDAR

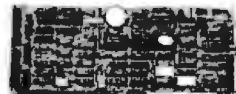

MID-SERIAL 2nd SERIAL PORT **\$159.95**

MCT-IO \$59.95

USE WITH MCT-FH FOR A MINIMUM OF SLOTS USED

- SERIAL PORT ADDRESSABLE AS COM1, COM2, COM3 OR COM4
- PARALLEL PRINTER PORT ADDRESSABLE AS LPT1 OR LPT2 (x378 OR x278)
- CLOCK/CALENDAR WITH A BATTERY BACK-UP



IO-SERIAL 2nd SERIAL PORT **\$159.95**

MCT-ATIO \$59.95

USE WITH MCT-ATFH FOR A MINIMUM OF SLOTS USED

- SERIAL PORT ADDRESSABLE AS COM1, COM2, COM3 OR COM4
- PARALLEL PRINTER PORT ADDRESSABLE AS LPTA OR LPTB (x378 OR x278)
- GAME PORT
- USES 16450 SERIAL SUPPORT CHIPS FOR HIGH SPEED OPERATION IN AN AT



ATIO-SERIAL 2nd SERIAL PORT **\$249.95**

RAM CARDS

FROM MODULAR CIRCUIT TECHNOLOGY

MCT-RAM \$69.95

A CONTIGUOUS MEMORY SOLUTION FOR YOUR SHORT OR REGULAR SLOT

- SHORT SLOT, LOW POWER PC COMPATIBLE DESIGN
- CAN OFFER UP TO 576K OF ADDITIONAL MEMORY
- USER SELECTABLE CONFIGURATION AMOUNTS OF 192, 384, 512, 256 & 576K, USING COMBINATIONS OF 64 & 256K RAM



MCT-ATRAM \$149.95

A POWER USER'S DREAM, 4MB OF MEMORY FOR THE AT

- USER EXPANDABLE TO 2MB OF ON-BOARD MEMORY
- USES FULL 16 BIT PARITY CHECKED MEMORY, 64K OR 256K DYNAMIC RAM
- FLEXIBLE STARTING ADDRESS, ROUND OUT CONVENTIONAL MEMORY TO 640K & ADD EXTENDED MEMORY ABOVE 1MB



MCT-ATRAM-MC **\$399.95**
2MB PIGGYBACK BOARD (ZERO K INSTALLED)

MCT-EMS \$129.95

2MB OF LOTUS/INTEL/MICROSOFT COMPATIBLE MEMORY FOR THE XT

- CONFORMS TO LOTUS/INTEL EMS
- USER EXPANDABLE TO 2 MB
- USES 64K OR 256K DYNAMIC RAM (NO MEMORY INSTALLED)
- USE AS EXPANDED OR CONVENTIONAL MEMORY, RAMDISK OR SPOOLER
- SOFTWARE INCLUDES EMS DEVICE DRIVERS, PRINT SPOOLER AND RAMDISK

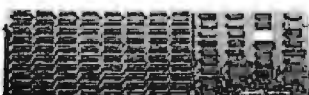

MCT-ATEMS AT VERSION OF THE MCT-EMS **\$139.95**

Seagate

HARD DISK SYSTEMS
20 MB 30 MB
\$339 \$399

Systems include half height hard disk drive, hard disk drive controller, cables and instructions. Drives are pre-tested and warranted for one year.

Seagate 40 MB AT DRIVE
FAST 40ms ACCESS TIME



\$599

DISK CONTROLLER CARDS

FROM MODULAR CIRCUIT TECHNOLOGY

MCT-FDC \$34.95

QUALITY DESIGN OFFERS 4 FLOPPY CONTROL IN A SINGLE SLOT

- INTERFACES UP TO 4 FDDs TO AN IBM PC OR COMPATIBLE
- INCLUDES CABLING FOR 2 INTERNAL DRIVES
- USES STANDARD DB37 CONNECTOR FOR EXTERNAL DRIVES
- SUPPORTS BOTH DS/DD AND DS/QD WHEN USED W/ DOS 3.2 OR JFORMAT

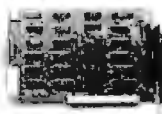

MCT-HDC

\$89.95

HARD DISK CONTROL FOR WHAT OTHERS CHARGE FOR FLOPPY CONTROL

- IBM XT COMPATIBLE CONTROLLER SUPPORTS 16 DRIVE SIZES INCLUDING 5, 10, 20, 30 & 40MB
- OPTIONS INCLUDE THE ABILITY TO DIVIDE 1 LARGE DRIVE INTO 2 SMALLER, LOGICAL DRIVES
- INCLUDES CABLING FOR 1 INTERNAL DRIVE

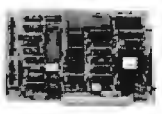

MCT-RLL

\$119.95

GET UP TO 50% MORE STORAGE SPACE ON YOUR HARD DISK

- INCREASES THE CAPACITY OF PLATED MEDIA DRIVES BY 50%
- RLL 2, 7 ENCODING FOR MORE RELIABLE STORAGE
- TRANSFER RATE IS ALSO 50% FASTER; 750K/sec vs 500K/sec
- USE WITH ST-238 DRIVE TO ACHIEVE 30-MB IN A HALF HEIGHT SLOT

NEW!

MCT-FH

\$139.95

STARVED FOR SLOTS? SATISFY IT WITH THIS TIMELY DESIGN

- INTERFACES UP TO 2 FDDs & 2 HDDs
- CABLING FOR 2 FDDs & 1 HDD
- FLOPPY INTERFACE SUPPORTS BOTH DS/DD & DS/QD WHEN USED WITH DOS 3.2 OR JFORMAT
- ALL POPULAR HDD SIZES ARE SUPPORTED, INCLUDING 5, 10, 20, 30 & 40MB
- CAN DIVIDE 1 LARGE DRIVE INTO 2 SMALLER, LOGICAL DRIVES

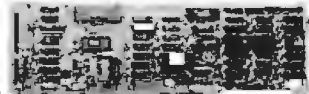

MCT-ATFH

\$169.95

FLOPPY AND HARD DISK CONTROL IN A TRUE AT DESIGN

- AT COMPATIBLE, CONTROL UP TO 2 350K/720K OR 1.2MB FDDs AS WELL AS 2 HDDs USING THE AT STANDARD CONTROL TABLES
- SUPPORTS AT STYLE FRONT PANEL LED TO INDICATE HD ACTIVITY
- 16 BIT BUSS PROVIDES RAPID DATA TRANSFERS
- FULLY SUPPORTED BY AT BIOS



JDR Microdevices

110 Knowles Drive, Los Gatos, CA 95030
Toll Free 800-538-5000 • (408) 866-6200 • FAX (408) 378-8927 • Telex 171-110

THE JDR MICRODEVICES LOGO IS A REGISTERED TRADEMARK OF JDR MICRODEVICES. JDR INSTRUMENTS AND JDR MICRODEVICES ARE TRADEMARKS OF JDR MICRODEVICES. IBM IS A TRADEMARK OF INTERNATIONAL BUSINESS MACHINES.

BOMB

YOU CHOOSE THE BEST ARTICLE EACH MONTH

BYTE's ongoing monitor box (BOMB) lets you rate each article you've read in BYTE as excellent, good, fair, or poor. Each month, you can mail in the BOMB card found at the back of the issue. We tally your votes, total the points, tell you who won, and award the two top-rated nonstaff authors

\$100 and \$50, respectively. An additional \$50 award for quality goes to the nonstaff author with the best average score (total points divided by the number of voters). If you prefer, you can use BIX as your method of voting. We welcome your participation.

ARTICLE#	PAGE	ARTICLE	AUTHOR(S)	ARTICLE#	PAGE	ARTICLE	AUTHOR(S)
1	37	Microbytes	staff	13	199	Computer-Aided Routing of Printed Circuit Boards.....	Belter
2	45	What's New.....	staff	14	209	IGES	Mayer
3	68	Ask BYTE/Circuit Cellar Feedback.....	Ciarcia	15	217	CAD for Building Chips.....	Trimberger, Rowson
4	81	Book Reviews.....	Rogers, West, Kilov	16	229	Beyond Turbo.....	Rash
5	100	First Impressions: The IBM PS/2 Computers.....	staff	17	235	Turbo-Amiga	Block
6	116	Product Description: Microsoft's New DOS.....	White, Grehan	18	238	Pick of the Litter.....	Murray, Pappas
7	129	Ciarcia's Circuit Cellar: Build a Gray-Scale Video Digitizer, Part 2.....	Ciarcia	19	245	Four C Language Interpreters..	Unger
8	143	Programming Project: A Contouring Subroutine.....	Bourke	20	250	Microsoft Windows Software Development Kit.....	Hart, Hart
9	155	Programming Insight: Polynomial Curve Fitter.....	Hood	21	256	Smalltalk/V Release 1.2.....	Davis
10	161	68000 Machines: Atari 520ST Projects.....	Hunkler	22	265	Acquaint	Tello
11	177	Data Structures in CAD Software	Pfortmiller	23	272	Zoomracks II.....	Sperry
12	187	The CADcompiler.....	Crooke	24	281	Computing at Chaos Manor: Puttering with Yin and Yang...	Pournelle
				25	297	According to Webster: Processor Wars.....	Webster
				26	317	Focus on Algorithms: Run-Length Encoding.....	Pountain
				27	321	Applications Only: AI, AI, Oh!.....	Shapiro
				28	325	Best of BIX.....	BIXen

BOMB RESULTS

First place in March goes to BYTE's Product Preview of "The Commodore A2000" by editors Gregg Williams, Tom Thompson, and Richard Grehan. In second place and the winner of \$100 is John F. Asmus for "Digital Image Processing in Art Conservation." Ken Sheldon's "Probing Space by Camera" placed third, followed by George Stewart's Product Preview of "Turbo BASIC." Next in line is What's New and Ciarcia's Circuit Cellar, in which Steve Ciarcia

shows how to "Build a Trainable Infrared Master Controller." Winner of the \$50 award for being the second nonstaff author to appear in the lineup is Benjamin M. Dawson for his "Introduction to Image Processing Algorithms." The \$50 award for quality again goes to John F. Asmus for his close look at the evolution of the *Mona Lisa*. Congratulations to all.

COMING UP IN BYTE

Theme:

Local area networks will be July's theme, with emphasis planned for topics like testing networks to see what load they can take; how to link Macintoshes into a Unix network; how to archive your data; a look at an Amiga network file server, a discussion of a LAN-based spreadsheet, and an examination of some LAN database software.

Features:

Planned features include the Intel 82786 graphics chip, Karmarkars algorithm, and map storage on CD-ROMs.

Circuit Cellar:

After building an image processor, Steve Ciarcia will discuss image-processing software.

Programming Project:

An article on recursive fractals (in BASIC).

Programming Insight:

Complex math in Pascal.

Special 68000 Series:

Remotely controlling scientific apparatus with a Macintosh and a specially developed object-oriented language.

Reviews:

Different ADA implementations for the IBM PC, an advanced debugging tool, a music program, and a roundup of CAD packages for use on the Macintosh.

EDITORIAL INDEX BY COMPANY

Index of companies covered in articles, columns, or news stories in this issue.
Each reference is to the first page of the article or section in which the company name appears.

COMPANY	PAGE	COMPANY	PAGE
ABSOF T	235	MATSUSHITA	37
ACCESS ASSOCIATES	297	METACOMCO	235, 281
ACS TELECOM	45	METAWARE	297
ADVANCED LOGIC RESEARCH	297	MICROPRO INTERNATIONAL	281, 321
ADVANCED MICRO DEVICES	217	MICROSOFT	45, 116, 143, 155, 187, 235, 245, 297
APOLLO COMPUTER	297	MICROVITEC	45
APPLE COMPUTER	37, 297	MINDSCAPE	281, 321
ATARI	281	MODULAR SOFTWARE	45
AUTOCAD	209	MOTOROLA	37
BAEN SOFTWARE	281	MOUSE SYSTEMS	235
BORLAND INTERNATIONAL	281, 317	NATIONAL SEMICONDUCTOR	297
BOSTON COMPUTER SOCIETY	37	NEC	37, 281
C. ITOH DIGITAL PRODUCTS	45	NOVATION	45
CADLOGIC SYSTEMS	45	OMNITEL	281
CCI	129	OWL INTERNATIONAL	281
CIE SYSTEMS	45	PAPERBACK SOFTWARE	321
COMMODORE	37, 45, 235	PC DISCOUNT	45
COMPAQ COMPUTER	297	PC'S LIMITED	229
COMPATIBLE SYSTEMS	45	PENCOM INTERNATIONAL	37
COMPUPRO	281	PHARLAP SOFTWARE	297
COMPUTER CONSOLES	37	PLANAR SYSTEMS	37
COMPUTER SYSTEM ASSOCIATES	235	POLAROID	45
CORVUS	229	PROFIT SYSTEMS	45
CRICKET SOFTWARE	37	QUARTERDECK OFFICE SYSTEMS	281
CYPHER TECHNOLOGY	45	QUICKVIEW SYSTEMS	245
DATA GENERAL	37	RA-LO	45
DATABLOCKS	45	RATIONAL SYSTEMS	245
DATARADIO	37	RCA	129
DAYFLO SOFTWARE	45	RYAN-MCFARLAND	45
DEM ASSOCIATES	37	SABA TECHNOLOGIES	45
DIGITAL EQUIPMENT	37, 297	SHARP	37
DIGITALK	245	SIGMA DESIGNS	297
DOUGLAS ELECTRONICS	45	SILICON BEACH SOFTWARE	297, 321
ELECTRONIC ARTS	45	SOFT WAREHOUSE	245
ELECTRONIC COTTAGERS	37	SOFTWARE PUBLISHING	45
EXPERTELLIGENCE	281	STRIDE MICRO	281
FALCON TECHNOLOGY	37	SUBLOGIC	45
GENERAL ELECTRIC	37	SUMMAGRAPHICS	235
GIMPEL SOFTWARE	245	SUN MICROSYSTEMS	297
HARD/SOFT PRESS	321	SYMANTEC	45
HAWTHORNE TECHNOLOGY	45	SYSTOLIC SYSTEMS	45
HAYES MICROCOMPUTER	129	T/MAKER	281
HEWLETT-PACKARD	297	TANDON	45
HITACHI	37	TDI SOFTWARE	235
IBM	37, 100, 116, 229, 235, 245, 297, 317	THE SOURCE	45
INFORMATION STORAGE	37	THE VOICE CONNECTION	45
INTEL	37	THINK TECHNOLOGIES	281
INTERGRAPH	209	3COM	45, 229
ITT	245	TORRINGTON	235
JASIK DESIGNS	281	TOSHIBA	37, 45
KAYPRO	45	UNIVERSITY OF CALIFORNIA AT BERKELEY	37
LARS OLSSON ENGINEERING	45	VERSITRON	37
LASERGRAPHICS	45	VISUAL AGE	45
LEVCO	297	WAITE GROUP	297
LIFEBOAT ASSOCIATES	245	WELLS AMERICAN	229
LITHP SYSTEMS	245	WHITE CRANE SYSTEMS	281
LIVING VIDEOTEXT	281	WINTEK	199
LOGITECH	235	XEROX	37, 245
LOTUS DEVELOPMENT	297	ZENITH DATA SYSTEMS	45, 229, 281
MACNEAL-SCHWENDLER	45		
MAGMA SOFTWARE SYSTEMS	45		

BACK ISSUES FOR SALE

	1985	1986	1987
Jan.	\$4.25		\$4.25
Feb.	\$4.25	\$4.25	\$4.25
March	\$4.25	\$4.25	\$4.25
April	\$4.25		\$4.25
May	\$4.25		\$4.25
June	\$4.25	\$4.25	
July		\$4.25	
Aug.	\$4.25	\$4.25	
Sept.	\$4.25	\$4.25	
Oct.	\$4.25	\$4.25	
Nov.	\$4.25	\$4.25	
Dec.	\$4.25	\$4.25	

SPECIAL ISSUES and INDEX

BYTE '83-'84 INDEX	\$1.75
BYTE 1985 INDEX	\$2.00
1984 SPECIAL GUIDE TO IBM PCs (VOL. 9, No. 9)	\$4.75
1985 INSIDE THE IBM PCs (VOL. 10, No. 11)	\$4.75

Circle and send requests with payments to:

BYTE Back Issues
P.O. Box 328
Hancock, NH 03449

Check enclosed *Payments from foreign countries must be made in US funds payable at a US bank.*

VISA MasterCard

CARD # _____ EXP. DATE _____

SIGNATURE _____

The above prices include postage in the US. Please add \$.50 per copy for Canada and Mexico; and \$2.00 per copy to foreign countries (surface delivery). Please allow 4 weeks for domestic delivery and 12 weeks for foreign delivery.

NAME _____

ADDRESS _____

CITY _____ STATE _____ ZIP _____

BYTE ADVERTISING SALES STAFF:

Dennis J. Riley, Advertising Sales Manager, One Phoenix Mill Lane, Peterborough, NH 03458, tel. (603) 924-9281

NEW ENGLAND
 ME, NH, VT, MA, RI,
 ONTARIO, CANADA & EASTERN CANADA
 Paul McPherson Jr. (617) 262-1160
 McGraw-Hill Publications
 575 Boylston Street
 Boston, MA 02116

ATLANTIC
 NY, NYC, CT, NJ (NORTH)
 Leah G. Rabinowitz (212) 512-2096
 McGraw-Hill Publications
 1221 Avenue of the Americas—
 39th Floor
 New York, NY 10020

Dick McGurk (203) 968-7111
 McGraw-Hill Publications
 Building A—3rd Floor
 777 Long Ridge Road
 Stamford, CT 06902

EAST
 PA, KY, OH, NJ (SOUTH),
 MD, VA, W.VA, DE, D.C.
 Daniel Ferro (215) 496-3833
 McGraw-Hill Publications
 Three Parkway
 Philadelphia, PA 19102

**NORTHEAST MAIL ORDER
 AND RETAIL ACCOUNTS**
 Bill Watson (603) 924-7255
 One Phoenix Mill Lane
 Peterborough, NH 03458

SOUTHEAST
 NC, SC, GA, FL, AL, TN
 Carolyn F. Lovett (404) 252-0626
 McGraw-Hill Publications
 4170 Ashford-Dunwoody Road
 Suite 420
 Atlanta, GA 30319

MIDWEST
 IL, MO, KS, IA, ND, SD, MN, WI,
 NB, IN, MI, MS
 Bob Denmead (312) 751-3740
 McGraw-Hill Publications
 Blair Building
 645 North Michigan Ave.
 Chicago, IL 60611

SOUTHWEST, ROCKY MOUNTAIN
 UT, CO, WY, OK, TX, AR, LA
 (214) 458-2400
 McGraw-Hill Publications
 Prestonwood Tower—Suite 907
 5151 Beltline
 Dallas, TX 75240

SOUTH PACIFIC
 SOUTHERN CA, AZ, NM, LAS VEGAS
 Jack Anderson (714) 557-6292
 McGraw-Hill Publications
 3001 Red Hill Ave.
 Building #1—Suite 222
 Costa Mesa, CA 92626

Tom Harvey (213) 480-5243
 McGraw-Hill Publications
 3333 Wilshire Boulevard #407
 Los Angeles, CA 90010

NORTH PACIFIC
 HI, WA, OR, ID, MT, NORTHERN CA,
 NV (except LAS VEGAS), W. CANADA
 Mike Kisseberth (415) 362-4600
 McGraw-Hill Publications
 425 Battery Street
 San Francisco, CA 94111

Bill McAfee (415) 349-4100
 McGraw-Hill Publications
 951 Mariner's Island Blvd.—3rd Floor
 San Mateo, CA 94404

**WEST COAST MAIL ORDER
 AND RETAIL ACCOUNTS**
 Tom Harvey (805) 964-8577
 3463 State Street—Suite 256
 Santa Barbara, CA 93105

The Buyer's Mart
 Mark Stone (603) 924-3754
 BYTE Publications
 One Phoenix Mill Lane
 Peterborough, NH 03458

BYTE BITS (2x3)
 Dan Harper (603) 924-6830
 BYTE Publications
 One Phoenix Mill Lane
 Peterborough, NH 03458

**BYTE Deck Mailings
 National**
 Ed Yare (603) 924-6166
 BYTE Publications
 One Phoenix Mill Lane
 Peterborough, NH 03458

A/E/C Computing Deck
 Mary Ann Goulding (603) 924-9281
 BYTE Publications
 One Phoenix Mill Lane
 Peterborough, NH 03458

International Advertising Sales Staff:

Mr. Hans Csokor
 Publimedia
 Reissnerstrasse 61
 A-1037 Vienna, Austria
 222 75 76 84

Mrs. Gurit Gepner
 McGraw-Hill Publishing Co.
 PO Box 2156
 Bat Yam, 59121 Israel
 3 866 561 321 39

Mr. Fritz Krusebecker
 McGraw-Hill Publishing Co.
 Liebigstrasse 19
 D-6000 Frankfurt/Main 1
 West Germany
 69 72 01 81

Mrs. Maria Sarmiento
 Pedro Teixeira 8, Off. 320
 Iberia Mart 1
 Madrid 4, Spain
 1 45 52 891

Mr. Andrew Karnig
 Andrew Karnig & Associates
 Finnbodavagen
 S-131 31 Nacka, Sweden
 8-44 0005

Mr. Alain Faure
 McGraw-Hill Publishing Co.
 128 Faubourg Saint Honore
 75008 Paris
 France
 (1) 42-89-03-81

Mr. Arthur Scheffer
 McGraw-Hill Publishing Co.
 34 Dover St.
 London W1X 3RA
 England 01 493 1451

Manuela Capuano
 McGraw-Hill Publishing Co.
 Via Flavio Baracchini 1
 20123 Milan, Italy
 02 86 90 617

Seavex Ltd.
 400 Orchard Road, #10-01
 Singapore 0923
 Republic of Singapore
 Tel: 734-9790
 Telex: R35539 SEAVEX

Seavex Ltd.
 503 Wilson House
 19-27 Wyndham St.
 Central, Hong Kong
 Tel: 5-260149
 Telex: 60904 SEVEX HX

Hiro Morita
 McGraw-Hill Publishing Co.
 Overseas Corp.
 Room 1528
 Kasumigaseki Bldg.
 3-2-5 Kasumigaseki,
 Chiyoda-Ku
 Tokyo 100, Japan
 3 581 9811

Mr. Ernest McCrary
 Empresa Internacional de
 Comunicacoes Ltda.
 Rua da Consolacao, 222
 Conjunto 103
 01302 Sao Paulo, S.P., Brasil
 Tel: (11) 259-3811
 Telex: (100) 32122 EMBN

READER SERVICE

To get further information on the products advertised in BYTE, fill out the reader service card by circling the numbers on the card that correspond to the inquiry number listed with the advertiser. This index is provided as an additional service by the publisher, who assumes no liability for errors or omissions.

* Correspond directly with company

Alphabetical Index to Advertisers

Inquiry No.	Page No.	Inquiry No.	Page No.	Inquiry No.	Page No.	Inquiry No.	Page No.
* 3M COMPANY	208A-H	71 COMPUTER WAREHOUSE	278	151 KADAK PRODUCTS	82	352 PERSOFT INC.	55
3 3M COMPANY	88,89	73 CONTECH COMPUTER CORP.	358	152 KAYPRO CORPORATION	176	353 PERSOFT INC.	55
4 ABSOFT	338	74 CONTROL SYSTEMS	219	153 KAYPRO CORPORATION	176	236 PERSONAL COMP. SUPT. GRP.	291
365 ADDISON-WESLEY EDU.MEDIA	276	75 CONTROL SYSTEMS	219	154 KEA SYSTEMS LTD.	358	237 PERSONAL TEX.	306
5 ADDMASTER CORP.	350	76 COTTON SOFTWARE	350	155 KEA SYSTEMS LTD.	358	238 PETER NORTON	271
6 ADOBE	186	77 CRAYON COMPUTER CORP.	364	157 LAHEY COMPUTER SYSTEMS	269	239 PETER NORTON	271
7 ADVANCED COMP. PROD.	365	79 CUESTA SYSTEMS	207	158 LANGUAGE PROCESSORS INC.	313	240 PINECOM COMPUTER	351
9 AHEAD SYSTEMS INC.	308	80 CUESTA SYSTEMS	207	159 LATTICE INC.	242	241 PMI	84
10 AHEAD SYSTEMS INC.	308	81 CURTIS INC.	358	161 LIFEBOAT ASSOC.	206	242 PMI	84
11 AJIDA TECHNOLOGIES	366	82 CUSTOM SOFTV	EMS 86	162 LIGHT SPEED	307	243 PRECISION DATA PROD.	319
12 ALF PRODUCTS, INC.	350	83 CYB SYSTEMS	80	163 LINK COMPUTER GRAPHICS	366	244 PRIDE SOFTWARE DEVLPMNT.	179
13 ALPHA PRODUCTS	363	84 DAC SOFTWARE	23	165 LOGICAL DEVICES	270	245 PRIDE SOFTWARE DEVLPMNT.	179
14 ALPS AMERICA	140,141	85 DALCO ELECTRONICS	356	166 LOGICAL DEVICES	270	246 PRIMAGES INC.	115
15 ALPS AMERICA	140,141	88 DATASOUTH COMP. CC	244	400 LOGICSOFT	224A-F	248 PRINCETON GRAPHIC SYS.	311
16 AMDEK CORP.	41	86 DEI	113	167 LOGITECH	61	160 PROGRAMMER'S PARADISE	196,197
17 AMERICAN RESEARCH CORP.	315	87 DEI	113	168 LOGITECH	61	249 PROGRAMMER'S SHOP	283
18 AMERICAN RESEARCH CORP.	315	89 DIC	105	169 LOGITECH	63	250 PROGRAMMER'S SHOP	289
19 AMERICAN SEMICONDUCTOR	338	90 DIGITAL VISI	90	170 LOGITECH	63	338 PROTEUS TECHNOLOGY CORP.	142
20 AMERICAN SMALL BUSINESS	139	91 DIGITALINK INC.	299	171 LONE STAR SOFTWARE	357	252 PD. SIG.	356
21 AMPRO COMPUTER INC.	208	92 DISKS PLUS	308	* LOTUS DEVELOPMENT	273	253 OIC RESEA	243
22 APPLIED KNOWLEDGE GPS. INC.	261	93 DISK WORLD! INC.	358	172 MACNEAL-SCHWENDLER	12	254 OSP INC.	267
363 APPLIED MICRO TECHNOLOGY	354	94 DISKOTECH	366	173 MACNEAL-SCHWENDLER	12	255 OUA TECH.	359
23 APROTEK	356	95 DISKETTE CONNECTION	359	174 MANX SOFTWARE SYS.	93	256 OUA TECH.	359
24 ARITY CORPORATION	233	64 DISKMASTER	356	175 MANX SOFTWARE SYS.	201	257 OUA TECH.	359
25 ARIUM	33	* DOW JONES NEWS/RETRIEVAL	85	176 MARK WILLIAMS CO.	39	258 OUA TECH.	359
26 ARIUM	33	96 DRESSELHAUS COMP.PROD.	204	177 MARK WILLIAMS CO.	21	259 OUA TECH.	359
27 ATI TECHNOLOGIES INC.	253	98 ECOSOFT	324	178 MATHSOFT	47	260 OUA TECH.	359
28 ATRON CORP.	77	99 EI&S	366	* MAXELL DATA PRODUCTS	7	* OUAID SOFWA	298
29 ATRONICS	239	101 ELEXOR INC.	360	179 MEAD COMPUTER	355	261 OUALSTAR COF	319
369 AUTODESK	15	102 ELLIS COMPUTING INC.	78	180 MEGASOFT	360	262 RADIO SHACK	CIV
30 AVIS RENTA-CAR	149	103 ENGINEERS COLLABORATIVE	362	* MEIRICK INC.	258	263 RADIO SHACK	157
31 AVOCET SYSTEMS INC.	288	360 ENTERPRISE SFTW. PROD.	314	181 MERRITT COMP. PRODS.	356	* RAIMA CORP.	20
32 A+ COMPUTER RESPONSE	354	104 EVEREX SYSTEMS	24,25	183 MICROCOM SYSTEMS	32	264 RAINBOW TECHNOLOGIES	362
35 BAY TECHNICAL ASSOC.	121	105 EVEREX SYSTEMS	24,25	184 MICROGRAFX	327	265 RAINBOW TECHNOLOGIES	94
36 BAY TECHNICAL ASSOC.	121	106 EVOLUTION COMPUTER	215	* MICROMINT	305	266 REAL TIME DEVICES	364
37 BBN SOFTWARE	154	107 EVOLUTION COMPUTER	215	185 MICROPORT	35	267 ROLAND DG	226
38 BECKMAN INDUSTRIES	145	109 FLAGSTAFF ENGINEERING	109	197 MICROPROCESSORS UNITD.	358	268 ROSE ELECTRONICS	354
* BEST WESTERN	282	110 FLAGSTAFF ENGINEERING	109	186 MICROSERVE	234	269 R.P.T. INTERGROUPS INT'L.	300
* BINARY TECHNOLOGIES	350	111 FORESIGHT RESOURCES	259	187 MICROSERVE	234	270 RYAN MCFARLAND	75
40 BIT SOFTWARE	302	112 FORESIGHT RESOURCES	259	* MICROSOFT CORP.	69	271 RYAN MCFARLAND	75
373 BORLAND INT'L.	CII,1	113 FORTRON CORPORATION	18	188 MICROSOFT CORP.	152,153	272 SAFEWARE	350
374 BORLAND INT'L.	CII,1	114 FOX SOFTWARE	123	189 MICROSOFT CORP.	152,153	273 SAMSUNG ELECTRON ICES 10	30
375 BP MICROSYSTEM	360	366 FTP SOFTWARE	364	* MICROSOFT CORP.	277	274 SAMSUNG ELECTRON ICES 10	30
* BUYER'S MART	339-346	116 GAV	319	190 MICROWARE SYSTEMS	268	275 SBT CORPORATION	303
* BYTE BACK ISSU	380	117 GENERIC SOFTWARE	91	191 MICROWAY	128	276 SCIENTIFIC ENG. LAI	354
* BYTE CIRCULATION	331	118 GENERIC SOFTWARE	91	192 MICROWAY	189	294 SCSI	216
450 BYTE INFO. EXCHANGE (BIX)	337	119 GENOA SYSTEMS CORP.	44	358 MIGENT SOFTWARE INC.	112	295 SCSI	216
* BYTE MARKETING	335	* GIMPEL SOFTWARE	138	359 MIGENT SOFTWARE INC.	112	277 SCR CORPORATION	360
* BYTE SUB. MESSAGE	379	* GOLD HILL COMPUTERS	96,97	193 MIGENT SOFTWARE INC.	249	278 SEAGATE TECHNOLOGY	110,111
* BYTE SUB. SERVICE	190	120 GOLDEN BOW SYSTEMS	350	194 MIGENT SOFTWARE INC.	249	279 SEAGATE TECHNOLOGY	110,111
42 BYTEK CORPORATION	26	121 GOLDEN BOW SYSTEMS	350	354 MIGENT SOFTWARE INC.	301	* SHARP ELECTRONICS	329
43 B&B ELECTRONICS	366	122 GRAFPOINT	362	355 MIGENT SOFTWARE INC.	301	280 SILICON SPECIALITIES	87
44 B&C MICROSYSTEMS	354	123 GRAND UNION MICROSYS.	354	196 MINI MICRO BUSINESS SYS.	220	281 SILICON SPECIALITIES	87
45 B&C MICROSYSTEMS	366	124 GREAT SOUTHWESTERN CO.	114	* MINORITY HIGH TECH INDS.	284	283 SOFTKLONE DISTRIBUTING	28
46 CAD SOFTWARE	300	126 GTEK INC.	322	198 MIX SOFTWARE	255	284 SOFTLINE CORP.	83
182 CADKEY	53	* HARMONY COMPUTERS	76	199 MONEYSWORTH	72,73	285 SOFTLOGIC SOLUTIONS	127
47 CADSOFT SYSTEMS	92	161 HCR CORP.	310	200 MOUNTAIN COMPUTER	309	286 SOFTRONICS	358
347 CAL COMP	228	327 HERCULES COMPUTER TECH.	323	201 MULTITECH SYSTEMS	264	287 SOFTWARE DEVLPMNT. SYS.	30
348 CAL COMP.	228	128 HERCULES COMPUTER TECH.	323	202 MULTITECH SYSTEMS	264	371 SOFTWARE LINK	27
* CALIFORNIA	367	129 HERCULES COMPUTER TECH.	66,67	203 NANTUCKET	39	372 SOFTWARE LINK	27
48 CAPITAL EOL	276	130 HERCULES COMPUTER TECH.	66,67	204 NANTUCKET	39	* SOFTWARE PUBLISHING	163
49 CASIO INC.	185	131 HERSEY MICRO CONSULTING	158	205 NATIONAL INS	11	290 SOFTPLUS RESEARCH	364
50 CENTRAL COMPUTE	IS.356	132 HOUSTON INSTRUMENTS	79	206 NEC INFORMA	CIII	291 SOLUTION SYSTEMS	282
51 CHUNG YU	314	133 IBEX COMP. CORP.	356	207 NETWORK	9	292 SOURCE ELECTRONICS	82
52 CITIZEN AMERICA	49	* IBM CORP.	80A-X	208 NEWBURY DATA INC.	293	293 SOURCE ELECTRONICS	82
* CLEO SOFTWARE	274	135 IC EXPRESS	320	209 NEWBURY DATA INC.	293	296 SPECTRUM SOFTWARE	191
53 CLUB AT	151	136 INFOGRAPH INC.	198	212 OKIDATA	295	297 SPRING CIRCLE TECHNOLGY.	257
* CODEX CO	263	137 INFOGRAPH INC.	198	362 ONLINE COMPUTER SYS. INC.	320	298 SPSS INC.	172
54 COEFFICIE	8	335 INFOMASTER	73	214 ORCHID TECHNOLOGY	36	299 STSC INC.	125
55 COGNITATE	350	367 INFOTRONICS	148	215 ORCHID TECHNOLOGY	36	300 SYBIS	364
56 COGNITATE	360	368 INFOTRONICS	148	216 ORIENTAL PRECISION CI	304	301 SYSTAT INC.	159
* COMPAQ COMPUTER CORP.	160A-H	* INTECTRA INC.	360	217 ORION INSTRUMENTS	280	302 SYSTAT INC.	159
58 COMPETITIVE EDGE	310	138 INTEGRAND RESEARCH CORP.	146	218 OSBORNE MCGRAW-HILL	14	303 S'NW ELECTR. & APPL.	78
59 COMPLETE ELECTRONICS	34	139 INTEL CORP.	42,43	356 OSBORNE MCGRAW-HILL	316	304 S-100 DIV. 696 CORP.	361
60 COMPLETE PC	59	357 INTELLIGENT	287	219 PARA SYSTEMS	22	305 S-100 DIV. 696 CORP.	361
61 COMPUTATA TRAI	360	140 INTELLISOFT	221	220 PATTON & PATTON	360	306 TANDON	147
* COMPUPRO	156	141 IO TECH	362	221 PC AMERICAN MARKETING	205	309 TEKTRONIX INC.	64M-P
62 COMPUSAVE	351	142 JACO ENTERPRISES	360	370 PC CLUB	353	310 TELEBYTE TECHNOLOGY	286
63 COMPUSERVE	296	143 JADE COMPUTER	370,371	223 PC NETWORK	347	349 TELEX COMMUNICATIONS	223
65 COMPUTER CASE CO.	362	144 JAMECO ELECTRONICS	368,369	224 PC NETWORK	348,349	350 TELEX COMMUNICATIONS	223
* COMPUTER CONTINUUM	364	145 JDR INSTRUMENTS	95	225 PC PRO SYSTEMS	366	312 TIGERTRONICS	90
66 COMPUTER FRIENDS	193	146 JDR MICRODEVICES	372,373	229 PC'S LIMITED	167-171	313 TIGERTRONICS	350
67 COMPUTER LIBRARY	285	147 JDR MICRODEVICES	373,375	231 PERFORMANCE PC	364	364 TIMELINE	353
68 COMPUTER MAIL ORDER	56,57	148 JDR MICRODEVICES	376,377	232 PERMA POWER	76	* TINNEY, ROBERT	333
69 COMPUTER VALLEY	352	149 JHL RESEARCH	356	233 PERMA POWER	76	315 TOUCHBASE SYSTEMS INC.	292
70 COMPUTER WAREHOUSE	278	150 JMR ELECTRONICS	362	351 PERSOFT INC.	55	316 TOUCHBASE SYSTEMS INC.	292

READER SERVICE

Also included in this issue:
Special Advertising Supplement for Priority One Electronics
to U.S. Subscribers

Inquiry No.	Page No.	Inquiry No.	Page No.	Inquiry No.	Page No.	Inquiry No.	Page No.		
* TRANSEC SYSTEMS.....	70	INTERNATIONAL ADVERTISING SECTION		411 PC LINK CORP.....	320A-7	442 SOFTWARE DIRECTIONS.....	320B-13		
317 TRI-STATE COMPUTER.....	362	<i>No domestic inquiries please.</i>		412 SAC.....	320A-1	443 SOFTWARE WORLD.....	320B-14		
318 TURNPOINT AMERICA.....	98	500 BASIS INC.....	64A	413 STRIDE/MICROSAGE.....	320A-5	Mid-West			
319 T&T COMPUTER PRODUCTS.....	350	501 BONDWELL INT'L.....	64E	414 SUMMIT COMP. SYS.....	320A-6	451 COMPUSAT.....	320C-8		
320 UNITED INNOVATIONS.....	184	502 COMPUADD CORP.....	64K	415 WALL STREET COMPUTER.....	320A-11	452 COMPUTER INFU. LI.....	320C-4		
8 UNIS-DEPOT.....	354	503 GAMMA PRODS., INC.....	64H					453 FOCUS COMPUTERS.....	320C-4
330 UPTIME.....	19	504 GREY MATTER.....	64I	Los Angeles				454 HANDS-ON LEARNG. CORP.....	320C-9
321 USROBOTICS, INC.....	181	505 KEA SYSTEMS LTD.....	64F	426 800 SOFTWARE.....	320B-11	462 HANDS-ON LEARNG. CORP.....	320C-9		
322 USROBOTICS, INC.....	181	506 LOCAL DATA.....	64F	427 BASIC COMPUTER.....	320B-15	* MICROBEST.....	320C-5		
323 VEN-TEL CORP.....	17	507 NOKIA INFO. SYSTEM.....	64G	428 BYTE AND FLOPPY.....	320B-15	456 MONITERM.....	320C-11		
324 VERBATIM.....	51	508 WITRON GMBH.....	64F	* BYTE/TIPS.....	320B-4	457 PC LINK CORP.....	320C-10		
326 VIA WEST.....	268	REGIONAL ADVERTISING SECTION		446 CM LABS.....	320B-8	458 PRIORITY ONE.....	320C-1		
327 VIA WEST.....	268	New York		429 COMPUSAT.....	320B-9	* ROBT. TINNEY GRAPHICS.....	320C-12		
328 VICTORY ENT. TECHNLGY.....	70	* BYTE TIPS.....	320A-10	430 COMP. APPLICATIONS.....	320B-15	459 SAC.....	320C-6		
329 VIDEO TECHNOLOGIES.....	364	401 CHAS MICROSYSTEMS.....	320A-2	* COMP. CHRONICLES.....	320B-16	460 STRIDE/MICROSAGE.....	320C-7		
331 VISIONICS.....	304	402 COTTAGE COMPUTERS.....	320A-2	431 COMPUTER NOOK.....	320B-15	461 WESTERN SYSTEMS.....	320C-2,3		
332 VOYETRA TECHNOLOGIES.....	358	403 CTX INTERNATIONAL.....	320A-4	432 CTX INTERNATIONAL.....	320B-6	Pacific Northwest			
333 WAREHOUSE DATA.....	71	404 DOW JONES SOFTWARE.....	320A-12	433 EAGLE ELECTRONICS.....	320B-6	* BYTE/TIPS.....	320D-8		
341 WAYTRON INT'L. INC.....	290	405 HANDS-ON LEARNG. CORP.....	320A-8	434 HANDS-ON LEARNG. CORP.....	320B-10	475 GRAPHIC COMP. SOLNS.....	320D-8		
334 WELLS AMERICAN.....	21	416 HANDS-ON LEARNG. CORP.....	320A-8	445 HANDS-ON LEARNG. CORP.....	320B-10	476 MEDIA SOFTWARE & SYS.....	320D-2		
336 WHITE CRANE SYSTEMS.....	92	406 ILAR SYSTEMS.....	320A-9	435 INFOTRONICS COMPUTERS.....	320B-8	477 M.A.S. SYSTEMS.....	320D-4,5		
337 WHITE CRANE SYSTEMS.....	92	407 INNOVATIVE DATA TECH.....	320A-4	436 INNOVATIVE DATA TECH.....	320B-4	478 VAR TECH, INC.....	320D-1		
339 WINTEK CORP.....	358	408 MICROAGE OF MAHWAH.....	320A-10	* MICROBEST.....	320B-7	479 VAR TECH, INC.....	320D-3		
340 WINTEK CORP.....	5	409 MICROAGE OF NORWALK.....	320A-10	438 M.A.S. SYSTEMS.....	320B-2,3	480 WESTERN SYSTEMS.....	320D-6,7		
342 WOODCHUCK INDUSTRIES.....	364	* MICROBEST.....	320A-3	439 PHASE 5.....	320B-15	<i>* Correspond directly with company.</i>			
343 WORTHINGTON DATA SOLNS.....	120			440 PRIORITY ONE.....	320B-1				
344 XEMAG.....	320			* ROBT. TINNEY GRAPHICS.....	320B-12				
345 ZERICON.....	338			441 SAC.....	320B-5				
346 Z-WORLD.....	74								

TIPS SUBSCRIBERS ONLY!*

*Use BYTE's Telephone Inquiry Processing System
Using TIPS can bring product information as much as 10 days earlier.*

SEND FOR YOUR SUBSCRIBER I.D. CARD	1) If you are a new subscriber or have lost your I.D. card, circle #1 on the Reader Service Card; attach mailer label. We will immediately send your personal TIPS subscriber card.
GET PREPARED	2) Write your Subscriber Number, as printed on your Subscriber I.D. Card, in boxes in Step 5 below. (Do not add 0's to fill in blank boxes) 3) Write numbers for information desired in boxes in Step 7b below. (Do not add 0's to fill in blank boxes).
CALL TIPS	4) Now, on a Touch-Tone telephone dial: (413) 442-2668 and wait for voice commands.
ENTER YOUR SUBSCRIBER AND ISSUE NUMBERS	5) When TIPS says: "Enter Subscriber Number" (Enter by pushing the numbers and symbols [# or * enclosed in the boxes] on telephone pad ignoring blank boxes) Enter <input type="checkbox"/> <input type="checkbox"/> <input type="checkbox"/> <input type="checkbox"/> <input type="checkbox"/> <input type="checkbox"/> <input type="checkbox"/> <input type="checkbox"/> <input type="checkbox"/> <input type="checkbox"/> <input type="checkbox"/> # 6) When TIPS says "Enter magazine code & issue code" Enter <input type="checkbox"/> <input type="checkbox"/> # <input type="checkbox"/> <input type="checkbox"/> # <input type="checkbox"/> <input type="checkbox"/> #
ENTER YOUR INQUIRIES	7a) When TIPS says "Enter (next) Inquiry Number" Enter one inquiry selection from below (ignore blank boxes) b) Repeat 7a as needed (maximum 17 inquiry numbers) 1. <input type="checkbox"/> <input type="checkbox"/> <input type="checkbox"/> # <input type="checkbox"/> # 6. <input type="checkbox"/> <input type="checkbox"/> <input type="checkbox"/> # <input type="checkbox"/> # 10. <input type="checkbox"/> <input type="checkbox"/> <input type="checkbox"/> # <input type="checkbox"/> # 14. <input type="checkbox"/> <input type="checkbox"/> <input type="checkbox"/> # <input type="checkbox"/> # 2. <input type="checkbox"/> <input type="checkbox"/> <input type="checkbox"/> # <input type="checkbox"/> # 7. <input type="checkbox"/> <input type="checkbox"/> <input type="checkbox"/> # <input type="checkbox"/> # 11. <input type="checkbox"/> <input type="checkbox"/> <input type="checkbox"/> # <input type="checkbox"/> # 15. <input type="checkbox"/> <input type="checkbox"/> <input type="checkbox"/> # <input type="checkbox"/> # 3. <input type="checkbox"/> <input type="checkbox"/> <input type="checkbox"/> # <input type="checkbox"/> # 8. <input type="checkbox"/> <input type="checkbox"/> <input type="checkbox"/> # <input type="checkbox"/> # 12. <input type="checkbox"/> <input type="checkbox"/> <input type="checkbox"/> # <input type="checkbox"/> # 16. <input type="checkbox"/> <input type="checkbox"/> <input type="checkbox"/> # <input type="checkbox"/> # 4. <input type="checkbox"/> <input type="checkbox"/> <input type="checkbox"/> # <input type="checkbox"/> # 9. <input type="checkbox"/> <input type="checkbox"/> <input type="checkbox"/> # <input type="checkbox"/> # 13. <input type="checkbox"/> <input type="checkbox"/> <input type="checkbox"/> # <input type="checkbox"/> # 17. <input type="checkbox"/> <input type="checkbox"/> <input type="checkbox"/> # <input type="checkbox"/> # 5. <input type="checkbox"/> <input type="checkbox"/> <input type="checkbox"/> # <input type="checkbox"/> #
END SESSION	8) End session by entering <input type="checkbox"/> * <input type="checkbox"/> <input type="checkbox"/> <input type="checkbox"/> # 9) Hang up after hearing final message If you are a subscriber and need assistance, call (603) 924-9281.

Available 24/Hours,
7 Days a Week

If you are not a subscriber fill out the subscription card found in this issue or, call BYTE Circulation 800-423-8912.

*Domestic and Canadian Subscribers Only!
382 BYTE • JUNE 1987

READER SERVICE

To get further information on the products advertised in BYTE, fill out the reader service card by circling the numbers on the card that correspond to the inquiry number listed with the advertiser. This index is provided as an additional service by the publisher, who assumes no liability for errors or omissions.

* Correspond directly with company

Index to Advertisers by Product Category

Inquiry No.	Page No.	Inquiry No.	Page No.	Inquiry No.	Page No.	Inquiry No.	Page No.
HARDWARE							
ADD INS							
9 AHEAD SYSTEMS INC.	308	10 AHEAD SYSTEMS INC.	308	13 ALPHA PRODUCTS	363	27 ATI TECHNOLOGIES INC.	253
29 ATRONICS	239	60 COMPLETE PC	59	75 CONTROL SYSTEMS	219	74 CONTROL SYSTEMS	219
103 ENGINEERS COLLABORATIVE	362	119 GENOA SYSTEMS CORP.	44	127 HERCULES COMPUTER TECH323		128 HERCULES COMPUTER TECH323	
129 HERCULES COMPUTER TECH66,67		130 HERCULES COMPUTER TECH66,67		139 INTEL CORP.	42,43	141 IO TECH	362
162 LIGHT SPEED	307	191 MICROWAY	128	214 ORCHID TECHNOLOGY	36	215 ORCHID TECHNOLOGY	36
218 OSBORNE MCGRAW-HILL	14	236 PERSONAL COMP. SUPT. GRP.	291	241 PMI	84	242 PMI	84
318 TURNPOINT AMERICA	98	329 VIDEO TECHNOLOGIES	364	332 VOYETRA TECHNOLOGIES	358	346 Z-WORLD	74
HARDWARE PROGRAMMERS							
23 APROTEK	356	375 BP MICROSYSTEMS	360	42 BYTEK CORPORATION	26	44 B&C MICROSYSTEMS	354
45 B&C MICROSYSTEMS	366	81 CURTIS INC.	358	126 GTEK INC.	322	163 LINK COMPUTER GRAPHICS	366
165 LOGICAL DEVICES	270	166 LOGICAL DEVICES	270	INSTRUMENTATION			
11 AJIDA TECHNOLOGIES	366	38 BECKMAN INDUSTRIES	145	48 CAPITAL EQUIPMENT	276	* COMPUTER CONTINUUM	364
99 EI&S	366	101 ELEXOR INC.	360	145 JDR INSTRUMENTS	95	163 LINK COMP. GRAPHIC	366
217 ORION INSTRUMENT	280	256 QUA TECH	359	257 QUA TECH	359	260 QUA TECH	359
266 REAL TIME DEVICES	364	273 SAMSUNG ELECTRON DEVICES	10	274 SAMSUNG ELECTRON DEVICES	10	297 SPRING CIRCLE TECHNOLGY	257
298 SONY ELECTRONIC DEVICES	10	306 TANDON	147	309 TEKTRONIX INC.	64M-P	341 WAYTRON INT'L. INC.	290
343 VENTEL CORP.	17	334 WELLS AMERICAN	21	339 WINTEK CORP.	358	SOFTWARE	
APPL2/MAC APPLICATIONS—Scientific/Technical							
205 NATIONAL INSTRUMENTS 11							
APPLE/MAC LANGUAGES							
174 MANX SOFTW. SYS. 93							
175 MANX SOFTW. SYS. 201							
APPLE2/MAC UTILITIES							
342 WOODCHUCK INDUSTRIES 364							
ATARI/AMIGA LANGUAGES							
4 ABSOFT 338							
IBM/MS-DOS APPLICATIONS							
35 BAY TECHNICAL ASSOC. 121							
36 BAY TECHNICAL ASSOC. 121							
55 COGITATE 350							
56 COGITATE 360							
76 COTTON SOFTWA 350							
84 DAC SOFTWARE 23							
114 FOX SOFTWARE 123							
193 MIGENT SOFTWARE INC. 249							
194 MIGENT SOFTWARE INC. 249							
354 MIGENT SOFTWARE INC. 301							
355 MIGENT SOFTWARE INC. 301							
203 NANTUCKET 39							
204 NANTUCKET 39							
244 PRIDE SOFTW. DEVLPMNT. 179							
245 PRIDE SOFTW. DEVLPMNT. 179							
* RAIMA CORP. 20							
275 SBT CORPORATION 303							
277 SCR CORPORATION 360							
<i>Continued</i>							

READER SERVICE

Also included in this issue:
Special Advertising Supplement for Priority One Electronics
to U.S. Subscribers

Inquiry No.	Page No.
<i>Continued</i>	
* SOFTWARE PUBLISHING.....	163
343 WORTHINGTON DATA SOLNS.....	120
IBM/MS-DOS APPLICATIONS—	
Miscellaneous	
* TRANSEC SYSTEMS.....	70
IBM/MS-DOS APPLICATIONS—	
Scientific/Technical	
37 BBN SOFTWARE.....	154
172 MACNEAL-SCHWENDLER.....	12
173 MACNEAL-SCHWENDLER.....	12
178 MATHSOFT.....	47
237 PERSONAL TEX.....	306
296 SPECTRUM SOFT.....	191
298 SPSS INC.....	172
299 STSC INC.....	125
301 SYSTAT INC.....	159
302 SYSTAT INC.....	159
IBM/MS-DOS APPLICATIONS—	
Word Processing	
149 JHL RESEARCH.....	356
IBM/MS-DOS—CAD	
20 AMERICAN SMALL BUSINESS.....	139
369 AUTODESK.....	15
46 CAD SOFTWARE.....	300
182 CADKEY.....	53
47 CADSOFT SYSTEMS.....	92
360 ENTERPRISE SOFTW. PROD.....	314
106 EVOLUTION COMPUTER.....	215
107 EVOLUTION COMPUTER.....	215
111 FORESIGHT RESOURCES.....	259
112 FORESIGHT RESOURCES.....	259
116 GAV.....	319
117 GENERIC SOFTWARE.....	91
118 GENERIC SOFTWARE.....	91
124 GREAT SOFTWESTERN.....	114
184 MICROGRAFX.....	327
331 VISIONICS.....	304
340 WINTEK CORP.....	5
IBM/MS-DOS COMMUNICATIONS	
40 BIT SOFTWARE.....	302
* CLEO SOFTWARE.....	274
54 COEFFICIENT SYSTEMS.....	8
366 FTP SOFTWARE.....	364
122 GRAFPOINT.....	362
154 KEA SYSTEMS LTI.....	358
155 KEA SYSTEMS LTI.....	358
351 PERSOFT INC.....	55
352 PERSOFT INC.....	55
353 PERSOFT INC.....	55
283 SOFTKLONE DISTRIBUTING.....	28
286 SOFTRONICS.....	358
371 SOFTWARE LINK.....	27
372 SOFTWARE LINK.....	27
336 WHITE CRANE SYSTEMS.....	92
337 WHITE CRANE SYSTEMS.....	92

Inquiry No.	Page No.
IBM/MS-DOS—GRAPHICS	
77 CRAYON COMP. CORP.....	364
IBM/MS-DOS—LANGUAGES	
24 ARITY CORPORATION.....	233
373 BORLAND INT'L.....	CII,1
374 BORLAND INT'L.....	CII,1
91 DIGITAL INC.....	299
102 ELLIS COMPUTING IN.....	78
* GIMPEL SOFTWARE.....	138
* GOLD HILL COMPUTE.....	96,97
361 HCR CORP.....	310
157 LAHEY COMP. SYSTEMS.....	269
159 LATTICE INC.....	242
161 LIFEBOAT ASSOC.....	206
167 LOGITECH.....	61
168 LOGITECH.....	61
174 MANX SOFTWARE SYS.....	93
175 MANX SOFTWARE SYS.....	201
176 MARK WILLIAMS CO.....	29
* MICROSOFT CORP.....	69
188 MICROSOFT CORP.....	152,153
189 MICROSOFT CORP.....	152,153
270 RYAN MCFARLAND.....	75
271 RYAN MCFARLAND.....	75
276 SCIENTIFIC ENG. LABS.....	354
IBM/MS-DOS—UTILITIES	
25 ARIUM.....	33
26 ARIUM.....	33
28 ATRON CORP.....	77
31 AVOCET SYSTEMS INC.....	288
82 CUSTOM SOFTWARE SYS.....	86
120 GOLDEN BOW SYS.....	350
121 GOLDEN BOW SYS.....	356
131 HERSEY MICRO CONSLTNG.....	158
140 INTELLISOFT.....	221
176 MARK WILLIAMS CO.....	29
177 MARK WILLIAMS CO.....	31
185 MICROPORT.....	35
198 MIX SOFTWARE.....	255
231 PERFORMANCE.....	364
239 PETER NORTON.....	271
238 PETER NORTON.....	271
* QUAID SOFTWARE.....	
285 SOFTLOGIC SOLUTIONS.....	127
287 SOFTWARE DEVLPMNT. SYS.....	30
291 SOLUTION SYSTEMS.....	222
300 SYBIS.....	
OTHER APPLICATIONS—	
Business/Office	
220 PATTON & PATTON.....	360
OTHER APPLICATIONS—	
Miscellaneous	
344 XEMAG.....	320
OTHER APPLICATIONS—	
Scientific/Technical	
98 ECOSOFT.....	324

Inquiry No.	Page No.
OTHER—LANGUAGES	
158 LANGUAGE PROC. INC.....	313
174 MANX SOFTWARE SYS.....	93
175 MANX SOFTWARE SYS.....	201
OTHER—UTILITIES	
287 SOFTWARE DEVELOPMENT SYS.30	
MAIL ORDER/RETAIL	
7 ADVANCED COMP. PROD.....	365
363 APPLD. MICRO TECHNOLGY.....	354
32 A+ COMPUTER RESPONSE.....	354
* CALIFORNIA DIGITAL.....	257
53 CLUB AT.....	
58 COMPETITIVE I.....	
62 COMPUSAVE.....	
66 COMPUTER FRIENDS.....	193
67 COMPUTER LIBRARY.....	285
68 COMP. MAIL ORDER.....	56,57
69 COMPUTER VALLEY.....	352
71 COMPUTER WAREHOU.....	278
70 COMPUTER WAREHOUSE.....	278
93 DISK WORLD!INC.....	358
94 DISKOCOTECH.....	366
95 DISKETTE CONNECTION.....	359
64 DISKMASTER.....	356
92 DISKS PLUS.....	
* HARMONY COMPUTERS.....	76
135 IC EXPRESS.....	320
367 INFOTRONICS.....	148
368 INFOTRONICS.....	148
143 JADE COMPUTER.....	370,371
144 JAMECO ELECTRONICS.....	368,369
146 JDR MICRODEVICES.....	372,373
147 JDR MICRODEVICES.....	374,375
148 JDR MICRODEVICES.....	376,377
400 LOGICSOFT.....	224A-F
171 LONE STAR SOFTWARE.....	357
179 MEAD COMPUTER.....	255
180 MEGASOFT.....	360
183 MICROCOM SYSTEMS.....	32
* MICROMINT.....	305
197 MICROPROC. UNLTD.....	358
186 MICROSERVE.....	234
192 MICROWAY.....	189
* MINORITY HIGH TECH INDS.....	284
199 MONEYSWORTH.....	72,73
221 PC AMERICAN MARKETING.....	205
370 PC CLUB.....	250
223 PC NETWORK.....	347
224 PC NETWORK.....	348,349
240 PINECOM COMPUTER.....	351
160 PROGRAMMER'S PARADISE.....	196,197
249 PROGRAMMER'S SHOP.....	283
250 PROGRAMMER'S SHOP.....	283
252 P.D.SIG.....	356
253 QIC RESEARCH.....	243
254 QSF INC.....	267
294 SCSI.....	
195 SCSI.....	

Inquiry No.	Page No.
280 SILICON SPECIALITIES.....	87
281 SILICON SPECIALITIES.....	87
284 SOFTLINE CORP.....	83
290 SOFT/PLUS RESEARCH.....	364
303 S'NW ELECTR. & APPL.....	78
304 S-100 DIV.696 CORP.....	361
305 S-100 DIV.696 CORP.....	361
364 TIMELINE.....	353
317 TRI-STATE COMPUTER.....	362
319 T&T COMPUTER PRODS.....	350
333 WAREHOUSE DATA.....	71
DESKTOP PUBLISHING	
365 ADDISON.....	A. 276
6 ADOBE.....	186
* LOTUS DEVELOPMENT.....	273
OPERATING SYSTEMS	
151 KADAK PRODUCTS.....	82
190 MICROWARE SYSTEMS.....	268
ON-LINE SERVICES	
450 BYTE INFO. EXCHG. (BIX).....	337
63 COMPUSERVE.....	296
* DOW JONES NEV.....	/AL. 85
335 INFOMASTER.....	13
EDUCATIONAL/ INSTRUCTIONAL	
* BYTE CIRCULATION.....	331
* BYTE MARKETING.....	335
187 MICROSERVE.....	234
356 OSBORNE MCGRAW-HILL.....	316
330 UPTIME.....	19
MISCELLANEOUS	
30 AVIS RENT-A-CAR.....	149
* BEST WESTER.....	282
49 CASIO INC.....	185
61 COMPUTATA.....	TORS 360
272 SAFEWARE.....	350
* SHARP ELECTRONICS.....	329
* TINNEY, ROBERT.....	333
RECRUITMENT	
* MICROSOFT CORP.....	277

* Correspond directly with company.

PLACE
POSTAGE
HERE

BYTE

READER SERVICE
PO Box 298
Dalton, MA 01227-0298
USA

PLACE
POSTAGE
HERE

BYTE

READER SERVICE
PO Box 298
Dalton, MA 01227-0298
USA

INTRODUCING THE PINWRITER P9XL. YOU WON'T BELIEVE WHAT IT DOES TO THE AVERAGE BUSINESS LETTER.



Fasten your seatbelts. The new Pinwriter® P9XL printer from NEC is about to take off.

It cruises at 400 characters per second in draft mode, 140 characters per second in letter quality mode.

It's our fastest printer yet.

Which means it can really make those business letters fly. In fact, no other 24-pin printer is faster.

Actual print sample from the Pinwriter P9XL printer.

And because it uses a 24-pin printhead and a multistrike film ribbon—the same kind that's used in typewriters and letter-quality printers—the P9XL also delivers better print quality than its competitors. It even prints in color.

But it's not limited to letters. The Pinwriter P9XL is a true multi-purpose printer that can fly through payroll, invoices, continuous forms, multi-part forms—just about any business or office application.

Best of all, it's from NEC—the world's largest manufacturer of 24-pin printers. The company that consistently offers you the highest reliability ratings in the industry. (You can expect your P9XL to run for five years before it might need a repair.)

So don't waste any more time. Fly down to your nearest dealer and ask to see the new Pinwriter P9XL. Or call NEC at 1-800-343-4418 (in MA, (617) 264-8635). Or if you prefer, write to NEC Information Systems, Dept. 1610, 1414 Massachusetts Ave., Boxborough, MA 01719.



NEC PRINTERS. THEY ONLY STOP WHEN YOU WANT THEM TO.

NEC

NEC Information Systems, Inc.

Inquiry 206

**“Ok...
But why
Tandy
Computers?”**



“In a word...quality.”

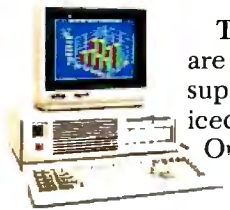

Tandy 3000 HD

Tandy® computers are designed, built, supported and serviced by Radio Shack. Our total commitment assures a high degree of product quality and, just as important, customer satisfaction long after the sale.

Quality-built in the USA. Our MS-DOS® personal computer line is made in America in our own

manufacturing plants. We control quality, from initial assembly to completed and tested product.

Nationwide Support. Over 1200 Radio Shack Computer Centers are ready to help you choose the latest in computer technology, backed by quality support.

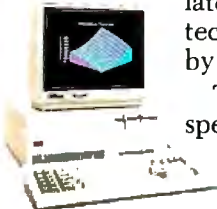

Tandy 3000 HL

Training and specialized software instruction is available at your



Tandy 1000 SX

place of business or ours, in 60 major market areas.

We've got what it takes. Like commercial leasing plans. And service performed

by technicians who work for the same company that manufactured and sold you your computer.

You expect quality . . . and you get it from Radio Shack.

TANDY COMPUTERS: In Business . . . for Business™

MS-DOS/Reg. TM Microsoft Corp.

Radio Shack®
COMPUTER CENTERS

A DIVISION OF TANDY CORPORATION

Inquiry 262