

BYTE

THE SMALL SYSTEMS JOURNAL®

MARCH 1988 VOL.13, NO.3

\$3.50 IN UNITED STATES
\$4.50 IN CANADA / £1.95 IN U.K.
A MCGRAW-HILL PUBLICATION
0360-5280

PRODUCT FOCUS

Enhanced EGA/VGA Boards

IN DEPTH

The New Coprocessors

The fastest-ever PC number crunching

**Compaq's Weitek
Math Coprocessor System**

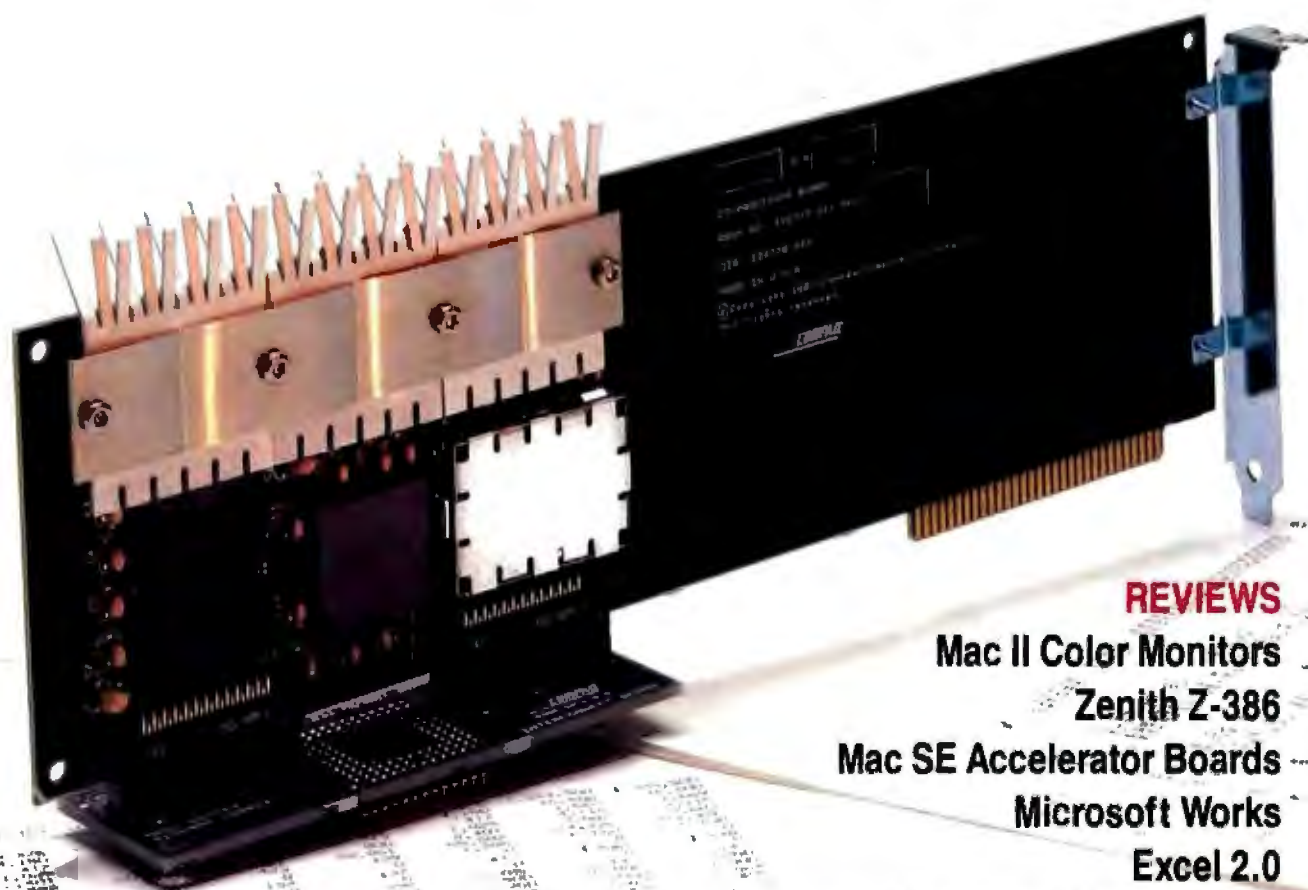

REVIEWS

Mac II Color Monitors

Zenith Z-386

Mac SE Accelerator Boards

Microsoft Works

Excel 2.0

PowerMate 2 and Vectra ES/12

Tandy 1400 LT

Why Paradox

"Paradox* is once again the top-rated program, with the latest version scoring even higher than last year's top score." (Software Digest's July 1987 Ratings Report—an independent comparative ratings report for selecting IBM PC Business software).

All tests for the Ratings Report were done by the prestigious National Software Testing Laboratory, Philadelphia, PA, and the message is crystal clear: there is no better relational database manager than Paradox.

NSTL tested 12 different programs and amongst other results, discovered that Paradox is 3 times faster than dBASE; 6 times faster than R:BASE on a two-file join with subtotals test.

Paradox does the impossible: combines ease-of-use with power and sophistication

Even if you're a beginner, Paradox is the only relational database manager that you

can take out of the box and begin using right away.

Because Paradox employs state-of-the-art artificial intelligence technology, it does almost everything for you—except take itself out of the box.

If you've ever used 1-2-3* or dBASE*, you already know how to use Paradox. It has Lotus-like menus, and Paradox documentation includes "A Quick Guide to Paradox for Lotus users," and "A Quick Guide to Paradox for dBASE users."

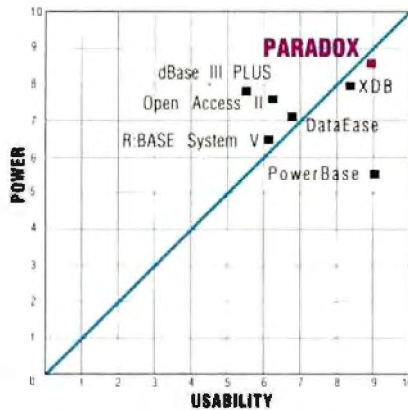

Source: Software Digest*

Ideal programs have high levels of both power and usability. Programs plotted in the upper righthand portion of the diagram above come closest to achieving that ideal.

“ Paradox still offers superior import/export facilities using Lotus 1-2-3, dBASE, ASCII and other file types. It transfers between formats with stunning speed

Rusel DeMarla, PC Week ”

Paradox responds instantly to "Query-by-Example"

The method you use to ask questions is called Query-by-Example. Instead of spending time figuring out *how* to do the query, you simply give Paradox an example of the results you're looking for. Paradox picks up the example and automatically seeks the fastest way of getting the answer. Paradox, unlike other databases, makes it just as easy to query multiple tables simultaneously as it is to query one.

Source: Software Digest*

Software Digest Rating Overall Evaluation	Program Name	Version Tested	Ease of Learning	Ease of Use	Error Handling	Performance	Versatility	Memory Requirement	Price
☆☆☆☆	Paradox	1.1	■	■	■	■	■	512K	\$495
☆☆☆☆	XDB	1.10	■	■	■	■	■	320K	\$750
☆☆☆	PowerBase	2.3	■	■	■	■	■	384K	\$349
☆☆☆	Open Access II	2.0	■	■	■	■	■	256K	\$395
☆☆☆	DataEase	2.5/2	■	■	■	■	■	384K	\$600
☆☆	dBASE III PLUS	1.1	■	■	■	■	■	384K	\$695
☆☆	R:BASE System V	1.1	■	■	■	■	■	512K	\$700

RATINGS KEY
(On a scale of 0 to 10)
Overall Evaluation
☆☆☆☆ 9.0 or higher
☆☆☆☆ 8.0 - 8.9
☆☆☆☆ 7.0 - 7.9
☆☆ 6.0 - 6.9
☆☆ 5.0 - 5.9
All Other Ratings
■ 7.0 - 9.9
■ 5.0 - 6.9
■ UNDER 5.0

Paradox is the best

There's no power like Paradox Power

PROGRAM	Overall Power	Overall Versatility	Search without an Index (sec.)	Subtotal on Two-File Join (sec.)	Subtotal on Three-File Join (sec.)	Subtotal on Three-File Join (sec.)	Four-File Join (sec.)	Many-to-Many Join (sec.)	Many-to-Many Join (sec.)	Many-to-Many Join (sec.)	Many-to-Many Join (sec.)	Many-to-Many Join (sec.)
Paradox	8.4	9.2	7.5	1.0	6	100	221	325	459	364	322	18
dBASE III PLUS	7.9	8.9	6.9	0.5	17	93	525	1013	646	449	445	39

Source: Software Digest*

Paradox saves you from future shock

Trends for the future with Paradox

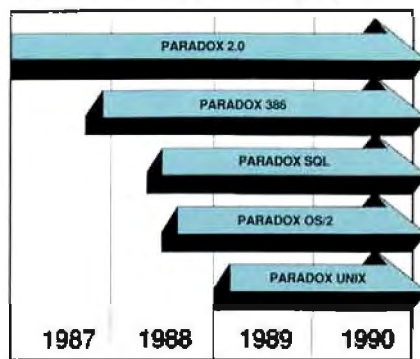

Paradox 386 allows users to take advantage of 16 Megabytes of Memory on a 386 machine. This allows Paradox users to work with databases that could in the past only be handled by minicomputers and mainframes.

Your investment today in Paradox applications is protected as new hardware and operating systems are used in your company. Paradox 2.0 applications will run unchanged on Paradox 386, Paradox OS/2, Paradox Unix and Paradox SQL! All versions of Paradox will be completely application and menu compatible. Paradox SQL will allow access to remote databases via SQL. Users will just type in a query as they normally would, and Paradox will translate that Query to SQL.

“ Paradox 2.0 will do for the LAN what the spreadsheet did for the PC

David Schulman,
Bendix Aerospace ”

Paradox makes your network run like clockwork

Paradox is just as valuable to multi and network users as it is to single users. It runs smoothly, intelligently and so transparently that multiusers can access the same data at the same time—without either being aware of each other or getting in each other's way. It works exactly the same way whether you're flying solo or as part of the crew.

“ Anyone who hasn't seen the network version of Paradox should take a look. Ansa has dramatically advanced the state of the art in multiuser network databases

Phil Lemmons,
BYTE

Paradox was a delight to use, both as a stand-alone product and from a local area network server.

Don Crabb,
InfoWorld ”

How to make your network network

To run Paradox 2.0 or the Paradox Network Pack on a network you need

- Novell with Novell Advanced Network version 2.0A or higher
- 3Com 3Plus with 3Com 3+ operating system version 1.0.11 or higher
- IBM Token Ring or PC Network with IBM PC Local Area Network Program version 1.12 or higher
- Tropic Tapesety version 1.4 or higher
- AT&T Starlan Network with AT&T PC 8300 Network Program version 1.0
- Other network configurations that are 100% compatible with DOS 3.1 and one of the listed networks

System Requirements for Single User:

- DOS 2.0 or higher
- IBM® PS/2 and PC, Compaq® PC families and other 100% compatibles
- 512K RAM
- Two disk drives, 3½-inch and 5¼-inch supported
- Compatible monochrome, color, or EGA monitor with adapter

System Requirements for the Network Workstation:

- DOS 3.1 or higher
- 640K RAM
- Any combination of hard, floppy, or no disk drives
- Compatible monochrome, color, or EGA monitor with adapter

Optional Equipment:

- EMS and EEMS Boards; AST RAMpage Board,™ Intel Above Board™ or other expanded memory adapters
- Printers: Compatible dot matrix, letter quality, or laser printer

*Reprinted with permission by Software Digest from its July 1987 report covering 12 relational database programs

Test was designed and executed by NSTL. A 1,000 record and a 10,000-record file were joined. A short text field from the 1,000-record file and a numeric field from the 10,000-record file were selected (using the 1,000 record file indexes). The short text field was grouped and sorted in ascending order, the numeric field was subtotaled for each group and the results output to a dolt printer. Test times from the last keystroke on the command sequence until return of program control were recorded and averaged.

Paradox is a registered trademark of Ansa Software. Ansa is a Borland International company. Other brand and product names are trademarks or registered trademarks of their respective holders. Copyright ©1988 Borland International, Inc. B1-1205

Paradox: the top-rated relational database manager in the world...

PARADOX

Introduction



Ansa

Paradox: the new corporate standard

Paradox automatically updates your data and lets you control access to information

In "Co-Edit" mode, changes made by anyone are automatically updated to everyone. You can pre-set a "Screen-Refresh" interval to occur anywhere from 1-second to 1-hour intervals. (If you don't make a pre-set choice, Paradox automatically updates every 3 seconds so that your screen always shows you updated data).

While Paradox 2.0 lets everyone share and update information simultaneously, you can configure it to keep secrets secret.

You can restrict others' rights in a variety of ways with safeguards protecting confidential files and/or giving someone "Read Only" rights which is to allow "View," but prevent "Change." The Paradox technique—automatic file and record locking—ensures data accuracy and integrity in any multiuser environment.

For a brochure or the dealer nearest you call (800) 543-7543

PARADOX

by Ansa

A Borland Company

“ With Version 2.0, Paradox becomes a sophisticated multiuser product that boasts an impressive selection of data-protection features and password-security levels

Rusel DeMaria,
PC Week ”

Get serious support for serious Paradox application programming

When you subscribe to the Paradox Developer's Resource Program (PDRP), you get all the resources and support you need for sophisticated Paradox application development: unlimited access to our toll-free PAL programmers support line; the Paradox Developer's Toolkit; a subscription to *Turbo Technix*, Borland's bi-monthly technical magazine; and a 20% discount on the Paradox User's Journal published by the Cobb Group.

Call our Customer Service Department at (408) 438-8400 for your free PDRP information kit with all the details.



Circle 40 on Reader Service Card (DEALERS: 41)

Contents

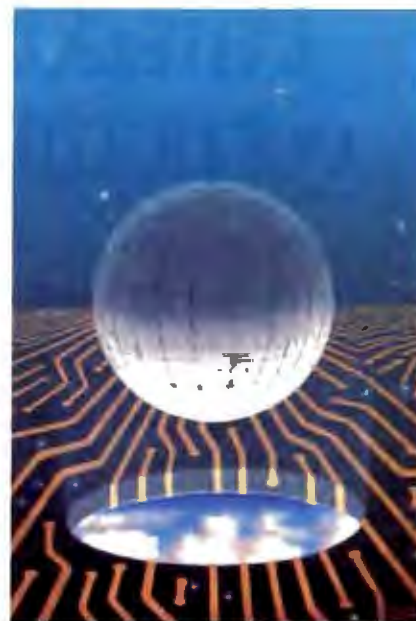

Floating-Point Processing/196

65 PRODUCTS IN PERSPECTIVE

67 What's New

89 Short Takes

SideKick Plus, a major upgrade of Borland's TSR Manuscript 2.0, Lotus's word processor enhanced Friendly Finder, a dBASE file-retrieval program Focal Point, a Mac HyperCard application PC WeatherPro, a weather monitor for your PC Tech*Graph*Pad 2.1, a technical graphing program

REVIEWS

102 **Product Focus:** Enhanced EGA and VGA Boards

by Curtis Franklin Jr.
Should you buy a VGA or will an enhanced EGA suffice for less money?

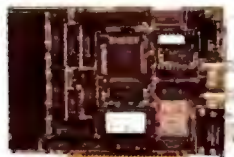

115 **The Zenith Z-386**

by Ed McNierney
Zenith's powerful desktop provides outstanding performance and flawless compatibility.

121 **NEC PowerMate 2 and HP Vectra ES/12**

by John Unger
Two 80286-based AT compatibles that offer high performance and excellent expansion capability.

127 **The Tandy 1400 LT**

by David Satz
A low-cost, lightweight laptop with good performance.

134 **Screening Macintosh II Color Monitors**

by Joel West and Neil Rhodes
Three monitors that take advantage of the Mac II's flexible display capabilities.

139 **Pushing the Mac SE**

by Laurence H. Loeb
A look at two accelerator boards: Do they really double the Mac SE's processing power?



145 **Trilogy: A New Approach to Logic Programming**

by Alex Lane
An alternative to Prolog with windows and other interesting twists.

155 **Excel Extraordinaire**

by Rich Malloy
Microsoft's successful Macintosh spreadsheet shines on the IBM PC AT.

157 **Microsoft Works**

by Nicholas M. Baran
The flexible exchange of data is this package's real strength.

162 **Reflex Plus for the Macintosh**

by Charles Spezzano
Reflex has evolved into this faster and easier relational database manager.

COLUMNS

169 **Computing at Chaos Manor: Transparent Conversions? Hah!**

by Jerry Pourmelle
A look at QuickBASIC 4.0 and Turbo BASIC, and Jerry presents his awards for 1987.

187 **Applications Only: Annual Revelations**

by Ezra Shapiro
Ezra's yearly look at the products he uses.

195 IN DEPTH: Floating-Point Processing

196 Introduction

197 **Avoiding Coprocessor Bottlenecks**

by Mauro Bonomi
Memory mapping helps overcome bandwidth problems between the CPU and floating-point coprocessor.

205 **The Intel 80387 vs. The Weitek 1167**

by Tom Thompson

207 **Programming the 80387 Coprocessor**

by Prakash Chandra
A look at the key differences between this floating-point unit and the earlier 8087 and 80287.



In Depth/195



Features/241

- 217 Floating-Point Survival Kit**
by Pete Wilson
An overview of floating-point arithmetic, standards, benchmarks, and high-performance designs.
- 229 How to Get Better Floating-Point Results**
by Carl Byington
A look at the trade-offs involved in emulating floating-point hardware, and the implications for programmers.
- 238 Resource Guide**

241 FEATURES

- 243 Ciarcia's Circuit Cellar:
The BCC180 Multitasking Controller
Part 3: Memory Management and Windowing**
by Steve Ciarcia
The BCC180's multitasking BASIC compiler can operate on a variety of hardware.
- 249 Better Bit-Mapped Lines**
by Jerry R. Van Aken and Carrell R. Killebrew Jr.
Bresenham's line algorithm provides a quick way for your computer to draw a straight line.
- 255 Focus on Algorithms:
Multicolumn Paged Text**
by Dick Pountain
This program will help you to explore desktop-publishing software technology.
- 265 It's All in the Symbols**
by Merrill Cornish
We are beginning to suspect that the "things" that can be represented by numbers might be in the minority.
- 273 System Calls in Modula-2**
by Richard Rankin
Pascal's successor gives you easy control over your PC's BIOS and DOS functions.

DEPARTMENTS

- 6 Editorial: Not Just for the Macfaithful**
- 11 Microbytes**
- 22 Letters**
- 34 Chaos Manor Mail**
- 38 Ask BYTE**
- 42 Circuit Cellar Feedback**
- 51 Book Reviews**
- 323 Coming Up in BYTE**

READER SERVICE

- 322 Editorial Index by Company**
- 325 Alphabetical Index to Advertisers**
- 327 Index to Advertisers by Product Category**
- Inquiry Reply Cards: after 328**

PROGRAM LISTINGS

- From BIX: see 278**
- From BYTENet: call (617) 861-9764**
- On disk or in print: see card after 296**



BYTE (ISSN 0360-5280) is published monthly with an additional issue in October by McGraw-Hill Inc. Founder James H. McGraw (1860-1948). Executive, editorial, circulation, and advertising offices: One Phoenix Mill Lane, Peterborough, NH 03458, phone (603) 924-9281. Office hours: Monday through Thursday 8:30 AM-4:30 PM, Friday 8:30 AM-1:00 PM Eastern Time. Address subscriptions to BYTE Subscriptions, P.O. Box 7640, Teaneck, NJ 07666-9866. Postmaster: Send address changes, USPS Form 3579, undeliverable copies, and fulfillment questions to BYTE Subscriptions, P.O. Box 7643, Teaneck, NJ 07666-9866. Second-class postage paid at Peterborough, NH 03458 and additional mailing offices. Postage paid at Winnipeg, Manitoba. Registration number 9321. Subscriptions are \$22 for one year, \$40 for two years, and \$58 for three years in the U.S. and its possessions. In Canada and Mexico \$25 for one year, \$45 for two years, \$65 for three years. \$69 for one year air delivery to Europe. \$1,000 yen for one year air delivery to Japan, \$5,600 yen for one year surface delivery to Japan, \$37 surface delivery elsewhere. Air delivery to selected areas at additional rates upon request. Single copy price is \$3.50 in the U.S. and its possessions, \$4.25 in Canada and Mexico, \$4.50 in Europe, and \$5 elsewhere. Foreign subscriptions and sales should be remitted in U.S. funds drawn on a U.S. bank. Please allow six to eight weeks for delivery of first issue. Printed in the United States of America.

Address editorial correspondence to Editor, BYTE, One Phoenix Mill Lane, Peterborough, NH 03458. Unacceptable manuscripts will be returned if accompanied by sufficient postage. Not responsible for lost manuscripts or photos. Opinions expressed by the authors are not necessarily those of BYTE.

Copyright © 1988 by McGraw-Hill Inc. All rights reserved. Trademark registered in the United States Patent and Trademark Office. Where necessary, permission is granted by the copyright owner for libraries and others registered with the Copyright Clearance Center (CCC) to photocopy any article herein for the flat fee of \$1.50 per copy of the article or any part thereof. Correspondence and payment should be sent directly to the CCC, 29 Congress St., Salem, MA 01970. Specify ISSN 0360-5280/83. \$1.50. Copying done for other than personal or internal reference use without the permission of McGraw-Hill Inc. is prohibited. Requests for special permission or bulk orders should be addressed to the publisher. BYTE is available in microform from University Microfilms International, 300 North Zeeb Rd., Dept. PR, Ann Arbor, MI 48106 or 18 Bedford Row, Dept. PR, London WC1R 4EJ, England.

Subscription questions or problems should be addressed to: BYTE Subscriber Service, P.O. Box 7643, Teaneck, NJ 07666-9866.

BYTE

THE SMALL SYSTEMS JOURNAL

EDITOR IN CHIEF
Frédéric S. Lange

PUBLISHER/GROUP VICE PRESIDENT
J. Burl Totaro

OPERATIONS
Glenn Hartwig *Associate Managing Editor*

REVIEWS (Hardware, Software, Product Focus)
Cathryn Baskin *Associate Managing Editor*, Dennis Allen *Senior Technical Editor*, Software, Curtis Franklin Jr. *Senior Testing Editor*, BYTE Lab

NEWS AND TECHNOLOGY (Microbytes, What's New, Short Takes)
Rich Malloy *Associate Managing Editor*, D. Barker *Senior Editor*, News and Technology, Anne Lent *Senior Editor*, New Products
Peterborough: Martha Hicks *Associate News Editor*, Jeff Merron *Associate News Editor*, Stan Miaszkowski *Associate News Editor*
West Coast: Gene Smarte *Bureau Chief*, Costa Mesa, Jonathan Erickson *Senior Technical Editor*, San Francisco, Nicholas Baran *Associate Technical Editor*, San Francisco, Jeffrey Bertolucci *Editorial Assistant*, San Francisco

SENIOR TECHNICAL EDITORS
Ken Sheldon *Features*, G. Michael Vose *In Depth*, Richard Grehan *At Large*, Jane Morrill *Tazelaar At Large*, Tom Thompson *At Large*

TECHNICAL EDITORS
George A. Stewart, Eva White, Stanley Wszola

CONSULTING EDITORS
Steve Garcia, Jerry Pournelle, Ezra Shapiro

CONTRIBUTING EDITORS
Jonathan Amsterdam *Programming Projects*, Mark Dahmke *Video, Operating Systems*, Mark Haas *At Large*, Rik Jadrnick *CAD, Graphics, Spreadsheets*, Robert T. Kurosaka *Mathematical Recreations*, Alastair J. W. Mayer *Software*, Alan R. Miller *Languages and Engineering*, Dick Pountain *Algorithms*, Roger Powell *Computers and Music*, Phillip Robinson *Semiconductors*, Jon Shiell *High Performance Systems*, Ernest Teilo *Artificial Intelligence*

COPY EDITORS
Lauren Stickler *Chief*, Susan Colwell, Judy Connors-Tenney, Jeff Edmonds, Nancy Hayes, Cathy Kingery, Margaret A. Richard, Warren Williamson

EDITORIAL ASSISTANTS
Peggy Dunham *Office Manager*, L. Ryan McCombs, June N. Sheldon

ART
Nancy Rice *Director*, Joseph A. Gallagher *Assistant Director*, Jan Muller *Assistant*, Alan Easton *Technical Artist*

PRODUCTION
David F. Anderson *Director*, Denise Chartrand, Michael J. Lonsky, Virginia Reardon

TYPOGRAPHY
Sherry Fiske *Systems Manager*, Selinda Chiquoine, Donna Sweeney

ADVERTISING/PRODUCTION (603) 924-8448
Lisa Wozniak *Supervisor*, Lyde Clark *Senior Account Coordinator*, Karen Cilley, Linda Fluhr, Jeanne Gatecombe, Brian Higgins, Rod Holden, Wei Chiu Li *Quality Control Manager*, Julie Murphree *Advertising/Production Coordinator*

ADMINISTRATION
Beverly Jackson *Publisher's Assistant*

MARKETING COMMUNICATIONS
Horace T. Howland *Director*
Laurie MacMillan *Promotion Manager*, Wilbur S. Watson *Marketing Services Manager*, Lisa Jo Steiner *Marketing Assistant*, Stephanie Warnesky *Marketing Art Director*, Sharon Price *Associate Art Director*, Julie Perron *Market Research Analyst*

PLANNING AND RESEARCH
Michèle Perron *Director*
Falih Kluntz *Copyrights Coordinator*, Cynthia Damato *Sands Reader Service Coordinator*

FINANCIAL SERVICES
Philip L. Penny *Director of Finance and Services*, Kenneth A. King *Business Manager*, Christine Monkton *Assistant*, Marilyn Haigh, Diane Henry, JoAnn Walter, Jaime Huber

CIRCULATION
Den McLaughlin *Director*
James Bingham *Newsstand Sales Manager*, Vicki Weston *Assistant Manager*, Claudette Carwell *Distribution Coordinator*, Karen Desroches *Direct Accounts Coordinator*, Louise Menegus *Back Issues*

PERSONNEL
Patricia Burke *Personnel Coordinator*, Donna Healy *Receptionist*

BUILDING SERVICES
Tony Bennell *Manager*, Cliff Monkton, Mark Monkton, Agnes Perry

BIX

BYTE INFORMATION EXCHANGE

ACTING DIRECTOR
Edward A. Rano Jr.

EXECUTIVE EDITOR
George Bond

SENIOR EDITOR
David Belz

ASSOCIATE EDITORS
Tony Lockwood, Donna Osgood *San Francisco*

MICROBYTES DAILY
D. Barker *Coordinator*, Peterborough: Rich Malloy *New York*, Gene Smarte *Bureau Chief*, Costa Mesa, Nicholas Baran *San Francisco*, Rick Cook *Phoenix*, Jonathan Erickson *San Francisco*, Martha Hicks *Peterborough*, Anne Fischer *Lehi*, Peterborough: Larry Loeb *Wallingford, CT*, Brock N. Meeks *La Mesa, CA*, Jeff Merron *Peterborough*, Stan Miaszkowski *Peterborough*, Wayne Rash Jr. *Washington, DC*, David Reed *Lexington, KY*

GROUP MODERATORS
David Allen *Applications*, Frank Boeman *Artificial Intelligence*, Leroy Castorline *Other*, Marc Greenfield *Programming Languages*, Jim Howard *Graphics*, Gary Kendall *Operating Systems*, Steve Krenak *Computers*, Brock N. Meeks *Telecommunications*, Barry Nance *New Technology*, Donald Osgood *Computers*, Sue Rosenberg *Other*, Jon Swanson *Chips*

BUSINESS AND MARKETING
Doug Webster *Director (603) 924-9027*, Patricia Bausum *Secretary*, Denise A. Greene *Customer Service*, Brian Warnock *Customer Service*, Tammy Burgess *Customer Credit and Billing*

TECHNOLOGY
Clayton Lisle *Director*, Business Systems Technology, MHS: Bill Gamson *Business Systems Analyst*, Jack Peilly *Senior Business Systems Analyst*, Bob Dorobis *Business Systems Analyst*

ADVERTISING SALES
Dennis J. Riley *Director*, (603) 924-9281
Sandra Foster *Administrative Assistant*

NEW ENGLAND
ME, NH, VT, MA, RI, ONTARIO, CANADA & EASTERN CANADA
Paul McPherson Jr. (617) 262-1100

ATLANTIC
NY, NYC, CT, NJ (NORTH)
Leah G. Rabinowitz (212) 312-2098
Dick McGurk (203) 968-7111

EAST
PA, KY, OH, NJ (SOUTH), MD, VA, W. VA, DE, D.C.
Daniel Ferro (215) 496-3633

SOUTHEAST
NC, SC, GA, FL, AL, TN
Carolyn F. Lovett (404) 252-0826

MIDWEST
IL, MO, KS, IA, ND, SD, MN, WI, NE, IN, MI, MS
Bob Denmead (312) 751-3740

SOUTHWEST, ROCKY MOUNTAIN
CO, WY, OK, TX, AR, LA
Karl Heinrich (713) 482-0757

SOUTH PACIFIC
SOUTHERN CA, AZ, NM, LAS VEGAS
Jack Anderson (714) 557-8292
Tom Harvey (213) 490-5245

NORTH PACIFIC
HI, WA, OR, ID, MT, NORTHERN CA, NV (except LAS VEGAS), UT, WESTERN CANADA
Mike Kisseberth (415) 262-4600
Bill McAfee (415) 349-4100

TELEMARKETING
L. Bradley Browne *Director*
Susan Boyd *Administrative Assistant*

BYTE BITS (2x3)
Dan Harper (603) 924-8630

THE BUYER'S MART (1x2)
Mark Stone (603) 924-3784

REGIONAL ADVERTISING SECTIONS
MID-ATLANTIC, METRO NY & NEW ENGLAND
SOUTHERN CALIFORNIA, SOUTHEAST
Elisa Lister (603) 924-8630

MIDWEST, PACIFIC NORTHWEST, SOUTHWEST, METRO NY & NEW ENGLAND
Scott Gagnon (603) 924-9281

BYTE DECK MAILINGS
National
Ed Ware (603) 924-6100

AZ/IC COMPUTING DECK
COMPUTING FOR ENGINEERS DECK
Mary Ann Goulding (603) 924-9281

EDITORIAL AND BUSINESS OFFICE:

One Phoenix Mill Lane, Peterborough, NH 03458, (603) 924-9281.
West Coast Branch Office: 425 Battery St., San Francisco, CA 94111, (415) 954-9718; 3001 Red Hill Ave., Building #1, Suite 222, Costa Mesa, CA 92626, (714) 557-8292
New York Branch Editorial Office: 1221 Avenue of the Americas, New York, NY 10020, (212) 512-3175
BYTEtel: (617) 861-9784 (set modem at 8-1-N or 7-1-E, 300 or 1200 baud), Fax: (603) 924-7507, Telex: (603) 924-7861
SUBSCRIPTION CUSTOMER SERVICE: Non-U.S. (201) 837-1315; Inside U.S. (outside NJ) 1-800-423-8272; (inside NJ) 1-800-367-0218

Officers of McGraw-Hill Information Systems Company: President Richard B. Miller, Executive Vice Presidents: Frederick P. Jannotti, Construction Information Group, Russell C. White, Computers and Communications Information Group, J. Thomas Ryan, Marketing and International, Senior Vice Presidents-Publishers: Laurence Altman, Electronics; David J. McGrath, Engineering News-Record Group; Vice Presidents: J. Burl Totaro, BYTE; Frank A. Shinal, Dodge; Peter B. McCuen, Communications Information; Vice Presidents: Robert D. Daleo, Controller; Fred O. Jensen, Planning and Development; Michael J. Koeller, Human Resources; Julia Lenaro, Systems Planning and Technology

Officers of McGraw-Hill Inc.: Harold W. McGraw Jr., Chairman; Joseph L. Donno, President and Chief Executive Officer; Robert N. Landes, Executive Vice President, General Counsel and Secretary; Victor D. Serwatski, Executive Vice President and Chief Financial Officer; Sher F. Assa, Senior Vice President, Manufacturing; Robert J. Bahash, Senior Vice President, Finance and Manufacturing; Frank D. Pengtase, Senior Vice President, Treasury Operations; Ralph R. Schurz, Senior Vice President, Editorial
BYTE, BIX and The Small Systems Journal are registered trademarks of McGraw-Hill Inc.

HiWIRE™ Starts the Job that smARTWORK® Finishes



Introducing HiWIRE™

Wintek's smARTWORK® is used by thousands of engineers to design printed-circuit boards. Now Wintek introduces HiWIRE, an electronic-schematic program that is easy to learn and use.

With a click of the mouse button, you can extract symbols from our library of over 700 common components and connect them with wires and buses. You can also easily modify the library's symbols or create your own by combining labels, lines, and arcs.

HiWIRE Advantages

- Easy-to-learn mouse/menu-driven operation
- Complete documentation and tutorial
- Extensive TTL, CMOS, micro-processor, and discrete-component libraries
- Rubberbanding

- Moving, copying, mirroring, and rotating of symbols
- Text-string searching
- Multiple display windows
- High-quality schematics from printers and plotters
- Hierarchical-design support; netlist and bill-of-materials utilities
- Schematic/layout cross checking
- 800 number for free technical support

System Requirements

- IBM Personal Computer, PC XT, or PC AT with 320K RAM, parallel printer port, 2 disk drives, and DOS V2.0 or later
- IBM Color/Graphics Adapter or EGA with RGB color monitor
- Microsoft Mouse
- IBM Graphics Printer or Epson FX/MX/RX-series dot-matrix printer, and/or:

- Houston Instrument DMP-40, 41, 42, 51, 52 or Hewlett-Packard 7470, 7475, 7550, 7580, 7585, 7586 plotter

High Performance at Low Cost

At \$895, HiWIRE delivers quality schematics quickly and easily. You don't need to guess whether or not HiWIRE is right for you. Our money-back guarantee lets you try it for 30 days at absolutely no risk. Call (800) 742-6809 toll free today and put HiWIRE to work tomorrow.

Wintek Corporation
1801 South Street
Lafayette, IN 47904-2993
Telephone: (800) 742-6809
or in Indiana (317) 742-8428
Telex: 70-9079 WINTEK CORP UD



"HiWIRE" is a trademark, and "smARTWORK", "Wintek", and the Wintek logo are registered trademarks of Wintek Corporation.

EDITORIAL

Not Just for the MacFaithful

"Gridlock surrounds S.F. computer show" screamed the headline in the *San Francisco Chronicle*. "More than 20,000 people turned up for the first day of the three-day computer show, compared with 30,000 for all three days of the show last year. Hundreds... were unable to get into a packed keynote address.... There was almost complete gridlock from Market to Howard streets... and traffic backed up onto the Bay Bridge.... Some drivers complained that it took a half hour to go one block."

I'm writing this on the flight back from this winter's MacWorld Expo and can attest that it's all true—and perhaps even a little understated. It was a *great* show, in some ways reminiscent of the early days of microcomputing, with an electric atmosphere, a spirit of innovation and excitement, and a profusion of new hardware and software.

It may be remembered as the show of the expandable Macintosh—a show when there finally were enough innovative products for the full Macintosh line (not just for the Mac II) to satisfy all but the most fanatical criticisms about limited RAM, small and monochromatic screens, inadequate expansion, and unfulfilled visual potential.

My briefcase barely fits under the seat in front of me: It's crammed full of literature and sample software for everything from accelerators and expansion products for the Plus and SE; to 68030-based accelerators, professional-quality animation, and digitized video products for the Mac II; and back to software that lets you accurately and flexibly drive color printers from monochrome Macs. The list goes on and on.

It was a great show. And not just for the MacFaithful.

Cross-Pollination

It's axiomatic that many of the concepts and technologies that had their first widespread commercial appearance on the Mac already have influenced and improved the IBM world. But, until recently, little has gone the other way. It's left the Mac world essentially isolated from the mainstream—a fertile but foreign land to the overwhelming majority of microcomputer users.

Some Mac users like it that way. They

regard the "purity" of the Mac as an almost religious issue. At several of the show's panel discussions, members of the audience actually castigated some manufacturers for "selling out" because they adapted Mac products for PCs, or vice versa.

Some PC users like it that way, too. These are the folks who made up their minds about Apple's "little beige toaster" when it first appeared and don't realize that the current crop of Macs and third-party hardware and software embody the most desirable traits of the IBM side (e.g., expandability and adaptability).

It's silly—dangerous, even—to put on blinders and track only one class of machine, or worse, only one brand of machine: Good ideas know no boundaries, except artificial ones, such as closed minds and closed architectures.

And that's why BYTE (which is sometimes incorrectly perceived as an MS-DOS publication) attends Mac shows. Because no matter whether you're a Mac user or a PC user, you need to know what's going on in the other camp: Sooner or later, you must deal with and choose among the best ideas that emerge there.

This cross-pollination benefits every computer user, and it's a fact of life of microcomputing today: The best features of hardware and software—wherever they originate—*will* eventually show up everywhere. Keeping you informed of these developments, keeping your options open—that's what BYTE is all about.

Some Specifics

At MacWorld, we covered all the best product and technology news virtually live for the Microbytes Daily area of BIX. We then produced a Show Report (see below) immediately after the show closed. I've already mentioned some of the most interesting products—many of which we'll soon be reviewing.

But if you've missed our earlier coverage of MacWorld, here's a sampling of some of the show's other interesting items. As you read them, you'll see many examples of cross-pollination.

- Apple rolls out three new laser printers: from a \$6599 model on the high end to a \$2799 PostScriptless model on the low end, with a \$4599 PostScripted model in the middle.

- Sculley talks of twenty-first century "knowledge navigator."

- Mainstay announces "Agenda-like" program for Mac.

- New Apple product lets MS-DOS PCs be AppleTalk nodes.

- Apple and DEC share technology.

- Activision program lets HyperCard users generate reports.

- WINGZ "integrated spreadsheet" puts graphs, text on one page.

- Truevision, maker of the Targa and Vista graphics cards for the IBM PC, announced a similar card for the Mac II.

- SuperMac's 24-bit color card for the Mac II.

- MacNeal-Schwendler introduces engineering software for Macs.

- Lotus introduces Modern Jazz.

- Mac CAD package has modular design.

- Kodak's first Mac projection pad.

- Program lets you map "information."

- Summagraphics announces digitizer for the Mac.

- Deutsch Research introduces a simulation program for analog and digital circuits.

- SuperMac/Levco brought out programming environments for its TransLink accelerator card.

- Apple Programmers Group offers new versions of MPW Pascal and MPW C.

- Digital film recorder does slides from Mac graphics.

- Two faxes for the Mac.

- Apple resists display PostScript.

- Cricket presents "Cricket Presents."

- Cricket shows beta paint program.

- Radius accelerator runs at 25 MHz.

- WordPerfect for the Mac: The "look and feel" of the Mac with all the keyboard functions of the IBM version.

And much more.

We'll also be producing a Show Report after this month's West Coast Computer Faire. We'll be glad to send you a copy for just the price of the paper, printing, and postage. Just drop us a note (send it to WCCF Show Report, BYTE, One Phoenix Mill Lane, Peterborough, NH 03458); please enclose a check or money order for \$3 and be sure to include your name and mailing address.

—Fred Langa
Editor In Chief
(BIX name: flanga)

A large, metallic robot with a human-like face and a rectangular mouth is holding a Maxell MC-6000 data cartridge in its right hand. The robot is standing in front of a background of clouds. The Maxell logo and model number are visible on the cartridge.

Backup for even the
most advanced hard disk.
The Maxell
1/4" data cartridge.

The loneliest feeling on earth is the feeling that comes right after losing the data you've worked so hard on for so long.

The solution?

Maxell Advanced System 1/4" Data Cartridges. They're fully compatible with all standard and mini 1/4" data tape systems. Perfect for file-by-file backup or mirror-image streaming, creating archival tapes or off-loading data.

And best of all, they bring you the peace of mind which can only come from seeing the Maxell name on your computer products.

Talk to your Maxell distributor about backup for even the most sophisticated computer today. Before it slips your mind.



maxell[®]
THE GOLD STANDARD

Maxell Corp. of America, 22-08 Route 208, Fairlawn, N.J. 07410

OTHERS PALE

SHIPMENTS BY MONTH

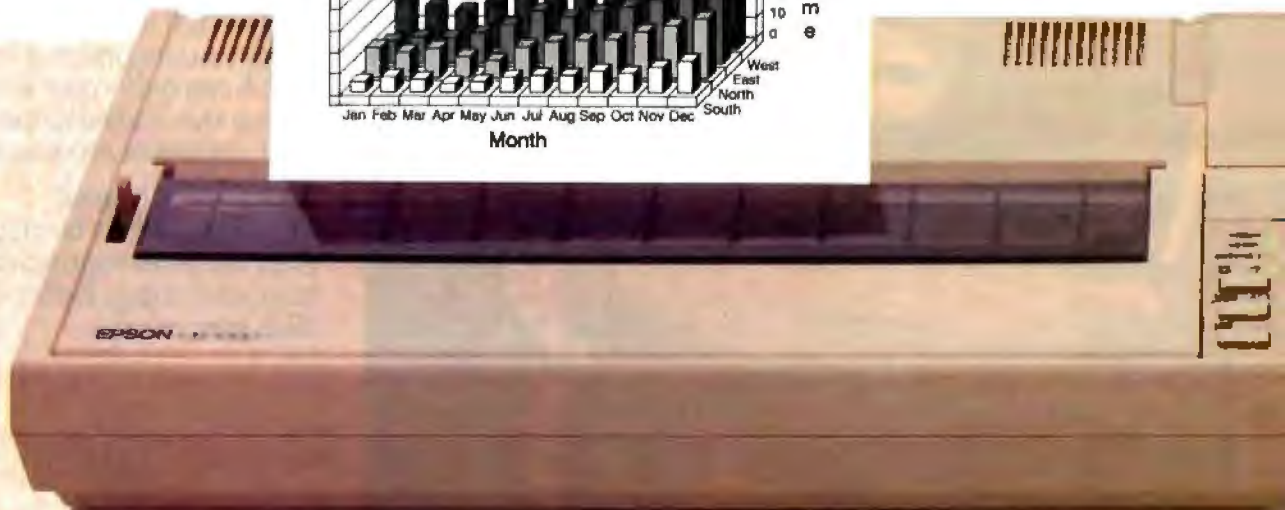
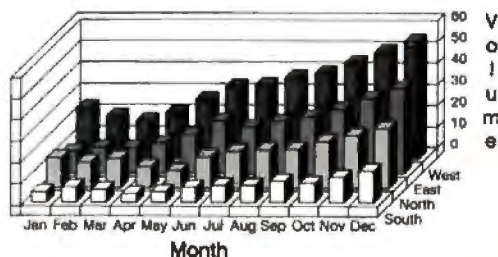

The small printer on the left seems positively unexciting next to the new ALPS ALQ300.

And it's not just because of our colorful personality.

You see, the ALQ300 is a lot faster. It handles bidirectional graphics with flying colors. And for black and white work—spreadsheets, letters, you name it—the ALQ300

zips along as fast as 240 cps.

It can do more things. It has snap in/out 24- or 18-pin print heads. Multiple font cartridges. Paper handling extras like auto-

matic single sheet feed and bottom feed. And of course, it runs with all the most popular PCs and software.

It's much easier to use, too. Because you do everything

and both offer the same great features as the first dot matrix printers with resolution quality. They quietly print at speeds you're versatile. A full range of models, transparencies, multiple-part files, pitches and fonts.

The ALQ300 prints everything from the letter quality text you see here, to high resolution graphics in seven colors.

Y COMPARISON.

SHIPMENTS BY MONTH

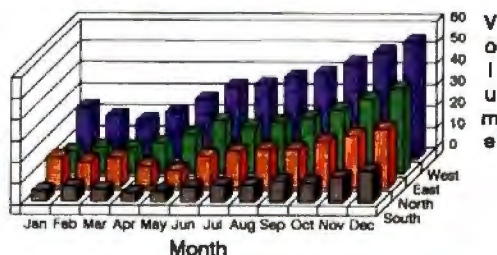

on the front panel. Change type styles and print modes. Load paper. Even override your software. All without software commands or DIP switches.

You may have also noticed that the ALQ300 looks more substantial. It is. Treat it right and it'll run over five years without a breakdown.

You may also expect that the ALQ300 is more expensive. It isn't. Our 24-pin version has a suggested retail price of just \$995.

And our 18-pin model is \$100 less.

Now it's time to make your own comparison. Call us for a free demo or more information at **(800) 828-ALPS**. In California, **(800) 257-7872**.

And you'll find there really isn't any comparison to make.

ALPS
AMERICA

IT'S TIME YOU SAW THE ALPS.



KEY SPECS

- 1600 x 1200 Resolution
- 150 DPI, 15" Diagonal
- Price—\$839.00 - LM-301
\$750.00 - PG-1600

- 1200 x 1664 Resolution
- 150 DPI, 15" Diagonal
- Price—\$839.00 - LM-300
\$750.00 - Laserpage

WORKS WITH

CGA/MDA
HARDWARE EMULATION

PageMaker
1.0A

Dr. HALO II™

**Ventura
Publisher**
1.1

**THE
OFFICE
PUBLISHER**
1.0

WordPerfect
4.2

**THE
OFFICE
PUBLISHER**
1.0

**PC PAINTBRUSH
plus 1.0**

**Ventura
Publisher**
1.1

**WORDSTAR
PRO 4.0**

WordPerfect
4.2

WINDOWS
1.04/2.03

AUTOCAD
2.1

**PC PAINTBRUSH
plus 1.0**

**GEM
Desktop 2.1**

**PUBLISHERS
PAINTBRUSH**
1.03

**PUBLISHERS
PAINTBRUSH**
1.03

WINDOWS
1.04/2.03

PageMaker
1.0A

1-2-3
1.A

WORDSTAR

**GEM
Desktop 2.1**

1-2-3
1.A/2

PRINCETON
GRAPHIC SYSTEMS
An Intelligent Systems Company
THE VISIBLE EDGE
601 Ewing St., Building A, Princeton, NJ 08540

To: Dave
From: John
Re: Monitor Analysis
For high resolution and compatibility, the handwriting's on the wall.
Place the order with Princeton!

MICROBYTES

*Staff-written highlights of developments
in technology and the microcomputer industry.*

SQL Promises Portability, but It's Not Easy Becoming a Standard

Incompatible database formats have long been a problem for computer users. It's not uncommon to find several different database programs being used within a single organization, all generating incompatible data. If we're to believe industry watchers and prognosticators, however, this problem will be solved by making Structured Query Language (SQL) the standard.

Although SQL is just a language for querying and communicating with databases, it requires a standard SQL "engine," or data format, to be used effectively. "The real promise of SQL is the portability of files and indexes," pioneering computer designer George Morrow told Microbytes. "If you follow the rules of SQL, everyone can use the data." The problem, however, is that very little data is currently in SQL format. "Unfortunately," said Ansa Software's cofounder Rob Shostak, "most of the world's data resides in flat files accessed by COBOL programs."

SQL may indeed be the next standard. But how long will this standardization take? And how will it affect database developers? With Oracle's recent announcement of an SQL add-in program for Lotus 1-2-3, SQL products for the PC are becoming a reality. Microrim also has announced SQL support, but the new version of R:base implements only some SQL commands and has no provisions for transferring files between R:base and SQL. According to Morrow, R:base users "will be greatly disappointed" when they discover that their files are still incompatible.

Shostak told Microbytes that Ansa is working on a version of Paradox that will accept data from SQL databases by providing a "seamless" translation of

Paradox queries into SQL. "What users really want to do is access SQL data with commands they already know," Shostak said. But do MIS managers want microcomputer users to be able to modify or update mainframe databases? In a survey of Fortune 500 companies, "many executives said they don't want micro users to be able to update the mainframe," said Shostak. Ansa is debating whether to provide a mechanism for exporting data from Paradox back into SQL databases.

Another problem is performance. According to Morrow, the main bottleneck in current PC database products is I/O. "SQL will be even slower, because the bottleneck is the CPU. SQL is highly interpretive. SQL gives you a nice language, but the price you pay is that it's CPU-bound," said Morrow. Morrow's company, Intelligent Access, has been developing SQL interfaces that are built into the hardware of disk controllers.

Of course, Ashton-Tate is also working on SQL products and has hired several experts in the field. Industry speculation has A-T acquiring a company with SQL expertise. But according to Oracle's marketing director, Gene Shklar, the first player to drop out of the SQL game will be A-T. "They simply don't have the technology to compete with us," he claimed. Shklar said that products like dBASE III, R:base, and Paradox are not based on the SQL model and therefore can offer only partial support of SQL.

In any case, no standardization takes place overnight. In the meantime, we'll have to thrash away at incompatible data files and put up with converting to ASCII format.

New Approach Will Make Scanners Smaller

Scanners will begin to change over the next 2 years as manufacturers adopt alternative technologies. The approach that looks to be the scanner technology of the future is called "contact image sensor." It should enable manufacturers

to design scanners that are much more compact, much less expensive, and have much less image falloff than anything on the market today. One thing that makes today's charge-coupled device

continued

Nanobytes

We'll resist unfair comparisons to *glasnost*, but IBM opened its doors a bit following published reports regarding PS/2 Model 50s showing up DOA. The company invited writers from several computer publications to its offices in White Plains, NY, to correct what it says are "misstatements" in the press. One person was quoted in a prominent news weekly as saying that 40 percent of the Model 50s he had ordered arrived defective; but IBM officials said that the quoted person never ordered even one Model 50. We've heard about some minor problems with the machines but have yet to find the rumored graveyard. . . . **Speech Systems Inc.** (Tarzana, CA) is investigating the use of a phonetics-based speech-recognition system to help improve the language abilities of people with hearing disabilities. The study is funded by the U.S. Department of Education. **SSI's Phonetic Engine converts speech to phonetic codes**; the approach is based on phonemes (basic elements of speech) rather than on whole words. . . . **Quintus Computer Systems** (Mountain View, CA) is testing a version of its Prolog compiler for 80386-based computers. **Quintus Prolog** adheres to Edinburgh syntax and provides a complete split-screen development environment with full-screen editor, incremental compiler, debugger, on-line help, and interfaces to C, FORTRAN, and Pascal. The split screen puts source code in the upper window, while Prolog executes in the lower window. . . . **Teknowledge** (Palo Alto, CA) is bringing its Copernicus expert-system environment to the MS-DOS world. The "knowledge engineering tool" runs under Microsoft Windows on 286- or 386-based computers and uses a

continued

DOS extender to allow execution in protected mode. A company official told us that this version is aimed at programmers who want to do the development work on an IBM PC and port it to a mainframe or use the micro as an "intelligent terminal." . . . The new 24-bit Mac II display card from **Jasmine Technologies** (San Francisco, CA) uses "extensions" to the Mac QuickDraw routines to make it possible for existing programs to be compatible with the device. The software for the Rembrandt II and III cards employs the PICT2 format used by QuickDraw, enabling you to paste an image to the Clipboard and then copy it into any application. The card is designed around custom gate arrays but makes use of the Texas Instruments 34010 graphics processor. . . . Having shipped its Pegasys I CAD program for the Macintosh, **IGC Technology** (Walnut Creek, CA) plans two more Mac CAD packages. Pegasys Expert, slated for this quarter, will add "true 3-D, macros, more menus," and more, said an IGC official. Pegasys II will run on the Mac II in full color and take advantage of that box's 68881 numeric coprocessor. . . . **Hewlett-Packard** (Palo Alto, CA) plans to release its workstations based on Motorola's 68030 in mid-1988. The new members of the HP 9000 Series 300 line will be object-code-compatible with HP-UX. An 030 upgrade board will be available for the older, 68020-based models 330 and 350, HP said. . . . This WORM does not crawl. **Micro Design** (Winter Park, FL) said it has speeded up its LaserBank 800 WORM drive by replacing its 8-bit host adapter with a 16-bit device. Claimed DOS throughput is now 90K bytes per second. The \$9995 unit can hold 800 megabytes of data. . . . Now there are mondo characters. **Worthington Data Solutions** (Santa Cruz, CA) has released a package that lets an HP LaserJet Plus-compatible printer print characters 2 inches tall, or what type-shop types would call 153 points. License cost for BIGfont is \$159. . . . Researchers at the **California Institute of Technol-**

continued

(CCD) based scanners so bulky and expensive is the reduction optical system that requires an optical path—that is, the distance between the scanned document and the CCD sensing array—of nearly 400 millimeters. Most scanners aren't that thick because a series of mirrors and lenses is used to reduce the optics. Adding to the bulk and cost is a reflection source, usually a fluorescent lamp.

Contact image sensors, however, have a maximum optical path of not more than 50 mm and replace a bulky lamp with a strip LED array. In a typical contact image scanner, the paper original travels beneath two sets of LED arrays positioned roughly at 45-degree angles above the paper. The light that shines down on the paper is reflected up at 90 degrees through a rod lens array before reaching the photosensor array.

Contact image technology is gener-

ally viable right now, but scanner makers say it currently costs about 3 times more than the more commonly used CCD approach. Contact image has its limitations as well. The dynamic range, for instance, is restricted to 6 bits (64 levels) of gray, while it's possible to push CCD to 8 bits, and even to 10 bits in some cases.

How long before contact image sensor technology makes its presence felt? A representative of one scanner company predicted that within 12 months, contact image sensors will be just as cost-effective as CCD, and within 18 to 24 months, it will be more cost-effective. Most major scanner manufacturers, including Datacopy and Dest, admit that they are tracking the technology and say they will have contact image-based products, perhaps in the form of 8½-inch hand-held page scanners, ready when the market wants them.

You, Too, Can Build a VGA Board

Want to enter the fast-growing graphics-board business? Two companies want to help you by offering a "manufacturer's kit" that they say will provide everything you need to build a VGA-compatible graphics board for the IBM PC.

Award Software (Los Gatos, CA) is supplying the BIOS and the design for the card, while Cirrus Logic (Milpitas, CA) brings the VGA-compatible chips. Cirrus, which provides VGA chips to companies such as Video Seven, claims that its two-part chip set is the only VGA-compatible set currently available.

Like many announced VGA cards, the Award/Cirrus board design features VGA, EGA, CGA, and Hercules compatibility, plus support for both the new analog monitors and the older digital TTL monitors. The board also features autoswitching between the graphics modes. Other enhancements include an 800- by 600-pixel by 16-color mode, support for a mouse in hardware, and

performance that Cirrus claims is 4 times that of the IBM EGA.

According to Award, people who purchase the \$5000 manufacturer's kit will be able to begin selling the board in 30 days. The kit includes an evaluation board, schematics, film for making the boards, manufacturing instructions, the text for an owner's manual, and two color photographs for marketing literature. According to Award, even FCC certification has been taken care of; the board design has passed the certification requirements, and getting a new version of it certified is a mere "paper formality," the firm said.

Award and Cirrus said that several manufacturers, including some monitor makers, should have versions of the board ready to ship by now for retail prices of \$400 to \$500. One manufacturer is even toying with the idea of bundling the board with a new desktop-publishing package; the board would provide high-resolution text.

Air Force Takes Tip from PC Industry

In a radical departure, Air Force planners have decided to base the next generation of USAF fighters and bombers around open-architecture hardware, an approach that they admit has proven successful in the personal computer industry. According to Lt. General Bill Thurman, commander of the Air Force's Aeronautical Systems Division (Wright-Patterson Air Force Base, OH), future aircraft will incorporate inter-

changeable printed circuit cards, like those in an IBM PC, instead of dedicated "black boxes" that have been used for the past few decades.

"Instead of contracting for a company to build an entire specialized radar set," Thurman said, "we'll contract for common cards." The approach, which the Air Force refers to as "modular avionics," is not new, although the

continued

Aztec C

*Power to go the distance...
Whatever that distance might be*



From real time embedded applications to comprehensive commercial applications on Macintosh, IBM PC, Amiga, Atari, and others, Aztec C has earned a well-deserved reputation as an innovative, tough to beat, rock-solid C development system.

But don't just take our word for it—try it yourself. We know that the best way to understand what puts you ahead with Aztec C is to use it. That's why Aztec C

systems purchased directly from Manx come with a 30-day, no questions asked, satisfaction guarantee. Call for yours today.

We can also send you information that details the special features and options of Aztec C. Plus information on support software, extended technical support options, and all of the services and specialized support that you may need when you're pushing your software to the limits and... beyond.

MS-DOS Hosted ROM Development Systems

Host + Target: \$750 Additional Targets: \$500

Targets:

- 6502 family
- 8080-8085-280-2180-64180
- 8086-8086-80186-80286/8087-80287
- 68000-68010-68020/68881

Components:

- C compiler for host and target
- Assembler for host and target
- linker and librarian
- Unix utilities make, diff, grep
- Unix vi editor
- debugger
- download support

Features:

- Complete development system
- Fast development times
- Prototype and debug non-specific code under MS-DOS
- Compilers produce modifiable assembler output, support inline assembly, and will link with assembly modules
- Support for INTEL hex, S record, and other formats
- source for UNIX run time library
- processor dependent features
- source for startup

Aztec C Micro Systems

Aztec C is available for most micro-computers in three configurations: The Professional; The Developer; and The Commercial system. All systems are upgradable.

Aztec C68k Am Amiga
source debugger—optional

Aztec C68k/Mac ... Macintosh
MPW and MAC II support

Aztec C86 MS-DOS
source debugger • CP/M libraries

The following have special pricing and configurations. Call for details.

Aztec C68k/At Atari ST

Aztec C80 CP/M-80

Aztec C65 Apple II & II GS

Standard System \$199

- C compiler
- Macro Assembler
- overlay linker with librarian
- debugger
- UNIX and other libraries
- utilities

Developer System \$299

- all Standard System features
- UNIX utilities make, diff, grep
- UNIX vi editor

Commercial System \$499

- all Developer features
- source for run time libraries
- one year of updates

COD VISA, MasterCard, American Express, wire (domestic and international), and terms are available. One and two day delivery available for all domestic and most international destinations.

Manx Software Systems
One Industrial Way
Eatontown, NJ 07724

Aztec C is available on a thirty-day money back guarantee. Call now and find out why over 50,000 users give Aztec C one of the highest user-satisfaction ratings in the industry.

Call 1-800-221-0440

In NJ or outside the USA,
call 201-542-2121

Telex: 4995812 Fax 201-542-8386

ogy (Pasadena, CA) used a Macintosh II to control an experiment that measured chemical reaction times occurring in femtoseconds. (Light travels from here to the moon in about one second; in a femtosecond, light wouldn't even make it across the width of a human hair.) The Mac manipulated a data-acquisition system and a laser actuator controller, under a program written in LightSpeed C by research fellow Mark Rosker. . . . **Hecht-Nielsen Neurocomputer Corp.** (San Diego, CA) has developed software for helping a neural network system learn patterns. AR/NET, in conjunction with the company's Anza add-in board for the IBM PC and compatibles, uses a massively parallel structure to recognize a learned pattern immediately. "Regardless of the number of patterns the network has learned, it can respond to any pattern it has learned," said company president Robert Hecht-Nielsen. The software can be set to signal the user when it encounters a pattern it doesn't understand. . . . Mac users can share PostScript fonts residing on a network with a printing utility from Olduvai (South Miami, FL). "The display fonts are the only ones that need to be present on the user's machine. The utility can find and download the PostScript font to the PostScript printer," said Olduvai president Juan Chotsourian. FontShare costs \$295 per network and is compatible with networks such as TOPS, AppleShare, MacServe, and HyperNet. . . . It's a Compaq 286 controlling the four robot-controlled cameras NBC now aims at Tom Brokaw on the Nightly News. . . . And now it's time for Digital Exercise! **International Component Manufacturing** gets our Who'd-a-Thought-It? award this month for its Exer-flex "exercise putty." The silicone-based putty "strengthens fingers and reduces operator fatigue among computer users," the company says. It can even improve your digital dexterity and reduce tension, ICM claims. Now we're awaiting little spandex leotards for our fingers to wear while exercising.

Air Force's decision to support the concept is.

"We want to develop architectures that will integrate avionics to cut weight and costs," Thurman explained. "By using highly specialized cards that have very high speed integrated circuits, which are just starting to become available, we will reduce a 50-pound aircraft data processor to a 3-pound computer on a card."

Among the planes that will incorporate open architectures are the Advanced Tactical Fighters, which are the follow-

ons to the current generation F-15S and F-16S, and the Advanced Technology Bomber (the "Stealth" bomber). Thurman, who is often referred to as "the architect of the Air Force of the twenty-first century," told Microbytes Daily that some current planes, including possibly the F-16, will be retrofitted with modular avionic systems "wherever appropriate," adding that "we just won't rip out the avionics of an F-16 for the sake of doing it." He sees modular avionics as a great opportunity for all card manufacturers.

Valdocs Lives, New Owner Says

Veteran microcomputer users may recall TPM, the Valdocs text management and operating system that runs on the old Z80-based Epson QX-10 and QX-16. Rising Star Industries, the developer of Valdocs, went bankrupt about 2 years ago, leaving Valdocs at version 3 Plus. However, a small company called Interface Solutions (Yuba City, CA) has acquired the assets of Rising Star and plans to eventually release new products based on Valdocs.

Don Soegaard, president of Interface Solutions, told Microbytes Daily that the company's first project is porting Valdocs 3 Plus to a single-board Z280 computer, which will plug into the QX-10 or QX-16. The Z280 is a 16-bit version of the 8-bit Z80 and has performance characteristics comparable to an 80286, according to Soegaard. The Z280 board will have up to 3 megabytes of on-board RAM, a SCSI port, serial and parallel ports, and an internal bus to allow additional card-to-card interfaces for a floating-point processor or more

RAM. The Z280 version of Valdocs will initially be very similar to version 3 Plus, but it will support electronic mail in the background, using the Epson's on-board Z80 for that purpose.

The next step will be to rewrite Valdocs in C and port it to MS-DOS and OS/2, said Soegaard. Valdocs is written in Z80 assembly language and in Fortran. Soegaard said the rewritten version will include a relational database, an expanded indexing system, and a new editor, which will be "a stand-alone desktop-publishing system."

Soegaard emphasized that Valdocs will be a starting point for a greatly expanded software system. "Unfortunately, the concept of Valdocs was totally lost, because it was too slow on the Z80 and was released with a lot of bugs," Soegaard said he believes that there is still a place for the Valdocs interface, and he estimates that there are some 50,000 QX-10 users. Interface Solutions welcomes inquiries from OEMs and software developers.

Ethernet Inventor Speculates on Future LANscape

By the year 2000, the local-area network (LAN) scene will consist of four standards, Ethernet inventor Bob Metcalfe told an audience recently. Metcalfe, who is a vice president at 3Com, said the surviving quartet will consist of AppleTalk, IBM's Token Ring, Ethernet, and FDDI (Fiber Data Distributed Interconnects).

"You might have believed that I would say that Ethernet should be the only LAN, and I admit that that argument does have a certain charm," he said, "but that won't be the case." Metcalfe predicted that Ethernet will remain the predominant LAN standard, since 500,000 Ethernet connections are currently in use today, and, he said,

3Com is shipping about 30,000 connections per month.

AppleTalk's advantages, said Metcalfe, are that it is the easiest LAN to install and it is built into the Macintosh. Its biggest drawback, he added, is its slow speed, especially when the LAN consists of more than four Macs; nevertheless, it will be around for the next 12 years.

Metcalfe characterized Token Ring technology as old (about 5 years behind Ethernet, he said) and slow (with data-transfer specifications of 4 megabits per second, as compared to Ethernet's 10 megabits per second). IBM has been hurt by the comparison, Metcalfe said,

continued

Some of the world's biggest problems are being solved with a touch of Smalltalk.

The French Ministry of Foreign Affairs is responsible for keeping **Abroad and involved in foreign affairs.**

track of every French citizen living abroad and every foreigner living in France. Each day, they process thousands of requests for documents or information, each one of which takes at least fifteen minutes. Arthur Andersen, the world's largest accounting firm, has developed a natural language processing application with Smalltalk/V that enables clerks without computer training to extract the necessary data much faster. Thanks to Smalltalk and system developers Bart Schutte and Pascal Wattiaux, what once took fifteen minutes now takes 30 seconds. Vive la Smalltalk!

On the ground floor of high-tech environmental control.

Climate, energy, fire and security are all critical aspects of environmental control in large office buildings. The challenge for Johnson Controls, a leader in this industry, is to provide a control system that is both technologically advanced and simple to operate. Using Smalltalk/V, Research Scientists Gene Koriovek and Tom Wrensch have created a work space environment that allows rapid prototyping and modeling of future systems. At Johnson Controls this system is used to explore relationships between cognitive models of building operations and corresponding iconic representations of building components. Each system can then be tested by simply clicking a mouse and viewing the results in sophisticated color graphics on a PC.



The world is made of objects. So naturally, the world is turning to Object-Oriented Programming (OOPS). And the fastest, easiest OOPS language and environment is Smalltalk/V.

With OOPS you program by defining objects, their inter-relationships and their behavior. Objects can represent both real-world entities — people, places, things — as well as useful abstractions such as stacks, sets and rectangles. Smalltalk/V provides everything you need to solve problems big and small, including a comprehensive tutorial to get you started.

Who needs Smalltalk?

Because Smalltalk models the way people really think, it is perfect for scientists, engineers and professionals who have to solve tough problems in a

short amount of time. Perfect for programmers who are looking for a fast, efficient prototyping environment. And anyone who wants to quickly and easily learn OOPS.

Introducing Smalltalk/V286.

Our newest version of Smalltalk offers faster and more powerful OOPS capabilities. We've gone from 16 to 32-bit architecture. From 640K to 16 MB capacity for 25 times the memory. And designed it to run

on the next generation OS/2 operating system as well as DOS.

Get Smalltalk for a small price.

Smalltalk/V sells for just \$99.95. Smalltalk/V286 is \$199.95. The following optional applications packs are available for \$49.95 each: Communications; EGA/VGA Color; Goodies #1, Goodies #2, Carleton Tools and Goodies #3, Carleton Projects.

And everything comes with a 60-day, money-back guarantee.

So visit your nearest dealer. Or call toll-free, 800-922-8255 and order direct with MasterCard or Visa. Or write to Digital, Inc., 9841 Airport Blvd., Los Angeles, CA 90045.

And let us help you put Smalltalk into action.

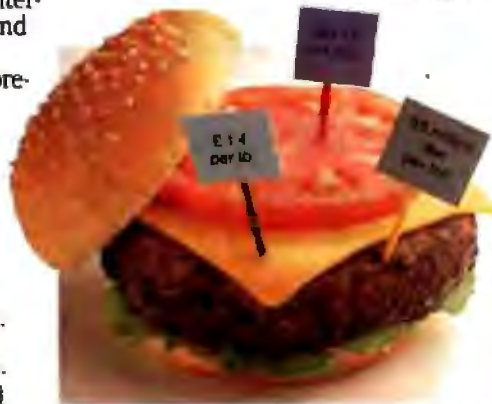

Teaching students to think economically.

With Smalltalk, even non programmers can create exciting applications. Economics Professor Arnold Katz of the University of Pittsburgh developed Economics PC Discovery World, an intelligent tutoring system for beginning microeconomics students. Using a mouse to access windows and manipulate data, a student can call up a set of markets and commodities for an imaginary community. By changing the scenario, the student can not only study a variety of market behaviors, but also test the validity of his or her own reasoning. A process that provides a lot of food for thought.

Smalltalk/V

digitalk inc.



Circle 79 on Reader Service Card (DEALERS: 80)

Smalltalk/V requires DOS and 512K RAM on IBM PC/AT/PS or compatibles and a CGA, MCGA, EGA, VGA, Toshiba T3100, Hercules, or AT&T 6300 graphic controller. A Microsoft or compatible mouse is recommended. Smalltalk/V286 requires a 286 or 386, DOS or OS/2 and 1MB of memory and one of the graphic controllers listed above. Not copy protected.

as evidenced by "the great lengths which IBM has tried to prove that 4 is greater than 10." He alluded to IBM published documents stating that Ethernet operates at only 20 percent of specification, which comes to about 2 megabits per second. "It is convenient that 4 is bigger than 2," he said while denying the IBM claims. In reality, Ethernet operates at more than 90 percent of specification, or more than 9 megabits per second, he said.

At more than \$10,000 per workstation, fiber-based FDDI networks currently are cost-prohibitive for most systems, Metcalfe said. But by the year

2000, lower costs, improved technology, and greater user needs will make FDDI much more common. One reason FDDI will become attractive is that the average LAN in the year 2000 will be carrying at least 10 megabits per second, as compared to today's average of about 1 megabit per second. "Ten-megabit Ethernet is empty today but will fill up by 2000," Metcalfe said. "By that time, FDDI will be there."

Among the LANs that should not be in the repertoire, Metcalfe said, are AT&T's StarLAN and the proposed IEEE 16-megabit-per-second Token Ring standard, both for reasons relat-

ing to lack of performance. StarLAN, which currently operates at 1 megabit per second, "will not be a major player," while the IEEE's 16-megabit-per-second proposal "does not offer a big enough [performance] advantage," Metcalfe said.

Metcalfe obviously has his preferences about which LANs should be around at the turn of the century, but he is realistic enough to know that there will be more than just four LAN environments. "The risk is that there will be too many members of the repertoire by 2000," he said, "not that there won't be enough."

Transputer Board Boosts Sun to 640 MIPS

A new Transputer-based board from Topologix (Denver, CO) converts Sun workstations to parallel processing supercomputers. The Topology 1000 board features four 32-bit INMOS T800 Transputers, each with its own memory array, which gives each board a peak performance of 80 reduced-instruction-set computer (RISC) MIPS (million instructions per second).

A maximum of 64 megabytes of

high-speed dynamic RAM can be used per board. You can connect up to eight boards to a standard Sun workstation (via a simple wiring harness), yielding a peak performance of 640 RISC MIPS, the equivalent processing power of 40 or 50 68020s, Topologix claims.

"The Topology 1000 is basically an accelerator board for the Sun," Topologix president Jack Harper told Microbytes Daily. "But it gives you a lot more

horsepower than an average accelerator board." To illustrate the board's capabilities, Topologix ran the standard programming problem that determines the most efficient (in terms of time and money) travel plans for a sales rep visiting 12 cities. According to Harper, a standard Sun-3 takes 15 hours to solve the problem, while the same workstation with one Topology board takes 20

continued

WordPerfect® . . . without the Template!!!

\$169



Let's get right to the point! Now you can use your WordPerfect without a template. With our Software Integrated Keyboard, all WordPerfect commands are printed in color-coded multi-legends directly on the keys in bold, easy-to-read acronyms.

How about advantages? Ideal for 'dedicated environment' computing. Employee/student/ novice training time is greatly reduced. Eliminates having to reference back and forth between the function keys and the template. Reduces 'hunt and peck' operations and *freed up your keyboard* for placement of another 'often used' software template.

What about desktop publishing? Add up our advantages and the answer is obvious. Make WordPerfect the efficient and cost effective tool it was intended to be with a PDI Software Integrated Keyboard.

Contact PDI for additional keyboard and printed keycap applications.

For all IBM PC/XT/AT & Compatibles

See us at Booth 851 at the WESTCOAST COMPUTER FAIRE, April 7-10, 1988 at the Moscone Center, San Francisco.



PRECISION DECORATORS, INC.
14140 N.W. Science Park Drive, Portland, OR 97229
503/646-5024, FAX 503/646-7850



\$20 trade-in on your old keyboard. Return prepaid in PDI packaging and allow 2-4 wks for return check by mail.

IBM PC/XT/AT are trademarks of International Business Machines. WordPerfect is a trademark of WordPerfect Corporation.

Name	_____
Address	_____
City	State _____ Zip _____
Phone	_____
No PO box addresses please, shipping via UPS	
<input type="checkbox"/> Check Enclosed	<input type="checkbox"/> VISA <input type="checkbox"/> MC <input type="checkbox"/> Discover
Card # _____	Expiration Date: _____
Order options: <input type="checkbox"/> 101 key (enhanced),	} HI-TEK
(check one) <input type="checkbox"/> 84 key (standard AT)	

Photocopy of order form is acceptable!

This \$1595 frame grabber price won't surprise you, once you know our history.



1626: Chief Fred
Sold Manhattan for \$24 worth of beads.



1803: Fred "Napoleon" Bonaparte
Sold the Louisiana territory for less than 3 cents an acre.



1987: Fred Molinari, President
Sells the DT2853 frame grabber for \$1595.

Nobody gets something for nothing. But throughout history, anyone dealing with our family has come awfully close.

Take, for instance, our new DT2853 512x512x8-bit frame grabber that performs real-time image processing on the IBM PC AT. It has advanced features like built-in real-time math and logic operations; square pixel display (for perfect display without geometric distortions); and external trigger inputs (for machine vision inspection applications). And it's supported by a wealth of software.

You get all that, and it's sold for the next-to-nothing

price of \$1595—well below the nearest competing board! Give us a call today. We don't offer prices like this very often, but when we do, they make history.



Call (617) 481-3700

To learn more, see us in Gold Book 1987, or call to receive our first-ever 1987 3-Book Set, including 1987 Catalog, Product Summary Price List, and Applications Handbook.

Image Processing Board	Computer	Resolution	Gray Levels	RS 170, NTSC, RS-330, CCIR, PAL Compatible	VCR Compatible	External Trig Inputs	Square Pixels	Number of Video Inputs	Real Time Frame Grab	Input and Output LUTs	Memory Mapped Frame Store Memory	Real Time Processing	Software Support	Price
DT2853 Frame Grabber	IBM PC AT	512x512	256	Yes	Yes	Yes	Yes	8*	Yes	Yes	2 buffers 512x512x8 each (512 Kbytes)	Yes	DT IRIS DT/Image-Pro PC SEMPER	\$1,595

*With DT2853 1/2 size multiplexer board (\$395)

DATA TRANSLATION

World Headquarters: Data Translation, Inc., 100 Locke Drive, Marlboro, MA 01752-1192. (617) 481-3700 Tlx 951646
 European Headquarters: Data Translation, Ltd., The Mulberry Business Park, Wokingham, Berkshire, RG11 2QJ, U.K. (0734) 793838, Tlx 851849862
 International Sales Offices: Australia (2) 662-4255; Belgium (2) 735-2135; Canada (416) 625-1907; Chile (2) 25-3689; China (408) 727-8222; (8) 721-4017; Denmark (2) 274511; Finland (90) 372-144; France (1) 69280173; (1) 69077802; Greece 951-4944; (03) 162-7039; (1) 361-4-300; Hong Kong (3) 7718585; India (22) 23-1040; Israel (3) 32-4298; Italy (2) 81-821; Japan (3) 502-5550; (3) 375-1551; (3) 355-1111; Korea 778-0721/5; Morocco (9) 30-4181; Netherlands (70) 99-6360; New Zealand (9) 504-759; Norway (02) 55-90-50; Peru (14) 31-8060; Portugal (1) 545313; Singapore 7797621; South Africa (12) 46-9221; Philippines 818-0103; Spain (1) 455-8112; Sweden (8) 761-7820; Switzerland (1) 723-1410; Taiwan (2) 709-1394; United Kingdom (0734) 793838; West Germany (89) 80-9020

IBM PC AT is a registered trademark of IBM Corp. Data Translation is a registered trademark of Data Translation, Inc. Image-Pro is a trademark of Media Cybernetics, Inc.

HARMONY COMPUTERS

2357 CONEY ISLAND AVE. (BET. AVES. T & U) BKLYN. NY 11223

ORDER DEPT. ONLY 800-441-1144 OR 718-627-1000 — INFORMATION 718-627-8888



**NO ADDITIONAL CHARGE
FOR CREDIT CARDS**

**IBM PS II MODEL 30 (20 Meg) \$1699.00
EPSON LX 800 \$189.00**

**PANASONIC 1091 i II \$179.00
COMMODORE 128D \$449.00**

Apple Image Writer II	454
Brother HP 40	569
Brother HP 20	329
Brother 150	358
Citizen 1200	138
Citizen 1800	158
Citizen MSP 10	228
Citizen MSP 15	318
Citizen MSP 40	283
Citizen MSP 45	389
Citizen Premier 35	429
Dixons Ink Jet 150	280
Dixons 300W	472
EPSON LX800	189
LX 80 and 86 Customer Feed	24
EPSON LQ500	348

IBM AND COMPATIBLES

IBM PS 2 Model 30 (2 Drives)	1249
IBM PS 2 Model 30 (20 Meg)	1692
IBM PS 2 Model 50 (20 Meg)	2849
IBM PS 2 Model 80 (40 Meg)	3559
IBM PS 2 Mono Monitor	199
IBM PS 2 Color (8512) Monitor	459
IBM PS 2 Color (8512) Monitor	529
Herz 41 (10 MHz) 640 K w/Drive	458
Herz 41 286 w/1.2 Meg Drive	899

PC BOARDS, DRIVES, CHIPS

Toshiba 5 1/4 Disk Dr	99
Toshiba 5 1/4 Disk Dr	129
AST 5 1/4 Disk DSK	109
AST 5 1/4 Disk DSK	189
AST Rampage (286)	204
Mercedes Color Card	139
Mercedes Monographic Plus	100
NEC EGA GBV	199
Quad Prosync (with mouse)	218
Quad Ultra VGA (with mouse)	319
Video 7 Deluxe	189
Video 7 VGA	299
Gamma Hi Res Card Plus	199
ATI Monitor EGA	189
ATI VGA Wonder	209
ATI Small Wonder	119
Paradee (200)	119
Paradee Auto Switch (486)	155
Paradee VGA	249
Everex Auto Sync (486)	129
Everex EGA Deluxe (840x480)	139
Intel 8027-3	109
Intel 8027-2	168
Intel 80287-4	169
Intel 80287-8	259
Intel 80287-10	299

AT&T

ATT 6300 Drive (486) w/keyboard	849
ATT Monochrome Monitor	179
ATT 301 Keyboard	119
ATT 302 Keyboard	149
AMDEK 125 Color Monitor (720 x 400)	399

"PRINTER SPECIALS"

Epson LQ 1000 Tractor	39	NEC Color P7	699
Epson LQ 850	499	Outdata 180 Plus	206
Epson LQ 1050	609	Outdata 180 Plus	329
Epson FX 86E	299	Outdata 183 Plus	429
Epson FX 280E	439	Outdata 292 w/wTFC	429
Epson FX800	409	Outdata 293 w/ink	549
Epson EX 1000	450	Outdata 393	599
Epson LQ550	649	Panasonic KXP 1080 - Model 2	184
IBM Proprinter II	599	Panasonic KXP 1091 i Model 2	179
IBM Proprinter 24	530	Panasonic KXP 1092	294
NEC P550	719	Panasonic KXP 1093	262
NEC P650	838	Panasonic KXP 3131 Tractor	79
NEC P2200	329		
NEC P6	427		
NEC P7	536		
NEC Color P6	529		

SEAGATE HARD DRIVES

20 Meg. w/controller	289
30 Meg. w/controller	319
30 Meg. AT #40B	459
40 Meg. AT #251	460
Tandon 20 Meg. Hard Card	369
Miniscor 30 Meg. Hard Card	369
Tandon 40 Meg. Hard Card	429
Plus Hard Card (20 or 40 Meg.)	649
(Microc) MAC 20 Meg. External	559

MODEMS

Hayes 1200	274
Hayes 1200B w/Smartmod 2	274
Hayes 300	139
Hayes 2400	408
Hayes 2400B w/Smartmod 2	408
Microcmodem SE	139
Everex Internal 1200B	98
Everex 2400 Internal	179
Everex 2400 External	184
Everex Mac 2400 External	269
Capitron 1200 External	109

APPLE

XTG with 256K	729
Apple Drive (2 1/2")	249
Apple Drive (3 1/2")	329
MAC Plus	1599
MACSE (3 Drives)	2049
MACSE (40 Meg.)	2599
MACSE Keyboard	89
MAC SE Expanded Keyboard	189
ImageWriter II	454
Apple Color Monitor (RGB)	399
Apple Disk II Write Monitor	118
Apple Drive (2 1/2" MAC) 5 1/4"	139
Miniscor MAC 20 Meg. Ext. Drive	559
Everex MAC Maxtron 1200 Ext	269

PORTABLES

NEC Multisync EL	1269
NEC Multisync EL	1399
NEC Multisync H D (30 Meg.)	2299
Toshiba T 1000	765
Toshiba T 1000 Plus (2 Drives)	1349
Toshiba T 1200 (20 Meg.)	2225
Toshiba T 1300 (20 Meg.)	2999
Sharp 4501	179
Zenith 181 (2 Drive)	1499
Dixons Ink Jet Port. Printer	299
Fedex II (Data Transfer Software)	79

MONITORS

Amdek 300 A	99
Amdek 310A	124
Amdek 410A	144
Amdek Color 600S	329
Amdek Color 712	419
Princeton HX 12 Plus	284
Princeton HX 12E	499
Princeton Max 12E	127
Princeton Ultra Sync	499
Scan Double Video Card	159
NEC Multisync II	589
NEC Multisync Plus	659
Gold Star T11 Amber	179
Gold Star RGB Color	219
Gold Composite	399
Magnavox (RGB Composite) 8562	249

MACINTOSH SOFTWARE

Microsoft Excel	278
Microsoft Word 3.01	273
Microsoft Works	187
Spellbase	18
Math (5/31/83)	154
Supersort	42

Panasonic KXP 3131	609
Panasonic KXP 1580	389
Panasonic KXP 1995	439
Panasonic 1824	649
Samsung 1200	124
Star 100	159
Star 1000 (color)	234
Star 1K 1000C	180
Star 1K15	299
Star MD 10	250
Star MD 15	399
Star MD 2400	419
Star MB 2415	599
Toshiba 341 5L	544
Toshiba 351 5L Model 2	179
Toshiba 351 5L	469
Toshiba 351 5L	989

NEC POWERMATE

Power Mate II w/NEC 20 Meg. Hard Drive	1449
Powermate II w/NEC 40 Meg. Hard Drive	2159
Powermate III w/NEC 40 Meg. Hard Drive	1449

COMMODORE

Commodore 128D (Blank Drive)	449
Commodore 128	174
1571 Drive 15.1 K	217
Commodore 64C	174
1541C Disk Drive	174
1571 Drive Drive (3 1/2")	199
2002 Monitor	449
1351 Mouse	449
Star 1K 1000C	113
Amiga 500 with 1084 Monitor	618
Amiga 500 Computer	1499
Amiga 512 RAM Upgrade (16 Amiga 500)	79

IBM SOFTWARE

Lotus 123 Ver. 2.01	299
Lotus Symphony	419
D Base 3.1	278
Framework 2	299
Microsoft Word 6.0	219
Microsoft Excel 4.0	299
Microsoft Windows 2.03	89
Word Perfect 4.2	60
Word Perfect 5.0	179
Q & A 2.0	78
PFS Professional Write	109
Northbridge 4.0	84
Northbridge Advanced	18
Microsoft Mouse (IBM PC and PS 2)	78
Logitech Mouse	78
Logitech Paint	70
Logitech with Mouse	109
Logitech with Cat	119
Wordstar Professional Re. 6	209
Microsoft Advantage Re. 2	49
Vermeer Desk Top Publishing	499
Managing Your Money Re. 2.10	118
Fast Wire II	79
(Data Transfer Software and cables) 1 1/2 inch Software	249

Master Card and Visa welcome. For your protection we check for stolen credit cards. Shipping & handling extra. Defective merchandise will be replaced or repaired at our discretion within the terms of our warranty. All sales final. Price and availability subject to change without notice. We cannot guarantee compatibility.

MICROBYTES

minutes. When the workstation has four Topology boards, the problem is solved in 5 minutes, he said.

The system has parallel Common LISP software (which supports parallel processing applications) and an extended C compiler (for parallel numeric applications). It also provides a Unix interface that permits Lisp and C access

to Unix system calls.

A non-bus-oriented architecture, in which all elements are linked, permits construction of computer networks of arbitrary size and topology. The resulting flexibility is one of the board's strong points. On one hand, Harper said, you can overlay a grid onto an image, making each Transputer respon-

sible for processing in individual grid areas. However, he said, the system can also be turned into a tree machine for other applications.

Topology 1000 at "general-purpose" markets—simulation, image processing, and so on, Harper said. The board is available for "about \$500 per MIP."

Some Mac Developers Not Following Rules, Apple Says

Software developers who take shortcuts when writing programs for the Macintosh may be getting by with it for the time being, but those shortcuts are short-sighted, Apple software engineers told Microbytes Daily.

"If a programmer has adhered to *Inside Macintosh* rules," one Apple spokesman said, "the software can very easily be ported to run under future versions of the Mac operating system."

Apple has said to developers "that if they follow the rules of *Inside Mac*, they won't have any problems, and we mean it," he said. "But not all of them have listened to us, and they are going to have to recompile in the future."

How serious is the problem? According to another engineer, only about 15 percent of all Mac programs tested followed the *Inside Mac* rules. With about 50 percent of the programs, only

slight edits and recompiles will be required to operate properly in the future. The remaining 35 percent will need significant work, however.

The Apple engineer pointed to Microsoft's Excel as an example of one program that hasn't adhered to the Mac rules. "The version of Excel you buy today won't run under the Mac operating system 2 years from now," he claimed.

TECHNOLOGY NEWS WANTED. The news staff at BYTE is always interested in hearing about new technological and scientific developments that might have an impact on microcomputers and the people who use them. We also want to keep track of innovative uses of that technology. If you know of advances or projects that involve research relevant to microcomputing and want to share that information, please contact us. Call the Microbytes staff at (603) 924-9281, send mail on BIX to Microbytes, or write to us at One Phoenix Mill Lane, Peterborough, NH 03458.

Upgrade Your Technology

We're Programmer's Connection, the leading independent dealer of quality programmer's development tools for IBM personal computers and compatibles. We can help you upgrade your programming technology with some of the best software tools available.

Comprehensive Buyer's Guide. The CONNECTION, our new Buyers Guide, contains prices and up-to-date descriptions of over 600 programmer's development tools by over 200 manufacturers. Each description covers major product features as well as special requirements, version numbers, diskette sizes, and guarantees.

How to Get Your FREE Copy: 1) Use the reader service card provided by this journal; 2) Mail us a card or letter with your name and address; or 3) Call one of our convenient toll free telephone numbers.

If you haven't yet received your copy of the Programmer's Connection Buyer's Guide, act now. Upgrading your programming technology could be one of the wisest and most profitable decisions you'll ever make.

USA 800-336-1166

Canada 800-225-1166
Ohio & Alaska (Collect) 216-494-3781
International 216-494-3781
TELEX 9102406879

Business Hours: 8:30 AM to 8:00 PM EST Monday through Friday
Prices, Terms and Conditions are subject to change
Copyright 1988 Programmer's Connection Incorporated

Sale Prices effective through 03/31/88



386 products		List	Ours
386 ASM/386 LINK Cross Asm by Phar Lap	495	389	
386 DEBUG Cross Debugger by Phar Lap	195	129	99
NDP C-386 by MicroWay	595	529	
NDP ForTran-386 by MicroWay	595	529	
PC-MDS/386 Single-User by The Software Link	195	155	
PC-MDS/386 S-Users by The Software Link	595	539	
PC-MDS/386 25-Users by The Software Link	995	869	

blaise products		List	Ours
ASYNCH MANAGER Specify C or Pascal	175	135	
C TOOLS PLUS/5.0	129	99	
PASCAL TOOLS/TOOLS 2	175	135	
Turbo ASYNCH PLUS/4.0	129	99	
Turbo C TODLS	129	99	
Turbo POWER TOOLS PLUS/4.0	129	99	
VIEW MANAGER Specify C or Pascal	275	199	

borland products		List	Ours
EUREKA Equations Solver	167	105	
Paradox 1.1 by Arsal/Borland	495	359	
Paradox 2.0 by Arsal/Borland	725	525	
Paradox Network Pack by Arsal/Borland	995	725	
Quattro: The Professional Spreadsheet	195	125	
Reflex: The Analyst	150	99	
Sidekick	85	57	
Superkey	100	64	

Turbo Basic Compiler	100	64	
Turbo Basic Database Toolbox	100	64	
Turbo Basic Editor Toolbox	100	64	
Turbo Basic Telecom Toolbox	100	64	
Turbo C Compiler (Call for support products)	100	64	
Turbo Lightning	100	64	
Turbo Lightning Word Wizard	70	47	
Turbo Pascal	100	59	
Turbo Pascal Database Toolbox	100	64	
Turbo Pascal Developer's Toolkit	395	259	
Turbo Pascal Editor Toolbox	100	64	
Turbo Pascal Gameworks Toolbox	100	64	
Turbo Pascal Graphics Toolbox	100	64	
Turbo Pascal Numerical Methods Toolbox	100	64	
Turbo Pascal Tutor	70	41	
Turbo Prolog Compiler	100	64	
Turbo Prolog Toolbox	100	64	

c language		List	Ours
Eco-C88 Modeling Compiler by Ecosoft	100	69	
Lattice C Compiler vers 3.2 from Lattice	500	265	
Mark Williams Let's C with FREE csd	75	54	
Univare 68000 C Cross Compiler by SDS	995	829	
Univare Z-80 C Cross Compiler by SDS	995	829	

database management		List	Ours
Clipper by Borland	595	379	
dBASE III Plus by Ashton-Tate	695	389	
dBXL by WordTech Systems	169	99	
Fox Base Plus by Fox Software	395	249	
Gemfile by Data	395	249	

Networker Plus by WordTech Systems	259	209	
QuickSilver by WordTech Systems	599	349	
R-Base 5000 by Microwin	495	359	
R-Base System V by Microwin	700	439	
Tom Reilly's Library by Tom Reilly & Assoc	100	79	
UI Programmer by Walsoft	295	239	

digitalk products		List	Ours
SmallTalk/V by Digitalk	100	84	
EGA/VGA Color Option	50	45	
Goodies Diskette #1	50	45	
Goodies Diskette #2	50	45	
Goodies Diskette #3	50	45	
SmallTalk/Comm	50	45	

logitech products		List	Ours
LOGIMOUSE All Vanities	CALL	CALL	
LOGITECH Modula-2 Development System	249	199	
Modula-2 Compiler Pack	99	75	
Modula-2 Toolkit	169	139	

microport products		List	Ours
DOSMerge286 Specify 2-Users or Unlimited	149	129	
DOSMerge386 2-Users	395	345	
DOSMerge386 Unlimited Users	495	429	
System V/386 Complete Package	799	669	
System V/AT Complete Package	549	485	
Other Microport Products	CALL	CALL	

Flash-Up with FREE Mouse from Software Bottling of NY
List \$89 Ours \$79

Flash-Up is a memory-resident macro, menu and note maker compatible with most languages. Easy-to-use features include a pull-down interface and on-line help. And until 03/31/88, you'll also get a Microsoft compatible mouse FREE.

microsoft products		List	Ours
Microsoft C Compiler S w/CodeView	450	285	
Microsoft COBOL Compiler with COBOL tools	700	439	
Microsoft Excel	495	319	
Microsoft FORTRAN Optimizing Compiler	450	285	
Microsoft Learning DOS	50	38	
Microsoft MACH 20	495	329	
Microsoft Macro Assembler	150	99	
Microsoft Macro All Vanities	CALL	CALL	
Microsoft Pascal Compiler	300	189	
Microsoft QuickBASIC 4	99	66	
Microsoft QuickC	99	66	
Microsoft Windows	99	66	
Microsoft Windows 386	195	129	
Microsoft Windows Development Kit	500	299	
Microsoft Word	450	285	
Microsoft Works	195	129	

ORDERING INFORMATION

FREE SHIPPING. Orders within the USA (including Alaska & Hawaii) are shipped FREE via UPS. Call for express shipping rates.

NO CREDIT CARD CHARGE. VISA, MasterCard and Discover Card are accepted at no extra cost. Your card is charged when your order is shipped. Mail orders please include expiration date and authorized signature.

NO COD OR PD FEE. CODs and Purchase Orders are accepted at no extra cost. No personal checks are accepted on COD orders. PDs with net 30-day terms (with initial minimum order of \$100) are available to qualified US accounts only.

NO SALES TAX. Orders outside of Ohio are not charged sales tax. Ohio customers please add 5% Ohio tax or provide proof of tax-exemption.

30-DAY GUARANTEE. Most of our products come with a 30-day documentation evaluation period or a 30-day return guarantee. Please note that some manufacturers restrict us from offering guarantees on their products. Call for more information.

SOUND ADVICE. Our knowledgeable technical staff can answer technical questions, assist in comparing products and send you detailed product information tailored to your needs.

INTERNATIONAL ORDERS. Shipping charges for International and Canadian orders are based on the shipping carrier's standard rate. Since rates vary between carriers, please call or write for the exact cost. International orders (except Canada), please include an additional \$10 for export preparation. All payments must be made with US funds drawn on a US bank. Please include your telephone number when ordering by mail. Due to government regulations, we cannot ship to all countries.

MAIL ORDERS. Please include your telephone number on all mail orders. Be sure to specify computer, operating system, diskette size, and any applicable compiler or hardware interface(s). Send mail orders to:

**Programmer's Connection
Order Processing Department
7249 Whipple Ave NW
North Canton, OH 44720**

peter norlon products		List	Ours
Advanced Norton Utilities	150	89	
Norton Commander	75	55	
Norton Guides Specify Language	100	65	
Norton Utilities	100	59	

sco products		List	Ours
SCO FoxBASE+	New	795	595
XENIX System V for PS/2 by SCO	New	CALL	CALL
XENIX System V 286 by SCO		1295	979
XENIX System V 386 by SCO		1495	1145
Other SCO Products		CALL	CALL

wiley professional products		List	Ours
50 MORE: FORTRAN		125	95
Scientific Subroutine Library for BASIC		125	99
Scientific Subroutine Lib Specify C or Fortran		225	179
STATLIB.GL		295	239
STATLIB.TSF		295	239

other products

ACTOR by Writewater Group	495	419	
Alysa Ada Products All Vanities	CALL	CALL	
Arity Prolog Products All Vanities	CALL	CALL	
Brief for Solution Systems	195	CALL	
Carbon Copy Plus by Meridian Technology	195	135	
Dan Bricklin's Demo II by Software Garden	195	179	
Deskview from Duke Hardware	130	115	
Disk Optimizer by Software Systems	50	55	
Disk Technician by Prime Solutions	100	89	
Disk Technician + by Prime Solutions	130	119	
MiniProbe by Abron	395	359	
Mac Utilities Paul Mace Software	99	85	
MacCAD by MainSoft	New	349	319
Peabody by Copal Int. Specify Language	New	100	89
Personal REXX by Mansfield Software Group		125	99
riC from IMSI	Sale	80	59
TLIB by Burton Systems Software	Sale	100	79
Turbo Professional 4.0 by IntellPower		99	79
TurboHALO from IMSI	Sale	95	69
TurboPower Utilities by TurboPower		95	78
Vcache by Golden Bow Systems		50	47
Ventura Desktop Publisher by XEROX	New	895	459
Venture Database by Golden Bow Systems		120	111
Vopt by Golden Bow Systems		50	47
XeroxCopy-PC by XEROX		80	69

CALL for Additional Products

Everex — the #1

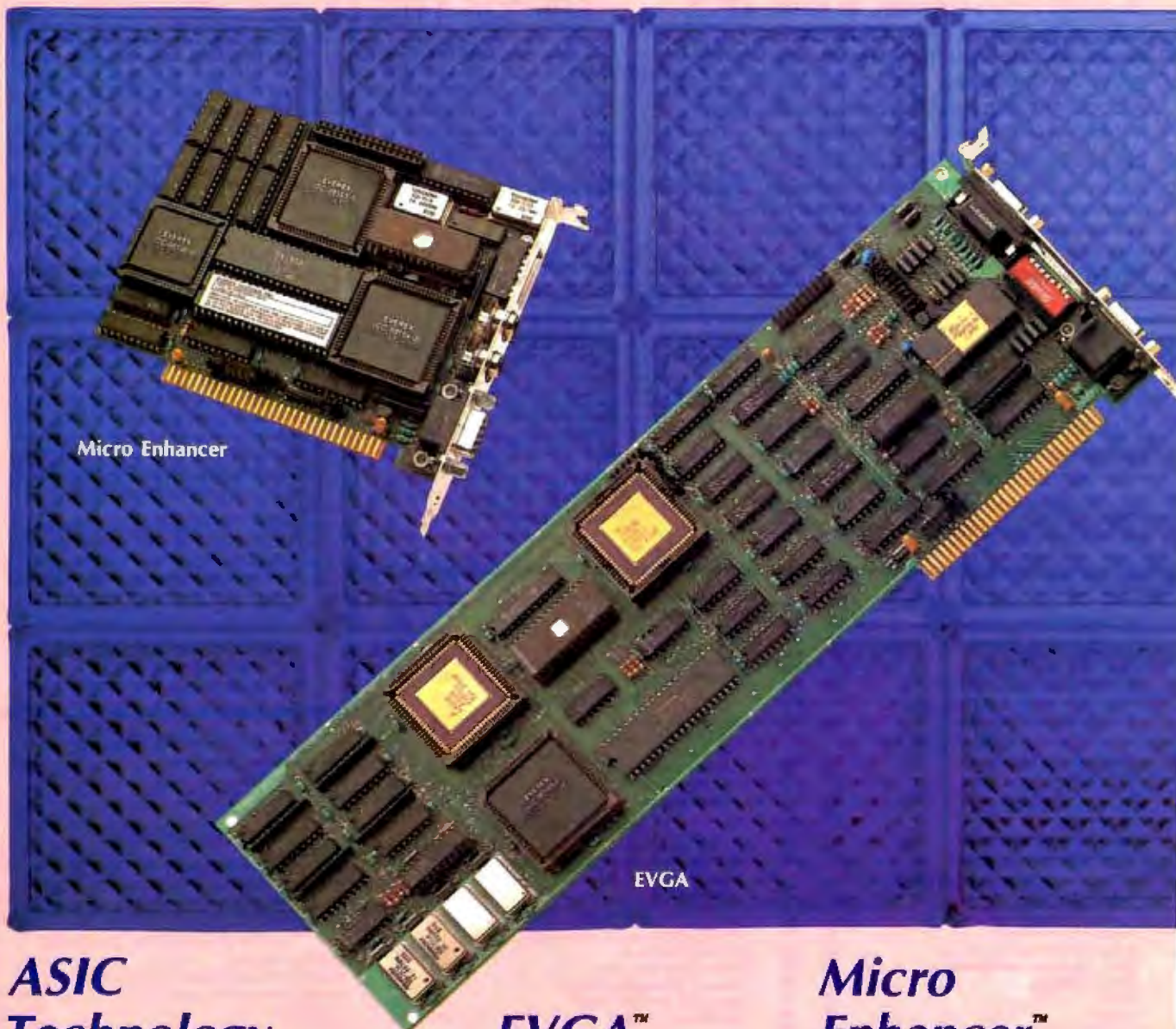

Micro Enhancer

EVGA

ASIC Technology

Everex, one of the leaders in graphics technology, offers a complete line of advanced graphics adapters for IBM PC™/XT™/AT® and compatibles. Application-Specific Integrated Circuits (ASIC) designed by Everex, have led to the quality, features, price and performance of these products. Choose the graphics adapter to suit your needs and start enjoying the Everex difference today!

EVGA™

- True VGA on PC/XT/AT and compatibles
- 256 simultaneous colors from over 256,000
- All 17 VGA modes implemented in hardware
- Runs VGA, EGA, CGA, MDA and Hercules® software
- Supports PS/2, multifrequency, EGA, CGA, and monochrome monitors
- 512 x 480 with 256 colors for true color video applications
- Special 1280 x 600, and 800 x 600 modes
- 132 column text modes

Micro Enhancer™

- High resolution EGA
- Compatible with IBM® EGA
- Supports automatic mode switching
- Extended EGA modes 752 x 410 and 640 x 480
- 132 x 44 and 132 x 25 text modes
- Supports multifrequency, EGA, CGA and monochrome monitors
- Can run Hercules software on an EGA monitor
- Includes feature adapter and RCA jacks
- Very attractively priced

EVEREX, EVER for EXcellence, Evergraphics Plus, EVGA, Evergraphics Deluxe, Ultra Graphics, Micro Enhancer, RamFont, IBM, PC, PC/XT, PC/AT, PS/2, Hercules and Microsoft are trademarks and registered trademarks of their respective companies. ©1987 Everex Systems, Inc. All rights reserved.

Choice in Graphics.



Ultra Graphics



Evergraphics Deluxe



Evergraphics Plus

Ultra Graphics™

- Very high resolution monochrome graphics adapter
- 1664 x 1200 resolution
- Ideal for desktop publishing
- Microsoft® Windows driver included
- Perfect for CAD applications
- AutoCad driver included
- Non-interlaced display
- Supports PGS 15" and Monitorm 19" high resolution monitors
- Co-exists with standard video adapters
- ROM BIOS to allow single display operation

Evergraphics Deluxe™

- Supports standard monochrome monitors
- High resolution 1024 x 704 and 1024 x 352 graphics modes
- AutoCad® drivers included
- Compatible with Hercules RamFont™ modes
- Displays foreign language, scientific, math characters instantly
- Powerful, easy-to-use font editor
- Over 3,000 characters in RAM simultaneously
- Runs standard monochrome software without modification
- 132 x 44 and 132 x 25 text modes

Evergraphics Plus™

- Low-cost monochrome graphics adapter
- Compatible with Hercules graphics
- Fast scrolling
- 132 x 44 and 132 x 25 text modes
- Configurable parallel port
- MDA text compatible
- Works with standard monochrome monitors

Ever for Excellence

For more information or for the name of your nearest Everex dealer please call:

Circle 93 on Reader Service Card (DEALERS: 94)

In USA **1-800-821-0806**
 in Calif **1-800-821-0807**



48431 Millmont Drive, Fremont, CA 94538

MARCH 1988 • BYTE 21

LETTERS

FEA Concerns

Nicholas M. Baran's article, "ANSYS-PC/Linear and MSC/pal 2" (November 1987), failed to focus appropriately on the critical issues in the evaluation of a professional-level IBM PC finite-element analysis (FEA) system. The report was highly subjective and unjustifiably biased toward MSC/pal 2.

Let me begin by stating that I am not without my own biases. I work for a mechanical engineering consulting firm that provides training and technical support to users of the ANSYS program. Although Mr. Baran did note several of MSC/pal 2's deficiencies—limited problem size capacity, lack of an adequate element library, and so on—he tended to dismiss these critical factors as unimportant. On the other hand, he took every opportunity to minimize ANSYS-PC/Linear's superior features (e.g., interactive modeling capability, advanced analysis options, and upward compatibility with the mainframe version).

Mr. Baran stated that ANSYS-PC/Linear is a more expensive program than MSC/pal 2. This is true. However, in PC FEA, you do indeed get what you pay for. The degree of sophistication and complexity of professional-level FEA code is at least an order of magnitude above common PC-based applications. The absence of an element as basic as a three-dimensional solid in MSC/pal 2 is a serious liability. We live in a world composed of three-dimensional solid objects; to model them effectively often requires a continuum element of this type.

Mr. Baran claimed that time-to-solution on similar analysis problems was equivalent for both programs. He did not elaborate on the type of problem he solved; he stated only that the model contained 2000 degrees of freedom. ANSYS-PC/Linear uses a wave-front solution method, influenced by element rather than node order. If you don't know the value of the maximum wave front in the model, the number of degrees of freedom is largely irrelevant. Numerous benchmark studies have shown that ANSYS-PC/Linear has the fastest time-to-solution of any MS-DOS finite-element program.

Mr. Baran raised the issue of ease of use and learning. It seems he based his entire evaluation upon the single user's

manual in his possession. Each ANSYS-PC/Linear lease or purchase includes training credits for an introductory seminar on using the program. Apparently Mr. Baran did not avail himself of this opportunity. He stated that ANSYS-PC/Linear is difficult to learn. I have to ask, relative to what—a spreadsheet? a word processor? We are talking about learning to effectively use a powerful engineering analysis tool; to use it properly requires an investment in time and effort.

One of the most serious deficiencies in Mr. Baran's review is his dismissal of ANSYS-PC/Linear's interactive model-generation capability (which MSC/pal 2 lacks). He states, "The interactive mode is most suitable for issuing a few on-line commands to obtain a plot or a small listing. For creating a moderate-size model, I found it much easier to prepare the input file using a text editor and then to run PREP7 in batch mode using my input file." To prefer working in batch mode when an excellent interactive capability exists (with on-line help, immediate plotting, and error correction) is insane. I wonder if Mr. Baran prefers shaving in the dark—that's what it feels like to create an FEA model in batch mode.

Now that I've gotten all that off my chest, let me say that Mr. Baran's criticism regarding difficulty in obtaining a hard copy in ANSYS-PC/Linear was entirely valid. However, Version 4.3 of ANSYS-PC/Linear is now available, and its new vector display mode option completely corrects this problem.

Victor R. Urbach
Westbury, NY

I stated in the article that ANSYS-PC/Linear is the more capable and flexible product. On the other hand, I think it's a bit presumptuous to claim that the "degree of sophistication and complexity of a professional-level FEA code is at least an order of magnitude above common PC-based applications." It all depends on what you plan to do with the program. And though we do live in a three-dimensional world, a great many problems can be solved in two dimensions with beam or plate elements.

In the years I worked as an engineer performing stress analyses of mechanical and structural components, I would say 80 percent of the problems involved beam

and plate elements rather than solid elements. Many of these types of problems can be solved accurately using MSC/pal 2 as well as ANSYS-PC/Linear.

Since MSC/pal 2 does not use a wave-front equation solver, the value of the maximum wave front does not help us compare performance. I intentionally avoided attempting a formal benchmark because of the different solution methods. My own experience in running identical problems on both programs was that their performance is roughly equivalent. And let's face it, whether it takes 40 minutes on one or 48 minutes on the other, both programs are pretty slow on an IBM PC.

Let's not confuse a program's ease of use with the process of learning and applying the concepts of finite-element analysis. While a great deal of training and education are involved in applying FEA competently, there is no reason why the user interface of a program like ANSYS-PC/Linear should be so complex. There is no reason that a beginning user should have to spend hours leafing through the manual trying to figure out how to generate a mesh pattern.

I'm sorry, but all the finite-element programs I've seen, including MSC/pal 2, could benefit from improved user interfaces. There is no reason why engineers should have to continue to put up with terse command languages and forbidding documentation.

Finally, I stand by my evaluation of ANSYS-PC/Linear's interactive modeler. No, I don't like shaving in the dark, but I also don't like shaving with a dull blade. I still maintain that the interactive modeler is extremely difficult to use. Perhaps with a training course, my attitude would change, but I was evaluating the program

continued

LETTERS POLICY: When submitting a letter for publication, double-space it on one side of the paper and include your name and address. Express your comments and ideas as clearly and concisely as possible. We can print listings and tables along with a letter if they are short and legible.

Because we receive hundreds of letters each month, we cannot publish all of them. We cannot return letters to authors. Generally, it takes four months from the time we receive a letter until we publish it.

Announcing - the database development system that you designed.

db_VISTA III™

C PROGRAMMERS-
We asked what you wanted in a database development system and we built it!

db_VISTA III™ is the database development system for programmers who want powerful, high performance DBMS capabilities ... and in any environment. Based on the network database model and the B-tree indexing method, db_VISTA III gives you the most powerful and efficient system for data organization and access. From simple file management to complex database structures with millions of records, db_VISTA III runs on most computers and operating systems like MS-DOS, UNIX, VAX/VMS and OS/2. It's written in C and the complete source code is available, so your application performance and portability are guaranteed! With db_VISTA III you can build applications for single-user microcomputers to multi-user LANs, up to minis and even mainframes.

RAIMA'S COMMITMENT TO YOU: No Royalties, Source Code Availability, 60 days FREE Technical Support and our 30-day Money-Back Guarantee. Extended services available include: Application Development, Product Development, Professional Consulting, Training Classes and Extended Application Development Support.

HOW TO ORDER: Purchase only those components you need. Start out with Single-user for MS-DOS then add components, upgrade ... or purchase Multi-user with Source for the entire db_VISTA III System. It's easy... call toll-free today!

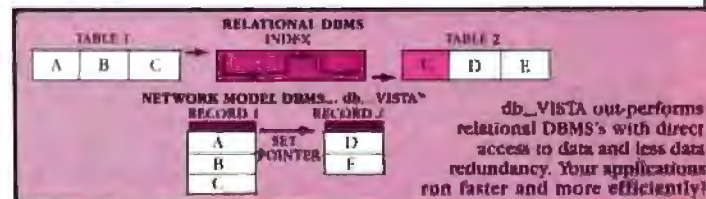

The db_VISTA III™ Database Development System

db_VISTA™: The High Performance DBMS

Major features include:
 Multi-user support for LANs and multi-user computers.
 Multiple database access.
 File and record locking.
 Automatic database recovery.
 Transaction processing and logging.
 Timestamping.
 Database consistency check utility.
 Fast access methods based on the network database model and B-tree indexing. Uses both direct "set" relations and B-tree indexing independently for design flexibility and performance.
 An easy-to-use interactive database access utility.
 File transfer utilities for importing/exporting ASCII text and dBASE III/III files.
 A Database Definition Language patterned after C.
 Virtual memory disk caching for fast database access.

- A runtime library of over 100 functions
- **Operating systems:** MS-DOS, UNIX V, XENIX, VMS, OS/2
- **C Compilers:** Lattice, Microsoft, IBM, Aztec, Computer Innovations, Turbo C, XENIX, and UNIX
- **LAN systems:** LifeNet, NetWare, PC, network, 3Com, SCO XENIX-NET, other NET BIOS compatible MS-DOS networks

- 2 db_QUERY™: The SQL-based Query.**
 - Provides relational view of db_VISTA applications.
 - Structured Query language
 - C linkable
 - Predefine query procedures or run ad hoc queries "on the fly"
- 1 db_REVISE™: The Database Restructure Program.**
 - Redesign your database easily
 - Convert all existing data to revised design

All components feature royalty-free run-time distribution, source code availability and our commitment to customer service. That's why corporations like ARCO, AT&T, Hewlett-Packard, IBM, Northwestern Mutual Life, UNISYS and others use our products.

db_VISTA III™ Database Development System

db_VISTA III™ \$595 - \$960
 db_QUERY™ \$595 - \$960
 db_REVISE™ \$595 - \$960

db_VISTA™ File Manager Starts at \$195

We'll answer your questions, help determine your needs and get you started.

CALL TODAY!

1-800-db-RAIMA

(that's 1-800-327-2462)



RAIMA™
CORPORATION

3055 112th Avenue N.E., Bellevue, WA 98004 (206)828-4636
 Telex: 6503018237MCIUW FAX: (206)828-3131

Attention all FX80, FX100, JX, RX, & MX owners:
**You already own half of
 a great printer**

**Improved
 version
 Now with
 elite NLQ
 on FX models**



**Now
 Only
 \$79.95**

Now for \$79.95 you can own the rest. You see, today's new dot matrix printers offer a lot more. Like an NLQ mode that makes their letters print almost as sharp as a daisy wheel. And mode switching at the touch of a button in over 160 styles. But now, a Dots-Perfect

upgrade kit will make your printer work like the new models in minutes— at a fraction of their cost. And FX, JX and MX models will print the IBM character set, too. So, call now and use your Visa, MasterCard, or AmerEx. Don't replace your printer, upgrade it!

1-800-368-7737

(Anywhere in the United States or Canada)



Dots-Perfect™

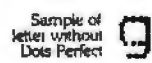

Dresselhaus

8560 Vineyard Ave., Ste. 405, Rancho Cucamonga, CA 91730



(714) 945-5600

An upgrade kit for EPSON FX, JX, RX, & MX printers

IBM is a registered trademark of International Business Machines Corp. Contour™ is a trademark of Spac America, Inc. Epson is a registered trademark of Epson America, Inc.

**Now there's a smart way to
 connect more than one printer**

Forget those dumb A/B boxes and those expensive switching devices. Now you can connect up to six parallel printers to your computer and let your programs do the switching intelligently for only \$119. SmartPorts automatically sends

your output to the correct printer. You just add a simple code to your program or printer setup string. Or, select a printer from a pop-up window utility that's included. SmartPorts recognizes the code and makes the switch.

So, call now and use your Visa, MasterCard or AmerEx. It's smart!

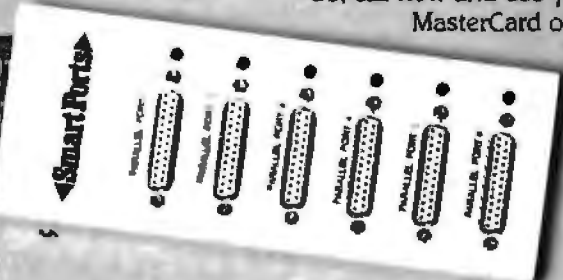

**Now
 Only
 \$119**

1-800-368-7737

(Anywhere in the United States or Canada)

Smart Ports™

Dresselhaus 8560 Vineyard Avenue, Suite 405, Rancho Cucamonga, CA 91730

A software-controlled printer switch for IBM PCs and compatibles

from the point of view of users who might be trying to learn the program on their own. —Nicholas M. Baran

Sign Language vs. Finger Talk
 Ohio State University's program, SpeechSign (Microbytes, December 1987, page 14), does not "help teach sign language." It teaches the manual alphabet, commonly known as "finger talk."

Finger talk is excruciatingly slow. Sign language positions the whole body, in the context of the surrounding environment, in symbols that transmit information.

Fluent signers routinely transmit information at 100 times aural speed.

There are three widely used sign languages. The oldest is American Indian Sign (AIS), used by the Boy Scouts. Next came American Sign Language (ASL), used by the hearing-impaired and for cross-cultural communications. Last came Gorilla Sign Language (GSL), ASL restructured for the Great Apes.

True sign language uses syntax and grammar radically different from aural language. NATO and the UN unofficially recognize ASL as a universal language. The Boy Scouts use AIS to conduct business and personal conversations during International Jamborees. GSL is the only language routinely used for two-way transmission of sophisticated abstract concepts between animals and humans.

None of this is possible with language-bound finger talk. To reach the Dick-and-Jane kindergarten level of sign, the hardware would have to have at least 500 megabytes of RAM, with a clock speed of at least 50 megacycles and a graphics screen the size of a barn door. Then comes the program, which will, while under development, spin off sign language translators centuries beyond what we have today.

Eugene Austin
 Tilden, NB

"Information," Please
 I congratulate BYTE for printing "Information Theory" by Ramachandran Bharath (December 1987). An open discussion in the computer field about defining the term "information" is long overdue, and maybe this article will lead the way. For too long, the term has been picked up and used without regard to its precise meaning.

Mr. Bharath provided us with a comprehensive introduction to information theory, and he made the technical nature of the theory crystal clear. The reader could easily see that the theory is based on mathematical proofs and, as such, could not be used to deal with the issues relating to the value of the contents of the

continued

COMPUTER WAREHOUSE

CALL TOLL FREE **1-800-528-1054**

FREE FEDERAL EXPRESS
Air Express Shipping
See Details Below

LOWEST PRICES
FAST DELIVERY

HARDWARE

PRINTERS

Alps All Models	Call
Brother All Models	Call
Citizen MSP-40	\$288
MSP-45	\$415
MSP-50	\$388
MSP-55	\$450
Premier 35	\$450
Tribute 224	\$605
170 D	\$148
Citizen 180D	\$160
Citizen 15E	\$315
Dyonics 180	\$299

EPSON	
All Printer Models Call	
Hewlett-Packard LaserJet II	\$1779
NEC P2200	\$335
850	\$1539
880+	\$1980
3550	\$729
880, 8850	\$1089
P6	\$425
P7	\$610
P8	\$1035

OKIDATA	
All Printer Models Call	
Panasonic 1081 Model 2	\$180
1080 Model 2	\$165
1092 I	\$305
1624	\$549
1592	\$405
1595	\$455
3131	\$285
3151	\$390
Laser	Call

STAR MICRONICS	
All Printer Models Call	
Toshiba 327 SL	\$499
341SL	\$665
351 Model II	\$899
Laser Printer	Call

DISKETTES

Maxell MD2 (Qty 100)	\$82.50
M2S	\$65
Sony DS/DD (Qty 100)	\$60
5 25 HD (100's)	\$150
3 5 DS (100's)	\$105

MONITORS

Amdtek All Monitors	Call
Mitsubishi Diamond Scan	\$499
Other Models	Call
NEC Multisync II	\$349
Multisync Plus	\$875
Multisync XL	\$2005
Princeton Graphics All Models	Call
Sony Multiscan w/cable	\$665
Multiscan 1303	Call
Thompson UltraScan	\$339
Zenith 1490 FTM	\$625
Other Models	Call

MODEMS

HAYES	
All Modems Call	
Prometheus 2400B w/Soft	\$120
Other Models	Call
US Robotics Courier 2400	\$299
Password 1200	\$149

DISK DRIVES

Imega Bernoulli 10 meg	\$865
Bernoulli 20 meg	\$1260
Bernoulli 40 meg	\$1605
Bernoulli Beta Internal (5 1/4)	\$909
Bernoulli Beta External (5 1/4)	\$1645
Miniscribe Drives	Call
Teac AT 1 2 Meg Drive	\$100
XT 1/2 HT Drive	\$65
Magnum Tape Backup	Call
Everex Tape Backup	Call

SEAGATE	
20 meg w/Western I/O	\$290
Other Models	Call

\$389



MIT SYSTEMS Turbo PC/XT

256 Memory, One 360K Brand Name Floppy Drive, 135 Watt Power Supply, Slide Case, AT Style Keyboard + 4-10 MHz Clock Speed (Keyboard Selectable), 8 Expansion Slots

Turbo PC/XT w/840K & 1 Drive	\$415
Turbo PC/XT w/840K & 2 Drives	\$485
Turbo PC/XT w/840K	
1 Drive & 20 MG	\$729
PC/AT 10 MHz w/1024K, 1 1/2 Floppy Drive	\$989
PC/AT 10 MHz w/1024K, 1 1/2 Floppy, 40MG	\$1519
PC/AT 12 MHz/1024K, 1 1/2 Floppy Drive	\$1049
PC/AT 12 MHz/1024K, 1 Drive, 40 MG	\$1549

MonGraphics Card with Parallel Printer Port \$55
Color Card w/Parallel Printer Port \$65
Amber Monitor (TTL) \$89
Amber Monitor w/Swivel Tilt \$95
Color Monitor (RGB) \$255
EGA+ Card \$145
I/O Card (Serial/Parallel) \$38
I/O Card (Serial/Clock Calendar) \$39
Enhanced Keyboard \$69
AT Multi I/O Card \$69
XT Multi I/O Card \$55

KEYBOARDS	
KB5151	\$145
KB515-3	\$235
KB 101	\$99

BOARDS

AST Six-Pack Plus	\$109
Hot Shot 286	\$330
Other Models	Call
ATI EGA	\$175
VGA	\$285
Hercules Color Card	\$145
Graphic Card & Graphic Card + Above Board PC 1010	\$175
Intel Above Board PS/PC (1110)	\$205
Above Board AT (4020)	\$239
Above Board PS/AT (4120)	\$305
386 w/Cable	\$329
Inboard w/Cable	\$719
NEC Multisync Graphic Board	\$1005
Crohid Tiny Turbo 286	\$275
Paradise Five Pak	\$265
Autoswitch 350	\$449
Paradise Five Pak	\$99
Autoswitch 480	\$135
VGA+	\$150
VGA Professional	\$239
Plus Development	\$355

Plus Hard Card 20 & 40 Megabyte	Call
Mountain Hard Cards	Call
Quadram Quad EGA + VGA	Call
Video-7 Vega Deluxe & VGA	Call

VIDEO TERMINALS

Cume 101 Plus Green	\$315
101 Plus Amber	\$315
Wyse	Call

COMPUTERS

AST Model 80	\$1509
AST Model 120	\$2130
AST Model 140	\$2475
ATAT	Call
NEC Multispeed	\$1375
NEC Multispeed EL	\$1609
Sharp	Call
Toshiba T1000	\$785
T3120	\$3068
T-1100 Superwet	\$1370
T-3100	\$2799
Zenith	Call

PROJECT MANAGEMENT

Harvard Total Project Manager (I)	\$269
Microsoft Project	Call
Super Project Plus	\$269
Timeline 2.0	\$289

GRAPHICS

Logi Mouse	Call
Logi Buss Mouse w/paint	\$65
Newmaster	\$48
Microsoft Buss Mouse 1.0	Call
Microsoft Chart 3.0	Call
Microsoft Serial Mouse 1.0	Call
Newaroom	\$30
PC Mouse w/Paint	\$89
PC Buss Plus Mouse w/Paint	\$99
PFS First Publisher	\$49
IMS Mouse w/Dr Halo II	\$85
PC Mouse w/Paint	\$89
Printmaster Plus	\$25
Master Presentation Pack	\$315
Turbo Graphics Tool Box	\$38

COMMUNICATIONS

CompuServe Starter Kit	\$19
Crosslink XVI	\$88
Carbon Copy Plus	\$103
Mirror II	\$33
Remote	\$88
Smartcom III	\$136

SOFTWARE IBM PC and 100% Compatibles

INTEGRATIVE SOFTWARE

Enable 2.0	\$359
Framework II	\$309
Smart Software System 3.1	Best Price
Symphony	\$439
Ability Plus	Call

TRAINING

MS Flight Simulator	Call
PC Logo	\$75
Typing Instructor	\$27
Typing Tutor IV	\$27
MS Learning DOS	Call

LANGUAGES

C Compiler (Microsoft)	Call
Fortran Compiler (Microsoft)	Call
Macro Assembler (Microsoft)	Call
Pascal Compiler (Microsoft)	Call
Quick Basic 4.0	Call
Turbo Jumbo Pack 3.0	\$159
Turbo Pascal 4.0	\$85
Turbo C 1.5	\$58
Turbo Basic	\$53
Turbo Prolog	\$53

UTILITIES

MS Windows 2.0	Call
Copy II PC	\$18
1 DIR Plus	\$46
Fastback Plus	\$67
Norton Utilities 4.0	\$46
Printworks For Laser	\$67
Sidekick (Unprotected)	\$44
Sideways 3.2	\$37
SuperKey	\$33
Xtree	\$53
SQZ	\$45
Brooklyn Bridge	\$69

WORD PROCESSORS

Word Perfect Executive	\$103
Leading Edge W/P w/Spell & Mail	Call
Turbo Lightning	\$82
Microsoft Word 4.0	\$183
Multimate Advantage II	\$249
Wordstar w/Tutor	\$162
Wordstar Pro Pack 4.0	\$205
PFS Professional Write	\$99

Word Perfect (Ver.4.2) \$189
Wordstar 2000 + 3.0 \$189

SPREADSHEETS

Lotus 1-2-3	\$295
Multiphan 3.0	Call
Twin	\$32
VP Planner Plus	\$82

Supercalc 4 \$269

MONEY MANAGEMENT

Dollars & Sense w/Forecast	\$92
Tobias Managing Your Money 4.0	\$115

DATA BASE MANAGEMENT

Clipper	\$368
Dbase III Plus	\$374
Quickcode Plus	\$138
QuickReport	\$138
Rellex	\$78
DB-XL	\$79
PFS Professional File	\$111

R:Base 5000 System V \$415

Many other titles available.

Circle 64 on Reader Service Card for MS DOS Products. (All Others: 65)

COMPUTER WAREHOUSE

To Place an Order: 1-800-528-1054
To Follow-up on an Order: 602-944-1037
8804 N. 23rd Ave.
Phoenix, Arizona 85021

Order Line Hours:
Mon-Fri 7:00 a.m.-6:00 p.m.
Saturday 9:00-1:00
Order Processing:
10:00 a.m.-3:00 p.m. Mon-Fri

* No Charge for VISA and MasterCard + You Pay the Ground Shipping - We Pay the Air + Ground Shipping & Handling \$6.00 + Free Air applies ONLY to orders up to 10 lbs. & Over \$50 + All products carry a manufacturer's warranty. All Guarantees, rebates, trial period privileges & promotional programs are handled by the manufacturer only + NO APC, FPO, or international orders, please + Call before submitting PO Numbers + Personal and Company Checks Will Delay Shipping 3 weeks + Prices, Terms & Availability Subject to Change Without Notice + Add 5% for COD Orders + We Do Not Guarantee Machine Compatibility + We do not charge credit cards until order is shipped.



OUTSTANDING SOFTWARE

For IBM PC's and Compatibles

\$3.50 PER DISK **\$3.00 PER DISK**

Small Quantities For Ten or More

SHIPPED WITHIN 24 HOURS!
Satisfaction Guaranteed or Money Back!

- BUSINESS 1**—EZ-FORMS business form generation, completion and printing program.
- CAD 3**—The PC Flow 1.0 computer aided flow-chart generation program. Color graphics required.
- COMM 4a,b,c,d,e**—(5 disks) Join the world of sysops with RBBS Bulletin Board System 14.1D.
- DATABASE 1a,b**—(2 disks) File Express 3.8 menu driven general purpose database manager.
- EDUCATION 1**—Interactive DOS tutorial for new PC users. Makes learning DOS painless.
- FINANCE 1a,b**—(2 disks) PC Accountant 2.0 personal bookkeeping and finance management.
- GAMES 1**—3-D Pacman, Kong, Spacewar, Jenit-Joe, futuristic Flightmare and more. Color required.
- GAMES 2**—Gubert, Pango, Cardpeda, dragons and dragons style Zorars, etc. Color req.
- GAMES 3**—Blackjack with customizable rules, Armchair Quarterback (you call plays), and more.
- GAMES 4**—Star Trek, the Castle adventure game, and the original Colossal Cave Adventure.
- GAMES 5**—The Hack adventure game from the universities. Like Rogue, only much richer.
- GAMES 6**—Pinball, Othello, Dragons, Sopwith (fly a Sopwith Camel) and more. Color required.
- INFO 1a,b**—(2 disks) Cooking recipes database with keyword/ingredient retrieval. Add your own.
- MUSIC 2a,b**—(2 disks) PianoMan 3.0 polyphonic music recording and playback program.
- ORGANIZER 1**—DeskTeam, a Siskit clone, and the Judy personal calendar program.
- PRINTER 1**—Resident print control and font utility, intelligent spooler, banner maker, and more.
- SIMULATION 1**—Maze making program, MIT's Life simulation, starfields, etc. Color graphics req.
- UTILITIES 1**—A collection of invaluable general purpose DOS utilities. An absolute must for all.
- UTILITIES 2**—More invaluable DOS utilities including screen burnout, ram disk, and more.
- UTILITIES 3**—A comprehensive set of debugging and diagnostic utilities for monitoring your computer.

BY 368

NEW RELEASES/UPDATES

- BUSINESS 2**—Expressgraph business graphics Chart your data and find trends. Color graphics req.
- CAD 1a,b**—(2 disks) Fingerprint 1.2 advanced painting and Altamira object oriented design. Color.
- CAD 2a,b**—(2 disks) DanCad3d, an advanced 2D/3D drafting program w/animation. 640K, color.
- COMM 2a,b**—(2 disks) Procomm 2.42, an excellent modem program with terminal emulation.
- EDUCATION 3**—PC Fastype 1.20 typing tutor, ideal for beginners and advanced students alike.
- FINANCES 3a,b**—(2 disks) Express Calc 3.12, a powerful and user friendly spreadsheet program.
- GAMES 8**—Striker helicopter attack and Risk, the game of world domination. Color required.
- GAMES 12**—Backgammon (play the computer) and Wheel of Fortune based on the gameshow.
- GRAPHICS 1**—Record and play back screen images! Excellent for demo, etc. Color required.
- GRAPHICS 2a,b,c**—(3 disks) An excellent 3-D surface modelling and shading program. Color.
- INFO 2a,b**—(2 disks) Zip-Phone, national area/code/prefix to zip-code cross reference.
- LANGUAGE 3a,b**—(2 disks) The A86 3.08 macro assembler and debugger for 8086/88/286s.
- SHELL 4a,b**—(2 disks) Altomenu and HDM II 4.04 hard disk prog. for custom full-screen menus.
- UTILITIES 5**—Hard disk utilities for verifying, formatting, parking and optimizing your disk drives.
- UTILITIES 6**—Advanced utilities including Mark/Release (remove resident prgs w/o reboot).
- UTILITIES 7**—More advanced utilities including Misterkey (undeletes files from hard disks).
- WORD 1a,b**—(2 disks) PC Write 2.71, a powerful word processing system w/spell checker, laser supt.

Most software listed is shareware or user-supported

3.5 format add \$1 disk 125 page directory, add \$2

MicroCom Systems Cost of items
3673 Enochs Street Shipping \$3.00
Santa Clara, CA CA res tax
95051 Total encl.

(408) 737-9000

Mon-Fri 7am-9pm Sat-Sun 8am-5pm



LETTERS

messages being measured. Perhaps Mr. Bharath's warning and clarification of this fact at the end of the article was not strong enough. I would like to reinforce the warning.

Information can be explained simply as data that is prepared into a form that makes it easier for someone else to use. Information theory provides us with mathematical tools to evaluate the reliability of information, not with a methodology to evaluate its relative value.

We tend to be too technical in our collective quest for systems solutions. We would be better off clarifying what information is and how it is processed, in the broadest sense of the word, so that we can provide more reliable, more effective, more acceptable systems solutions.

Information is a dynamic and personal, yet powerful, thing. It changes everything with which it comes into contact. That is part of the nature of information. Information scientists and librarians have obviously given attention to this topic, as have economists, political scientists, and behavioral scientists. Now is a great time to learn from these discussions. We need more dialogue to discover just what information is.

Kevin Stumpf
The Infotorium
Kitchener, Ontario, Canada

Karmarkar Kudos

Ever since I saw "Karmarkar's Algorithm" by Andrew M. Rockett and John C. Stevenson (September 1987), I have found more and more reasons to thank you for including material at this level of mathematics.

The article is proving to be a most useful adjunct to lecture material in a course on linear programming that I am taking—even the errors in the BASIC listing made me think things through.

Since I have found the spreadsheet a good self-instructional tool, I have constructed a Lotus 1-2-3 worksheet that steps through the iterations of the example given. This worksheet provides a useful look at what is actually happening at each stage.

I would be glad to provide BYTE readers with a listing of the formulas and a description. If readers would send along a disk, I would copy the worksheet onto it and mail it back to them.

H. J. Hunter
P.O. Box 13398
Kanata, Ontario, Canada K2K 1X5

Semantic Accuracy

In "Modeling the Brain" (December 1987), Mathew Zeidenberg asserts that the system makes "accurate role assignments" in such sentences as "The man

hit the boy with the mallet." It's best not to say "accurate" in setting a default semantic value for an ambiguous sentence without context validation. The article deals with semantics at sentence level only, so matters of context are not considered. Given that approach, ambiguous sentences are best left with semantics not fully resolved. The pleasure many people derive out of ambiguous sentences, similar to that of enjoying optical illusions, argues that an isolated sentence does have a flip-flop semantic value.

For a system to analyze syntactic ambiguity, other input should be considered before making a semantic decision. Each relevant piece of data adds weight to an interpretation, and some particular (even externally set) weight of certainty sets the meaning, at least until contradictory information is received. Since ambiguity can be resolved before or after its occurrence, the system needs to look back as well as forward. Consider "The 4-year-old was showing his buddies his new mallet when a car veered around the corner. They ran for safety, but the man hit the boy with the mallet." Or "The man hit the boy with the mallet, then the red-headed kid, but missed the baby, before he regained control of his car and rounded the corner." Not to mention "The man hit the boy with the mallet with his car."

The fact that people do not stop at the end of each sentence for an interminable period of interpretation makes clear that once we think we know what we're talking about, we suspend analysis (right or wrong). A computational model should likewise go to the heights and depths, at need only.

Cathy Miller
Salt Lake City, UT

A Vote for Tweaking

With regard to Fred Langa's December 1987 editorial on benchmarks, it was a shame that benchmark optimization (referred to as "tweaking") came off so badly. On the contrary, I assert that unless each benchmark is optimized, the results will have little meaning in the IBM PC marketplace.

When compilers are benchmarked without "tweaking," we are verifying their ability to handle a particular source code. Source code compatibility is essential in an environment that requires the continued use of many different machines and compilers. In the big-business management information-systems environment, programs can be distributed as source code, or perhaps a publisher will produce different versions of a program for the various target machines. In any case, source code compatibility is an ab-

continued

THE WORLD'S BEST-SELLING DRIVE

Field-proven
30,000 hour
MTBF



THE ST225

Proven reliability. That's the reason Seagate's 20 MB half-height hard disc drive is so popular, with over 3 million sold in less than three years.

Who proved it? Millions of computer users around the world. They've benefited from our continued design and manufacturing improvements. And they've proved that the ST225 has an MTBF of 30,000 hours.

Which means years of uninterrupted performance. And a disc drive you can rely on.

Reliability has helped make Seagate the world's leading independent manufacturer of 5¼" and 3½" hard disc drives.

If you're looking for a proven 20 megabyte drive, ask for the ST225. Call Seagate at 800-468-DISC. Put the best seller to work for you.

 **Seagate**

The first name in disc drives.

solute requirement in a big-computer environment.

The basis for the IBM PC software markets is not source code but compatibility at the machine level. PC programs are distributed as object code, and only object code compatibility is required. Users do not care whether the program source code is "compatible" with some standard, but they do care whether the object code program is compatible with their hardware and how fast it runs. If "incompatible" source code features would improve performance (and pro-

duce the same results), this is a topic of real interest to programmers serving the PC marketplace. Performance optimizations for particular languages and compilers are useful news.

The thing that is constant about a PC marketplace is a "standard interface" between hardware and software; that interface is where applications object code meets the operating system, BIOS, or other hardware interface code. When rating new hardware or software, the only thing that matters is performance while using the standard interface. Applications

can be rated directly. Compilers can be rated as applications that produce applications, and by the performance of the resulting applications. Hardware can be rated by the performance of known applications that use the standard interface.

Of course, "performance" is always relative to something; it is useful to investigate software performance on some "standard hardware." Perhaps the standard hardware in the 8086 environment would be both a classical IBM PC and a PC AT; in this way, programs that take advantage of the 286 could be identified. Different but similar hardware standards would apply to the various 68000 environments. To investigate hardware improvements, there would be a suite of "standard software," and the comparative performance (between the "standard hardware" and the "improved" version) would indicate the effectiveness of the new hardware.

In summary, the failure to "tweak" a benchmark for a particular compiler emphasizes source code compatibility over object code performance, an emphasis that is misplaced in the PC marketplace. Optimizing each benchmark for each compiler (to produce the fastest and tightest code to perform the desired function) should be a normal course of business—unless, of course, you're addressing a big-computer environment.

Terry Ritter
Austin, TX

If you think you can buy a better C compiler, don't. We'll buy it for you.

Buy Let's C[®] with *csd*[™] for just \$75. If you're not satisfied, get Turbo C or QuickC. Free.*



Why are we making this incredible offer? Because we're absolutely certain Let's C and *csd* C Source Debugger are the best C programming tools you can own.

Rest assured that, like its competition, Let's C features incredibly fast in-memory compilation and produces extremely tight, high quality code. The differences lie in how much faster you can perform other programming chores.

Our debugger, for example, can cut development time in half. But that's not all:

"csd is close to the ideal debugging environment... a definite aid to learning C and an indispensable tool for program development."

—William G. Wong, BYTE

And comparatively speaking: *"No debugger is included in the Turbo C package... a serious shortcoming."*

—Michael Abrash, Programmer's Journal

Unlike our competition, Let's C includes its own full-featured assembler, features documentation with complete examples and technical support with complete answers—the first time you call.

LET'S C:

- Now compiles twice as fast
- Integrated edit/compile cycle: editor automatically points to errors
- Includes both small and large memory models
- Integrated environment or command line interface
- 8087 sensing and support

LET'S C AND *csd* FEATURES

- Full UNIX compatibility and complete libraries
- Many powerful utilities including make assembler archiver
- MicroMACS full screen editor with source code included
- Supported by dozens of third party libraries

csd:

- Debug in C source code, not assembler
- Provides separate source, evaluation program and history windows
- Ability to set trace points and monitor variables
- Can interactively evaluate any C expression
- Can execute any C function in your program
- Trace back function

So if you're thinking about buying any other C compiler, think again. But you only have until Feb. 29 to order and take advantage of this special offer. So think fast. And call 1-800-MWC-1700 soon. (1-312-472-6659 in Illinois.)

*Offer available on telephone orders only from Feb. 1, 1988 to Feb. 28, 1988. To exchange Let's C and *csd* for Turbo C or QuickC, return registration card within 15 days of purchase date, notify Mark Williams Company (if you are returning products and receive a return authorization number. Products must be returned within 30 days from shipping date.



1430 West Wrightwood, Chicago, Illinois 60614, 312-472-6659

© 1988 Mark Williams Company

Fantastic

I have one basic comment regarding the planned revision of your benchmark programs (December 1987 editorial): Fantastic! There is a definite need for the revision, as the erratic results obtained by the current benchmarks demonstrate.

I have a few thoughts regarding the revisions:

- Retain the Sieve, Sort, Savage, Whetstone, and Dhrystone tests for historical reasons, if no other; they're not all bad. The Float test should be discarded, since it doesn't represent any real-world processing and is susceptible to being reduced to the trivial by better compilers. The Fibonacci test should be discarded for lack of interest; the algorithm used in the current form is terrible, and the Sieve and Sort tests do a better job of testing integer operations.

- Provide for both higher-level and assembly language forms of the tests. In the higher-level language form, the programs test how well compilers make use of processors' features, and they can serve to compare a compiler's quality for a particular processor. In the assembly language form, a better comparison of processors'

continued



The big idea behind the PC system you can't outgrow.

We call it Modular Systems Architecture™: a building block approach that protects your PC investment against obsolescence. It makes upgrading Wyse PCs a snap—literally. Because we've put all computing functions, even the CPU and its microprocessor, on plug-in boards. So as your needs grow, you can easily upgrade our 8 MHz AT compatible to a 12.5 MHz high performance 286, or even a 16 MHz 386. When more powerful microprocessors are available, you'll even be able to upgrade our top-of-the-line 16MHz WYSEpc 386.



The WYSEpc 386: exceptional memory speed plus processing speed make it one of the most powerful PCs made.

Introducing SystemWyse™ Wyse PCs are themselves building blocks in a comprehensive system for creating solutions. They link effortlessly with our terminals, monitors, and expansion boards in integrated solutions of exceptional quality and value, using industry standard software. And SystemWyse is backed by the company that sells more terminals than anyone but IBM.



It's this easy to upgrade the CPU and boost the power of a SystemWyse PC.

The big idea, above all, is to adapt more readily to change than any other PC system. Because survival belongs not merely to the fittest, but to those who remain fittest, longest. Call for more information. **1-800-GET-WYSE**

WYSE

We make it better, or we just don't make it.

MARCH 1988 • BYTE 29

WYSE® is a registered trademark of Wyse Technology. SystemWyse, WYSEpc 386, and Modular Systems Architecture are trademarks of Wyse Technology. IBM is a trademark of International Business Machines. Screen: Boeing Graph.

Circle 287 on Reader Service Card

effects on performance can be made, since the variation introduced by compilers is eliminated, thus allowing more meaningful comparisons across processor families.

- Verify that the benchmarks' algorithms have been correctly transformed. The Savage program is relatively easy to verify, since the result should be very close to the number of times the loop is executed. The number of primes found is a reasonable verification of the Sieve program. A visual inspection of the Sort program's results could suffice, but I would

prefer something more automated, perhaps sorting randomly rearranged successive integers and then testing for successive integers. The Whetstone program produces some intermediate numerical results that can be verified.

- Extend the Sieve and Sort tests such that 32-bit arithmetic and more than 65K-byte data referencing are required. In the case of the Sort test, make the record size greater than 64 bytes so as to make the test more realistic, and remove opportunities for playing silly games with the 68000 family of processors.

- Devise one or more benchmark programs to test character string manipulations. A large percentage of most computers' time is spent processing textual information, yet there is no well-known benchmark for this type of processing. Devising such a test will be difficult due to such things as character string representation and limits, providing standard text to process, higher-level languages' treatment of (or lack of) character string data types, and so on. Possibly, the character can be combined with some sort of file-accessing benchmark. In any event, there should be more than 65K bytes or characters to process.

- When publishing the benchmark results, the length of time to generate the program, the amount of code generated (both with and without run-time library code), and the size of the translators (compiler, assembler, and linker) are useful data. This data, of course, applies only to the tools needed to produce the executable benchmark programs, but the numbers are of some value in their own right and are sometimes helpful in interpreting the benchmark results.

Everett M. Greene
Ridgecrest, CA

CAN YOU REACH YOUR FULL POTENTIAL WITH ONLY HALF THE VIEW?

Let CPT give you the total view — today. Upgrade your PC, XT, or AT-compatible computer with CPT's full-page displays, at a price far lower than you might expect. For more information on how CPT can expand your display horizons, call 1-800-447-4700.



More Than Office Automation... Office Productivity

PC, XT and AT are trademarks of International Business Machines, Inc.

RT-0301-A

FIXES

Photo Swap

Snow Software informed us of a photo error in the What's New section of the January issue. The photo that appears on page 94 is the Snow Report Writer Screen, rather than Silverado, as it is labeled. The Silverado screen appears on page 96.

Copy Protection and Drawbase

In the What's New section of the January issue, on page 78, some new programs from Skok Systems Inc. are described as not copy-protected.

Drawbase HLR is *not* copy-protected. However, Drawbase 2000, Drawbase 3000, and Drawbase 4000 *are* copy-protected.

Data-Acquisition System Not Micro Channel-Compatible

In the What's New section of the January issue, on page 86, we incorrectly stated that The Automation Group's MDL-16 data-acquisition system is a Micro Channel-compatible product. It is not. The MDL-16 is a stand-alone RS-232C and RS-244 data-acquisition board. It operates as an independent serial peripheral and does not require any slot space in your computer. ■

80386

Imagine the speed and power of a \$100,000 minicomputer in a desktop PC costing under \$7,000. Now imagine all that power going to waste because the operating system you chose was never meant to take advantage of a computer this powerful. It will take more than just a "window environment" or an outdated operating system to unlock the 80386.

It will take PC-MOS/386™

The First 80386 Operating System. Specifically designed for the 80386 computer, PC-MOS/386™ opens doors. Doors to more memory and multi-tasking. Doors to thousands of DOS programs as well as upcoming 80386-specific software. It's the gateway to the latest technology... and your networking future.

Memory Management

Without Boards. PC-MOS exploits the memory management capabilities built into the 80386. So, up to four GIGABYTES of memory are accessible to multiple users and to future 80386-specific applications requiring megabytes of memory.

Multi-Tasking, Multi-

User Support for One, Five or 25 Users. PC-MOS/386™ allows up to 25 inexpensive terminals to be driven by a single 80386 machine. So the features of the 80386 can be utilized at every terminal. And it comes in three versions so you can upgrade your system as your company grows...without having to learn new commands or install new hardware.

**UP TO
25 USERS.**

**MADE FOR
THE 80386.**

**RUNS DOS
PROGRAMS.**

MULTI-TASKING



Software Support for Thousands of DOS Programs. Although PC-MOS/386™ totally replaces DOS, it doesn't make you replace your favorite DOS programs. So you can run programs like Lotus 1-2-3, WordStar, dBASE III, and WordPerfect on the 80386. Best of all, it uses familiar commands like DIR and COPY—so you'll feel comfortable with our system.

The Gateway to Endless

Features. Distinctive characteristics like file/system security, remote access, file/record locking, and built-in color graphics support for EACH user set PC-MOS/386™ apart from all previous operating systems.

Open the Doors to Your

Future TODAY! Call The Software Link TODAY for more information and the authorized dealer nearest you. PC-MOS/386™ comes in single, five & 25-user versions starting at \$195.

PC-MOS/386™

MODULAR OPERATING SYSTEM



THE SOFTWARE LINK

Developers of LANLink & MultiLink Advanced

3577 Parkway Lane, Atlanta, GA 30092

Telex 4996117 SWLINK

FAX 404/263-6174

For the dealer nearest you,

CALL: 800/451-LINK

In Georgia: 404/418-LINK

OEM/Int'l Sales: 404/263-1006

Resellers/VARS: 404/418-5465

DEM/Dealer Inquiries Invited

THE SOFTWARE LINK/CANADA CALL: 905/267-0101

**More Than Just Windows,
We've Opened Doors.**

Circle 245 on Reader Service Card (DEALERS: 246)

TRADEMARK ACKNOWLEDGEMENTS: MultiLink® is a registered trademark of The Software Link. PC-MOS/386™, MultiLink® Advanced, and LANLink™ are trademarks of The Software Link. Lotus 1-2-3, WordStar, dBASE III, & WordPerfect are trademarks of Lotus Development Corp., MicroPro, Ashton-Tate, & WordPerfect Corp., respectively. Prices and technical specifications subject to change.

Now Taking Applications.

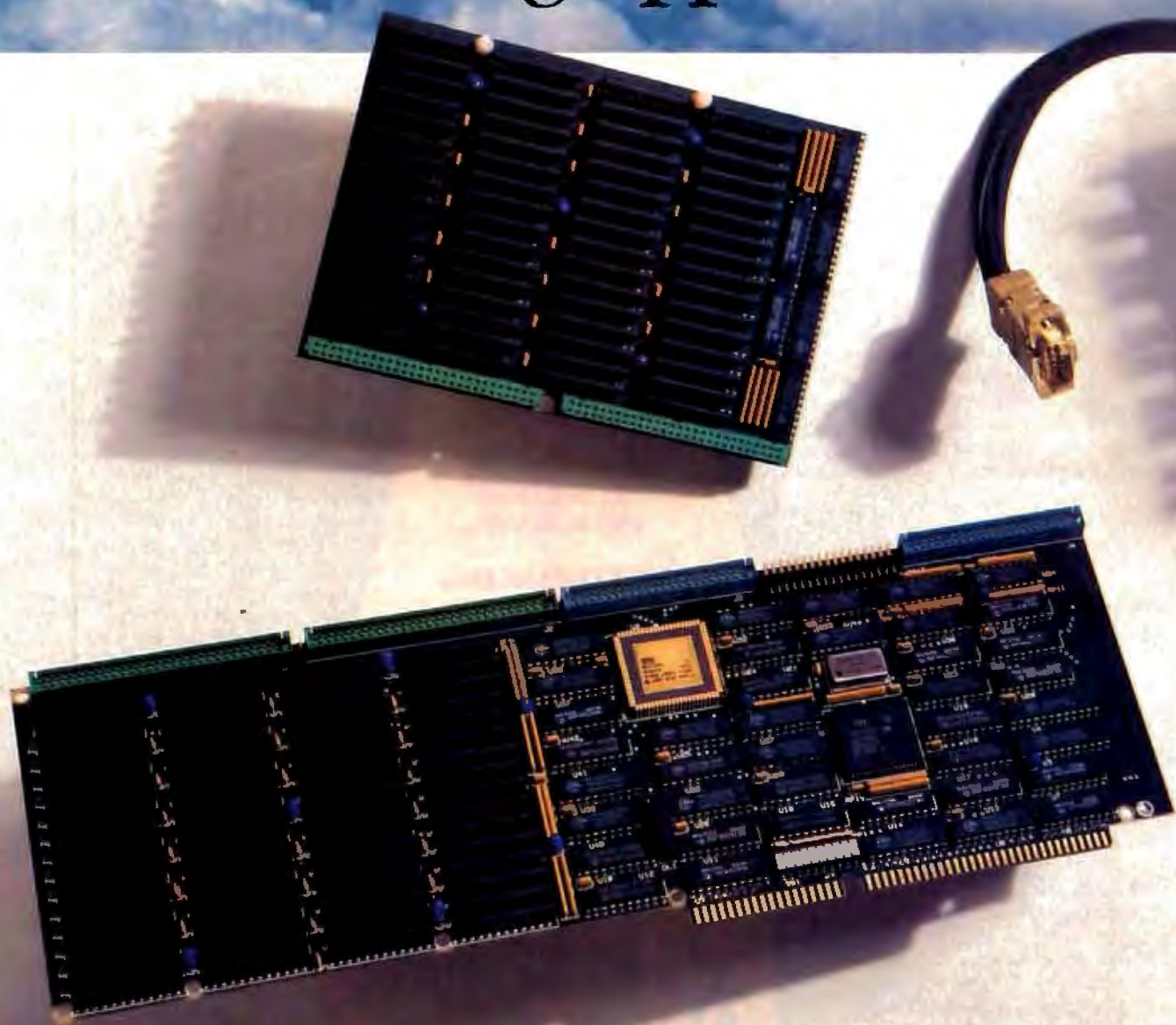

Take a look at the specs on VISTA™, a good look. Notice the processing, programming, and video capabilities? Now think real hard about what *you* could do with the power of VISTA and a microcomputer. Incorporate it with your system to create a digital pre-press proofing station for publishing. Design a graphics workstation which outputs both colorful hi-resolution slides and broadcast-quality animated images. Construct a CAD system which merges computer generated images with real-life backdrops for architecture, packaging or other industries. And, after you've brainstormed your way to new horizons of videographics possibilities, get your own VISTA and start working.

Introducing TRUEVISTA™ Videographics.

VISTA is a powerful single-slot videographics adapter which captures and displays video signals in real time.

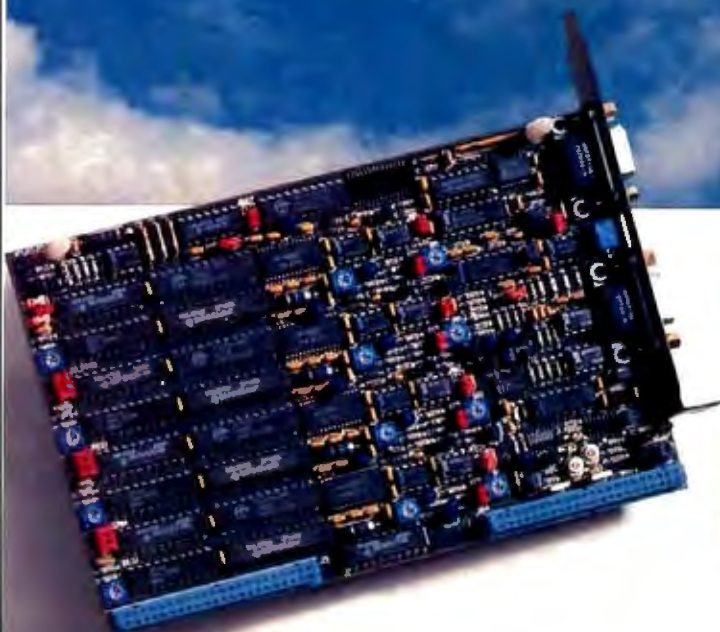

Let's Get Specific.

We knew you couldn't resist seeing the facts, and frankly, our engineers wouldn't have it any other way. Here is an overview of VISTA's key features.

FEATURES:

- 4Mbytes of Video RAM on-board
- Texas Instruments' TMS 34010 GSP
- Flexible, programmable resolutions
- NTSC and PAL compatible
- Four 8-bit channels for real-time capture
- Fully integrated genlock
- Processor memory expandable in 2Mbyte increments to 12Mbytes
- Four 2K x 8-bit CMOS static RAM LUTs
- Display can be color-mapped, RGB, or a versatile combination of both
- Interlaced and non-interlaced display
- Binary and fractional programmable zoom capability, creates horizontal and vertical magnify or minify
- Smooth horizontal and vertical programmable panning, includes wrap-around and split screen
- Suggested Retail Price: \$5995.

ADDRESSABLE RESOLUTIONS:

32 bits/pixel	16 bits/pixel	8 bits/pixel
1024x1024	2048x1024	4096x1024
512x2048	1024x2048	2048x2048
256x4096	512x4096	1024x4096

CAPTURE RESOLUTIONS:*

NTSC	PAL
(RS-170A)	(CCIR-624)
756x486	738x576
604x486	590x576
504x486	492x576
432x486	422x576

*Resolutions are programmable; these are nominal ones for interlaced NTSC and PAL compatible.

DISPLAY RESOLUTIONS:*

NTSC	PAL	Interlaced	Non-Interlaced
(RS-170A)	(CCIR-624)		
1512x486	1476x576	1024x768	768x576
1008x486	984x576	(60 Hz)	(50 Hz)
756x486	738x576		
604x486	590x576	768x768	758x486
504x486	492x576	(80 Hz)	(60 Hz)

*Resolutions are programmable; these are nominal ones.

COMPUTER REQUIREMENTS:

Host Type:	IBM PC AT and 100% Compatibles, Compaq 386, Apollo DN 3000-single-slot board
Data Bus:	16-bit or 8-bit (self-configuring)
Bus Clock:	6MHz to 12MHz
Power Consumption:	15 Watts

It's So Flexible, We've Added Support.

With its Texas Instruments TMS 34010 graphics processor, large quantity of video memory, and proprietary video cross-point, VISTA can be programmed for an array of powerful market-specific videographic applications. To help you maximize VISTA's potential, Truevision offers a range of C-language programming tools for developers. And when your system is market-ready, we'll support your marketing efforts with our TRUEVISION SOFTWARE CATALOG, TRUEVISION NEWS, and THE PULSE.

We're For Higher

Resolution... Power... Flexibility... Quality. Join the many key manufacturers and developers already working with the state of the videographics art, VISTA. Call us at 800/858-TRUE for more information on the VISTA Developer's Program. We're ready to take your application today.

TRUEVISION INC.
7351 Shadeland Station, Suite 100
Indianapolis, IN 46256
800/858-TRUE

Announcing
NuVISTA™
for the Macintosh™ II
It's available soon,
so call for more information.

TRUEVISION INC. *Circle 268 on Reader Service Card*

Create Powerful Programs with Blaise TOOLS

Whether you're an expert or a novice, you can benefit from using special tools to enhance your programs, make them reliable, and give them a professional look. With windows, menus, pop-up memory resident programs, and communications support, Blaise Computing offers you a wide range of programming tools to let you take full advantage of the Microsoft and Borland programming environments. All language support packages include fully commented source code, complete comprehensive manuals and sample programs.

C TOOLS PLUS/5.0 \$129.00

Full spectrum of general service utility functions including: windows; menus; memory resident applications; interrupt service routines; intervention code; and direct video access for fast screen handling. Specifically designed for Microsoft C 5.0 and QuickC.

Turbo C TOOLS \$129.00

Windows and menus; ISRs; intervention code; screen handling including EGA 43-line text mode support; direct screen access; and memory resident applications. Carefully crafted specifically to complement Turbo C.

Turbo POWER SCREEN

COMING SOON! General screen management; paint screens; block mode data entry or field-by-field control with instant screen access. For Turbo Pascal.

Turbo POWER TOOLS PLUS \$129.00

NEW VERSION! Now supports Turbo Pascal 4.0. Screen, window, and menu management including EGA support; DOS memory control; ISRs; scheduled intervention code; and much more.

Turbo ASYNCH PLUS \$129.00

NEW VERSION! Now supports Turbo Pascal 4.0. Interrupt driven support for the COM ports. I/O buffers up to 64K; XON/XOFF; up to 9600 baud; modem and XMODEM control.

ASYNCH MANAGER \$175.00

Full featured interrupt driven support for the COM ports. I/O buffers up to 64K; XON/XOFF; up to 9600 baud; modem control and XMODEM. For Microsoft C, Turbo C or MS Pascal.

KeyPlayer \$49.95

"Super-batch" program. Create batch files which can invoke programs and provide input to them; run any program unattended; create demonstration programs; analyze keyboard usage.

PASCAL TOOLS/TOOLS 2 \$175.00

Expanded string and screen handling; graphics routines; memory management; general program control; DOS file support and more. For MS-Pascal.

EXEC \$95.00

NEW VERSION! Program chaining executive. Chain one program from another in different languages; specify common data areas; less than 2K of overhead.

RUNOFF \$49.95

Text formatter for all programmers. Written in Turbo Pascal: flexible printer control; user-defined variables; index generation; and a general macro facility.

**TO ORDER CALL TOLL FREE
800-333-8087!**

BLAISE COMPUTING INC.

2360 Ninth Street, Suite 316 Berkeley, CA 94710 (415) 540-5441

CHAOS MANOR MAIL

Jerry Pournelle answers questions about his column and related computer topics.

More on SpeedStor

Dear Jerry,

I'm totally baffled as to why anyone would use SpeedStor to split a 42-megabyte hard disk into two 21-megabyte partitions, making the big disk look like two small disks. If you're going to do that, why not just have two 21-megabyte hard disks to start with? Storage Dimensions' advertising would seem to imply that the raison d'être of SpeedStor is to bypass the asinine 32-megabyte disk volume limitation of MS-DOS. When I finally get around to buying a 130-megabyte drive, I'll want to have it set up as one 130-megabyte volume, not four 32-megabyte partitions that look to MS-DOS like four separate physical drives.

SpeedStor gives you a choice of three kinds of partitions: bootable, DOS-compatible, and DOS-extended. The first two are bound by the 32-megabyte limitation; the third is not. That means if you set up the entire drive as an extended DOS partition, you have to boot off another drive, probably a floppy disk drive. There is, however, a better way. Partition the disk into a 1-megabyte bootable partition (C:) and the remainder as a DOS-extended partition with 1K-byte sectors and 2K-byte clusters (D:). Put your boot-up files in the first partition, and make the last line of the AUTOEXEC.BAT read D:. The system should boot up exactly as before, except that you'll wind up with a D:> prompt instead of C:>, and the volume size (if the drive is like mine) will be around 41.5 megabytes.

When you choose the sector and cluster size, SpeedStor will warn you that CHKDSK.COM will not operate. That's true, but when you got Golden Bow's Vopt, you also got CHKDSK.EXE (on the distribution disk), which works just fine on the bigger volume and nonstandard cluster, as does Vopt itself.

Incidentally, what do you think of the new enhanced keyboard? I love it—with one exception. Having two Control and Alt keys is great—if only IBM (and, of course, everyone else) hadn't put the Control keys directly below the Shift keys. Because of that, I'm continually pressing the wrong one while typing. The solution would be simple: Reduce the keys to standard size and put them alongside each other next to the space bar, getting them out from under Shift. Do you

agree? If so, you probably have the clout to suggest that to someone (say, Key Tronic) with some chance of getting it implemented.

Ron J. Goodman
Warrensville, OH

Well, I could say I like having two logical disk drives, but in fact I was just too lazy to figure out the proper installation the first time, and after that it was a bit late with stuff stored on both disks. I expect I'd have done it differently another time.

DataDesk keyboards come with a switch and replacement key caps; you can put the Control key to the left of the A key, where it belongs, and relegate the CapsLock down to below the Shift. I love DataDesk keyboards. I'm typing this on one.—Jerry

Mouseless Microsoft Word

Dear Jerry,

Regarding the Delete Word command in Microsoft Word (Computing at Chaos Manor, October 1987): You can create a macro to delete a single word in Word, using SuperKey. Try this:

```
<LFT><F8><Del>
```

(using SuperKey terminology). The left arrow command is to account for the case when the cursor is on the last character of a word that is followed by a punctuation mark, when pressing F8 would send the cursor to the punctuation mark.

I wonder if PC-Write would get rave reviews if users had to pay the same for it as they pay for the "big" programs (\$450 list, \$229 street price). I've tried PC-Write, and I find its interminable dot commands and myriad special keystrokes for every little function illogical and confusing. Give me Microsoft Word's pop-up mnemonic menus (automated by a few SuperKey macros) any time.

Robert Hawkins
Greenville, MS

continued

Jerry Pournelle holds a doctorate in psychology and is a science fiction writer who also earns a comfortable living writing about computers present and future. He can be reached via BYTE, One Phoenix Mill Lane, Peterborough, NH 03458.

Thanks To The T3200, The Desktop PC Can Now Take Its Place In History.



When the eagerly awaited PC first hit the desks of the public, everyone figured it was there to stay. It was, after all, powerful and functional. And considering it weighed about 40 lbs., it would take a lot to unseat it.

Introducing a lot. The new Toshiba T3200.

In a sleek 18.7 lb. package, the T3200 acts like no other portable, or overweight desktop PC AT,[®] for that matter.

With its two internal expansion slots, you can connect to a LAN, a mainframe, or add peripherals.

It also has a 12 MHz 80286 micro-processor, a 40MB hard disk, and a 720KB 3 1/2" diskette drive.

And when it comes to memory, the T3200 rivals your clunky desktop. With its 1MB RAM that expands to 4MB. We even gave it a built-in, gas plasma EGA display and monitor port. Which, by the way, are optional on your old desktop.

All of which means you should call 1-800-457-7777 for your nearest Toshiba computer and printer dealer.

And ask to see the first portable PC powerful enough to push the desktop right into the history books.



The T3200 is backed by the Exceptional Care program. No cost enrollment required. See your dealer for details. PC AT is a registered trademark of International Business Machines Corporation.

In Touch with Tomorrow
TOSHIBA

Toshiba America, Inc., Information Systems Division

Yeah, I know you can do almost anything with macros in Microsoft Word 4.0. WordStar 4.0 is pretty good, too. I understand they're adding macros to Word Perfect as well. Every time one of the editing programs improves, the others do. Makes for an embarrassment of riches, but I'd rather have that problem than not enough choices. —Jerry

Floatable Computer?

Dear Jerry,

I have a problem. I am lusting for a computer, and I live on a boat. Living on a boat means that I have only 12-volt electricity, very little space, no proper lighting, and so on.

I would like to get an MS-DOS computer. It must run on 12 V DC, be very sturdy, and not drain too much electricity, and I must be able to buy (rather than transfer) software for it.

You have written several times about the Zenith Z-181, but the problems you mention with regard to null modem cables and so forth seem too great for me. I have the boat in the Caribbean now, and I have enough problems getting things like lightbulbs.

Could you please comment on the Toshiba T1100 Plus and the NEC Multi-

Speed in relation to the Zenith Z-181? Can you think of any other portables that might be in this class?

Bren Jacobson
Northville, NY

I may have made the difficulties of transferring software to the Z-181 sound greater than they were; anyway, given Traveling Software's wonderful Laplink (which comes with cables), that's all history.

I am told that Zenith makes a 12-V power adapter. I find my Z-183 (which has a hard disk drive) nearly perfect except for its weight. Whether it will stand up to a corrosive salt water atmosphere is another story.

The Toshiba and NEC portables are also very nice. I prefer the Zenith, largely on the basis of the keyboard and backlit screen. Again, I'd be awfully concerned about corrosion.

I used to have the smallest legal midget ocean racer (a 20-foot Weber-designed sloop) on the Pacific coast. That was before computers. I miss her. —Jerry

In Defense of DP Departments

Dear Jerry,

You've come down rather critically re-

garding data processing departments having much control over the purchase/setup/use of personal computers. My experience in relatively small corporations having from 10 to 30 or so PCs at any one time leads me to the following conclusions:

Early in 1988 there are still many, many more totally new and completely naive PC users than there are even very moderately experienced users. Of every 10 users I've dealt with, only 2 had learned after 6 months how to use a utility program like PC Tools other than by rote while referring to written notes. For them, if it isn't on a menu, it isn't possible to do without help. Only 1 in 10 had moved on their own to a level of competence more than minimally acceptable within the one or two applications (word processing or Lotus 1-2-3) necessary to do their jobs. Fully 8 of every 10, if asked to do something that required learning a significant new area of an application that they had worked with for some time, demanded training and hand-holding before they would even begin to approach the problem.

For the large majority of users, there is no willingness to take a manual home or

continued on page 269

Introducing the OpenEnder™ Intelligent Multi-Channel Communications Board for PS/2.

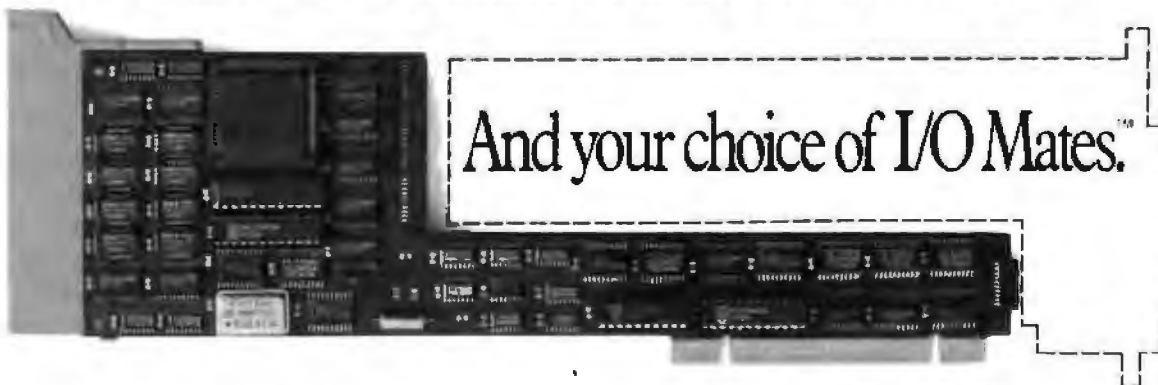

Now, with DigiBoard OpenEnder™ Intelligent Communications Boards, you can channel the power of IBM Personal System/2 to up to 32 users, 400% faster than the boards you're probably using now.

But what really sets DigiBoard OpenEnders apart is that you only have to pay

for the expensive intelligent part once. Because your I/O functions are handled by affordable I/O Mate™ modules that simply plug in.



So, for the first time in the history of intelligent communications boards, your I/O options are wide open. And they always will be.

Call 1-800-344-4273. In Minnesota, (612) 922-8055.

FOXBASE+ / Mac
Coming Soon...

dBASE Users!
Independent Reviewers Say:

Nobody Beats The Fox ...Nobody's Even Close



Data Based Advisor



BYTE Magazine

FoxBASE+ Fastest By Far

BYTE* benchmarks show that FoxBASE+ takes only 14 minutes to do what dBASE III PLUS needs an hour to do. The others are even slower. Clipper needs an hour and 17 minutes. Quicksilver needs an hour and 40 minutes.

Nobody beat FoxBASE+ in *even one* of the 27 BYTE benchmarks.

FoxBASE+ zipped through the exhaustive Data Based Advisor** benchmarks in just 15.5 minutes. New FoxBASE+ /386 ran them in only 7 minutes! By contrast Clipper took 53

minutes, Quicksilver took 59 minutes, and dBASE III PLUS took an hour and 18 minutes.

Why Waste Your Time?

BYTE's data shows FoxBASE+ is up to 7 times faster. DBA's benchmarks show FoxBASE+ is over 5 times faster.

You can *run* with Fox... or you can *crawl* with them.

FoxBASE+ Delivers Now... The Others Only Promise

We're totally committed to insuring that FoxBASE+ will *always* be fastest... now and in the future. *You can't buy a faster product.*

But that's not all...

FoxBASE+ offers other great features like: true compatibility... familiar interactive commands like BROWSE and EDIT... "dot-prompt" programming... major language extensions... ideal development environment... and a *money-back guarantee*.

So call us for the details. After all...

Nothing Runs Like a Fox.

FOXBASE 

FoxBASE, FoxBASE+, and FoxBASE+ /386 are trademarks of Fox Software. dBASE III PLUS is a trademark of Ashton-Tate. Clipper is a trademark of Nantucket. Quicksilver is a trademark of WordTech Systems.

*Using the benchmark timings published in BYTE, September 1987.

**Using the suite of benchmarks published in Data Based Advisor, March 1987.

Fox Software
118 W. South Boundary, Perrysburg, Ohio 43551
(419) 874-0162 Telex: 6503040827 FOX
FAX: (419) 874-8678

ASK BYTE

Steve Ciarcia answers your questions on microcomputing.

dBASE Deletions

Dear Steve,

At the office, I work on an IBM PC using various software packages, including dBASE II Plus. I discovered that, while using one database and executing an APPEND from another database, all the characters like the Hebrew letter "Mēm" (on a Hebrew keyboard) are totally deleted. This ruins the whole display of the data that I've just added to the database with APPEND. (Every occurrence of the letter Mēm is deleted, and the rest of the letters are carried back one space for each deletion.)

The IBM guide (*IBM Personal Computer—National Supplement—Israel*) regards the Mēm character as decimal 13 (hexadecimal 0D). SideKick regards the character as decimal 141 (hexadecimal 8D).

I am not a professional programmer; I'm working as a secretary while studying for my second degree in education, and most of my knowledge is self-learned. Therefore, I don't have the tools to solve this problem on my own. What could be the reason for the malfunction of dBASE that I described above, and what can I do to correct it and avoid the problem in the future?

Dalia Hasson
Haiifa, Israel

I never cease to be amazed at the awful consequences of even simple changes to programs. In your case, dBASE is eating the disappearing Mēm in the mistaken belief that it's a carriage return instead of a printable character.

In the ASCII character set, a carriage return is represented by a decimal 13 (hexadecimal 0D), and that's what most programs expect to see. Some programs ignore the high-order bit when looking for control codes, so both hexadecimal 0D and 8D are often treated as carriage returns because they differ only in that bit position.

You can write a small dBASE program to see what ASCII code dBASE uses for Mēm:

```
CLEAR
SET TALK OFF
STORE 0 TO keyval
DO WHILE keyval = 0
  @ 5,5 SAY "Press a key to display
```

```
the ASCII value"
keyval = InKey( )
ENDDO
?
? "The ASCII value is"
? keyval
```

If Mēm turns out to be 0D, then there's no simple fix. What you'll need to do is write programs that convert Mēm into some other (unused) character before storing it in the database, then convert it back before displaying it. This is barely acceptable if you're using programs to control all the database operations, but it's unworkable if you're doing it by hand.

Perhaps a variant of that idea might be useful. You could write a program to scan a database file and replace all occurrences of Mēm with another character. You could write another program to convert them back after you've done the APPEND. This might work, but the scanning that the program will have to do might fail if dBASE filters out the hexadecimal 0D and 8D characters. You'll have to try it to see.

I'd also expect that you'd have problems with Hebrew characters that map to other ASCII control codes, such as hexadecimal 0A (linefeed), 0C (formfeed), and 07 (bell). I wish I had a clean solution for you, but I suspect that there just isn't one. It's a shame that dBASE isn't more international, but it's also a shame that there isn't a solid standard that would allow programmers to handle multiple character sets.—Steve

A 360K-byte Apple Drive

Dear Steve,

I have an Apple II Plus, and I was wondering why I couldn't rewire the disk drive card so that it could control a 360K-byte floppy disk drive (say, a Remex 480—cost around \$35). If I could patch the card to do this, I could write software to control the drive appropriately. I know the Apple disk drive was done this way when Apple converted from DOS 3.2 to DOS 3.3.

Leo Kratz
Fairgrove, MI

With the current availability of industry-standard disk drives at bargain prices, many Apple computer owners

would like to make a switch. Actually doing so, however, is a major problem. When Apple introduced it 10 years ago, the Apple disk drive was an elegantly engineered solution to the need for a minimum-hardware disk system for Apple's entry into the rapidly growing personal computer market.

The Apple disk system uses a group coding (GCR) data format that uses software to perform tasks that are commonly done in hardware with industry-standard systems. The Apple disk drive/controller hardware remained essentially unchanged in the transition from DOS 3.2 to 3.3; a coding change in the PROMs enabled the system to discriminate two consecutive zero bits when reading the disk. This permitted an increase from 13 to 16 data sectors per track because of greater data density permitted by the larger number of usable code groups. DOS 3.3 thus uses a single-sided, 35-track, 16-sector GCR format. The only change required for the transition from 3.2 to 3.3 was a new disk controller PROM and the new master disk software; the drive itself was unchanged.

When IBM established the de facto industry standard as a double-sided, double-density 40-track 360K-byte disk drive, modified frequency modulation (MFM) encoding, using an NEC μPD765 series controller chip, Apple's elegant solution became something of a millstone. Because of control signal and other differences, the Apple drives can-

continued

IN ASK BYTE, Steve Ciarcia, a computer consultant and electronics engineer, answers questions on any area of microcomputing. The most representative questions will be answered and published. Send your inquiry to

*Ask BYTE
c/o Steve Ciarcia
P.O. Box 582
Glastonbury, CT 06033*

Due to the high volume of inquiries, we cannot guarantee a personal reply. All letters and photographs become the property of Steve Ciarcia and cannot be returned.

The Ask BYTE staff includes manager Harv Weiner and researchers Eric Albert, Tom Cantrell, Bill Curlew, Ken Davidson, Jeannette Dojan, Jon Elson, Frank Kuechmann, Tim McDonough, Edward Nisley, Dick Sawyer, Robert Stek, and Mark Voorhees.

WE'VE JUST MADE THE BEST EVEN

Better

Peachtree Complete II: The Business Accounting System

New

The success story of Peachtree Complete (now with over 200,000 users) continues with the newest member of the Peachtree family, **Peachtree Complete II**. Much more than just an update, Complete II builds upon the comprehensive features that have made Peachtree the leader in small business accounting software for nearly ten years. We've added many exciting new features and designed state-of-the-art methods for using the packages. The result—all eight modules are even more powerful and easy to use, yet still priced at just **\$199**—a 96% price reduction from the original \$4,800.



Windows and Pop-Up Menus.

Complete II is designed for user convenience. Use the cursor throughout the system to make easy "point-and-shoot" selections. If you can't remember a customer or account number while using a program, simply open a window and scroll through your customer list or chart of accounts. Select the information you're looking for directly from the table!

Short-Cut Keys. We speed you from one function to another without the time-consuming task of manually passing through multiple menus.

Smart HELP. If you get stuck, the same function key will always bring HELP to your rescue with pop-up windows of information that relate to your individual trouble spot at both program and field levels.

Quick-and-Easy Error Handling.

Complete II traps errors and gives a plain-English description of the problem along with suggested solutions.

Range Printing. Print all information on a report or select a specific range of information for print out. A great feature for restarting long reports or partial printing of certain sections.

Easiest Installation Ever. Enter your company's information once and it is reflected throughout the system. Complete II includes a separate Installation Guide, basic Accounting Primer, eight-volume Reference Library and extensive Tutorials on each package — all at no extra charge!

Ideal for Service Businesses. Enter information free form on service invoices or store pre-defined paragraphs of up to 160 characters. Enjoy full editing capabilities at time of invoice entry.

Eight Integrated Software Modules

- General Ledger
- Accounts Receivable
- Invoicing
- Accounts Payable
- Inventory
- Fixed Assets
- Job Cost
- Payroll

Complete II includes eight software modules that may be integrated or installed individually and may be distributed among separate computers. Install the most critical modules initially; add others later.

COMPARE FEATURE FOR FEATURE

System-Wide Features

- NEW Over 450 reports
- NEW Unlimited number of companies and consolidations
- NEW Automatic menu-driven conversion of your existing Peachtree Business Accounting data files
- NEW Increased numeric capacities to 1999,999,999.99 in key areas

General Ledger

- Chart of Accounts includes 76 suggested and 26,000 user-defined screens
- NEW 1 to 13 user-defined fiscal periods
- Repeating journal entries
- NEW Financial statement comparisons may include current period and year-to-date with budget and/or prior period comparison
- NEW Reversing journal entries

Accounts Receivable/Invoicing

- Open items or balance forward customers
- NEW Up to 14,400 customers
- Supports partial payments
- NEW User-defined terms codes and aging periods
- NEW Automatic transactions with monthly, bi-monthly, quarterly, semi-annual, and annual frequency options

Accounts Payable

- Up to 14,400 vendors
- NEW Partial payments of invoices
- Cash requirements forecasting by due date
- NEW User-defined billing cycle on automatic invoices
- Checks printed with unlimited invoice listing on stub
- NEW Ability to void and reprint checks

Inventory

- Supports average, last purchase and standard costing methods
- Up to 19,500 inventory items (SKU's)
- NEW Automatic price change on multiple items by percent or amount

Fixed Assets

- Handles 13,000 assets and 13 methods of depreciation
- NEW Updated to handle current tax laws

Job Cost

- Tracks costs and profitability on a job-by-job basis
- Compares estimated costs with actual costs for specific tasks

Payroll

- Built-in current year federal, state, city and county tax tables for all 50 states with automatic calculation capabilities
- Automatic payroll processing supporting hourly, salaried, commission or draw-against-commission pay types
- NEW New tax laws incorporated into program
- Processes up to 3,900 employees
- NEW Supports Cafeteria Plan
- User modifiable tax tables with updates published regularly by Peachtree Software
- NEW Printed and magnetic media W-2s generated automatically



Money-Back Guarantee

When you purchase Peachtree Complete II directly from Peachtree Software, you're protected with a 30-Day Money Back Guarantee. If you're not satisfied, simply return the product in saleable condition within 30 days and your purchase price will be promptly refunded. (A \$20 restocking fee will be charged if disk bag is opened.)

And, of course, Complete II is backed by Peachtree Software's famous technical support, labeled by *InfoWorld* as "the finest in the industry". Technical assistance is available for \$1 per minute with a 20-minute minimum via a toll-free telephone number. You only pay for what you need, without unnecessary support contracts.

Buy Forms Direct from Peachtree

Enjoy the convenience and economy of buying your forms directly from Peachtree Software with guaranteed compatibility. Call 1-800-553-6485 to order forms. In Ohio, call 1-513-973-0110.

Announcing PDQ II

Transfer your valuable Peachtree accounting information to Lotus 1-2-3®, dBASE™ and other programs for further analysis, plus create custom reports, invoices and statements with Peachtree Data Query II. Updated to take full advantage of the increased capabilities of Peachtree Complete II, PDQ II is priced at just \$199. Call today to order!

Hardware Specifications

Requires PC/MS-DOS version 2.0 or higher with 384K of usable memory with a minimum 10 MB hard disk. For use with the IBM® PC, PC XT, PC AT, Personal System/2™ and compatibles. 3 1/4" media optionally available. IBM is a registered trademark and Personal System/2 is a trademark of International Business Machines. Not copy protected.

To Order by Mail, Send \$199 Plus \$12.50 Shipping and Handling to: (In Georgia, add applicable sales tax.)

Peachtree Software

A Member of the Intelligent Systems Family
4355 Shackleford Road, Dept. BYT,
Norcross, GA 30093

Call Now to Order
or for a Dealer Near You
1-800-247-3224
In Georgia, call 1-404-564-5800



Circle 196 on Reader Service Card

\$199
Still Only
Complete

CD-ROM/WORM

ALL PRODUCTS, LOWEST PRICES,
EXPERT ADVICE

INTRODUCTORY OFFER

Hitachi CDR-1503S CD-ROM drive \$895
and your choice

- Grokler Electronic Encyclopedia (+\$80 after 1/88) or
- Microsoft Bookshelf with MS-DOS Extension or
- McGraw-Hill Science and Technical Reference Set or
- PC-SIG 817 PC Software Programs

Hitachi CDR-1503S CD-ROM DRIVE \$729
with Digital Audio Input/Output \$929

Full height - standalone - front auto-load - Hi-Fi CD audio capabilities (with CD-PLAY described below) - daisy chain capabilities - for IBM PC/XT/AT and full compatibles

Hitachi CDR-3500 CD-ROM DRIVE \$829
with Digital Audio Input/Output \$979

Half height - internal mount - same features as Hitachi CDR-1503S

WORM DRIVES—400 MB \$2799
—800 MB \$3799

Full height - standalone - for IBM PC/XT/AT and full compatibles

Call for pricing on all Hitachi, Phillips, Denon, Sony and Panasonic drives

SOFTWARE FOR HITACHI AND COMPATIBLE CD-ROM DRIVES*

CD-PLAY \$95

Permits user to play CD audio disks. RAM resident "Pop-up" accessory - compat role with all major software - recognizes CD and displays track title information outputs to headphones or stereo amplifier

CD-PLAY + SAMPLER \$195

Same features as CD-PLAY plus CD sampling functions for electronic musicians

CD-TEST \$195

Tests accuracy of data storage on CD audio disks - for audiophiles CD-Professionals (available soon)

CD-UTILITIES \$195

Quick Basic routines permit software developers to access CD ROM/Audio drive capabilities

CDP sells all software including the International Dictionary of Medicine and Biology - Med Line - Library References and Indexes - Encyclopedia of Chemical Technology - Corporate Databases

Call for Prices/Catalogues. Special prices for first time customers, computer dealers, corporate/government accounts libraries, educational institutions International shipments a specialty

TO ORDER CALL 800-MEGABYTE (634-2298)

INQUIRES CALL 212-996-6999

Policy: Shipping and handling extra. Personal and company checks require 3 weeks to clear. For faster delivery use your credit card (add 3% for MC and Visa, add 5% for AMEX) or send a cashier's check or bank money order. New York residents add 8.25% sales tax. All prices are U.S.A. prices and are subject to change and all items are subject to availability. Defective software will be replaced with the same item only. Hardware will be replaced or repaired within the terms and limits of the manufacturer's warranty. We cannot guarantee compatibility. All sales are final and returned shipments are subject to a restocking fee.

CDP

Compact Disc Products, Inc.
217 East 85th Street (Suite 216)
New York, NY 10028

not be used with other controllers, and non-Apple-type drives cannot be used with an Apple controller.

The Apple drive hardware and software is discussed in considerable detail in the following books: Understanding the Apple II by James Sather, Understanding the Apple IIE by James Sather, Beneath Apple DOS by Don Worth and Peter Lechner, and Beneath Apple ProDOS by Don Worth and Peter Lechner. All four books are available from Quality Software, Computer Book Division, 21601 Marilla St., Chatsworth, CA 91311.

At one time, there were several sources for kits to convert industry-standard drives made by Shugart and MPI to work with the Apple controller. You might be able to use one of them to adapt drives such as the Remex 480 you mentioned. I know of only one source now: W. M. Enterprises, 266 Hillsmere Dr., Annapolis, MD 21403.—Steve

An Apple Coxswain

Dear Steve,

I have a rowing exercise machine hooked up to my Apple II using the game I/O connector SW2. It keeps track of the number of strokes I do, and, using the 1/60 second interrupt on my mouse card, I can display the time, strokes per minute, required strokes per minute, and other calculations that I want.

I would also like to monitor my heartbeat and increase or decrease my required strokes per minute based on my pulse rate. I've seen several units that monitor your pulse using infrared sensors on either the finger (not good for rowing) or the earlobe.

I picked up an infrared phototransistor (TIL414) from Radio Shack and hooked it up to one of the paddle connectors. It works with a light source, giving different values as the distance from the light varies, but it isn't going to work on the earlobe or the finger the way it is. Can you give me some help with this?

Dave Partyka
Lorain, OH

You've already got about half of what you need to monitor your pulse. The other half consists of an infrared LED, which you can obtain from Radio Shack. You should connect the LED between +5 volts and ground using a series resistor with a value in the 100- to 500-ohm range.

If you place the LED on one side of your earlobe and the phototransistor on the other, you should be able to monitor pulse frequency. You may need to experiment with various series resistance values (varying LED brightness) to ob-

tain the best results. Fastening the rig to your ear may be the biggest headache. Perhaps you could use a post-type earring, with the LED and phototransistor epoxied in position.

A more sophisticated method might use a photodiode buffered with an op-amp instead of the phototransistor. This would give you a faster response, but you may not need it for your application.—Steve

Love Me, Love My Imagewriter

Dear Steve,

I surrender! After a number of years as an Apple user, I have concluded that I must switch to an MS-DOS machine. However, I have developed a fondness for my 15-inch-carriage Imagewriter, and therein lies my question. Will my Imagewriter work using the standard serial port on IBM clones? Will I have problems using my Imagewriter with products such as Lotus 1-2-3, dBASE, and Microsoft Word? I live in Heidelberg, West Germany, and technical assistance (in English) is hard to come by. I hope you can help.

Alan P. Alborn
APO, NY

Your desire to keep your Imagewriter is understandable—it's an excellent printer that's worth holding on to. You can use it with an IBM-type computer with minimal effort. There is one potential problem that you may encounter, however, which leads us to the RS-232C follies. As many people have discovered, "RS-232C standard" is an oxymoron, like "harmonious discord."

The Imagewriter is configured for DTE operation. If the serial port on your IBM PC is also configured for DTE, the result will be a conflict between the two devices. The simplest solution is to configure your serial port for DCE operation (if possible). Some microcomputers come with two serial ports—a printer port wired for DTE and a modem port wired for DCE. Usually, you can alter configurations with shorting blocks or switch settings. Consult the documentation of whatever PC you obtain to determine the procedure for making the change. If you cannot configure the port suitably, you could use a null modem cable or adapter.

As with RS-232C, there is no such thing as a standard null modem cable. To simplify the confusion, let's assume you're using a cable with a DB-25 connector at each end. In all common variations, pin 2 at each end is tied to pin 3 at the other, and pin 7 connects straight through. The rest of the connections vary considerably. Some of the possibilities are as follows:

continued

FROM CREATION

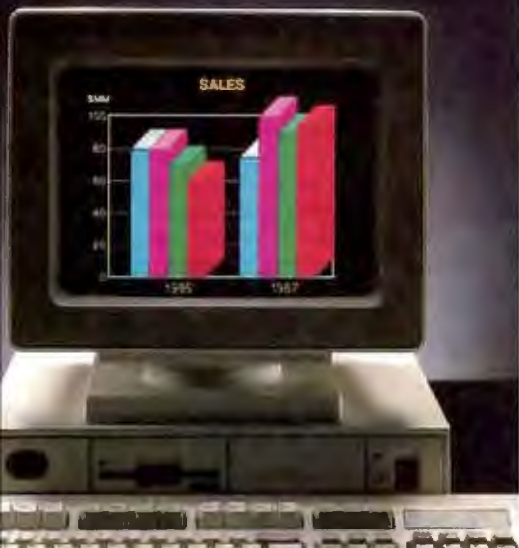

You've created a file or document on your PC. Now what?

Because most business information needs to be communicated, most people print the computer file and send the papers by mail, courier or fax. Or maybe send a floppy disk.

If the recipient needs to manipulate or revise the data, it must be rekeyed.

That's the time-honored—and the time-consuming—way of doing business.

What's a faster, cheaper, better way? Western Union EasyLink® service.

TO COMMUNICATION



Western Union EasyLink lets you send and receive data and documents between computers. Without a detour onto paper or the inconvenience of a courier. And you can be sure what you send is exactly what's received.

You can use EasyLink to move the information that moves your business in seconds. You can move orders and text files. Receive reports and graphics. Even send product specs and spreadsheets.

Fast revisions—without rekeying

EasyLink connects the computers you use, regardless of type or location. Files on one computer can be sent to other computers, eliminating the need to rekey data.

More than just computer communications

EasyLink even lets you send messages to fax machines. Reach your company's

mainframe. And communicate *between* offices or businesses.

Best of all, the cost of sending a message is comparable to a postage stamp. And unlike telephone, the distance makes no difference.

Western Union—a leader in electronic communication

With EasyLink, we're bringing proven reliability to today's technology. And you'll get added value with EasyLink services like InfoMaster®, the largest electronic library with more than 800 databases.

Let EasyLink take your PCs from creation to communication. To learn how *your* business can benefit, return the coupon.

Or call:
1-800-247-1373, ext. 7181

IF YOU CREATE IT ON A PC SEND IT ON A PC WITH EASYLINK

YES, tell me more

Show me how EasyLink can turn my company's PCs into an efficient, economical new way to communicate.

Name _____
Title (please print) _____
Company _____
Bus. Address _____
City/State/Zip _____
Bus. Phone () _____

Mail to: Western Union EasyLink
P.O. Box 37472
Omaha, Nebraska 68137

Or call: 1-800-247-1373, ext. 7181

 **EasyLink**

LABELING SOFTWARE



For DOT MATRIX and Laser Printers

(Epson/IBM/Okidata/LaserJet)

- Labels for shelves, bins, inventory
- Text readable up to 50 ft.
- Bar Codes: 1 2 of 5, UPC/ EAN MIL-STD, AIAG, Code 39
- Any size label • Flexible format
- Color options • Reversals • Fast
- File input • Menu driven • \$279
- Other bar code programs from \$49.
- Not Copy Protected!

30 Day Money Back Guarantee!

Bar Code Readers for PC, XT, AT, PS/2



- Reads 2 of 5, UPC/EAN, Code 39
- Attaches as 2nd Keyboard
- No software changes to add bar codes to any program
- Rugged stainless steel wand
- Optional Magnetic Stripe Reader only \$100 additional
- External attach to all PS/2 models
- External OR Internal to PC, XT, AT
- Upgrade from PC to PS/2-only \$30

PC, XT, AT model \$385
PS/2 model \$399
also RS-232 model \$399

30 Day Money Back Guarantee!

WORTHINGTON
DATA SOLUTIONS

417-A Ingalls Street,
Santa Cruz, California 95060
408/458-9938

• Tie pins 5, 6, and 8 together at each end, then connect them as a group to pin 20 at the other end.

• Tie pins 4 and 5 together at each end; tie pins 6 and 8 together at each end, then connect to pin 20 at the other end.

• Tie pin 4 at each end to pin 5 at the other; tie pin 20 at each end to pin 6 at the other.

You can ignore pins that I haven't mentioned above. You may need a breakout box, and you'll certainly need a lot of patience to get things working. You can simplify the situation somewhat by using a straight-through connecting cable together with a prewired null modem adapter (both available from sources such as JDR Microdevices and Jameco Electronics—see the back of BYTE for their ads). It is usually easier to alter the connections inside an adapter than to rewire the cable itself.—Steve

Parts Is Parts

Dear Steve,

I enjoy building interface cards for my Apple II (I purchase bare boards for this). Usually, I have no problems locating the parts I need. However, I have now run into a brick wall. I am looking for a General Electric DS3D PC-mount nickel-cadmium battery and a TTLDM-100 time-delay IC. If you know where I can locate these components, please let me know.

Joseph E. Pratt
St. Ann, MO

It's always encouraging to hear from fellow "roll your own" types. In a field increasingly dominated by appliance users, putting together your own hardware can get pretty lonely. While I can make a number of suggestions regarding your quest for parts, it would be easier to be specific if you had provided more information (such as the number of pins, the width of the sought-after IC, and the voltage/amperage of the needed battery).

Your best bet for obtaining the nickel-cadmium battery (GE DS3D) you require is probably an industrial supplier in a major nearby city, such as St. Louis or Kansas City. You can probably obtain the battery (for its equivalent) through sources you should be able to locate in the phone book. Digi-Key Corp. (P.O. Box 677, Thief River Falls, MN 56701), a frequent advertiser in BYTE and other publications, carries a line of nickel-cadmium batteries in various sizes, although most are designed to be used in holders rather than soldered directly into a printed circuit board. You might be able to use one of these batteries with minor board modifications to accommodate the

battery holder. It's important to match the battery's voltage, amperage, and charge/discharge rate if you make a substitution. You may also have to make slight circuit modifications to permit substitution of a nonrechargeable type (such as a lithium cell). The major component in such a circuit change is the addition of a diode such as a 1N914, to prevent charging (you may also need a resistor).

The IC designation you've given—TTLDM-100—doesn't match anything I've been able to find in my references. Perhaps it is a manufacturer's in-house number.—Steve

CIRCUIT CELLAR FEEDBACK

Remember the S-100?

Dear Steve,

Several of my friends and projects are on hold for lack of information. For the most part, I've exhausted local sources, so my roommate, Alex Pournelle, suggested I write and ask you.

At the moment, my main home computer is a CP/M Jade "Big Z" CPU card with a Z80 and one serial port, a Jade "Double D" 8-inch floppy disk controller and four 8-inch drives, a 64K-byte CMOS memory board (with the address range F000-FFFF hexadecimal locked out for the monitor/boot ROM and disk window), and a CCS 2830 six-port RS-232C card. All these boards are supposedly IEEE-696 compatible, and I have mangled the BIOS to support them. This system runs in an old 12-slot Problem Solver Systems cabinet with two internal 8-inch drives.

Over the years, I have reconfigured the system many times, but I always run into either power supply or slot-count limits. I have a number of S-100 peripheral boards on the shelf, and I have recently been given another complete CP/M system consisting of an ICOM dual floppy disk drive system, a Soroc terminal, and an IMSAI 8080 S-100 frame holding even more S-100 boards. I'd like to convert the IMSAI itself to IEEE-696, so that I can move my existing system into the IMSAI frame (which has a much larger power supply and 22 slots). My problem is that I have not been able to locate any information about updating old S-100 bus equipment.

I'm sure there are thousands of Altairs, IMSAIs, Vectors, and North Stars out there gathering dust. They only need updating to the IEEE-696 standard and adding some modern Godbout, Teletex, Lomas, or Advanced Digital S-100 boards

continued

New Prices

OS/2

WINDOWS FOR DATA®

MULTI-LEVEL MENU SYSTEM

NESTED POP-UP FORMS

SCROLLABLE REGION

CHOICE LIST

CLOCK

POP-UP WINDOW

RUNNING TOTALS

MESSAGE WINDOW



Cursor keys scroll, ENTER selects and ESC exits choice menu

If you program in C, take a few moments to learn how Windows for Data can help you build a state-of-the-art user interface.

- ✓ Create and manage menus, data-entry forms, context-sensitive help, and text displays — all within windows.
- ✓ Develop window-based OS/2 programs right now, without the headaches of learning OS/2 screen management. Run the same source code in PC DOS and OS/2 protected mode.
- ✓ Build a better front end for any DBMS that has a C-language interface (most popular ones do).



FROM END TO BEGINNING

Windows for Data begins where other screen packages end, with special features like nested pop-up forms and menus, field entry from lists of choices, scrollable regions for the entry of variable numbers of line items, and an exclusive built-in debugging system.

NO WALLS

If you've been frustrated by the limitations of other screen utilities, don't be discouraged. You won't run into walls with Windows for Data. Our customers repeatedly tell us how they've used our system in ways we never imagined — but which we anticipated by designing Windows for Data for unprecedented adaptability. You will be amazed at what you can do with Windows for Data.

YOU ARE ALWAYS IN CHARGE

Control functions that you write and attach to fields and/or keys can read, compare, validate, and change the data values in all fields of the form. Upon entry or exit from any field, control functions can call up subsidiary forms and menus, change the active field, exit or abort the form, perform almost any task you can imagine.



OUR WINDOWS WILL OPEN DOORS

Our windows will open doors to new markets for your software. High-performance, source-code-compatible versions of Windows for Data are now available for PC DOS, OS/2, XENIX, UNIX, and VMS. PC DOS

versions are fully compatible with Microsoft Windows. **No royalties.**

MONEY BACK GUARANTEE

You owe it to yourself and your programs to try Windows for Data. If not satisfied, you can return it for a full refund.

Prices: PC DOS \$295, Source \$295. OS/2 \$495. XENIX \$795. UNIX, VMS, please call.

Call: (802) 848-7731

ext. 51

Telex: 510-601-4160 VC SOFT

FAX 802-848-3502



Vermont Creative Software

21 Elm Ave.
Richford,
VT 05476

UNIX is a trademark of AT & T Bell Laboratories.

SORD Wins Hands Down



M680UX Series

- ★ Operable with UNIX*
 - ★ Astonishing speed: use of 32-bit Motorola 68020 CPU
 - ★ Easy expansion: VME bus architecture
- Also available on OEM basis.

SORD®

Software & hardware

— Quality through technological innovation —

SORD COMPUTER CORPORATION

20-7, Masago 5-chome, Chiba-shi, Chiba 260, Japan

TEL (0472)79-2671 TLX 3722484 SORDC J FAX (0472)77-6696

New York: (212)759-0140



UTAH

COBOL™

NEW
VERSION 4.0

\$**69.⁹⁵**

For IBM®PC's, XT's, AT's and other DOS machines. This is the one you've heard so much about - with fast compile times, small object code modules, no royalties, and clear error messages. Version 4.0 is based upon ANSI-74 standards with new features including:

- Multi-key Indexed files with up to 24 keys. This advanced feature requires the software package Btrieve® which is optionally available.
- Windowing, pop-up's, color and overlays. This advanced feature requires the software package Saywhat?™ which is optionally available.
- ACCEPT numerics with decimal point alignment, numeric checking, AUTO-SKIP, SECURITY, LENGTH-CHECK, EMPTY-CHECK.
- Fast memory mapped DISPLAY's (1, 5) ERASE, BEEP, ATTRIBUTE.
- Level 88's - READ INTO - WRITE/REWRITE FROM - and DELETE
- An easy to use, COBOL source code EDITOR with auto line numbering, A-margin, B-margin tabbing with full screen cursor control

Current customers can receive the new version by sending in their original diskette and \$30.00. This offer expires Dec 31, 1987

Also available: Utah FORTHAN, Utah BASIC, Utah PASCAL, Utah PILOT, Btrieve and Saywhat?™. Used by 50,000 professionals, students and teachers in 40 countries.



SINCE 1977

ELLIS COMPUTING™

5655 Riggins Court, Suite 10

Reno, Nevada 89502

To order call:
(702) 827-3030

IBM is a registered trademark of International Business Machines, Inc. Btrieve is a registered trademark of Softrcraft, Inc. SAYWHAT?™ is a trademark of The Research Group. Utah COBOL is a trademark of Ellis Computing, Inc. © 1987 Ellis Computing Inc.

CIARCIA FEEDBACK

to turn those computers back into contributing members of a computing society. Upgrading old S-100 equipment to IEEE-696 might make a good topic for an article.

I will probably buy an SB180 (September 1985 Circuit Cellar) if I can modify it two ways: adding 512K bytes for an expanded RAM disk, and interfacing an ST-506 drive to it (sacrificing the SCSI port if need be). My application is a process control system that must be able to survive a very dusty environment, will be 30 miles from the nearest road (i.e., infrequent service calls), and will be able to receive remote uploads via modem.

I plan to buy your Home Run Control System (April 1985 Circuit Cellar) or build my own. However, I'd like to add to it a receiver for X-10 codes so I can continue using my telephone responder and ultrasonic console (on different house codes to avoid undesired interaction). Have you considered this option?

My house was built in the late 1930s, and it's extremely difficult to run any kind of wiring inside the walls or the attic. (The current Heathkit catalog has an X-10 module designed to connect to dry contacts on a household alarm system to output an "all lamps on" command or "all lamps on" plus "one appliance module on" command. This transmitter, modified for only the "appliance module on" code, would be ideal, if I could set up the Home Run Control System so it would receive the signal and then respond accordingly.)

This is an idea for a future Circuit Cellar project: Many people (including myself) are still using daisy-wheel printers on printer buffers. Often, when I'm printing a large piece of correspondence, I use several different print wheels, depending on what symbol I want. I might use one wheel for text, another for italics, and another for mathematical symbols. I have not yet seen a printer buffer on the market that accepts a "pause code" (i.e., a series of bytes that I could send to the buffer, commanding it to pause so I can change print wheels, then push a Continue button on the box so that printing resumes).

Also, only one manufacturer that I have seen offers a buffer that allows you to select serial or parallel in and serial or parallel out, so that you can still use the buffer box even if you change your printer, your computer, or both.

Mike Morris
Arcadia, CA

Let me get this straight: Alex Pournelle's roommate is asking me for information? This sounds like Dear Abby get-

continued

The best decision for
millions of businesses,
educators and home users.

Quality.

Reliable performance is our design objective. Our engineering team takes pride in the exceptional quality they can produce utilizing our proprietary test equipment. The result: a 33,000-hour mean time between failure.

Compatibility.

Our MS-DOS® based computers are the best-selling PC compatibles in America. Tandy 286- and 386-based business systems are Microsoft® OS/2 ready as well.

Why Tandy® Computers? Because there is no better value.™

Technology.

Innovative design, custom circuitry and distinguishing features make our computers more than just clones. Plus, every Tandy desktop computer is designed and built in our own USA manufacturing plants.

Connectivity.

Tandy PC compatibles can be linked into a workgroup for communications with other PCs and mainframe computers alike.

Longevity.

Technology has been our business for sixty-six years. In 1977, we became the first company to successfully manufacture and market a personal computer—nobody's been in the business longer.

High performance, great prices and the best service and support in the industry.

Tandy Computers:
Because there is no better value.

Radio Shack®
COMPUTER CENTERS

A DIVISION OF TANDY CORPORATION

MARCH 1988 • BYTE 45

ATARI PRINCE

Apple II

SUNDAY 10-5

PROMPT DELIVERY

**COMPUTERS, PRINTERS,
DISK DRIVES, MODEMS,
MONITORS, ACCESSORIES,
FURNITURE & EXPERIENCE**

**GUARANTEED
LOWEST PRICES**

1-800-874-1235

TOLL FREE
OUT OF N.Y.
IN N.Y. CALL (212) 463-8330

S & W COMPUTERS & ELECTRONICS
31 West 21 Street, New York, N.Y. 10010

HOURS: Mon-Thurs 9-6
Fri. 9-2, Sat. 10-5, Sun. Closed

* Credit Card Accounts charged at time of order * Add shipping & handling * Min. Limited * Prices without invoice * Not responsible for typographical errors

ting another letter from the lads at Yale!
I've got to admit that all my S-100 and CP/M knowledge is rather dated by now—and not having done anything with it for a while, the grisly details are fading fast. The current repository of such knowledge may be the S-100 Journal, which you can reach at P.O. Box 1914, Orem, UT 84057. It's \$14 for a year's worth of quarterly issues, \$27 for 2 years. A letter to the editor of S-100 Journal might well turn up someone who knows the answers to your IEEE-696 questions.

For the original SB180 design, 256K bytes is the upper limit on the RAM. The boot EPROM shows up in the lower 256K bytes of the total 512K bytes of address space and is not fully decoded. You could hack the board to "shadow" the EPROM and add more RAM on the expansion port, but it might be a little messier than you'd like, because we didn't really intend to expand the SB180's RAM. The newer SB180FX, which uses the same HD64180 as the SB180, allows up to 4 megabytes of RAM.

As far as hitching an ST-506 hard disk drive directly to the SB180 goes, I think you're wasting your time. Admittedly, the drive is cheap, but if you're figuring in any nonzero value for your time, the total cost is going to be a lot higher, particularly because this sounds like a one-time project.

If you're looking for reliability, you want a stock solution without little yellow wires hanging off the boards. It's always fun to mess around with (read "improve") someone else's circuitry, but is that really what your client wants? Remember, he's paying for results, not "clever" design.

Back to the SB180FX. It has a SCSI port on-board, so it's easy to add an external hard disk drive with an outboard SCSI controller, such as the XEBEC 1410A. (You can usually find someone advertising the XEBEC controller in the back of BYTE. This device allows a SCSI port to control an ST-506 hard disk drive.)

Concerning your remarks about an X-10 receiver, stay tuned for a few upcoming Circuit Cellar power-line projects. These projects should provide you with the X-10 control you appear to be longing for.

Another upcoming project is the Circuit Cellar SmartSpooler, which functions as a rather bright print spooler with all combinations of parallel and serial inputs and outputs. I'm setting it up to allow downloading custom software through the standard printer port, so you can tinker with this project to add a "pause" code.—Steve ■

PowerStation™

A Complete VT220 / VT241 Work Station Upgrade for the IBM PC/XT/AT and PS/2

"Now true 800 pixel wide VT241 display and VT220/VT241 support for VMS Services for MS-DOS."

PowerStation™ 240	\$435	EGAmate™	\$39
VT240 style keyboard and ZSTEM VT240 Emulation Software		Daughterboard option for 132 columns and 800 pixel	
Optional WPS labeled keys (GOLD KEY MODEL) add \$30		ReGIS on standard EGA adaptors	
ZSTEM pc™ - VT240 Emulator Emulation Software only.	\$295	PS220/2	\$19
VT240/241 Emulation software with all the features of ZSTEM VT220 plus ZSTEM 4014 serial and ReGIS graphics		Keyboard adaptor cable for PS200 on PS/2 systems	
PowerStation™ 220	\$289	ZSTEMpc™-4814 Emulator	\$99
VT220 style keyboard and ZSTEM VT220 emulation Software		Use with ZSTEM VT100, VT220, or stand-alone	
Optional WPS labeled keys (GOLD KEY MODEL) add \$30		Interactive zoom and pan. Save/recall images from	
ZSTEMpc™-VT220 Emulator Emulation Software only	\$150	disk. Keypad, mouse, digitizer, printer, plotter, and	
All the features of ZSTEM VT100 plus 8-bit mode, downloadable fonts, user defined keys, full national/multi-national modes, Extended macros/script language. True 132 columns on Hercules, VGAs, Super VGAs, and standard EGAs using the EGAmate option. 128 columns on CGAs. 43 line support on EGAs. Enhanced keyboard support. Ungermann Bass Net/One and VMS services for MS-DOS support		TIFF support. 4100 color and line style color mapping	
		640 x 400 and 640 x 480 on some adaptor/monitors	
		ZSTEMpc™-VT100 Emulator	\$99
		High performance COLOR VT100. True double	
		high/wide smooth scrolling ISO and arbitrary	
		mapped color. XMODEM and KERMIT. softkey/MAC	
		RGS, DOS access	

KEA Systems Ltd.
#412 - 2150 West Broadway, Vancouver, B.C. Canada V6K 4L9
Support (604) 732-7411 TELEX 04-352848 VCR FAX (604) 732-0715
Order Desk (800) 663-8702 Toll Free
30 day money back guarantee AMEX/MC/VISA

GET SERIOUS

NEW MENUING
INTERFACE AND
RELIABILITY PROCEDURE



...ABOUT ANALYZING YOUR DATA.

You might be spreading your spreadsheet a little too thin. Or maybe you're starting from scratch. But if you're serious about data analysis, you're ready for SPSS/PC+™ — a full software family that brings you eight high-powered ways to complete any data analysis task.

Enter it. SPSS Data Entry II™ is a fully integrated data entry, cleaning and editing tool.

Analyze it. The SPSS/PC+ base package provides a powerful array of statistical and reporting procedures.

Picture it. SPSS/PC+ Graph-in-the-Box™ featuring New England Software's Graph-in-the-Box™ offers full color "snapshot" graphics.

Examine it. SPSS/PC+ Advanced Statistics™ lets you get more serious with your data.

Predict it. SPSS/PC+ Trends™ — our latest option — is the complete time series analysis/forecasting tool.

Table it. SPSS/PC+ Tables™ produces presentation-ready tables instantly.

Chart it. SPSS/PC+ Graphics™ featuring Microsoft® Chart creates show-stopping graphs and charts.

Map it. SPSS/PC+ Mapping™ featuring MAP-MASTER™ creates maps where vast amounts of data can be summarized and presented in one, simple picture.

SPSS/PC+ products are being put to productive use by serious fact finders in business, government and education. For countless purposes such as market research. Wage and salary studies. Survey analysis. And quality control. Plus each product is superbly documented and supported by SPSS Inc., a leader in statistical software for nearly 20 years. While specially tailored customer support is available through the VALUE PLUS™ plan. And SPSS now offers a SPSS/PC+ version for Novell LANs.

So if you're serious about data analysis, step up to SPSS/PC+. For details, contact our Marketing Department.

CALL 1/312/329-3315

SPSS inc.

SPSS Inc. • 444 North Michigan Avenue, Suite 3000 • Chicago, Illinois 60611

In Europe: SPSS Europe BV • P.O. Box 115 • 4200 AC Gonnichem, The Netherlands • Telephone: + 31183036711 • TWX: 21019

SPSS/PC+ runs on IBM PC/XT/AT's with hard disk. Contact SPSS Inc. for compatible microcomputers. SPSS/PC+, SPSS Data Entry II, SPSS/PC+ Graph-in-the-Box, SPSS/PC+ Advanced Statistics, SPSS/PC+ Trends, SPSS/PC+ Tables, SPSS/PC+ Graphics and SPSS/PC+ Mapping are trademarks of SPSS Inc. VALUE PLUS is a trademark of SPSS Inc. Chart and Microsoft are trademarks of Microsoft Corporation. MAP-MASTER is a trademark of Ashton-Tate. Graph-in-the-Box is a trademark of New England Software, Inc. © 1987. SPSS Inc.

Introducing the two on earth



The new COMPAQ DESKPRO 386/20™

The world now has two new benchmarks from the leader in high-performance personal computing. The new 20-MHz COMPAQ DESKPRO 386/20 and the 20-lb., 20-MHz COMPAQ PORTABLE 386 deliver system performance that can rival minicomputers! Plus they introduce advanced capabilities without sacrificing compatibility with the software and hardware you already own.

Both employ an industry-standard Intel® 80386 microprocessor and sophisticated 32-bit architecture. Our newest portable is up to 25% faster and our desktop is actually up to 50% faster than 16-MHz 386 PC's. But we did much more than simply increase the clock speed.

For instance, the COMPAQ DESKPRO 386/20 uses a cache memory controller. It complements the speed of the micropro-

cessor, providing an increase in system performance up to 25% over other 20-MHz 386 PC's. It's also the first PC to offer an optional Weitek™ Coprocessor Board, which can give it the performance of a dedicated engineering workstation at a fraction of the cost.

They both provide the most storage and memory within their classes. Up to 300 MB of storage in our latest desktop and up to 100 MB in our new portable.

It simply works better.

most powerful PC's and off.



and the new 20-MHz COMPAQ PORTABLE 386™

Both use disk caching to inject more speed into disk-intensive applications and both will run MS® OS/2.

As for memory, get up to 16 MB of high-speed 32-bit RAM with the COMPAQ DESKPRO 386/20 and up to 10 MB with the COMPAQ PORTABLE 386. Both computers feature the COMPAQ® Expanded Memory Manager, which supports the Lotus®/Intel®/Microsoft® Expanded Memory Specification

to break the 640-Kbyte barrier imposed by DOS.

With these new computers plus the original COMPAQ DESKPRO 386™, we now offer the broadest line of high-performance 386 solutions. They all let you run software being written to take advantage of 386 technology, including Microsoft, Windows/386 Presentation Manager. It provides multitasking capabilities with

today's DOS applications to make you considerably more productive. But that's just the beginning. For more information, call 1-800-231-0900, Operator 43. In Canada, call 416-733-7876, Operator 43.

Intel, Lotus, Microsoft, and Weitek are trademarks of their respective companies.
©1987 Compaq Computer Corporation
All rights reserved.

COMPAQ®

You Never Regret A **WYSE** Decision



WYSEpc 286 SYSTEM

Intel 80286 Running AT 8 and 12.5 MHz
 Phoenix Bios • 1.2 Meg Floppy Drive
 102 - Key Enhanced PC - Style Key Board
 1 Meg of Parity Checked RAM
 Clock/Calendar with Battery Backup
 WYSEwindow system status display
 190 W Power Supply • GW-Basic 3.21
 1 Serial and 1 Parallel Port
 MS-DOS 3.21 and Users Guide
 20 Meg 65ms Hard Disk Drive

\$1,795

\$2,295



WYSEpc 386 SYSTEM

Intel 80386 Running AT 8 and 16 MHz
 Phoenix Bios • 1.2 Meg Floppy
 102-Key Enhanced PC - Style Keyboard
 1 Meg of 0 wait state static ram
 Clock/Calendar with Battery Backup
 WYSEwindow system status display
 1 Serial and 1 Parallel Port
 GW - Basic 3.21 • 220 W Power Supply
 MS-DOS 3.21 • FREE PC - MOS/386
 41 Meg 28ms Hard Disk Drive

\$3,750

\$4,250

HERCULES COMPATIBLE MONO SYSTEM

EGA COLOR SYSTEM With WY-640 Hi Res EGA MONITOR

OPTIONS

- 2nd Floppy Drive 5 1/4" 360K \$99
- 2nd Floppy Drive 3 1/2" 720K \$155
- 41Meg 28ms Hard Disk Drive \$210
- 1200 Baud Internal Modem w/Software \$99
- 2400 Baud Internal Modem w/Software \$199
- 12.5 MHz Speed Option \$450

- NEC Multisync EGA Monitor \$99
- 71 Meg 28 ms Hard Disk Drive \$450
- Math Co-Processor
- Extended Service Contract Available
- Other Options Available

THIRTY-DAY MONEY BACK GUARANTEE

You can return any B & W SYSTEMS, INC. computer system within thirty days of the date of shipment. Return the items like new with complete documentation, warranty cards and packing material. Return product cards and packing material. Return product must be labeled with a Return Merchandise Authorization (RMA) number and shipped prepaid and insured.

ONE YEAR LIMITED WARRANTY

We warrant our products to be free of defects in material and workmanship for a period of one year from the date of shipment. The Warranty covers the cost of all materials and labor.

- WORLDWIDE SERVICE AND SUPPORT
- QUANTITY DISCOUNTS AVAILABLE
- No Extra Charge for Visa or Mastercard

TO ORDER TOLL FREE

1-800-638-9628

For Information Call — (301) 963-5800

Visa • Master Card



7877 Cessna Ave
 Gaithersburg, MD
 20879

© B & W SYSTEMS, INC.

Trademarks: WYSE — trademark of WYSE Technology • MS-DOS & OS/2 — trademark of Microsoft Corporation • Hercules — trademark of Hercules Computer Technology • NEC — trademark of NEC Corporation • PC-MOS/386 — trade mark of Software Link. Specifications, configurations, and prices subject to change without notice. Copyright 1987 B & W SYSTEMS, INC.

BOOK REVIEWS

THE MS-DOS
ENCYCLOPEDIA
Ray Duncan, editor

IBM PERSONAL
SYSTEM/2 AND
PERSONAL COMPUTER
BIOS INTERFACE
TECHNICAL
REFERENCE

MEMORY RESIDENT
PROGRAMMING
ON THE IBM PC
Thomas Wadlow

THE MS-DOS
ENCYCLOPEDIA
Reviewed by Bill Bourn

Microsoft Press, Redmond,
WA: 1988, ISBN 1-55615-
049-0, 1570 pages, \$134.95

What do you call a single volume containing over 1500 pages, 15 appendixes, and 5 sections, one of which contains 20 distinct articles? Suppose that material came from 14 contributors and 64 technical advisers. Microsoft Press calls this massive collection *The MS-DOS Encyclopedia*. With its multitude of distinctively presented examples, written in both assembly language and C code, the book is closer to being a handbook, although you'd need Schwarzenegger's wrists to manage it with only one hand. I guess "encyclopedia" has become an unwelcome synonym for "comprehensive treatise" since Jiminy Cricket first defined the word.

In addition to the 20 articles written by such MS-DOS experts as Ray Duncan, Charles Petzold, and Van Wolverton, the book contains 240 pages detailing individual descriptions of MS-DOS user commands, 200 pages of usage descriptions for programming utilities, and 250 pages devoted to the description of DOS system calls via the INT instruction. Much of that material is already available in the respective user guides for the various software. Why repeat it all here?

There is, I suppose, a good reason, depending on your need: The descriptions in the book span all the versions and OEM suppliers of MS-DOS—pretty handy if, as a programmer, you don't have all the versions of all the DOS manuals from Compaq to Zenith at your disposal. Even though this material has been covered elsewhere, including it all in one volume (along with the possible error messages that you might get when using any



Illustration by Len Kulberda

command) turns that volume into the one to fetch for nearly all DOS-related questions.

The Articles

The most unique part of *The MS-DOS Encyclopedia* is the first section, whose 20 articles delve into those mysteries that have tantalized the intellectual DOS user. I was disappointed that the internal control structures are so lightly covered in the article on the components of MS-DOS; it's rather like describing a car as a chassis, engine, wheels, fenders, and passenger compartment. I want to know about the pistons, crankshaft, and oil pump inside the MS-DOS engine. That level of detail is denied us here.

Other articles deal with the structure of an application program; managing files, records, directories, and volumes; memory management; and several other topics—merely scanning the table of contents gives evidence of the breadth of coverage in this section. Nothing I read here (or elsewhere in the book) struck any discord with what I already knew about MS-DOS. I depend on the high caliber of the contributors for having

checked the factual accuracy of the contents.

A few articles deserve specific mention. In his article "Terminate-and-Stay-Resident Utilities," Richard Wilton does a creditable job of classifying the kinds of trouble you could have trying to write a TSR routine for MS-DOS. After the "rules of the residency-road," he presents two TSR routines in complete form, with accompanying explanatory text. The first routine is a simple, passive TSR that merely says "Hello." The second TSR is a more useful routine that attempts to cover all the conditions under which a TSR might be invoked. This sample TSR is invoked from the keyboard, writes to disk, recognizes the status of pending hardware interrupts, and generally addresses all the other nitty-gritty details that appear to be required for a successful TSR.

Microsoft has yet to publish an official method or set of guidelines for using this DOS function, which has been in place since release 2.0. A myriad of useful routines have been published in that vacuum; all take advantage of the TSR capability but have widely varying degrees of compatibility with each

continued

dB Fast™ -VS- Clipper™

\$69
Limited time
offer!

New dBase III Plus™ Compiler

- Smaller EXE's
- Faster compilation
- Faster execution
- Lower price!

OPERATION	dB Fast	Clipper
Minimum .EXE file size	1kb	140kb
Compiling/Linking	2 Seconds	4 Minutes
Execution time	6 Seconds	17 Seconds
PRICE	\$149 \$69	\$695

d-Smallest! With Clipper™ the smallest program you can create is 140k. And it goes up from there! dB Fast™ creates programs as small as 1k with typical program sizes from 5 to 10k. Just think, now it's possible to fit all your programs on one floppy disk. And if you send files via modem — look what happens to your modem phone bill... it almost disappears!

d-Fastest! dB Fast compiles and links in a blistering 3 seconds. Clipper slugs along at 4 minutes. dB Fast compiled programs also run faster. A program that took over 1 full minute to run using dBase III Plus and an additional 17 seconds using Clipper, ran in just 6 seconds with dB Fast!

d-Cheapest! See for yourself why dB Fast is d-Biggest Bang for d-Buck! Nowhere can you get all these features for such a low price:

- dBase III Plus compatible
- LAN compatible
- Unlimited runtime
- Protected source code
- No need to modify your PRG files
- Speed, efficiency, price



60 day Guarantee

Try dB Fast for 60 days. If you're not totally satisfied for any reason, just send it back for a full refund (less \$10 handling fee).

Call today! 1-800-356-6356

sales information call 1-206-392-0368

Dealer inquiries welcome

	Qty	Subtotal
<input type="checkbox"/> VISA	dB Fast _____ @ \$69	_____
<input type="checkbox"/> MasterCard	Shipping: \$4 U.S., \$25 outside U.S. (add \$5 for each additional package)	_____
<input type="checkbox"/>	WA residents add 8.1% sales tax	_____
<input type="checkbox"/>	Total	_____
		(U.S. funds only)

Name: _____

Company: _____

Address: _____

City: _____ St. _____ Zip: _____

Phone #: _____

Payment (circle one): VISA MC AMX Check

Card #: _____

Expires: _____

Name on Card: _____



1420 Gilman Blvd.
Suite 28-57
Issaquah, WA 98027-9399

Profuse examples and minute details make The MS-DOS Encyclopedia's coverage of debugging a must for any programmer who knows that even the purest of heart are visited by gremlins.

other. *The MS-DOS Encyclopedia* takes a brave step into the resulting melee to give us these examples of "decent" TSR behavior. However, the volume includes a disclaimer: "Microsoft cannot guarantee that the information in this article will be valid for future versions of MS-DOS."

TSR programs come up again in an article on the Microsoft object linker program, as an example of using the linker to organize memory. This article and the preceding one on the structure of object files (also by Wilton) may well be unique among books on MS-DOS, and this is undoubtedly due to the extreme specialization of the topic. The articles go into great detail, which is welcome here, particularly if you need to know how to build some "food" for the linker program as a part of your large project. The feast includes analysis of every bit of every byte in any object module. Wilton must have been working with Microsoft's internal documentation to provide such a complete description.

Steve Bostwick's article, "Debugging in the MS-DOS Environment," vigorously attacks the problems facing a programmer whose program doesn't work. Bostwick presents a variety of techniques, ranging from simple eyeball examination to complex analysis using CodeView, which comes with Microsoft's high-level language compilers. In one example, he uses a TSR program to echo data from the serial port onto the screen. The article briefly discusses hardware debuggers, their capabilities, and the circumstances for their use, but it avoids discussion of specific non-Microsoft hardware products. Profuse examples and details down to the byte in error make this coverage of debugging a must for any programmer who knows that even the purest of heart are visited by gremlins.

What Could Be Missing?

Amid the wealth of information included in *The MS-DOS Encyclopedia*, it's hard to tell what might have been left out. Aside from a more detailed discussion of DOS's internal structure, I missed comprehensive discussions of networking and file-sharing. The first article, which describes the haphazard infancy of MS-DOS, includes a reproduction of a large scribbled diagram showing the original network support logic for MS-DOS 3.0, but the topic deserves an article of its own. (That first chapter, by the way, is of interest to all DOS users, not just programmers, and it's worth borrowing the book just to read.)

The book could stand to have a glossary and a bibliography, which are quite useful adjuncts to serious study—whatever the subject. It does have a two-part index that is unique; commands and system calls are listed separately from the other subjects. Getting used to this arrangement might take you a while.

The complete set of the examples from the book is available on two 5 1/4-inch floppy disks, or presumably one 3 1/2-inch disk, for the exorbitant fee of \$50. This seems to condone the use of the examples, but Microsoft should make its intentions clearer about the use of sample code in a reader's own products. In

continued

Order Status,
Technical & Other
Info. (602) 246-2222
FAX # (602) 246-7805

Call for programs
not listed



SPECIAL
MICROSOFT WORD 4.0
\$195

No Charge for
MasterCard or Visa



TOLL-FREE ORDER LINE 1-800-421-3135

FREE SOFTWARE! FREE SOFTWARE! FREE SOFTWARE!

Purchase over \$100 and receive one of these disks absolutely FREE! Purchases over \$250 get two free disks, over \$400 get three, or get all four disks when your purchase is over \$500! 1) **MIXED BAG**—A great assortment of utilities and games all packed on one disk. 2) **PC-WRITE**—Try this famous feature packed word processor. It's a winner! 3) **FONT-SET**—Lets you set popular fonts like bold, underline, etc. on most late model printers from Citizen, Epson, NEC, Okidata, Panasonic, Star, Toshiba, etc. You can even use your printer like a typewriter! 4) **ABC-LIST**—Great mailing list program! Sort on any field, do qualified searches, print reports and mailing labels, and more!

-- SOFTWARE --		Microsoft		Word Perfect		AZ 10		MONITORS	
ACCOUNTING		Macro Assembler	Call	Executive	\$106	150 watt power supply, dual 360K drive, 10 MHZ mother board, 640K, keyboard \$670		AMDEK	
Cyma	Call	Microsoft Pascal	Call	Word Perfect Library	59			410 Amber	\$145
Dac Easy Acct.	\$54	Microsoft Quick Basic	\$59	Wordstar Pro	233			Magnavox RGB	Call
Dac Easy Payroll	39	Microsoft Quick C	59	Wordstar 2000+	194	PRINCETON			
Dollars & Sense	94	Ryan McFarlan				Max 12	138		
In House Acct.	112	Fortran	342	-- HARDWARE --		HX 12E	460		
Managing Your Money 3.0	117	Ryan McFarlan		ACCESSORIES		SAMSUNG			
COMMUNICATION PROGRAMS		Cobol	549	Brooklyn Bridge	72	TTL Amber w/tilt	75		
Carbon Copy Plus	108	Turbo Basic	59	Copy II PC Bd.	75	Color w/tilt	249		
Crosstalk XVI	89	Turbo C	59	Curtis Ruby	59	PRINTERS			
Crosstalk MK4	110	Turbo Pascal	59	Mach III Joystick	36	CITIZEN			
Remote	89	Turbo Prolog	59	Masterpiece	88	MSP 10	249		
Smartcom II	79	MULTI-USER SOFTWARE		Masterpiece+	99	MSP 15	315		
DATA BASE MANAGERS		Fox Base	299	150 Watt		MSP 20	285		
Clipper	375	Word Perfect	310	Power Supply	69	120 D	142		
Condor 3	325	Word Perfect Modules	ee 75	BOARDS		Premiere 35	471		
DBase III Plus	Call	Microsoft Word	Call	AST		Tribute 224	639		
DB-XL	80	PROJECT MANAGER		Advantage Premium	422	EPSON--			
Fox Base Plus	195	Microsoft Project	Call	Sixpac Premium	Call	Call on all models			
Genifer	189	Super Project Plus	Call	Sixpac	145	NEC			
Paradox 2.0		Timeline 2.0	270	HERCULES		P5XLP	815		
Premium	435	Total Harvard Man. 2	Call	Color Card	145	P7 Parallel	595		
PFS: Pro File	Call	SPREADSHEET		In Color Card	302	8850	1059		
Powerbase	169	Lotus 1-2-3	Call	Graphics Plus	182	P6 Parallel	419		
Q&A	189	Microsoft PC Excel	Call	Intel		P960XL	1005		
Quicksilver	295	Spreadsheet Auditor	82	Above PC 64K	225	P2200	335		
Revelation	464	Supercalc 4	Call	Above 286	319	OKIDATA--			
R Base System V	Call	Surpass	329	Orchid Tiny Turbo	289	Call on all models			
Reflex	81	VP Planner	65	SUNTEK		PANASONIC			
Relate & Report	112	UTILITIES		IO XT	65	1080-I/M2	Call		
VP Info	65	Copy II PC	19	IO AT	65	1090-I/M2	Call		
DESKTOP PUBLISHING		Copywrite	39	TALLTREE		1092-1	Call		
Pagemaker	479	Cubit	30	J Ram 3 ATP	Call	1524	Call		
PFS: First Publisher	59	Deskview 2.0	72	COMPUTERS		1592	Call		
Ventura Publisher	475	Direct Access	49	AZ 386		1595	Call		
GRAPHICS		Eureka	95	80386-16 Micro Processor, 1 MB of Ram, Teac 1.2 MB disk drive, 220 watt power supply, 6 layer mother board, RT keyboard \$2995		3131	Call		
Chartmaster	199	Fastback Plus	92	AZ TURBO AT		3151	Call		
Design Cad 2	148	Formtools	58	512K, 6 & 10 MHZ, keyboard, 200 watt power supply, one 1.2 teac drive, Phoenix Bios \$975		3151	Call		
Diagram Master	Call	Graph in the Box 2	55	AZ TURBO XT		3151	Call		
Easy Cad	109	Mace	55	135 watt power supply, One 360K drive, 640K, keyboard \$519		3151	Call		
Energraphics 2.01	294	Microsoft Windows	59	MODEMS		335	Call		
Generic Cad	49	Norton Advanced	75	AZ 300/1200	75	RAM			
In-A-Vision	270	Norton Utilities	48	Everex 300/1200	89	64K 150NS	16.50		
Microsoft Chart 3.0	Call	PC Tools Deluxe	37	Hayes 1200	Call	258K 150NS	33		
Newsroom Pro	65	Prokey 4.0	70	Hayes 1200B	Call	TERMS: Shipping on most software is \$5.00 AZ orders + 6.7% sales tax. Personal check / company check—allow fourteen (14) days to clear. We accept purchase orders from authorized institutions for 3.5% more than cash price. All returns are subject to our approval. There will be a 20% restock fee. Minimum phone order \$50. All prices are subject to change. Due to copyright laws, we cannot take back any open software.			
Printshop	33	Q DOS II	49	Hayes 2400	Call				
INTEGRATED		Rightwriter	75	U.S. Robotics 2400	335				
Ability	56	Sidewick	55	MICE		Genius	59		
Ability Plus	Call	Sideways	39	Logitech	Call	Microsoft Bus	99		
Enable	Call	Sqz	Call	Microsoft Bus w/Paintbrush	99	Microsoft Serial	105		
Framework II	Call	Superkey	55	Optimouse w/Dr Halo	89	Optimouse w/DPE	185		
Smart System	429	Turbo Lightning	55	WORD PROCESSING					
Symphony	Call	XTree	35	Microsoft Word 4.0	195				
LANGUAGES		WORD PROCESSING		Multimate	Call				
Lattice C Compiler	242	Advantage II	Call	Advantage II	Call				
Microsoft C Compiler	Call	Volkswriter 3	139	Volkswriter 3	139				
Microsoft Fortran	Call	Webster Spellcheck	37	Webster Spellcheck	37				
		Word Perfect	195	Word Perfect	195				

TOLL-FREE ORDER LINE 1-800-421-3135

WAREHOUSE DATA PRODUCTS

2701 West Glendale Ave. • Phoenix, AZ 85051

We do not guarantee compatibility

-- STORE HOURS --

Monday, Wednesday & Thursday	9am-11pm EST	8am-10pm CST	7am-9pm MST	6am-8pm PST
Tuesday & Friday	9am-7pm EST	8am-6pm CST	7am-5pm MST	6am-4pm PST
Saturday	11am-7pm EST	10am-6pm CST	9am-5pm MST	8am-4pm PST

Expansion Chassis/Tape Back-up

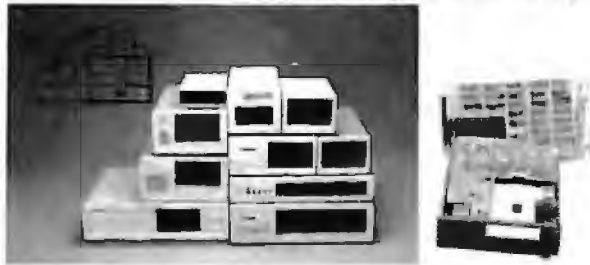

Specification

Model No.	No. of Slot	Space for Height Drive	Power Supply (Watts)	Dimension D X W X H (cm)	Price
M-1*	0	1	50	30 x 15 x 6.5	\$139
M-2	3	3	100	42 x 25 x 16	\$299
M-3	5	3	100	39 x 30 x 15	\$239
M-4	12	2	100	40 x 49 x 14	\$299
M-5	0	2	45	39 x 18 x 15	\$149
M-6	0	1	50	26.5 x 18 x 13.5	\$169
M-7	5	2	100	38.5 x 30 x 13.5	\$299
M-8	0	2	45	39.5 x 18 x 13.5	\$149
M-9	0	2	60	38.5 x 49 x 9	\$249
M-10	8	4	135	43 x 49 x 14	\$239

* Extra space for a stand alone controller

EXT and RCV Adapters (Interfacing Computer & Chassis With Slots) \$149

Tape Back-up (With Controller & Cable) \$499

ORDER TOLL FREE: (800) 826-0267
In California Call (408) 434-0877

SOURCE ELECTRONICS CORP.
2380 Qume Drive, Suite A
San Jose, CA 95131

Telex: 279366 Fax: (408) 434 0539

BOOK REVIEWS

these days of copyright cupidity, I'd prefer to have a definite statement one way or the other.

The code examples are set off by both typeface and color to good effect. As a rule, the typography is clean and uncluttered throughout the book. However, the tables are labeled inconsistently; many identical typographic structures face each other on opposite pages, one with a table designation and the other without.

Similarly, the information about MS-DOS control structures is diagramed in two apparently arbitrary formats. One structure might appear in a table that lists field length and usage, while another is consigned to a more visual series of stacked rectangles, with descriptions inside.

The cross-references to other articles are sometimes awkward. Whereas references to an appendix title include the letter designation, references to articles don't carry the corresponding article number, so the page headings (which appear on odd pages and which carry both the number and title) are less helpful than they could be.

Do You Need It?

Why publish so extensive a work about MS-DOS now, on the verge of OS/2 ascendancy? Perhaps Microsoft thought that MS-DOS is now mature enough that *The MS-DOS Encyclopedia* won't soon go out of date. The preface claims 10 million copies of MS-DOS are working now. Does this book belong next to all of those systems? Emphatically not! The book's general editor, Ray Duncan, tags the book's audience as "the community of working programmers," but I have to wonder how many programmers are currently engaged in new MS-DOS application development with OS/2 just around the corner.

Is this book for you? Look at your shelf of software and manuals. Do you have a version of an 8086 assembler there? If so, you may be able to use this book. Doubly so if that assembler is dusty. I bet the examples and lucid explanations here will catalyze you to use both the book and your assembler to overcome your previous frustrations with the quirks and mores of the world's most popular operating system.

Bill Bourn is moderator of the ms.dos conference on BIX and president of the Central Connecticut PC User's Group. You can reach him at P.O. Box 964, Glastonbury, CT 06033, or on BIX as "billbourn."

IBM PERSONAL SYSTEM/2 AND PERSONAL COMPUTER BIOS INTERFACE TECHNICAL REFERENCE

Reviewed by Ben Myers

IBM Corp., Racine, WI: 1987, Publication 68X2260, Form S68X-2260, 214 pages, \$75

For some time now, when I've had to refer to some detail about an IBM PC BIOS, I've found myself looking at several sources, none of them complete. Peter Norton's *Programmer's Guide to the IBM PC* has become somewhat dated by the author's original vision to produce a work that emphasized the IBM PC and PC XT, then predominant. Norton's book contains sketchy information about the EGA specification and few specifics about the AT BIOS. Until the PS/2 computers came along, Ray Duncan's *Advanced MS-DOS* was a well-organized reference for some BIOS calls, but it curiously omitted most of the information about disk BIOS services, and it included nothing about the system services (interrupt 15H) on the AT. Finally, descriptions of BIOS calling sequences are embedded

continued

New! 80286 Based
Tandy 1000 TX



CALL!
For Major Savings

SAVE \$360 OR MORE

SAVE 20-40%
OFF LIST ON ALL TANDY AND RS EQUIPMENT

- ✓ TANDY LAPTOP: Save \$400 or More!
- ✓ Save On STB, Zucker, And Other Non-TANDY Boards And Software!
- ✓ Save On All Radio Shack Products!

CALL FOR LATEST PRICES!

CALL TOLL FREE FOR ORDERS:
1-800-447-4225

FOR COLORADO RESIDENTS AND INFORMATION CALL (303) 249-9125

232 MAIN ST • MONROSE, CO 81401 • HOURS: 9-5 MST, M-F

TANDY
America's #1 Compatibles!

SALE!

TANDY 1000 SX
with Seagate
20 Meg. H.D.
\$999.00

1 MB Tandy 4000



SAVE \$1000 OR MORE

OS/2 ready Features 3 1/2 disk drive 80286 microprocessor and a use 16 MHz clock speed. 40K-500K memory per option. IBM-PC compatible. © 1987 Tandy Corp.

You will be pleased with our services, different service and with the knowledge that we WILL NOT be underpaid!







Keep your mainframe in touch: Send your remote PCs a card!

If a telephone line goes to wherever your remote PCs are, Sync-Up™ from UDS can now link them directly to your mainframe!

Sync-Up fits a complete synchronous modem and a protocol converter onto a single card; no other modules are required. Add appropriate UDS-supplied software, and you'll have a fast, reliable micro-to-mainframe link. If your system is already supporting 201C, 212A, 208A/B and/or 9600B modems, no modifications are required at the mainframe end.

Sync-Up boards may be specified with software to support 2780/3780 or 3270 BSC, and 3270, 3770 or 5251 SNA or a variety of other protocols. For complete technical data and quantity prices, contact Universal Data Systems, 5000 Bradford Dr., Huntsville, AL 35805. Telephone 205/721-8000; Telex 752602 UDS HTV.

 **Universal Data Systems**

 **MOTOROLA INC.**
Information Systems Group

The American Success Story Continues..



CLUB 286 (12MHz Zero Wait State) (16MHz Throughput) Mono System **\$1695**

- 12MHz Zero Wait State 80286 /• 16MHz Throughput /• Small Footprint Chassis /• Secured Hardware Reset /• 12" Monochrome Monitor (800x350) /• Hercules Compatible 132 Column Video Card
- Speaker On/Off /• Standard 1MB Memory /• Norton SI: 15.3
- Keyboard Selectable Between 8/12 and Zero/1 Wait State
- Plus Basic System Features /• Made in U.S.A.

12MHz EGA System **\$2065** 

Basic System Features:

- 80286 16-bit CPU /• 512K Motherboard Expandable to 1MB
- Clock Calendar with Battery Backup /• 195 Watt Power Supply 220/110V (UL, CSA) /• Fully Compatible AMI BIOS (Written in USA)
- 200 Page Documentation and User's Guide /• Limited One Year Warranty
- Optional Add Ons: 360KB Floppy Drives/ Enhanced Keyboard/ 720KB Floppy Drives 3 1/2"

ORDER BY MAIL: Check and Money Order. California add 7% Sales Tax.

ORDER BY PHONE: CC, Cashier Check, VISA (1%), American Express (4%) or Approved Company P.O.'s

Policy and Terms: All prices are subject to change and quantities may be limited and we reserve the right to substitute equivalent items. Unauthorized returns are subject to a 15% restocking fee. RMA numbers must be attached to all returned items and must be sent shipping prepaid by customer. The limited warranty is 1 year on parts and 6 months on labor.



CLUB 286 (10MHz Zero Wait State) (12MHz Throughput) Mono System **\$1529**

- 80286 10MHz Zero Wait State /• 8/10 Keyboard Switch
- 12" Monochrome Monitor (800x350) /• Hercules Compatible 132 Column Video Card /• Wait State Insertable Slots
- 12MHz Throughput /• 2 Serials, 1 Parallel Port Built In
- Norton SI:V(3.0) 11.5 /• Plus Basic System Features /• Made in U.S.A.

10MHz EGA System **\$1895**

286 System Options

20MB 65ms Half Height	\$280	80287-8	\$235
30MB 39ms Full Height	\$500	80287-10	\$310
44MB 28ms Full Height	\$575	Optical Mouse	\$99
72MB 23ms Full Height	\$920	Mechanical Mouse	\$69
71MB 28ms Full Height	\$870	14" Flatscreen Evervision Mono Monitor	CALL
130MB 18ms Full Height	\$1800		
NEC Multisync	CALL		

All 14" Evervision monitors shown above are optional.

NEC, Hercules, Evervision, OS-2, OS-3, Xenix, Unix, DBase III+ (Unix Framework, Sidekick, Symphony, PC Limited, Compaq, and Premium 286 are trademarks or registered trademarks of their respective companies.

And now, the most powerful line up of machines from the leading manufacturing, design and engineering company in America.....

Introducing the 13MHz Pulse

The CLUB 286 series of computers is ready for OS/2™ and OS/3™. The CLUB 286 Series will run Xenix, Unix, DBase III + , Lotus, Framework, BlackJack, Symphony and a host of all the popular software you can think of.

Call for our 386 Machine



CLUB 286 (8MHz 1 Wait State) 8MHz Monochrome System

- Includes Basic System /• 12" Monochrome Monitor (800x350) /• Hercules Compatible 132 Column Video Card /• Made in U.S.A.

Special Only
\$995

8MHz EGA System \$1399

CLUB Turbo 4.77/8.0MHz Monochrome System

\$699

- 8088-2 Keyboard Selectable /• 256K Standard /• 12" Monochrome Monitor (800x350) /• Hercules Compatible 132 Column Video Card
- 135 Watt Power Supply

4.77/8MHz EGA System \$1150 20MB System Add **\$300**

Model	Pulse-286	IBM	PC Limited	COMPAQ	Premier 286
Processor:	80286-12	80286-10	80286-12	80286-12	80286-10
Clock speed					
Wait States	0	1	0	1	0
Rating SI (2.0)	15.3	10.1	13.3	11.5	11.5

Mon - Fri	7:30 - 6:30 (West Coast)
Mon - Fri	10:30 - 9:30 (East Coast)
Saturday	10:30 - 3:00 (West Coast)
Saturday	1:30 - 6:00 (East Coast)

International sales desk now open
Corporate Buyer call for Corporate Desk
University P.O.'s are welcome
Dealers and Quantity Discounts are available

CLUB

American Technologies, Inc.

3401 W. Warren Ave., Fremont, CA 94539
FAX (415) 490-2687 (24 hrs.)

(415) 490-2201 Tech Suport (415) 683-6580

Introducing

Quaid Analyzer

the tool
that created
CopyWrite

Now you can debug your own programs with a professional quality debugger - the one that unraveled every form of copy-protection used on the PC.

With the Quaid Analyzer, you can:

- See occurrences of any interrupt, with its meaning shown on the screen.
- View memory as text or instructions, scrolling as easily as you do with an editor.
- Run until a memory location or I/O port is changed.
- Protect your hard disk from accidental destruction.
- Analyze software without the source, even when it uses countermeasures to thwart tracing.
- See all stages of the boot load.

We kept the Quaid Analyzer off the market to avoid helping publishers with copy-protection. Now that copy-protection is gone, we can sell it to you.

The Quaid Analyzer is a software tool occupying 100K bytes. It runs on any IBM PC and most MS-DOS systems without hardware modification.



Call (416) 961-8243

Quaid Analyzer \$99 U.S.

All orders shipped at our expense within a day. All major credit cards accepted.

or return coupon to 45 Charles St. East Third Floor, Dept. 605 Toronto, Ontario M4Y 1S2

Payment method MC-Visa-Amex-Diners-Check

Card No. _____

Expiry Date _____

Name _____

Address _____

City/State _____

Phone No. _____

Signature _____



Quaid Software Limited

Ask about Disk Explorer the program that takes over where Quaid Analyzer leaves off

within the assembly listings contained in the older PC and AT technical references published by IBM. All in all, this is a very haphazard collection of reference materials, but it was the best available until recently.

The *IBM Personal System/2 and Personal Computer BIOS Interface Technical Reference* gives the software developer a complete set of materials that describe how the various versions of the IBM PC BIOS work. IBM has not published assembly listings of the PS/2 BIOS; this reference documents the externally visible features of the BIOS as a programmer doing clean BIOS-level programming would see and use them.

The book covers the original IBM PC, PC XT, PC AT, PCjr, PC Convertible, and all announced models in the PS/2 product line. At \$75, the *BIOS Interface Technical Reference* seems pricey at first, but no other single document today can match it for completeness in treating its subject. It comes with a hard three-ring slipcase binder, like most other IBM reference publications. The typeface is a small but very readable Helvetica, so a lot of information is crammed into its 214 pages. There are few typographical errors.

The meat of the book is the section that has detailed descriptions of all calls to BIOS services. If different models of the PC do not respond identically, the book lists exact differences by PC model and relevant BIOS date. For example, the printer BIOS (17H) section has six notes describing the actions taken by various models of PCs. The pages covering video BIOS (10H) describe the three VGA modes, as well as the other video modes. The system services interrupt 15H receives extensive treatment, including the multitasking services that are used by other parts of BIOS on the PC AT, PC XT Model 286, and PS/2. If another interrupt uses system services to relinquish control while waiting for completion of an external event, this information is also noted. The BIOS services are arranged in order by interrupt number, then by major function designation passed in the AH register value within interrupt, so everything is quite easy to find. For the money, it would have been nice if IBM had thrown in half a dozen blank thumb-index tabs, beyond the two labeled "BIOS" and "Supplement." Then, I could have set up tabs to get quickly to the sections I use most often.

In the section on data areas and ROM tables, the BIOS data area, extended BIOS data area, and disk drive parameter tables are laid out, byte by byte and bit by bit. The last section of the book, entitled "Additional Information," describes interrupt sharing, adapter ROM, video function compatibility, multitasking provisions, system identification, application guidelines, and scan code/character code combinations. I found the information on video function compatibility particularly useful, because it told me, step by step, how to test which video functions are present. Using the procedure described, I can determine which video adapter—VGA, EGA, MCGA, CGA, or MDA—is present. The text also describes video mode-switching procedures. There is a vacant section for future supplements to be issued. The book has a standard glossary and index at the end.

If you are an experienced software developer designing software that must interface with any version of BIOS, the *IBM PS/2 and PC BIOS Interface Technical Reference* is one of a kind and indispensable. It is not for the novice PC programmer, however, because it is almost entirely bereft of examples. In the personal computer industry, where it is fashionable to take potshots at IBM, the company is often overlooked as a source for complete, well-organized materials describing its products and, by logical extension, compatible products.

Ben Myers has more than 25 years of varied experience in the computer industry. He can be reached at 73 Westcott Rd., Harvard, MA 01451.

continued

95% of the Top U.S. Companies Solve Their Complex Numeric Problems with APL ... Shouldn't You?



In businesses where complex numeric problems are a daily challenge, professionals from all walks of life rely on the APL★PLUS® System.

The APL★PLUS System

Thousands of professionals in a wide range of fields—investment research, insurance, corporate finance, engineering, and science—find the APL★PLUS System the perfect software for complex problem solving. That's because its natural mathematical orientation and conciseness of code provide the ideal environment for model building, array handling, system prototyping, and matrix manipulation. And for your connectivity needs, the APL★PLUS System runs on a

wide range of machines and operating environments.

Why not give yourself the analytical edge, for only \$695* Call 800-592-0050 and we'll show you how to put the APL★PLUS System to work in *your* specific application.

STSC

STSC, Inc.
2115 East Jefferson Street
Rockville, Maryland 20852
800-592-0050
301-984-5123 in Maryland or
Canada
Telex 898085

A PLUS★WARE® PRODUCT

The APL★PLUS System is available for the mainframe, IBM PC and compatibles, Macintosh, and machines running UNIX and VAX/VMS. The APL★PLUS System may be purchased through dealers and distributors worldwide.

APL★PLUS and PLUS★WARE are registered trademarks of STSC, Inc. UNIX, Macintosh, and IBM are registered trademarks of AT&T Bell Laboratories, Apple Computer, and International Business Machines Corporation, respectively.

Top companies according to the April 17, 1987 issue of *Business Week*

*U.S. suggested retail for DOS version. International prices slightly higher.

Circle 253 on Reader Service Card

APL is indispensable in developing mathematical models for pricing financial securities such as options, futures, and bonds. Complex mathematical algorithms are programmed quickly and concisely. And, empirical research is facilitated by APL's unmatched capabilities in manipulating and analyzing arrays of data.

Mark Schroder
Option Research Specialist
Prudential Bache

When you need to consider three classes of service, numerous fare types, and multiple connections, fare pricing analysis without APL is a Herculean task. APL's ability to manipulate tables of data with a single command enables us to explore a wider range of scenarios as fast as we can think of them.

Mike Flsher
Manager, Systems
Development
Pan American World Airways

Each quarter we consolidate and analyze historical data, current data, and forecasts from over 800 entities within GE and then quickly compile it into a comprehensive series of reports. With APL we get it done in a third of the time it would take us using other methods.

Eric Baelen
Manager, Business Systems
Development
General Electric Company

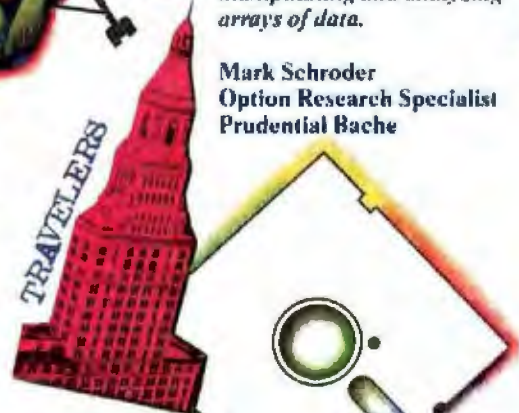
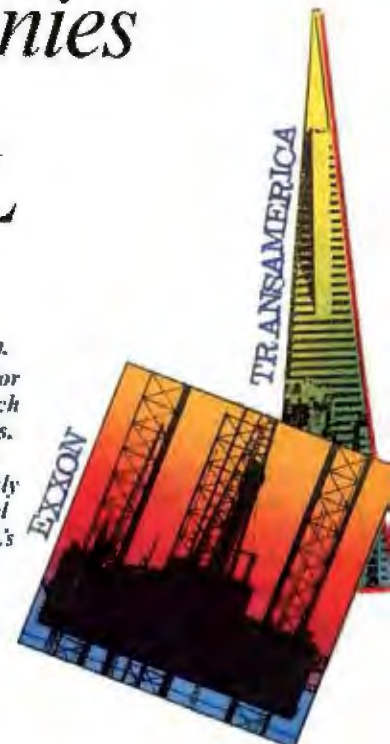

Convert .DXF files to Gerber® with SoftWest™ GPL.



Plot anything
you can draw
with SoftWest GPL,
the DXF-to-Gerber
conversion program.

It is bi-directional

(it also converts Gerber back
into AutoCAD®), and supports all
popular Gerber photoplotters, includin
the new laser plotters using Gerber pr.
Price in U.S.A.: \$500.00.

The Great SoftWestern Company®
is also the creator of Auto-Board
System®, SoftWest™ D2D, and
SoftWest™ PPI.

1-800-231-6880
INFORMATION & ORDERS
1-817-383-4434
TECHNICAL ASSISTANCE



The Original

AutoCAD is a registered trademark of Autodesk, Inc.

720K & 1.44MB
Drives Available
For DOS 2.1 & Up!

NOW!
2MB Model
Available



THE 3.5" CONNECTION!

This internal 720K 3.5" disk drive is a "drop-in" replacement for 5.25" drives! It's the ideal solution for exchanging data between your PC/XT/AT and the new generation of laptops. Disk format is compatible with IBM, Toshiba and Zenith portables. The Model 853W drive kit contains everything you need, including interface adapters, premium SONY drive, and complete documentation. Uses your existing disk controller (no additional slots required). Requires DOS 3.2 for maximum performance. Ask about our Model 873W (1.44MB).

\$\$ SAVE \$\$
SONY DISKS

Tigertronics
INCORPORATED

\$159.95
+ FRT. & TAX



400 Daily Lane
P.O. Box 5210
Grants Pass, OR 97527



WE'VE
MOVED!!

IMMEDIATE DELIVERY!
Call 503-474-6700 or 503-474-6701

BOOK REVIEWS

MEMORY RESIDENT PROGRAMMING ON THE IBM PC

Reviewed by Ben Myers

Addison-Wesley, Reading, MA: 1987, ISBN 0-201-18595-2,
413 pages, \$24.95

The subtitle of *Memory Resident Programming on the IBM PC* is "The Essential Guide to Developing Memory Resident Programs." The introductory chapters of the book cover programming in general, assembly language programming for the Intel 8088/8086 family, and writing an 8086 assembler program to display the interrupt vectors. Author Thomas Wadlow then defines a basic TSR program skeleton and provides several sample TSRs by way of explaining TSR writing. These include a keystroke expander, a clock, an instruction pointer (CS:IP) display, and TSR programs that display communications port values, set communications port parameters, list a directory, and browse through a file. The last four programs serve only as examples of TSR writing. Normal DOS programs would accomplish the same results with less effort.

Interrupts and Omissions

Unfortunately, Wadlow's book omits information that is necessary to write many important kinds of TSR programs. For example, if you have to read or write files while other programs are running, you need to know what to do to the current active PSP (program segment prefix) via DOS functions 50h and 51h. The interrupt multiplexer vector, interrupt 28h, is used to synchronize DOS operations among TSRs and other programs. Interrupt 22h (program termination), interrupt 23h (Control-C/Control-Break handler), and interrupt 24h (critical error handler) are essential to any well-written application, and doubly so for a TSR program. DOS treats functions 01h through 0Ch differently from the other function calls. None of these are explained in the book.

Similarly, if you write a TSR program that pops up on the screen, you need to be able to save and restore the screen area in which the pop-up occurs. That information is missing, as is any explanation of how a TSR program de-installs itself.

The concluding chapter, "The Roads Not Taken," is an often misleading explanation of TSR design trade-offs. Fully one-third of the book contains appendixes intended as reference material, though these, too, have some omissions. The first appendix, "IBM ROM BIOS Services," explains the BIOS calls for the IBM PC XT but excludes the ones for the IBM AT, EGA, VGA, MCGA, and PS/2. (Granted, omission of the last three is understandable, since they are fairly recent developments.) A "Hardware Interrupts" appendix covers only interrupts through 01Fh, and it includes some interrupts that are not for hardware, like the disk parameter table and high-order graphics table pointers. "IBM DOS Services" describes only the DOS functions for DOS 2.x, neglecting the DOS 3.x functions entirely. The final appendix, "Useful Books," gives a (very short) list of references used by the author in writing the book. These appendixes also have quite a few typos.

Useful, But Not Essential

The assembly language examples in *Memory Resident Programming on the IBM PC* are clear, and the accompanying explanations of programs are lucid and well written. If you want to get your feet wet writing simple TSRs, this book is an introduction to the subject, but you can find more complete examples of robust TSR programs elsewhere. The book does not meet its stated objective of being essential. You can write the bulletproof TSR programs that today's IBM PC marketplace demands without it. ■

Dot, Daisy and Laser.



The new family of Olympia printers with a prestigious technological heritage.

Olympia is first in making lasting impressions for a good reason. For over 80 years we've been a leading innovator in typing technology for the office. Now everything has changed. And nothing has changed. Our technology is as new as the dew. Our commitment to reliability, efficiency

and service is as solid as ever.

The Olympia dot matrix printers produce clean, crisp printing at speeds from 130 CPS to 240 CPS for a wide range of applications. And our daisy wheels are unsurpassed in printing quality.

Our new Laserstar 6 is compact, versatile, compatible and

offers the latest in desktop printing technology.

In short, whatever you need we've got. So don't go shopping without the big new name in printers on your list.

Olympia. We'll make a good impression on you.

Then for you.

OLYMPIA

The Competition

Advanced Engineering from Germany

Get acquainted with our family. And a gift for you: The fabulous Fisher Space Pen!

See all the Olympia models in our brochure "Printers That Make Quality Impressions." Along with our brochure we'll tell you how to get a Fisher Space Pen—free! The pen that went to the moon—from the finest

printers on earth. Call 1-800-999-6872 or send this coupon to: (USA) Olympia, P.O. Box 22, Dept. Adv., Somerville, N.J. 08876 (or Canada) Olympia, 58 Prince Andrew Place, Don Mills, Ontario, Canada M3C3A2

Mr Mrs Ms (Please Print)

Name First Last Title Phone

Company Address

City State Zip

Printer make(s) used now I plan to make a printer purchase in month/year

800 X 560

Twice the resolution of EGA
on your Multisync.

NEW

FROM THE
MANUFACTURER
OF THE
EGA WONDER



**Any
Software**

- 800x560 (1)
- 752x410 (1)
- 640x480 VGA (1)
- 640x350 EGA
- 320x200 CGA
- 720x350 MDA
- 720x350 Herc.
- 132 Columns

**Any
Monitor**

- MultiSync
- EGA Color
- RGB Color
- 25 kHz Color
- TTL Monochrome
- Composite Mono
- PC Portable
- Compaq Portable (2)
- Polaroid Palette

**Any
Time**

- Windows
- GEM
- AutoCAD
- 1-2-3
- Symphony
- PageMaker
- Ventura
- VTerm
- SmartTerm
- WordPerfect
- WordStar & more

EGAWONDER800™

Now available from all major computer stores
Call us Today at (416) 756-0711 for more information

ATI Technologies Inc
3761 Victoria Park Ave
Scarborough, Ontario, Canada
M1W 3S2
Tel. (416) 756-0711

Telex 06-9666-10
Fax (416) 756-0720



TECHNOLOGIES INC.

Technology you can Trust.

Circle 25 on Reader Service Card

(1) MultiSync monitors only. (2) Requires Optional Compaq Expansion Module

Trademarks: ATI, EGA WONDER — ATI Technologies Inc., IBM, VGA, EGA, CGA — International Business Machines Corp.,

Ventura — Xerox Corp., PageMaker — Aldus Corp., SmartTerm — PerSoft Inc., VTerm — Coefficient Systems Corp.,

Compaq — Compaq Computer Corp., MultiSync — NEC Home Electronics Corp., Windows — Microsoft Inc., GEM — Digital Research Inc.,

1-2-3, Symphony — Lotus Development Corp., AutoCAD — Autodesk Inc., WordPerfect — WordPerfect Inc., WordStar — MicroPro Inc., Polaroid — Polaroid Corp.



THE IMPROVED VGA

Extending across barriers of graphics incompatibilities, **ATI** introduces a VGA improved performance card - **VIP**. **VIP** delivers the IBM PS/2 VGA standard to IBM PC/XT/AT and Model/30 users, providing an upgrade path to the outstanding world of VGA graphics.

Totally compatible with the **ATI EGA WONDER**, users have the unique ability to display EGA, Color/Graphics and Hercules software on monochrome, RGB and EGA monitors.

- Compatible to IBM Video Graphics Array (VGA). All 17 modes.
- Runs EGA/CGA/Hercules & 132 column software on IBM PS/2 Analog¹, Multisync, EGA, RGB, TTL monochrome, PC Portable, Compaq Portable² monitors.
- Softsense automatic mode switching.
- Automatic analog monitor detection.
- High resolution 800 x 560 graphics for Multisync monitors with drivers supplied for Windows, Gem, Ventura, Autocad.



Call today at (416) 756-0711 for more information.

¹ 132 Columns not available on IBM PS/2 Analog Monitors

² Compaq via optional Compaq Expansion Module

Trademarks: IBM, PS/2, Model 30, VIDEO GRAPHICS ARRAY, VGA, EGA, CGA, VGA - International Business Machines Corp.; HERCULES - Hercules Computer Technologies Inc.; Multisync - NEC Home Electronics Corp.; COMPAQ - Compaq Computer Corp.; WINDOWS - Microsoft Inc.; GEM - Digital Research Inc.; VENTURA - Xerox Corp.; AUTOCAD - Autodesk Inc.



TECHNOLOGIES INC.

Technology you can Trust.

Circle 26 on Reader Service Card

ATI Technologies Inc. 3701 Victoria Park Ave. Scarborough, Ontario, Canada
M1W 1S2 Tel: (416) 756-0711 Telex: 06-960680 Fax: (416) 756-0720

Safety in Numbers



2
year warranty

100+
G shock rating

30,000+
hours, MTBF

Reliability. The attribute that has made Silicon Valley Computer the world's leading manufacturer of ruggedized IBM™ compatible equipment. Reliability proven by the successful installation of thousands of disk and tape systems monthly. Superior engineering and meticulous care in manufacturing and testing have been the foundation of this reliability since 1982.

We offer a full selection of ruggedized hard-disk cards and high-quality commercial-grade disk-drive kits ranging in capacity from 21 to 512 megabytes. Also available are tape subsystems, 8- and 16-bit SCSI/ESDI/MFM/RLL disk controllers, Token Ring Ethernet controllers (Novell compatible), 3.5-inch floppies, 360 KB, 720 KB, 1200 KB, and 1440 KB floppies.

Tens of thousands of units are currently being used by the U.S. Navy, NASA, Pentagon R&D, major banking institutions, and numerous small businesses. All products meet or exceed stringent performance criteria. SVC established these standards to satisfy the needs of our growing list of sophisticated customers.

Compatibility.

Silicon Valley Computer drives have been interfaced with most IBM PC, XT, XT286, ATs and compatibles. Over 50 clones have been tested as 100% compatible with our drives using IBM PC-DOS 3.1/3.2/3.3.

We are also the first company in the industry to supply hard disk add-on units for the new IBM Personal System 2 Model 30, Model 60, and Model 80 machines.

Service.

Quality customer service is as important to us as the quality of our product. Ninety percent of all orders are shipped within 24 hours of receipt. Each order is accompanied by complete documentation, software, cables and mounting hardware. All products are available with our industry-leading two-year swap-out warranty. When you want the best product, service and reliability, at very competitive prices, call Silicon Valley Computer.



SILICON VALLEY
COMPUTER

140 Archer Street, San Jose, California 95112 • 408 288-8837
TELEX 821299 SILICON VLY • FAX 408-947-1353

Circle 242 on Reader Service Card

The Gold Card (hard-disk-card)

Silicon Valley Computer has the widest selection available.

RUGGEDIZED

21R MB 80G shock • 65 ms w/auto head lifters • 30,000 hr MTBF (MFM)
32R 80G shock • 65 ms w/auto head lifters • 30,000 hr MTBF (RLL)
40R 100G shock • 29 ms w/auto head lifters • 30,000 hr MTBF (SCSI)
40AT 100G shock • 26 ms/hd lifters • 100% AT compatible • 30,000 hr MTBF

SILENT RUNNING

21L MB 65 ms • Oxide media • 5,000,000 BPS • 10 W, 30,000 hr MTBF (MFM)
21F 65 ms • Plated media • 30 dB • 5,000,000 BPS • 25,000 hr MTBF (MFM)
32F 65 ms • Plated media • 30 dB • 7,500,000 BPS • 25,000 hr MTBF (RLL)
50F 62 ms • Plated media • 30 dB • 7,500,000 BPS • 25,000 hr MTBF (RLL)

Hard-Disk PC Kits (half height)

21L MB 65 ms • Oxide media • 5,000,000 BPS • 10 W • 28,000 hr MTRF (MFM)
32F 65 ms • 30 dB • Plated media • 7,500,000 BPS • 20,000 hr MTBF (RLL)
40R 29 ms • Plated media • 8,000,000 BPS • 10 W • 30,000 hr MTBF (SCSI)
40 26 ms • World's fastest 40 MB drive • 30,000 hr MTBF (MFM)
50F 62 ms • 30 dB • Plated media • 7,500,000 BPS • 20,000 hr MTBF (RLL)

Hard-Disk PC Kits (full height)

30 MB 40 ms • 30,000 hr MTBF • 5,000,000 BPS (MFM)
72 26 ms • 30,000 hr MTBF • 5,000,000 BPS (MFM)
120 28 ms • 30,000 hr MTBF • Novell compatible (MFM)
150 28 ms • 30,000 hr MTBF • 10,000,000 BPS (SCSI/ESDI)
234 28 ms • 30,000 hr MTBF • 7,500,000 BPS (SCSI)
317 28 ms • 30,000 hr MTBF • 10,000,000 BPS (SCSI/ESDI)
800 100 ms • Removable WORM • Optical/laser (SCSI)

IBM Compatible Devices

60 MB Tape systems • Internal mounting, half-height DC 600 A cartridge
60 MB Tape systems • External mounting power cabinet included
40 MB Tape systems • Floppy interface DC2000 cartridge
Token Ring compatible Ethernet boards • 10 MBPS
SCSI Hard-disk tape controller • 8/16-bit switchable w/floppy
MFM Hard-disk controller • 8/16-bit • 2 W • 2K buffer
RLL Hard-disk controller • 8/16-bit • 2 W • 2K buffer
ESDI Hard-disk/floppy/MFM controller • 8/16-bit • 10 MBPS

IBM is a registered trademark of International Business Machines Corp

PRICES TOO LOW TO ADVERTISE!
(Volume users/resellers, call 408 288-8838.)

Products in Perspective

- 67 **What's New**
- 89 **Short Takes**
SideKick Plus
Manuscript 2.0
Friendly Finder
Focal Point
PC WeatherPro
Tech*Graph*Pad 2.1
- Reviews**
- 102 Enhanced EGA and VGA Boards
- 115 The Zenith Z-386
- 121 NEC PowerMate 2
and HP Vectra ES/12
- 127 The Tandy 1400 LT
- 134 Macintosh II Color Monitors
- 139 Mac SE Accelerator Boards
- 145 Trilogy Programming Language
- 155 Excel Extraordinaire
- 157 Microsoft Works
- 162 Reflex Plus for the Macintosh
- 169 **Computing at Chaos Manor**
by Jerry Pournelle
- 187 **Applications Only**
by Ezra Shapiro



IT'S TIME TO DO SOME SERIOUS 386 BUGBUSTING!



PROBE's menu bar and pull-down menus set a new standard for debugger interfaces.

PROBE has source-level debugging to let you "C" your program.

POP registers up and down with a single key.

This is an out-of-range memory-overwrite bug. Since it is interrupt related, it only appears in real time.

Welcome to your nightmare. Your company has bet the farm on your product. Your demonstration wowed the operating committee, and beta shipments were out on time. Then wham!

All your beta customers seemed to call on the same day. "Your software is doing some really bizarre things," they say. Your credibility is at stake. Your profits are at stake. Your sanity is at stake.

THIS BUG'S FOR YOU

You rack your brain, trying to figure something out. Is it a random memory overwrite? Or worse, an overwrite to a stack-based local variable? Is it sequence dependent? Or worse, randomly caused by interrupts? Overwritten code? Undocumented "features" in the software you're linking to? And to top it off, your program is too big. The software debugger, your program and its symbol table can't fit into memory at the same time. Opening a bicycle shop suddenly isn't such a bad idea.

THIS DEBUGGER'S FOR YOU

Announcing the 386 PROBE™ Bugbuster,* from Atron. Nine of the top-ten software developers sleep better at night because of Atron hardware-assisted debuggers. Because they can set real-time breakpoints which instantly detect memory reads and writes.

Now, with the 386 PROBE, you have the capability to set a *qualified breakpoint*, so the breakpoint triggers only if the events are coming from the wrong procedures. So you don't have to be halted by breakpoints from legitimate areas. You can even detect obscure, sequence-dependent problems by stopping a breakpoint only after a specific chain of events has occurred in a specific order.

Then, so you can look at the cause of the problem, the 386 PROBE automatically stores the last 2K cycles of program execution. Although other debuggers may *try* to do the same thing, Atron is the only company in the world to dequeue the pipelined trace data so you can easily understand it.

Finally, 386 PROBE's megabyte of hidden, write-protected memory stores your symbol table and debugger. So your bug can't roach the debugger. And so you have room enough to debug a really big program.

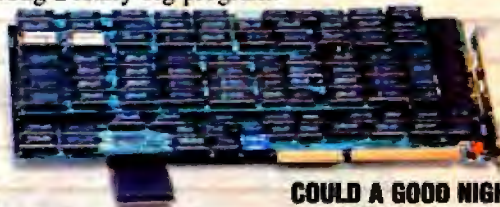

COULD A GOOD NIGHT'S SLEEP PUT YOU IN THE TOP TEN?

Look at it this way. Nine of the top-ten software products in any given category were created by Atron customers. Maybe their *edge* is — a good night's sleep.

Call and get your free, 56-page bugbusting bible today. And if you're in the middle of a nightmare right now, give us a purchase order number. We'll FEDEX you a sweet dream.



atron
BUGBUSTERS

A division of Northwest Instrument Systems, Inc.
Saratoga Office Center • 12950 Saratoga Avenue
Saratoga, CA 95070 • Call 408/253-5933 today.

*Versions for COMPAQ, PS/2-80s and compatibles. Copyright © 1987 by Atron. 386 PROBE is a trademark of Atron. Call 44-2-855-888 in the UK and 49-8-985-8020 in West Germany.

WHAT'S NEW

SYSTEMS

A Loaded 68020 System

Designed and built in England, the Omega is a full-featured 68020-based workstation that includes a 68881 math coprocessor and 1 megabyte of zero-wait-state nonvolatile static RAM. Also included is the OS9/68K real-time, multitasking operating system from Microware Systems.

With a processor running at 12.5 MHz, other standard features of the Omega include a fully buffered 16-bit data bus with 24 address lines, a 25.5-megabyte hard disk drive, a 1.2-megabyte floppy disk drive, four RS-232C serial ports, a parallel printer port, a bidirectional high-speed 16-bit parallel interface, and an RS-485 network node.

Hardware options for the Omega include higher clock speeds of 16.67, 20, or 25 MHz. There's also a 640- by 480-pixel by 16-color display controller, a 1- or 4-megabyte memory-expansion board, an intelligent network node controller, a prototyping board, an EPROM programmer, a 100-megabyte hard disk drive, and a tape backup unit. On the software side, there's a variety of language compilers, an applications generator, a cross assembler and debuggers, and several business applications.

Price: 12.5-MHz version, \$4750; 16.67-MHz version, \$4950; 20-MHz version, \$5495; 25-MHz version, \$6895.

Contact: Lloyd I/O Inc., Omega Sales Dept., 19535 Northeast Glisan St., P.O. Box 30945, Portland, OR 97230, (800) 227-3719. **Inquiry 754.**



The Omega is a feature-packed system from England.

NEC's Desktop-Publishing System

If you have an urge to get into desktop publishing but feel constrained by your current display and controller, you can add NEC's MonoGraph System to your IBM PC or compatible and be ready to roll. A complete full-page display system, the MonoGraph System has a square-screen monitor; a controller board for the monitor's 1024- by 1024-pixel maximum resolution; a cable to connect the two; and driver, font, and diagnostic software.

The system's square-screen analog monitor has a

16-inch CRT with 100-dot-per-inch dot density, an aspect ratio of 1 to 1, and a flicker-free display. The monitor measures 14 by 14 by 17 inches and includes a tilt-and-swivel base.

The video-controller board requires a full-length 8-bit slot and features an Intel 82786 graphics processor running at 10 MHz. It has a CGA emulator that displays CGA-compatible software in double-scan mode, with twice the standard resolution and double the pixels per dot.

On the software side, the MonoGraph System comes with 15 fonts for both Aldus PageMaker and Ventura Pub-

lisher. Software drivers for Microsoft Windows and Ventura Publisher are also included, as is a full set of diagnostics.

Price: \$1999.

Contact: NEC Home Electronics (U.S.A.) Inc., 1255 Michael Dr., Wood Dale, IL 60191, (312) 860-9500. **Inquiry 755.**

Upgrade Your Zenith

A new upgrade kit from Zenith Data Systems (ZDS) lets you upgrade any Zenith Z-248 PC- or AT-compatible system to a 16-MHz, zero-wait-state, 80386-based computer with a 32-bit bus.

The ZDS SuperSet upgrade kit contains three 32-bit system boards (I/O, 1 megabyte of RAM, and the 80386 CPU board). ZDS claims it takes less than 30 minutes to install and that it works with any Z-248 system, including those supplied to the U.S. Department of Defense.

After you install the SuperSet upgrade, your system will become a Z-386 with five open bus slots, 1 megabyte of RAM (expandable to 16 megabytes), serial and parallel ports, and sockets for both 80287 and 80387 coprocessors. The Z-386 will support dual hard disk drives, dual floppy disk drives, and a tape backup unit.

Price: \$2699.

Contact: Zenith Data Systems, 1000 Milwaukee Ave., Glenview, IL 60025, (800) 842-9000, ext. 1. **Inquiry 756.**

continued

SEND US YOUR NEW PRODUCT RELEASE

We'd like to consider your product for publication. Send us full information, including its price, ship date, and an address and telephone number where readers can get further information. Send to New Products Editor, BYTE, One Phoenix Mill Lane, Peterborough, NH 03458. Information contained in these items is based on manufacturers' written statements and/or telephone interviews with BYTE reporters. BYTE has not formally reviewed each product mentioned.

PERIPHERALS

Laser-Quality Printing for Under \$1000

Using drop-on-demand thermal ink-jet printing technology, Hewlett-Packard claims its new HP DeskJet printer gives laser-printer-quality output at a significantly lower price. The DeskJet prints high-resolution text in multiple fonts and full-page graphics, all at 300 by 300 dots per inch. There's also a draft mode that prints at a resolution of 300 by 150 dpi. It prints standard letter-quality text at 120 characters per second, and draft quality at 240 cps.

The DeskJet has an automatic cut-sheet feeder that holds up to 100 sheets and has Courier, Courier Bold, and Courier Compressed fonts built in. There are two accessory-cartridge ports that let you add additional fonts, expand the memory (up to 256K bytes), and provide Epson FX-80 printer emulation.

Because the DeskJet uses HP's own PCL printer language, it's compatible with most software packages that support the HP LaserJet printer. The unit comes with both parallel ports and a 16K-byte printer buffer. It measures 17.3 by 8 by 14.8 inches and weighs 14.3 pounds.

Price: \$995.

Contact: Inquiries Manager, Hewlett-Packard, 1820 Embarcadero Rd., Palo Alto, CA 94303, or call the Hewlett-Packard Company sales office listed in your telephone directory's white pages. **Inquiry 757.**



The Hewlett-Packard DeskJet prints laser quality for less.

POSTSCRIPT-COMPATIBLE LASER PRINTER

According to QMS, its QMS-PS 810 laser printer is the first Canon SX-engine-based laser printer that supports Adobe's PostScript page-description language.

The printer's built-in controller includes 2 megabytes of RAM (expandable to 3 megabytes) and 1 megabyte of ROM, and is built around

a 68000 processor running at 16 MHz. The controller supports the 35 standard Adobe PostScript typefaces and also emulates the HP LaserJet Plus, HP 7475A plotter, and the Diablo 630.

The QMS-PS 810 outputs final copy at 8 pages per minute with 300-by-300-dpi resolution. It has a duty cycle of 5000 copies per

month and a toner cartridge life of 4000 copies. There are two output trays: one for face-up copies; one for face-down. RS-232C, RS-422/AppleTalk, and parallel interfaces are standard.

Price: \$5495.

Contact: QMS Inc., One Magnum Pass, Mobile, AL 36618. (205) 633-4300. **Inquiry 762.**

An Ocular Mouse for the New Macs

If your new Mac's standard mechanical mouse is wearing out or wearing you out, MSC Technologies (formerly Mouse Systems) is offering an alternative. The A+ Mouse ADB optical mouse is fully compatible with the Macintosh II and Macintosh SE, as well as the Apple II GS.

The mouse's LED reflects off a special grid pad and is read by an optical sensor. It then converts the grid-line count to movement on your screen.

According to the company, an optical mouse avoids the problems of slippage, wear, and dirt that can eventually cause problems with mechanical mice. At the same time it introduced the new mouse, MSC also dropped the price of its optical mouse for other models of the Apple from \$119 to \$99. All models come with a lifetime warranty.

Price: \$129.

Contact: MSC Technologies

Inc., 2600 San Tomas Expressway, Santa Clara, CA 95051, (408) 988-0211.

Inquiry 802.

A Duo of Drives for the PS/2

The comparatively high price and lack of availability of 5¼-inch drives for the IBM PS/2 has encouraged manufacturers other than Big Blue to enter the fray. Here are two.

The PRS-2 from Pacific Rim Systems is a 5¼-inch floppy disk drive that attaches directly to the drive B connector on the IBM PS/2 Models 30, 50, 60, and 80. It weighs a mere 3½ pounds and consumes just 4 watts of power without having to use any external AC connections. The company claims you can install the PRS-2 in about 5 minutes, and says the unit's rated time before failure is 11,000 hours.

Price: \$300.

Contact: Pacific Rim Systems Inc., 2570 Barrington Court, Hayward, CA 94545, (415) 782-1013.

Inquiry 759.

Meanwhile, the XD-360 is SMT's version of the 5¼-inch external drive for the entire IBM PS/2 family. The company says the unit's footprint is half the size of the

IBM drive. To install the XD-360, you insert the unit's cable into your PS/2's drive B connector. You then route the cable internally to the rear panel and insert it into an available slot.

Price: \$325.

Contact: Systems Manufacturing Technology Inc., 1145 Linda Vista Dr., San Marcos, CA 92069, (619) 744-3590. **Inquiry 760.**

Micro Channel Modem

If you own an IBM PS/2 Model 50, 60, or 80, you can now telecommunicate at 2400 bps with an internal modem for the Micro Channel bus. The Ven-Tel 24/2 internal modem comes with a configuration file that automatically sets it up for PS/2 operation. You don't need to set any option switches, and it supports communications ports 1 through 8.

Ven-Tel says the 24/2 is fully compatible with the AT command set and includes automatic fallback to 1200 or 300 bps, as well as extensive self-test capabilities. It has a jack for an external telephone, is covered by a 5-year warranty, and is available with Crosstalk XVI software.

Price: \$549.

Contact: Ven-Tel Inc., 2121 Zanker Rd., San Jose, CA 95131-2177, (800) 538-5121; in California, (408) 436-7400. **Inquiry 761.**

continued

For problems involving engineering calculations or scientific analysis, the answer is MathCAD.[®]

Transporting an iceberg to Southern California is a formidable task. Calculating the variables is just as demanding. How many tugboats would be needed to tow the ice mass? At what cost? How much fresh water would be lost?

Innovative solutions require extraordinary tools. For problems involving calculations or what-if analysis, the answer is MathCAD.

MathCAD is the only PC-based software package specifically designed to give technical professionals the freedom to follow their own scientific intuition.

Requires IBM[®] PC or compatible

You decide how to solve the problem – MathCAD does the "grunt work."

- Ends programming and debugging.
- Recalculates as variables change.
- Generates quick plots.

Easy to learn and use, MathCAD operates interactively in standard math notation. And its built-in functions provide all the power you need to solve real-world problems. MathCAD handles matrix operations, solves simultaneous equations, works with real and complex numbers, does automatic unit conversion, displays Greek characters and

other math symbols, performs FFTs and much more.

There's never been a better way to get fast, accurate solutions to analytical problems. That's why 20,000 engineers and researchers are using MathCAD daily in applications as diverse as fluid mechanics, signal processing and molecular modeling.

To find out what MathCAD can do for you, call us today for a **free demo disk: 1-800-MathCAD** (in MA, 617-577-1017). Or write to MathSoft, Inc., One Kendall Square, Cambridge, MA 02139.

MathSoft
 $\Sigma + \sqrt{-} = \times f \div 8$
Software Tools for Calculating Minds

HOW MANY GLASSES OF WATER

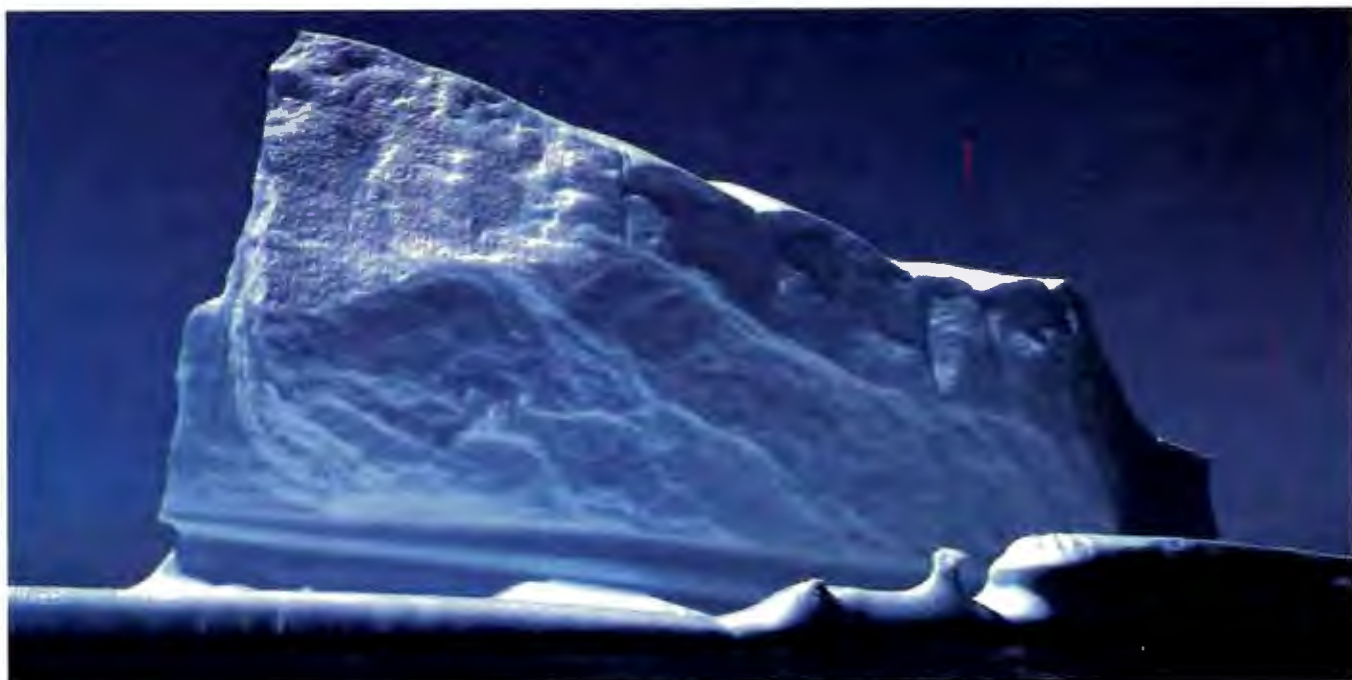

IBM[®] International Business Machines Corporation MathCAD[®] MathSoft, Inc. © Copyright MathSoft, Inc. 1988.

CAN THIS ICEBERG SUPPLY TO L.A.?

PERIPHERALS



Numerikeys gives your portable computer a numeric keypad.

Numbers for Your Portable

Portable or desktop computers without dedicated numeric keypads can be a real pain if you need to enter large amounts of numeric data into your programs. Numerikeys, an auxiliary numeric keypad from Genest Technologies, solves the problem by connecting between your computer's parallel printer port and printer cable.

Numerikeys has all the keys you need for most spreadsheet applications, including separate numeric, cursor-control, symbol, and function keys. The unit doesn't interfere with your parallel port, and it works full-time, even while your computer is printing. **Price:** \$129.

Contact: Genest Technologies Inc., 1331 East Edinger Ave., Santa Ana, CA 92705, (800) 826-9641; in California, (714) 547-0880. **Inquiry 763.**

Touch Your Keyboard

Honeywell's new TCE434 Series Touch Panel Keyboard is a flat-panel unit that's sealed so it's completely protected in environments

where dust, grime, moisture, or liquid spills could create problems.

The 84-key keyboard uses membrane switches with metal snap disks and an embossed touch surface for tactile feedback. It's compatible with the IBM PC, AT, and compatibles, and automatically selects the correct interface.

The TCE434 includes its own dedicated 8-bit processor, ROM, RAM, I/O lines, timer/event counter, and electronic shift. To keep the throughput moving, the electronics include a 16-character FIFO buffer. **Price:** \$275.

Contact: Honeywell Inc., Keyboard Division, 4171 North Mesa St., Building D, El Paso, TX 79902, (915) 543-5503. **Inquiry 764.**

Run PC Bus Card with the Micro Channel

A product called the TransFormer 2 is a converter board that lets you connect PC bus add-in cards into IBM's Micro Channel bus in PS/2 Models 50, 60, and 80. The board plugs into your PS/2, and you connect it via cable to your PC expansion bus.

The TransFormer 2 package includes the TransFormer board, a cable, and the ADC XI Card, a PC expansion interface board. You can also use the unit with Advanced Digital Communication's current bus expansion box. The company says you can also use it with all ADC Personal Network software, including Novell NetWare, and that it will be compatible with OS/2. **Price:** \$695.

Contact: Advanced Digital Corp., 5432 Production Dr., Huntington Beach, CA 92649, (714) 891-4004. **Inquiry 765.**

Shades of Gray For Your Mac II

If you're using your Macintosh II for desktop publishing or other applications that require photo-realistic black-and-white images, the Viking Analog gray-scale monochrome monitor from Monitorm may be your ticket.

The 19-inch monitor uses square pixels that let it precisely match screen and laser-printed output at a screen reso-

lution of 72 dpi. It comes with a controller that plugs into the Mac II's NuBus slot. A PC-compatible controller is also available.

Price: \$2695.

Contact: Monitorm Corp., 5740 Green Circle Dr., Minnetonka, MN 55343, (612) 935-4151. **Inquiry 766.**

A Hard Drive for the Amiga 500

Supra Corp., which has been making hard disk systems for Amigas since their introduction, now has a version of its SupraDrive hard disk system for the newest Amiga—the 500.

The SupraDrives are available in capacities of 20, 30, 60, and 250 megabytes, and are ready to be plugged in and used immediately. The drives plug into the Amiga 500's expansion connector and use Supra's own proprietary interface for high-speed data transfer. The data channel is capable of burst data transfers of over 250K bytes per second.

Each SupraDrive has an SCSI expansion port, and you can add plug-in RAM modules with either 1- or 2-megabyte capacities. Both the hard disk drives and any expansion RAM are powered by SupraDrive's internal power supply. **Price:** \$995 to \$3995.

Contact: Supra Corp., 1133 Commercial Way, Albany, OR 97321, (503) 967-9075. **Inquiry 767.**

continued

ECONOMICAL PORTABLE MODEM

Tiny transportable modems have recently become popular, but with an often considerable price difference over conventional modems. Now Delta Gold Computer Corp. has, at this writing, the lowest-cost full-featured portable modem.

The DM-1200 is a 300-/1200-bps Hayes-compatible

modem that measures 2¹/₂ by 1 by 3¹/₂ inches—about the size of a pack of cigarettes—and weighs just eight ounces. The modem has 28 characters of nonvolatile configurable memory, remote ring, tone sensing, busy- and dial-tone monitoring, and a low-battery light. You can power the DM-

1200 off a 9-volt battery, an automobile lighter adapter, or standard AC power.

Price: \$99.

Contact: Delta Gold Computer Corp., 260 Forbes Blvd., P.O. Box 809, Mansfield, MA 02048, (800) 255-3358; in Massachusetts, (617) 339-5575.

Inquiry 768.

New! Introducing Turbo C 1.5— the best optimizing compiler gets even better!

*The professional
optimizing compiler
for less than \$100*

Turbo C* is a technically superior production-quality compiler. (Borland's equation solver, Eureka™, is written in Turbo C.) And our Turbo C 1.5 offers a new library of the highest presentation-quality graphics in the industry—the kind you'll see in Quattro.™ our new professional spreadsheet.

And spectacular graphics are just part of the brand-new features. Turbo C 1.5 enhancements also include:

- A professional-quality graphics library of over 70 functions
- A librarian that allows you to build your own object module libraries
- Context-sensitive help for the language and the library routines



Actual photograph of Turbo C graphics displayed on IBM 8514 screen.*

- Text/video functions, including windows
- 43- and 50-line mode support
- VGA, CGA, EGA, Hercules, and IBM 8514 support
- File search utility (GREP)

- Sample graphics applications
- More than 100 new functions

For professional-quality C at an affordable price, no one else comes close to Turbo C. Because no one can deliver technical superiority like Borland.

60-Day Money-back Guarantee**

For the dealer nearest
you or to order, call
(800) 543-7543



Circle 42 on Reader Service Card
(DEALERS: 43)

Minimum system requirements: For the IBM PS/2™ and the IBM® and Compaq® families of personal computers and all 100% compatibles. PC DOS (MS-DOS™) 2.0 or later. 384K.

*Aircraft visible courtesy of Geographics Corporation.

**Customer satisfaction is our main concern; if within 60 days of purchase this product does not perform in accordance with our claims, call our customer service department, and we will arrange a refund.

All Borland products are trademarks or registered trademarks of Borland International, Inc. Other brand and product names are trademarks or registered trademarks of their respective owners. Copyright © 1987 Borland International, Inc.

111658

It's easy to upgrade to Turbo C 1.5!

Just complete this coupon and mail it with payment before June 30, 1988. Or, call us at (800) 543-7543 and be ready to give our operators your name, credit card number, and the serial number on your Turbo C master disk.

Turbo C 1.5 Upgrade Price **\$ 33.50**

CA and MA residents add sales tax _____

Shipping and handling _____

In US \$5.00 (Outside US add \$10)

Total amount enclosed **\$ _____**

Must include your Turbo C serial # _____

Return this coupon and the Turbo C RTL source code registration form from your Turbo C manual along with your payment by March 31, 1988 and receive your Turbo C 1.5 upgrade for free! (No phone orders please.)

**Turbo C 1.5 Runtime Library
Source Code** **\$ 150.00**

CA & MA residents add sales tax _____

Price includes shipping to all US cities.
(Outside US add \$10)

Total amount enclosed **\$ _____**

Please specify diskette size 5 1/4" 3 1/2"

Method of Payment VISA MC Check Bank Draft

Credit card expiration date _____ / _____

Card # _____

Name _____

Ship Address _____

City _____ State _____

Zip _____ Phone (____) _____

Mail coupon to: Turbo C 1.5 Upgrade Dept., Borland International
4585 Scotts Valley Drive, Scotts Valley, CA 95066

This offer is limited to one upgrade per valid product serial number. Not good with any other offer from Borland. Outside US make payments by bank draft payable in US dollars drawn on a US bank. CODs and purchase orders will not be accepted by Borland.

BORLAND

A D D - I N S



Capture color for real-time processing with the DT2871.

Process Color Images in Real Time

The DT2871 from Data Translation is a PC AT-compatible plug-in board that captures color images from standard video sources for image processing. In addition to handling real-time color capture and display, the DT2871 performs real-time conversions between RGB and hue-saturation-intensity (HSI) images. According to the company, HSI representations are preferable to RGB because they allow high-speed image processing of color images.

Examples of hue-saturation processing made possible by the DT2871 are color identification, edge enhancement, desaturation/saturation, colorimetric analysis, automatic coloring of monochrome images, object definition, tinting, retouch, and other special effects. Intensity-processing capabilities include noise reduction, arithmetic and logic operations, frequency-domain analysis, and compression/decompression.

The DT2871 handles 30 frames per second at 512- by 512-pixel resolution with over 16 million displayable

colors. You can connect it directly to other Data Translation boards, such as the DT2858 Auxiliary Frame Processor or DT7020 Floating Point Array Processor, to speed up computation-intensive operations.

The DT2871 has 1 megabyte of frame store memory—enough to store a single color image in three 256K-byte buffers; the fourth 256K-byte buffer supports overlaying of text and graphics on color images.

Data Translation also provides a software library package called Aurora for control-

ling the DT2871. The library is callable from Microsoft Pascal, C, and FORTRAN.

Price: \$2995; Aurora software, \$995.

Contact: Data Translation Inc., 100 Locke Dr., Marlborough, MA 01752, (617) 481-3700.

Inquiry 769.

Supercharge Your Printers

The Printer Performance Card is an intelligent printer interface that fits into any IBM PC or compatible and lets up to three computers share up to seven printers. The card also has its own 256K-byte internal buffer (expandable to 512K bytes) that can store and feed documents to printers while freeing up the computers.

Equipped with its own dedicated microprocessor, the Printer Performance Card has six standard parallel and two RS-232C serial ports.

You can use the card in a network server, and it's shipped with memory-resident software that lets you pick the printer you want to use from a pop-up menu.

Price: \$399.

Contact: Dresselhaus Computer Products, 8560 Vineyard Ave., Suite 405, Rancho Cucamonga, CA 91730, (800) 368-7737.

Inquiry 770.

Tape Interface for the AT

You can use industry-standard 9-track computer tape drives with your IBM PC, AT, or compatible with Catamount's interface cards. The cards are available in two different models: one for the IBM PC or compatible, the other for the IBM AT or compatible.

For the PC, The ATC-8 is an 8-bit FIFO interface on a half-slot card. For the AT, the ATC-16 is a full-length card with 16-bit I/O and 128K-byte buffering.

Price: ATC-8, \$1095; ATC-16, \$1295.

Contact: Catamount Corp., 2243 Agate Court, Simi Valley, CA 93065-1898, (805) 584-2233.

Inquiry 771.

Digital Sound From Your PC

Using the VP620E add-in board in your IBM PC or compatible, you can convert any audio signal in the 20-Hz to 7-kHz range into a digital signal for real-time recording and playback using your computer's disk. The $\frac{3}{4}$ -length board uses ADPCM (Adaptive Differential Pulse Code Modulation) and takes its input via an RCA jack.

Using software, you can select a sampling rate of either 8 or 16 kHz. You can then manipulate or randomly access the digitized audio. Since the board operates in the background, it works at a maximum overhead rate of less than 20 percent. Since it has selectable interrupts, you can use multiple boards for applications such as stereo or simultaneous record/playback.

Price: \$395.

Contact: Antex Electronics Corp., 16100 South Figueroa St., Gardena, CA 90248. (800) 621-0849, ext. 350; in California, (213) 532-3092.

Inquiry 772.

LOW-COST HI-RES

CADcontroller is a new multifunction graphics card from GTCO that's designed especially for CAD applications on the IBM AT and compatibles. It displays color graphics in resolutions of up to 1024 by 768 pixels.

Although it's at its best when used with wide-bandwidth high-resolution monitors, you can configure CADcontroller to work with lower-cost (lower-bandwidth) monitors at either

1024- by 768-pixel interlaced or 800- by 600-pixel noninterlaced resolutions.

CADcontroller has a standard RS-232C serial port. A 1-megabyte RAM expansion board is also available.

Price: \$777; RAM expansion, \$495.

Contact: GTCO Corp., 7125 Riverwood Dr., Columbia, MD 21046, (301) 381-6688.

Inquiry 773.



Introducing the most agile mouse ever to set foot on a desktop.

The LOGITECH HiREZ Mouse—the only mouse expressly designed for high-resolution screens.

With a resolution of 320 dots-per-inch (as compared with 200 dpi or less for ordinary mice), it covers the same area on your high-res screen, but needs less of your desk to do it. More than 50% less. Saving you valuable desk space, and effort: mouse maneuvers that used to require a sweep of the hand are now reduced to a flick of the wrist.



The LOGITECH HiREZ mouse needs 50% less desk space to cover the same amount of screen area as a 200 dpi mouse.

Which makes this new mouse a hand's best friend. And a more reliable, long-lasting companion—fully compatible with all popular software, and equipped with a Lifetime Guarantee.

Equipped, too, with other advantages exclusive to all Logitech mice: A unique lightweight ergonomic design. Low-angled buttons for maximum comfort and minimum fatigue. An exclusive technology that guarantees a much greater life span. An exceptionally smooth-moving, dirt-resistant roller ball. And natural compatibility with all PCs, look-a-likes, and virtually any software.

So if you've got your eyes on a high-res screen, get your hands on the one mouse that's agile enough to keep up with it.

The LOGITECH HiREZ Mouse.

For the dealer nearest you, call 800-231-7717 (800-552-8885 in California), or write Logitech, Inc., 6505 Kaiser Drive, Fremont, CA 94555. In Europe, call or write: Logitech Switzerland, European Headquarters, CH-1111 Romanel/Morges, Switzerland (+41-21-869-9656).

 LOGITECH

Circle 147 on Reader Service Card (DEALERS: 148)

How to pick th



Though most mice out there look pretty much alike, they're not all equal in performance. It pays to be just a little choosy to make sure you end up with the right mouse for your needs.

Starting with software. If you want full compatibility with all of your software, all you have to do is look for a mouse with the Logitech name. There are four in all, each one designed for different hardware needs.

THE HiREZ MOUSE

If you've got your eyes on a high-resolution screen, the mouse to get your hand on is the new LOGITECH HiREZ Mouse.

With a resolution of 320 dots-per-inch (as compared with 200 dpi or less for ordinary mice), it covers the same area on your high-res screen but needs less of your desk to do it. More than 50% less. Saving you valuable desk space, and



The LOGITECH HiREZ Mouse needs 50% less desk space to cover the same amount of screen area as a 200 dpi mouse.



Good instincts run in this family (left to right): the new LOGITECH HiREZ Mouse (\$179), the only mouse designed expressly for high-res screens; the LOGITECH Series 2 Mouse for the IBM PS/2 (\$99, plugs right into mouse port); and the LOGITECH Mouse for standard screens (\$119, in bus and serial versions).

All come with Logitech's own Plus Software, which assures ease of use with virtually any software, mouse based or not.

effort: mouse maneuvers that used to require sweeps of the hand are now reduced to a flick of the wrist.

Which makes this new mouse a hand's best friend. And a more reliable, long-lasting companion. And, like all Logitech mice, it's fully compatible with all popular software, and equipped with a Lifetime Guarantee.

THE SERIES 2 MOUSE

For those who've chosen the Personal System/2,[™] the most logical choice is the LOGITECH Series 2 Mouse. It's 100% compatible with PS/2, and plugs right into the mouse port, leaving the serial port free to accommodate other peripherals.

e right mouse.

THE ALL-PURPOSE MOUSE: SERIAL OR BUS

Most people find our standard mouse is still the best choice for their systems. It's available in both bus and serial versions, one of which is sure to fit perfectly with your hardware. And with all your favorite software—whether mouse-based or not.

It's hardly an accident that only Logitech offers you such a complete selection—we're the only mouse company to design and manufacture our own products. We make more mice, in fact, than anyone else. Including custom-designed models for OEMs like AT&T, DEC, and Hewlett-Packard.

The three mice pictured to the left come with all this expertise built right in. Which explains an interesting paradox: while you may pay less for a Logitech mouse, you'll surely get more in performance.

And in comfort. With a unique lightweight ergonomic design. Low-angled buttons for maximum comfort and minimum fatigue. An exclusive technology that guarantees a much greater life span. An exceptionally smooth-moving, dirt-resistant roller ball. And natural compatibility with all PCs, look-a-likes, and virtually any software.

All of which leads to an inescapable conclusion: if you want to end up with the right mouse, start with the right mouse company.

Logitech. We've got a mouse for whatever the task at hand.

For the dealer nearest you, call 800-231-7717



A Logitech mouse plus Logitech application software equals a complete solution (all prices include mouse, Plus Software, and application):

LOGICADD...\$189. Turns your PC into a full-featured CADD workstation. Everything you need for dimensioned line drawing and CADD.

PUBLISHER PACKAGE...\$179. PUBLISHER software lets beginners and experts alike produce professional, high-impact documents. Design templates make page layout easy.

LOGIPAIN SET...\$149. Eleven type fonts and a 16-color palette. Creates files that move easily into both LOGICADD and PUBLISHER documents.

(800-552-8885 in California). Or fill out and mail the coupon below to: Logitech, Inc., 6505 Kaiser Drive, Fremont, CA 94555. In Europe, call or write: Logitech Switzerland, European Headquarters, CH-1111 Romanel/Morges, Switzerland (+41-21-869-9656).



Logitech, Inc., 6505 Kaiser Drive, Fremont, CA 94555.
Logitech Switzerland, European Headquarters,
CH-1111 Romanel/Morges, Switzerland.

Yes! Please send me the name of the nearest Logitech dealer.

Name _____

Company/Title _____

Address _____

Phone _____



LOGITECH

Personal System/2 is a trademark of International Business Machines Corporation.

HARDWARE • OTHER

Analyze Those Waveforms

The MacSpeech Lab II is a complete system for speech, music, and waveform analysis using Apple's Macintosh II. According to GW Instruments, typical applications for the lab include the development and testing of audio equipment, voice and sound analysis by crime laboratories, speech disorder analysis, speech therapy, speech-recognition and speech-synthesis technology development, audiological testing and studies, and other assorted acoustic studies.

The heart of MacSpeech Lab II is the MacADIOS data acquisition board, along with the MacADIOS II antialiasing filter daughterboard. Also included are a microphone, speaker, record and play amplifiers, and MacSpeech Lab II software.

The system can digitize complex waveforms up to 4½ minutes long at sample rates of from 5 to 80 kHz. You can then view, play, analyze, edit, or print them. MacSpeech Lab II is available either solo or complete with a Macintosh II and Apple LaserWriter Plus, or with the Macintosh II without the printer. Price: \$6999; with Mac II and printer, \$16,350.

Contact: GW Instruments Inc., P.O. Box 2145, Cambridge, MA 02141, (617) 625-4096. Inquiry 774.



MacSpeech Lab II brings waveform analysis to the Mac II.

Companionship for Your Computer

Cyx Corp. stresses that it's not a network or multitasking device, but what its product—named Companion—can do is add an extra keyboard and monitor to your system up to 250 feet away from your system unit.

Companion uses a connector box and special circuitry to use a single ¼-inch cable for both keyboard and monitor. It can be switched from "shared," which allows both local and remote keyboards and screens to be active, to "private," for when you don't want the remote screen visible.

According to its maker, Companion works with all IBM PCs and compatibles. If you're using monochrome or color monitors, you can get

Companion in cable lengths of 25, 50, 100, and 150 feet.

Price: \$199 and up.

Contact: Cybex Corp., 1860-B Sparkman Dr., Huntsville, AL 35816, (205) 830-1100.

Inquiry 775.

Serious Joy(stick)

The "ultimate control for flight-simulation software" is what CH Products calls its FlightStick joystick for the Apple II and IBM PC and compatible families. The FlightStick has a contour pistol grip, with both trigger and fire buttons. The IBM version also has a thumbwheel control for throttle control on both Microsoft's Flight Simulator and Electronic Art's Advanced Flight Trainer.

The FlightStick also has

dual-axis trim controls, and a 5-foot cable with thumb-screws. CH Products says the internal potentiometers are rated at 4 million life cycles, and that its return-to-center accuracy is $\pm .5$ percent.

The Apple model of the FlightStick works with the IIe, IIc, and IIGS. The IBM model is compatible with the PC, XT, AT, and compatibles, as well as the PS/2 series. On the IBM, you'll need a game port, and CH Products just happens to have its new Gamecard III Plus available. The board has a three-position switch that adjusts the gameport interface to three different values.

The company claims the board also lets you use joysticks and computer games with AT compatibles at up to 16 MHz.

Price: Apple version, \$74.95; IBM version, \$79.95; Gamecard III Plus, \$59.95.

Contact: CH Products, 1225 Stone Dr., San Marcos, CA 92069, (619) 744-8546.

Inquiry 776.

Coprocessor Speedup

Due to the variation in speed rating of 80287 arithmetic coprocessor chips, most computer systems run these chips at only 66 percent of the speed of the 80286 processor. But a company called Semiconductor Physics has a solution. Its Co-Clock is an 80287 speedup board that's sold without the coprocessor chip.

Available in rated frequencies of 10 and 12 MHz, the Co-Clock operates at the precise rated frequency of the 80287. Installation is a simple matter of inserting the 80287 into the Co-Clock, and inserting the Co-Clock into your system's 80287 socket.

Price: \$60.

Contact: Semiconductor Physics Inc., 639 Meadow Grove Place, Escondido, CA 92027, (619) 741-3360.

Inquiry 777.

FRIENDLIER THAN THE AVERAGE MOUSE

Mouse-Trak looks like a trackball, and it is. But it's compatible with a mouse. According to Itac Systems, Mouse-Trak is more accurate and requires less effort to use than your garden-variety mouse.

The essence of Mouse-Trak is a 2-inch polished phenolic ball. Using a DIP switch, you can set the on-board buttons for either mo-

mentary contact or toggle on/off. There's also a speed-control button that gives you a 4-to-1 change in cursor velocity.

Five versions of Mouse-Trak are available. The two standard RS-232C versions (two or three buttons) emulate both the Microsoft Mouse and the Mouse Systems PC Mouse, respectively. The three quadrature

versions are replacements for mice that operate with systems ranging from Atari to Apple, to more powerful systems such as Sun, Apollo, VAX, and Tektronics.

Price: \$119 to \$179.

Contact: Itac Systems Inc., 1303 Columbia, Suite 217, Richardson, TX 75081, (800) 533-4822; in Texas, (214) 234-5366.

Inquiry 778.

continued

ANNOUNCING ORACLE[®] FOR 1-2-3. JUST IN TIME - \$199

Spreadsheet growing too big and complex? You need a database. No time to learn a database? You need the ORACLE database add-in for Lotus 1-2-3.

If you have Lotus 1-2-3 and \$199, you can now solve the six biggest spreadsheet problems:

- 1 Has your spreadsheet grown so complex you can't keep track of the formulas any more?
- 2 Have you had to break down your large spreadsheet into many smaller ones?
- 3 Do you have to manually re-enter data that's duplicated in several spreadsheets?
- 4 Do you have to manually manipulate rows into meaningful groups?
- 5 Is recalculation time for seldom-used reference variables eating you alive?
- 6 Do you wish you could simultaneously share spreadsheet data with other PCs, as well as with minis and mainframes?

Now, ORACLE for 1-2-3 turns your spreadsheet into the world-class database you already know how to use. And without learning a new database language, you can use the very same ORACLE that's the most requested DBMS by minicomputer and mainframe users. All for only \$199.

ORACLE for 1-2-3 lets data relationships replace ever more complex spreadsheet formulas. No more time is wasted recalculating seldom-used reference cells. In short, ORACLE puts data back where it belongs. In a database.

With simple extensions to existing Lotus menus, ORACLE for 1-2-3 lets you create new database tables right from rows and columns in your spreadsheet. When you query the database from a cell, you immediately see current database information. Update a spreadsheet cell, and the



database is simultaneously updated. A range of cells in your 1-2-3 spreadsheet could really be a window into an online micro, mini or mainframe database anywhere in the world. It's network ready, from LAN to WAN. All as easy as... 1-2-3.

ORACLE FOR 1-2-3: THE NEW STANDARD

ORACLE is the number one database for mainframes, minicomputers and workstations. Software Digest recently rated ORACLE the most powerful and versatile relational DBMS for the PC. And ORACLE is based on SQL, the data management standard endorsed by IBM, ANSI, ISO and the federal government. Now, there is a new standard: ORACLE for 1-2-3. It has the simplicity you've always had, with the power you've always wanted.

THE ADVANTAGES OF DATABASE TECHNOLOGY

If your data is in a database, your spreadsheet only has to deal with the data you're interested in. Which means spreadsheet performance is

dramatically improved. But this is just the beginning.

Multiple users can share the same data. Different users can have different levels of security. Mainframe-class data integrity and error recovery mean never having to say "Ooops!"

- CREATE YOUR DATABASE FROM SPREADSHEET COLUMNS AND ROWS. Familiar menus and context-sensitive help guide you through the process.
- QUERY YOUR DATABASE AS EASY AS 1-2-3. Have the query built for you, or write SQL queries yourself. Learn why SQL is the industry

data management standard

- UPDATE YOUR DATABASE AS YOU UPDATE SPREADSHEET CELLS. In update mode, changes in your spreadsheet become changes in your database. And if you make a mistake, you can...

- COMMIT OR UNDO CHANGES. Finally, an "UNDO" command for 1-2-3! When your database changes are complete, you can COMMIT them, or ROLLBACK your database and your spreadsheet.

- AROUND YOUR OFFICE OR AROUND THE WORLD. ORACLE for 1-2-3 is network ready for data distribution on LANs and WANs. So data on PCs, workstations, minis and even on mainframes appears as if it's on your local hard disk.

HEARD ENOUGH?

WE'LL PAY SALES TAX AND SHIPPING IF YOU FILL OUT AND MAIL THE ATTACHED COUPON, OR CALL TODAY. YOU CAN ALSO SEE A DEMONSTRATION AT YOUR FAVORITE COMPUTER STORE.

Dear Oracle, ORACLE for 1-2-3 • Oracle Corporation
20 Davis Drive • Belmont, CA 94002

Yes, I have an 80286/80386 PC running DOS 3.0+ and Lotus release 2.01. I also have 512KB of RAM, plus either 1MB of extended memory or I'll reassign 1MB of my expanded (above-board) memory as extended memory. Please send me the database I already know how to use: The ORACLE Database Add-in for Lotus 1-2-3. Enclosed is my check, or VISA/ MC/ AmEx credit card authorization for \$199. Hurry.

Print Name _____ Date _____
Company _____ Title _____
Street (No P.O. boxes, please) _____
City _____ State _____ Zip _____
Phone _____
Credit Card Number _____ Card Expiration Date _____
Signature _____ (BY)

ORACLE[®]
COMPATIBILITY • PORTABILITY • CONNECTABILITY

CALL 1-800-ORACLE1
EXT. 149 TODAY.

Oracle is a registered trademark of Oracle Corporation. The following are also trademarks: Lotus and 1-2-3 of Lotus Development Corporation; IBM of International Business Machines. TR8A

SOFTWARE • PROGRAMMING

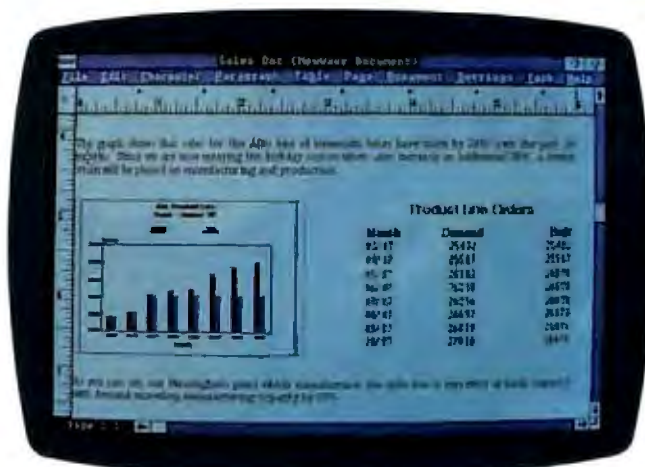

HP's NewWave integrates data from multiple applications.

Windows Management Under QuickBASIC

QuickWindows is a window-management library for Microsoft's QuickBASIC. You can create windows, pop-up and pull-down menus, help windows, and data-entry screens, and you can access over 60 functions through BASIC with the CALL statement.

When you open a window, the program automatically saves the screen contents below. When you close the

window, it restores the screen. You have control over the style, size, and attributes of each window. Each window also has its own cursor, so you can write text to a window, and the window scrolls when it becomes full.

QuickWindows is written in assembly language. It runs on the IBM PC, XT, AT, or compatible with a hard disk drive or two floppy disk drives and MS-DOS or PC-DOS 2.0 or higher. You need at least 320K bytes of available memory, and 512K bytes is

recommended. You also need Microsoft's QuickBASIC and an EGA or CGA video board. The program also supports the Microsoft Mouse. **Price:** \$79; \$99 with source code.

Contact: Software Interphase Inc., 5 Bradley St., Suite 10, Providence, RI 02908-2304, (401) 274-5465. **Inquiry 779.**

HP's Icon-Based Application Environment

The NewWave environment combines object-management technology, artificial intelligence, and a graphical user interface. It lets you integrate data from multiple applications including text, graphics, voice, and scanned images. Hewlett-Packard reports that the data is linked seamlessly. "Hot connects" between applications make sure that when you modify one object, all others are updated as needed.

NewWave can run any MS-DOS application, but you need to write code to make it appear as a seamless object in the NewWave environment. You

can run the MS-DOS application from within NewWave, represent the data from the application as an icon, or fully integrate the application into NewWave by hot connects.

A task manager (the Agent) is like a macro processor but can record comments applying to different MS-DOS applications. The Agent uses scripts written in the NewWave Task Language, and you can use it to automatically execute repetitive tasks at a particular date and time.

NewWave runs on the IBM PC, XT, AT, and compatibles with Microsoft Windows 2.0. **Price:** \$895.

Contact: Hewlett-Packard, P.O. Box 10301, Palo Alto, CA 94303-0890, (800) 367-4772; in California, (415) 857-1501. **Inquiry 780.**

Application Modeling

Model-S lets you develop a working model of process-related applications. To create a model, you break the application into frames, such as menus, data-entry panels, and reports, which may include both text and data. You then link the frames into a working model, test it during development, and display the flow diagram; then you can export it to a database.

You can develop models with up to 200 frames, and for longer models you connect them to form super-models. Frame size is 60 rows by 160 columns, and you can have up to 200 titles and data fields. You can link it to as many as 60 other frames.

The program runs on the IBM PC and compatibles with a hard disk drive, one or more floppy disk drives, PC-DOS or MS-DOS 2.0 or higher, and at least 256K bytes of RAM. Color is supported. **Price:** \$149.

Contact: PC-Systems, 307 Barwyne Lane, Wynnewood, PA 19151, (215) 649-8981. **Inquiry 781.**

TURBO PASCAL 4.0 LIBRARY AND COMMUNICATIONS UTILITY

Power Tools Plus 4.0 is a library of over 140 functions that enhance the Turbo Pascal 4.0 programming environment. You can install a Turbo Pascal procedure as an interrupt-service routine or an intervention code that can be automatically triggered at certain times of the day or when you press hot keys.

The utilities provide cursor control, screen attribute settings, multiple-display page support, scrolling, screen input and output, and fast video access. EGA and VGA are supported in text mode, including 43- and 50-line modes.

With Power Tools Plus,

you can construct multiple windows with borders, attributes, and cursor control. You can also stack and remove them, or display them tiled or overlapped. You can also execute DOS commands from within your Turbo Pascal program.

Asynch Plus is another Turbo Pascal 4.0 utility. It lets you add asynchronous communication capabilities to your Pascal applications programs. Asynch offers simultaneous buffered input and output to both communications ports at up to 9600 bps, according to Blaise. It supports the XON/XOFF protocol and XMODEM file transfers. The routines drive

most asynchronous devices via RS-232C ports. The utility includes low-level control and queue-maintenance functions written in assembly language, and high-level routines written in Turbo Pascal.

Both Power Tools Plus and Asynch require Turbo Pascal 4.0 and MS-DOS 2.0 or higher, running on the IBM PC, XT, AT, or compatibles, or the PS/2. The source code is also included with both products.

Price: \$129 each. **Contact:** Blaise Computing Inc., 2560 Ninth St., Suite 316, Berkeley, CA 94710, (415) 540-5441. **Inquiry 782.**

continued



Perfect matches to DEC user needs. Hip. Hip. And Hooray.

One-size-fits-all is an attribute best reserved for inexpensive socks. In the realm of PC-based emulation and communications software for DEC mainframe users, it's important to match specific user needs with specific product attributes. We have.

SmartTerm® 240 features exact four-color emulation of a DEC® VT241 terminal. Along with delivering full-screen ReGIS® and Tektronix® 4010/4014 graphics, SmartTerm 240 offers precise VT220, VT102, VT100, and VT52 text emulation.

For non-graphics applications, SmartTerm® 220 duplicates virtually every SmartTerm 240 text, communication, and ease-of-use feature. Three error-free file transfer protocols, including Kermit and Xmodem, are provided. Downloading minimizes on-line time requirements to boost overall system efficiency. And an optional network package allows direct LAN access to shared modems, printers, as well as host mainframes.

As SmartTerm 240 and 220 focus on graphics and text, new SmartMOVE® makes PC-to-the-rest-of-the-World communications sharper than ever. Speed connect, auto redial, and background file transfer features make this VT100 emulator a loud and clear choice for advanced communications requirements.

Graphics, text, and communications. If you're looking for a perfect fit, seek the software sized and priced to match your needs. Persoft has it. Period.

See us at DEXPO West Booth 1024, visit your dealer, phone us at 608-273-6000, or use inquiry code 50.

© 1987 Persoft Inc. All rights reserved. Persoft, SmartTerm, and SmartMOVE are registered trademarks of Persoft Inc. DEC, VT and ReGIS are trademarks of Digital Equipment Corporation. Tektronix is a registered trademark of Tektronix Inc.

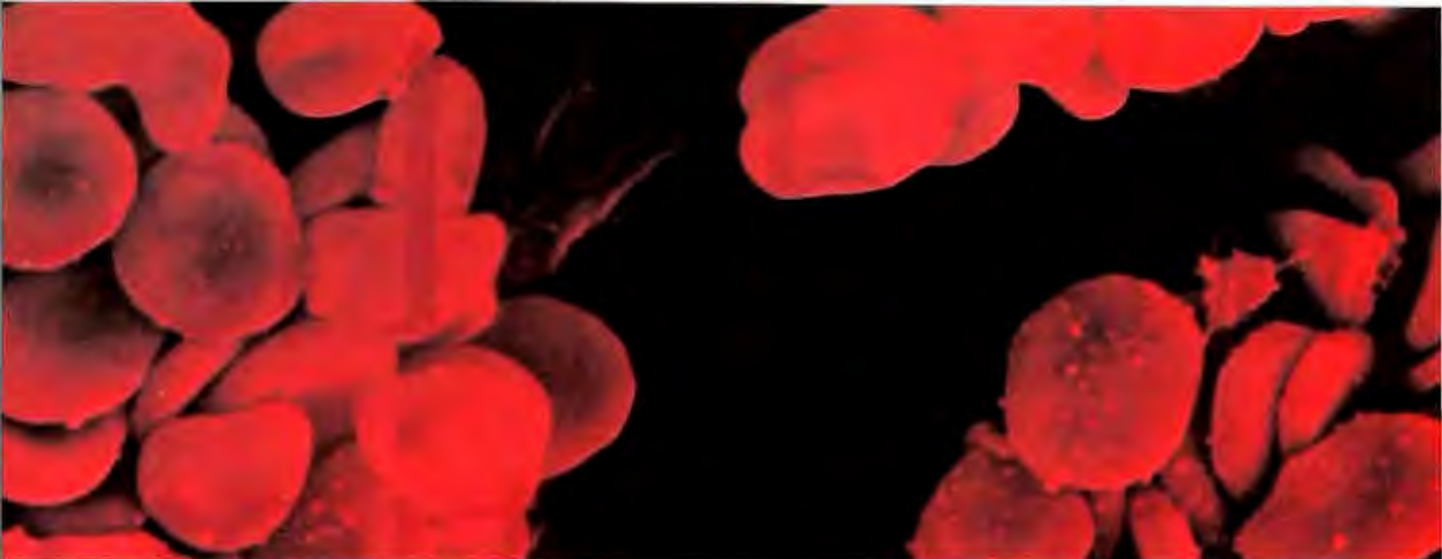

Scanning electron micrograph of red blood cells

SOME PEOPLE ASK LIFE & DEATH QUESTIONS WITH OUR MICROPROCESSOR DEVELOPMENT TOOLS.

Multiply your productivity with NEW Avocet C.*

What you see above isn't the late-night vision of an overworked design engineer.

Rather, it's blood—ready to be computer assayed at the touch of a button in a hospital operating room—on a new blood gas analyzer that works twice as fast as ever before. All to save time, money, error—and lives.

This breakthrough for anesthesiologists was created by NOVA Biomedical. And made possible by AVOCET, acclaimed as the best source for professional-quality assemblers, simulator/debuggers and cross-compilers for microprocessor and microcontroller software development.

Let Avocet turn your PC or VAX into a fast, powerful, integrated development system in 48 hours, even overnight.

Avocet can help you turn more good ideas into more real products in less time.

Just call us now and we'll get you up and running with what EDN calls "the most flexible, easy-to-use, high-speed development tools"—everything you need to turn your computer into a sophisticated personal development system.

All at a modest price. From a single source. Backed by the reassurance of a technical hotline. So friendly, knowledgeable, immediate-response support is always as close as your phone.

Start with the industry standard: Avocet AVMAC™ Assemblers.

The latest AVMAC Version 2.0 offers you lightning-fast assembly. Plus, enhanced compatibility with Intel, Hitachi, Motorola & other chipmakers. Each AVMAC package comes complete with our AVLINK™ linker, AVLIB™ librarian, AVREF™ cross-reference generator and 200+ pg. User's Guide—all the tools you'll want and need.

Introducing Avocet C—professional-quality optimizing cross compilers for the Z80, 64180, 8096, 8051 and more.

Avocet C gives you quick compilation and compact, fast-running object code. And yes, it supports the full C language, including many ANSI extensions.

Of course, Avocet C is also compatible with our AVMAC assemblers. So you can drop into assembly language when you need to work magic at the bits-and-bytes level.

Test with the best: AVSIM™ Simulator/Debuggers.

NOVA™ Biomedical design engineers rate AVSIM "Number One" for checking programs—quickly and reliably.

AVSIM test target μ P/ μ C code right on your PC, with no special hardware. It can't be crashed by program bugs. And the full-screen display gives you instant visual access to the entire CPU: flags, registers, memory, I/O ports and on-chip peripherals. Highly-rated by EDN, "only AVSIM is sophisticated enough to let you set unlimited breakpoints and traps."



Target Microprocessor Families Supported		
1802/1805	68000/68010	COP400
6502/65C02	68020	HD64180
6801/6301	8048/8041	NEC 7500
6804	8051/8052	TMS-32010
6805/6305	8085	TMS-32020
6809	8096	Z8
68HC 11	F8/3870	Z80

Host Operating Systems			
CP/M	DOS	PC Xenix	VAX Unix
AVMAC Macro Assemblers			from \$349
AVSIM Simulator/Debuggers			from \$379

Call now about new Avocet C Cross Compilers from \$895

CALL TOLL-FREE
800-448-8500*

to order, inquire about other development tools or receive our latest microprocessor development tool catalog

Try before you buy

Order your AVMAC assembler and AVSIM simulator/debugger today and we'll include a special demo kit for both. Try the demo for 30 days. If you're not satisfied for any reason, return unopened products for a full refund, less the \$35 demo/documentation kit which is yours to keep.

Avocet Systems. With our development tools, the diagnosis for your project is a smooth finish—on time and on budget.

Avocet Systems, Inc., 120 Union Street
P.O. Box 490AQ, Rockport, Maine 04856

*Outside U.S. and in ME, call (207) 236-9055
TLX: 467210 AVOCET C1 FAX: (207) 236-6713

Avocet delivers all the tools you need in 48 hours or less. Ask about our NEW Cross-Compilers, our AVPROM™ and AVPAL™ programmers, our 8051 in-circuit emulator, development boards, the AVPAS 51™ cross-compiler—and AVKIT™, the total Unix toolbox for DOS, including the incomparable V1 editor.

© 1987 Avocet Systems, Inc. All rights reserved. VAX is a trademark of DEC. Unix is a trademark of AT&T. Xenix is a trademark of Microsoft. CP/M is a trademark of Digital Research.

AVOCET
SYSTEMS, INC.*

THE SOURCE FOR QUALITY PERSONAL μ P DEVELOPMENT TOOLS.

Circle 30 on Reader Service Card

Inside the revolution

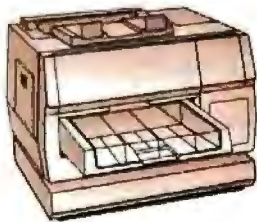

NBI, Inc. Model 908

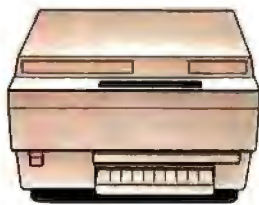

QMS-PS 800
QMS-PS* 800+
QMS-PS* 800 II*



*Linotype Company Linotronic™ 100
Linotype Company Linotronic™ 300*

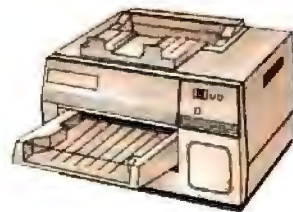

*Digital Equipment Corp
ScriptPrinter™*

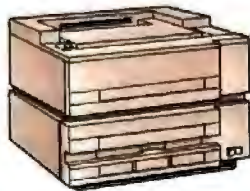

Qume Corporation ScriptEN™

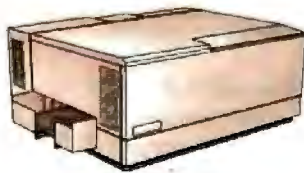

Diconix Digi® 1/PS

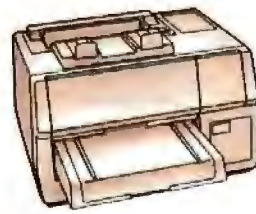

AST Turbo Laser®/PS

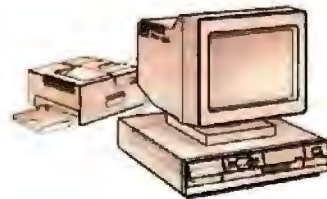

IBM 4216-020 Personal PagePrinter™

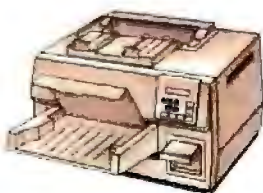

Texas Instruments OmniLaser™ 2108

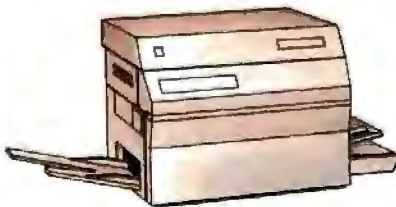

Vantyper VT-600

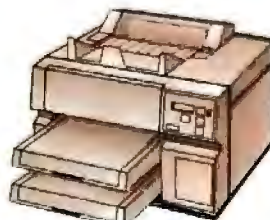

Wang LCS15™

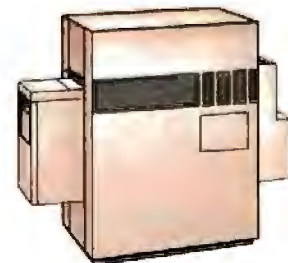

Agfa-Gevaert P400PS™



The Laser Connection PS Jet/PS Jet+™

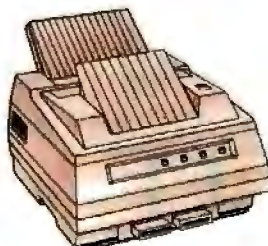

*NEC Information Systems
SilentWriter™ LC-890*



QMS-PS® 2400

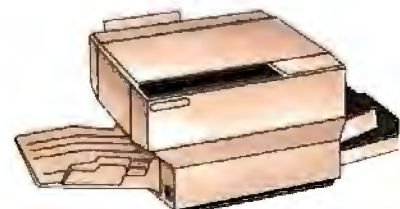

*Apollo Computer Inc
Domain/Laser 26™*

e printers a is going on.

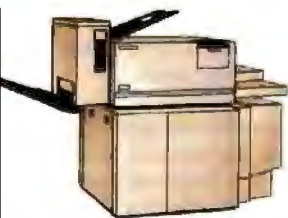

Digital Equipment Corp. PrintServer 40™

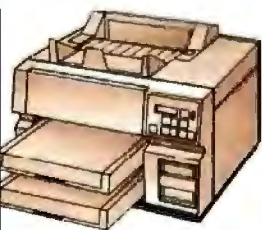

Texas Instruments OmniLaser™ 2115

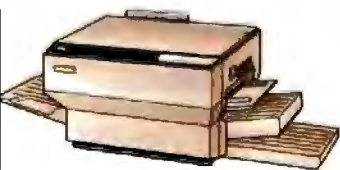

Dataproducts Corp. LZR™ 2665

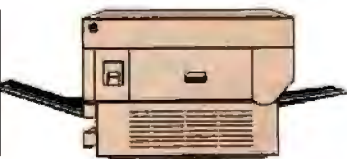

Apple Computer Inc. LaserWriter®
Apple Computer Inc. LaserWriter® Plus

POSTSCRIPT® from Adobe Systems started a revolution in business communications. That's why you'll find POSTSCRIPT in virtually every popular laser printer sold today.

POSTSCRIPT, the page description language, is the unanimous choice for some very good reasons. POSTSCRIPT gives you the option of printing from an IBM® PC, Macintosh™, or mini/mainframe.

With so many printers to choose from, you won't be tied to a single vendor. And that gives you the flexibility to buy what's best for your

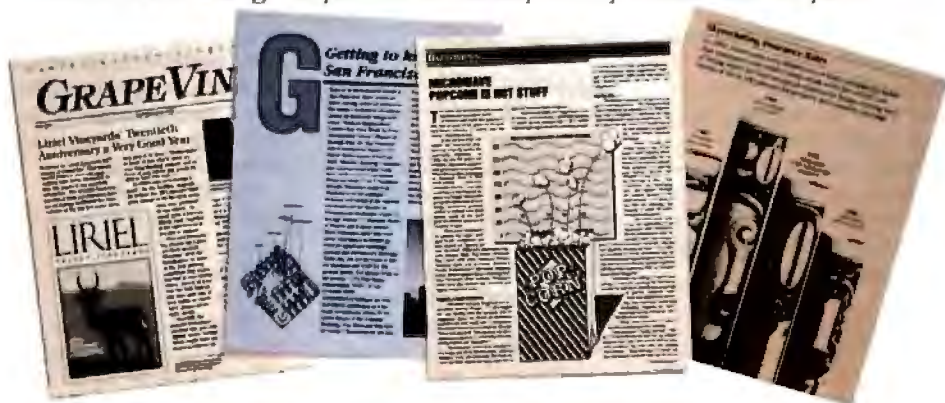

company's needs. Since POSTSCRIPT is device independent, you can design a document, then professionally print it later at a higher resolution.

You can also choose from hundreds of software programs supporting POSTSCRIPT. And POSTSCRIPT lets you combine text, line art, and even digitized photographs on the same page.

POSTSCRIPT from Adobe Systems. The only two names you need to know to join the communication revolution.

Ask for a demonstration on the POSTSCRIPT printer of your choice. With so many to choose from, the hardest decision you may face is which POSTSCRIPT printer to buy.



POSTSCRIPT from Adobe. The Magic Behind Desktop Publishing.

All products are registered trademarks and trademarks of their manufacturers.

Circle 4 on Reader Service Card

Modeling, Animating on the Amiga

Sculpt 3-D is a solids-modeling and ray-tracing program. Animate 3-D is an animation program. You can link the two together to produce animated designs and productions.

Sculpt 3-D is a stand-alone program that can use all 4096 colors of the Amiga palette. It offers mouse control, pull-down menus, and keyboard macros. Three windows show you standard architectural views of a three-dimensional space. A library of shapes includes spheres, cubes, and prisms. Tools such as spin, magnet, and extrude enable you to modify the object's shape.

You can change your point of observation, and, just as if you were using a 35mm camera, you can choose the lens view from wide angle to telephoto. You can also change the placement of light sources.

In quick check mode, which lasts for less than 1 second, you can create a wire-frame model image. Painting mode is for generating a solid model image quickly.

Snapshot mode renders a fast ray-traced image without the shadows, and photo mode gives you a detailed 4096-color ray-traced image with shadows.

Sculpt 3-D supports overscan and all the Amiga graphics modes, as well as NTSC and PAL video displays. Output is in the form of standard IFF files.

Animate 3-D requires Sculpt 3-D as its object editor. It lets you manipulate and control the motion of the objects you create with Sculpt 3-D. You can use segmented and cubic spline paths for objects, observer, and light sources. Animate also lets you preview character animation in real time.

You can also compress and expand images in real time.



A three-dimensional model created with Sculpt 3-D.

Animate lets you interface with single-frame controllers and film recorders.

Price: Sculpt 3-D, \$99.95;

Animate 3-D, \$149.95.

Contact: Byte by Byte Corp., Arboretum Plaza II, 9442 Capital of Texas Highway N, Suite 150, Austin, TX 78759, (512) 343-4357.

Inquiry 788.

Modeling with DataCAD

DC Modeler works with DataCAD 3.5, adding three-dimensional design, editing, and modeling capabilities to the CAD program. The modeler includes an edit menu, which lets you edit drawings from any perspective. An entities menu gives you a variety of three-dimensional shapes such as cones, domes, cylinders, and slabs.

You can access DC Modeler from within the DataCAD menu. All changes you make are automatically made to the drawing file.

To run DC Modeler you need an IBM PC or compatible with 640K bytes of RAM, MS-DOS or PC-DOS 3.0 or higher, and DataCAD 3.5.

Price: \$495.
Contact: Microecture Corp., 617 West Main St., Charlottesville, VA 22903, (804) 295-2600.
Inquiry 789.

Numerical Analysis, Signal Processing, and Graphics

386-MATLAB (matrix laboratory) and 386/Weitek-MATLAB run in protected mode on 386 systems, breaking the 640K-byte memory barrier. The programs, which integrate numerical analysis, matrix computation, signal processing, and graphics, don't require dimensioning. A matrix interpreter accepts commands in standard mathematical notation.

The Weitek version of MATLAB offers floating-point support using the Weitek 1167 on the Compaq Deskpro 386/20.

386-MATLAB runs on 386-based personal computers with an 80287 or 80387 math coprocessor and MS-DOS or PC-DOS 3.1 or higher; 1 megabyte of RAM; and an EGA, CGA, or Hercules Monochrome card. The Weitek version requires the Weitek 1167 coprocessor option.
Price: 386-MATLAB, \$1495; Weitek version, \$1995.
Contact: Math Works Inc., 20 North Main St., Suite 250, Sherborn, MA 01770, (617) 653-1415.
Inquiry 790.

Mechanical Drafting with AutoCAD

Encodraft/Mechanical works with AutoCAD to automate a variety of mechanical drafting tasks. Encodraft/Mechanical has a setup feature that helps you create layers, establish standard drawing sizes, and select layer names and colors. The program can shift the drawing origin to any location automatically.

According to Encode, rules-based construction techniques facilitate geometric construction and ensure that the drawings will meet CAD industry standards. Encode reports that tangencies and other intersections are accurate to 16 significant digits.

A bill of materials extraction routine extracts data captured, and the information is exported to external databases.

The program runs on the IBM AT or PS/2s with AutoCAD 2.5 or higher.

Price: \$500.

Contact: Encode Inc., 12 Cotton Rd., Nashua, NH 03063, (603) 882-4666.
Inquiry 791.

HyperCard Statistical Calculator

CLR StatCalc simulates a statistical calculator with a display, 7 standard functions, 12 statistical functions, and 3 memories. Functions provided include mean, standard deviation, standard error of the mean, correlation, regression, and probabilities. You can enter data in scrollable text fields, or you can read it in from text files.

The program runs on the Macintosh Plus and requires HyperCard.

Price: \$22.50; 1-year site licenses for schools, \$125.
Contact: Clear Lake Research, 5615 Morningside, Suite 127, Houston, TX 77005, (713) 523-7842.
Inquiry 792.

continued



Will The Real VGA Please Stand Up

It's easy to identify the leader in VGA resolution—just look to the company that brought you the *first* 800 x 600 EGA card.

800 x 600 VGA with 256 Colors

1024 x 768, too. Either way, Genoa's SuperVGA HiRes™ is the best way to see VGA. And your spreadsheets will look great, with 132 columns and 60 rows for your viewing pleasure.

Crash-free Windows

Yes, we do Windows—no problem. And SuperVGA HiRes is compatible with both the VGA PS/2 monitors and the EGA Multisync monitors, in VGA and EGA modes.

So don't settle for inadequate imitations. Get the highest VGA performance at the best price, in true Genoa tradition.

For the dealer nearest you, contact: Genoa Systems Corporation, 73 E. Trimble Road, San Jose, CA 95131
FAX: 408-434-0997 Telex: 172319
Telephone: 408-432-9090



Genoa Systems Limited (U.K.) Tel: 01-720-5064

© 1987 Genoa Systems Corporation. SuperVGA HiRes is a trademark of Genoa Systems Corporation. Windows is a trademark of Microsoft, Inc. Multisync is a trademark of NEC Home Electronics.

Circle 104 on Reader Service Card

Memory-Resident Spreadsheet

Datax calls QuickPlan the only memory-resident spreadsheet program for MS-DOS computers. The spreadsheet features a SideKick-like pop-up menu, 17 movable windows, cut-and-paste capability, and math functions.

With the cut-and-paste feature, you can export an area of the spreadsheet to other programs. The 28 built-in math functions and operators let you build worksheets. QuickPlan works with cell ranges, letting you construct formulas containing absolute, relative, or mixed-cell references. You can customize the format of any cell in the spreadsheet, and also change the number of decimals and cell width. QuickPlan's worksheet contains 588 cells in 14 columns by 42 rows.

QuickPlan is not copy-protected and runs on the IBM PC with at least 150K bytes of available RAM. It comes with TurboCalc, a 24-function calculator, and FileMaster, a DOS shell and macro processor.

Price: \$79.

Contact: Datax, 470 12th Ave. N, St. Petersburg, FL 33701, (813) 894-7472.

Inquiry 793.

Two on Taxes

ChipSoft's TurboTax and J. K. Lasser's Your Income Tax both take the 1986 tax reform act into account. They feature on-screen calculators and pin-feed 1040 forms (and don't require preprinted 1040s).

TurboTax offers pop-up instructions from the IRS booklets. A forms finder helps you locate the form you need by subject. TurboTax's data examiner checks over your return when you're done to see if you've missed anything.

Also included with Turbo-



QuickPlan, the memory-resident spreadsheet.

Tax is Price Waterhouse's guide to 1987 and 1988 taxes. More than 35 schedules and worksheets are provided with the program. One last unique feature of TurboTax is its tax window, which lets you check your tax status at any point while filling out the forms. A version of TurboTax is available for professional tax preparers.

TurboTax runs on the IBM PC and compatibles with at least 256K bytes of RAM.

Price: TurboTax, \$75; Pro-Series/1040, \$295.

Contact: ChipSoft Inc., 5045 Shoreham Place, Suite 100, San Diego, CA 92122, (619) 453-8722.

Inquiry 794.

Your Income Tax from J. K. Lasser has an interview system feature like the program Ask Dan about Taxes. It asks you questions and suggests the correct forms to use, based on your answers. The program can also compare your tax liability under various scenarios. And, like TurboTax, Your Income Tax has features for the professional tax preparer so you can work on forms for more than one client.

Your Income Tax also runs on the IBM PC and compatibles with at least 256K bytes of RAM.

Price: \$69.95.

Contact: MicroServices, 200 Old Tappan Rd., Old

Tappan, NJ 07675, (800) 624-0023; in New Jersey, (800) 624-0024.

Inquiry 795.

Tracking Sales Accounts

Maximizer is a general-purpose program for salespeople. It lets you keep track of information on your clients, write letters, track your own records, schedule appointments, and more.

Maximizer imposes no limit on the number of clients and no system limit on the number of contacts within a company.

You can define the number of attributes associated with each client, and the terms you use to describe the attributes are up to you. You can write notes and letters with the program's built-in editor.

A day-at-a-glance facility lets you record appointments and other scheduled activities. A telephone directory is created automatically from your records.

To run Maximizer you need an IBM PC with at least 512K bytes of RAM and MS-DOS or PC-DOS 3.0 or higher. It also runs on PS/2s.

Price: \$495.

Contact: Pinetree Software

Inc., 8100 Granville Ave., 9th Floor, Richmond, BC V6Y 1P3, Canada, (604) 270-3311. **Inquiry** 796.

AI and Hypertext Application

Stock Expert is Knowledge Garden's first application that combines hypertext with an expert system. Based on guidelines set by the National Association of Investment Clubs, the program offers assistance in investment decision-making.

Hypertext explains industry jargon, and artificial intelligence is used in the expert system that makes investment recommendations. You can instruct the expert system to think in various ranges so you can adjust its recommendations to reflect your own experience, expertise, and preferences.

The system includes a stock checklist, selection guide, comparison guide, and company database. The checklist helps you analyze past stock growth. The selection guide includes information from Standard and Poor's or Value Line to help you predict stock price fluctuations over the next five years. The comparison guide compares and analyzes the performance of companies and makes predictions on gains. And, finally, the database lets you store historical information on companies. The database lets you search for sales growth, relative value, earnings-per-share growth, retained earnings, and payout.

Stock Expert is written in the KnowledgePro knowledge-processing environment. It runs on the IBM PC, XT, AT and compatibles with 512K bytes of RAM. It also runs on PS/2s.

Price: \$249.

Contact: Knowledge Garden Inc., 473A Malden Bridge Rd., Nassau, NY 12123, (518) 766-3000.

Inquiry 797.

continued



A GEM of a Deal

Free Software from Genoa! For a limited time only, every SuperEGA HiRes+™ card comes with a **FREE** copy of GEM Graph™—the popular business graphics package that normally retails for \$249!

What a combination—a quick, easy way to turn your spreadsheets and database files into stunning graphs, and SuperEGA HiRes+, the *only* Multisync-compatible 16-color EGA card with 800 x 600 resolution!

What can you do with the graphics card that brings you a full-page, readable display for Desktop Publishing? Run your spreadsheets in 132 x 60 columns. Run most VGA applications. Run Ventura,™ Pagemaker,™ AutoCAD,™ Windows,™ and more—all in dazzling 800 x 600 resolution!

Get in on Genoa's GEM of a deal! For the dealer nearest you, contact: Genoa Systems Corporation, 73 E. Trimble Road, San Jose, CA 95131
 FAX: 408-434-0997 Telex: 172319
 Telephone: 408-432-9090

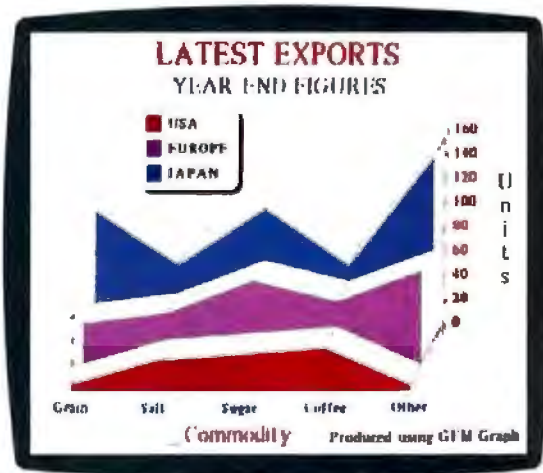

Free GEM Graph Software with every purchase of a Super EGA HiRes+ card from Genoa! But hurry—offer expires March 31st!



©1987 Genoa Systems Corporation
 Offer begins October 1, 1987 and applies to SuperEGA HiRes and SuperEGA HiRes+.
 SuperEGA HiRes and SuperEGA HiRes+ are trademarks of Genoa Systems Corporation.
 GEM Graph is a trademark of Digital Research, Inc. Multisync—NEC Home Electronics.
 Ventura—Xerox Corporation; Pagemaker—Aldus Corporation; AutoCAD—AutoDesk, Inc.
 Windows—Microsoft Corporation

Circle 105 on Reader Service Card



Resident Expert offers information on a variety of programming languages.

Programmer's Reference Guides

Resident Expert contains a memory-resident shell and reference modules that you can pop up as windows to get more information on commands, a summary of syntax, examples, or a cross-indexed list of related topics.

For example, if you forget the syntax for a command such as BACKUP, you activate the shell and press F for Resident Expert's FIND command to pull up a window showing a synopsis and overview. There's also a Related Topic feature and a Snapshot capability, which lets you freeze a window of information and continue typing.

Reference guides are available for Borland's Turbo C 1.0, Turbo Pascal 3.0, and Turbo Prolog 1.1; the Lattice C Compiler 3.2; Logitech's Modula-2 version 3.0, Mark Williams' Let's C 4.0, and Microsoft C. A PC Programmer's Guide is also available.

The program is a terminate-and-stay-resident utility that runs on the IBM PC, XT, AT, and compatibles. It uses 49K bytes of RAM and is compatible with other TSRs, according to Santa Rita. Each reference database uses 110 to 500K bytes of RAM.

Price: \$19 for the shell, which includes MS-DOS and

PC-DOS guides; prices of other guides range from \$19.95 to \$39.95.

Contact: Santa Rita Software, 1000 East 14th St., Suite 365, Plano, TX 75074, (214) 727-9217.
Inquiry 798.

Freehand Drawing on the Mac

Aldus Corp. acquired the rights to FreeHand from Altsys Corp. in August 1987 and plans to release the product early this year.

FreeHand is a drawing program that lets you create or trace graphics with basic drawing tools or advanced line- and Bézier-curve tools. You can manipulate objects and text using special-effects features such as graduated fills of text and objects; the ability to scale, rotate, reflect, and skew objects and text; and the ability to define beginning and ending colors for graduated fills. Drawing tools include lines, rectangles, rounded rectangles, and ellipses. PostScript line and curve tools are also included.

Text-handling capabilities include the ability to bend or shape a line of text along a baseline that you define. Automatic or manual kerning is

available, as well as variable letter and word spacing and variable line spacing.

When you're in preview mode, FreeHand lets you edit. You have nine levels of magnification for viewing work on the screen. There are undo and redo options for the last eight actions you've performed. Other editing features include group/ungroup and lock/unlock commands, automatic alignment of objects and text, snap-to grids, rulers with measurements in increments you define, an on-screen information bar that shows you changes in mathematical increments, and the ability to break up rectangles and ellipses into separate paths.

FreeHand allows you to display up to 256 colors on your Mac II color monitor. The program also has a color-separation capability for the four process colors, spot color separations, or a combination of the two. You can also specify color screen percentages for printing color tints.

FreeHand can import and export files saved in Encapsulated PostScript, and you can also open and edit graphics files created in Adobe Illustrator. The program also supports Clipboard images, which you can bring in as traceable background elements.

FreeHand runs on the Mac Plus, SE, or II with two 800K-byte floppy disk drives or a hard disk drive, and any PostScript-compatible output device.

Price: \$495.
Contact: Aldus Corp., 411 First Ave. S, Suite 200, Seattle, WA 98104, (206) 628-2375.
Inquiry 799.

Quilps and Quotes

Salinson's quipster, called Off-The-Wall, generates one-liners from a library of over 70 patterns and a dictionary. You can add your own phrases to the library and control the placement of nouns, adjectives, adverbs, and verbs.

Off-The-Wall runs on the IBM PC and compatibles with at least 256K bytes of RAM and MS-DOS or PC-DOS 2.0 or higher.

Price: \$29.
Contact: Salinson Corp., 7430 Greenville Ave., Dallas, TX 75231, (214) 692-9091.
Inquiry 800.

A Print Spooler with Sideways Capabilities

Duet is a memory-resident print spooler that performs standard functions such as queuing and background printing of jobs. It also prints sideways and can print 1-2-3 or Symphony spreadsheet files.

Duet can intercept all output sent to the printer by other programs and put it on its print queue. You can reorder, delete, and schedule print jobs for a certain time of day, or put them on indefinite hold. Duet can automatically write the print queue and the spooled files out to disk, so if the power goes down, you won't lose your print jobs.

With sideways printing you have the choice of 12 pre-defined font sizes, ranging from 19 by 10 pixels to 9 by 6 pixels. A font generator is included that lets you customize the sideprint fonts or build your own fonts. Duet comes in four configurations: The largest version has both sideways printing and spreadsheet decoding; another version has sideprinting only; a third version has spreadsheet decoding only; and the last version is without sideprinting or spreadsheet decoding. All four have normal spooling operations.

Duet runs on the IBM PC, XT, AT, and compatibles with at least 256K bytes of RAM.
Price: \$89.95.

Contact: Consumers Software Inc., 736 Chestnut St., Santa Cruz, CA 95060, (408) 426-7311.
Inquiry 801.



On Site Service
Contract available.

Don't Just Buy a Computer Invest in a SF-286

Basic System Features:

80286 16 bit CPU, 512K RAM expandable to 1MB, clock/calendar with battery backup, 196 watt power supply, Maxiswitch keyboard (101 key optional), 1.2MB floppy drive, floppy/hard disk controller, 80287 socket, 8 expansion slots, AMI BIOS, full manual, 48 hour burn-in testing and a one year limited warranty.

Complete System Packages

SF-286	Monographics System	Super EGA System
8 MHz	\$995	\$1499
10 MHz	\$1199	\$1649
10 MHz (0 wa)	\$1349	\$1799
12 MHz (0 wa)	\$1499	\$1950
16 MHz (80386)	\$1950	\$2450

Monographic System:

Basic system features plus monographics card with printer port and 12" amber monochrome monitor with tilt/swivel base.

Super EGA System:

Basic System features plus EGA deluxe graphics card (640 x 480 and 752 x 410) and Mitsubishi Diamond Scan Multisync monitor with tilt/swivel base.

*Other system packages are available, call for prices

SF-286-8 MHz Super VGA Special \$1649

Basic System features plus: Everex EVGA graphics board (640 x 480, up to 256 colors) and Mitsubishi Diamond Scan multisync monitor with tilt/swivel.

Super EGA Bundle \$599

Everex EGA Deluxe autoswitch graphics board, 640 x 480 and 752 x 410, 132 columns PLUS Mitsubishi Diamond Scan with tilt/swivel.

Super VGA Bundle \$749

Everex VGA Graphics board, 640 x 480 and 800 x 600, 132 columns PLUS Mitsubishi Diamond scan with tilt/swivel.

Monographics Bundle \$139

Monographs board with printer port PLUS Samsung amber monochrome monitor with tilt/swivel.

Hard Disk Drives

Seagate ST225 20MB + Controller	\$275
Seagate ST238 30MB + Controller	\$309
Miniscribe 3650 40MB + Controller	\$399
Seagate ST251 40MB + Controller	\$499
Seagate 4038 30MB (39 ms)	\$499
Miniscribe 3650 40MB (61 ms)	\$359
Seagate ST251 40MB (40 ms)	\$449
Micropolite 1335 71MB (28 ms)	\$865
Seagate 4086 80MB (28 ms)	\$899

Everex Modems

Everex Evercom half card modem, 300/1200 baud, fully Hayes compatible and Bitcom software.

External Pocket Modem \$139

Everex Evercom 2400 baud modems

Internal \$179 External \$199

Special

Mini I/O	\$55
Serial Mouse	from \$65
150 Watt Power Supply	\$55
Monographics board	\$79
2MB EMS board w/DK	\$80
3.5" 720K floppy/1.4MB floppy	\$119/\$159
EGA Deluxe Graphics board	\$139
Evercom 2400 Int. modem for PS/2	\$199
Memory board for PS/2	\$269
Everex EVGA Graphics board	\$299

micro

1825 Lombard Street
San Francisco, CA 94123

California Orders, Information

(415) 929-1505

National Order Desk (800) 237-5631
Technical Support (415) 929-1607

University P.O.'s and Dealers Inquiries
are Welcome

TERMS: We accept MasterCard, VISA (no surcharge), American Express, COO's (Certified Funds) and approved company P.O.'s. California residents please add sales tax. 10% fee for unauthorized returns (call for RMA number). Returns must be shipped freight prepaid by customer. Prices are subject to change without notice. We reserve the right to substitute equivalent items. Shipping charge are not refundable.
Everex, Mitsubishi, Samsung, Seagate, Miniscribe, Micropolite, Hayes, PS/2, BitCom and Macintosh are trademarks or registered trademarks of their respective companies.

REGIONAL SECTION

PACIFIC COAST

Stand-Alone Modem

Merge—System A combines a Hayes-compatible modem with a telephone and includes up to 264K bytes of RAM. It allows you to communicate by both voice and data over the same line, send data unattended, and upload and download information without being connected to a microcomputer.

When hooked up to an IBM PC or compatible, Merge—System A supports communication at 300 or 1200 bps. You can store information from your computer in the modem's memory, and transfer data from the modem's memory to your computer. A two-line 80-character LCD screen is provided.

Merge—System A features a programmable alphanumeric



Merge—System A can upload and download unattended.

keyboard with macros, a phone directory that can store 200 numbers, and auto-dial capabilities. Terminal emula-

tion is also provided. Price: With 40K bytes of RAM, \$399; with 264K bytes of RAM, \$499.

Contact: New Generation Technology, 16742 Gothard St., Suite 217, Huntington Beach, CA 92647, (714) 848-0871. Inquiry 823.

Norton's OS/2 Reference Guides

The Norton On-Line Programmer's Guides to OS/2 Kernel API include about 800K bytes of information about DOSx (system and file functions), KBDx (keyboard functions), MOUx (mouse functions) and VIDx (video screen functions).

The memory-resident program provides both short and long entries, including calling sequences and programming examples. A reference section

continued



The interface board makes all Keithley modules compatible with PC or PS/2.

PS/2 Compatible Data Acquisition:

Planned Non-Obsolescence

Design a custom new data acquisition system or upgrade your existing one—the Keithley Series 500 is the one system that is never out of date. All Keithley data acquisition and control modules are fully compatible with the powerful new IBM PS/2 computers.

Because Keithley offers the widest selection of modules, you can configure the exact setup your application requires. And when your requirements change, don't redesign your entire system—upgrade it with new modules from a selection of almost 30, including:

- 12- AND 14-BIT A/D CONVERTERS
- DIGITAL INPUT AND OUTPUT
- ISOLATED ANALOG INPUTS
- STRAIN GAGE WITH BRIDGE COMPLETION
- THERMOCOUPLE WITH ISOTHERMAL BLOCK
- FREQUENCY AND EVENT COUNTING
- LVDT/RVDT CARRIER AMPLIFIER
- 12- AND 16-BIT D/A CONVERTERS
- GPIB CONTROL

Find out more about the Series 500, or discuss your particular application with one of our engineers. Just call our Product Information Group today at

1-800-552-1115



3,000,000 PCS

MEANS QUALITY

Quality, others promise, we deliver. The fact we've already delivered over 3,000,000 color monitors is the best proof. Tatung also makes a full line of computers and peripherals. Our reputation for superb quality is well known around the world. And we deliver complete after sales service to you.

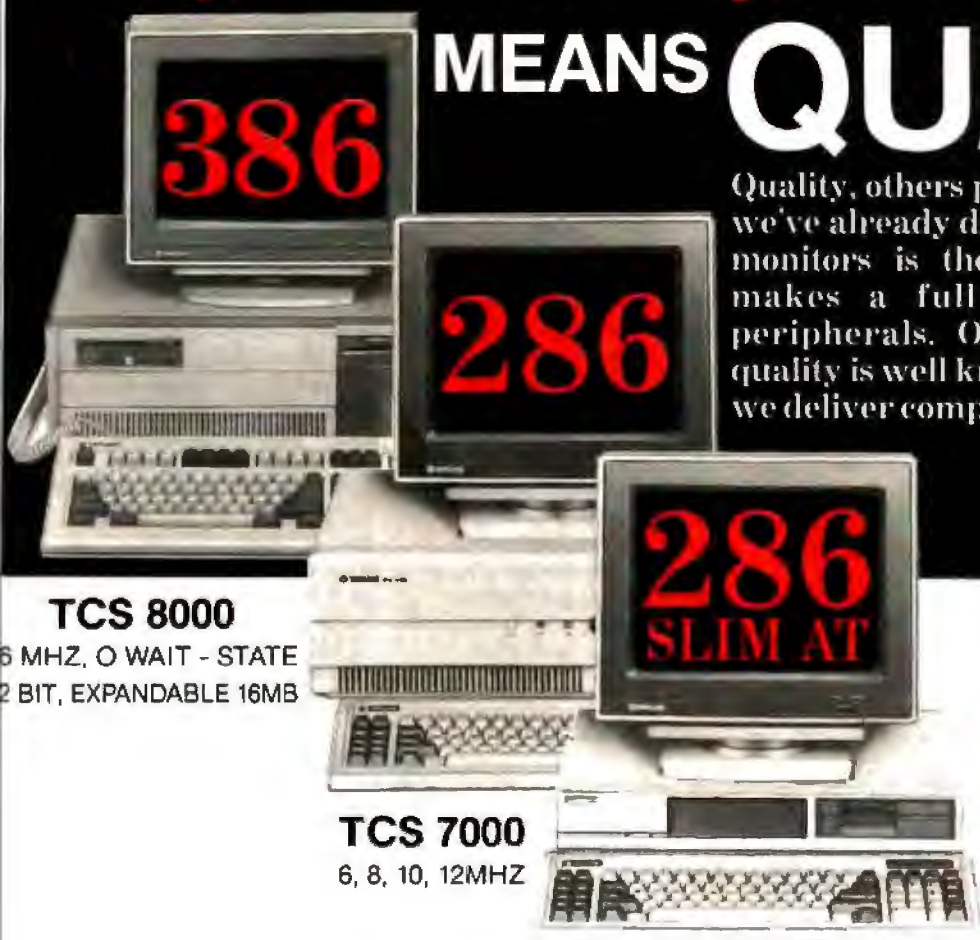

TCS 8000

6 MHZ, 0 WAIT - STATE
2 BIT, EXPANDABLE 16MB

TCS 7000

6, 8, 10, 12MHZ

TCS 4000 (6/10MHZ)

EQUIVALENT OF 5 EXPANSION SLOTS

OMNISCAN

COMPATIBILITY:

IBM VGA™, MCGA*
PGA, EGA, CGA
AT&T™ PCs
APPLE IIGS™
MACINTOSH II™*

14" Color Monitor

RES: 800 x 560
4 MULTI-COLOR MODE

12" Mono Monitor

RES: 800 x 560

* ALL TRADEMARKS ARE PROPERTY OF
THEIR RESPECTIVE MANUFACTURERS

COLOR MONITOR

MODEL RES.

- CM 1322N 640 X 200
- CM 1370A 720 X 400
- CM 1380F 640 X 350
- CM 1495 800 X 560

MONO MONITOR

MODEL RES.

- MM 1222 800 X 350
- MM 1422 800 X 350
- MM 1295 800 X 560

TERMINAL

ET - 10 SERIES

- 14" DARK - TINTED
ANTI-GLARE FLAT CRT
- H10 (AMBER)
- H17 (PAPER/WHITE)

Circle 485 on Reader Service Card

VAR. DISTRIBUTORS. OEM
INQUIRIES ARE WELCOME



TATUNG

TATUNG SCIENCE & TECHNOLOGY INC.

408-435-0140

780 CHARCOT AVE. SAN JOSE CA. 9513

PACIFIC COAST

includes an introduction to OS/2 and examples of programming techniques like pipe creation and using protected mode for running multiple processes. It also provides information on OS/2 data structures, ANSI escape sequences, and I/O control functions.

You invoke the program by pressing a hot key. It then presents you with a menu that provides expand and search functions; and kernel, tables, and reference areas. Each category includes a list of short entry descriptions. Once you find the appropriate short entry, you can open its corresponding long entry.

With the options menu, you can set screen colors, change the hot key, de-install the instant-access program from memory, and invoke the auto-lookup function, which enables you to automatically search for what your cursor is

on when you invoke the program.

The Norton On-Line Programmer's Guides to OS/2 Kernel API enable you to create your own cross-referenced databases with menus and expandable entries.

The program runs on the IBM PC and compatibles with MS-DOS or PC-DOS 2.0 or higher or OS/2 (in the DOS compatibility box). A version that runs in OS/2 native mode is also available. The program takes up 72K bytes of RAM. It comes on both 3½- and 5¼-inch floppy disks. You can purchase it with or without the Norton Guides Engine instant-access program.

Price: \$100 without Norton Guides Engine; \$150 with Engine.

Contact: Peter Norton Computing, 2210 Wilshire Blvd., Suite 186, Santa Monica, CA 90403-5784, (800) 451-0303,

ext. 40; in California, (213) 453-2361.

Inquiry 824.

Stackware Provides Videodisk Links

The Voyager Company's Laserstacks are among the first to take advantage of HyperCard's capabilities as a front end to large databases. A Laserstack turns the still photographs and motion pictures on existing videodisks into visual databases.

The hub of the series is VideoStack, which enables you to develop interactive videodisk applications with HyperCard. It provides more than 35 buttons controlling different functions. It allows you to automatically install video drivers into any HyperCard stack, define video events, and automatically activate the events.

The National Gallery of Art Laserguide is designed to work with The Voyager Company's National Gallery of Art disk that contains still photographs of the permanent collection on display at the National Gallery of Art in Washington, DC. You can organize works of art and present them according to artist, nationality, school, and other categories.

Laserguides are also available for Voyager's Vincent Van Gogh and Bio-Sci disks.

The Laserstacks series runs on the Macintosh Plus, SE, and II with HyperCard and a videodisk player.

Price: VideoStack, \$49.95; National Gallery of Art Laserguide, \$49.95; Vincent Van Gogh Laserguide, \$39.95; Bio-Sci Laserguide, \$99.95.

Contact: The Voyager Company, 2139 Manning Ave., Los Angeles, CA 90025, (213) 475-3524.

Inquiry 825.

a square peg does fit a roundhole

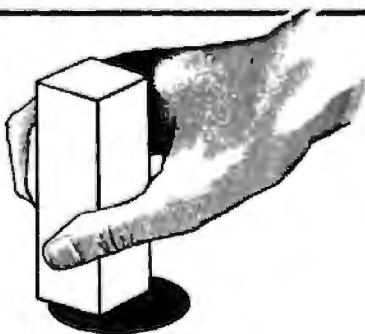

Converts Incompatible Formats To Standard IBM-PC And PS/2 Compatibility

Now anyone can move important data and costly software from 5¼" IBM-PC format to 3½" PS/2 format without any hardware connections.

You don't have to wire anything, program anything or understand anything about either type of computer. Just install your 5¼" data diskette and a blank 3½" diskette in the Copi•Riter and press two buttons. It's that easy!

The Copi•Riter can also collect data from non-IBM systems with RS-232C or Parallel interfaces and save it in IBM compatible format. Write or phone MECA today for specifications on the Copi•Riter and our other versatile storage devices.



Copi•Riter

MECA

56677 Sunset Ave., NBU 8419
Yucca Valley, CA 92284
(619) 365-7686

"INCREDIBLY FAST"

— PC RESOURCE Nov. 1987



\$1995
(List \$2829)

LTI BEATS TOP ATs IN PERFORMANCE TEST!

"The LTI is ideal for running large spreadsheets and maintaining large databases. The LTI is also well suited for running computer-aided design (CAD) programs. Not only is it one of the fastest ATs we've reviewed, IT IS ALSO ONE OF THE MOST AFFORDABLE." — PC RESOURCE Nov. 1987 AT Comparison Tests

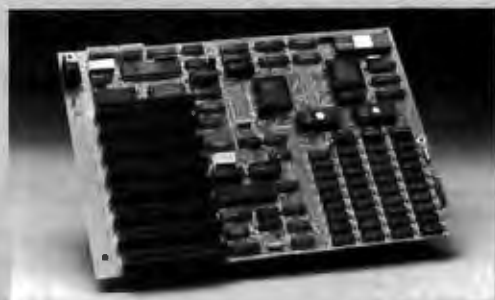

Upgrade your present PC, XT or AT with our 0-wait-state 7.2, 8, 10 or 12½ MHz motherboards
GAIN 820% TO 1530% SPEED INCREASE.
Prices start as low as \$259!

Call for your nearest dealer

Circle 468 on Reader Service Card

• 30 Day Money-Back
Guarantee

CTXT Systems, Inc.

• 1 Year Warranty on Systems
• 2 Years on Motherboards

9205 Alabama Avenue • Chatsworth, CA 91311 • (818) 341-4227 • **ORDERS ONLY**, call 1-800-872-2898, in California 1-800-438-2898

PC, XT, AT are trademarks of International Business Machines Corp

With *MapInfo*, All These Ways To Map Your Data . . . For \$750*



Pin Map. MapInfo can find addresses and plot your entire database on maps with detailed street information.

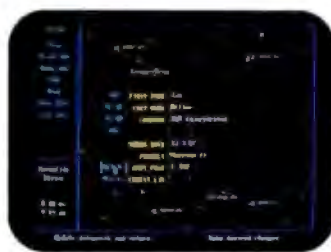

Database. For any point, call to the screen all the data behind the point. You specify the fields. Or use dBASE III files.

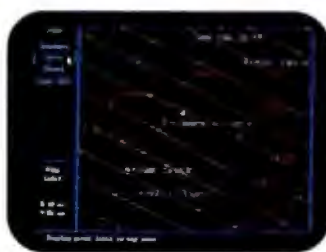

Label Points. Pick any field in your database to label points.



Boundaries. Town, county, zip available. Or draw your own — e.g., sales territories — and display the data within the boundaries.



Thematic. Shade boundaries — ours or yours — based on fields you select from your database, or the number of points found inside the boundaries.



Magnify. As close as 52 ft. across the screen. For dense databases or to see details.



Ultra Dense. For multiple occurrences at a single point, display a count of all the records behind the point.

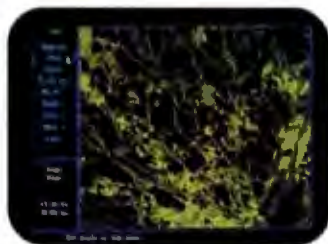

Zoom Out. As far as 5,000 miles! See your data across your city or the entire U.S.



The U.S. Assign data to state boundaries. States may be automatically shaded based on data within.

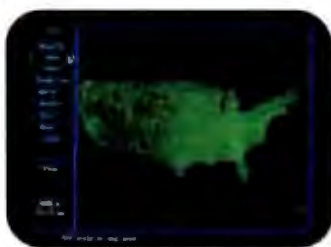

Counties By State. The boundaries are already available. Simply load your existing data.

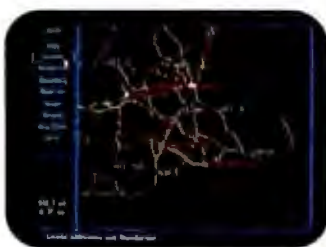

Highways. Overlay on local, state, or national maps all state, national or interstate highways.

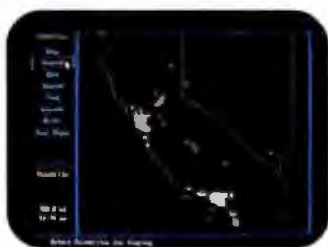

By Town. Display your data by town or boundary. Ideal for charting territories and analyzing sales data.

No matter what your application, if you need to display information on a map, MapInfo can do it. In more ways than you've imagined possible on a PC.



Highlighted Streets. Gives a nice, clean appearance to your maps for formal display.

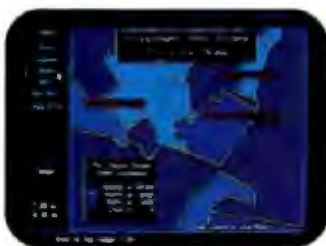

Customized Graphics. Add your own titles, legends, and text.



Draw Your Own. From floor plans to organization charts, use MapInfo for visual database applications.

Runs on IBM PC or 100% compatibles, with 640K memory, a hard disk, and graphics capability.

* MapInfo costs \$750 for the software system. Maps for hundreds of metropolitan areas across the U.S., complete with street names and addresses are also available starting from \$250. Maps of individual states with county lines, highways, or every town also available, starting from \$95.

IBM is a trademark of International Business Machines Corp. dBASE III is a trademark of Ashton-Tate

MapInfo Corp.

200 Broadway, Troy, NY 12180

To order, call 1-800-FASTMAP. (that's 1-800-327-8627)

In New York State, call 1-518-274-8673 (Telex 371-5584)

Circle 471 on Reader Service Card

MARCH 1988 • BYTE 88PC-7



16 color VGA Support

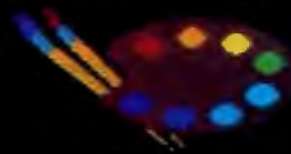

Dual Brush Modes



Smooth Command

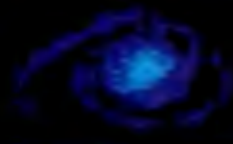

Airbrush Command

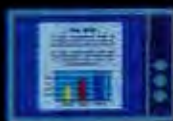

Grid Command

Additional Features

ENGLISH SPEAKING (NO ICONS)

FULL-SCREEN EDITING

DYNAMIC ZOOM (4X or 8X magnification)

EXTENSIVE AIRBRUSH CONTROLS

SMALL COMMAND (reduces files 50 to 90%)

AUTOMATIC PAN (page mode)

AUTOMATIC COLOR SMOOTHER MODE

SOPHISTICATED SLIDE SHOW (w/dissolve-maker)

XLATE UTILITY (translate between resolutions)

34 FONTS (with over 25 control combinations)

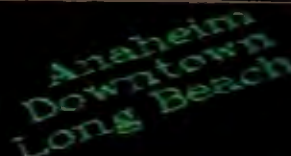

360° Rotate Command

3 & 4 Point Curve Command

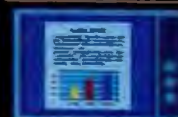

FullPage Printing

Screen Pan

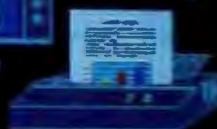

Capture almost any screen



PC QuikArt Support

One Picture Is Worth A Thousand Words!

Step up to state-of-the-art in EGA graphics generation technology. Our 2005 version is not just another paint program or another version of the "same old thing." EGA PAINT 2005 is a complete restructuring of our 2001 program (itself the recipient of the PC TECH JOURNAL award for excellence in program design). We believe the end-user comes first and instead of merely patching on more features (as all the others do) we went to a whole new (much easier and faster) way to create truly startling business presentations & EGA color illustrations. Take another look at some of our features (some of which are available only on programs costing hundreds more) and decide for yourself.

Also available from RIX:

EGA SCREEN ENHANCER

This easy to install device enables older EGA cards to utilize EGA PAINT 2005 in 640x480 & 752x410 resolution modes. Our ESE comes complete with a special test pattern diskette for only \$49.95 (+ \$5.00 for shipping and handling).

All this and more for just:

\$99.00

ORDER NOW!

in CA - (800) 233-5983 out CA (800) 345-9059



RIX SoftWorks, Inc.

18552 MacArthur Bl. Suite 375, Irvine, CA 92715

QMD

Presents

DESKTOP PUBLISHING

LASER PRINTERS  **HEWLETT PACKARD**
 HP Laser Jet II \$1699
 HP 1 Megabyte Memory Expansion Card \$399
 HP Toner Cartridge For Above Unit (Black) \$89
 Destiny Laser Act 1 SMB \$1595
 Tray & Fonts CALL

MONITORS
 Amdel 310A TTL Amber \$140
 Amdel 1280 795
 CTX EGA 352
 CTX RGB 225
 Mitsubishi 1371 EGA 585
 NEC Multsync JC-1401P3A 550
 Panasonic Mono Monitor Green 75
 Princeton LM300 Full Screen 1120
 Princeton SR-12P PGA 549
 Sony Multiscan CPD 1302 599
 Sony Multiscan TV/Monitor EV1311CE 479
 Tazara Color 650 599
 Thompson 4460 EGA 330
 Thompson Ultrascan 410
 Wyse 700 Full Page 799

CAD/CAM

PLOTTERS & DIGITIZERS
 Hitachi 11 x 11 Tablet \$540
 Roland DXY-980 with Digital Display \$1270
 Houston Instruments DMP-20 \$1680
 Summagraphics 1201 ps 5 stylus \$427
 HP Plotter 7475A \$1325
 Calcomp 1043 GT Plotter \$2295
 JDI, 8650 GL \$3190
 Numonics 5860 \$11100

COMPUTERS 
 386-20/40MB \$2299
 386-20/130MB \$6699
 386-20/300MB \$6799
 Portable 386-40 \$5649
 Portable 386-100 \$7049



 PS/2 Model 30 2 3 1/4" FDD (720KB) \$1199
 PS/2 Model 30 20MB & 1 FDD \$1609
 PS/2 Model 50 20MB & 1 FDD (1 4MB) \$2519
 PS/2 Model 80 40MB & 1 FDD \$4899
 Monochrome 2/Play 8503 178
 Color VGA 2/Play 8513 \$418
 Color VGA 2/Play 8514 \$499
 2 MB Expanded Memory Adapter \$909
 5 1/4" External Drive w/Adapter \$119

386 SYSTEM

386 Tower
 Special 1 Intel 386 AT motherboard desktop cabinet floppy drive keyboard Western Digital dual controller \$3890
 Special 2 Taiwan 386 motherboard (similar to Intel) 386 AT desktop cabinet floppy drive keyboard Western Digital dual controller \$3480
 Special 3 Taiwan motherboard package similar to Special 3 except lower cabinet \$3880
 Special 4 Taiwan 25 MHz 80286 Tower Cabinet includes 2 MByte on-board RAM expandable to 8 MByte \$3150

Additional Accessories
 Intel 2 MByte 32-bit RAM board \$725
 Intel 8 MByte 32-bit RAM board \$3860
 Taiwan 2 MByte 32-bit RAM board \$625
 Taiwan 8 MByte 32-bit RAM board \$2450
 Intel 80387 16 math coprocessor \$550
 Intel 386 AT has 90 days tac warranty
 Taiwan 386 has 1 year tac warranty



 (213) 474-3764
 800-553-3339 in CA orders only
 1-800-MICRO 86 (642-7886) in U.S.

QUALITY MICRO DISTRIBUTORS

West Coast Office 1851 W. Pico Blvd., Los Angeles, CA 90064 For Technical Service Call Watson Line (213) 470-8073 East Coast Office 313 Post Ave. Westbury, NY 11590 1-800-338-9444

MAXTOR • LOTUS • ZENITH • AST • NEC • HP • COMPAQ • IBM

ALTEC ZIP-386

\$2,265

- Intel 80386 microprocessor
- 1M high speed memory installed
- Expandable to 10 MB
- Phoenix 386 BIOS or Award 386 BIOS
- 4 speed (4.77/6/8/16 MHz)
- 200W power supply
- Case with reset button
- Enhanced keyboard
- Hard disk/floppy disk controller card
- 1.2M floppy disk drive
- Monochrome/Graphics card with printer port
- Hi-RES Monochrome Monitor
- User's manual
- 1 year warranty



ALTEC-286 Enhanced System

\$1,135

- Intel 80286-10 microprocessor
- 1M RAM
- Dual speed 6/10 MHz
- 200W power supply
- AT style case
- Enhanced keyboard
- Hard disk/floppy disk controller card
- 1.2M floppy disk drive
- Monochrome/Graphics card with printer port
- Hi-RES Monochrome Monitor
- User's manual
- 1 year warranty



ALTEC-XT Turbo System

\$ 575

- 80286-1 microprocessor
- 4.77/10 MHz
- 640K RAM
- 150W power supply
- AT style keyboard
- Multi I/O card
- 380K floppy disk drive
- Monochrome/Graphics card with printer port
- Hi-RES Monochrome Monitor
- User's manual
- 1 year warranty



ALTEC-286jr System

\$1,095

- Intel 80286-10 microprocessor
- 1M RAM
- 200W power supply
- AT style case
- AT style keyboard
- Hard disk/floppy disk controller card
- 1.2M floppy disk drive
- Monochrome/Graphics card with printer port
- Hi-RES Monochrome Monitor
- User's manual
- 1 year warranty



ADDITIONAL FEATURES

ADDITIONAL FEATURES	ADD
Case System	\$299.00
EISA System	\$499.00
286 hard disk	\$213.00 (286 & 386) \$295.00 (XT)
40K hard disk	\$405.00 (286 & 386) \$465.00 (XT)
286 & floppy disk drive	\$89.00
17" Hi-Res. Monochrome monitor	\$129.00
1.44 M 3 1/2" floppy disk drive	\$129.00



ALTEC Technology Corporation
 5751 Rickenbacker Road, Los Angeles, CA 90040
 Tel 1-213-888-9100
Order Desk: 1-800-255-9971

Intel is a registered trademark of Intel Corporation.
 Phoenix is a registered trademark of Phoenix Technologies Ltd.
 Award is a registered trademark of Award Software Inc.
 AT is a registered trademark of Intel Corporation.

LaserJet font Nirvana. Or your \$99.95 back.

Witness a LaserJet miracle.

Glyphix generates a dazzling variety of downloadable fonts from a set of four flexible typeface outlines.

Working with your PC, Glyphix makes creating a font as simple as picking an effect from a menu. Select sizes from 6 to 60 point. Choose from 14 different weights. Portrait or landscape. Condensed. Expanded. Slanted. Patterned. Shaded. The possibilities? Millions of them.

Microsoft Word, WordPerfect, Glyphix and our font managers: a match made in heaven.

Let our font managers free you from the Purgatory of using fonts with Microsoft Word® and WordPerfect®. Sorting through PRD files and printer drivers is a thing of the past.

Our managers build fonts right into Word and WordPerfect, giving you the freedom to change font as often as you like. Best of all, the font managers use Glyphix to create and download your fonts automatically, liberating megabytes of disk space from font storage. With a Glyphix font set and a font manager, you have an army of fonts at your fingertips.

If you're using Aldus Pagemaker® or Ventura Publisher®, you're ready to use Glyphix. (Any package that can read HP soft fonts can manage Glyphix fonts.)

GLYPHIX



Swfte

Software with capability. And credibility.

GLYPHIX			
HP			
Bitstream			
FONTS TO 60 POINT	YES	NO	YES
FONT SCALING	YES	NO	YES
DEGREES OF BOLD	2	2	14
PATTERNED FONTS	NO	NO	YES
300 x 300 DOT QUALITY	YES	YES	YES
TIME TO CREATE 30 POINT FONT	1:34	—	:16
PRICE	\$195 ⁰⁰	\$200 ⁰⁰	\$99 ⁹⁵

Let the Glyphix Basics lead you through the pearly gates.

The Basics is a collection of four typeface outlines, each representing one of the major lettering styles. Roman, our version of Times Roman®, is a classical serif face that has become a standard for body copy. Helvette, our version of Helvetica®, is a modern sans serif face designed for presentations and headlines.

Chancelor is a decorative face that reflects a cursive handwritten look. And rounding out the family is Rockland, a versatile square serif font that commands attention in headline and body copy.

The Glyphix Basics. The Glyphix Font Managers. Products that give your documents a look of celestial beauty. Order yours today.

Take me to Heaven!

- Send me the Glyphix Basics for \$99.95.
- Send me your MS Word Font Manager for \$79.95.
- Send me your WordPerfect Manager for \$79.95.
- Send me a catalog of all the Glyphix type collections.

Glyphix Basics:
Roman
Helvette
Chancelor
Rockland

Name _____ Telephone _____
Address _____
City _____ State _____ Zip _____

**ORDER TOLL FREE:
(800) 237-9383**

IN DELAWARE CALL (302) 733-0956

Include \$5.00 shipping and handling for one item. \$2.50 each additional item. Mail orders to SWFTE International, Box 5773, Wilmington, DE 19808. Money back guarantee is extended for 30 days from the date of sale.

A Totally New Concept in Digitizers That Offers You 3 Unprecedented Benefits!

DIGI-PAD PC™

1. Lowers The Cost Of Digitizers,
2. Eliminates The Power Supply & RS232 Cable And
3. Features A New, Lightweight Tablet Design.

Unbeatable Prices*

(*Includes tablet, controller, and stylus or 4 button cursor.)

11 x 11	\$599.
11 x 17	\$839.
17 x 24	\$1999.
20 x 20	\$1999.
24 x 36	\$2899.
36 x 48	\$3499.

All sizes available from stock.



DIGI-PAD PC brings high performance and low cost, without the clutter, to your CAD workstation.

The New DIGI-PAD PC Controller goes inside your computer, replacing the RS232 cable and the external power supply.

SAVE Up To 33%

GTCO's new PC compatible digitizers are as little as $\frac{2}{3}$ the cost of competitor's tablets. And they're available in 6 popular sizes, from 11 x 17 to 36 x 48.

Their lightweight design allows mounting to a variety of pedestals, tilt stands and wall mounted brackets.

Call us to enhance your system with
DIGI-PAD PC.

Circle 469 on Reader Service Card

GTCO Corporation
A Graphics Technology Company

7125 Riverwood Drive, Columbia, Maryland 21046
Phone: 301/381-0588 Telex: 898471 Fax: 301/290-8065

Complete and Easy...
and only \$16!



Parsons Technology

MONEY COUNTS[®]

VERSION 4.0

Complete Money Management/ Accounting System . . .

- CPA-designed for home & business
- Manages cash, checking, savings & credit cards
- Smart checkbook balancer — makes short work of the toughest bank statement
- Handles up to 999 accounts & 24000 transactions per year

Prepares & Prints a Wealth of Reports . . .

- Financial statements (4 types including net worth)
- Inquiry reports (3 types)
- General ledger & accountant's trial balance

Now Including . . .

- Automatic transactions
- Financial calculator — computes interest rates, loan payments, prints amortization schedules
- Journal entries
- And more

Plus These Important Additional Features . . .

- Budgeting
- Fast financial data base with 3-way look-up
- Pop-up calculator
- Graphics
- Works great with monochrome & color monitors
- Not copy-protected

VISA, MasterCard & COD orders call:

1-800-223-6925



(In Canada 319/395-7300)

Here it is. You won't find software that's easier to use:

- Requires no accounting knowledge
- Completely menu-driven with on-line help
- 93-page fully indexed tutorial manual (on disk)

A Proven Track Record. Hard to believe the \$16 price? Don't worry. MoneyCounts[®] has been marketed for three years and is continually receiving rave reviews. There's no catch. This is a fully functional system that compares with products selling for \$99 and more.

Same-Day Shipping. Order today and own MoneyCounts[®] for only \$16! Add \$3 shipping and handling (outside North America add \$7). Iowa residents please add 4% sales tax. Send check or money order payable to Parsons Technology. VISA and MasterCard orders welcome.

Dept. B
373 Collins Road NE
Cedar Rapids, IA 52402

\$16 + \$3 Shipping

MoneyCounts[®] requires IBM or compatible computer with two disk drives (or a hard disk drive), 192k or more memory, DOS 2.0 or later and printer

Name: _____

Address: _____

City/State/Zip: _____

Phone: _____

Check Money Order VISA MasterCard

Card # _____ Exp. Date _____

EXCLUSIVE COMPUTERS HEADQUARTERS TEK COMPUTER

THE VALUE LEADER IN COMPUTERS

**Guaranteed
When You
Buy**
LOWEST
PRICES ON
IBM • COMPAQ
• EPSON •
• TOSHIBA •
• NEC

SELECTION: We stock and sell products made by the world's largest and most trusted names in Computers, Printers and Software Manufacturers.

VOLUME: Since we have multiple locations and our overhead is low, we buy and sell an incredible volume.

EXPERTISE: Since we deal exclusively with EPSON, TOSHIBA, COMPAQ, IBM, we get special factory training giving us the know how nobody else has.

ATTENTION: Our job is not finished unless you are satisfied. You *must* be happy.

**Assurance
After You
Buy**
Service from
factory trained
technicians

• **Free Radio Watch \$19.95 Value** •

Buy 2 boxes of Janus diskettes at \$14.95 and get a digital watch and radio free

AST PREMIUM/286

- 80286 Processor
- 1.2 MB Disk Drive
- 40 MB HD
- Enhanced Keyboard
- Monochrome System

\$2249

MACINTOSH™

- MAC SE
2 Drives ***2149**
- MAC SE
1 Floppy 20 MB .2799
- MAC PLUS **1549**
- Apple Laser Writer .. **In Stock**

NOW HERE-IN STOCK

COMPAQ 386

20 MHz SYSTEM
Lmt. Quanties Available

MONTHLY LAPTOP SPECIALS

NEC Multispeed EL/20 MB ***1599/2450**
Toshiba 1000/1200/3120 w/2 MB HD ***875/2450/3199**

MONTHLY PRINTER SPECIALS

IBM PROPRINTERS TOSHIBA
X24/XL24 ***599/840** 321/341SL ***499/785**

Boards

IBM Mono Adapter ***99**
AST Six Pack 64K + Sidekick **149**
AST Advantage Expansion Board for AT
w/128K **349**
Vega Board by Video 7 Deluxe **275**
Hercules Graphics Plus **190**
Hayes 1200/2400B w/SW **349/399**
NEC EGA **430**
Migent Pocket Modem **159**
Everex Evercom 1/2 card 1200B **90**
Everex Evercom III 2400B **200**

Hard Cards

Plus Development Card 20/40 . ***599/899**
Omega Bernoulli Box IMS Disk Available

Hard Disks

20MB/30MB/40MB ***259/369/599**
40/80MB Hard Disk for AT **699/1099**
20MB/60MB Tape Back-Up **599/799**
120MB Hard Disk **2600**

Computers

IBM AT 339K ***3399**
IBM Sys 2 Model 25 **945/1190**
IBM Sys 2 Model 30 **1275/CALL**
IBM Sys 2 Model 50 10 MHz, 20 MB **2624**
IBM Sys 2 Model 60 10 MHz, 44 MB **3499**
IBM Sys 2 Model 80 40/70 **CALL**
COMPAQ Port 2 Dr **1545**
COMPAQ Port II 1 Dr/20 MB **2899**
COMPAQ Port III 40/20 **CALL**
COMPAQ 286 Desk Pro 12 MHz **1949**
COMPAQ 386 Mod 40/70 **4499/5499**
AST Premium
All Models Available **Best Price**

Software

Lotus 1-2-3/Hal/Metro ... ***309/120/85**
Symphony **410**
Framework 2 **365**
D Base III+ **395**
WordPerfect 4.2 **219**
Microsoft Windows **69**
Microsoft Excel **CALL**
Xerox Ventura Publisher **499**

Aldus Pagemaker **465**
Multimate Advantage II **440**
Ability/Enrich by Migent **LOW**

Printers

Okidata 292/293 ***425/599**
Epson 850/1050 **545/745**
Epson LQ800/1000 **469/549**
Epson LX86/FX85 **199/349**
Epson EX800/1000 **498/549**
Epson LQ2500 **1099**
Epson FX88E/FX286E **359/475**
IBM Proprinter II **399**
IBM Quietwriter III **1299**
NEC Laser Printer **3895**
HP Laser Jet II **1699**

Monitors

IBM Color Monitor 8513 PS/2 ***512**
IBM Mono Monitor 8503 PS/2 **200**
IBM Color Monitor 8512/8519 **485/1196**
Princeton SR12P **CALL**
NEC Multisync II **575**
Sony Multiscan **629**
Amdek 410A/422 **159/489**
Samsung RGB/EGA **299/369**

2740 El Camino Real
Santa Clara, CA 95051

139 Kearney (and Market)
San Francisco, Ca 94108

(408) 296-0455

FAX
(408) 296-7499

(415) 362-6870

All Good While Quantities Last • Prices Subject To Change • Cash Prices

Compaq is a registered trademark of Compaq
IBM is a registered trademark of International Business Machines

SAVE 15%

on these new computer books and software from McGraw-Hill
CALL TOLL-FREE 1-800-2-MCGRAW

INTRODUCING PC-DOS AND MS-DOS

By T. Sheldon. 374 pp., illus., softbound. Find out about the free advanced capabilities of DOS and how to use them. "Wonderfully enlightening . . . well-written . . . my pick for technical book of the year."—*Online Review* 056559-7. Regular Price: \$18.95. **Your Price: \$16.10.**

INTRODUCING UNIX™ SYSTEM V

By R. Morgan & H. McGilton. 480 pp., illus., softbound. Guides you step by step through the facilities, commands, utilities, and applications of System V, AT&T's new version of the UNIX operating system. 043152-3. Regular Price: \$19.95. **Your Price: \$16.95.**

UNIX™ UTILITIES: A Programmer's Guide

By R. S. Tare. 640 pp., illus., softbound. Save time and effort with popular UNIX utilities! Helps you write efficient, bug-free programs and significantly reduce turnaround time. 062884-X. Regular Price: \$24.95. **Your Price: \$21.20.**

HOW TO BE A SUCCESSFUL COMPUTER CONSULTANT

By A. R. Simon. 256 pp., illus., softbound. Everything you have to know to set up and run your own computer consultant (or software development) business, full- or part-time. No business experience required! 057296-8. Regular Price: \$18.50. **Your Price: \$15.70.**

dBASE DEMYSTIFIED: dBase II/III/III Plus™ Applications and Solutions to Real Problems

By L. Barnes. 288 pp., 120 illus., softbound. Covers the full range of dBase features and shows how to apply the various releases of dBase to real-world problems. 003844-9. Regular Price: \$19.95. **Your Price: \$16.95.**

BUILDING YOUR FIRST EXPERT SYSTEM

By T. Nagy, D. Gault, & M. Nagy. 293 pp., book/disk (IBM PC and compatibles). How to easily create your own working expert system. A book/disk combination ideal for beginning programmers. 912673-1. Regular Price: \$19.95. **Your Price: \$16.95.**

GETTING THE MOST OUT OF YOUR EPSON PRINTER

By D. A. Kater & R. L. Kater. 224 pp., 170 illus., softbound. The A to Z of the popular Epson printer and how to make maximum use of it. Covers the full line. 033385-8. Regular Price: \$19.95. **Your Price: \$16.95.**

dBASE III PLUS™ TRAIL GUIDE

By H. Dickler. 350 pp., book/disk (IBM PC and compatibles). Follow this step-by-step trail and learn dBase III Plus in one week! With valuable programs you can modify and use over and over again. 912709-6. Regular Price: \$29.95. **Your Price: \$25.45.**

A COMPREHENSIVE GUIDE TO AI AND EXPERT SYSTEMS

By R. I. Levine, D. E. Drang, & B. Edelson. 256 pp., 99 illus., softbound. All about artificial intelligence and how to utilize it on your personal computer. Gives you everything from basic concepts to sophisticated programming techniques. 037470-8. Regular Price: \$19.95. **Your Price: \$16.95.**

MICRO-EXPERT

By B. Thompson & W. Thompson. 74 pp., book/disk. Become an instant expert with the world's most widely used expert system shell. Includes its own source code so you can tailor it to meet your needs. "Highly recommended."—*Online Today* IBM PC (and compatibles): 852109-2. Apple II (all models): 852110-6. Apple Macintosh: 852138-6. Regular Price (all versions): \$49.95. **Your Price: \$42.45.**

For fast service call TOLL-FREE
1-800-2-MCGRAW or use coupon below. 15-day
examination period.



McGraw-Hill Book Company
P.O. Box 400, Hightstown, NJ 08520

Please send me—at 15% off the regular price—the products whose code numbers (the number before the regular price in above blurb) I have checked below. I understand I have 15 days for free examination before I send payment for those products I want to keep (plus postage, handling, and local tax) and return any unwanted products postpaid.

- | | | |
|-------------------------------------------|-------------------------------------------|-------------------------------------------|
| <input type="checkbox"/> 056559-7 \$16.10 | <input type="checkbox"/> 003844-9 \$16.95 | <input type="checkbox"/> 037470-8 \$16.95 |
| <input type="checkbox"/> 043152-3 \$16.95 | <input type="checkbox"/> 912673-1 \$16.95 | <input type="checkbox"/> 852109-2 \$42.45 |
| <input type="checkbox"/> 062884-X \$21.20 | <input type="checkbox"/> 033385-8 \$16.95 | <input type="checkbox"/> 852110-6 \$42.45 |
| <input type="checkbox"/> 057296-8 \$15.70 | <input type="checkbox"/> 912709-6 \$25.45 | <input type="checkbox"/> 852138-6 \$42.45 |

Name _____

Address _____

City _____ State _____ Zip _____



EPSON
(An Epson-Wide Protection Plan)

EQUITY I+

- 360K Floppy
- 20 Meg Hard Disk
- 640K Ram
- Serial/Parallel Port
- Monochrome Card
- Monochrome Monitor
- MS DOS
- GW Basic

\$1295

EQUITY III+

- 80286 CPU 6-8 10 MHz
- 1.2 MEG Floppy
- 30 MEG Hard Disk
- DOS 3.2 Mono Monitor & Graphic Card

\$2595

EQUITY II PLUS

- 1.2 Meg Floppy
- 40 Meg Hard Disk
- 640K Ram
- Serial/Parallel/C/G
- 80286 CPU
- Monochrome Monitor
- Graphic Card
- MS DOS
- GW Basic

In order to provide the best service,
EPSON EQUITY is
exclusively sold on location.

**LOW
PRICE
LEADER**

LEADING EDGE 
MODEL "D"™

**CALL FOR
NEW LOW
PRICES**



ALL Configurations In Stock!

NEW IMS Bernoulli Dual Speed

MODEL "D" IS A REGISTERED TRADEMARK
OF LEADING EDGE PRODUCTS, INC

Authorized Dealer Service Center

COMPAQ

Desk Pro 20 meg	1495
286 30 meg	2875
386 40 meg	4335
386 60 meg/20 MHz	5650
Portable III 40 meg/20 MHz	5450
CARD & MONITOR EXTRA	

IBM

PS/2 model 30/20 meg	1695
PS/2 model 50/20 meg	2695
PS/2 model 60/40 meg	3595
PS/2 model 60/71 meg	4595
PS/2 model 80/40 meg	5100
MONITOR EXTRA	

LAP-TOP

Toshiba 3100-20	Call
Toshiba 1000	Call
NEC Multispeed	1395
NEC Multispeed EL	1695

WE STOCK

CITIZEN
OKIDATA

TOSHIBA
NEC

PRINCETON GRAPHICS
SONY

AMDEK
HAYES

PC MOUSE
MICROSOFT MICE

IRWIN & ARCHIVE
TAPE BACK

HARD DISK

Seagate 20 meg	305
Seagate 30 meg	365
Seagate 4038	495
Seagate 251	465

SOFTWARE

Microsoft Word	215
Word Perfect 4.2	215
Lotus 1-2-3	325
dBase III+	385
Microsoft Works	135
AND MANY, MANY MORE!	



NOVELL

Authorized Dealer
Netware

AST

AST 286 model 80	1495
AST 286 model 120	2350
AST 286 model 140	2650
CARD & MONITOR EXTRA	

**EPSON
PRINTERS**

Epson FX86E	315
Epson 286E	448
Epson EX800	425
Epson EX1000	499
Epson LX800	210
Epson LQ800	405
Epson LQ1000	549
GQ3500	1295
Epson LQ850	550
Epson LQ1050	725
HP LASER II	1750

WE ACCEPT LC, CASHIER CHECKS, MONEY ORDERS, VISA, MC, AmEx
3% charge on VISA, MC & American Express

COMPUTER LANE

HOURS:
M-S 10-6

(818) 884-8644

22107 ROSCOE BLVD.
CANOGA PARK
½ BLOCK W. OF TOPANGA
CA 91304

CORPORATE ACCOUNTS WELCOME
CALL FOR VOLUME DISCOUNTS

Prices subject to change without notice

Compaq is a Registered Trademark of Compaq
IBM is a Registered Trademark of International Business Machines

Leprecard disk cards



from
\$339

FAST As low as 28ms. average access times.

Big Up to 49 megabytes formatted storage.

LOW POWER Just 10 watts total power consumption. This means lower operation temperatures and longer component life.

QUALITY Leprecards feature controllers & drives made by the biggest names in the business — Western Digital, Seagate & Miniscribe. 1 year warranty & 30 day money back guarantee assure your satisfaction.

FREE SOFTWARE including **TakeTwo**, the backup utility named PC MAGAZINE Editor's Choice two years in a row!

GET IT FAST — FEDERAL EXPRESS standard add \$10.

MINISCRIBE

20MB/60ms.	30MB/50ms.	20MB/30ms.	30MB/28ms.
\$339	\$349	\$399	\$379

SEAGATE

Tandy 1000 Leprecards add \$20

1200 internal modem

\$69



- Short Slot size
- 300 or 1200 bps speed
- Hayes Smartcom II compatible
- Line-busy detect and auto redial
- MIRROR II software, a \$69 Value!
- Made in USA by Franklin Telecom
- 1-year warranty

1200 External with Mirror II \$99

768K mini ems

\$179



- 768K of 120ns RAM
- Lotus-Inter-Microsoft compatible
- Can backfill to 640K, remainder as EMS
- Short slot card
- 1 MB piggyback board option \$169
- Pop-up window print spooler, and RAM disk software

Circle 482 on Reader Service Card

3 1/2" floppy kit

TakeTwo



Instant Laptop & PS/2 compatibility. All kits include bracket to mount in 5 1/4" drive bay, black & grey face plates, and mounting rails. 144MB XT kits include replacement floppy controller that doubles the data transfer rate.

Now included: **TakeTwo**, the backup utility PC MAGAZINE named as their Editor's Choice. Now you have a fast, affordable backup solution that brings you media compatibility with the latest IBM PS/2 systems.

720K Internal for PCXT/AT, \$119

- Requires DOS 3.2 or optional \$15 driver software

1.44MB internal for AT only, \$149

- Includes driver software

1.44MB Internal for PCXT, \$249

- Floppy Controller & cables with 500,000 bit per second data transfer rate. Supports two drives.

External Case for XT kits add \$99

PC/XT hard disks

- Drive & Controller pretested & formatted
- Genuine Western Digital Short slot controller
- 30 page installation guide & reference manual
- Cables, mounting screws, full & half-height benches
- **TakeTwo** Backup Software, PC MAGAZINE Editor's Choice
- 1 year parts and labor warranty
- 30 Day Money Back Satisfaction Guarantee
- Optional: 150 watt, UL/FCC approved power supply \$69

Tandy 1000 kits add \$20

Shamrock

2524B Townsgate Rd., Dept B
Westlake Village, CA 91361
TOLL FREE 800-722-AT-XT
California 805-373-7847

No extra for Visa/MasterCard
Prices include UPS Shipping & Insurance
30-Day Money-Back Guarantee
Corporate & Institutional PO's accepted

Paradise Autoswitch 480



\$199

- EGA, CGA, MDA, & Hercules Compatible
- Short Card, 5.25" long
- 2-year warranty
- 640x480 resolution
- 132-column Lotus 1-2-3, Symphony, etc
- EGA480 & NEC MultiSync II \$768

WESTERN DIGITAL

TakeTwo



20 MB Kits

\$289

- Seagate ST225—214 MB/65 ms/Half-height/14.8 Watts

30 MB kits

\$329

- Seagate ST238—315 MB/65 ms/Half-height/14.8 Watts

40 MB kits

\$487

- Seagate ST251—428 MB/Half-Height/11 Watts
- Pre-formatted into a pair of 21MB partitions, 28ms.

40 MB kits

\$399

- Miniscribe 3650—42.2MB/Half-Height/18 Watts
- Pre-formatted into a pair of 21MB partitions, 42ms.

65 MB kits

\$599

- Seagate ST277R—65.5 MB/Half-Height/11 Watts
- Pre-formatted into a pair of 32MB partitions, 28ms.

2400 MNP modems



\$239

- Hayes Compatible
- 300/1200/2400 Speeds
- MNP level 4 error correction increases throughput up to 20%
- Automatic Adaptive Equalization
- Non-volatile memory retains configuration
- MIRROR II Software, a \$69 value
- Internal fits in short slot
- PCXT/ATPS2 Modem Cable \$15 (specify model)

FAX Modem



\$499

- 9600 bps Operation
- CCITT Group 3 compatible
- Send ASCII or word processing files
- Background receiving
- Unattended sending & receiving
- Prints on Epson or Laserjet compatible printers
- Use as 9600 bps synchronous modem with other FAX/96 modems
- Requires 512K, Hard Disk, DOS 3.x, & Hercules mono or color graphics adapter

30MB filecard



\$399

- 32 Mega-bytes, 62 msec Access
- Low power consumption, 12 Watts
- High Speed WD RLL Controller
- XTREE, & SpeedRead Disk Cache software
- Requires 1 1/2 slots
- **TakeTwo** backup software

Miniscribe ScribeCard 32 for Tandy 1000 \$419

AT hard disk drives

- Includes AT mounting rails, & data cable
- **SpeedStor** or **OnTrack** large drive software
- Formatted, Partitioned, & Tested

Size	Model	Speed	Capacity	Price
HH	Seagate ST251	40ms	42.8MB	\$439
FH	Seagate ST4053	28ms	44.5MB	\$599
FH	Seagate ST4096	28ms	80.2MB	\$888
FH	Micropolis 1335	28ms	71MB	\$849
FH	Maxtor 1140	27ms	117MB	\$1849
FH	Maxtor 2190	30ms	150MB	\$2099

Now You Have A Friend In The Computer Business*

Authorized Autocad and Novell Dealer
6 Good Reasons To Buy

<p style="text-align: center;">1</p> <p>COMPAQ 286-12</p> <p>640K, 1.2 floppy, 40 MB HD monochrome system</p> <p>\$2895 IN STOCK 386/20 mhz</p>	<p style="text-align: center;">2</p> <p>AST PREMIUM 286</p>  <p>512K RAM, 1.2 Floppy, 40 MB Fast HD, hi-res mono card, mono monitor, DOS 3.2, CTW Base</p> <p>\$2195 Call for all AST products!</p>	<p style="text-align: center;">3</p> <p>WYSE 286 System</p> <p>512K RAM, 1.2 floppy, 40MB HD full monochrome system</p> <p>\$2179 IN STOCK! WYSE 386/WYSE Terminals</p>
<p style="text-align: center;">4</p> <p>LAPTOP SPECIALS</p>  <p>NEW TOSHIBA T-1000 \$849</p> <p>NEC Multispeed EL \$1695 NEW! ZENITH 181/183-20 \$1649/2490</p>	<p style="text-align: center;">5</p> <p>LEADING EDGE COMPUTERS</p>  <p>Model D Full Mono System \$1295</p> <p>Authorized Leading Edge Dealer</p>	<p style="text-align: center;">6</p> <p>ACER 710/910 SYSTEMS</p>  <p>(Formerly Multitech) 512K memory, 20 MB HD, 6/10 U wait state full mono system</p> <p>IN STOCK! Call for Best Price</p> <p>Acer 386 machine</p>

We carry a full line of HP, IBM, Intel, Diconix products at best prices in town.

SOFTWARE SPECIAL

Word Perfect \$194
Microsoft Word 209
Lotus 305
Call for any software—we deliver it to you in
24 hours!

PRINTER SPECIAL

Epson LX800 \$189
Epson EX800/1000 489/489
Epson LQ800/1000 459/569
Epson LQ2500 899
Epson LQ850/1050 IN STOCK
NEC P6/P7/2200 414/615/415
Toshiba P321SL/P351SL IN STOCK
HP Laser Jet Series 2 CALL

Substantial return and service loans. Free consultation. Carry-over carry-out, pick-up drop.
Call us for Service Contract information.

**We Sell, Deliver,
Install, & Repair**

Registered trademark of Alcatel-Lucent, Mountain View, CA
IBM is a registered trademark of International Business Machines, Inc.
Novell is a trademark of Novell Systems, Inc. & Communications
Compaq is a trademark of Compaq Computer & Communications
Epson is a registered trademark of Epson America, Inc.

All prices subject to change or availability without notice.

AUTHORIZED DEALER FOR

Novell Systems
Epson Computers & Printers
Samsung
Zenith
Toshiba
Wyse Computers
AT&T
Autocad
Novell (Network) Plus
Leading Edge

Computown Pleasant Hill

1527 Contra Costa Blvd.
Pleasant Hill, CA 94523

(415) 634-TOWN

(415) 634-8696

NEW LOCATION!

Computown-Mountain View

2455 M Old Middlefield Way
Mountain View, CA 94043

(415) 962-TOWN

(415) 962-8696

Computown-San Francisco

760 Market Street, Suite 219
(Phelan Building)
San Francisco, CA 94102

(415) 956-TOWN

(415) 956-8696

FAX (415) 989-TOWN



COMPUTOWN



To 27 million Americans, this scene is a fairy tale.

That's because 27 million American adults can't read a child's bedtime story, can't read a street sign, can't read...period.

Functional illiteracy has become an epidemic, an epidemic that has reached 1 out of 5 American adults. It robs them of a decent living, it robs them of self-respect, it robs them of the simplest of human pleasures...like reading a letter from a friend or a fairy-tale to their children.

Tragic as that is, it's not the worst part. Because people like this could be taught to read, if we had more tutors to teach them. Sadly, we don't. Today, the waiting period for a tutor can be up to a year.

You can change that by joining the fight against illiteracy yourself. It takes no special

qualifications. If you can read, you can tutor or help us in countless other ways. You'll be trained to work in programs right in your own community. And you'll experience the greatest satisfaction of all...the satisfaction of helping people discover whole new lives.

So join the effort. Call the Coalition for Literacy at toll-free **1-800-228-8813**. Helping takes so little. And illiteracy robs people of so much.

Volunteer Against Illiteracy.
The only degree you need
is a degree of caring.

Ad
Council

 Coalition for Literacy

SHORT TAKES

BYTE editors offer hands-on views of new products.

A New SideKick

Experienced SideKick users will feel like kids in a candy store when they begin using **SideKick Plus**. The program is so packed with features that Borland's biggest problem may well be convincing current SideKick customers that the program is in fact a completely new program, not simply an upgrade of an existing product. Comparing the nearly 400-page SideKick Plus manual needed to document the program with the original 86-page SideKick manual underscores this.

SideKick Plus (SK+) has a memory-resident Notepad (text editor), a Calculator, and an ASCII table. Although greatly expanded in capabilities, these modules, and many other SK+ features, should be familiar to current SideKick users. However, SK+ also includes a disk organizer (File Manager), an outline processor (Outlook), a calendar (Time Planner), and a full communications package (Phonebook). The program is modular in that you can customize SK+.

To save on memory and enhance performance, I set up my version to include only the applications I thought I'd use the most—File Manager, Notepad, Phonebook, and Calculator. Using a standard IBM PC with a Plus Hardcard 20, I focused on those features that I frequently use—the text editor and communications module.

There were two things that I particularly liked about the SK+ Notepad: the ability to have up to nine windows open at a time, and the size of the files that you can have in each window (up to 54K bytes). I loaded nine chapters of a project I'm currently working on (the largest chapter was 49K bytes), switched from one chapter to another (by pressing F6),

continued



The Facts:
SideKick Plus
\$199
\$69.95 for upgrade

Borland International
4585 Scotts Valley Dr.
Scotts Valley, CA 95066
(408) 438-8400
Inquiry 859.

Requirements:
IBM PC, XT, AT, or
compatibles, or IBM PS/2;
DOS 2.0 or higher, 384K
bytes of RAM, and a hard
disk drive.

SIDEKICK PLUS COMMAND SUMMARY

File Manager

Directory (for any disk or path), Search (for files or text strings within files), Mark Entries (for further processing), Copy, Delete, Move, Rename, Print, (change) Attributes, View (files), Prepare (format) Disk, Create Directory, Order (sort directories)

Notepad

File, Reformat, Search, Block, Insert, Delete, Go to, Marker, Options, Insert Mode, Auto Indent, Graphics, Hard Tabs, Margin Release, Right Margin, File

Outlook (outliner)

Line Spacing, Indent, Hidden Text, Attached Notes, Structured Output; also, all the Notepad's commands

Phonebook

Search (for entry), Attach Note, Edit Entry (uses the Notepad's commands), Insert Entry, Delete Entry, Communications (a full telecommunications module), Glossary, Print, Options, New Phonebook

Time Planner

New Book, Search (for an entry), Insert, Edit (uses the Notepad's commands), Print, (set) Alarm, Resolution (set appointment book's increments, in minutes), Begin Day, End Day, Default Times, Go to

Calculator

Edit Tape, Variables, Functions, Memory, Block, Options, Type (of calculator: Scientific, Business, Programmer, Formula)

ASCII Table

Control Characters, Edit Paste Buffer, Paste Options, Go to

Services

Edit Clipboard (uses the Notepad's commands), Window Control, Copy from, Paste from Clipboard, Quick Paste, Setup, Memory Sizes, Unload SideKick Plus

Vogon Poetry

A just-for-fun item. In the beta version we tested, this command (from the opening menu) called up a game—a clone of Space Invaders.

edited them, and copied and pasted text without any problem. At the same time, I loaded the same 49K-byte file into WordStar 3.3, and I found that I could move around the file faster with Notepad than with WordStar. (Executing a Control-Q-C to get from the top to the end of the file took SK+ about 2 seconds; with WordStar, it took about 9 seconds.)

The system Clipboard made it very easy to cut, copy, and paste information between SK+ applications. A feature called Quick Paste, which bypasses the Clipboard, let me paste text directly to the current cursor position in the WordStar file. The Notepad also uses WordStar-like dot commands and Control-key sequences to support almost all standard word-processing features.

The Phonebook is a powerful communications program that supports background communication, auto-log-on, scripts, and other advanced features. Its Learn feature was nice; I easily created a BIX log-on script by turning Learn on, going through the standard dial-up and log-on sequence, and turning Learn off. I then edited the script to delete everything but prompt and response statements before finally activating it. It worked fine the first time. To test background communication, I logged onto a remote bulletin board system and, using XMODEM CRC protocol, downloaded a 7K-byte file. During the download, I switched back to DOS, loaded

WordStar, created and edited a document, then switched back to my background downloading. It worked great, and the complete file was received with no errors. Although background communication capability uses about 20K extra bytes of RAM, I know I'll use it a lot.

One SK+ feature that users may find troublesome is that the program is complex and has a confusing array of features that you can reach from Control-key sequences, function keys, and menus. You'll have to decide for yourself if the complexity of the program is worth the effort; I think it is.

Another feature I found bothersome was the length of time it takes SK+ to appear on the screen—about 4 seconds to load and another 4 seconds to unload. The reason for the time delay is the method used to swap resident applications and data on and off the disk. There are ways to speed up the loading process, including an installation option that eliminates disk swapping, the use of a RAM disk or an Above Board, or the creation of an abbreviated customized version of the program (my option). Borland also indicated that speed optimization will continue to be a prime objective.

Overall, I think I'll be one of many dedicated SideKick users who give up the simplicity of the original program for the power of SideKick Plus.

—Jonathan Erickson

Lotus's Outliner/Word Processor



The Facts:

Manuscript 2.0
\$495
(Pre-2.0 copies purchased on or after December 1, 1987 can be upgraded to 2.0 for free. Copies purchased before that date can be upgraded for \$75.)

Lotus Development Corp.
55 Cambridge Parkway
Cambridge, MA 02142
(617) 577-8500
Inquiry 854.

Requirements:

Runs on MS-DOS computers (version 2.0 or higher) with at least 512K bytes of RAM, a hard disk drive, and a 5¼-inch or 3½-inch (1.44-megabyte) floppy disk drive; works with CGA, EGA, VGA, Hercules Monochrome, InColor, Toshiba T3100, and Compaq Portable III displays. Includes software drivers for most popular dot-matrix and laser printers.

Manuscript 2.0 is easier to use, more powerful, and faster than version 1.0.

Word-processing additions include macros; named text libraries for rapid insertion of boilerplate copy; multiline headers and footers; inclusion of Microlytics' Word Finder thesaurus, with definitions as well as synonyms; a new spelling checker from SoftArt, and integration of spell-checking with the editor rather than as an external utility; the ability to see page breaks while in the editor; sorting of tables, using any column as the sort key; and automatic saving of an edit document at predefined time intervals. You can include Lotus 1-2-3 worksheets in a document by file reference and update them by command (the latest numbers from a worksheet are read into the document).

Formatting and printing the six-page sample document, which contained three graphs, two equations, and two tables, took 59 seconds with version 1.0, while a prerelease version of 2.0 took 47 seconds. The final version will be still faster, according to Lotus. (Lotus reports it plans to ship Manuscript 2.0 in the first quarter of this year.)

Previewing is also faster in version 2.0, thanks to an intermediate storage format for graphics images and changes in the product's overall memory management scheme. The edit document now remains in memory while the editor, print formatter, and previewer are swapped in and out.

Manuscript 2.0 also includes some major enhancements and new features in the area of page layout and format: winding columns of text (one to nine columns); financial tabs, so numbers are properly aligned even when followed by symbols such as percent and minus signs; named blocks; full user control of parameters for hyphenation and microjustification; and logic for page and column breaks.

I think Manuscript 2.0 should have broad appeal as a complete editing and layout system for large documents. It looks like a workable alternative to the traditional approach of using typesetting and layout services to create printable documents.

—George A. Stewart
continued

CONNECT.



OCR SCANNING

Our "SCANNING CONNECTION" system can be used to read your paper documents into a PC. Pictures and graphs can be scanned and saved in various file formats for use by many word processing and desktop publishing systems. Text images can be converted to character text for use with most word processing and typesetting systems. Images can be sent over telephone lines to another PC or a facsimile machine.

We have developed a special controller card for high speed compression of images and for character recognition. Books, magazines, newsprint, reports and typed documents can be read by our OCR software. The software can be trained to recognize almost any font style. System prices including scanner and software start at \$1795.

Circle 313

"JOIN" FLAGENG for vendor support on BIX!

9-TRACK TAPE

With our "TAPE CONNECTION" system you can read and write most 1/2" 9-Track magnetic tapes using your PC. Tapes can be 800, 1600, or 6250. Our file transfer software can process ANSI labeled tapes from most computer systems including DEC, HP, HONEYWELL, and IBM. Large files from multivolume tape reels can be transferred to a disk at rates up to 5 MB/min. Software is provided to use the system for backup of the hard disk on your PC.

With more than twenty years experience in working with tape drive systems, we can solve most PC tape conversion problems. We can supply more than ten different tape drive models. System prices including tape drive, controller card, and software start at \$3495.

Circle 314

E **FLAGSTAFF
ENGINEERING**

DISKETTE CONVERSION

We specialize in conversion systems and can transport your documents or images to almost any computer, word processing, or typesetting system. With our "DISKETTE CONNECTION" system you can read and write most 8", 5 1/4", or 3 1/2" diskettes using your PC. We support systems from DEC, CPT, WANG, NBI, LANIER, HONEYWELL, and XEROX. We support most IBM systems including 3741, 5/36, PC/36, 4300, and Displaywriter.

Since 1981 we have developed hundreds of software programs and designed many specialized diskette hardware products. With thousands of installations worldwide, we are probably the world leader in manufacturing diskette conversion systems. System prices including diskette drive, controller card, and software start at \$1195.

Circle 315

Circle 316 on Reader Service Card for Dealers.

1120 Kalbab • Flagstaff, AZ 86001 • 602-779-3341

Compusol-Europe • 12 Rue Rosenwald • 75015 Paris • Tel 530.07.37 • Telex 205431P • Telex U.S.A. 705609

To: All persons who missed last month's advertisement on the same subject. Also, to those who read it, and ought to have done something about it, but didn't.

Subject: GUI5

- Data: 1. **Scanner Model 321**
 --specially designed for **FAX USE**
 Easy to write software for
 --also suitable for **DTP** (high cost-efficiency at under US\$1K)
2. **Fax Card**--to use w/Scanner 321 or alone (under US\$0.8K)
3. Also, **TellerFax 207**--Stand-alone G3, linkable with PC for max. flex.'y
- * **TellerFax** now has desktop file conv. cap.'y

..... Dist + OEM appl' all welcome

To: All those of Memo 1, plus all others

Subject: GUI5 - New product

- Data: 1. **LaserFax** (9600 bps, G2/G3)
 2. Linkable with PC for max. flex.'y (incl. **DTP**)
 3. **Plain paper** laser printer
 4. Retailing at under US\$4.5K

Suggested Action: Contact GUI5 below

P.S.: CeBIT'88, Hannover, March 16-23, 1988
 booth B45 (Hall 16)
 WCC, Chicago, March 28-31, 1988
 booth 6419

GUI5

A Little Giant in Telecommunications

Glorious Union Information Systems Inc.
 14th Floor, 207 Tun-Hwa North Rd.,
 Taipei, Taiwan, R.O.C.
 TEL: 2-7153356 2-7168035
 TLX: 22651 GUI5 FAX: 2-7134572

Agent in the Netherlands:
 Hy-Test Europe B.V.
 Edisonstraat 15 1/2
 2723 RS Zoetermeer
 Netherlands
 TEL: (31)79-418841 FAX: (31)79-423973

Search and Cut/Paste Facility for dBASE Files

City	St-Zip	U-Rec	Populat
L ANGELES EAST			
EAST LOS ANGELES	Ca 90822	213	118017
LOS ANGELES	Ca 90052	213	2960579
EAST LANSING	Mi 48823	517	40309
EAST ORANGE	NJ 87819	281	77878
SAN ANGELO	Tx 76901	915	73248
EAST CLEVELAND	Oh 44112	216	36957
EAST MOLINE	Il 61244	389	28987
EAST ST. LOUIS	Il 62281	618	55288
LAUDERDALE LAKES	Fl 33313	385	25426
WALLA WALLA	Wa 99362	589	25618
HUNTINGTON STATION	Nv 11746	516	28769

The Facts:

Friendly Finder
 \$99

Proximity Technology Inc.
 3511 Northeast 22nd Ave.
 Fort Lauderdale, FL 33308
 (305) 566-3511
Inquiry 856.

Requirements:

IBM PC, XT, AT, or
 compatibles with DOS 2.0 or
 higher (DOS 3.0 required
 with the IBM PC AT); 75K
 bytes of free memory; hard
 disk drive (recommended).

If you've ever needed information from a database while working in another application, you know that exiting the application, opening the database, and then finding the record can be frustrating.

Using the patented search algorithm Proximity-Scan, **Friendly Finder** lets you search and retrieve information from dBASE files while working in other applications. Friendly Finder also works with fixed-length ASCII files, but it's primarily for use with files in dBASE format (DBF). You can use Friendly Finder with other database programs, such as Paradox or R:base, by first converting the data to DBF format, but then you have to reconvert your data every time you update the database.

You can run Friendly Finder from the DOS prompt, but you would probably want to operate it in memory-resident mode (it takes up 75K bytes); this is really more useful because you can then access databases from within other applications.

To invoke Friendly Finder in memory-resident mode, you press the default key combination Control-Right-Shift, or any other combination that you specify. Friendly Finder appears in a small window at the top of your screen with a list of available databases. You select the database you wish to search and enter your query. Friendly Finder finds all records that match the string in your query. Once you've found the record (or records) you're looking for, you can paste the data into your application, one field at a time.

I tested Friendly Finder on an XT with an Orchid Turbo-EGA card and an Intel Above Board. With the Above Board, I was able to copy my database files to a RAM disk in expanded memory. While Friendly Finder is pretty fast on a hard disk, its performance is virtually instantaneous on a RAM disk. A search for a unique record in a 1000-record

continued

KAO. THE FIRST DISKETTES DESIGNED FOR THE FORTUNE 500.



Today's new generation of personal computers provides unprecedented power and capability. That's the good news.

Now the bad news. Your diskette media is stretched to the limit every time it's taken for a spin. And, as diskette densities increase, so does the chance of failure.

That's why Kao (pronounced cow) Corporation re-thought the diskette. And applied its 100 years of expertise in surface science technology to developing the first diskettes designed for today's high performance computers.

Kao diskettes employ patented, wear-resistant resins and surface-treated magnetic particles for better head-to-surface contact, the key to diskette durability and performance. And unique surface lubricants actually extend the life of your drive's read/write heads. Our new Canadian microdisk plant—the world's largest and most modern—ensures that Kao diskettes exceed every industry standard worldwide.

More than 12 million high performance Kao diskettes have been sold under many well-known brand names in the U.S.A. Now they're available from leading computer specialty and office products dealers under the Kao name. In a complete selection of sizes, densities, and colors—all the way to 2MBytes in 3.5". We even offer custom silkscreen designs—an innovative way to enhance marketing programs, improve security, and simplify diskette identification.

For the name of your nearest Kao dealer, call (800) 541-3475. (In CA: 800 548-3475). And get the first diskettes designed for the Fortune 500. Or companies that wish to join them.

KAO
Media from the Surface Scientists

World Headquarters: Kao Corporation 14-10 Nishinobashi Kayabacho 1-chome, Chuo-ku, Tokyo 103 Japan. 813-860-7880 Fax: 813-860-7788 Telex: KAO TYO J24R R
In USA contact: Kao Corporation of America InfoSystems Division, 2005 Landings Drive, Mountain View, CA 94043 (415) 965-4183 Fax: (415) 965-0463
In Canada contact: Kao-Diskette Ltd. P.O. Box 41, 10 Dicks Drive, Ampring, Ont. M7S 3H2 (613) 623 7901 Fax: (613) 623-2886 Telex: 0523548
In Europe contact: Kao Corporation GmbH InfoSystems Division, Wanhamer Str. 57 4000 Düsseldorf 30, F.R. Germany. 0211-4176-0 Fax: 0211-413550 Telex: 8587505 kae o

Corporate logos used are the trademarks of their respective companies. They are intended to illustrate the Kao custom silkscreen process and do not imply use of or endorsement by these companies of Kao diskettes. © 1987 Kao Corporation

IBM PC® COMPATIBLE SINGLE BOARD COMPUTER

Quark/PC+

4" x 6"

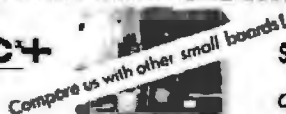

From
\$325.
quantity one

- Low Power — Less than 3 Watts
- Optional on-board Video LCD Driver
- Ideal for any PC compatible OEM product which is not a personal computer

Includes: 1. Powerful V40® CPU (Faster than a PC) 2. Math Co-Processor Socket 3. 5 Volt Only Operation (3 watts) 4. Speaker Port 5. Keyboard Port 6. Parallel Printer Port 7. PC Bus 8. PC Compatible BIOS ROM 9. 1 Serial Port

On board Options include: 1. 5 Mode Video Controller Option (Monochrome, Hercules® Graphics, CGA, High Res CGA, LCD Driver) 2. Floppy Disk Controller (3.5"/5.25", 360K/720K/1.2 MB) 3. SCSI Bus Interface (Hard Disk etc.) 4. Up to 768K RAM 5. Battery-Backed-up Real-Time-Clock 6. 2 Additional RS232C Serial Ports

To order or enquire call us today.
Megatel Computer Corporation
(416) 745-7214 FAX (416) 745-8792
174 Turbine Drive, Weston, Ontario M9L 2S2
U.S. Address: 1051 Clinton St., Buffalo, N.Y. 14206

Distributors:

Northern Europe: Mecom GMBH (Germany) (06071) 5495
Southern Europe: NCS Electronics (Italy) (0331) 256-524
U.K.: Densitron (0959) 71011 or (0959) 71015
Australia: Asp Microcomputers (02) 500-0628

Quark is a registered trademark of Megatel Computer Corp. Hercules is a registered trademark of Hercules Corporation. V40 is a registered trademark of NEC Corp. IBM PC is a registered trademark of IBM Corporation.

megatel

SHORT TAKES

database took a few seconds on the hard disk but completed almost instantly on the RAM disk.

To customize Friendly Finder using its special customization program, you add submenus that appear when you invoke Friendly Finder. The customization program also lets you set up fixed-length ASCII files for use with Friendly Finder. You have to specify a field width and field name for each field in the fixed-length record. The fixed-length file can then be queried just like a DBF file.

Friendly Finder is an extremely useful utility for database users. I hope that Proximity Technology will eventually make Friendly Finder available for other database formats.

—Nick Baran

Recordkeeping Software Shows Potential of Macintosh HyperCard

The Facts:

Focal Point
\$99.95

Requirements:

Macintosh Plus or equivalent,
HyperCard 1.0.1 or higher,
and a second floppy disk
drive or a hard disk drive.

Activision Inc.
P.O. Box 7286
Mountain View, CA 94039
(415) 960-0410
Inquiry 857.

One of the most alluring promises of Apple's HyperCard is the possibility of quickly storing, retrieving, changing, and cross-referencing "stacks" of whatever information you use regularly. Focal Point is a collection of 18 interrelated stacks that help you organize job-related phone, project, and billing data.

The most valuable thing about Focal Point is that information needed in multiple places shows up automatically after you have entered it once. For example, when you dial a number from the Directory and Dialer stack, Focal Point creates a new record in the Outgoing Phone Log, filling in the fields for the date, time, person called, and phone number.

The scheduling stacks include the Appointment Book, To Do List, Monthly Calendar, and Deadlines. In the To Do List, you can sort entries by priority; at the end of the day, pressing one button copies all pending items to the next day. The Deadlines stack shows all the project-related deadlines you've set, sorted by date.

There are also project stacks that you can use to interrelate clients, vendors, and projects. The phone-support stacks include the Directory and Dialer stack, and the Incoming and Outgoing Phone Log stacks. For billing purposes, you can record the length of a call in both Phone Log stacks just by clicking on a call-finished button. And finally, there are expense accounting stacks.

Focal Point is an excellent product, but as stackware, which sits "on top of" HyperCard rather than a directly executable file, it has advantages and disadvantages. For example, if you don't like the way it works, you can modify it (with some difficulty) by changing the underlying HyperTalk scripts. On the other hand, it executes some actions slowly and has odd conventions, like wanting you to hit Tab or Enter but not Return when you finish a data item (this is an idiosyncrasy of HyperCard).

You really need a hard disk drive, MultiFinder, and at least 2 megabytes of memory (Focal Point is most useful when it is already in memory and can be called up in several

continued

COMPAQ 386 COMPATIBLE

16 MHZ, "0" WAIT
2 MEG MEMORY
1.2 MEG DISKETTE
AT STYLE KEYBOARD

ADD-ON OPTIONS

MONITOR KIT

Monitor, Video Card,
Parallel Port

Monochrome \$150.00

RGB Color \$355.00

EGA/PGA Graphics \$705.00

HARD DISKS

386
\$2,245.00

40 MEG \$640.00

70 MEG \$925.00

(312) 450-6220



Additional Configurations Available

Intratech, inc.

BOX 1104
WESTMONT, IL 60559

TERMS: Prepaid. Illinois Residents Add 6 3/4% Sales Tax.
Freight UPS Ground Rate Collect.

Discover Parallel Processing!

Monoputer™

*The Most Cost Effective
Transputer Development System*

MicroWay's **Monoputer** is the best selling Transputer-based PC coprocessor in the world. It was the first board available to run the 20 MHz T414 or T800. As a result, it received many rave reviews in the UK (available on request) and became the standard Transputer software development tool. Parallel code can be executed on a single Monoputer or on an array of Monoputers wired together by their external link lines. The Monoputer includes 2 megabytes of 100 nsec DRAM, a 20 MHz T414 or T800 and the MicroWay stand alone Occam Compiler, which generates Transputer code that runs under MS-DOS. Optional tools include our licensed version of the TDS and a Pascal, Fortran, C, and Prolog.

Attend MicroWay's Seminar on Parallel Processing, April 6th in Plymouth, Massachusetts!
For more information please call (617) 746-7341. After July, 1988, call (508) 746-7341.

Micro Way

TRADE-MARKS Quadputer, Biputer and Monoputer of MicroWay Inc. INMOS Transputer TDS, OCCAM of INMOS Corp. MicroWay™ is a registered trademark of MicroWay, Inc.

Circle 174 on Reader Service Card

Quadputer™

*Mainframe Power
For Your PC!*

MicroWay's **Quadputer** is the most versatile multiple Transputer coprocessor on the market today. It can be purchased with 2, 3, or 4 Transputers, each of which has 1 or 4 megabytes of local memory. Two or more Quadputers can be easily cabled together to build larger parallel processor systems. A single Quadputer using four T800s provides 40 MIPS of CPU and 6 megallops of NDP throughput at one fiftieth the cost of a comparably performing mainframe.

The World Leader in PC Numerics

P.O. Box 79, Kingston, Mass. 02364 USA (617) 746-7341
32 High St., Kingston-Upon-Thames, UK 01-541-5466
St. Leonards, NSW, Australia 02-439-8400



Polishing The Apple

enthusiasts and Polishing the Apple for Macintosh enthusiasts, are available now.

These illusionary images are reproduced for the first time on 100 lb. 15" x 19" acid free book weight coated paper with fade resistant inks to insure precise reproduction of the original watercolors. Each reproduction is signed by the artist.

The price of these exact reproductions is just \$30 each or both for \$50. These introductory prices include shipment via UPS Blue Label (2-day delivery) and an unconditional 30-day guarantee.



Rambenders, 1986

NANCY GRAHAM'S RAMBENDERS

Nancy Graham, recognized nationally for her high-precision watercolors of classic cars, is creating a series of original paintings which explore the interplay of the power of the 50's cars and the power of the 80's computers. Superb quality color reproductions of the first two paintings in this series, Power User, for IBM PC



Power User

Order yours from Rambenders, 11100 Lakewood Lane, Austin, Texas, 78750-3408, (512) 258-0782. ew@rambenders@uunet.uu.net Mastercard/Visa accepted.

SHORT TAKES

seconds). The full set of stacks takes up 1051K bytes of disk storage, although you can make do with less. Although Focal Point's price is too high and it has a few drawbacks, I think it's a worthwhile product.

—Gregg Williams

A Weather Station for Your PC

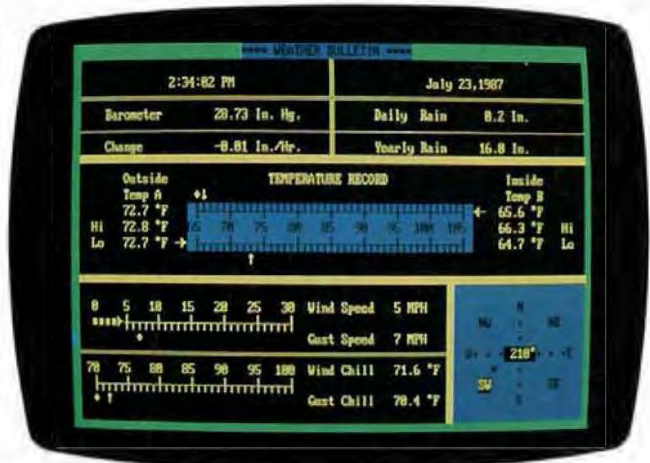

The Facts:

PC WeatherPro
\$575

Requirements:

IBM PC, XT, AT, or compatible; DOS 2.0 or higher.

Technology Marketing Group Ltd.
4000 Kruse Way Place,
Building 2, Suite 120
Lake Oswego, OR 97035
(503) 635-3966
Inquiry 855.

A full-fledged weather monitoring system, PC WeatherPro is based on a half-length plug-in card with a spiffy 80-pin custom IC developed specifically to process weather data. Packed into the chip is an A/D converter, a processor, memory, a real-time clock, a custom solid-state barometric pressure transducer, and the microcode that ties it all together. Since keeping the board powered up at all times is critical, a separate plug-in power supply keeps PC WeatherPro running even when your computer is powered down.

But the board is only the beginning. It's what you hook up to it that counts, and that includes both internal and external temperature sensors, an electronic rain gauge, an anemometer, and a wind vane. Obviously, installing and hooking up all this stuff requires a certain amount of ambition, time, and skill. You'll need to plan wire runs and crawl around on your roof to mount the wind sensors and rain gauge. And you'll need both boiling and freezing water to calibrate the temperature probes, as well as access to accurate barometric pressure to calibrate the on-board sensor.

The software that keeps PC WeatherPro happily keeping track of conditions runs in the background, as you'd expect. You can call up the master Weather Bulletin screen at any time by pressing a hot key. The real power in PC WeatherPro, however, is its ability to log and plot all that weather data. At regular intervals, all the weather parameters that the system measures are written to a disk file. You can call them up at any time, and, with the press of a couple of keys, either display

continued

AMX 86

KADAK's engineers bring years of practical real-time experience to this mature

MULTI-TASKING SYSTEM (version 2.0)

for the IBM® PC, PC/XT and PC/AT

- No royalties
- IBM PC DOS® support
- C language support
- Preemptive scheduler
- Time slicing available
- Source code of the C interface and device drivers is included

- Intertask message passing
- Dynamic operations:
 - task create/delete
 - task priorities
 - memory allocation
- Event Manager
- Semaphore Manager

AMX86™ operates on any 8086/86, 80186/88, 80286 system.

Demo package \$25 US
Manual only \$75 US
AMX86 system \$2195 US
(shipping/handling extra)

Also available for 8080, Z80, 58000

KADAK Products Ltd.
206-1847 W. Broadway
Vancouver, B.C., Canada
V6J 1Y5
Telephone: (604) 734-2796
Telex: 04-55670

BREATHE NEW FIRE INTO YOUR GRAPHICS.



Introducing The OmniScanSM multifrequency monitor...AND...the Advanced EGA 900 OmniCardSM

Together they breathe new fire and life into charts, graphs, documents, spreadsheets, CAD/CAM applications and desktop publishing.

OmniScan...the high resolution monitor compatible with virtually all computers, software and graphics packages; VGATM to EGA...Personal System/2TM to Macintosh IITM.

The Advanced EGA 900 OmniCard...the most versatile graphics card available. Supports virtually all monitors and software; EGA, CGA, HerculesTM, MDA, 132 columns, VGA modes 11 and 12...and 800 x 560 high resolution graphics.

OmniScan and OmniCard are a powerful and profitable sales combination. Each is engineered for outstanding quality and value. Together, they're a real fire breather. Call today for complete specifications.

* 1988 is the year of the Dragon: a year of power and good fortune.

 **TATUNG**
We monitor the world.

Tatung Co. of America, Inc.

Western Region-2850 El Presidio Street, Long Beach, CA 90810 (213) 979-7055

Mid-West Region-3320 Dalworth St., Arlington, TX 76011 (817) 640-3175

Eastern Region-1075 Cranbury South River Road, Building A, Suite 8, Jamesburg, NJ 08831 (609) 395-6770

OmniScan and 900 OmniCard are sales marks of Tatung Co. of America, Inc. All trademarks are property of their respective manufacturers.

Want to save Time, Money,
& Headaches?



GET SUPERSOFT'S
SERVICE DIAGNOSTICS

All the software, alignment diskettes, parallel/serial wrap-around plugs, ROM POSTs and extensive, professional documentation to provide the most comprehensive testing available for IBM PCs, XT's, AT's and all compatibles under DOS or Stand Alone. No other diagnostics offers such in-depth testing on as many different types of equipment by isolating problems to the board and chip level.

NEW: SuperSoft's ROM POST performs the most advanced Power-on-Self-Test available for system boards that are compatible with the IBM ROM BIOS. It works even in circumstances when the Service Diagnostics diskette cannot be loaded.

NEW: 386 diagnostics for hybrids and PS/2s!

For over nine years, major manufacturers have been relying on SuperSoft's diagnostics software to help them and their customers repair microcomputers. End users have been relying on SuperSoft's Diagnostics II for the most thorough hardware error isolation available. Now versions of Service Diagnostics are available to save everyone (including every serious repair technician) time, money, and headaches in fixing their computers, even non-IBM equipment.

All CPUs & Numeric Co-processors	All Color Graphics & Monochrome
System Expansion & Extended Memory	Monitors
Floppy, Fixed & Non-standard Disk Drives	Parallel & Serial Ports
Standard & Non-standard Printers	Mono, CGA, Hercules & EGA
System Board: DMA, Timers, Interrupt,	Adapters
Real-time Clock & CMOS config. RAM	All Keyboards & the 8042 Controller

Join the ranks of XEROX, NCR, CDC, SONY, PRIME, ... who have bundled SuperSoft's diagnostics with their microcomputers at no risk because of our 30 day money back guarantee.

Service Diagnostics for PC, PC/XT, and compatibles only	\$199
Alignment Diskette for PC, PC/XT and compatibles (48 tpi drives)	\$ 50
Wrap-around Plug for PC, PC/XT and compatibles (parallel and serial)	\$ 30
Service Diagnostics for AT and compatibles only	\$199
Alignment Diskette for AT and compatibles (96 tpi drives)	\$ 50
Wrap-around Plug for AT (serial)	\$ 15
ROM POST for PC, PC/XT, and compatibles only	\$245
ROM POST for AT and compatibles only	\$245
Service Diagnostics: The KIT (Includes all of the above—save \$502)	\$495
Service Diagnostics for all other CPUs (386, V20, V30, Harris, etc.)	\$199
Diagnostics II is the solution to the service problems of users of all CP/M-80, CP/M-86 and MS-DOS computers	\$125
ROM POST for PS/2 and compatibles only	\$245
Alignment Diskette for PS/2 and compatibles (3.5 inch)	\$ 50

To order, call 800-762-6629 (in Illinois 217-359-2112), write to SuperSoft, or FAX 217-398-5923.

your microcomputer repair solution

SuperSoft

FIRST IN SOFTWARE TECHNOLOGY P.O. Box 1826 Champaign, IL 61820 (217) 369-2112 Telex 270366

SUPERSOFT is a registered trademark of SuperSoft, Inc., CDC of Control Data Corp., IBM PC, AT & XT of International Business Machines Corp., MS-DOS of MicroSoft Corp., NEC of NEC Information Systems, Inc., PRIME of PRIME INC., Sony of Sony Corp.

or print out graphs of the data. You can also set alarms to go off when certain conditions that you've preset—such as low or high temperatures or wind—occur.

With its \$575 price tag, PC WeatherPro is for dedicated weather freaks or those with a real need to keep track of current and past weather information. It is kind of a pain to set up, but it's one of the few PC accessories that give you the guilty pleasure of having fun and doing something ostensibly useful at the same time.

—Stan Miastkowski

Technical Graphing for Lotus 1-2-3

The Facts:

Tech*Graph*Pad 2.1
\$275

Binary Engineering Inc.
100 Fifth Ave.
Waltham, MA 02154
(617) 890-1812
Inquiry 858.

Requirements:

IBM PC, XT, or AT with
440K bytes of free memory,
DOS 2.0 or higher, and
CGA or EGA.

Tech*Graph*Pad is a stand-alone technical graphing program that can read directly from Lotus 1-2-3 or WKS-format files. The version that I tested (2.1) had several serious bugs and an extremely clumsy interface for such an expensive piece of software. The program does, however, have many features that engineers and scientists need in a graphing program. It supports log-log and log-linear plot types, as well as polar coordinates. You can use up to eight data sets of 500 points each, which you can generate in ASCII format or WKS files. In addition, Tech*Graph*Pad supports a set of curve-fitting algorithms, including polynomial, power, spline, logarithmic, Bézier, and Savitsky-Golay. A host of other features for scaling, labeling, and customizing your graphs are also included. You can also convert data from Tech*Graph*Pad into multiple or merged PIC files if you need to use the Lotus PrintGraph facility.

In the bugs department, Tech*Graph*Pad printed the x-axis coordinates incorrectly when I changed to an integer format (it printed one coordinate twice and put a minus sign in front of the 0 coordinate). Also, the built-in line editor for editing data files did not work properly, introducing extraneous characters when I attempted to move the cursor or use the PageUp or PageDown keys.

While bugs can be corrected, Tech*Graph*Pad suffers from more basic design problems in its user interface. Tech*Graph*Pad uses a series of pop-up menus, some of which have selections in columns. Unfortunately, you can't move the cursor horizontally from one column to the next. You have to scroll vertically to the bottom of one column and then start at the top of the next, even if you only want to enter commands in a single row. In addition to the menu problems, Tech*Graph*Pad does not support the Extended ASCII character set, so you can't label your plots with standard Greek mathematical symbols such as θ or Σ , for example.

Tech*Graph*Pad's most important feature is its ability to read WKS files. However, you can't view the data from the WKS file when you are prompted to enter cell ranges for each data set. This means that you have to write them down on paper while in Lotus 1-2-3 before you load Tech*Graph*Pad.

There is a need for a program with Tech*Graph*Pad's features. However, I think that the implementation of these features in Tech*Graph*Pad version 2.1 is seriously flawed. ■

—Nick Baran

Now you can find a needle in the haystack in three seconds flat. With MemoryMate.™

Imagine tossing all your notes and files into a huge desk drawer. Then magically discovering that every time you want something, it's right there on top.

We call it MemoryMate. A new breed of data manager that reduces your paper clutter and takes the mess off your desk.

Unlike structured data bases, MemoryMate is free-form and works intuitively. Once you enter a record (up to 60 lines each) every single word, phrase, and date is automatically indexed. And cross-indexed.

Which means that MemoryMate can find that record later by using any word, date, or phrase in it. And MemoryMate does it fast. You can search 180K on a PC XT in three seconds!

And since MemoryMate is memory-resident, it's always there. You can access it while other programs are running. You can even cut and paste between MemoryMate and other programs. And vice versa.

Just enter your memos, notes, tables — anything — using the built-in word processor. You can forget designating "keywords." Just like you can forget where you stashed that important scrap of paper or yellow Post-it®.

You can even forget all your to-do lists and deadlines. Because MemoryMate reminds you. Ticker messages pop-up on screen automatically on the days you select.

So how complex is all this to operate? MemoryMate has only 15 simple commands and they're always on screen. So you can access all that power easily — without having to remember a thing.

Find what you need using a single word. Or a sentence.

Let's say you want to call an attorney you met playing tennis last May. But you can't remember his name. All you remember is that you put a note about him in MemoryMate. So you type in the word "tennis" and hit the search key. In seconds, all records containing "tennis" begin to appear. But let's say you also manage a tennis league. You've got tons of "tennis" entries. To narrow your search, you type "tennis and May and attorney". Bingo! You've got his name and phone number.

Circle 45 on Reader Service Card



Is a
better memory worth
\$69.95?

Much more, according to Michael J. Miller, InfoWorld: "If you've got lots of unstructured information to keep track of, MemoryMate is a wonder... And at \$69.95, it's a bargain."

PC Week agrees: "Once you've unlocked MemoryMate's power, you'll wonder how you ever got by without it."

Syndicated columnist Bob Schwabach is ecstatic: "I don't know quite how they did it...but this thing is lightning fast."

With all this praise and all these incredible features, you'd expect MemoryMate to cost a lot more than \$69.95. But it doesn't.

And, right now you can get a demo disk for less than six bucks — which can be rebated when you buy MemoryMate. So fill in the coupon below and send it in. And be sure to do it now, before you forget.

After all, you don't have MemoryMate to remind you. Yet.

- YES.** Send me the MemoryMate demo disk for just \$5.95, tax and shipping included.
- I'M SOLD.** Send me the MemoryMate program for \$69.95 plus \$3.50 shipping. CA res. add 6% sales tax.

NAME _____

ADDRESS _____

CITY _____ STATE _____ ZIP _____

DAYTIME TELEPHONE _____
 Check/Money Order Visa MasterCard American Express

Account Number _____

Expiration Date _____ Signature _____

Order Toll-Free. 24 Hours.
1-800-527-6263

Order by Mail: P.O. Box 12947, San Rafael, CA 94913-2947 33BY2

Allow 4 weeks for delivery. Demo disk offer good while supplies last.

Broderbund®

ABOVE BOARD 2 LEAVES THE COM

Above* Board 2 is the first memory board for the PS/2™ that comes with the new expanded memory specification — LIM 4.0.

Because only Above Board 2 comes from Intel. The company that developed LIM 4.0.

So now your users can access more memory. And run the very latest DOS application software well beyond 640K. Which will give everyone powerful, new capabilities they never thought possible.

Above Board 2 also promises 100% compatibility with OS/2™ application software.

Along with guaranteeing compatibility with the PS/2's microchannel technology.

Add to that Intel's technical support, award-winning documentation and five-year warranty, and Above Board 2 is clearly your one and only choice.

Of course you could always wait for the competition to catch up. But, where would that leave you?

The Intel logo, consisting of the word "intel" in a lowercase, sans-serif font with a registered trademark symbol (®) to its upper right.

For more information, call 800-538-1573. This advertisement is © 1988 Intel Corporation. PS/2, OS/2, and microchannel are trademarks of International Business Machines Corporation. © 1988 Intel Corporation.



PETITION OUT ON A LIM.

Enhanced EGA and VGA Boards

Curtis Franklin Jr.

The joy of a good video standard is that you want to use the available graphics. EGA graphics have become the standard for business applications, offering 640- by 350-pixel by 16-color resolution and text that is readable for extended periods of time. During the last year, companies pushed that standard higher by offering enhanced EGA boards with 640 by 480 or higher resolutions.

IBM has since given the world a new graphics standard, the VGA, and early indications are that it is a good standard indeed. People who make graphics boards recognize this, and so the rush is on to get VGA-compatible graphics adapters to market. In this mad rush, unfortunately, the word "compatible" takes on several shades of meaning. I looked at 22 boards and found that, in many cases, compatibility is in the eye of the marketing chief.

In broad terms, the boards in this review fall into two categories: VGA-compatible boards and enhanced EGA boards that happen to have modes that coincide with one or more of the new VGA modes. Table 1 lists characteristics for the 14 enhanced EGA boards I looked at, and photo 1 shows a sampling of these boards. Table 2 lists the 8 VGA boards, and photos 2 and 3 show what these boards look like. In both groups of boards, I found that performance and features varied widely from board to board.

Sorting Out Standards

The original EGA boards used a 16.257-MHz timing crystal to drive the display at the 640 by 350 resolution. This satisfied users until multiple-scan-rate monitors, like the NEC MultiSync, appeared. These monitors allow a much higher resolution, and people soon realized that simply adding a faster crystal would give

Should you buy a VGA or will an enhanced EGA fill the same purpose for less money?

them an EGA display with 640 by 480 resolution (now the standard for enhanced EGAs). Some manufacturers are going beyond the new standard to 800 by 560 and higher resolutions.

VGA arrived on the scene with the IBM PS/2 computers in April 1987. It brought five new BIOS display modes (two text and three graphics) and a new requirement for monitors. EGA (and earlier) graphics use TTL monitors for their display. The increased bandwidth of the VGA signals would require a TTL cable roughly the diameter of your thumb, so IBM engineers decided to switch to analog display technology.

With an analog display, fewer wires are required to carry the signal from the display adapter to the monitor. Most multiple-scan-rate monitors allow switching between analog and TTL input, so upgrading from EGA to VGA will not, for many users, require buying a new monitor, as did the switch from CGA to EGA.

Most of the interest in VGA has centered on the graphics modes. The three new ones are mode 11H, 640 by 480 by 2-color; mode 12H, 640 by 480 by 16-color; and mode 13H, 320 by 200 by 256-color. Modes 12H and 13H display their colors from a palette of more than 256,000 colors.

You may have noticed that the resolution of modes 11H and 12H matches the resolution of many enhanced EGA boards. This does not mean that all boards with 640 by 480 resolution are VGA-compatible. The BIOS entry locations are different for EGA and VGA, even at the same resolution. Some manufacturers solve this problem by offering software that switches the board between EGA BIOS and VGA BIOS.

If you have specific needs for a particu-

lar mode or resolution, you should read the specifications of the board and its attendant software carefully. Photos 4 and 5 show the difference between EGA and VGA resolution. (For a detailed discussion of the VGA standard, see "PS/2 Video Programming" by Richard Wilton in BYTE's Fall 1987 *Inside the IBM PCs*.)

Wringing Them Out

I used nine tests to check the features and compare the performance of the boards. The machine I used was an 8-MHz IBM PC AT with 2.5 megabytes of RAM, a 40-megabyte hard disk drive, and an NEC MultiSync XL monitor. The tests I used were the following:

1. TORUS.BAS: A QuickBASIC 4.0 program that draws a torus (doughnut) on the screen at the highest available color/resolution, then cycles the colors.
- 2 and 3. Two QuickBASIC programs that checked for support of VGA mode 13H.
4. VGADiag: This program comes with the SigmaVGA board and checks for support of all EGA modes, enhanced EGA (640 by 480), and all VGA modes.
5. Windows Draw: I measured the time to redraw the USA.PIC file that was supplied with Microsoft Windows Draw.
6. Windows Write: I measured the time needed to scroll from the top to the bottom of a file that measured approximately 40K bytes. For both Windows tests, I used Microsoft Windows version 1.03 (which was the latest version available at the time of this writing) and the Windows driver supplied with the individual board unless otherwise stated.
7. DOS DIR: The time needed to display a 53-entry directory using the DIR command of DOS 3.2.
8. AutoCAD: I timed a regeneration (REGEN) of the STPAULS file supplied with AutoCAD version 2.52 with ADE 3 extensions. I used the AutoCAD driver supplied with each board to perform this test.

continued

Curtis Franklin Jr. is a technical editor for BYTE. He can be contacted at BYTE, One Phoenix Mill Lane, Peterborough, NH 03458, or on BIX as "curtf."



EGA

Boca Research MultiEGA
Genoa SuperEGA HiRes +
IGC EGAcad
Logitech EGA
Mitac SEGA
NSI Smart EGA Plus
Paradise Autoswitch EGA480
Quadram Quad ProSync!
SCOA Star PGA
SMT Pro-EGA
Tatung 900 OmniCard
Tecmar EGA Master 800
Thomson EGA Ultra Version
Tseng EVA480

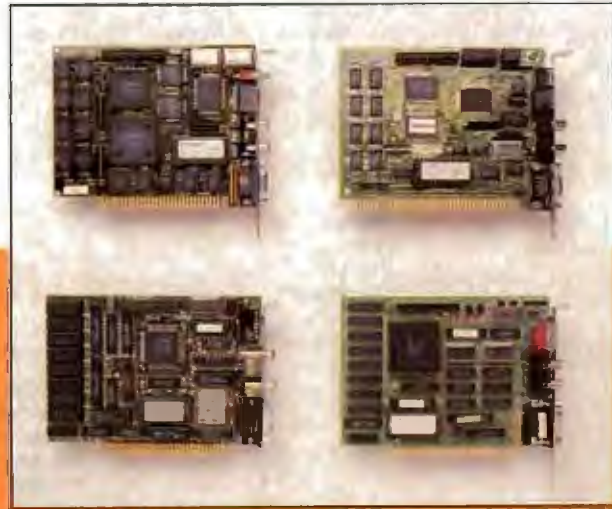

VGA

ATI VIP VGA
Tatung Platinum Card
Compaq VGC Board
IBM PS/2 Display Adapter
SigmaVGA
STB VGA Extra
Video Seven VEGA VGA
Zenith Z449

Photo 1: The NSI Smart EGA Plus, Thomson Enhanced Graphics Adapter Ultra Version, Paradise Autoswitch EGA480, and Quadram Quad ProSync! are typical of the half-slot enhanced EGA boards.

Photo 2: IBM's Personal System/2 Display Adapter, the standard by which most other VGA boards are judged.

Photo 3: The first crop of VGA boards include the ATI VIP VGA, Compaq Video Graphics Controller Board, SigmaVGA, STB VGA Extra, VEGA VGA, Tatung Platinum Card, and Zenith Z449.

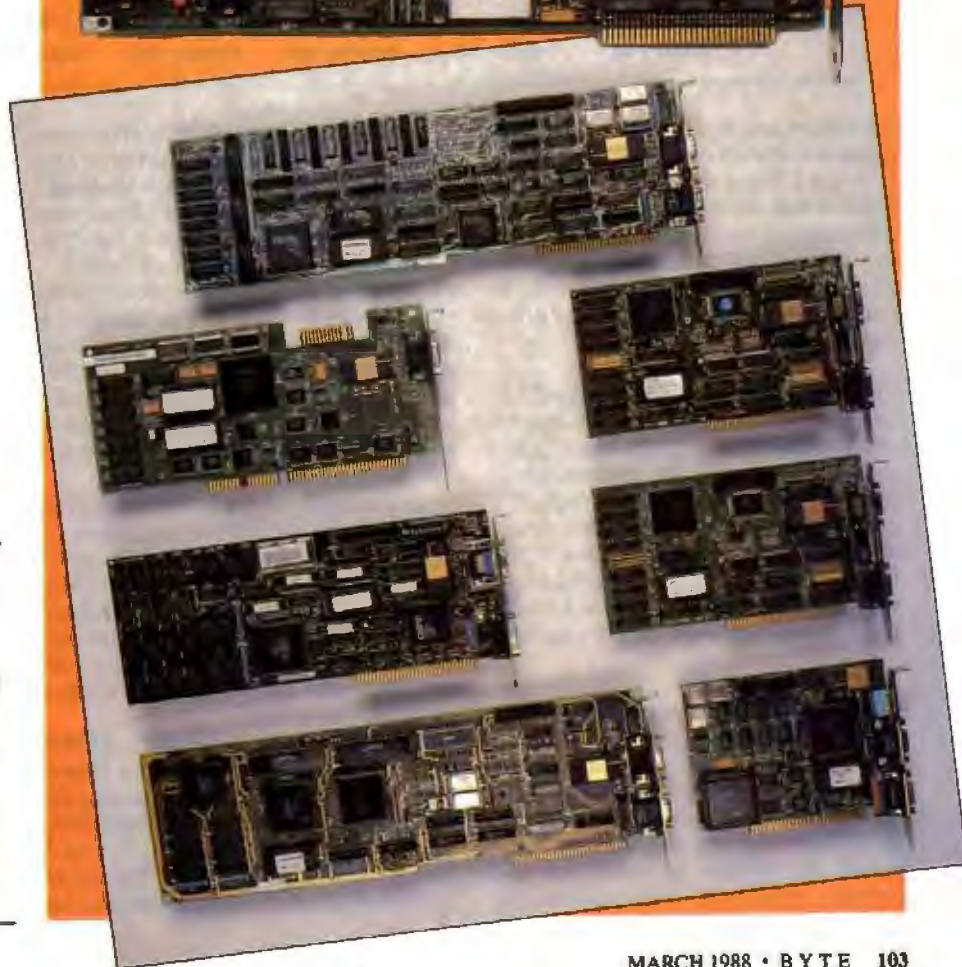

Table 1: Enhanced EGA boards.

Product	Boca Research MultiEGA	Genoa SuperEGA HiRes +	IGC EGAcad	Logitech EGA	Mitac SEGA	NSI Logic Smart EGA Plus	Paradise Autoswitch EGA480
Maximum resolution	640 x 480 x 16 colors	640 x 480 x 16 colors	640 x 480 x 16 colors	640 x 480 x 16 colors	640 x 480 x 16 colors	640 x 480 x 16 colors	640 x 480 x 16 colors
VGA modes supported	None	Modes 0, 1, 2, and 3	None	None	None	None	None
Drivers supplied	Windows, AutoCAD	Windows, AutoCAD, GEM, Lotus 1-2-3, Framework II, Ventura Publisher, Volkswriter 3	AutoCAD	Windows, AutoCAD, GEM	Windows, AutoCAD, Lotus 1-2-3	Windows, AutoCAD, GEM, Lotus 1-2-3, Ventura Publisher, Symphony, WordStar, Framework II, WordPerfect	Windows, AutoCAD, GEM, Lotus 1-2-3, Ventura Publisher, Symphony, WordStar, Framework II, WordPerfect
Size	5½ x 4"	5½ x 4"	7 x 4"	5½ x 4"	5½ x 4"	5½ x 4"	5½ x 4"
Special features			TTL and 9-pin analog output; cable	Comes with three-button mouse and mouse driver software		Compatible with drivers for other EGA boards	
Documentation	46-page Owner's Manual	57-page User's Manual	25-page User's Manual	47-page Installation Manual	28-page Guide to Operations	39-page User's Guide 4-page addendum	35-page manual 31-page Software Manual
Price	\$299 Inquiry 924.	\$489 Inquiry 925.	\$450 Inquiry 926.	\$399 Inquiry 927.	\$199 Inquiry 928.	\$499 Inquiry 929.	\$349 Inquiry 930.

All drivers supplied used the ADI driver hooks available in AutoCAD.

9. Lotus 1-2-3: I timed the drawing of a graph within the spreadsheet. The graph was a stacked bar chart of 48 data points in 1-2-3 version 2. I used the 1-2-3 graphics driver supplied with the board or the Lotus EGA driver if no graphics driver was supplied.

The applications (Windows, AutoCAD, and Lotus 1-2-3) test the performance and features of a graphics board/driver combination. I used the highest-resolution driver available in each case. The performance of the board with a lower-resolution driver might be much different. Figure 1 shows the benchmark results for the enhanced EGA boards; figure 2, the results for the VGA boards.

Boards Beyond EGA

All boards in this category support at least 640 by 480 by 16-color graphics, driving them on a TTL monitor. Some of the boards provide BIOS hooks for VGA software in certain modes, but most simply list themselves as enhanced EGA boards. In addition to the drivers and software listed with each product, the

boards generally include software to display the version and date of the motherboard ROM, a program to change video modes in software, and a program to allow games that auto-boot to run. The boards are listed in alphabetical order.

The Boca Research MultiEGA (\$299) is a PC-bus half card. The MultiEGA uses the Chips and Technologies EGA chip set and the Boca Research BIOS, and it contains one switchblock and three jumpers for setting mode and monitor type. It includes drivers for AutoCAD and Windows and a screensaver.

Its performance places the MultiEGA solidly in the top tier of the enhanced EGA boards, taking 22.77 seconds to regenerate the STPAULS file in AutoCAD, the fifth fastest time, and 95.98 seconds to scroll through the Windows Write text file, the second fastest time. Boca does not claim that the MultiEGA emulates any VGA video modes.

The Genoa SuperEGA HiRes + (\$489) is a half-length board that uses a Genoa EGA chip set and EGA BIOS to provide enhanced EGA functions and compatibility with VGA text modes 0, 1, 2, and 3 through a TTL video port. The board provides VGA BIOS entry points, but the

tests I ran showed that the VGA emulation is not perfect. For example, the TORUS program gave an initial display of EGA-type colors, but it would not cycle the colors. In addition, a large green band ran down the right side of the screen.

Genoa includes drivers for AutoCAD, GEM, Windows, Lotus 1-2-3, Framework II, Ventura Publisher, and Volkswriter 3. With each test program, the SuperEGA HiRes + brought up the display on the far left side of the screen and then shifted it to the center after about ½ second. The jumping display was disconcerting but did not seem to have any effect on the performance of the programs. This board had the worst performance in Lotus 1-2-3, taking more than twice the time of the next slowest board. In other programs, it scored in the middle.

The Intelligent Graphics Corp. EGAcad (\$450), based on the Chips and Technologies chip set and Phoenix BIOS, has a number of features that make it stand out from the rest of the boards in this group. The EGAcad does not include VGA BIOS hooks or emulation, but it does have (9-pin) analog output in addition to the standard EGA TTL. IGC even included a 9-pin to 9-pin cable with the

Quadram Quad ProSync!	SCOA Star PGA	SMT Pro-EGA	Tatung 900 OmniCard	Tecmar EGA Master 800	Thomson EGA Ultra Version	Tseng Labs EVA480
640 x 480 x 16 colors	640 x 480 x 16 colors	640 x 480 x 16 colors	800 x 560 x 16 colors	640 x 480 x 16 colors	640 x 480 x 16 colors	640 x 480 x 16 colors
Modes 11H and 12H	None	None	Modes 11H and 12H	Modes 11H and 12H	None	None
Windows, AutoCAD, GEM, WordStar, WordPerfect	Windows, AutoCAD, GEM, CADVance, Lotus 1-2-3, WordStar, Symphony, Ventura Publisher	Windows, AutoCAD, GEM, CADVance, Lotus 1-2-3, WordStar, Symphony, Ventura Publisher	Windows, AutoCAD, Lotus 1-2-3, WordStar	Windows, AutoCAD, GEM, Lotus 1-2-3, Ventura Publisher	AutoCAD	Windows AutoCAD
5 1/2 x 4"	5 1/2 x 4"	5 1/2 x 4"	5 1/2 x 4"	5 1/2 x 4"	5 1/2 x 4"	13 1/4 x 4"
Driver upgrade for VGA: \$10					Microsoft InPort connector and mouse driver	25-pin RS-232C port, Hercules emulation
52-page Operations Manual; 30-page driver appendixes	60-page User's Manual	60-page Instruction Manual	45-page Operations Manual	70-page user's guide, 38-page cover removal guide	44-page User's Guide	51-page User's Guide, 35-page Driver Notes
\$395	\$399	\$249	\$399	\$595	\$395	\$480
Inquiry 931.	Inquiry 975.	Inquiry 976.	Inquiry 977.	Inquiry 978.	Inquiry 979.	Inquiry 980.

board. While other boards in this review concentrated on the VGA standard, IGC designed this board to work "in series" with its PGC (Professional Graphics Controller) compatible adapter. According to the manual, connecting the two boards allows the EGAcad to provide PGC colors at EGA resolution.

A driver for AutoCAD was included

with the board but, unlike the drivers for the other boards I looked at, this one didn't work. When I tried to install it, I got an Unknown Hardware error. The AutoCAD timing test was run using the AutoCAD EGA driver.

The Logitech EGA (\$399) comes with a three-button Logitech mouse and a mouse port. The Logitech EGA is based

on the Chips and Technologies chip set and Logitech BIOS, and it uses one switchblock and two jumpers to set video mode and monitor type. The board comes with drivers for Windows, GEM, and AutoCAD and drives all three at 640 by 480 resolution. I did not test the mouse or its drivers. The Logitech EGA board

continued



Photos 4 and 5: Microsoft's Windows 1.03 running under EGA (left) and VGA (right) modes illustrates the increased resolution that VGA offers.

Table 2: VGA boards.

Product	ATI VIP VGA	Tatung Platinum Card	Compaq Video Graphics Controller	IBM Personal System/2 Adapter	SigmaVGA	STB VGA Extra	Video Seven VEGA VGA	Zenith Z449
Maximum resolution	640 x 480 x 16 colors	640 x 480 x 16 colors	640 x 480 x 16 colors	640 x 480 x 16 colors	640 x 480 x 16 colors	640 x 480 x 16 colors	640 x 480 x 16 colors	640 x 480 x 16 colors
VGA modes supported	All	All	All	All	All	All	All	All except mode 13H
Drivers supplied	Windows, AutoCAD, GEM, Lotus 1-2-3, Ventura Publisher	Windows, AutoCAD, GEM, Lotus 1-2-3, Ventura Publisher	None	None	Windows, AutoCAD, Lotus 1-2-3, WordStar, GEM	Windows, AutoCAD, Lotus 1-2-3, Symphony	Windows, AutoCAD, Lotus 1-2-3	Windows, AutoCAD, GEM, Symphony, Lotus 1-2-3
Size	7½ x 4"	7½ x 4"	9 x 4"	13½ x 4"	13½ x 4"	10 x 4"	5½ x 4"	13½ x 4"
Special features				Also supports EGA, CGA, Hercules, and MDA		Loads video ROM into RAM	Also supports EGA, CGA, Hercules, and MDA	
Documentation	49-page Operations Manual	49-page Operations Manual	29-page Installation and Operations Guide	21-page Installation Instructions; 22-page addendum to DOS Guide	63-page Installation and User's Guide	57-page user's manual	52-page User's Manual	24-page Installation Guide; 20-page Driver Installation Guide
Price	\$449	\$445	\$599	\$595	\$499	\$395	\$499	\$499
	Inquiry 981.	Inquiry 982.	Inquiry 983.	Inquiry 984.	Inquiry 985.	Inquiry 986.	Inquiry 987.	Inquiry 988.

worked flawlessly and turned in a better-than-average performance.

The *Mitac SEGA* (\$199) is built around the same Chips and Technologies chip set and Phoenix BIOS as many of the other boards, but it deserves special note as the least-expensive board I looked at. The SEGA performed as a standard enhanced EGA, with one exception: In the VGA-Diag test, where all other boards gave a full-size screen for both the 320 by 200 by 16-color and 640 by 200 by 16-color tests, the SEGA gave split screens, with identical half-size images appearing in the top and bottom halves of the screen. In all, the Mitac board looks like a good bet if your needs are confined to the capabilities of an enhanced EGA.

The *NSI Logic Smart EGA Plus* (\$499) supports VGA modes 11H and 12H through its TTL video port. The documentation also lists other boards that this NSI chip-set- and BIOS-based board is compatible with. According to the documentation, this board is compatible with, and can use the drivers from, the Paradise Autoswitch EGA480, Video Seven VEGA Deluxe, Quadram Quad ProSync!, and PCG Photon Mega. In addition to this bounty of drivers, the Smart EGA Plus comes with drivers for Windows, 1-2-3, Symphony, and AutoCAD.

The major flaw of this board was the noticeable and very annoying flicker in the Windows and AutoCAD displays. The Smart EGA Plus was the only board to have a problem with severe flickering.

The *Paradise Autoswitch EGA480* (\$349) is a half-length card that uses the Paradise single-chip EGA and Paradise BIOS to provide enhanced EGA capability. This board offers the same basic functionality as the other boards in this group, and it provides software drivers for Windows, GEM, AutoCAD, Ventura Publisher, 1-2-3, Symphony, Framework II, WordStar, and WordPerfect.

The most outstanding feature of the Autoswitch EGA480 is its documentation, which is well written, professionally presented, and clearer than any other board's documentation on how the installation procedure for each driver works, including the response shown on the screen at each step. The quality of the documentation make this board good for users who do not have a lot of experience installing boards and drivers.

The *Quadram Quad ProSync!* (\$395) supports VGA modes 11H and 12H, as well as enhanced EGA modes. When I tested the board, which uses a Chips and Technologies chip set and the Phoenix BIOS, I found that on TORUS I got VGA

colors, but no color cycling, indicating limits to the completeness of the emulation. The Quad ProSync! comes with drivers for 1-2-3, Windows, AutoCAD, GEM, WordPerfect, and WordStar.

My only problem with the board came in using AutoCAD. When STPAULS first appeared, the colors were dramatically different than those of other boards, with red replacing blue, and green replacing white. When I regenerated, the colors corrected themselves, but throughout the AutoCAD session, random characters would occasionally appear at the top of the menu section.

The *SCOA Star PGA* (\$399) confused my poor little brain. First, the box said "Intelligent EGA." Next, while I would assume that "PGA" related to the IBM PGC board, this is simply another enhanced EGA board that uses the Chips and Technologies chip set and the Phoenix BIOS. There was nothing unusual in the operation of the board, but it was the only product I looked at that had no switches set at the factory. Most of the boards came set up for EGA graphics on a standard EGA monitor, but this board simply came with all switches on.

The *SMT Pro-EGA* (\$249) is a half-length card that uses the Paradise chip set

continued

CTX

THE BEST 14" MONITORS IN BOTH WORLDS



CGA

EGA

VGA [PS-2]

MULTI-SCAN/ANALOG

DUAL SCAN

GREEN/AMBER/WHITE

132 COLUMN

ALL WITH TWO-YEAR WARRANTY



U.S. HEADQUARTERS: CTX INTERNATIONAL, INC.

260 PASEO TESORO/WALNUT, CA 91769

TEL: (714) 595-6146 FAX: (714) 595-6293

EASTERN REGIONAL OFFICE

CONTINENTAL TECHNOLOGY, INC.

300 MCGAW DRIVE

EDISON, NEW JERSEY 08837

TEL: (201) 225-7377 FAX: (201) 225-6355

**SOUTHERN CALIFORNIA
AUTHORIZED DISTRIBUTOR**

ELCO COMPUTERS

215 S. RAYMOND ST.

ALHAMBRA, CA 91803

TEL: (818) 284-3281 FAX: (818) 284-4871

FACTORY

CHUNTEX ELECTRONIC CO., LTD.

ROOM 401, NO. 50 SEC.1,

HSIN-SHENG S. RD.,

TAIPEI, TAIWAN, R.O.C.

TEL: (02) 3921171 FAX: (02) 3919780

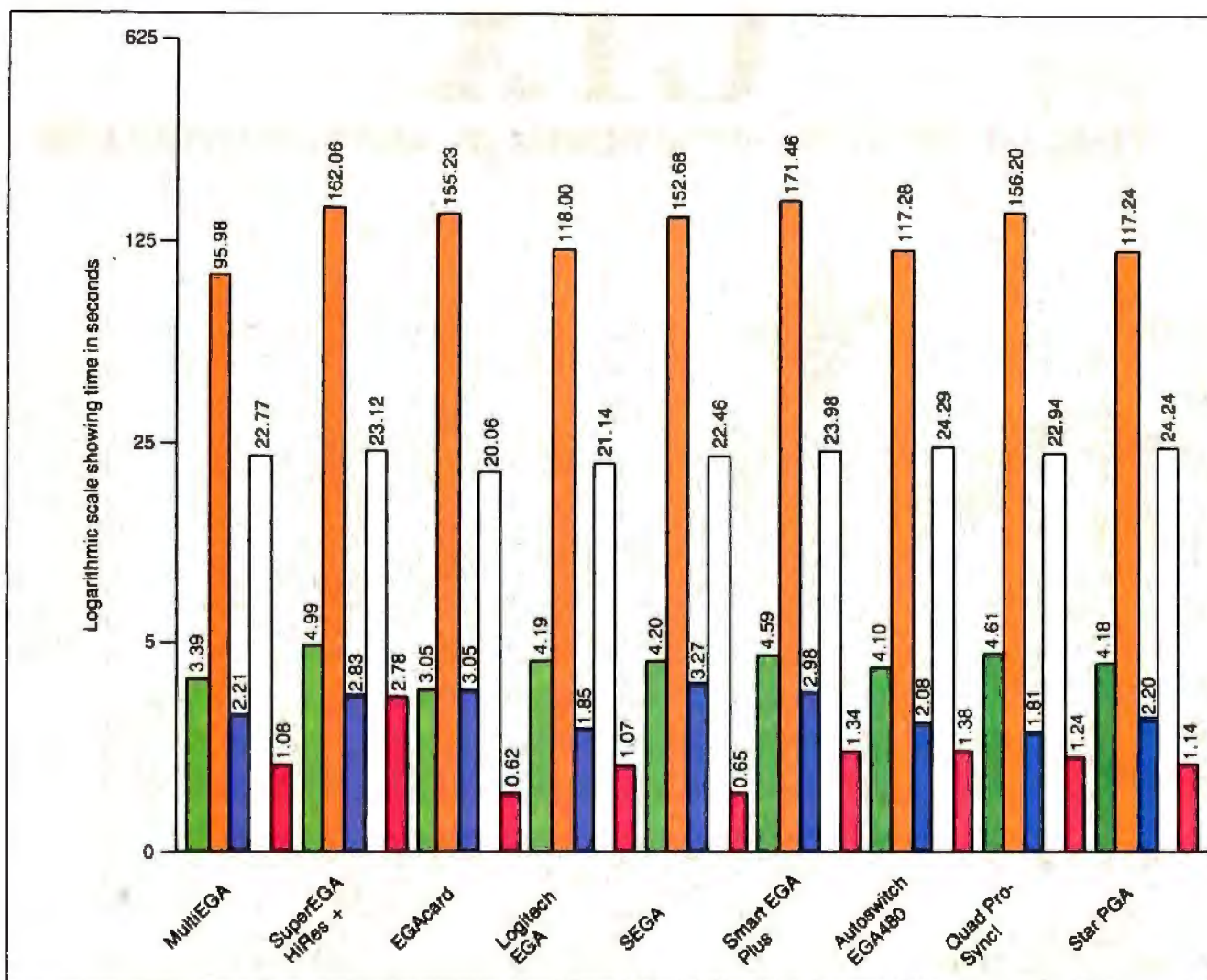

Figure 1: In the tests for the enhanced EGA boards, Boca Research's MultiEGA and Tseng's EVA480 were the top performers.

and BIOS. The Pro-EGA has one switch-block and three jumpers on the board, and it comes with drivers for Windows, GEM, AutoCAD, CADvance, Ventura Publisher, Symphony, 1-2-3, and WordStar. This board is one of the few that warranted a word about color; the driver for AutoCAD produced a weak red, while the Windows driver gave one of the richest reds of any board in the review.

The *Tatung 900 OmniCard* (\$399) uses the Chips and Technologies chip set and a Tatung BIOS to provide both VGA BIOS entry points and enhanced EGA resolution up to 800 by 560 by 16 colors. Tatung provides drivers for Windows, GEM, AutoCAD, 1-2-3, and Symphony. I tested the board using the 800 by 560 mode and found the display to be quite crisp and readable. Unfortunately, the screen in Windows and 1-2-3 was drawn too large (vertically) for the display, especially annoying in Windows, when important information (like the name of the

working file) was drawn off the screen.

The *Tecmar EGA Master 800* (\$595) is an enhanced EGA half-length card that has software for enabling BIOS hooks for VGA modes 11H and 12H. The Tecmar board has a Genoa chip set and Tecmar BIOS, and it comes with drivers for Windows 1.03, GEM, 1-2-3, AutoCAD, and Ventura Publisher. I was surprised to find that, in addition to the 70-page manual for the board, Tecmar includes a 38-page *Guide to Cover Removal and Replacement*, showing how to take the cover off scores of personal computers.

The *Thomson Enhanced Graphics Adapter Ultra Version* (\$395) is a half-length card that comes with a driver for AutoCAD and a mouse driver for the Microsoft InPort Mouse adapter on the card. Because of the presence of the InPort, the EGA Ultra Version has more switches than most of the boards, with three switchblocks and four jumpers. The board is built around the Renaissance

BIOS and chip set.

The *Tseng Labs EVA480* (\$480) has a number of unusual features that set it apart from the other boards. Tseng offers a piggyback board to allow complete Hercules emulation and includes a 25-pin serial port with the EVA480. This is a full-length board that uses a Tseng proprietary chip set and BIOS.

There are drivers for 1-2-3 and AutoCAD with the board, and I found files that appear to be Windows drivers. There were, however, no instructions for installing the Windows drivers, so I used the enhanced EGA driver supplied with Windows 1.03. The AutoCAD driver had the interesting feature of changing the menu characters to double size whenever they were accessed. The sudden leap in size was a bit jarring.

And on to VGA

The eight boards reviewed that fall into the true VGA category are the first ones

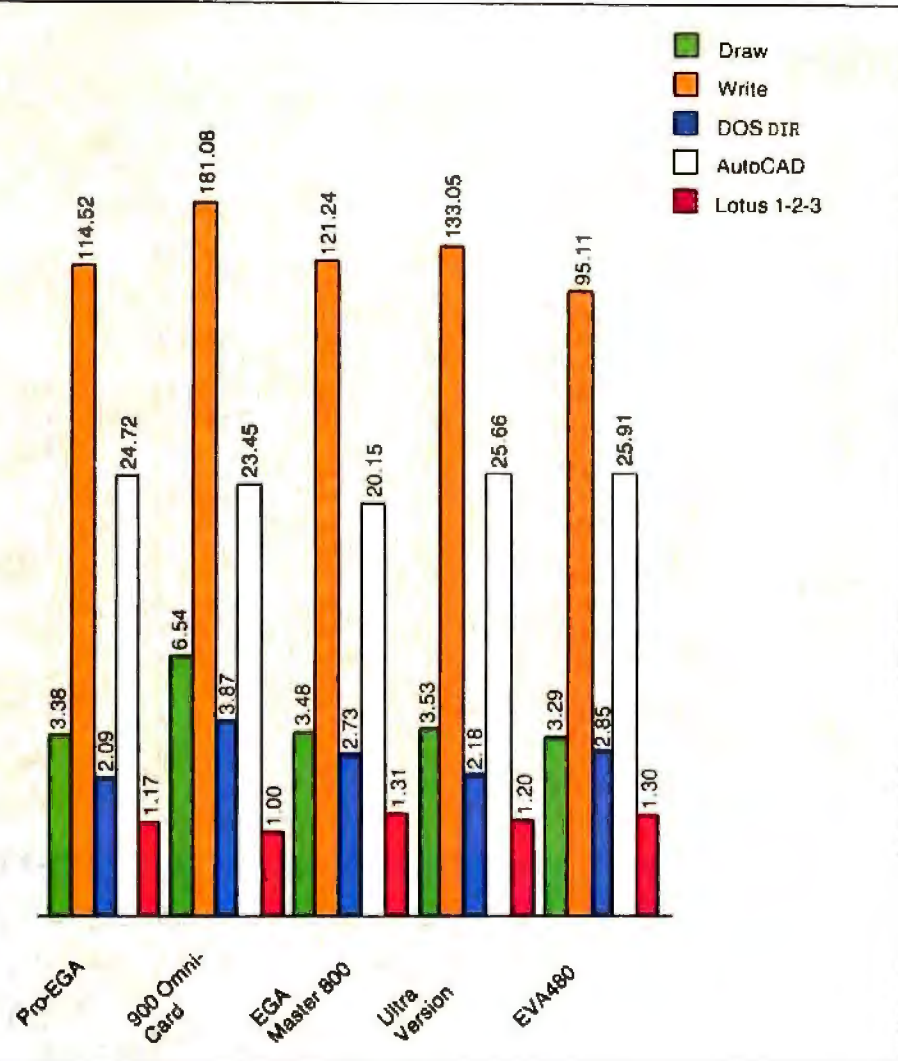

available. I found that the levels of performance and features among this group varied far more than did the features and performance of the enhanced EGA boards. As before, the boards are (with one exception) listed in alphabetical order.

The *ATI VIP VGA* (\$449) and *Tarung Platinum Card* (\$445) are listed together because they are one board sold by two different companies. ATI manufactures the boards using a Chips and Technologies chip set and ATI BIOS. Both supply drivers for GEM, Ventura Publisher 1.0, 1-2-3, AutoCAD, and Windows.

Both boards support all VGA modes, and both had the same problems with drivers. In AutoCAD and Windows, the display was drawn much too large (vertically) for the monitor to display. In AutoCAD, both the coordinates at the top of the screen and the current command at the bottom of the screen were invisible. In Windows, the blue bar with the working filename at the top of the screen and

the green icon bar at the bottom were both drawn out of the display area.

The *Compaq Video Graphics Controller Board* (\$599) emulates the IBM VGA to the extent of including precisely as many drivers as the IBM: none. Once I got past that, the Paradise chip-set-based board worked well, but with a lot of noise; not the video noise that causes "snow" on the screen, but real audio noise over the computer speaker. There was a definite hum throughout the operation of the board. The hum's pitch would change as different items were drawn on the screen. It was kind of fun to close my eyes and guess what was happening on the screen by the sound it made, but I think that the hum would get on my nerves in a big way over time.

The *IBM Personal System/2 Display Adapter* (\$595) is, of course, the standard against which all other VGA boards are judged. In most ways, it's not a hard standard to meet. It comes on a Micro Chan-

nel form-factor with a PC-bus connector. The board includes no drivers. Its documentation is complete, but not exhaustive. In order to get VGA graphics, I used the drivers from the SigmaVGA board, which worked with every package but AutoCAD. I ran the AutoCAD test using the EGA driver that was packaged with AutoCAD.

The *SigmaVGA* from Sigma Designs (\$499) is a full-length board that packs a lot of graphics compatibility into a single slot. Not only does the SigmaVGA support all VGA modes, it emulates EGA, CGA, Monochrome Display Adapter (MDA), and Hercules as well. With one of these and a multiple-scan-rate monitor, graphics-incompatible software would be few and far between. Drivers for AutoCAD, 1-2-3, Windows, GEM, and WordStar are included with the board. I've tried to think of some criticism of the board, but frankly, I can't.

The *STB VGA Extra* (\$395) is the least-expensive VGA board, but it's also the board with the most problems. The full-length Chips and Technologies chip-set-based board includes drivers for 1-2-3, Symphony, Windows, and AutoCAD. It also has a 57-page photocopied user's manual.

The problems arose in Windows and 1-2-3. The screen display in Windows was drawn too large for the monitor, with areas of the screen getting shoved off the top and bottom. In 1-2-3, the problem arose when I exited the package. After leaving 1-2-3, the screen stopped redrawing. In other words, a DOS CLS command would take the cursor to the top left corner of the screen but would not blank the old image. It took rebooting to get redrawing back.

The *VEGA VGA* from Video Seven (\$499) came very close to getting a no-buy recommendation. The first VEGA VGA board that I looked at had some serious problems. In AutoCAD, large vertical white lines would flash across the screen any time the mouse was in motion. No amount of regenerating, redrawing, or rebooting solved this problem.

Fortunately for Video Seven, I had received three of the boards, and I decided to look at another, to see if the problems were endemic to the VEGA VGA or particular to one board. I'm glad I did, because the problems seem to have been with one board, and the VEGA VGA does a couple of nice things. First, Video Seven has put VGA graphics into a half-length card format, which makes it the smallest board of the VGA group. Next, the company provides software that can automatically load the ROM code into faster RAM for better performance.

continued

Company Information

American Mitac Corp.
410 East Plumeria Dr.
San Jose, CA 95134
(418) 432-1160

ATI Technologies
3761 Victoria Park Ave.
Scarborough, Ontario
Canada M1W 3S2
(416) 756-0711

Boca Research Inc.
6401 Congress Ave.
Boca Raton, FL 22487
(305) 997-6227

Compaq Computer Corp.
20555 FM149
Houston, TX 77070
(713) 370-0670

Genoa Systems
73 East Trimble Rd.
San Jose, CA 95131
(408) 432-9090

IBM
900 King St.
1A515 Rye Brook, NY 10573
(914) 934-4793

Intelligent Graphics Corp.
4800 Great America Pkwy.
Suite 200
Santa Clara, CA 95054
(408) 986-8373

Logitech
6505 Kaiser Dr.
Fremont, CA 94555
(415) 795-8500

NSI Logic Inc.
Cedar Hill Business Park
257B Cedar Hill Rd.
Marlborough, MA 01752
(617) 460-0717

Paradise Systems
99 South Hill Dr.
Brisbane, CA 94005
(415) 468-7300

Quadram
One Quad Way
Norcross, GA 30093
(404) 923-6666

SCOA Systems
2100 Golf Rd., Suite 100
Rolling Meadows, IL 60008
(312) 640-8782

Sigma Designs
46501 Landing Pkwy.
Fremont, CA 94538
(415) 770-0100

SMT
1145 Linda Vista Dr.
San Marcos, CA 92069
(619) 744-3590

STB Systems Inc.
1651 North Glanville
Richardson, TX 75081
(214) 234-8750

Tatung Co. of America Inc.
2850 El Presidio Dr.
Long Beach, CA 90810
(213) 979-7055

Tecmar
6225 Cochran Rd.
Cleveland, OH 44139
(216) 349-0600

Thomson
5731 West Slauson Ave.
Suite 111
Culver City, CA 90230
(213) 568-1002

Tseng Laboratories
10 Pheasant Run
Newtown, PA 18940
(215) 968-0502

Video Seven
46355 Landing Pkwy.
Fremont, CA 94538
(415) 656-7800

Zenith Data Systems
100 Milwaukee Ave.
Glenview, IL 60025
(312) 699-4839

\$1799 For 386 POWER!!

ADVANCED LOGIC RESEARCH
386/2 Model 10

- * 80386-16mhz (20mhz Optional).
- * 1MB of 32-bit RAM (80ns);
- * Expandable to 2MB on board.
- * 1 Serial/ 1 Parallel Ports.
- * Floppy Controller.
- * 1 1.2MB Floppy Drive.
- * 101 Professional Keyboard.
- * Phoenix Bios.
- * 80387 and 80287 Sockets.
- * 8 Slots.



386/2

386/2 Model 40 \$2999

386/2 Model R66 \$2749

Other Models Too!! 20mhz versions now available!!!

COMING SOON: "Flex Cache" Models From ALR!!

W.P. Electronics, Inc. 800-962-6778 Order Line 8AM - 5PM Pacific Time

555 S Palm Canyon Dr #A110-342, Palm Springs, CA 92264
619-320-6500 In CA.

These are only some of our selections!!
Ask and we'll send you a FREE CATALOG!

Our Other Quality Brands:

Aldus	Dest	Iomega	Okidata
Amdak	Diconix	Irwin	Paradise
AT&T	Epson	Lotus	Plus Devlpmnt.
Ansa	Hayes	Microsoft	Ricoh
Ashton-Tate	Hercules	NCR	Seagate
AST	Hewlett-Packard	NEC	Western Digital
Compaq	IBM	Novell	Zenith

ALR "DART" 286s Avail....Mod 10 \$1199, Mod R66 \$1999

Incredible Software and Hardware Values:

Xerox Ventura Publ.	\$459	Novell Arcnet Starter Kit	\$2299
Aldus PageMaker	\$415	Lotus 123	\$299
PARADISE VGA BOARD	\$Call	HP LaserJet II w/Toner	\$1695
ATI VGA BOARD	\$289	HP 7475A Plotter	\$1299
VIDEO & VGA BOARD	\$Call	HP ScanJet w/PC Intrfc.	\$1395

Terms and Conditions:

Prices shown are for prepayment. Prices are subject to change without notice.
Some items are in short supply. FOB Palm Springs, CA. We accept MC/VISA 2%
extra; COD orders 2% extra. 20% Restocking Fee. Volume Inquiries Welcome.

COMPAQ and ZENITH

Deskpro 286-1	\$1799	Z-181 Laptop	
Deskpro 286-20	\$2450		\$1549
Deskpro 286-40	\$2999	Z-183 10MB HD	
Deskpro 386 Systems	\$Call		\$2075
Portable III-20	\$3599	Z-183+ 20MB HD	
Portable III-40	\$4175		\$2287
Portable 386 Systems	\$Call	1200Bd Int.Modem	
Compaq RAM Upgrades	\$Call		\$199
Compaq Accessories	\$Call	Carry Case	\$59

Time is of the essence. The essence of the HP DraftMaster Plotter. The fastest A to E size drafting plotter made by Hewlett-Packard. A plotter so fast, any designer can create big ideas at blinding speeds.

How did we do it? With unsurpassed acceleration. And features like a new pen-sorting algorithm. Bi-directional plotting. And a very fast resident micro-processor. We even offer a model with roll-feed for non-stop plotting.

But the HP DraftMaster doesn't sacrifice output quality for its blinding speed. Every plotter is thoroughly tested to ensure the highest reliability and precision. So you get smooth arcs, straight lines and perfectly-formed characters, time after time. Furthermore, it handles a variety of

pens on drafting film, vellum or paper—all at optimal speeds.

Naturally, it works with just about any computer. Like the HP Vectra PC and IBM PC's. As well as popular PC-CAD software like AutoCAD and VersaCAD. And the DraftMaster brings with it HP's worldwide reputation for quality. Prices start at just \$9,900*.

Why wait? For a brochure and a sample plot, call us at 1 800 367-4772, Ext. 901A.

The drawing shown below was produced on the HP DraftMaster with AutoCAD software

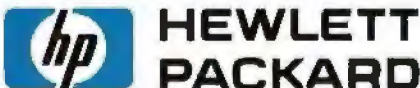

AutoCAD is a registered trademark of Autodesk Inc. VersaCAD is a registered trademark of T&W Systems. *Suggested U.S. list price © 1987 Hewlett-Packard Co.

Circle 113 on Reader Service Card

*we never
stop
asking "What if..."*

How to create monumental plots in a matter of minutes.

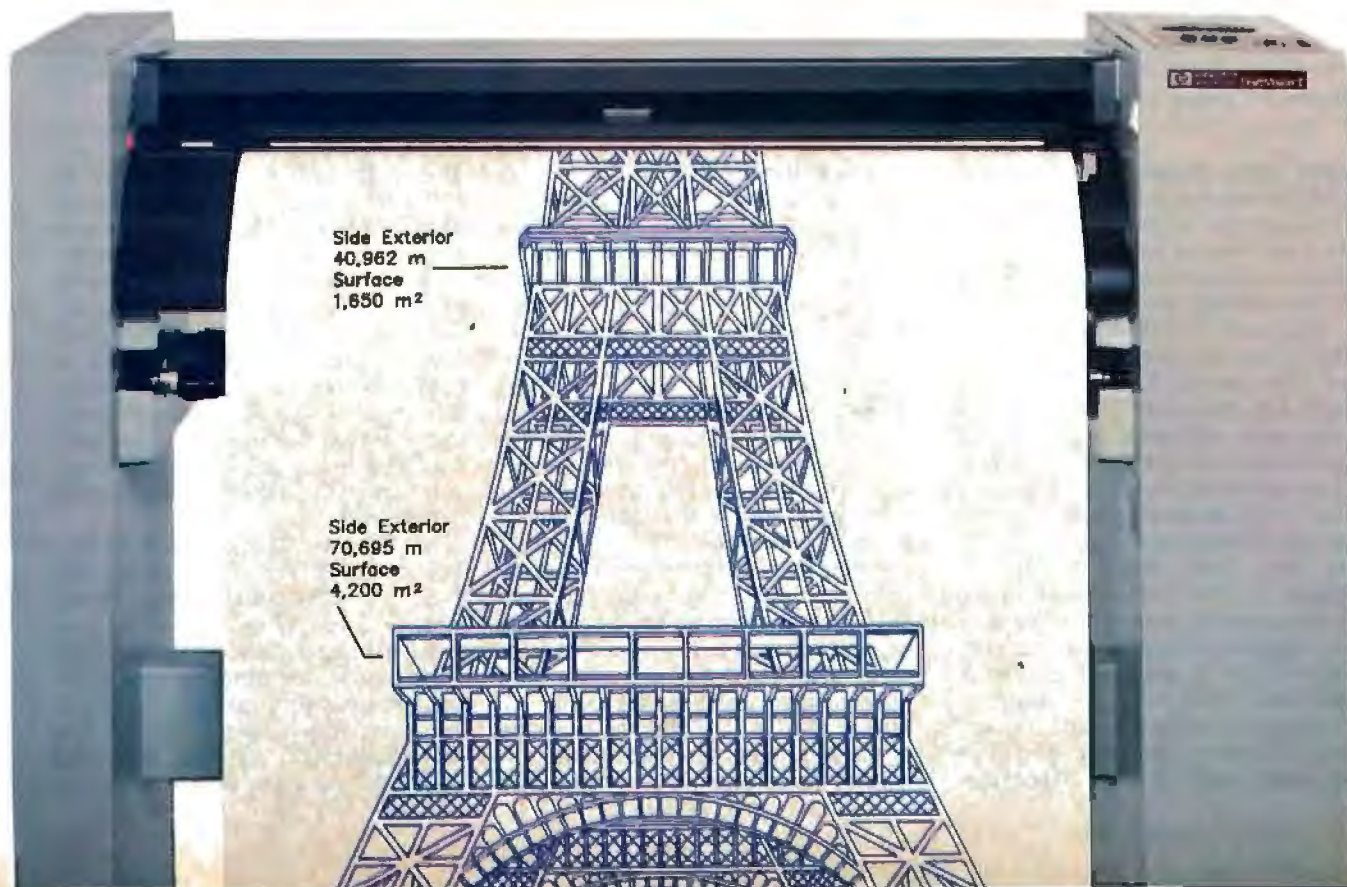

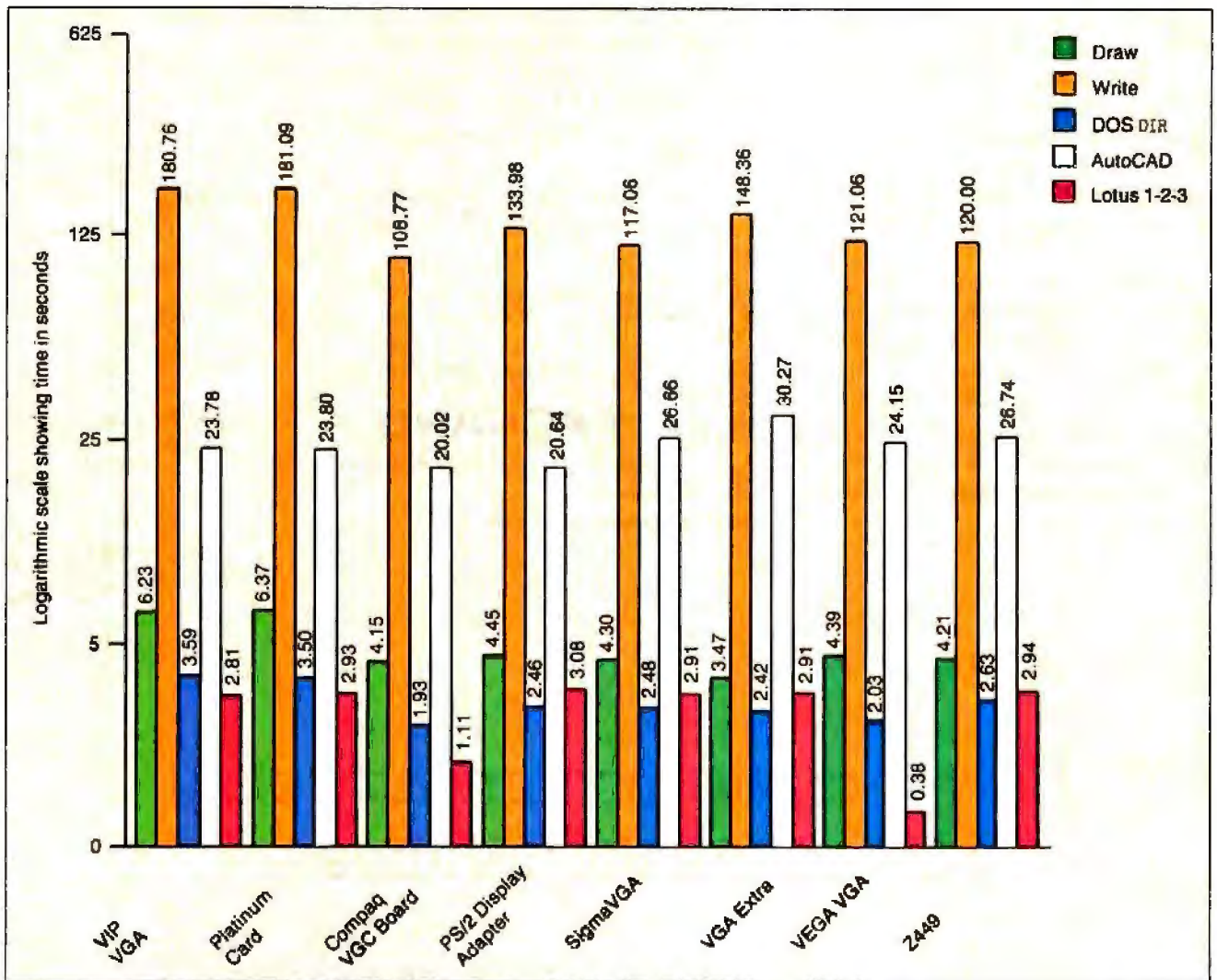

Figure 2: Compaq's VGC Board scored best on the benchmark tests for VGA boards, followed by Video Seven's VEGA VGA.

Video Seven includes drivers for AutoCAD, Windows, and 1-2-3 with the board. The experience with the first board left me a bit leery of the VEGA VGA, but based on the performance and features of the second board, this product's a winner.

The Zenith Z449 (\$499) is a full-length VGA board that supports all but one of the VGA modes. Unfortunately, the mode left out (mode 13H) is the 256-color mode that helps make the VGA standard so nice. The Z449, based on the Chips and Technologies chip set, tries to make up for the missing mode by providing lots of backward compatibility, offering EGA, CGA, MDA, and Hercules support. It almost succeeds. In addition to the hardware features, Zenith shows nice attention to detail by being the only manufacturer to provide its drivers for AutoCAD, GEM, 1-2-3, Symphony, and Windows on both 5 1/4- and 3 1/2-inch disks. If it weren't for the missing mode, this would be the top board of the group.

The Best of a Big Bunch

If an enhanced EGA board with no pretensions to VGA is all you need, the Mitac SEGA board is the clear winner on the basis of price. If you feel that high-quality, detailed documentation is important, by all means check out the Paradise board. Other than these two, the enhanced EGA boards offer a lot of similarities across a wide range of prices and secondary features. There were none that I would warn against. And given the current lack of software that supports VGA, these boards may be more than adequate for most applications.

On the VGA side of things, one fact became quite clear: If you need VGA, buy VGA, not an enhanced EGA board that happens to have a mode or two that coincides with VGA. For one thing, you really need an analog display to take advantage of VGA, and with the exception of the Intelligent Graphics EGAcad, none of the enhanced EGA boards offer

analog. For another, the quality of the "VGA emulation" provided by the enhanced EGA boards simply wasn't up to the standards of the "real" VGA boards.

Finally, most of the VGA boards reviewed here claim BIOS-level versus register-level compatibility with VGA. Since I began this review, many companies, including Paradise, Sigma, and others mentioned here, have announced boards that claim to be hardware-compatible with VGA and so able to more fully support future VGA software and offer faster performance.

But if I were in the market today for a VGA board, the SigmaVGA would be my choice. It offers complete VGA implementation and a nice variety of drivers in a well-documented package. The VEGA VGA from Video Seven is also a top-notch board, with good features and performance. If you need VGA and have only a half-length slot open, the VEGA VGA is the way to go. ■

Ah, the big idea. Everyone has one. But not everyone can afford a plotter to plot one on. Which got us thinking. What if there was an HP quality plotter so reasonably priced you could afford to hook one up to every PC CAD workstation in the office?

Presenting the HP DraftPro Plotter. For only \$4900 any architect, engineer or designer can create perfect plots time after time.

Consider what the DraftPro can do:

It can draw straight lines, smooth arcs and perfectly-formed characters. All on C and D-size drafting film, paper or vellum, using eight different pen colors.

Furthermore, it works with

just about any PC, such as the HP Vectra PC and IBM PCs. As well as popular PC CAD programs like VersaCAD and AutoCAD.

If the idea of having HP reliability with a low price tag makes sense to you, call us now. For a brochure and sample plot, call 1 800 752-0900, Ext. 901A.

The HP DraftPro Plotter: high-quality drafting for only \$4900.*

The drawing shown below was produced on the HP DraftPro with VersaCAD software.



VersaCAD is a registered trademark of T & W Systems. AutoCAD is a registered trademark of Autodesk, Inc. *Suggested U.S. list price.

Circle 114 on Reader Service Card

We never stop asking...
What if...

How to pull off a fantastic HP plot for only \$4900.

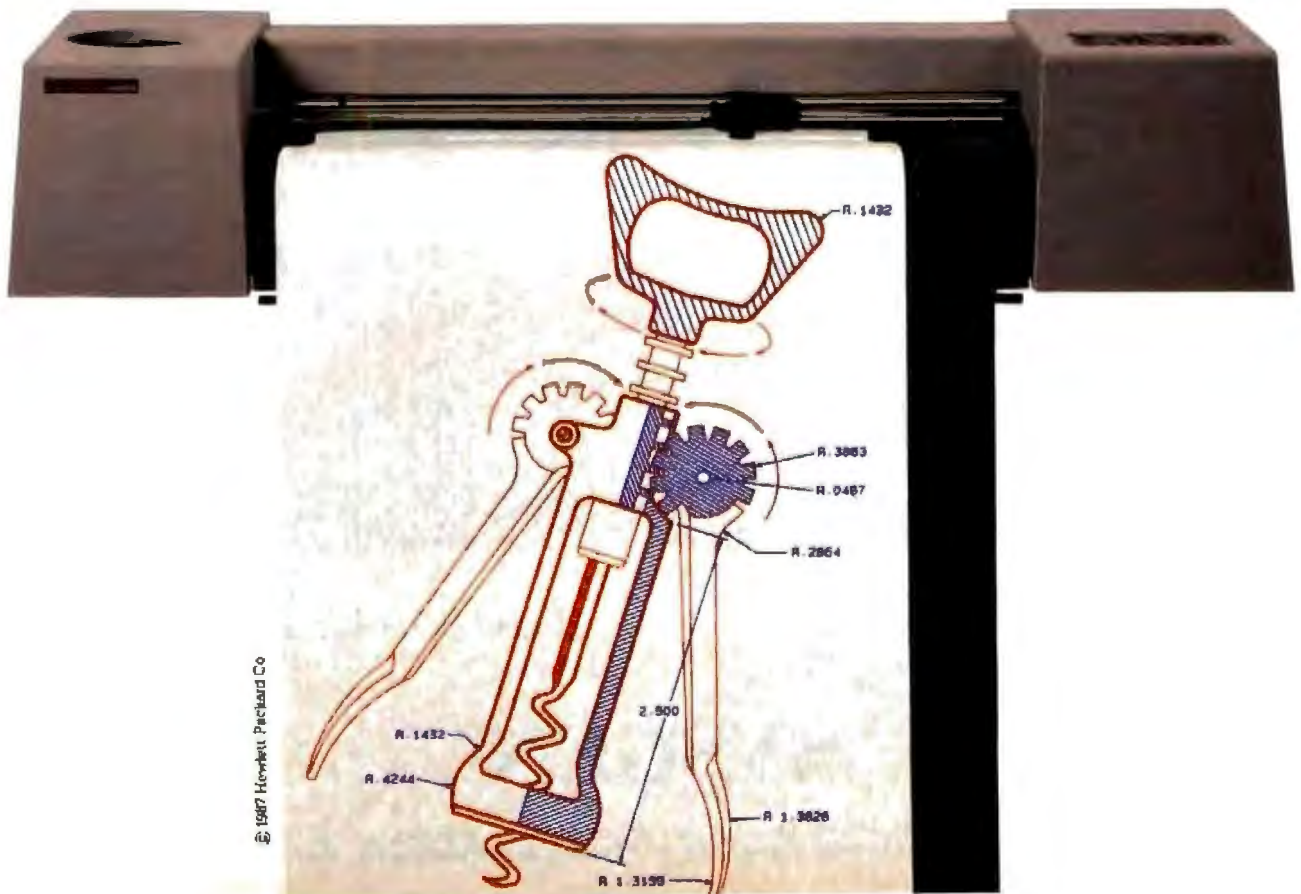

Insist on a Sysgen 5¹/₄" drive for your PS/2.

Here's why:

A Sysgen™ Bridge-File™ gives a PS/2™ full access to your current data and software, with unparalleled 5¹/₄" disk drive performance and reliability. You get: A larger capacity drive. Two modes — a 360Kb and a powerful 1.2 Mb — assure you comprehensive transfer capabilities and convenience for total office needs. Others, like IBM®'s, offer only 360Kb. Proven reliability. In fact, Sysgen is the choice of over 100,000 satisfied Bridge-File and tape back-up users. No slot loss. The Sysgen 5¹/₄" drive adapter card doesn't take any additional slot space. IBM's does. Built-in flexibility of an external connector. You can add another Bridge-File drive or Sysgen's high-performance tape back-up system, Bridge-Tape.™ (As a Bridge-File owner, you receive a total savings of \$135 on Bridge-Tape!) What's more,

Sysgen's footprint is smaller. A full 50% smaller than IBM's. For the best PS/2 access to 5¹/₄" disks, and the best value at only \$325, insist on Sysgen Bridge-File.

Sysgen offers the only complete family of data transfer products: Including the 3¹/₂" Bridge-File floppy disk drive, for transferring information from any PS/2 to any PC. And the Bridge-Tape subsystem that's

PC and PS/2 compatible, giving you total tape back-up and data transfer flexibility.

Call for Sysgen literature or for the location of the Sysgen dealer nearest you.



INFO HOTLINE 1-800-821-2151

SYSGEN
INCORPORATED



The Zenith Z-386

Ed McNierney

*Faster than the PS/2
Model 80 and fully compatible
with the IBM PC AT*

The Z-386 backplane design features an unusual approach to high-speed bus expansion. In this design, the backplane, or system board, serves as a power and bus connection system into which you plug other circuit boards. One advantage to this is that if a part fails, it is likely to be on a removable circuit board. The Z-386's backplane has two 8-bit slots, two AT-compatible 16-bit slots, and six 32-bit slots.

The Z-386, at the high end of Zenith's MS-DOS desktop computers, combines the speed of a 32-bit 80386 processor with IBM PC AT compatibility.

The basic system comes in two models, differentiated by the amount of hard disk space: The Model 40 (\$6499) contains a 40-megabyte hard disk drive, and the Model 80 (\$7499) has an 80-megabyte hard disk drive. Both models include a 16-MHz 80386 processor, which requires one 32-bit slot and has a socket for either an 80287 or 80387 math coprocessor; a Z-505 memory board containing 1 megabyte of two-wait-state 100-nanosecond RAM (it requires one 32-bit slot); a 1.2-megabyte floppy disk drive and one of the hard disk drives (the disk controller requires one 16-bit slot); an I/O board containing one serial port and one parallel port (the board requires one 32-bit slot); a 31.5-kHz video display board, which occupies one 8-bit slot and includes EGA, CGA, and Hercules hardware and software support; and five additional expansion slots—one 8-bit, one 16-bit, and three 32-bit slots. The basic system also includes MS-DOS 3.2 and Microsoft Windows/386.

You can expand memory in either 1-megabyte increments with the Z-505 memory card (\$699) or 4-megabyte increments with the Z-515 memory card (\$2199); each card of either kind requires

one 32-bit slot. You can provide the Z-386 with a maximum of 16 megabytes of RAM by filling the three remaining 32-bit slots with Z-515s and substituting another Z-515 for the Z-505 that comes with the basic system.

You can add Zenith's optional Z-525 64K-byte, zero-wait-state, 40-ns cache-memory board (\$599), which requires a 32-bit slot, and you can add another 1.2-megabyte or 360K-byte floppy disk drive, as well as another hard disk drive. The Z-386's 195-watt power supply and disk controller provide all the power and cabling necessary to support two floppy disk drives and two hard disk drives without upgrading or requiring additional expansion slots.

The system I reviewed was a Z-386 Model 80 with a 1.2-megabyte 5¼-inch floppy disk drive, an 80-megabyte hard

disk drive, the Z-449 video display board, and Zenith's excellent ZVM-1380-C 13-inch EGA color monitor (\$799). The review system also came with the optional 64K-byte cache memory board to cache the entire address space. Adding this optional board boosts system performance, as the benchmarks will show.

The Hard Facts

The Z-386 has a modular design based on Zenith's familiar "backplane," with plug-in components including the CPU, system memory, disk controllers, and standard I/O services. Most 80386 microcomputers feature at least one 32-bit expansion slot into which you can add fast peripherals such as memory. However, many slot designs are proprietary, and 32-bit hardware designed for one system can't be used with another. Much of the time, you can use these 32-bit slots only with special 32-bit circuit boards; if you are running out of slots, you may not be able to use a standard IBM PC or AT peripheral device in an unused slot.

While the 32-bit bus layout for the Z-386 is also proprietary, it is designed to be an extension of the AT's 98-pin connector. The 16-MHz, 32-bit, 160-pin slots can accept Zenith peripheral boards as well as AT-compatible boards. Those AT boards containing descenders—that is, portions of the board that drop down beyond the edge connector to gain more board space—won't fit, because the descenders hit the connector on the Z-386.

continued

Ed McNierney is a principal engineer at Lotus Development Corp. You can contact him at 54 Pleasant St., Groton, MA 01450, or on BIX as "mced."



Zenith Z-386 Model 80

Company

Zenith Data Systems
1000 Milwaukee Ave.
Glenview, IL 60025
(312) 699-4800

Components

Processor: 16-MHz Intel 80386; socket for optional 80287 or 80387 math coprocessor

Memory: 1 megabyte of two-wait-state RAM, expandable to 16 megabytes; 64K bytes of cache memory optional

Mass storage: One 1.2-megabyte 5¼-inch floppy disk drive; one 80-megabyte hard disk drive; expandable to one more floppy disk drive and one more hard disk drive

Display: MDA, CGA, Hercules, EGA, Enhanced EGA, and VGA

Keyboard: Modified 101-key enhanced keyboard layout

I/O interfaces: One serial port; one parallel port; five free slots: one 8-bit slot, one 16-bit slot, and three 32-bit slots

Other: Real-time clock/calendar with battery, 195 watts; 110-/220-volt switchable power supply; one year carry-in warranty

Size

6½ by 21 by 16½ inches; 38 pounds

Software

MS-DOS version 3.2; Microsoft Windows/386; Video Drivers software support

Options

80287 math coprocessor: \$525

80387 math coprocessor: \$1199

Z-505 1-megabyte RAM expansion: \$699

Z-515 4-megabyte RAM expansion: \$2199

Z-525 64K-byte cache memory: \$599

40-megabyte hard disk drive: \$1699

80-megabyte hard disk drive: \$1999

Documentation

130-page *High-Performance Workstation Owner's Manual*; 475-page *MS-DOS Version 3.2 User's Guide and User's Reference*; 20-page *Video Drivers Installation Guide*; 46-page *MS-DOS Version 3.2 Quick Reference Guide*

Price

Model 40: \$6499

Model 80: \$7499

Inquiry 885.

Test	Z-386 Model 80		PS/2 Model 80	Compaq 386	IBM PC AT
	no cache, no FPU	cache, no FPU	80387-16	80387-16	80287-8
Dhrystone*	3821	4136	3626	3748	1590
Fibonacci	53.17	49.43	57.26	53.11	126.22
Float	35.70	33.45	1.62	1.43	10.98
Savage	314.08	280.89	9.49	8.95	37.30
Sieve	5.84	5.38	6.45	5.98	24.60
Sort	8.02	6.92	7.74	5.58	43.17

* For the Dhrystone test only, higher figures denote faster performance.

DISK ACCESS IN BASIC (IN SECONDS)

WRITE

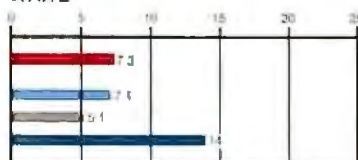

READ

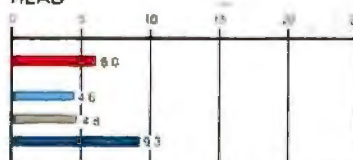

BASIC PERFORMANCE (IN SECONDS)

SIEVE

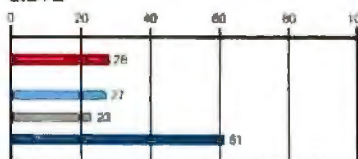

CALCULATIONS



SPREADSHEET (IN SECONDS)

LOAD



RECALCULATE



SYSTEM UTILITIES (IN SECONDS)

40K FILE COPY



■ ZENITH Z-386
■ IBM PS/2 MODEL 80
■ COMPAQ DESKPRO 386
■ IBM PC AT (8 MHZ)

The table contains the results of C language benchmarks (see "A Closer Look" by Richard Grehan in the September 1987 BYTE). All times are in seconds, except for the Dhrystone, which is in Dhrystones per second. The Disk Access benchmarks write and then read a 64K-byte sequential text file to a hard disk. Sieve runs one iteration of the Sieve of Eratosthenes. Calculations performs 10,000 multiplication and division operations. The Spreadsheet tests load and recalculate a 100-row by 25-column Multiplan (1.06) spreadsheet. The 40K File Copy benchmark copies a 40K-byte file on the hard disk. All BASIC benchmark programs were run with MS-DOS 3.20 and GWBASIC 3.20 on the Zenith Z-386 Model 80; PC-DOS 3.3 and BASICA 3.3 on the PS/2 Model 80 and PC AT; and Compaq DOS 3.1 and Compaq BASIC 3.11 on the Deskpro 386.

However, most AT boards will fit, and the added flexibility is convenient.

The Z-386 features standard EGA-compatible graphics that can send video output to a variety of different monitors. In addition to supporting MDA, CGA, Hercules, and EGA monitors, the Z-449 video adapter can drive a 31.5-kHz analog monochrome or color monitor, such as those supported by IBM's PS/2 computers. The Z-449 directly supports a special EGA-like 480-line display on VGA analog monitors, and Zenith provides a disk of video drivers to support the 480-line mode in Lotus 1-2-3, Lotus Symphony, AutoCAD, GEM, and Microsoft Windows. [Editor's note: For further discussion of the Z-449, see "Enhanced EGA and VGA Boards" by Curtis Franklin Jr. on page 102 of this issue.]

On the rear of the system unit are two sockets for monitors: one for a VGA or compatible monitor and one for the other supported monitors. The sockets are easy to differentiate, however: The VGA monitor socket has 15 pins in three rows, and the other has 9 pins in two rows. In other words, the plug on your monitor will fit only in the appropriate socket, so there's no chance of mixing them up.

When I connected the monitor to the system unit, it displayed only a solid white screen. Even though the review system came with an EGA monitor, Zenith configured the system at the factory to support an analog VGA monitor. I solved the display problem by setting off video DIP switch 6 (accessible from the outside of the unit)—but only after searching the documentation for the solution and finally finding it in Chapter 4 of the owner's manual. I think Zenith should include information addressing common setup problems in the "Getting Started" chapter at the front.

The on/off switch for the monitor is on the front; it is a push button labeled "I/O." The monitor also has a feature I haven't seen before: On the front is a three-position dial that lets you choose either the standard color output (black and white for text at the default settings) or monochrome output in amber or green.

Zenith's enhanced 101-key keyboard closely emulates the 101-key layout used on IBM's PS/2 and AT computers, and it has a soft touch with an audible clicking feedback system in the keyboard unit itself. Zenith has made one change to the IBM layout: Instead of placing the backslash (\) key to the left of the single-width Backspace key, as IBM does, Zenith has enlarged the Backspace key to double-width and placed the backslash key to the right of a truncated right Shift key. It's a small change, but I find it difficult to switch between layouts.

On the positive side, the Z-386's keyboard features a well-designed accelerated key-repeat feature. When you press a key and hold it down, it begins to repeat at a standard rate; but the longer you hold it down, the faster it repeats, making long cursor movements convenient and rapid.

You can use the keyboard with either AT- or XT-compatible computers; there is an AT/XT switch under the nameplate on the upper left. The keyboard comes set up for AT compatibility, and if you wish to use XT compatibility, you need to add appropriate firmware and change the switch setting.

The Software Scene

In addition to MS-DOS 3.2 and Microsoft Windows/386, the Z-386 comes with a ROM-based Monitor program that provides access to a Setup/Configuration program that lets you configure your system from the keyboard; a Test program that has extensive disk-read, keyboard, base-memory, expansion-memory, and power-up diagnostic tests; a series of debugging tools, including *Eaddress* (examine memory), *Iport* (input from port), *R[register]* (examine register), *T[count]* (trace program), and *U[ranga]* (unassemble program), where brackets denote an optional parameter. To activate the Monitor program, you press Ctrl-Alt-Insert.

The Z-386 provides a flexible disk-boot mechanism. The Setup/Configuration program lets you tell the system where to look for its bootstrap record; you can choose to boot automatically from the floppy disk or the hard disk, or from the floppy disk when it is mounted and from the hard disk when it isn't. You can also choose to have the system come up displaying the Monitor program's prompt, at which time you can boot from whatever drive you wish with the boot command *B[parameters]*.

Although the Z-386 comes with Zenith's version of MS-DOS 3.2, the operating system is not preinstalled on the hard disk. When I first powered up the review system (after setting the DIP switch), the screen displayed the error message Not a bootable partition. The "Getting Started" section of the owner's manual explained that at this point you reset the computer with the Ctrl-Alt-Insert combination to go to the Monitor program. From there, you mount the first MS-DOS disk and enter *B F* (which stands for "boot from floppy"). The boot sequence on the floppy disk initiates the MS-DOS SETUP utility.

This reveals a couple of problems that Zenith could easily have avoided. First, SETUP is not the same as the Setup/Configuration program, but Zenith doesn't

tell you that there are two different programs involved. This is confusing; you think you're going to enter the Setup/Configuration program, but you aren't. So, any attempt to jump ahead can easily put you in the wrong place. For instance, if at the monitor prompt you select the option for the Setup/Configuration program, you have actually bypassed the SETUP utility, and your hard disk has not been formatted. Thus, you can find yourself in quite a mess. A different name for one of the programs would have avoided this confusion.

Second, Zenith has set the system to automatically try to boot up on the hard disk. This doesn't make much sense when you consider that the hard disk doesn't contain an operating system; in fact, it isn't even formatted. It would make more sense to set the initial system default to boot from the floppy disk.

The SETUP utility formats your hard disk and transfers your system to it, if you wish, through a user-friendly conversational interaction. The hard disk comes unformatted with one partition. If you want more than one, you can use the MS-DOS PART utility to set them up. SETUP tells you when to exit and execute PART, and the two utilities give you instructions on all the procedures you need.

You can also use some other MS-DOS utilities if you need to modify the hard disk organization and protections. You can use DSKSETUP and ASGNPART to create more than one MS-DOS partition and assign disk drive letters to those partitions. Then you can format the partitions with the MS-DOS FORMAT command to make them usable and bootable.

The DSKSETUP utility adds a convenient feature to the hard disk layout: format protection. With DSKSETUP, you can protect each partition on the hard disk from accidental reformatting; only another DSKSETUP command can release the protection and allow the disk to be reformatted. ASGNPART lets you assign the connections between MS-DOS disk drive letters and the logical disk partitions created by DSKSETUP. Partitions can all receive flexible name assignments.

Zenith's version of MS-DOS includes a number of custom software utilities, including APPLY (to execute a command repeatedly while varying a specific parameter); CONFIGUR (to tell the system the correct protocol to use for a serial or parallel device and display the system configuration); FC (to compare two files and send any differences it finds to the screen or to another file); RTCLOCK (to read the real-time clock and set the MS-DOS clock to that date and time, and reset the real-time clock); SEARCH (to scan a disk

continued

WHAT WOULD YOU DO WITH

16

MODEMS ON A SINGLE PC?

HOW ABOUT 64?

- Up to 16 modems on one single-slot plug-in card
- Up to 64-user capability simultaneous & interactive
- Runs on any PC compatible under MS-DOS V3.X
- User-modifiable C source code included
- Menu-oriented operation
- Complete accounting capability w/audit trail
- Extensive SYSOP displays
- Powerfail-protected data
- "Midnite-Cleanup" feature
- Full one year warranty on hardware

Mega BBS applications
on Microcomputers

- Teleconferencing
- Electronic Mail
- File Upload/Download
- Order Entry
- Database Look-up
- On-line Expert Systems
- Catalog Scanning
- Classified Advertising Svcs
- Educational Services
- Banking/Financial Services
- Brokerage Services
- Customer Service
- Insurance Claims Processing
- Multiple Listing Services
- Field Quotes
- Sales Office Communications
- Reservations Services
- SIG Conferences
- Stock Prices
- Telephone Directories
- Travel Agency Services
- Yellow Pages
- Surveys/Polling
- Multi-Player Games

BREAKTHROUGH!

Combine our single-slot card with our sophisticated BREAKTHROUGH software and you have a BBS that performs like a mainframe on a 286/386 machine... with only one cable coming out the back! Completely self-contained, with no external hardware necessary, the system is extremely reliable, flexible and fast.

Successfully in use at over one hundred installations, BREAKTHROUGH allows up to 64 users to interact with each other and with the system simultaneously. Up to 16 modems are available on one single slot card. Extensive and growing third party developer support offers a wide variety of applications for many fields.

The only way to experience our BREAKTHROUGH is by trying it yourself. For \$59.00 we'll rush you a copy of The Major BBS (our multi-user Bulletin Board System), the C source, and a 175 page book explaining the system. This includes everything except the single-slot modem card and the low-level "device driver" object library package. Single slot modem cards are available separately in a variety of configurations and with any number of modems (up to 16) that you may require.

305/583-5990

GALACTICOMM

The Leader in BBS for the PC

4101 SW 47th Avenue, Suite 101 Fort Lauderdale, FL 33314

REVIEW: THE ZENITH Z-386

and display all files that match the input specification); ZCOM (to use a modem or direct serial communications to transfer files between two computers); and ZSPOOL (to create a print buffer in either conventional or expanded memory).

In addition, the Expanded Memory Specification device driver, EMM.SYS, comes on the MS-DOS distribution disk. You can set up as much of your memory as you wish to be EMS memory, as long as your first memory card reserves at least 640K bytes as system memory.

The Z-386 is completely AT compatible, running all the tested software and hardware without any problems, including Microsoft Windows version 1.03, Lotus 1-2-3 version 2.01, SideKick version 1.56A, the Microsoft bus Mouse version 6.10, the Everex Evercom 1200-bit-per-second modem, and Lotus Manuscript version 1.0. As is common with 80386 systems, the Z-386, via the Setup/Configuration program, lets you select one of three operating speeds: Slow, which is a constant 8-MHz operation; Fast, a constant 16-MHz operation; or Smart, in which the CPU runs at 16 MHz for processing and slows to 8 MHz for disk I/O operations. The default mode, Smart, lets you install (and deinstall) copy-protected software, such as Lotus 1-2-3 version 2.01, on the hard disk without difficulty.

[Editor's note: *While we were working with the Z-386, the system hung on two separate and unrelated occasions. We could enter nothing, and we got no response; we couldn't even reboot. We had to turn the machine off and then on again to free it. We also couldn't re-create the situations. Thus, we have no idea whether this is a recurring problem or a fluke.*]

On the Bench

Zenith's literature claims a 40-millisecond average access time for the 80-megabyte hard disk drive, but Core International's Coretest utility measured a much more respectable 27-ms average seek time, with track-to-track seeks requiring only 4.3 ms. The drive also performed well on the disk-transfer-rate test, with a transfer rate of 205.5K bytes per second.

The EGA display system ran all tested graphics software, including Microsoft Windows versions 1.03 and 2.0 and PC Paintbrush Plus version 1.0, with no problems. Video memory required 30 wait states for each access, but this is not unusual for an EGA board running in a 16-MHz 80386 machine. As 32-bit machines become more common and users become more demanding of graphical interfaces, EGA-compatible hardware will need to be redesigned for higher speed, so that it fits more appropriately with the

performance of the rest of the system.

BYTE's BASIC benchmarks show that the Z-386 without its optional cache memory is generally comparable to other 80386 machines; its performance is slightly slower in some tests and slightly faster in others.

The Z-386 becomes more impressive in the C benchmarks, which are more indicative of computing power and ability among the 80386 machines. Without its optional cache, the Z-386 exceeds the performance of the IBM PS/2 Model 80 by 5 percent on the Dhrystone test, and it beats that of the 16-MHz Compaq Deskpro 386 by 2 percent. With the cache memory, these figures jump to 14 percent over the PS/2 and 10 percent over the Compaq (and an 8 percent increase over the Z-386 without the cache).

On the Fibonacci test, the Z-386 shows a slight edge over the Model 80 and a speed equal to the Compaq's. Adding the cache boosts performance by about 8 percent. The review system didn't have a floating-point coprocessor, so the Float and Savage benchmarks indicate only that if you do many floating-point or transcendental calculations, you will want one.

On the Sieve test, the Z-386 shows a 10 percent improvement over the Model 80 and a small (2 percent) improvement over the Compaq. The Sort benchmark is the only one in which the Z-386 falls behind the others. It lags behind the Model 80 by 4 percent, and behind the Compaq Deskpro by a whopping 44 percent. The cache memory boosts the Z-386's Sort time by 16 percent, however.

Coupled with Zenith's reputation for service and reliability, the benchmarks overall indicate that the Z-386 is an excellent machine to use as an 80386 computing platform. They also indicate that the additional expense of the Z-525 64K-byte cache memory board is well worth the performance boost it provides.

An Outstanding Machine

The Zenith Z-386 is a powerful machine and a sound value for your computing dollar. Its compatibility with the PC AT is flawless, and its performance is among the best in its class. Its raw computing horsepower is made even more useful by Zenith's unusually helpful assortment of ROM and MS-DOS utility software.

The manual could be better organized and some of the setup choices more logical. However, these things bothered me partly because the Z-386 is such an outstanding machine: It's frustrating to have a terrific machine at your fingertips and then have a struggle setting it up. Take the instructions slowly and carefully, and don't try to jump ahead, and I think you'll avoid the troubles I had. ■



An Incredible Display Of Power And Versatility.

For just \$599,* the new 965 gives you ASCII, ANSI and IBM® PC compatibility in one terminal.

The new 965's versatility is unparalleled. It supports 23 terminal emulations, more than any other model in its class. You even get your choice of ASCII, ANSI or IBM Enhanced PC keyboard styles.

There's a 14" flat display in green or page-white with crisp, clear characters in a high-resolution 10x16 matrix. A 2-position keyboard with a true accounting keypad, 20 user-

programmable editing keys, and 128 programmable function keys.

The 965 can display up to 49 data lines, enough to show large spreadsheets or two normal display pages of text at the same time. No other terminal this affordable can do that.

The 965's state-of-the-art single board design uses a 16-bit CPU and sophisticated gate array to give you a high-performance, very reliable terminal with a full one-year end-user limited warranty.

The 965. A whole new look in terminals from TeleVideo. Call us toll-free or write today for more information.

TeleVideo Systems, Inc.,
1170 Morse Ave., Sunnyvale, CA
94088-3568.

 **TeleVideo**®
THE VISION YOU NEED TO SUCCEED

Call 1-800-835-3228

WATCH WHAT YOU'RE DOING.



Introducing UniLab 8620 analyzer-emulator with InSight.

■ There's nothing like InSight.™ A feature of the new 8620 that lets you actually watch your program go through its paces. So you can debug faster. And speed up microprocessor development. For demanding applications like the automotive controller shown.

■ An exciting industry first, InSight blends analyzer/emulator techniques to give you continuous, real time monitoring of key processor functions. See changing register contents, I/O lines, ports, user-defined memory windows. With your own labels. And all at once. Interactively. Without stopping your program.



■ InSight is made possible by the 8620's advanced bus state analyzer, its 2730-bus-cycle trace buffer, and a new high-speed parallel interface that eliminates RS-232 bottlenecks.

■ The fast interface also speeds data throughput. From your hard drive, you can load a 64K program into emulation memory in five seconds.

■ On top of that, you get a new, crystal-controlled 1 μ sec clock for super precise event timing.

■ Computer integrated instruments from Orion prove debugging needn't be costly or tedious. For more than 150 processors. Like all our analyzer-emulators, the 8620 debugs by symptom. Via advanced truth table triggering. Always included is enough breakpointing and single stepping (now faster than ever) to assure optimum efficiency. We even provide a stimulus generator and built-in EPROM programmer to help finish the job.

■ Get serious about price/performance. Save big on design, test, and support costs. UniLab 8620 analyzer-emulator.

■ Look into it.

Toll free: 800/245-8500. In CA: 415/361-8883.

ORION
INSTRUMENTS

Computer Integrated Instrumentation
702 Marshall Street, Redwood City, CA 94063
Telex: 530942

*InSight is a trademark of Orion Instruments, Inc.

Circle 191 on Reader Service Card



NEC PowerMate 2 and HP Vectra ES/12

John Unger

*Two mature AT-compatible
designs that offer higher speed
and greater reliability*

The NEC APC IV PowerMate 2 and the Hewlett-Packard Vectra ES/12 represent two of the best of a generation of microcomputers that are based on IBM PC AT compatibility and the 80286 CPU. Both NEC and HP apparently believe that computers based on the 80286 have not reached the end of their development. The companies offer the PowerMate 2 and the Vectra ES/12 as the best price/performance solution for many business and personal needs.

The Vectra and the PowerMate both have dual-speed 80286 processors: The PowerMate can be switched between 10 MHz and 8 MHz, and the Vectra runs at 12 MHz or 8 MHz. The machines are more than adequate for nearly all the needs of the average microcomputer user. Furthermore, they are compatible with the multitude of software and hardware developed for the IBM PC AT.

The PowerMate I reviewed had 1 megabyte of 120-nanosecond and 150-ns RAM; the Vectra had 640K bytes of 120-ns and 100-ns RAM. They both came with EGAs and monitors and high-performance hard disk drives: The PowerMate had a 67-megabyte drive, and the Vectra had a 40-megabyte unit. The PowerMate also came with an optional 1 megabyte of extended RAM. In these enhanced configurations, the PowerMate costs \$5595, and the Vectra \$5535.

The basic version of each computer comes with one 1.2-megabyte 5¼-inch floppy disk drive, a floppy disk/hard disk drive controller card, and 640K bytes of RAM. In these versions, the PowerMate costs \$2595 and the Vectra is \$2995.

Internal Circuitry

Both computers use very-large-scale integration (VLSI) chips from Chips and



The NEC PowerMate (left) and HP Vectra (right).

Technologies (C&T). The Vectra uses five of these surface-mounted packages on its motherboard, and the PowerMate uses six. The optional EGAs that were part of my review systems each used two of these C&T packages. VLSI packages reduce the total chip count in the computers and allow a cleaner design. Like many other AT clones, both use Phoenix Technologies' ROM BIOS—firmware well known for its compatibility with the IBM operating-system ROM.

In addition to five 16-bit and two 8-bit expansion slots (the disk controller occupies one of the 16-bit slots, and the EGA card fills one of the 8-bit slots), the Vectra's motherboard holds a special expanded memory slot, which can only be used for an optional Vectra ES expanded

memory card. This slot looks like an 8-bit slot, but the board connector has been moved forward on the motherboard. The slot can't be used for standard PC expansion boards. You can populate the expanded memory board with up to 8 megabytes. The slot runs at 12 MHz, rather than 8 MHz like the other slots on the expansion bus; this factor gives the Vectra faster memory I/O for those applications that use expanded memory.

The PowerMate has six 16-bit expansion slots and two 8-bit slots on its motherboard. The PowerMate's disk controller card occupies one of the 16-bit slots, and the EGA card fills one of the 8-bit slots. The optional NEC memory board that I installed in my review machine fits in one of the 16-bit slots. This board comes with 18 256K-bit by 8-bit 120-ns RAM chips soldered to it, for a total of 512K bytes of additional memory. Three more memory kits consisting of 18 256K-bit RAM chips may be added for a total of 2 megabytes of RAM for

each board. You can add a total of five fully populated boards to each PowerMate.

The PowerMate features a zero-insertion-force (ZIF) socket for its 80286 pin-grid-array CPU. This makes removing or replacing the chip very easy.

Both systems let you switch speeds either from the keyboard or with simple software commands. I had no difficulty switching speeds on either computer, even in the middle of a program. The

continued

John Unger is a geophysicist for the U.S. government. He writes graphics software and uses computers to study the earth's crust. You can reach him at P.O. Box 95, Hamilton, VA 22068.

PowerMate has a convenient LED indicator on the front panel that lights when the computer is running in the high-speed or 10-MHz mode. The Vectra gives one beep when you shift to 8 MHz, and two beeps when you go to 12 MHz. Each computer's motherboard has a socket for an optional 80287 numeric coprocessor.

Storage

The PowerMate's larger size provides room for five half-height storage devices. The Vectra has a more conventional layout, with space for three half-height storage devices.

The hard disk drive that came with my PowerMate was NEC's D5452, a high-performance 67-megabyte model with a data transfer rate of 247.4K bytes per second, an average seek time of 25.3 milliseconds, and a track-to-track time of 6.3 ms, according to the Coretest program. Vectra's 40-megabyte Seagate ST-251 hard disk drive is only slightly slower: It has a data transfer rate of 244.7K bytes per second, an average seek time of 26.7 ms, and a track-to-track time of 10.5 ms.

Because MS-DOS 3.2 does not support a logical disk drive larger than 32 megabytes, I partitioned the 67-megabyte drive into two 32-megabyte drives and one 3-megabyte drive. The utility setup and formatting programs that came with the Vectra and the PowerMate were easy to follow, and getting the hard disks set up properly was not difficult.

The Vectra comes with HPCACHE, a disk-caching utility program for the computer's hard disk. This versatile program lets you set aside either normal or EMS memory as a cache. Disk-cache routines such as HPCACHE can improve the overall performance of your system, particularly if you use software that frequently accesses the hard disk—such as a program that uses overlays or a compiler that stores and retrieves intermediate temporary files as it compiles source code. In use, the cache provided a 10 percent to 40 percent improvement in the benchmark results.

The Vectra and PowerMate disk controller cards come with cabling and connectors for a total of two floppy disk drives and two hard disk drives. This setup gives you a variety of possible combinations of hard and floppy disk drives for the systems. Both systems' software and hardware support the addition of 3 1/2-inch floppy disk drives; the Vectra can handle either 720K-byte or 1.4-megabyte drives, while the PowerMate only has the option of adding a 720K-byte drive. The Vectra's disk controller card also contains the logic for the serial and parallel ports. On the PowerMate, the two DB-9 serial

NEC PowerMate 2, Model APC-H503C

Company
NEC Information Systems Inc.
1414 Massachusetts Ave.
Boxborough, MA 01719
(617) 264-8000

Components

Processor: 10-MHz Intel 80286; socket for optional 80287 math coprocessor
Memory: 1 megabyte, expandable with 2-megabyte expansion boards to 10.6 megabytes
Mass storage: One 1.2-megabyte 5 1/4-inch floppy disk drive; 67-megabyte hard disk drive
Display: MultiSync monitor and EGA card
Keyboard: 101 full-size keys with 12 function keys and separate editing keys and numeric keypad
I/O interfaces: Two 8-bit and six 16-bit expansion slots; two RS-232C ports (DB-9); one parallel printer port (DB-25)

Size

6 1/2 by 21 1/2 by 17 inches; 41 pounds

Software

MS-DOS 3.2; GWBASIC 3.2

Options

Color graphics adapter board: \$225
Advanced Graphics Board plus PowerMate MultiSync monitor: \$1350
Memory expansion board with 512K bytes of RAM: \$395

Documentation

69-page *PowerMate 2 Owners Guide*;
407-page *GWBASIC User's Guide*; 468-page *MS-DOS User's Guide*

Price

Model APC-H503C (unit reviewed): \$5595
Model APC-H500K (no hard disk drive or monitor): \$2595
Model APC-H501D (40-megabyte hard disk drive and EGA monitor): \$4345

Inquiry 884.

Hewlett-Packard Vectra ES/12, Model 42

Company
Hewlett-Packard Corp.
3000 Hanover St.
Palo Alto, CA 94304
(415) 857-1501

Components

Processor: 12-MHz Intel 80286; socket for optional 80287 math coprocessor
Memory: 640K bytes of RAM on motherboard standard; up to 8 megabytes on optional Vectra ES expanded memory card
Mass storage: One 1.2-megabyte 5 1/4-inch floppy disk drive; 40-megabyte hard disk drive
Display: EGA card standard; 13-inch enhanced color display
Keyboard: 101 full-size keys with 12 function keys and separate editing keys and keypad
I/O interfaces: Two 8-bit and five 16-bit expansion slots; one expanded memory slot; one RS-232C port (DB-9); one parallel printer port (DB-25)

Size

6 1/2 by 16 1/4 by 15 1/2 inches; 34 pounds

Software

MS-DOS 3.2; HP utilities and system diagnostics, including Personal Applications Manager, DOS shell, terminal-emulation program, disk-cache program

Options

3 1/2-inch 1.44-megabyte floppy disk drive: \$325
5 1/4-inch 360K-byte floppy disk drive: \$225
80287-8 math coprocessor: \$450
Monochrome monitor: \$325
Enhanced graphics monitor: \$845
Expanded memory card with 2 megabytes of RAM: \$1695

Documentation

120-page *Vectra MS-DOS 3.2 Vol. 1, Introduction*; 585-page *Vectra MS-DOS 3.2 Vol. 2, User's Reference*; 245-page *Setting Up the Vectra ES*; 110-page *HP Terminal Program User Manual*; 146-page *Using Personal Application Manager*; 112-page *Using the Multiple Character Set Utilities*

Price

Model 42 (unit reviewed): \$5535
Model 10 (640K bytes of RAM and one 1.2-megabyte 5 1/4-inch floppy disk drive): \$2995
Model 20 (same as Model 10, plus a 20-megabyte hard disk drive): \$3195
Model 40 (same as Model 10, plus a 40-megabyte hard disk drive): \$4195

Inquiry 883.

DISK ACCESS IN BASIC (IN SECONDS)

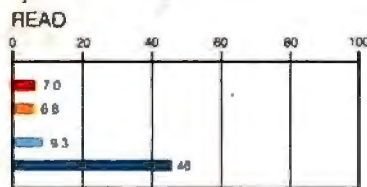
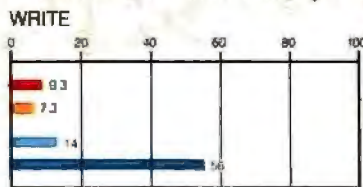

BASIC PERFORMANCE (IN SECONDS)

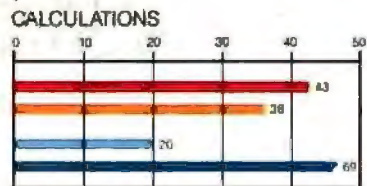
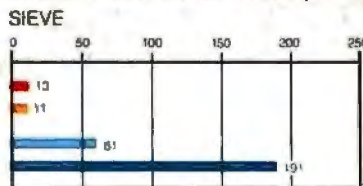

SPREADSHEET (IN SECONDS)

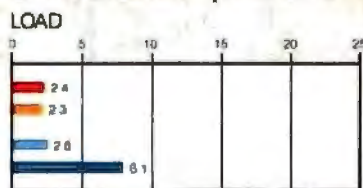

SYSTEM UTILITIES (IN SECONDS)

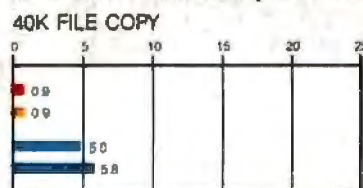

- NEC POWERMATE 2
- HP VECTRA ES/12
- IBM PC AT (8 MHz)
- IBM PC

ports and the DB-25 parallel port are part of the motherboard's circuits.

Externals

The most obvious difference between the two computers is their size. The PowerMate is about 4 inches wider than the Vectra and uses this extra space to provide two more half-height slots for storage devices.

Both computers have keyboards patterned after the IBM enhanced keyboard. The feel of both keyboards is good, even though they are rather different. I fell in love with the PowerMate's the first time I used it. It has a rather light touch, with a mechanical click built into the keys, and it is good for fast typing. The Vectra's keyboard is a bit stiffer, but it has a similar feel, with a definite break before the key actually enters its character. I just can't seem to type as fast on it as I can on the PowerMate's. The key click on the Vectra comes from software rather than from the keyboard, and you can easily change its amplitude or remove it altogether by using the Control, Alt, and Plus (+) keys.

The EGA boards and monitors on both computers performed flawlessly, and the colors and resolution of the displays were good. You might expect this from the PowerMate; the "Advanced Color Display" sold with this system is the popular NEC MultiSync, which has received well-deserved praise in many reviews. Mitsubishi manufactures HP's enhanced graphics display. It has a fine screen and great color, and it automatically selects scan frequencies between 15.75 and 21.85 kHz. I give the edge to the PowerMate 2's display; it is crisper, and the character set used by NEC is easier on the eyes. Because of its 35-kHz maximum scan frequency, the MultiSync monitor also has the advantage of upward compatibility with VGA cards' higher-resolution graphics modes.

Performance and Compatibility

There are no mysteries when comparing these two computers. As the benchmark results show, the Vectra's 12-MHz mode gives it a 3 percent to 27 percent performance edge over the PowerMate running at 10 MHz. The Vectra's performance edge increases when it is run with the disk-caching program in place.

Although it is not explicit from their specifications, both of these machines operate with one wait state and therefore give up a slight speed advantage. Both computers are probably in the top 10 percent of all AT clones in terms of calculating speed; the only 80286 machines that outperform them are those few that run at

continued

The Disk Access benchmarks write and then read a 64K-byte sequential text file to a hard disk. Sieve runs one iteration of the Sieve of Eratosthenes. Calculations performs 10,000 multiplication and division operations. The 40K File Copy benchmark copies a 40K-byte file on the hard disk. The Spreadsheet tests load and recalculate a 100-row by 25-column Multiplan (1.06) spreadsheet. The BASIC benchmarks were run with MS-DOS 3.2 and GWBASIC 3.2 on the NEC PowerMate and HP Vectra; tests on the IBM PC and PC AT were run with PC-DOS 3.3 and BASICA 3.3.

HOW DO YOU GET A JOB WITHOUT EXPERIENCE? AND HOW DO YOU GET EXPERIENCE WITHOUT A JOB?

Most young people have one answer to this problem. They avoid it until they're out of college. But they could be getting solid work experience while they're still in college. With your company's help. And ours.

We're Co-op Education. A nationwide program that helps college students get real jobs for real pay, while they're getting an education.

But we can't do it without you. Those real jobs have to come from real companies. Like yours.

For more information on how you can participate in this valuable program, write Co-op Education, Box 775E, Boston, MA 02115.

Not only will you be giving students a chance to earn money and pick up the most valuable kind of knowledge, you'll be giving yourselves a chance to pick up the most valuable kind of employee.

Co-op Education.

You earn a future when you earn a degree.

10 or 12 MHz with zero wait states. The high-performance disk drives add to the overall speed of the two systems.

I had no problems running my normal stock of software, which includes WordPerfect 4.1, Reflex 1.1, Condor 3, Multiplan 1.06, a variety of C compilers (Turbo C 1.0, Microsoft C 4.0, and DeSmet C 2.5), and the C-terp 3.00 interpreter, on either computer at its highest speed setting. Most of the games I ran—Jet, Starflight (which needs an EGA patch), Pinball Construction Set, and Flight Simulator—functioned reliably.

Warranty, Service, and Quality

HP has a well-deserved reputation for making reliable and well-designed computers. Its dedication to quality carries over into its Vectra series; my review system was a well-built, well-designed piece of hardware. HP offers a limited one-year warranty that covers carry-in service at an authorized dealer or the manufacturer.

The first microcomputer I reviewed for BYTE was the NEC APC III, a predecessor to the PowerMate reviewed here. The qualities that impressed me in the APC III—its design, construction, and graphics—are even more apparent in the APC IV PowerMate, and this time the system is 100 percent compatible with the IBM PC AT. NEC has a one-year warranty for its machines that is similar to HP's. Service should be easy to find due to NEC's extensive national network of dealers.

Up to Snuff, and Then Some

The 80286 AT-compatible market is now at a mature stage. This means that potential buyers of this class of microcomputer must look at small, perhaps even subjective, features when comparing different machines. The NEC and HP systems have an advantage over most of the no-name AT clones now flooding the marketplace because they are backed by companies with large, well-known sales and service groups. The Vectra ES/12 and the APC IV PowerMate 2 are both going to be supported for years to come. The amount and quality of documentation is also quite good—an important point for less-experienced users to keep in mind.

If you want a high-performance AT-compatible computer with excellent expansion capability, either of these machines will do the job for you. Obvious differences are the Vectra's lead in computing performance and the PowerMate's larger expansion chassis. My choice would be the PowerMate, because of the feel of its keyboard and the extra serial port, and because it is available at highly discounted prices from many dealers and so is simply a better value at retail street prices. ■





The \$19.95 High-Performance C Compiler

Mix Software presents Power C... Our new cost-efficient alternative to high-priced C compilers. Now you can create high-performance programs without spending all your hard-earned money. But price isn't the only reason to choose Power C over the competition.

Compare the performance. Power C's integrated Make saves you time and effort by automatically managing your large programming projects. And with Power C, your programs can be as large as available memory. As for speed, the performance chart speaks for itself. Power C executes most of the benchmarks faster. And Power C creates smaller EXE files, out-performing the competition.

Compare the functions. With over 400 functions, the Power C library is vastly superior. Our library is a superset of Microsoft C and Turbo C. Plus, we've added an extensive set of graphics functions for drawing lines, boxes circles, pie charts, and more.

Compare the portability. Power C supports the latest features of the proposed ANSI C standard. Plus, Power C is compatible with both Microsoft C and Turbo C. All of which makes it easier to move programs to and from Power C.

Compare the documentation. Our competition assumes that you're already a C wizard. We don't. Power C includes a step-by-step tutorial and sample programs with every function. With our complete documentation, programming in C couldn't be easier.

Power C is factors less expensive. And the source code to our function library is available at a fraction of their price.

Performance Chart (execution times in seconds)			
	Power C	MS C	Turbo C
1) fib*	23.8	47.0	26.4
2) sieve*	27.8	40.2	25.5
3) tdbi*	3.5	9.0	9.6
4) diskio*	13.5	14.2	14.3
5) report**	11.0	88.3	60.7
6) drystone**	36.6	38.2	31.8
Compile/Link	73.9	187.6	81.4
EXE File Size	25120	29008	27184

Price Chart			
C Compiler	Power C	MS C	Turbo C
C Compiler	\$19.95	\$450.00	\$99.95
Library Source Code Option	\$10.00	N/A	\$150.00
Total Cost with Source	\$29.95	N/A	\$249.95

Technical Specifications

Power C includes: Power C compiler with integrated Make, Power C linker, Power C Libraries, Power C book, and support for...

- ANSI standard
- IEEE floating point
- 8087/80287 coprocessor
- auto-sensing of 8087/80287
- automatic register variables
- mixed model (near & far pointers)
- CGA, EGA, & Hercules graphics

Options are...

- Library source code
- BCD business math

Order Power C now by calling our toll free number or mail the coupon to Mix Software, 1132 Commerce Drive, Richardson, TX 75081.

1-800-523-9520

For technical support and for orders inside Texas call: 1-214-783-6001

Minimum System Requirements: MSDOS or PC DOS 2.0 or later, 256K memory, 2 floppy drives or hard drive recommended. Runs on IBM PC, XT, AT, and compatibles, and IBM PS/2 model 25, 30, 50, 60, or 80.

60 day money back guarantee

Name _____
 Street _____
 City _____
 State _____ Zip _____
 Telephone _____

Paying by: Check Money Order
 MC/Visa/Exp _____ Exp _____

Computer Name _____ Disk Size _____
 5 1/4" 3 1/2"

Product(s) (Not Copy Protected)

Power C (\$19.95) \$ _____
 Library Source Code (\$10) \$ _____
(includes an assembler)

BCD Business Math (\$10) \$ _____

Texas Residents add 8% Sales Tax \$ _____
 Add Shipping (\$5 USA - \$20 Foreign) \$ _____
 Total amount of your order \$ _____

Power C is a trademark of Mix Software.
 Microsoft C is a registered trademark of Microsoft Corporation.
 Turbo C is a registered trademark of Borland International B

Benchmarks from Dr. Dobb's Journal* & Computer Language**. First four programs test 1) function calling, 2) loops/integer math 3) floating point math, & 4) disk I/O. Programs 5 & 6 simulate typical applications. Tests compiled from command line using Make supplied with each compiler. Tests run on 8 MHz AT with medium model of Power C 1.0, MS (Microsoft) C 4.0, & Turbo C 1.0.

Circle 180 on Reader Service Card





CLEO
now delivers
3278 coax cards
at **\$795.00!**



and now coax!

CLEO is your SNA or BSC Gateway

Remote Sites Communication

Whatever your industry, your remote computers need to share information with your mainframe. Or, they need to exchange data with other remotes. In either case, you need a total solution at the remote sites. You need software, hardware interfaces and modems that all work together smoothly. You need CLEO!

CLEO software products allow micro-computers to communicate with mini-computers and mainframes, and to emulate their workstations. Since 1981, CLEO has provided remote communications between micros and mainframes for the automotive, insurance, medical and banking industries. Today over 66,000 CLEO users worldwide are running on all major brands of micro-processors. The greatest number of these users run CLEO software on IBM Personal Computers and NETBIOS LANs.

Complete Software/Hardware Package

Every CLEO package contains all the software and hardware accessories needed at the remote site. Your selected CLEO SNA or BSC software is packaged with 1) an internal modem card for dial-up applications, or 2) an interface card and cable for use with your existing modem. There's no waiting for non-CLEO add-ons. And, you get prompt, single-source service.



Package prices range from \$795.00 for most stand-alone packages, up to \$1,995.00 for the 32-user SNA gateway.

Call us today to discuss your application.

CLEO Software
1639 North Alpine Rd.
Rockford, IL 61107
Telex 703639
FAX 815/397-6535

Headquarters:

USA: 1-800/233-2536
Illinois: 1-800/422-2536
International: 815/397-8110

Sales and Distribution:

Benelux: 31 (71) 215281
Canada, East: 800/361-3185
Canada, West: 800/361-1210
Canada, Montreal: 514/737-3631
Colombia, S.A.: 12172266
Denmark: 1628300
England: 0908667737
France: 146861136
Italy: (0331) 634 562
Mexico City: 596-5539
Sweden: 8 740 5070

CLEO 



The Tandy 1400 LT

David Satz

*This portable strikes
a sensible balance between basic
performance and economy*

At \$1599, the Tandy 1400 LT is less expensive than most other portables and laptops. It enters the field of IBM PC-compatible laptop computers in the middle in terms of processor power and portability, and near the bottom in terms of price. The speed of its 8088-compatible NEC V20 is software-switchable between 7.16 MHz and 4.77 MHz, placing its top speed between those of the 4.77-MHz IBM PC and the 8-MHz IBM PC AT. At 13½ pounds, it is lighter than some portables (the Compaq Portable 386, for example, weighs in at 20 pounds) and heavier than others (the Toshiba T1000 weighs only 6½ pounds).

The Tandy 1400 LT has 768K bytes of RAM, two 720K-byte 3½-inch floppy disk drives, and a backlit supertwist LCD screen. As configured by Tandy, the 128K bytes of memory beyond the 640K-byte DOS limit is set up as a RAM disk. Unfortunately, however, its contents are not maintained when you shut the power off. The Tandy's user-replaceable and rechargeable internal nickel-cadmium battery pack gives 4 to 5 hours of service per 13-hour charge cycle. An AC adapter also comes with the machine. An optional internal 300-/1200-bit-per-second (bps) Hayes-compatible modem card is available for \$199.95.

To the Rear

The rear access panel contains all external power and data connectors, including one serial port and one parallel port, RGB-intensity (RGBI) and composite video outputs, a keyboard input, and a socket for an external floppy disk drive. Also, the rear panel has a slot for an internal modem and an unlabeled access panel. The motherboard has a socket for an optional 8087-2 numeric coprocessor.



The system ROM contains the Phoenix BIOS, and the system software includes MS-DOS 3.2 and Tandy's version of GWBASIC 3.2. The system also contains a setup mode from which you can alter system parameters at any time. For example, the F7 option lets you change the system clock speed from the default 7.16 MHz to 4.77 MHz, if you should need to for program compatibility.

The rear panel is protected by both a plastic door flap and two sets of protruding ridges that let you stand the computer safely on end. You can connect an IBM PC-compatible external keyboard, as well as an external RGBI monitor; a tiny slide switch on the back panel allows you to specify either the LCD screen or an external monitor as the default display. In addition, you can also connect an external 5¼-inch floppy disk drive; there is an-

other tiny slide switch on the right side of the case that lets you select the internal or external disk drive as the default boot device.

Stand By

Standby mode in the Tandy 1400 LT is the timed, automatic shutdown of the screen electronics, including the battery-eating fluorescent backlighting. It is triggered when the computer has been waiting for keyboard input for a specified length of time—10 minutes as configured by Tandy, but you can set this interval to any number of hours and minutes up to 3:59 with the setup mode.

The computer most often waits for keyboard input at the DOS prompt. However, keyboard-driven applications programs such as word processors can also be left suspended while waiting for the next command; their execution then resumes along with screen illumination as soon as you press any key to continue operation.

The value of this feature is in preserving battery-charge life and sometimes (especially in cases of user oversight) important program data. The normal battery charge lasts only about 4 hours in active mode, while the standby mode, which uses less than half as much current, can preserve the contents of memory and the status of a running program for up to 11 hours on a fully charged battery, provided that you don't turn off the power switch in the meantime. A green LED in front of the B drive lights up when you are in standby mode.

continued

David Satz (118 State St., Apt. C, Brooklyn Heights, NY 11201) is a classical musician and recording engineer. You can reach him on BIX as "dsatz."

Tandy 1400 LT

Company

Tandy Corp./Radio Shack
1800 One Tandy Center
Fort Worth, Texas 76102
(817) 390-3011

Components

Processor: 4.77-/7.16-MHz NEC V20; socket for Intel 8087-2 math coprocessor
Memory: 768K bytes of RAM; 16K bytes of ROM (Phoenix BIOS)
Mass storage: Two 720K-byte 3½-inch floppy disk drives, optional 5¼-inch external floppy disk drive can be used
Display: Backlit supertwist LCD, 25 lines by 80 columns, 640- by 200-pixel color graphics (partially simulated by shading); 4½- by 9¾-inch screen; optional external RGBI monitor can be used
Keyboard: 76 keys, including 12 function keys, special editing-key cluster, embedded numeric keypad in ASCII keyboard; optional external keyboard can be used
I/O interfaces: RS-232C serial port; Centronics-compatible parallel port; external floppy disk drive port; RGBI video output (IBM PC-compatible); composite video output; external keyboard port; telephone line and instrument
Other: Built-in clock/calendar; internal nickel-cadmium battery pack, A/C adapter; carrying handle

Size

14½ by 12¾ by 3½ inches;
13½ pounds

Software

MS-DOS 3.2; GWBASIC 3.2

Options

300-/1200-bps Hayes-compatible CMOS internal modem: \$199.95
Additional nickel-cadmium battery pack: \$79.95
Carrying case: \$39.95
Intel 8087-2 math coprocessor: \$250
MS-DOS/GWBASIC Reference Guides: \$29.95

Documentation

77-page A Practical Guide to the Tandy 1400 LT

Price

\$1599

Inquiry 895.

DISK ACCESS IN BASIC (IN SECONDS)

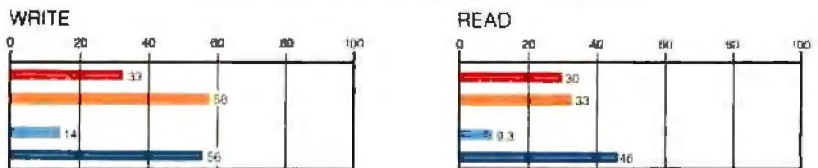

BASIC PERFORMANCE (IN SECONDS)

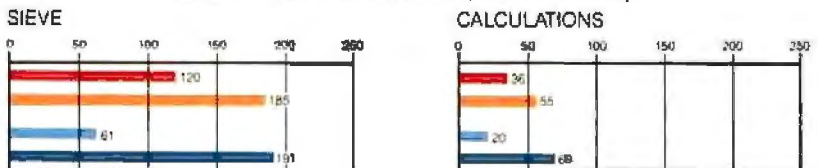

SYSTEM UTILITIES (IN SECONDS)

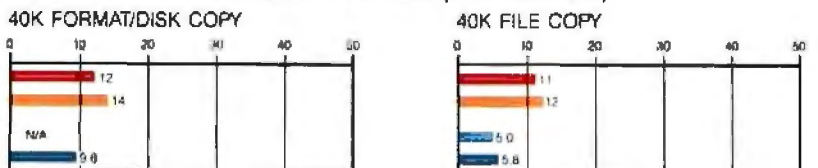

SPREADSHEET (IN SECONDS)

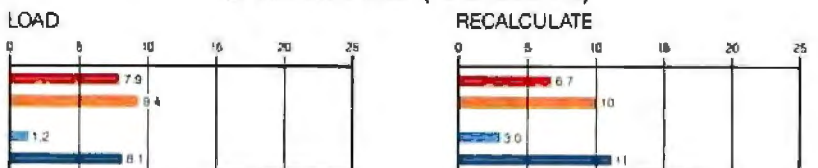

■ TANDY 1400 LT (7.16 MHz) ■ TANDY 1400 LT (4.77 MHz)
■ IBM PC AT (8 MHz) ■ IBM PC (4.77 MHz)

The Disk Access benchmarks write and then read a 64K-byte sequential text file to a blank, formatted floppy disk. Sieve runs one iteration of the Sieve of Eratosthenes. Calculations performs 10,000 multiplication and division operations. The 40K Format/Disk Copy formats and copies a 40K-byte file with the system utilities. This test was not performed on the PC AT because the computer had only one floppy disk drive. The 40K File Copy benchmark copies a 40K-byte file from one floppy disk to the other. The Spreadsheet tests load and recalculate a 25-row by 25-column Multiplan (1.06) spreadsheet. All benchmark programs on the Tandy 1400 LT were run with MS-DOS 3.20 and Tandy's version of GWBASIC 3.20; tests on the IBM PC and PC AT were run with PC-DOS 3.2 and GWBASIC 2.02.

Screen and Keyboard

The lid containing the 4½- by 9¾-inch LCD screen hinges from the center of the main chassis and is adjustable to any viewing angle from upright to nearly flat. Be careful, however, not to let it fall shut on your fingers or on disks that you haven't fully inserted into the drives.

The 80-column by 25-line screen is only half as tall as it is wide, and there is no margin at all between the descenders of one line of characters and the ascenders of the next. But the font is a well-chosen mixture of double- and single-dot thicknesses, and it has sufficient contrast to be easily legible under all normal am-

bient lighting conditions—or even in total darkness. A contrast control on the right side of the case sets the shading for the royal-blue characters and the silver-gray background, a combination I found extremely readable and easy on the eyes.

The plastic-film surface coating over the screen tends to reflect some glare, but

you can usually adjust the screen tilt to avoid any problems. The fluorescent backlighting also "sings" noticeably at about 660 Hz when energized, but this sound is disturbing only in quiet surroundings. The fluorescent panels have an estimated life of 3 years; Tandy computer-service personnel can replace them.

The Tandy 1400 LT simulates the CGA 640-by-200-pixel graphics mode. By varying the refresh cycle of the LCD pixels, you can obtain four degrees of shading: the basic silver-gray background, royal blue for fully darkened pixels, a dull brownish foreground shade, and a lighter background shade.

The slow darkening characteristic of supertwist LCD pixels is observable here just as it is on the NEC MultiSpeed (see my review "The NEC MultiSpeed" in the September 1987 BYTE). But due to the Tandy's slower processor, the smearing effect that you get when you scroll text (e.g., disk directory listings) is less pronounced. You can also see a slight downward ripple effect, particularly when the background setting is on the dark side. This ripple is not a product of interference from other lighting; it is visible in total darkness as well.

Keyboard preferences are even more intensely subject to personal tastes and acquired habits than screens are. The Tandy 1400 LT's keyboard arrangement features 12 function keys in three groups across the top, the Escape key to the left of the numbers row, and minor punctuation character keys to the left and right of the space bar. The cursor-control cluster is at the extreme bottom right, and you must combine cursor keys with a left-hand Function key to produce commands such as PageUp, PageDown, Home, and End. This arrangement conserves space on the keyboard, but not in the mind. It results in four different shift-type keys: Shift, Control, Alt, and Function. It also makes you use three fingers, as well as extra eye motions, to generate several of the most common word processor commands, such as PageUp (Ctrl-Fn-PgUp) or End (Ctrl-Fn-End). Even CapsLock, the purpose of which is to free your hands, ironically requires both hands to set or reset (Ctrl-Fn-CapsLock).

The keyboard action provides some resistance and requires a firm touch—a slight punching action. Getting used to the touch required to depress the keys is easier than getting accustomed to the keys popping up when you release them. They make a hollow popping sound both when you depress them and when you let them go. The keyboard is not conducive to quiet typing or to an extremely light typing touch. On the other hand, you're not

likely to enter extraneous characters by mistake; these keys require a definite key-stroke to produce a character.

You can use an alternative keyboard, if you wish, by plugging it into the keyboard socket provided on the rear panel.

Modem, Size, and Battery

I installed the optional 300-/1200-bps Hayes-compatible modem card with very little difficulty. To use it, you must select the F4 option in the setup mode and switch from the default RS232C to MODEM. The modem functioned flawlessly on both local and coast-to-coast connections. It lets you use acoustic cups at both 300- and 1200-bps speeds, making it useful in hotels and pay phones where direct access to modular phone sockets may not be available. The modem's implementation of the AT command set includes all the normal S register controls and the extended verbal/numeric result codes.

Overall, the computer is neither as small as the Toshiba T1100 Plus (or any of the Toshiba laptops, for that matter) nor as large as the NEC MultiSpeed. The Tandy 1400 LT is light enough to carry across a large airport terminal, but it is heavy enough to cause eventual discomfort, rather like an early-model portable electric typewriter. The weight is mostly at the rear of the computer. This is understandable: The keyboard is in the front, and the boards and disk drives are in the rear. However, taking the Tandy 1400 LT at its name, I tried it as a laptop, balanced on my knees. Its rear weight and slightly longer footprint (14½ inches versus 12 inches for the Toshiba T1100 Plus and 13½ inches for the NEC MultiSpeed) gave it a tendency to slip off my lap.

The nickel-cadmium battery pack comes in its own externally accessible compartment, so you can easily replace it with an optional extra battery pack. This will be good news for travelers and those of us who never quite seem to get the long-life performance that modern, properly cared-for nickel-cadmium batteries are supposed to offer. The battery power supply takes over automatically if it contains an adequate operating charge and the AC power supply is removed or interrupted. However, you can't change the battery safely while the computer is active or in standby mode. The manual instructs you to turn off the power and disconnect all peripherals and accessories first.

Checking Out the Software

A single 3½-inch floppy disk contains a complete implementation of MS-DOS 3.2, including the hard disk drive-oriented utilities such as BACKUP, RESTORE, JOIN, and SUBST (although no hard disk

drive is available). GWBASIC 3.2 comes on the disk as well.

Up-to-date versions of MOUSE.COM and MOUSE.SYS are included to support a Microsoft serial Mouse if you wish to add one. The DOS disk also has the programmer-oriented utilities LINK, LIB, and EXE2BIN, and a bunch of lesser-known DOS utilities. These would have sent me running to the DOS manual to see what they're good for if the Tandy 1400 LT had come with one. But it didn't; the manual is an optional extra.

The Tandy 1400 LT showed no software- or hardware-compatibility problems with Flight Simulator 2.13, Turbo Pascal 3.01a, SideKick 1.56a, MEX.PC 1.65a, Microsoft Word 3.1, or QuickBASIC 2.01. However, I did have trouble with version 4.0 of Microsoft Word. Earlier versions of Word worked perfectly well; however, due to the increased default key-repetition rate in version 4.0, you get a runaway-keyboard condition that you can stop only by rebooting. To prevent this problem, you must use the DOS DEBUG utility to patch a single location in the MW.INI file in the WORD directory. (Microsoft's customer service is aware of this problem and can advise you of the precise patch.) The Microsoft serial Mouse (original style) worked perfectly well with the supplied version of MOUSE.COM.

The softcover manual, *A Practical Guide to the Tandy 1400 LT*, devotes 28 pages to DOS concepts and functions, but the explanations are so concise that I wonder whether many nontechnical readers could really profit from them. Another strange aside: The manual contains two indexes—one at the end of the hardware section (48 pages into the manual), and another at the end of the DOS section, which is at the end of the book. So, if you're looking for something to do with the hardware, you won't find it in the index at the end of the book, where you'd normally look.

Testing the Tandy

I tested the 720K-byte floppy disk drives with the Coretest, which showed an average access time of about 225 milliseconds; this is typical of the drives on current-model laptops. The operating noise level of the disk drives is higher than average, although, like the noise of the screen, it should be disturbing only in quiet environments, such as libraries or classrooms.

I also ran BYTE's BASIC benchmarks with Tandy's version of GWBASIC 3.2 and MS-DOS 3.20. Disk Read and Write, Sieve, Calculations, and Spreadsheet Load and Recalculate all give the Tandy

continued

SPEED UP YOUR PC/XT NOW

NORTON SI = 9.4/10.3

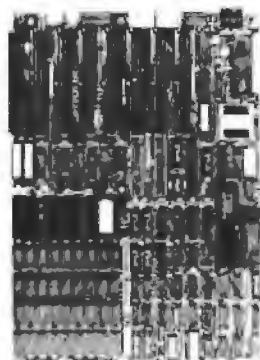

You know that **SPEED** is the only thing your PC/XT never has. Its brain takes too much time to think. Have it transplanted now with the **EPC** motherboard and your system would yield an astonishingly high performance, exceeding even that of the PC-AT.

EPC is simply the **FASTEST PC/XT** Motherboard in the World that is fully compatible to all PC/XT hardware and software. It's 100% designed and made in CANADA and absolutely not a downsize AT clone. **EPC** comes with an step-by-step installation manual plus a **TWO-YEARS** warranty and prices only **US\$399.00** (with 0Kb)

SPECIFICATIONS

- * 80286-10 CPU in 8088 mode
- * Dual speed : 8Mhz/10Mhz
- * Socketed for 80287
- * Socketed for BIOS/640Kb RAM
- * Industrial Grade 4-layer PCB
- * 8 XT slots
- * XT keyboard input
- * XT Power supply input
- * Dimensions: 8.5in.x14in. (fit most XT clone cases)

Dealer Inquiries Welcome

SWEET
Electronics Inc.

3800 Thimens Blvd.
St-Laurent, Quebec, CANADA H4R 1V6
Tel: (514) 745-2656

LAHEY SETS NEW FORTRAN STANDARDS

LAHEY PERSONAL FORTRAN 77 - Full ANSI Standard \$95

F77L - The benchmark for the competition. \$477

"EDITOR'S CHOICE"

PC Magazine

"...the most robust compiler tested."

Micro/Systems Journal

"...the ultimate fully-blown ANSI FORTRAN 77...
a fantastic product."

PC Australia

F77L-EM/16 - Breaks the DOS 640K barrier with extended memory.
The most powerful PC FORTRAN available. \$695

FORTRAN TOOLS: Profiler, Mathematical Functions Library, Overlay Linker, Utility Libraries, Windows Library, Toolkit.

The difficult decision is not from whom you should buy your PC FORTRAN, but which Lahey compiler you should purchase.

Call us today to discuss your
PC FORTRAN needs.

FOR INFORMATION OR TO ORDER:
1-800-548-4778

30-Day Money-Back Satisfaction Guarantee
Lahey Computer Systems, Inc., Box 8091,
Incline Village, NV 89450
Tel: 702-831-2500 FAX: 9102401258



REVIEW: THE TANDY 1400 LT

1400 LT at 4.77 MHz the edge over the 4.77-MHz IBM PC. The formatting and copying tests, however, are a different story. On the 40K Format/Disk Copy, the IBM PC is more than 40 percent faster than the Tandy 1400 LT (9.6 seconds for the PC and 13.5 for the 1400 LT); and on the 40K File Copy, the IBM leaves the Tandy in the dust, with more than a 98 percent advantage (5.8 seconds for the IBM versus 11.5 for the Tandy).

When you compare the Tandy 1400 LT at 7.16 MHz with the 4.77-MHz IBM PC, the results change, as you would expect. The Tandy shows a significant advantage on the Disk Write and Read, the Sieve, and the Calculations tests. Then the advantage dissolves. The 4.77-MHz IBM PC outperforms the 7.16-MHz Tandy 1400 LT on the 40K Format/Disk Copy by more than 20 percent (9.6 seconds for the IBM and 11.6 for the Tandy). And the IBM continues to blow the Tandy away on the 40K File Copy by 88 percent (5.8 seconds versus the Tandy's 10.9). On the Spreadsheet Load, the 1400 LT at 7.16 MHz performs at almost exactly the same speed as the 4.77-MHz IBM PC, although the megahertz advantage does show up in the Recalculate figures (the Tandy outperforms the IBM by 64 percent: 6.7 seconds versus 11 seconds). Needless to say, the 8-MHz IBM PC AT steals the speed awards by a healthy margin.

Little New Ground

Tandy, with its massive distribution network of Radio Shack stores, has the power to make waves with any serious computer product it introduces. The Tandy 1400 LT is a solidly designed laptop that breaks little new ground, but—if you accept its keyboard feel and layout and slow disk drives—it avoids any serious design flaws. Its hardware capability will be particularly noteworthy if a reasonably priced expansion chassis and a hard disk drive become available in the future.

The Tandy 1400 LT's processor power and backlit LCD screen make it a low-cost alternative to the successful Zenith Z-181 (\$2399). The Z-181 screen is taller but is hinged from the back of the case, making it harder to use on most airplane or train seat backs. If you need compactness, processor power, and battery life, you may prefer the somewhat higher-priced Toshiba T1100 Plus (\$1999)—or the NEC MultiSpeed (\$2195), a backlit LCD machine that is more powerful than either the Tandy 1400 LT or the Toshiba T1100 Plus. However, at \$1599, the Tandy 1400 LT achieves a sensible and moderate balance between good basic performance and economy. ■



PROGRAMMER'S PARADISE PRESENTS MICROPORT SYSTEM V/386 THE BEST INTEL 80386 SOFTWARE DEVELOPMENT ENVIRONMENT. PERIOD!

Microport & Programmer's Paradise offer you the best value on the tools you need.

Software developers, Microport knows your job is difficult. That's why they've created the best 80386 development environment on the market, giving you the tools you need to do your job successfully. Microport System V/386™ is the powerful UNIX® V operating system that delivers almost unlimited speed and power and provides true multi-tasking and multi-user capabilities. It can be used in virtually all computer environments, from software development to office automation to true desktop publishing.

System V/386 — the best and most complete development environment. And here's why. It's the only operating environment with:

- The real UNIX developed by AT&T, which gives you complete compatibility up and down.
- The latest version of AT&T UNIX System V, Release 3.
- The highly acclaimed Green Hills C-386 C compiler, well-known for its ability to generate fast, compact code, gives you full UNIX symbolic debugging and support for the 80387 and Weitek 1167 math co-processors.

Make your job easier and get the Microport 80386 software development advantage.



RUNTIME SYSTEM

One of the most comprehensive UNIX V operating systems available on the market today, it includes the screen editor "vi" and contains over 180 utility programs.
List: Runtime System (2-user): \$199 Ours: \$169
Runtime System (unlimited users): \$448 Ours: Call

SOFTWARE DEVELOPMENT SYSTEM

The Software Development System includes both the Green Hills C-386 compiler and the AT&T 386 pcc C compiler. Also available are Green Hills Fortran 386 and Pascal 386. A family of compilers with call sequence compatibility. Each compiler conforms to relevant standards, generates small, condensed code, and features global optimization for fast execution.
List: \$499 Ours: \$429
UNIX is a registered trademark of AT&T. System V/386 is a trademark of Microport Systems.

Circle 209 on Reader Service Card

TEXT PREPARATION SYSTEM

This package consists of the complete System V, Release 2 Documenters' Workbench (DWB). Also includes both the new troff (device-independent troff) and the old troff (otroff). Drivers for the HP LaserJet Printer and Apple's LaserWriter are optionally available.
List: \$199 Ours: \$169

COMPLETE SYSTEM V/386

Includes Runtime System, Software Development System and Text Preparation System
List: \$799 Ours: \$669

DOS MERGE 386

DOS Merge 386 is an environment that supports concurrent use of System V/386 and DOS. With DOS Merge, you can develop software by combining DOS and UNIX System V programs and commands. You can run multiple DOS programs and UNIX System V programs at the same time on dumb terminals. DOS Merge comes in two versions: a 2-user version and an unlimited-user version.
List: DOS Merge 386 (2 User) \$395 Ours: \$345
DOS Merge 386 (Unlimited) \$495 Ours: \$429

Microport System V is also available for the PC/AT

	List	Ours
System V/AT (Complete)	\$549	\$465
Runtime System	199	169
Software Development System	249	209
Text Preparation System	199	169
Unlimited License Kit	249	209
DOS Merge 286	149	129

Put Microport's System V/386 or System V/AT Software Development Environment to work for you. Call PROGRAMMER'S PARADISE!

1-800-445-7899
In NY: 914-332-4548

Programmer's
Paradise™

A Division of Hudson Technologies, Inc.
42 River Street, Tarrytown, NY 10591





DISCOVER PARADISE

Programmer's Paradise Gives You Superb Selection, Personal Service and Unbeatable Prices!

Welcome to Paradise. The microcomputer software source that caters to your programming needs. Discover the Many Advantages of Paradise...

- Lowest price guaranteed
- Latest versions
- Huge inventory, immediate shipment
- Knowledgeable sales staff
- Special orders
- 30-day money-back guarantee*

We'll Match Any Nationally Advertised Price.

	LIST OURS		LIST OURS
386 SOFTWARE		RUN/C	120 79
ADVANTAGE 386 C	895 839	RUN/C PROFESSIONAL	230 155
ADVANTAGE 386 PASCAL	895 839	C LIBRARIES	
DESQVIEW	NEW 130 109	BASIC.C	175 170
MICROPORT DOS/MERGE	395 349	BLACKSTAR FUNCTIONS	125 99
MICROPORT SYSTEM		ASYNC HX MANAGER	175 135
Y2K0 (COMPLETE)	SPECIAL 799 669	C FOODS/MORGASBORD	130 85
MS WINDOWS/386	SPECIAL 195 129	C TOOLS PLUS/S.O	129 99
PC-MOS 386	CALL CALL	C UTILITY LIBRARY	185 135
PHARLAP 386/ASM/LINK	495 419	C XPERT	395 339
PHARLAP 386 DEBUG	195 155	ESSENTIAL COMMUNICATIONS	185 125
SCO XENIX SYS V 386 (COMPLETE)	1495 1195	COMMUNICATIONS PLUS	250 195
VM/386	245 179	GREENLEAF C SAMPLER	195 125
386-TO-THE-MAX	NEW 75 65	GREENLEAF COMM LIBRARY	185 125
		GREENLEAF FUNCTIONS	185 125
APL		MULTI-C	149 135
APL+PLUS PC	695 499	PFORCE	295 216
APL+PLUS PC TOOLS	395 295	RESIDENT C W/SOURCE	198 169
POCKET APL	95 79	THE HAMMER	195 119
		TIMESLICER	295 279
ARTIFICIAL INTELLIGENCE		W/SOURCE CODE	1000 895
ACTIVE PROLOG TUTOR	85 55	TURBO C TOOLS	129 99
ARITY STANDARD PROLOG	95 79	WKS LIBRARY	89 79
LPA PROLOG PRO COMPILEK	895 759		
LPA PROLOG PRO INTERPRETER	395 339	COBOL	
MULISP-87 INTERPRETER	300 189	COBOL/SPU	395 329
MULISP-87 INTERP COMPILER	400 289	E-Z PAGE	395 239
PC SCHEME	95 85	MICRO FOCUS	900 729
SMALLTALK/V	SPECIAL 99 79	COBOL/2	NEW 800 729
STAR SAPPHIRE LISP	495 445	COBOL/2 TOOLSET	1500 CALL
TURBO PROLOG	89 69	LEVEL II COBOL	349 279
TURBO PROLOG TOOLBOX	100 69	PERSONAL COBOL	149 119
VF EXPERT	100 85	OTHERS	CALL CALL
		MICROSOFT COBOL	190 149
ASSEMBLERS/LINKERS		MICROSOFT SORT	195 139
ADVANTAGE DISASM	SPECIAL 295 269	OPT-TECH SORT	149 105
ASMLIB	149 129	REALIGCS	995 795
DR ASSEMBLER + TOOLS	200 179	REALIA COBOL	1145 879
MS MACRO ASSEMBLER	150 99	W/REALMENU	990 739
OPTASM	NEW SPECIAL 195 165	RM/COBOL	1250 990
PASMB6	195 115	RM/COBOL-85	395 315
PLINK86/PLUS	495 279	RM/SCREENS	400 379
RELAS, UNWARE, XASMS	CALL CALL	SCREENING	170 129
VISIBLE COMPUTER 80286	100 89	SCREENPLAY	475 129
BASIC			
DB/LIB	139 119		
FINALLY!	99 89		
FLASH-UP	89 79		
INSIDE TRACK	85 55		
MACH 2	99 69		
MS QUICK BASIC	SPECIAL 99 69		
QBASE	89 79		
QUICKPAK	89 79		
QUICK-TOOLS	130 109		
QUICKWINDOWS	99 89		
SCREEN SCULPTOR	125 95		
STAY RES	69 55		
TRUE BASIC	100 79		
TURBO BASIC	100 69		
DATABASE TOOLBOX	100 69		
EDITOR TOOLBOX	100 69		
TELECOM TOOLBOX	100 69		
C COMPILERS			
AZTEC-COMMERCIAL	499 CALL		
AZTEC C-DEVELOPERS	299 CALL		
C86PLUS	497 375		
HIGH C	595 CALL		
LATTICE C	500 289		
W/SOURCE	900 499		
MICROSOFT C	450 355		
QUICK C	99 65		
TURBO C	SPECIAL 100 65		
C++			
ADVANTAGE C++	SPECIAL 495 469		
PFORCE C++	SPECIAL 395 199		
C INTERPRETERS			
C-TRIP	295 239		
INSTANT C	495 279		
INSTANT C16M	895 CALL		

	LIST OURS		LIST OURS
HARDWARE PRODUCTS		GENIEFER	395 279
AMDEK 723 MONITOR	790 499	GENIEFER SOLUTIONS	NEW 95 79
AMDEK 730 MONITOR	899 589	HI SCREEN XL	149 119
AST ADVANTAGE PREMIUM W/S12K	495 219	QUICK ENTRY	NEW 99 89
AST RAMPAGE! 386 W 2M	849 549	R&R	150 129
AST RAMPAGE! 386 W/S12K	549 349	REPORT PLUS	NEW 150 129
HERCULES GRAPHICS CARD PLUS	299 189	SEEKIT	NEW 109 89
HERCULES IN COLOR CARD	499 329	SILVERCOM LIBRARY	130 109
IRMA 2	1195 779	SQUISH	NEW 79 69
ORCHID TURBO PGA	749 499	TOM RETTIG'S LIBRARY	100 79
ORCHID TURBO EGA	1495 1099	UI PROGRAMMER	250 239
PARADISE SYSTEMS AUTOSWITCH			
EGA 489 CARD	349 189	DEBUGGERS	
VGA PLUS CARD	399 309	ADVANCED TRACE-86	175 119
VGA PROFESSIONAL	599 499	BREAKOUT	125 89
VEGA DELUXE	379 289	C-SPRITE	175 119
		PERISCOPE 1	345 275
DATABASE COMPILERS		PERISCOPE II	175 139
FORCE III	695 399	PERISCOPE IIX	145 105
FOXBASE PLUS	395 299	PERISCOPE III 8 MHZ	295 799
QUICKSILVER	599 389	PERISCOPE III 10 MHZ	1095 875
R-TURBO	695 CALL	PFIX 86 PLUS	395 215
		SOFTPHONE I/IX	750 699
DBASE-TOOLS		T-DEBUG PLUS	60 49
APPLICATION PLUS	499 279		
DBASE III PLUS	695 429	DISK/DOS-KEYBOARD UTILITIES	
DBASE IV TOOLS FOR C	79 65	BACK-IT	130 119
DNPL REPORTER	90 79	BOOKMARK	100 79
D ONE TWO THREE	99 89	COMMAND PLUS	NEW V. 2.0 80 69
		DISK OPTIMIZER	60 55
		FANSI CONSOLE	75 59
		PASTBACK	175 129
		PAST FORWARD	70 69
		FETCH	55 45
		INTELLIGENT BACKUP	190 135
		MADE UTILITIES	99 89
		NORTON COMMANDER	75 55
		NORTON UTILITIES	100 59
		ADVANCED NORTON UTILITIES	159 99
		PDISK	145 105
		Q-DOS II	70 59
		TASKVIEW	80 55
		VFEATURE	80 75
		VFEATURE DELUXE	120 110
		EDITORS	
		BRIEF	195 CALL
		WDBRIEF	175 CALL
		CVUE W/SOURCE CODE	250 199
		EDIX	195 165
		EMACS	295 265
		EPISON	185 149
		FIRSTTIME (C)	295 229
		KEDIT	125 99
		MKSU	75 69
		PC/EDIT	250 229
		PI EDITOR	195 155
		PMATE	195 115
		SP/PC	195 149
		VEDIT PLUS	185 139
		XTC	90 79
		FILE MANAGEMENT	
		BTRIEVE	245 189
		XTRIEVE	245 185
		REPORT OPTION	145 99
		BTRIEVE/N	595 455
		XTRIEVE/N	345 269
		REPORT OPTION/N	159 139
		CBTREE	395 315
		C-TRIE	125 99
		R-TREE	295 239
		C-TREE/R-TREE BUNDLE	650 519
		DBC II/III W/SOURCE CODE	250 189
		DBC III PLUS	500 359
		DR.VISTA OR DR.QUERY	750 585
		SINGLE USER/SOURCE	SPECIAL 195 159
		MULTIUSER	SPECIAL 495 399
		MULTIUSER W/SOURCE	SPECIAL 990 789
		INFORMIX ES/SQL	285 235
		INFORMIX 4GL	895 CALL
		INFORMIX SQL	795 CALL

	LIST OURS		LIST OURS
FORTRAN COMPILERS		GRAPHICS	
DIGITAL RESEARCH FORTRAN 77	350 319	ADVANTAGE GRAPHICS (C)	250 229
LARRY PORTMAN S77L	SPECIAL 695 CALL	ESSENTIAL GRAPHICS	250 189
LARRY PERSONAL FORTRAN 77	65 49	GRAPHIC	350 279
MICROSOFT FORTRAN	450 285	GSS GRAPHIC DEV. TOOLKIT	495 375
RM/FORTRAN	595 479	HALO	300 269
WATFOR FORTRAN	375 235	HALO (5 MICROSOFT LANG)	595 389
		METAWINDOW	195 159
		METAWINDOW PLUS	275 229
		TURBO WINDOW/C	95 79
		TURBO HALO (FOR TURBO C)	99 79
FORTRAN UTILITIES/LIBRARIES		LIBRARY	
AUTOMATED PROGRAMMER	995 849	PC-LINT	179 99
DIAGRAMMER OR DOCUMENTER	129 115	PRE-C	295 159
EXTEND	150 129		
FORTRAN ADDENDA	165 139	MODULA-2	
FORTRAN ADDENDUM	95 85	LOGITECH MODULA-2	
GRAPHMATIC OR PLOTMATIC	125 119	COMPILER KIT	99 79
MACUS NUMERICAL ANALYST	295 249	DEVELOPMENT SYSTEM	249 199
MATHPAC	495 445	TOOLKIT	169 139
NO LIMIT	129 109	REPETOIRE	89 75
PANEL	295 199	STONYBROOK MODULA 2	195 169
SPINDRIFT LIBRARY	149 135	UTILITIES	345 295
SSP/PC	350 289		
TEKMAR GRAPHICS LIB	195 165	OPERATING SYSTEMS	
		MICROPORT	
		286 DOS MERGE	149 129
		SYSTEM V/AT	SPECIAL 549 469
		SOFTWARE DEV. PACKAGE	199 169
		TEXT PREPARATION PACKAGE	199 169
		UNLIMITED LICENSE KIT	249 209
		SCO	
		XENIX SYSTEM V (COMPLETE)	1295 995
		DEVELOPMENT SYSTEM	595 489
		OPERATING SYSTEM	585 489
		TEXT PROCESSING PACKAGE	185 145
		XENIX FOR PS/2 5.0, 6.0, 6.0	CALL CALL
		WENDIN:	
		OPERATING SYSTEM TOOLBOX	99 79
		PCVMS	99 79
		PCVMS	99 79
		WENDIN DOS	SPECIAL 99 79
		WENDIN DOS APPLICATION KIT	99 79
		PASCAL COMPILERS	
		MARSHAL PASCAL	189 165
		MICROSOFT PASCAL	305 189
		PASCAL-2	350 319
		PROFESSIONAL PASCAL	595 CALL
		TURBO PASCAL	100 89
		TURBO PASCAL DEV. LIB.	295 269
		FEATURED PRODUCTS	
		OPTASM - High speed assembler is source compatible with MASM 5.0 and four times faster. Multi-pass design eliminates inserted NOP's and forward reference problems and automatically expands jumps out of range. Supports large symbol table, local labels, and includes built-in MAKE for serious programming. Special Price: \$165	
		SEIDL VERSION MANAGER - SYM a source code management system, with an easy to use full screen interface, space saving ability to compress data on archive files and a powerful report generator which can generate detailed audit trail reports with all the information archived. Special Price: CALL	
		Lakey S77L-EM/16M Fortran Compiler - Now! Breaks 640K barriers on PC/AT's and 386 based micros. A tremendous aid to downloading huge mainframe FORTRAN programs. Supports for NAMELIST and many other extensions make porting much easier. Special Price: CALL	
		ADVANTAGE Disassembler - Disassembles exe and com files for comprehensive, well-documented assembly language source code. Latest version is now able to disassemble memory resident code and the original symbol has been rearranged so listing the symbol table or writing to a file will be faster. List: \$295 Special Price: \$269	
		TURBO PASCAL ADD-ONS	
		ASCH TURBO GHOST WRITER	
		STARTER	NEW 99 89
		COMPLETE	NEW 239 229
		AZOTAR DOS TOOLKIT	NEW 99 85
		ADOSBIOS & MOUSE TOOLS	75 69
		FLASH-UP	89 79
		FLASH-UP TOOLBOX	49 45
		INSIDE TRACK	85 55
		MACH	75 59
		METRABYTE DATA ACQ. TOOLS	100 89
		SCIENCE AND ENGIN. TOOLS	75 99
		SCREEN SCULPTOR	125 95
		SYSTEM BUILDER	150 129
		IMPEX	100 89
		REPORT BUILDER	130 115
		T-DEBUG PLUS	60 19
		TURBO ADVANTAGE	50 15
		TURBO ADVANTAGE COMPLEX	90 79
		TURBO ADVANTAGE DISPLAY	70 65
		TURBO ASM	99 89
		TURBO ASYNCH PLUS	139 99
		TURBO GEOMETRY LIBRARY	NEW 100 85
		TURBO HALO	99 85

	LIST OURS		LIST OURS
TURBO MAGIC	189	179	
TURBO POWER TOOLS PLUS	129	88	
TURBO POWER UTILITIES	95	79	
TURBO PROFESSIONAL 4.0	99	79	
TURBO WINDOW/PASCAL	95	79	
UNIVERSAL GRAPHICS LIBRARY	150	119	
SCREEN DISPLAY/WINDOWS			
C POWER WINDOWS	130	115	
C-SCAPE	279	265	
CURSES W/SOURCE CODE	250	168	
GREENLEAF DATA WINDOWS	225	155	
W/SOURCE CODE	285	289	
JYACC FORMAKER	495	449	
JYACC JAM	750	679	
MICROSOFT WINDOWS	99	65	
MS WINDOWS DEVELOPMENT KIT	500	319	
PANEL	295	199	
PANEL PLUS	495	399	
PANEL/QC (QUICK C)	129	85	
PANEL/TC (TURBO C)	129	85	
SCREENSTAR W/SOURCE	198	169	
VIEW MANAGER	275	199	
VITAMIN C	225	155	
VC SCREEN	99	79	
WINDOWS FOR C	195	149	
WINDOWS FOR DATA	295	239	
W/SOURCE	NEW	590	CALL

TRANSLATORS			
BASIC OR BAS.PAS	CALL	CALL	
BASTOC	495	399	
DB2C	299	CALL	
DBX TRANSLATOR	350	299	
RTC PLUS	325	299	
TURBO TO C	495	468	

ADDITIONAL LANGUAGES/PRODUCTS			
ACTOR	SPECIAL	495	469
CARBON COPY PLUS		195	189
DAN BRICKLIN'S DEMO PROGRAM		75	59
DAN BRICKLIN'S DEMO TUTORIAL		50	45
FLOAT CHARTING II		229	206
HS/FORTH		395	389
IANUS/ADA C PACK		95	89
LATTICE RPG II COMPILER		750	629
MASTER FORTH		125	89
MKS AWK		75	69
MKS RCS	NEW	189	169
MKS TOOLKIT		139	115
NORTON GUIDES		100	65
PC FORTH		150	109
PERSONAL REXX		125	99
PLI 86		750	675

PRO-C	399	379
SAPIENS V8	300	269
SET. SCH	349	319
SOFTSCREEN HELP	195	149
SOURCE PRINT	95	75
THE WEINER SHELL	199	179
TREE DIAGRAMMER	77	69

XENIX/UNIX SOFTWARE			
MICROPORT + SCO PRODUCTS	CALL	CALL	
ADVANTAGE C++	695	625	
DIRECTORY SHELL (286)	349	315	
DIRECTORY SHELL (386)	495	445	
FOOBASE PLUS	795	649	
INFORMIX PRODUCTS	CALL	CALL	
JYACC FORMAKER	495	449	
JYACC JAM	1350	1219	
KORN SHELL	145	129	
MICROSOFT LANGUAGES	CALL	CALL	
PANEL PLUS	795	675	
RMICODL	1250	849	
RM/FORTRAN	750	649	
WINDOWS FOR DATA	795	CALL	

BLAISE			
ASYNCH MANAGER (C/PASCAL)	175	135	
C TOOLS PLUS/5.0	129	99	
EXBC	95	75	
PASCAL TOOLS/TOOLS 2	175	135	
TURBO ASYNCH PLUS	129	99	
TURBO C TOOLS	129	99	
TURBO POWER TOOLS PLUS	129	99	
VIEW MANAGER (C/PASCAL)	275	199	

BORLAND			
TURBO BASIC COMPILER	100	69	
DATABASE TOOLBOX	100	69	
EDITOR TOOLBOX	100	69	
TELECOM TOOLBOX	100	69	
TURBO C COMPILER	100	69	
TURBO PASCAL	100	69	
TURBO PASCAL DEV. LIB.	395	389	
TURBO TUTOR	70	45	
NUMERICAL METHODS TOOLBOX	100	69	
DATABASE TOOLBOX	100	69	
EDITOR TOOLBOX	100	69	
GAMEWORKS TOOLBOX	100	69	
GRAPHIX TOOLBOX	100	69	
TURBO PROLOG COMPILER	100	69	
TURBO PROLOG TOOLBOX	100	69	

GREENLEAF			
GREENLEAF C SAMPLER	95	88	

GREENLEAF COMM LIBRARY	185	125
GREENLEAF DATA WINDOWS	225	155
W/SOURCE CODE	395	289
GREENLEAF FUNCTIONS	185	125
LATTICE		
LATTICE C	500	269
W/SOURCE CODE	900	489
C CROSS REFERENCE GENERATOR	50	39
C-FOODSMORGASBORD	150	95
W/SOURCE CODE	300	179
C-SPRITE	175	119
CURSES SCREEN MANAGER	125	89
CVUE W/SOURCE CODE	250	189
DBC III	250	189
DBC III W/SOURCE CODE	500	339
DBC III PLUS	750	595
W/SOURCE CODE	1900	1188
LMK	195	139
LSE	125	99
RPG II DEVELOPER SYSTEM	1400	1119
RPG II COMPILER	750	629
RPG II SEU	250	189
RPG II SORT/MERGE	250	189
RPG II SCREEN DESIGN AID	350	309
SECRETDISK	120	89
SIDETALK	120	89
SPY	350	289
TEXT MANAGEMENT UTILITIES	120	89

LIFEBOAT			
ADVANTAGE 386 C OR PASCAL	895	829	
ADVANTAGE C++	SPECIAL	495	468
ADVANTAGE DISASM	SPECIAL	395	289
ADVANTAGE GRAPHICS		229	
ADVANTAGE LINK		395	379
ADVANTAGE MAKE		125	99
ADVANTAGE VMS		379	329
PANEL PLUS		495	395
QUICKSCREEN		195	175
RUN/C PROFESSIONAL		250	185
TIMESLICER		295	279
W/SOURCE CODE		1000	895

MICROSOFT			
MS BASIC COMPILER (XENIX)	695	449	
MS BASIC INTERPRETER (XENIX)	250	229	
MS C COMPILER	450	295	
MS COBOL COMPILER	700	449	
FOR XENIX	995	649	
MS FORTRAN	450	289	
FOR XENIX	695	449	
MS LEARNING DOS	50	39	
MS MACRO ASSEMBLER	150	99	
MS MOUSE SERIAL OR BUS	150	99	
W/MS WINDOWS	200	139	
W/EASY CAD	175	119	

MS MUMATH	300	165
MS PASCAL COMPILER	300	189
FOR XENIX	595	449
MS QUICK BASIC	SPECIAL	99
MS QUICK C	SPECIAL	99
MS SORT	195	129
MS WINDOWS	99	65
MS WINDOWS DEVELOPMENT KIT	500	319
MS WINDOWS/386	SPECIAL	195
PHOENIX		
PASM86	195	115
PDISK	145	109
PFANTASY PAC	995	889
PFINISH	395	315
PFIX86PLUS	395	315
PFORCE	395	315
PFORCE++	SPECIAL	395
PLINK86PLUS	495	279
PMAKER	125	79
PMAKE	195	115
PKE-C	295	189
PTEL	49	39
POLYTRON		
POLYBOOST	80	69
POLYDESK III	80	75
ADD-ONS	CALL	CALL

MOUSE PRODUCTS			
LOGITECH SERIAL OR BUS MOUSE			
W/PLUS, SOFTWARE	119	99	
W/PLUS, LOGICPAINT	149	119	
W/PLUS, LOGICADD MOUSE	189	149	
W/PLUS, PUBLISHER MOUSE	179	145	
W/PLUS, PAINT, CADD	200	169	
W/PLUS, CADD PUBL. MOUSE	239	189	
W/PLUS, PAINT, PUBL. MOUSE	199	159	
W/PLUS, PAINT, CADD, PUBL.	253	206	
LOGITECH SERIES 2 W/PLUS	175	119	
MICROSOFT SER OR BUS MOUSE	150	99	
W/EASY CAD	200	139	
PC MOUSE SER W/PNT & POPUPS	179	129	
PC MOUSE SER W/PNT & POPUPS	150	115	
SUMMAMOUSE	119	99	

POLYLIBRARIAN	95	89
POLYMAKE	149	129
POLYSHELL	149	129
POLYTRON C BEAUTIFIER	49	45
POLYTRON C LIBRARY I	99	75
POLYXREF	219	185
PVCS CORPORATE	395	329
PVCS NETWORK	CALL	CALL
PVCS PERSONAL	149	125

Special Savings from Paradise

MICROSOFT WINDOWS/386

Windows/386 gives you the look and feel of OS/2, by IBM and Microsoft — the standard for tomorrow. Turns your personal computer into a multi-tasking, virtual machine, where any number of DOS and Microsoft Windows applications can run at the same time. Each DOS application runs in its own 640K — even memory resident programs. Copying and passing of selected data between DOS and Windows application is supported. Features greatly enhanced support for DOS applications, they can run in a window or use the full screen.



Special Price: \$125

QuickC

QuickC gives you the features that you need to learn C quickly. It's the best for fast and easy compilation and prototyping, compiling programs at 10,000 lines per minute. Features a built-in editor with selectable insert or overtype mode, automatic MAKE file creation, context-sensitive help for easy learning and an integrated debugger that lets you set breakpoints, animate through your program and add watch variables. QuickC is completely source code and object compatible with Microsoft C 5.0.

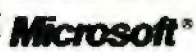

Special Price: \$65

QuickBASIC/4.0

QuickBASIC 4.0 eliminates the time-consuming compile step. Run your program, stop to edit and debug, then continue running without recompiling. When you edit your code, QuickBASIC automatically incorporates your changes — usually at 150,000 lines per minute. Includes a built-in, full-screen editor with automatic syntax checking and formatting, advanced threaded p-code interpreter, support for 8087/287 math co-processors, a subset of the Code View debugger, plus other new features.



Special Price: \$65

PI EDITOR

Turbocharge your productivity with PI, the only editor that automatically highlights your compilation errors and displays error messages. Slash development time instantly with PI's intuitive mnemonic commands, enhanced pop-up menus, contextual help and on-line manual. Bring out your best with PI's blazing speed, undo, macros, 'Find All,' regular expressions, language support, and full DOS access. The ultimate editing environment with built-in speed.



List: \$195

Special Price: \$155

WENDIN-DOS

WENDIN-DOS is the new multi-tasking, multi-user MS-DOS replacement operating system for IBM compatible PC's. WENDIN-DOS uses the MS-DOS file system, and supports MS-DOS commands while providing new ones to enable multi-tasking, file protection, and command language extension and enables you to access your files with DOS, UNIX, or VAX/VMS style file names — whichever you prefer. Provides pass words and run privileges for system securing. WENDIN-DOS supports several users on the same computer. To add new users, the computer operator just adds communications ports and describes them in his configuration system file. Minimum 512K memory.



List: \$99

Special Price: \$79

ADVANTAGE C++

Add ADVANTAGE C++ to your C compiler and enhance your existing C tools with new object-oriented capabilities. Now available with MS Windows Support this super set of C gives you the speed, support and reliability you need to develop large and complex programs with greater resilience, and fewer bugs. The latest version supports MS C4.0/5.0, and QuickC.



List: \$495

Special Price: \$469

Terms and Policies
 • We honor MC, VISA, AMERICAN EXPRESS
 No surcharge on credit card or C.O.D. Payment by check. New York State residents add applicable sales tax. Shipping and handling \$3.95 per item, next UPS ground. Bulk service available, pricing rates.
 • Programmer's Paradise will make any correct, verifiably advertised price for the products listed in this ad.
 • Prices and policies subject to change without notice.
 • Hours 9AM EST — 7PM EST
 • We'll Make any Non-advertised Price.
 • Most Orders include your phone number.
 *Ask for details. Some manufacturers will not allow returns once disk units are broken.
 Dealers and Corporate Buyers — Call for special discounts and benefits!

1-800-445-7899
In NY: 914-332-4548
 Customer Service:
914-332-0869
 International Orders:
914-332-4548
 Telex: 510-601-7602

Programmer's
Paradise
 A Division of Hudson Technologies, Inc.
 42 River Street, Tarrytown, NY 10591



Screening Macintosh II Color Monitors

Joel West and Neil Rhodes

A look at the PCPC II, the SuperMac Color Trinitron, and the Machroma C2D monitors

The Macintosh II (unlike its predecessor, the Mac Plus) was designed without a built-in video display device. This means that you can select display hardware (monitors or video cards) that are suitable for the specific demands of your work—color or gray scale, or larger monitors with more pixels.

Apple's Mac II video board gives you a 640- by 480-pixel display with 16 colors or gray scales for \$499, and up to 256 colors or grays if you add extra video memory to the board (for an additional \$149). For displays, Apple offers a choice of a 12-inch gray-scale monitor for \$399 or a 13-inch color monitor (which was in short supply last year) for \$999.

Since the Mac II's introduction, third-party vendors have brought out alternative monitors for it, including larger monitors displaying more pixels to meet the needs of those doing extensive CAD/CAM or graphics work. We evaluated some of the first available Mac II displays: two large-screen monitors from Personal Computer Peripherals Corp. (PCPC) and SuperMac Technology, and a standard-size monitor from 4Site Technologies.

The Mac II architecture supports display formats of arbitrary resolution; the video card's configuration ROM supplies the screen dimensions and pixel depth to the operating system when the computer starts up. Both SuperMac and PCPC take advantage of this flexibility by supplying video boards that provide more pixels than the standard Apple display.

The PCPC II [Trinitron] uses a 19-inch color Trinitron monitor and a video

board that displays 1027 by 768 pixels. This combination costs \$5295. SuperMac Technology offers a 19-inch color Trinitron monitor and the Spectrum 1000/8 video board, which provides a 1024- by 768-pixel display. This monitor and video board combination costs \$5190. Both companies offer alternative lower-cost 19-inch displays (discussed later). 4Site Technologies' Machroma C2D is a 14-inch color monitor that can display 926 by 580 pixels and costs \$895. It does not use its own video board; you can use Apple's Mac II video board or another third-party video board. (For a look at IBM-compatible multiscan-type monitors that can be used on Mac IIs, such as the Sony Multiscan and NEC MultiSync, see "Multiscan Color Monitors" by George A. Stewart in the February BYTE).

We noted qualitative impressions of the monitor/video card combinations during normal use, including testing with various Macintosh software packages. We used our own Colorizer software package, several MacApp demonstration programs from Apple's Advanced Technology Group, and Spinnaker, a Palette Manager test program by Art Cabral of Apple. In addition, quantitative results were obtained at the laboratories of Microvision, which used its SuperSpot 100 CRT analysis system on the three monitors. For reference purposes, we compared these systems with Apple's AppleColor color monitor and the Mac II video board.

The Monitors

The PCPC and SuperMac monitors are based on the 19-inch Trinitron manufactured by Sony, the GDM 1950 monitor (termed the GDM 1952 when equipped

with a tilt/swivel base). The PCPC is available only with the tilt/swivel base. The two monitors appeared to function identically during normal use, although testing showed a few subtle differences.

These monitors are very bulky and heavy; in fact, under Federal Occupational Safety and Health Administration employee guidelines, they require two people to move them. Due to their weight, you can't place them directly on top of a Mac II, as you can with smaller monitors. Thus, you need either more desk space or a stand that's sturdy enough to support 84 pounds of monitor (the tilt/swivel base increases this load to 90 pounds). SuperMac offers a tilt/swivel stand to support its monitor; it costs \$250.

According to the manufacturer, the Trinitron can display 1280 by 1024 pixels, but the nominal resolution with both of the supplied video boards is 1024 by 768 pixels. This provides approximately 250 percent of the screen pixels of the standard 640- by 480-pixel Apple Mac II monitor, and 450 percent of the Macintosh Plus and SE's 512- by 342-pixel displays. The pixel density is approximately that of the standard displays, so the net effect is a lot more screen area to work with when positioning application windows. This is particularly useful when working with MultiFinder, where the windows of all running programs must share the screen. A larger screen area lets you place application windows where you can bring them to the foreground at a mouse click instead of needing to pull down the desk accessory menu.

The 4Site Machroma C2D monitor is based on the Magnavox Professional 8CM873 monitor. It has a 14-inch screen with a 13-inch viewing area. Combined with Apple's video card, it offers a display of 640 by 480 pixels. It is slightly taller than the Apple monitor and is 5 pounds lighter.

The Machroma is the only one of the

Joel West is president and Neil Rhodes is manager of software development for Palomar Software Inc. (P.O. Box 2635, Vista, CA 92083). They are coauthors of the firm's Colorizer software package for the Macintosh II.

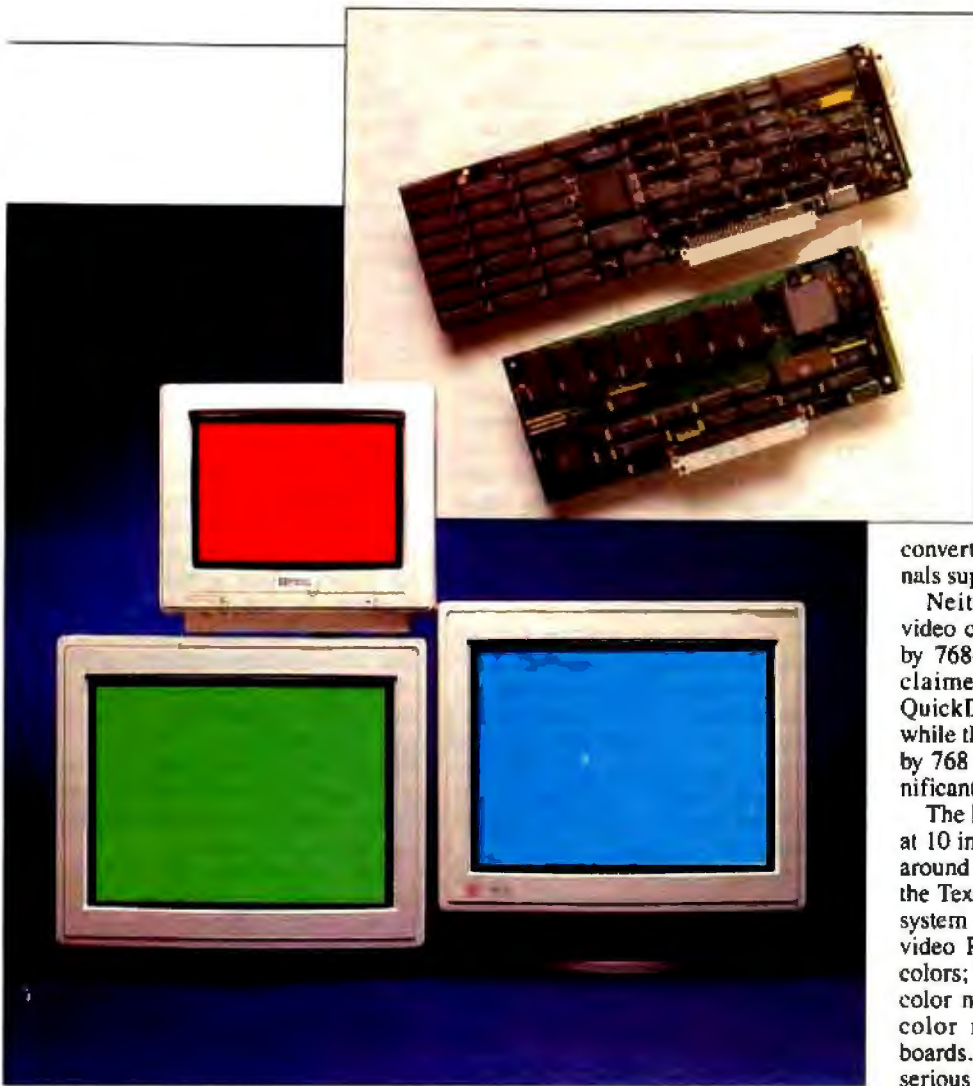

Photo 1: The three monitors reviewed. Top: 4Site's Machroma C2D. Bottom left: The SuperMac Color Trinitron. Bottom right: The PCPC II [Trinitron]. Inset: The video boards for the large monitors. Top: The SuperMac Spectrum 1000/8. Bottom: The PCPC CGC/1.

four monitors to include a 3-inch speaker and an audio input jack. It also has a Text switch that turns off the red and blue inputs, producing a black-on-green display with the Mac II.

The AppleColor High-Resolution RGB Monitor, which we used for reference, uses a 13-inch Trinitron tube with Apple electronics.

All the monitors except the AppleColor have a nonreflective coating, which is an advantage in normal and bright office lighting. Both of the large screens are switch-selectable for 220/240 volts AC, although different fuses are required for the different voltages. The AppleColor monitor automatically adjusts to higher voltages, while the Machroma was supplied in the 120-V version only.

PCPC and SuperMac each offer another 19-inch model, made by Mitsubishi and Ikegami, respectively. The PCPC II [Mitsubishi] costs \$4995; the SuperMac

Standard Color Monitor costs \$2995. SuperMac also sells a 16-inch Trinitron that displays the same number of pixels at a higher density and costs \$2495, and a 19-inch gray-scale monitor that costs \$1695.

Video Cards

To use one of these monitors, you must install a NuBus-compatible video card in the Mac II chassis. Opening up the Macintosh and installing the card may seem foreign to owners of earlier Macs, but it's a simple task, accomplished in less than 5 minutes. No DIP switches are present on any of the boards: Following the NuBus standard, it's up to the board's configuration ROM to provide the computer with the necessary information and driver code.

The output device for all the video cards is a RAMDAC by Brooktree Corp. This IC passes a digital value retrieved from video RAM to three built-in D/A

converters that drive the RGB analog signals supplied to the monitor.

Neither PCPC's nor SuperMac's video cards supported exactly the 1024-by-768-pixel display their manufacturers claimed. The PCPC board provided QuickDraw with 1024 by 767 pixels, while the SuperMac board supplied 1016 by 768 pixels. Neither variation was significant in actual use.

The PCPC video board is the smallest, at 10 inches long. The board is designed around the 75-MHz Brooktree 458 and the Texas Instruments TMS 34061 video system controller. It has 768K bytes of video RAM, allowing it to display 256 colors; however, it supports only the 256-color mode and not the 2-, 4-, and 16-color modes available on the other boards. The lack of a 2-color mode is a serious limitation, since a number of programs (e.g., MacPaint 1.5, SuperPaint 1.0, and TMON) expect a 1-bit deep (2-color) display; otherwise, they garble the screen image. With other video boards, the easiest fix for this problem is to set the display to the 2-color mode. Since the PCPC board doesn't have a 2-color mode, you're stuck until a new generation of programs arrives that can properly handle a 256-color display. PCPC is aware of the situation and says it will have a video board that supports a 2- and 256-color mode by the time you read this.

The SuperMac is the longest of the three boards at 13 inches. It uses the same TMS 34061 and a 66-MHz Brooktree 453. It also uses 768K bytes of video RAM to provide 256 colors. The tested board included version D11 of the SuperMac ROMs—the third revision offered, correcting problems with the 4- and 16-color display modes. This version was made available to all customers late last year, according to the company.

The SuperMac board demonstrated a minor (but annoying) display defect. When we changed the standard QuickDraw color table, the top display line noticeably flashes to black before showing

continued

Company Information

Personal Computer Peripherals Corp.
6204 Benjamin Rd.
Tampa, FL 33634
(813) 884-3092

SuperMac Technology
295 North Bernardo Ave.
Mountain View, CA 94043
(415) 964-8444

4Site Technologies Inc.
Machroma Division
200 Seventh Ave.
Suite 120
Santa Cruz, CA 95062
(800) 634-7483

Apple Computer Inc.
20525 Mariani Ave.
Cupertino, CA 95014
(408) 996-1010

the proper color. However, before this article went to press, SuperMac sent us a new version (1.0B1) of the configuration ROM that corrects this problem.

For comparison, the 12-inch Apple Macintosh Video Card uses a 40-MHz modified version of the Brooktree 453. The board is built around a custom frame-buffer chip instead of the Texas Instruments controller. It supports 2-, 4-, and 16-color modes standard, while the optional expansion kit (or its third-party equivalent) is needed for a 256-color mode. As shipped, the board comes with eight video RAMs and sockets for eight more. The additional RAM (sold by Apple as the Mac II Video Card Expansion Kit) is required for a 256-color display.

Monitor Tests and Results

A series of 10 tests was performed at the offices of Microvision in Campbell, California. The tests were run using the firm's SuperSpot 100 CRT analysis system. The standard SuperSpot test patterns are available only for MS-DOS machines, so we wrote a comparable program for the Mac II using Color QuickDraw calls and MacApp.

The tested hardware included the AppleColor High-Resolution RGB Monitor; video cards from PCPC and SuperMac and their monitors; and two Mac II Video Cards, with the optional video expansion kits, to drive Apple's monitor and the Machroma monitor.

The monitors were allowed to warm to operating temperature (about 30 minutes), and the brightness level was adjusted for best definition. The entire screen was flooded with green, since the sensor was most sensitive to this color, and the intensity was measured. The light levels in foot-lamberts for each monitor were as follows: PCPC, 19; SuperMac, 16.7; Machroma, 17; and AppleColor, 15. The tests measured the spot size; time variance effects such as jitter, swim, and drift; misconvergence; and voltage regulation.

Spot size is the minimum size that can be illuminated by the electron beam. The tests provide separate readings for horizontal and vertical dimensions. Measurements were made in the center and the corner of the screens. The square root of the sum of the squares of the horizontal and vertical measurements provides a single number that corresponds to the length of a diagonal line across a spot. Spot size shows the fineness of the display beyond the nominal dot-pitch specification. The spot sizes are shown in figure 1; they have been normalized for a screen size of 13 inches.

The two 19-inch Trinitron monitors did not perform identically. The spot size for the PCPC monitor was measurably smaller than that of the SuperMac monitor—in fact, it was the smallest for the monitors tested. This result was repeated when testing the PCPC monitor with the

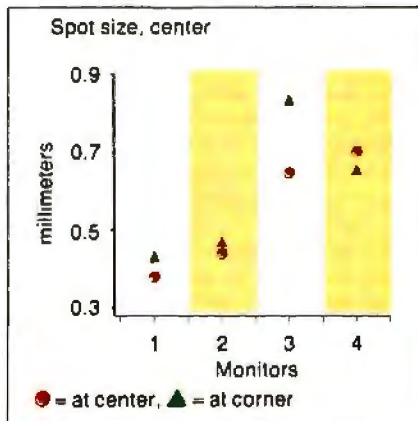

◀ **Figure 1: Measured spot sizes for the monitors in millimeters.**

Figure 2a: Jitter measurement.

Figure 2b: Swim measurement.

Figure 2c: Drift measurement.

All measurements in millimeters. ▼

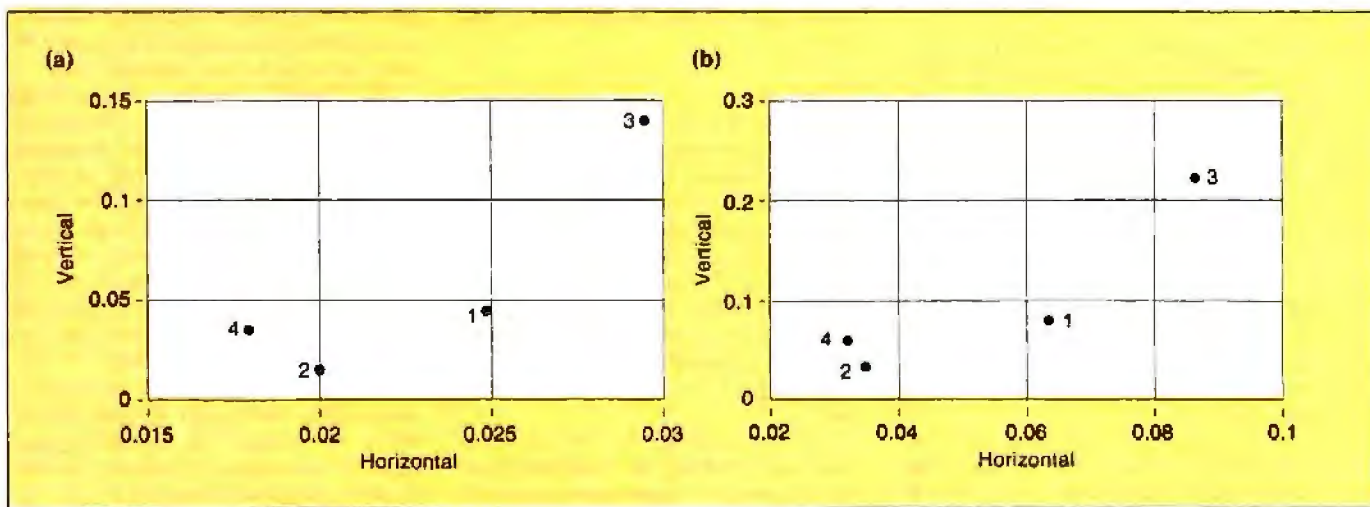

SuperMac card. Other measurements, such as line variation, were better for the SuperMac; this suggests sample-to-sample variations in factory adjustments. The Machroma monitor had the largest spot size and the largest variation between the center and the corner of the screen.

Time variance measures undesirable fluctuations in the beam position. *Jitter* is high-frequency movement (measurements were made over half-second intervals), *swim* is medium-frequency movement (measurements were made over 10-second intervals), and *drift* is low-frequency movement (measurements were made over 60-second intervals). Jitter can cause eyestrain; large amounts of drift can make precision graphics or CAD work difficult.

Microvision measured horizontal and vertical variance separately. Maximum variance and average variance for jitter, swim, and drift were recorded. Measurements were made only in the center of the screen. Again, linear measurements have been adjusted for a 13-inch screen. Figures 2a, 2b, and 2c present the results for average variance of the three measurements. The SuperMac and Apple monitors had the lowest time variance, and the Machroma monitor had the highest.

Misconvergence measures errors in the electron beam/phosphor dot alignment; these errors cause color fringing. Misconvergence was measured at the center of the screen (usually best case) and the

upper left corner (usually worst case). The amount of error in the red-green, blue-green, and red-blue convergence in horizontal and vertical directions was measured separately. Linear measurements were adjusted for screen size. (See figures 3a and 3b.) There were no clear winners here, but the SuperMac had the best horizontal convergence, and the Machroma had the best vertical convergence.

You can gauge the quality of a monitor's voltage regulation by how much a line's position is displaced when the screen is black versus when the rest of the screen is filled with white. Ideally, the line shouldn't move. We compared a horizontal line's position on the screen when the rest of the screen was black, and then when the screen was white; a vertical line was similarly compared. Again, the results were normalized for screen size. Figure 4 shows the voltage regulation test results presented as horizontal and vertical displacements. The AppleColor monitor showed exceptionally good voltage regulation. The Machroma monitor was the only one of the four to show poor high-voltage regulation; the test pattern moved noticeably as the number of displayed pixels changed.

The Price of a Large Screen

None of the three rival monitors was quite as good subjectively as the AppleColor

continued

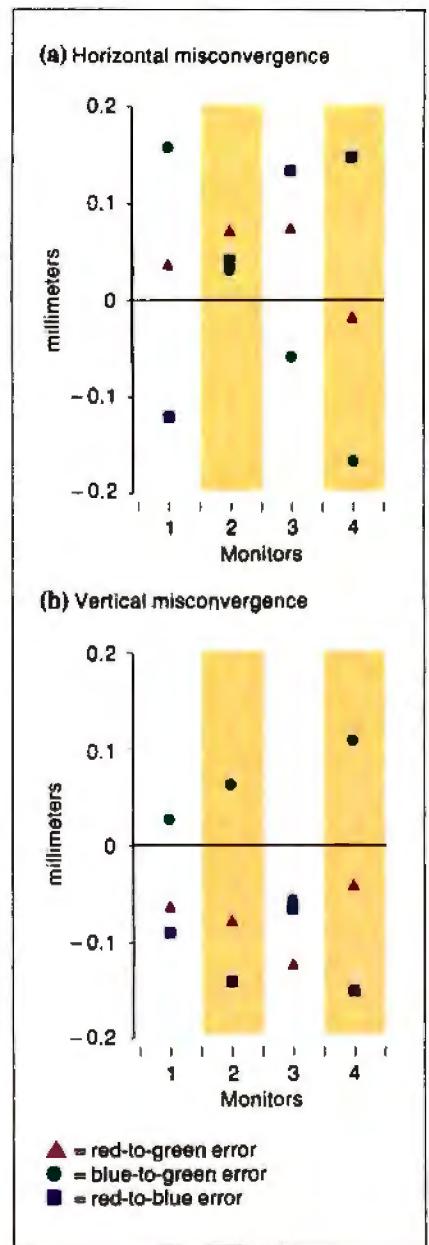

Figure 3a: Horizontal misconvergence at center, in millimeters.
 Figure 3b: Vertical misconvergence at center, in millimeters.

Figure 4: Line displacement in millimeters.

Key to Charts

- 1 PCPC II
- 2 SuperMac
- 3 Machroma
- 4 AppleColor

All measurements are normalized for a 13-inch screen.

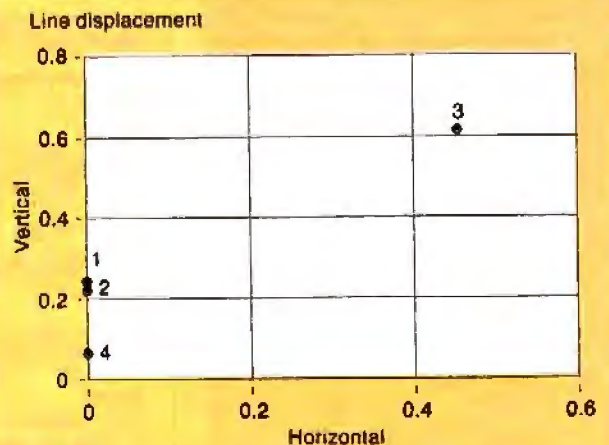
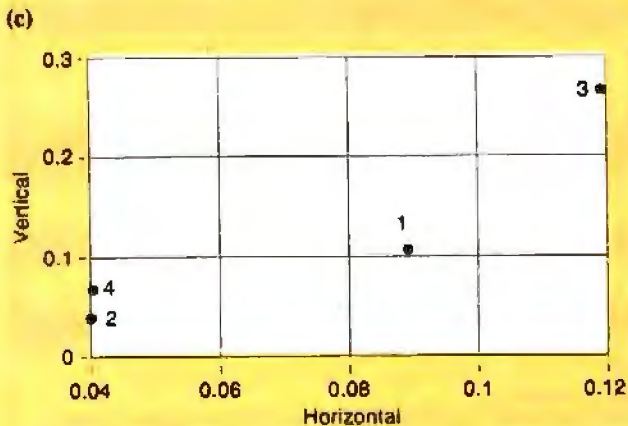

High-Performance IEEE-488 Solutions



for your
IBM PS/2

COMPARE THESE BENEFITS

- Runs on Personal System/2 models 50, 60, and 80 (Micro Channel™)
- Most extensive software library – program in the language of your choice
- Highest performance available – up to 1M bytes/sec data transfer rate using NI Turbo488™ gate array
- ON SRQ interrupt response
- Applications Monitor – real-time error checking and program tracing with pop-up windows
- Best price/performance
- FREE technical support with toll free telephone service
- 30-day money back guarantee
- 2-year warranty



**NATIONAL
INSTRUMENTS™**

The Leader in IEEE-488

12109 Technology Blvd.
Austin, Texas • 78727-6204

CALL FOR FREE CATALOG
800/531-4742 • 512/250-9119

REVIEW: MACINTOSH II COLOR MONITORS

Monitor	PCPC II [Trinitron]	SuperMac Color Trinitron	4Site Machroma C2D	AppleColor High-Resolution RGB Monitor
Screen size	19 inch	19 inch	14 inch	13 inch
Resolution ¹	1024 by 768	1024 by 768	926 by 580	640 by 480
Display area ¹ (In mm)	360 by 270	360 by 270	250 by 180	235 by 176
Aspect ratio	1.33	1.33	1.39	1.33
Dot pitch	0.31 mm	0.31 mm	0.31 mm	0.25 mm
Scanning frequencies ¹	49 kHz by 60 Hz	63 kHz by 60 Hz	35 kHz by 60 Hz	35 kHz by 66.7 Hz
Bandwidth	100 MHz	100 MHz	25 MHz	23 MHz
Power consumption	220 W	300 W	132 W	160 W
Power input	100/120 V 220/240 V	100/120 V 220/240 V	120 V	85/270 V
Antiglare	Yes	Yes	Yes	No
Signal connector type				
Video	3 BNC male	3 BNC male	DB-9 female RCA jack	DA-15 female N/A
Audio	N/A	N/A		
Dimensions	19 by 21 by 19	18 by 21 by 19	13 by 14 by 15	12 by 14 by 15
Weight	90 pounds	84 pounds	29 pounds	34 pounds
Tilt and swivel	Standard	\$250	\$35	\$89
Warranty	1 year	90 days	1 year	90 days
Price	\$5295 ²	\$5190 ³	\$895	\$999
	Inquiry 888.	Inquiry 889.	Inquiry 890.	Inquiry 891.
Notes:				
1. Horizontal by vertical.				
2. Includes price of video board (video board and monitor sold as a set).				
3. Price of monitor and video board (monitor alone is \$3695).				

Board	PCPC CGC/1	SuperMac Spectrum 1000/8	Apple Macintosh II Video Card
Resolution ¹	1016 by 768	1024 by 767	640 by 480
Scanning frequencies			
Horizontal	49 kHz	48.2 kHz	35 kHz
Vertical	60 Hz	59.3 Hz	66.7 Hz
Connector	DB-9 male	DA-15 female	DA-15 female
Board length	10 inches	13 inches	12 inches
Warranty	1 year	1 year	90 days
Price	\$1595	\$1495	\$648 ²
	Inquiry 892.	Inquiry 893.	Inquiry 894.
Notes:			
1. As measured; horizontal by vertical.			
2. Price includes 256K-byte video RAM upgrade for 256 colors (without upgrade, price is \$499, and card displays only 16 colors).			

monitor. The tests indicate that although the AppleColor's convergence and spot size is not as good as that of the larger monitors, the low time-variance measurements and the superior voltage regulation probably contribute to the favorable impression.

From the standpoint of display quality, the two 19-inch monitors were very good. The colors were as good as the AppleColor's, although the displays did not appear to be quite as sharp. The much larger display area is a decided advantage for many applications. Remember, however, that since there are more pixels to update, the two 1024- by 768-pixel monitors are considerably slower than the 640- by 480-pixel screens. Of course, whether the bulk, weight, and price of these monitors is likely to rule them out must be up to you.

The Machroma C2D was disappointing in comparison to the other three monitors. The display did not appear to be as

sharp as the others, and the contrast was low. This observation was confirmed objectively by the test results. In addition, the white had a marked greenish tint. The saturation of pure colors was poor, particularly for red. We found little reason to recommend the Machroma monitor. If you're looking for a medium-size monitor other than the Apple, then you should consider one of the better multiscan monitors reviewed in the February BYTE, such as the Sony CPD 1302 or the Taxan 770 Plus.

Among video cards, the Apple board again set the standard: It worked flawlessly, and it supported the 2-, 4-, 16-, and 256-color modes without any problems. The PCPC video board showed no real problems, but the lack of a 2-color mode made it incompatible with the TMON debugger and SuperPaint. Also, all software works considerably faster when updating 87 percent fewer video bits in a 2-color mode (1 bit instead of 8).

We run our Mac II monitors in the 2-color mode for development work a significant portion of the time, and a board like the PCPC that does not support this would be unacceptable for our own purchase. The 4-color mode is rarely of use, but the 16-color mode frequently proves to be an acceptable compromise between speed and color fidelity.

The SuperMac video board performed capably, but only after the problems with the configuration ROM were corrected. If you decide to buy the SuperMac board, we recommend that you check to see that it has the latest version of the configuration ROM. ■

ACKNOWLEDGMENTS

David Buckstad of Microvision performed the quantitative tests on the four monitors at his company's facilities. David Gelpman of Adobe Systems lent his Mac II and Apple monitor for use during those tests. ■

Pushing the Mac SE

Laurence H. Loeb

Macintosh SE accelerator boards plug into the SE's single expansion slot to let SE owners upgrade their computers to near-Macintosh II power without buying a new and more expensive machine. The two accelerator boards examined here, the Radius Accelerator (\$995) and MacMemory's Turbo SE (\$599), claim to more than double the Mac SE's processing power.

The idea of a plug-in board that bypasses the Mac SE's processor is not a new one. In a previous review (November 1987 BYTE), I looked at two of the first accelerator boards for the SE: the Prodigy SE from Levco and the HyperCharger 020 from General Computer Corp. (GCC). These two boards boost the Mac SE's computing power by supplying a 16-MHz 68020 processor and 1 megabyte of 32-bit memory that replaces the computer's original 8-MHz 68000 processor and 1 megabyte of 16-bit memory.

The Radius Accelerator and Turbo SE, however, use different approaches to enhance the Mac SE's performance. While the Radius accelerator has an on-board 16-MHz 68020, it uses 32K bytes of zero-wait-state 32-bit-wide cache memory. The MacMemory board uses a 16-MHz 68000, clocked at twice the speed of the SE's processor, but it still uses the

Mac SE's 16-bit memory for program storage. Like the Prodigy SE and HyperCharger, both of these boards have a socket for an optional 68881 floating-point unit (FPU).

The Radius Accelerator

The first board I examined was the Radius Accelerator. I looked forward to evaluating this product because it offered a reasonably priced board with a 68020 processor and the 68881 FPU socket (the review unit contained the 68881).

The installation documentation that came with the board was abysmal: It consisted of a single sheet of paper with text printed on each side. The documentation cautions that only a Radius authorized dealer should install the board. There's good reason for this: Its design results in an installation procedure that, with some bad luck, could damage your Mac SE motherboard.

The SE motherboard is hinged on one side. To remove it, you shift the motherboard along its axis, then swivel it out of its locked position (much like pulling up on a door before swinging it open). The Radius daughterboard contains a connector that coincides with a hole in an internal metal strut when the board is installed on the Mac SE motherboard. The con-



The MacMemory Turbo SE board (left), and the Radius Accelerator board (right).

connector implements Radius's "MagicBus," an expansion bus for additional hardware add-ins. Currently, it connects only to Radius's Full Page Display.

The MagicBus connector prevents you from reinstalling the motherboard in the same way that you took it out (i.e., you can't swing the door shut, then let it drop down). Radius's installation notes say that "you will not be able to slide the Macintosh board back into the chassis and will have to pop it back into place by putting first one edge into the side rail and then prying with a flat blade screwdriver to pop the other edge into the side rail." In almost a year of product reviews, this is as close as I have come to cracking the Mac SE's motherboard in half. Until this installation procedure is changed, I recommend that your Radius

continued

Radius Accelerator	Turbo SE
Type Macintosh SE accelerator board	Type Macintosh SE accelerator board
Company Radius Inc. 404 East Plumena Dr. San Jose, CA 95134 (408) 434-1010	Company MacMemory 2480 North First St. San Jose, CA 95131 (800) 862-2636 (408) 922-0140
Features 16-MHz 68020 processor; socket for 68881 math coprocessor; 32K bytes of zero-wait-state cache memory; connector for Radius Full Page Display	Features 16-MHz 68000 processor; socket for 68881 math coprocessor; uses memory already in Mac SE; adds 128K bytes of memory for use by video and sound circuitry; connector for The Big Picture video display from E-Machines; Turbo881 INIT file for 68881 support
Size 8½ by 4¼ inches	Size 8½ by 5 inches
Hardware Required Macintosh SE	Hardware Required Macintosh SE
Software Required System 3.2/Finder 5.3 or higher	Software Required System 3.2/Finder 5.3 or higher
Documentation Two-page <i>Installation Guide</i> ; 12-page <i>User's Manual</i>	Documentation 57-page <i>Turbo SE Installation and Owner's Manual</i>
Options 16-MHz 68881 math coprocessor: \$395	Options 16-MHz 68881 math coprocessor: \$399 4 megabytes of 120-ns RAM: \$1798 (price varies)
Price \$995	Price \$599
Inquiry 886.	Inquiry 887.

dealer install the board, even if you are technically competent. Once installed, the accelerator board doesn't require any further adjustments via the Control Panel or a desk accessory.

A 12-page user's manual provides tips on using the board. It shows you simple things such as how to tell when the accelerator is active (it displays a start-up screen) and how to turn the accelerator off (hold down the mouse button after you power up the computer—you can turn it off from a preferences panel that appears). If you use MacWrite 4.5, you don't have to add a special compatibility file, as some accelerator boards require, because the Radius board patches the offending TRAP vectors automatically. This feature is of limited value if you're using MacWrite 4.6, which works correctly with all Macintoshes.

A yellow insert in the package advises you to back up your hard disk before installing the Accelerator because some

formatting software "has exhibited incompatibility problems with the Accelerator, destroying data on start-up." Radius also provides a list of tested hard disk drives. Backing up the hard disk drive is a good idea before doing any major hardware change.

The Radius board requires that you power down the Mac SE to switch between the 68020 mode and the 68000 compatibility mode. Some users may find fault with the need to power down the Mac to change modes, but I never found this procedure necessary because I encountered no software incompatibilities.

The latest versions of all the software I normally use worked with the Radius's 68020 mode. Several programs that use the 68881 floating-point processor also worked just fine, including beta versions of Borland's Eureka for the Mac and Super-3D by Silicon Beach Software. Red Ryder 10.3 worked well with the board, too, although version 9.4 of the

program had caused problems with the Prodigy SE and HyperCharger boards. This indicates that software vendors have tried to make their code 68020- and 68881-compatible since the Mac II's introduction.

Fast Cache Memory

The problems with installation should not blind you to the immediate benefits of using the Radius Accelerator: Programs run noticeably faster, and the screen refreshes itself faster. One example is returning to Finder from an application. With a hard disk, Finder can take a few seconds to redraw all the icons on a crowded desktop. Maybe it's my Type A personality, but waiting for this redraw annoys me. With the Radius board installed, this redraw time is decreased to acceptable levels.

A significant factor in the Radius's performance is its one unique feature: cache memory. Unlike the Prodigy SE or HyperCharger boards, the Accelerator doesn't have a megabyte of 32-bit memory to store the executing program. It has 32K bytes of zero-wait-state 32-bit cache memory, of which 22K bytes is used to store the memory-mapped screen (one of the reasons the board appears to work fast is the quick screen-refresh time), 8K bytes is for program data, and 2K bytes is for "housekeeping" information. When a cache miss occurs, the program code (which is in 16-bit memory) is simultaneously executed and copied into the cache, avoiding a separate copy operation that would slow the processor down.

As a result, the computer stores the most recently used parts of the program (whether executing code or Macintosh ROM calls) in cache memory. This minimizes the Mac SE's number of slower 16-bit memory accesses and allows the 68020 to do fetches from cache memory at the maximum data transfer rate. Radius's 32K bytes of cache memory is faster than the HyperCharger's and Prodigy's 1 megabyte of memory because these boards' memories always run at one wait state, while Radius's always runs at zero wait states.

The Turbo SE

MacMemory takes a completely different approach in its Turbo SE board. It uses a 16-MHz 68000 processor clocked at 15.8 MHz (from the C16M signal present in the SE) to speed things up. The company says it took this approach (which none of the other boards uses) to offer compatibility with all existing Mac software. (However, as I stated earlier, I didn't find software incompatibility with the 68020 to be a problem.)

continued

AutoSketch®

A Resource to Draw Upon



To get any job done, you need the right tools. Ideally, they should be extensions of your talents, freeing you to do what you do best. And speed, precision, flexibility, and consistency are always top priorities, no matter what the job.

If communicating with drawings is part of your job, AutoSketch should be one of your resources.

AutoSketch from Autodesk, the developers of AutoCAD®, is the precision drawing tool for professional use. It's fast, powerful, and simple to learn. The price is right, too.

With AutoSketch and your personal computer, you'll enter the world of computer-aided drawing with ease. You may never have designed with a PC before, and you may think it's bound to be complicated and time-consuming. Surprise! With AutoSketch, you'll probably be up and running in about an hour.

Despite its ease of use, AutoSketch is a full-function, object-oriented CAD program. Pull-down menus and dialog boxes help you each step of the way. With a click of the mouse, you can draw, then copy, mirror, or move objects, even create symbol libraries. AutoSketch automatically updates measurements whenever you stretch, scale, or rotate dimensioned objects. It even keeps track of everything you do, so that you can delete and restore parts of your drawing as easily as you change your mind, using successive undo or redo commands.



We know you'll be impressed with the professional results. So will your clients and colleagues.

AutoSketch runs on the IBM PC/XT/AT and 100% compatible systems with a minimum of 512K RAM and either color or monochrome display. If your PC has an 8087 or 80287 math coprocessor, the standard version operates about three times faster. The speed-enhanced version, requiring the coprocessor, is three times faster still.

Call 800-445-5415 for the name of the AutoSketch Dealer nearest you or more information on supported peripherals. To order direct with MasterCard or Visa, call 800-223-2521, or 415-331-0356.

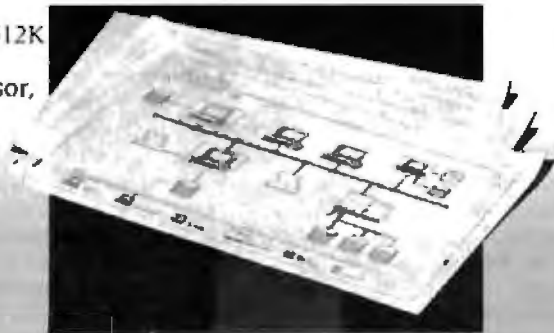

Circle 28 on Reader Service Card



Table 1: As these benchmarks show, the Radius board outperforms the Turbo SE and boosts the Mac SE's performance to close to that of the Mac II. All times are in seconds, except the Dhrystone, which is in Dhrystones per second.

	Prodigy SE	Hyper-Charger 020	Standard Mac II	Radius Accelerator	MacMemory Turbo SE	Standard Mac SE
Dhrystone*	3125	3125	2631	2941	1470	887
Fibonacci	51.81	52.08	58.9	59.78	126.7	203.1
Float	17.98	27.54	14.4	32.57	24.32	123.0
Savage	52.08	52.69	226.2	457.2	43.79	1927
Sieve	10.58	10.63	11.9	9.87	26.88	46.22
Sort	18.56	18.60	19.6	18.35	41.67	74.10
Open spreadsheet	N/A	N/A	8.59	11.24	14.36	21.9
Recalculate spreadsheet	N/A	N/A	1.99	1.99	2.67	4.90
Scroll	N/A	N/A	111	100	149	273
Price, with 68881 FPU (for boards only)	\$1499	\$1699	N/A	\$1390	\$2796 with 4 meg of 120-ns RAM	N/A

*For the Dhrystone test only, higher numbers denote faster performance.

Notes:

1. The Radius tested had 1 megabyte of memory and 32K bytes of fast hardware cache memory. The Turbo SE had 4 megabytes of 120-ns memory. The HyperCharger used the SE memory as a 1-megabyte RAM disk and had an additional 1 megabyte of 32-bit memory. The Prodigy had 1 megabyte of SE memory and 1 megabyte of 32-bit memory. The Mac SE and Mac II had 1 megabyte of memory each.
2. For details on the C language benchmarks, see "A Closer Look" by Richard Grehan in the September 1987 BYTE.
3. The Spreadsheet tests open and recalculate a 25-by-100-cell Excel 1.04 spreadsheet. Scroll shows how long it takes to scroll through a 40K-byte MacWrite 4.6 text file from beginning to end.

The Turbo SE also installs differently from the others. One of the ways that MacMemory achieves its low price is to use the 16-bit memory of the Mac SE—which makes sense because its 68000 processor can't use 32-bit-wide memory. But you must take the SIMMs (single in-line memory modules) from the motherboard and put them into the accelerator card. This is not beyond what a technically competent user can do, especially with the 21-page well-illustrated installation section in the Turbo SE manual (which is the best such manual I have seen so far).

MacMemory also recommends that you take the two Mac ROMs and place them in sockets on the Turbo SE daughterboard. They work faster that way, but jumper blocks on the board let you leave the ROMs on the motherboard if you don't want to move them.

MacMemory supplies two 64K-byte SIMMs that you plug into the now-vacant SIMM3 and SIMM4 motherboard memory sockets. The Mac then uses this memory for the video display, leaving the remaining memory for other uses. According to the company, these changes "increase screen drawing speed by al-

most 50 percent above the speed gained by doubling the Mac SE's clock speed."

Once you have installed the ROMs and SIMMs, the board inserts into the SE expansion connector without problems. The two plastic retainers that connect the accelerator and motherboard are the best way of providing mechanical support that I have seen in all the boards I have reviewed. They are much easier to install and remove than the plastic post and the metal-screw-with-nonremovable-lock-washer system that Radius uses.

The last step of the installation process is to set the on-board jumpers to the correct positions for the RAM/ROM configuration installed. The board can accept up to 4 megabytes of 120-nanosecond (ns) memory, although the Mac SE's memory (which will go on the Turbo SE board unless you buy new SIMMs) is 1 megabyte of 150-ns memory.

The Turbo SE's manual is clearly designed to assist the technically competent user in installing the board. But, like Radius, MacMemory insists that only certified technicians should do the installation, to keep from voiding AppleCare coverage and any Apple warranties.

The Turbo SE's options include E-

Machine's Big Picture video display (which connects to a socket on the board) and the 68881 floating-point coprocessor, which was installed on the board I reviewed. MacMemory provides a software INIT file to patch the calls from the Apple SANE (Standard Apple Numerics Environment) to use the 68881. This allows Excel, for instance, to recognize that the 68881 is present even though a 68020 isn't. To install INIT, drop it into the System Folder of your start-up disk (whether a hard or floppy disk), then restart your Mac using this disk.

Ranking Performance

Once installed, how do these boards stack up? To get an objective measurement, I ran BYTE's set of C benchmarks with both boards, using Lightspeed C 2.01. I also checked the boards' performance on a couple of applications-oriented tests with Excel 1.04 and MacWrite 4.6. For the Excel and MacWrite tests, the System Folder had no unnecessary INIT and cdev files, and there was no caching from the Control Panel. To measure its maximum performance, I tested the Turbo SE with 4 megabytes of 120-ns (one-wait-

continued

DesignCAD 3-D

3-D CAD You Can Afford

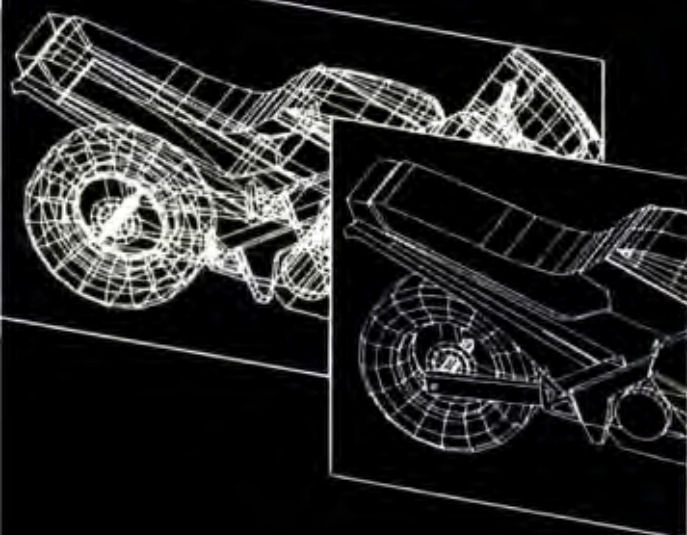

DesignCAD 3-D is a complete 3-Dimensional CAD system. It compares favorably with systems costing more than \$3000! But, in the great American tradition, we said "Aw... What the Heck! Let's see if other guys beat this!" DesignCAD 3-D is \$299. Complete.

Once again, American Small Business Computers has proved that you don't always have to spend a lot of money to get quality software. DesignCAD 3-D provides features such as Shading, Hidden Line Removal, Printer and Plotter support, and extensive file transfer capability, all for \$299! No other 3-Dimensional CAD system can come close to providing the price-performance of DesignCAD 3-D.

There is a very important reason to buy DesignCAD 3-D other than price: PERFORMANCE. DesignCAD 3-D provides complete 3-Dimensional drawing capabilities. It's not a "warmed over" 2-D program. DesignCAD 3-D allows you to draw any entity in 3-D space. This means, for example, that you can draw a curve in the shape of a spring. You can draw a circle or arc at ANY angle on ANY plane.

DesignCAD 3-D allows up to 4 simultaneous views - any angle or perspective - on the screen. DesignCAD 3-D also provides complex extrusions - linear, scalar, and circular. Extensive 3-D text capabilities and auto dimensioning are provided - at no extra charge, of course.

DesignCAD 3-D provides the capability to read drawings from most other CAD systems (DesignCAD ProDesign II, AutoCAD's DXF, and IGES file formats). You can also send a view of a 3-D drawing to other CAD systems. These features are included at no extra charge, of course.

DesignCAD 3-D almost certainly is compatible with the computer system you now own. DesignCAD 3-D supports more than 200 dot matrix printers, at high resolution. DesignCAD 3-D supports more than 80 plotters, and most digitizers and graphics adapters available for "PC Compatible" systems. Shaded and wireframe models can be output to the printer or plotter YOU own.

DesignCAD 3-D does not require expensive graphics adapters and monitors - even shading can be done on ordinary displays such as the Enhanced Graphics Adapter (EGA), Color Graphics Adapter, or Hercules monochrome adapter.

However, the best reason to buy DesignCAD 3-D is not the low price. It's not the outstanding performance. It's not the extensive hardware compatibility. The best reason to buy DesignCAD 3-D is for its amazing ease of use!

DesignCAD 3-D provides powerful commands you can use to produce professional 3-Dimensional drawings in less time than you thought possible! DesignCAD 3-D commands can be selected from the menu or entered as fast, single keystroke commands. We have found DesignCAD 3-D to be easier to learn and easier to use than any 3-Dimensional CAD system for the IBM PC, at any price!

What else do you need to know about DesignCAD 3-D? Only this: "Included at No Extra Charge." What is included at no extra charge? EVERYTHING! \$299 BUYS IT ALL!

How do you get one?

See your local dealer, or contact:

American Small Business Computers, Inc.
118 South Mill Street
Pryor, OK 74361
(918) 825-4844

Telex 9102400302

state) memory. All four accelerator boards had a 68881 installed.

In all the tests except the Float and the Savage, the Radius board outperformed the Turbo SE, turning in times from 50 percent to almost 300 percent faster (see table 1). The Turbo SE outranked the Radius board in both the Float and the Savage; the Turbo SE's performance on the Savage benchmark was more than 10 times better than the Radius's.

True to the company claims, both accelerator boards significantly outperformed the Mac SE. In all but the Float and Savage benchmarks, the Radius board matched or topped the Mac II. The Turbo SE beat the Mac II in the Savage only, falling short on the other tests.

Neither the Radius Accelerator nor the Turbo SE matched the Dhrystone performances of the Prodigy SE and the HyperCharger 020. However, the Radius Accelerator approached their performances in several of the tests. The Turbo SE came close to or beat their performances in the Float and Savage benchmarks only.

The times for the Savage benchmark deserve some interpretation and qualification. The Radius board does poorly (457.2 seconds) because it uses the SANE routines to calculate the transcen-

dental functions that the Savage benchmark emphasizes. The HyperCharger's time of 52.69 seconds is achieved with the use of GCC's numerics package, which is less accurate than Apple's SANE, but much faster. (The SANE package, based on an IEEE floating-point arithmetic standard, is much more precise than most applications require—the GCC numerics package has an error of 6×10^{-14} compared to the SANE's result.) Note that when the HyperCharger uses the SANE package, it achieves a time of 458.91 seconds—virtually identical to the Radius's result.

A spokesperson at Radius said that the company is now testing its own faster math package, which may be available by the time you read this. Like the HyperCharger, the Levco Prodigy uses a numerics package that's less accurate but faster than SANE; it offers no option for using SANE, however.

Most Bang for the Buck?

Although the Radius Accelerator has a risky installation procedure, I prefer this board to the Turbo SE. Its increase in performance is worth the extra \$400 (or less, depending on street prices) over the base price of the Turbo SE.

If you're really on a tight budget, the Turbo SE with 1 megabyte of 150-ns memory offers an improvement over an unenhanced Mac SE. However, if you buy 4 megabytes of 120-ns SIMMs from MacMemory for maximum performance, the price of the Turbo SE jumps to about \$2796—about \$1400 more than the cost of the Radius board. Keep in mind, though, that MacMemory's SIMMs are pricey; you can buy less expensive ones from other vendors.

Overall, though, the performances of the Levco Prodigy SE and the GCC HyperCharger 020 make them still better choices—even over a Mac II—if you can afford them. ■

ACKNOWLEDGMENT

I would like to thank Rich Siegel, customer support representative of Think Technologies, whose help with 68881-related matters contributed to the background of this review.

Laurence H. Loeb is an electrical-engineer-turned-dental-surgeon and is co-moderator of the macintosh conference on BIX. He can be reached at PBC Enterprises, P.O. Box 925, Wallingford, CT 06492, or on BIX as "lloeb."

How a software engineer got to captain the lunar landing module.

The Computer Museum is everything you'd expect, and a lot of things you wouldn't.

Of course, the museum contains a collection of the most significant accomplishments in the history of information processing. But it's not just a great place to see things, it's also a great place to do things.

There are over twenty interactive exhibits at The Computer Museum. You can design a car, create your own fractal landscape, or even captain the lunar landing



module on the Apollo flight simulator.

So, the next time you're in Boston, stop by The Computer Museum. You'll discover it's more than a lot of machines, it's also a lot of fun.

For more information, or to become a Museum Member, write The Computer Museum, or call (617) 423-6758.

The Computer Museum

B O S T O N
There's something in it for everyone

300 Congress Street, Boston, MA 02210

ALL CLONES ARE CREATED EQUAL....BUT CMO MAKES THE DIFFERENCE
 GREAT PRICING • EXPERT CONSULTATION • ONE YEAR WARRANTY



BASIC SYSTEM CONFIGURATION:

- NEC V-20 CPU, 12 MHz Speed
- 640K Mother Board Memory
- 8 I/O Expansion Slots
- 360K Floppy Disk Drive
- Floppy Disk Drive Controller
- Clock Calendar with Battery Backup
- 150 Watt Power Supply
- IBM Compatible BIOS
- 4 Half Height Front Storage Slots
- 100-Key AT-XT Switchable Keyboard
- 24 Hour Burn-In

BASE SYSTEM PRICE: No CAPC12-01 **\$579**
 Monitor Optional

BASIC SYSTEM CONFIGURATION:

- 8 MHz 80286 16-Bit Microprocessor
- 512K Motherboard Memory Expandable to 1 MB
- 12 I/O Expansion Slots (6 16-Bit & 2 8-Bit)
- Clock Calendar with Battery Backup
- 1.2 MB Floppy Disk Drive
- Hard Disk/Floppy Controller Card
- 238 Watt Power Supply
- Fully Compatible High Speed BIOS
- 84 Key 5151-Type Style Keyboard
- Microsoft MS-DOS with GW Basic
- 5 Half-Height Front Storage Slots (4 exposed)
- 24 Hour Burn-In
- DOS with GW Basic

BASE SYSTEM PRICE: No CA5170-01 **\$999**
 Monitor Optional



BASIC SYSTEM CONFIGURATION:

- 10 MHz 80286 16-Bit Microprocessor
- 512K Motherboard Expandable to 1 MB
- 12 I/O Expansion Slots (6 16-Bit & 6 8-Bit)
- Battery Backed-up/Real-Time Clock
- 1.2 MB Floppy Disk Drive
- Dual Hard Disk/Dual Floppy Controller Card
- 238 Watt Power Supply
- Fully Compatible High Speed BIOS
- 5 Half-Height Front Storage Slots (4 exposed)
- 101-Key Enhanced Keyboard
- 24-Hour Burn-in

BASE SYSTEM PRICE: No CA5191-01 **\$1199**
 Monitor Optional



COMPUTER MAIL ORDER

477 East Third Street, Dept. A1, Williamsport, PA 17701
 All Major Credit Cards Accepted

JOIN OVER 350,000 SATISFIED CUSTOMERS
CALL 1-800-233-8950
 Outside the U.S.A. 717-327-9575
 FAX 717-327-1217



**IBM
PS/2 Model 30**
 • 720KB 3 1/2" Disk Drive
 • 640K RAM, 8MHz
 • 20 MB Hard Drive
 • 101 Enhanced Keyboard

No. IBS32

\$1699



**IBM
PS/2 Model 50**
 • 80286, 10 MHz
 • 128K ROM, 1 MB RAM
 • 20 MB Hard Drive
 • 1.44 MB 3.5" Disk Drive

No. IBS50

\$2799



**IBM
PS/2 Model 80**
 • 80386, 16 MHz Micro Processor
 • 1 MB RAM, VGA Display
 • 40 MB Fixed Disk Drive
 • 1.44 MB 3.5" Disk Drive

No. IBS80

\$5299



**AST
Premium Model 140**
 • 1.2 MB Floppy, 101 Keyboard
 • FastRAM 1MB
 • 80286, 10MHz, Zero Wait
 • AST 3 G Plus Board

No. ATP140

\$2499



**COMPAQ
DeskPro 386/20 Model 60**
 • 80386 Processor, 20 MHz
 • 1 MB RAM, 1.2 Floppy
 • 60 MB Hard Drive
 • Parallel and Serial Ports

No. CQ145

\$5899



**NEC
PowerMate II**
 • 1.2 MB Floppy Drive
 • 640K RAM, 10 MHz
 • 40 MB Fixed Disk Drive
 • MS-DOS 3.2 & GW-Basic

No. NIH501K

\$2399



**TOSHIBA
T-1000 Lap Top**
 • Fully IBM compatible
 • 512K RAM
 • 720K 3 1/2" Disk Drive
 • 640 x 200 Pixels

No. TB1000

\$799



**NEC
Multispeed EL**
 • Dual 3 1/2" 720K Floppies
 • 640K RAM, 512K ROM
 • Backlit LCD Screen
 • 9.54 MHz CMOS V-30

No. NIMSB

\$1599



**COMPAQ
Portable 386 Model 40**
 • 80386 Processor
 • 1 Megabyte RAM
 • 40 MB Fixed Drive
 • 1.3 MB Diskette Drive

No. CQ114

\$6199



BOCA VEGA
640 x 350 Resolution
16 Color/64 Palette
256K of Video Memory

No. BOEGA **\$149**



BOCA BocaRam AT
• 16 Bit, Runs to 16 MHz
• 1 MB - 4 MB Memory
• Expanded, Extended, LIM

No. BOAT10 **\$299**



VIDEO SEVEN VEGA Deluxe
• 752 x 410 Display
• EGA, CGA, MGA, HGC
• 256K-DRAM Screen Buffer

No. VSEGAD **\$229**



VIDEO SEVEN VEGA V•G•A
• 800 x 800 Resolution
• 256 Simultaneous Colors
• Supports Both Analog & Digital

No. VSVG A **\$329**



SENG LABS EVA/480
640 x 480 Resolution
CGA, MDA and Hercules Compat
Parallel Port Standard

No. TL480 **\$229**



EVEREX Autoswitch Enhancer
• Autoswitch EGA
• 132 Column Operation
• Parallel Printer Port

No. EV857 **\$149**



EVEREX RAM 3000 Deluxe
• 0K-3MB Memory
• EMS, Extended, BASE for AT
• Utility Software

No. EV159 **\$99⁹⁹**



QUADRAM XT386 Board
• PC Upgrade to 80386 Processor
• 1 MB of Onboard Memory
• Quadmaster Software Included

No. QU3861 **\$799**



INTEL Above Board/286
512K Expandable to 2 MB
Conventional, Expanded & Extended
Memory
AT&XT to 12.5MHz

No. IN4020 **\$349**



INTEL In Board/386/PC
• Converts PC to 16MHz
• 80386 Microprocessor
• 1MB On Board Memory

No. IN1B1200 **\$799**



INTEL Math Co-Processors
No. IN8087 PC **\$129**
No. IN80287-BAT **\$299**
No. IN80287-10AT **\$319**
No. IN80387 **\$539**



HERCULES Graphics Card Plus
• 720 x 348 Bit Mapped Graphics
• RAM Font Software Included
• Parallel Port

No. HEGCP **\$169**



ZUCKERBOARD PS/2 0/60 Multifunction Board
512K to 2 MB Memory
Parallel and Serial Ports
EMS and Diagnostic Software

No. HX15 **\$289**



IDEA 5251 Terminal Emulation
• Local Twinax Communication
• IBM 34/36/38 Compatible
• Printer Support, Hot Key

No. IE5251 **\$579**



IRMA IRMA Board 2.2
• Native Mode Coaxial Link
• IBM 3270 Controller Compatible
• SNA/SDLC or BSC

No. IRMA2 **\$799**



FIFTH GENERATION The Logical Connection
• 4 Serial, 2 Parallel in, 2 Parallel out
• Daisy-chainable up to 315 devices

No. ICFI02 256K **\$289**
No. ICFI03 512K **\$369**

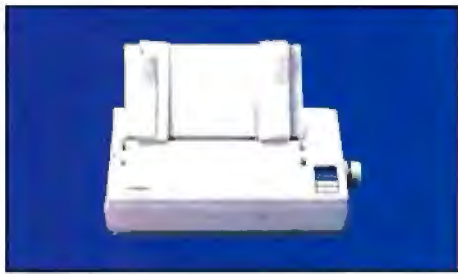

EPSON LX-800

- 150 cps Draft/30 cps NLQ
 - 9 Pin Dot Matrix, 80 Column
 - Built-in Tractor Feed
- No. EPLX800

\$179

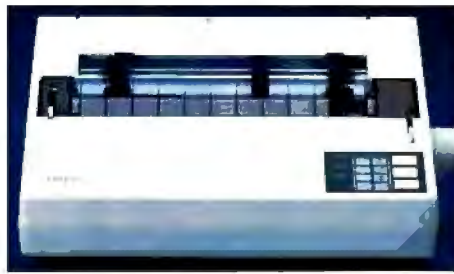

EPSON EX-800

- 9 Pin Dot Matrix
 - 300 CPS Draft/50 CPS NLQ
 - 80 Column, 8K Buffer
- No. EPEX800

\$429

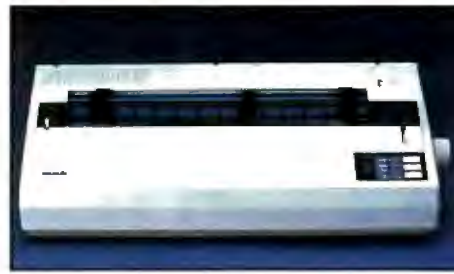

EPSON EX-1000

- 9 Pin Dot Matrix
 - 300 CPS Draft/50 CPS NLQ
 - 132 Column, 8K Buffer
- No. EPEX1000

\$489



EPSON FX-286E

- 240 cps Draft/40 cps NLQ
 - 132 Column, 8K Buffer
 - Friction/Tractor Feed
- No. EPFX286E

\$479



EPSON LQ-500

- 24 Pin Dot Matrix
 - 180 CPS Draft/60 CPS NLQ
 - 8K Input Buffer
- No. EPLQ500

\$339



EPSON LQ-850

- 330 cps Draft/60 cps NLQ
 - 24 Pin Print Head
 - Parallel/Serial with 6K Buffer
- No. EPLQ850

\$529

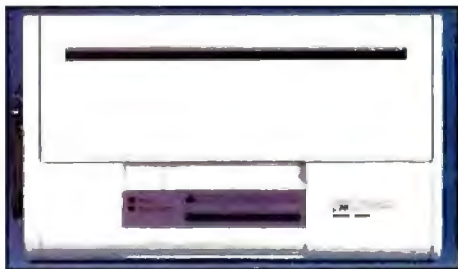

DICONIX INKJET 150P

- AC/DC Powered Portable
 - Centronics Parallel 8 Bit
 - 150 cps Draft/50 cps NLQ
- No. KD150

\$319



SHARP FO-210 Facsimile

- Half-tone Transmission
 - Automatic Contrast Adjustment
 - Automatic dialing for 87 #'s
- No. SHF0210

\$1499



CANON PC-25 Personal Copier

- 8 copies per minute
 - Wait time 20 seconds
 - Copy size up to 356x216 mm
- No. CC25

\$899



OKIDATA ML-193 Plus

- 200 CPS Draft, 40 CPS NLQ
 - 8K Print Buffer
 - 9 Wire, 132 Column
- No. OK193I

\$469



OKIDATA ML-293

- Dual 9 Pin Dot-Matrix
 - 240 cps Draft/100 cps NLQ
 - 136 column, 8K Buffer
- No. QK293

\$539



OKIDATA ML-393 Plus

- 450 cps Draft/160 cps NLQ
 - 24 Wire Dot Matrix
 - Personality Module Concept
- No. QK393

\$989



BROTHER M-1509 Dot Matrix
 • 180 CPS Draft/45 CPS NLQ
 • Auto Paper Loading
 • Friction and Pin Feed
 No. BRM1509 **\$389**



BROTHER HR-40 Daisywheel
 • 40 CPS, 136 Columns
 • 2 Color Printing
 • Friction and Forms Tractor
 No. BRHR40 **\$599**



BROTHER HR-60 Daisywheel
 • 60 CPS, 136 Columns
 • Diablo 635 compatible
 • Standard Parallel Interface
 No. BRHR60 **\$739**



NEC 2200
 • 24-Wire Dot Matrix
 • 170 cps Draft/55 cps NLQ
 • 360x360 Dots per inch
 No. NIP2200 **\$379**



NEC P760 Pinwriter
 • 24-Wire Print Head
 • 216 cps Draft/65 cps NLQ
 • 136 Column Carriage
 No. NIP760 **\$659**



C.ITOH 315XP
 • 300 cps Draft/50 cps NLQ
 • 15" Carriage Width
 • IBM/Epson compatible
 No. TE315XP **\$559**

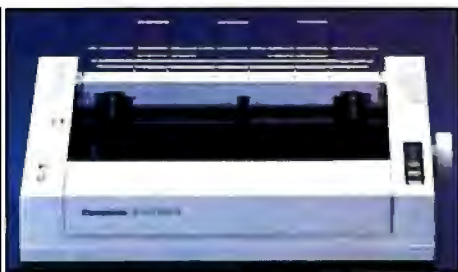

PANASONIC KX-P1091-II
 • 194 CPS Dot Matrix
 • 9-Pin Print Head
 • IBM Pro Printer Emulation
 No. PA1091 **\$199**



STAR MICRONICS NX-1000
 • 144 cps Draft/35 cps NLQ
 • 4K Buffer, 80 column, Auto feed
 • Friction and Tractor Feed
 No. SGNX1000 **\$179**



STAR MICRONICS NX-15
 • 120 CPS Draft, /50 CPS NLQ
 • 5K Buffer, 132 Column
 • Friction & Tractor Feed
 No. SGNX15 **\$319**



TOSHIBA P321SL
 • 24 Wire Print Head
 • 216/180/72 cps
 • Character font cartridges
 No. TB321SL **\$529**



TOSHIBA P351-SX
 • 24 Wire Print Head
 • 360 cps Draft/120 cps NLQ
 • 136 column, Parallel/Serial
 No. TB351SX **\$999**



CITIZEN Premier 35
 • 35 cps Daisywheel
 • Built-in clock/calendar display
 • Error messages in English
 No. CZMSP35 **\$479**



MAGNAVOX Monochrome Monitor
 • 12" Amber or Green Display
 • 1000 Lines
 • Dark Glass CRT
 No. NAP613 Green
 No. NAP623 Amber **\$89⁹⁹**



MAGNAVOX RGB/Composite
 • 13" Dark Bulb Screen
 • 600 x 240 Pixel Resolution
 • Green Text Display Switch
 No. NAP652 **\$269**



MAGNAVOX Enhanced Display
 • Up to 690 x 350 Resolution
 • 64 Colors in EGA Mode
 • Text Display Function
 No. NAP053 **\$369**



MAGNAVOX Multimode Display
 • Digital and Analog
 • 926 x 580 display
 • 15 KHz to 34KHz
 No. NAP873 **\$489**



AMDEK Video 410 Series
 • 12" TTL Amber, Green, White
 • Up to 960 lines
 • Flat non-glare screen
 No. AM410A, G, or W **\$159**



AMDEK Color 722
 • 13" In-Line etched screen
 • Supports 64 Colors
 • 720 x 350 Display
 No. AMC722 **\$429**



AMDEK Monochrome/432
 • PS/2 MCGA & VGA Compatible
 • 640 x 480 Pixel Resolution
 • 31.48 KHz Scan Frequency
 No. AM432 **\$179**



AMDEK Monitor/732
 • Palette of 256,000 colors
 • 12" Etched Glass, Non-Glare
 • 640 x 480 MCGA Compatible
 No. AMC732 **\$499**



PRINCETON MAX-12
 • 12" Amber TTL
 • 720 x 350 Display
 • 16 Shades
 No. PNM12 **\$139**



PRINCETON Ultrasync
 • 12" Analog/TTL .28mm Dot Pitch
 • 800 x 600 Resolution
 • IBM PS/2 & Mac II Compatible
 No. PN12U **\$549**



ZENITH ZMM-149 VGA
 • IBM VGA Monochrome
 • 14" High Resolution
 • 31.48 KHz Scan Frequency
 No. ZVA149 Amber
 No. ZVW149 White **\$239**



ZENITH ZCM-1490 VGA
 • 14" Analog/TTL .31 Dot Pitch
 • 64 Available Colors
 • 25 MHz, 640 x 480 Resolution
 No. ZEC1490 **\$749**



THOMPSON Model 4120
 • 14" RGB/Comp/Analog
 • 580 x 240 Pixel Resolution
 • .51 Dot Pitch, 12 MHz
 No. TPC4120 **\$239**



THOMPSON Model 4375M
 • 14" Super High Contrast
 • 64 Available Colors
 • 30 MHz, 800 x 560 Resolution
 No. TPC4375M **\$499**



NEC 1402 Multisync II
 • Multisync RGB
 • 800 x 560 Display
 • 6 Text Switchable
 No. NEC1402 **\$589**



NEC Multisync Plus
 • 15" Flattened CRT
 • 960 x 720 Resolution
 • 3-Way Text Switch
 No. NEC1501 **\$999**



MOUNTAIN Drivecard

- 20 Meg. No. MB20
- 30 Meg. No. MB30
- 50 Meg. No. MB50

\$469
\$519
\$699



MOUNTAIN Dual 20 Bernoulli

- Bernoulli Technology
- Dual 20 MB Cartridges
- Requires PC2 Controller

No. MBB4174 **\$1799**



PC-T00 Datasave 4000

- 40 MB Formatted capacity
- 3 1/2" Pocket Size Cartridges
- Uses existing floppy controller

No. MBPC1206 **\$479**



POLAROID Palette Plus

- Computer Image Recorder
- 35mm and 3x4 Film Unit
- 8 Palette Software included

No. PO01P **\$2399**



SEAGATE Hard Drives

- 20MB 1/2 Ht No. ST-225
- 30MB 1/2 Ht No. ST-238
- 40MB 1/2 Ht No. ST-251

\$249
\$399
\$439



EVEREX Excel-Stream 60-8

- 60 MB Cassette Back-up
- Backs up 5 MB per minute
- Built-in Formatter

No. EV60E **\$729**



IRWIN 10 MB Tape Drive

- 10 MB Formatted Capacity
- 8 Minute Back-up Time
- Half-height Internal

No. IW110D **\$219**



CMS Drive Plus 21

- 21 MB Expansion Card
- 3 1/2" Rigid Disks
- 5 MB/sec Transfer Rate

No. CH20DP **\$319**



HAYES Smartmodem 1200

- 300/1200 Baud External
- Automatic Speed Selection
- Voice/Data Transmissions

No. HY1200 **\$279**



HAYES Smartmodem 2400

- 300/1200/2400 Baud External
- Non-Volatile Memory
- Stored Number Dial

No. HY2400 **\$429**



NOVATION Parrott 1200

- Compact 300/1200 BPS
- "AT" (Hayes) Command Compatible
- No Batteries or AC Required

No. NV700 **\$99⁹⁹**



U.S. ROBOTICS Direct 2400 PC

- 300/1200/2400 Baud Internal
- Carrier detect override
- Audio phone line monitor

No. UR2400 **\$179**



ZUCKERBOARD The Nude Modem

- 1200 Baud Half Card
- Fully Hayes Compatible
- PC Talk III Software

No. HX12 **\$79⁹⁹**



ANCHOR 1200E

- 300/1200 BPS, AA/AD
- 100% Hayes Compatible
- 5 Year Limited Warranty

No. ANA1200E **\$129**



EVEREX Evercom 920

- 300/1200 Baud Half-Size
- Bell 103/212A Compatible
- Auto Answer/Auto Dial

No. EV920 **\$89⁹⁹**



EVEREX Evercom 945

- 300/1200/2400 Baud External
- "AT" (Hayes) Command Compatible
- Status Indicator LED's

No. EV924E **\$239**



LOTUS 1-2-3
No. ICLO01 **\$299**



d-Base III+
No. ICAH03 **\$399**



Word Perfect 4.2
No. ICSS01 **\$209**



Symphony
No. ICLO02 **\$439**



Copy II PC Option Board
No. ICCP02 **\$84.99**

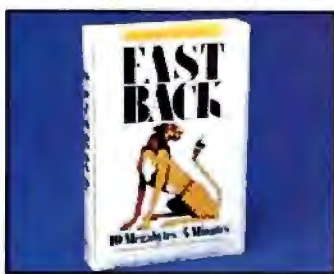

Fast Back Plus
No. ICFI04 **\$89.99**



Microsoft Mouse w/ Paintbrush
No. ICMR02 **\$119**

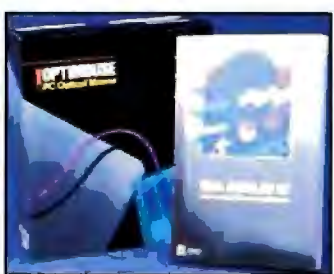

IMSI Optimouse w/ Dr. Halo
No. ICIM04 **\$89.99**



Micropro Professional 4.0
w/GL, No. ICMP03 **\$239**



Multimate Advantage II
No. ICMM02 **\$299**

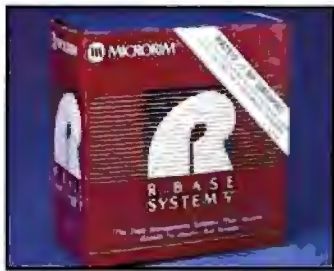

R:Base System V
No. ICMH04 **\$449**



Logitech Mouse
No. ICLG03 **\$79.99**

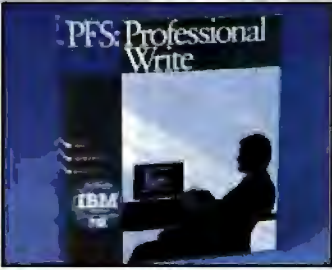

PFS: Professional Write
No. ICPP11 **\$129**



Crosstalk XVI
No. ICMF01 **\$89.99**



Xerox Ventura
No. ICXE01 **\$499**

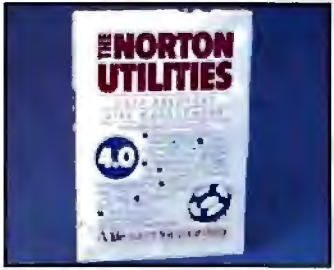

Norton Utilities
No. ICNO01 **\$54.99**



SONY 3 1/2" & 5 1/4" Diskettes
• 3 1/2" DS/DD 10 Pk No. SCMPD2 **\$16.99**
• 5 1/4" DS/DD 10 Pk No. SCMD2 **\$7.99**

CMO POLICIES

- Next Day Shipping on all in-stock items.
- No Surcharge on Visa or Mastercard orders.
- Credit Cards are NOT Charged until order is shipped.
- Add 3% (minimum \$7.00) shipping/handling on all orders.
- All items subject to availability and price change.
- Returned items may be subject to a restocking fee.
- PA residents add 6% Sales Tax.



MAXELL Double & Hi Density
• 5 1/4" DS/DD 10 Pk No. MXD2 **\$8.99**
• 5 1/4" Hi Dens. 10 Pk No. MXD2HD **\$18.99**



Trilogy: A New Approach to Logic Programming

Alex Lane

An alternative to Prolog, with windows and other interesting twists

Trilogy version 1.15 (\$99.95) from Complete Logic Systems (CLS) is a new logic programming language that combines the best features of logic, procedural, and database programming. Trilogy is an example of the current trend in logic programming languages, which centers on the introduction of types (domains), constraints, I/O annotations, arrays, and reassigned variables. (For a discussion of this trend, see the Prolog-related articles in the August 1987 BYTE.)

As a logic programming language, Trilogy most resembles Prolog. Both languages are based in mathematical logic, support lists, and are capable of manipulating symbolic variables. Running programs in either language consists of asking questions (called executing a query). The programming language can use backtracking to find alternative ways to satisfy a query. Trilogy improves upon the blind backtracking approach of Prolog, however, by incorporating constraint logic.

Program source code reads a lot more like Pascal than Prolog; Trilogy supports arrays, enumerated types, and subrange declarations, and provides `if...then...else` and case control structures. You can express and compile procedures straightforwardly into nonbacktracking modules. While Trilogy provides no explicit control structures for iteration or looping, it conserves stack and heap space by performing tail recursion optimization (a technique for saving space and time in recursive programs) on nonbacktracking modules (procedures and subroutines).

Finally, Trilogy provides a set of relational database operations for creating, updating, and querying database files. Database files may have variable record sizes, and you can place these records anywhere within a file or insert them in order. You can store anything (e.g., a list, a tree, or an array) as a field. You can insert, delete, and update records anywhere in a file. The database predi-

cates work with both Trilogy database files and ASCII DOS files.

The package requires an IBM PC, XT, AT or compatible with 512K bytes of RAM running DOS 2.0 or higher. You can run Trilogy from dual floppy disk drives, but a hard disk drive is highly recommended. I used a 4.77-MHz IBM PC XT with 640K bytes of RAM, a hard disk drive, and an 8087 coprocessor. The operating system I used was PC-DOS 3.1.

The Trilogy package consists of a spiral-bound user's manual and two 5¼-inch floppy disks that contain an installation program, the Trilogy compiler, source and object files for system modules, a number of sample programs, and a supplemental documentation file.

Language Features

Trilogy is a fairly compact language, having only 22 reserved words and 12 reserved names. The standard system modules `math.l`, `files.l`, `strings.l`, and `windows.l` add support for, respectively, mathematical functions, file-access functions, functions for manipulating strings, dates and times, and windowing functions. Unlike Pascal or C, Trilogy is case-sensitive. In a reversal of the Prolog naming convention, Trilogy variables and symbols start with lowercase letters, while the names of procedures start with uppercase letters.

Trilogy is a strongly typed language. Its four fundamental types are long (32-bit) and short (16-bit) integers; real numbers; and strings denoted by L, I, R, and S, respectively. Typed variables buy you faster execution and source code that's easier to read. However, the greatest benefit of using typed variables lies with Trilogy's ability to use *decision procedures* that modify *constraints* associated with

the variables. Constraints are pieces of information that Trilogy places in the environment as it computes a solution.

The programming language associates different constraints with different data types. For example, the constraint conditions put on a short integer variable `x` are

```
x op n
x op var + n
```

where `op` is a relational operator (i.e., =, <, and >), `n` is a short integer, and `var` is a short integer variable. Whenever Trilogy encounters an expression with short integers and a relational operator, it attempts to transform the expression into one of the short integer constraints by using algebraic rules. If Trilogy cannot get the expression into one of these forms, it will backtrack in an attempt to calculate a value for one of the variables, and if this fails, it will flag the error with a message such as too many backtracks.

Consider the query `all x::I & y::I & x>0 & y>0 & x = 3*y + 9`. Translated, this says: "Find all values of `x` and `y` when both are short integers, both are greater than zero, and `x = 3*y + 9`." This query will fail because the system cannot transform the expression `x = 3*y + 9` into one of the constraint forms for short integers; nor can Trilogy find a finite number of values for either `x` or `y`. If, however, we add the condition that `y = 2`, then the query has a solution.

Constraints for long integers are more complex than those for short integers;

```
t1*xv1 + t2*xv2 + ... + tn*xvn op m
```

continued

Alex Lane is a knowledge engineer for Technology Applications Inc. and moderator of the prolog conference on BIX. He can be reached at 6621 Southpoint Dr. N, Suite 310, Jacksonville, FL 32216, or on BIX as 'a.lane.'

Trilogy 1.15**Type**

Programming language

Company

Complete Logic Systems Inc
741 Bluendge Ave.
North Vancouver, BC
Canada V7R 2J5
(604) 986-3234

Format

Two 5¼-inch floppy disks

Language

C and assembly

Hardware Required

IBM PC, XT, AT, or compatible with
512K bytes of memory and a hard disk
drive (recommended)

Software required

DOS 2.0 or higher

Documentation

229-page user's manual

Price

\$99.95

Inquiry 899.

where t_1, t_2, \dots, t_n and m are long integer values and v_1, v_2, \dots, v_n are long integer variables. If, in the previous example, you declare x and y to be long integers, you don't have to put a value on y for the query to succeed because the expression $x = 3*y + 9$ fits the constraint decision procedures for long integers.

You can use Trilogy's pairing operator on the four basic types (I, L, R, and S) to construct other data structures. A pair consists simply of any two terms separated by a comma, optionally set off with parentheses for clarity. You can create a list data structure by pairing the basic types with the symbol `NIL`.

Trilogy also lets you declare your own types, including enumerated types and unions (similar to Pascal case-variant types). The user's manual uses the convention of appending `t` to all user-defined types. Type declarations can be Pascal-like subranges, like `Digit_t = [0..9]`, or tuples like

```
Date_t = (year:I, month:[1..12],
          day:[1..31])
```

where you can select the individual fields year, month, and day by, for example,

declaring a variable anniversary to be of type `Date_t` and using the terms `anniversary.year`, `anniversary.month`, and `anniversary.day`.

Advocates of typeless programming need not feel left out of Trilogy. Every data type in what is called the Trilogy universe belongs to a universal data type (denoted by `U`). Using the `U` data type in predicates (denoted as `pred`) lets you write predicates that take terms of any type as parameters. Having a universal type also makes possible conversions from one data type to another via coercion (which is an automatically occurring mechanism) and casts (which the programmer specifies).

Predicate Classes

Trilogy provides three classes of predicates: true predicates, procedures, and subroutines. Like predicates in Prolog, a true predicate in Trilogy expresses a quality, property, or relationship possessed by a term or a group of terms. In Trilogy, only true predicates exhibit backtracking (i.e., nondeterministic) behavior. The system doesn't perform tail recursion optimization for `pred` because of the uncertainty involved in satisfying constraints. Unlike Prolog, there are no extralogical operations (i.e., predicates that lie outside the logic programming model). Some examples of extralogical predicates are predicates for user I/O, for interaction with the operating system, and for program manipulation such as the cut, assert, and retract predicates.

While backtracking is a powerful resource in logic programming, it becomes a handicap when executing once-through procedural code. To permit efficient procedural programming, Trilogy provides the procedure (`proc`) predicate. Because there can be no possibility of backtracking inside a procedure, the manual specifies several rules for coding a procedure. For example, you can't use a logical or, symbolic parameters, or symbolic local variables in the procedure body, and the procedure cannot call any true predicates without using the `all` construct.

Like true predicates in Trilogy, `proc` predicates can fail. Prolog veterans will recognize this behavior as that of "deterministic predicates." You can view a procedure, whose last parameter is an output mode parameter, as a function, and you can (using functional notation) use it as a term in an expression.

The third and most important class of Trilogy predicate is the subroutine (`subr`). Subroutines are special procedures that access data external to the Trilogy environment (e.g., system time and user input). It is this access that distinguishes `subr` predicates from `proc` predi-

cates in Trilogy. Were it not for this distinction, Trilogy would fail to maintain its logical integrity. Since the behavior of subroutines is unpredictable, you cannot call them from either `proc` or `pred` predicates, but only from other `subr` predicates or directly from a query.

Variable Modes

Unlike traditional Pascal-like programming languages, where only a variable's type is declared up front, variables in Trilogy are declared in terms of both type and mode. The mode tells the Trilogy compiler what, if anything, is known about a variable's value upon entry to a predicate. Trilogy has four variable modes: symbolic, input, output, and I/O.

Symbolic mode (denoted by `::` in the variable declaration) is used exclusively in predicates, where little or nothing is known about the value of a variable passed as a parameter to a nondeterministic predicate. You use input and output modes in `proc` and `subr` predicates to denote whether to expect a value upon entry to or exit from such predicates.

For example, the expression `x:<L` declares x to be a long integer whose value the system will know upon entry to a predicate. Analogously, the expression `x:>L` says that you will know x upon successful exit from a predicate.

The major difference between symbolic-, input-, output-, and I/O-mode variables is that you cannot reassign the first three types. You can, on the other hand, reassign I/O variables, which conserves memory use.

Trilogy's Windows

Trilogy provides a window-oriented interface that lets you edit, compile, and run programs and build, query, and update databases. Available functions are listed at the top of the screen: Options, Query, Modules, Files, Library, and DOS. Context-sensitive help is available for both general information and errors encountered when running programs.

From the Options menu you can choose your screen colors and activate or deactivate the error-bell tone. You can also enable or disable the generation of `.MOD` files when compiling queries and determine whether these `.MOD` files will generate code that makes direct calls to the 8087 or only emulate it. In addition, you can choose to back up or restore libraries, or call the editor to edit a non-Trilogy file.

As with Prolog, a prior familiarity with the code you're going to run is necessary. You run programs by entering a query using the name of a predicate statement like `ZebraAnsw(a, b)` into a one-line query window near the top of the

screen and pressing the F2 key to compile the query. If the compiler detects an error, the machine beeps and places the cursor at the spot where the compiler detected the error. Here, pressing F1 accesses a context-sensitive help window that attempts to explain the problem.

In general, I found Trilogy's help screens to be an invaluable aid in learning the language. Sometimes, however, the displayed message made no apparent sense. For example, when I executed the mistaken query

```
all Append ((1,1,N11):<I,(2,3,
N11),a)
```

the system gave me an error message that a right parenthesis was missing.

Trilogy comes complete with a librarian that keeps track of what modules rely upon which others. You can add, modify, or delete modules from the library.

The editor included with Trilogy is modeled after the IBM PE editor. To use the editor, I had to learn an entirely new set of editing commands. I would like to see the next release offer the option of using your own programming editor with Trilogy.

By selecting the DOS function from the top of the screen, you exit from the Trilogy environment. This version of Trilogy does not provide a means of getting a directory from inside Trilogy.

Documentation

Because Trilogy is a new language, the quality of the documentation is very important. The 229-page manual is divided into three sections: a tutorial, a system manual, and a programmer's manual. The tutorial provides a step-by-step introduction to the Trilogy programming language. It assumes you have some experience with programming languages like BASIC or Pascal, but you don't need to have background in logic or database programming.

The system manual describes the Trilogy system and environment, including use of the windows, function keys, and editor. The bulk of this part explains how to edit, compile, and query.

The programmer's manual resembles a collection of appendixes that cover the formal language definition. Short supplemental chapters are devoted to topics such as mode coercion, type conversion, and constraints.

All the examples presented in the manual are included in two source code files. I like this touch, since it saves much time getting acquainted with the language. Of the other sample programs included with the package, including a pattern matcher for ASCII files and several examples in a

Table 1: Trilogy and Turbo Prolog are fairly evenly matched in their ability to manipulate lists, perform recursion, and read and write files, except for Trilogy's problem with running out of stack or heap. The Zebra Puzzle shows how use of constraints gives Trilogy a decided advantage in solving logic problems. The 8087 emulation in the Floating Point test is essentially the same for both products; however, Turbo Prolog outperforms Trilogy in the 8087 emulation of the Transcendental tests. Trilogy provides 8087 support, whereas Turbo Prolog does not. All times are in seconds.

	Trilogy 1.15	Turbo Prolog 1.1
Floating Point	32.19 (3 68) ¹	30 83
Sieve	0 11	2 89
Disk Write (64K)	16.98	29 73
Disk Read (64K)	— ²	15 85
Transcendental		
Sqrt	142 (0 7) ¹	5 19
Logs	87 (1 0) ¹	13 58
Exp	166 (1 3) ¹	24 24
Atan	388 (1 5) ¹	15 46
Sin	156 (2 0) ¹	16 18
Factorial	2 25	21 86
List Reversal	11 92	11 27
Tower of Hanoi		
5 rings	2.2	2 69
7 rings	14.2	10 87
10 rings	— ³	87 71
Zebra Puzzle	2 19	9 45

¹ Time using the 8087 coprocessor chip

² Time for reading a 32K-byte file was 9 2 seconds

³ Insufficient stack/heap

Note: Tests were conducted on an IBM PC XT with 640K bytes of memory, an 8087 coprocessor, and a 20-megabyte hard disk drive.

demonstration program, the file that interested me most was the so-called "zebra puzzle." This classic logic problem involves five men of different nationalities that own different pets, drink different drinks, smoke different brands of cigarettes, and live in different-colored houses. The goal is to find out "who owns the zebra." I used this program as one of the benchmark tests.

A supplemental READ.ME file on the distribution disk gives a terse description of the assembly and C language interfaces. The file LINKMOD.EXE is a utility that links .OBJ files generated by assemblers and C compilers into .MOD object files that Trilogy can use. The LINKMOD utility does not work as described. Instead of the command line LINKMOD MODNAME OBJFILE, I found I had to type LINKMOD MODNAME and then wait for the prompt to enter the object filename.

The supplemental file also covers other topics, such as a discussion of tail recursion optimization, heap management, and some partially implemented Trilogy features.

Benchmarks

Because Trilogy and Prolog appear to be "competitors" in the logic programming

arena, I compared Trilogy to Turbo Prolog version 1.1 (see table 1). Of interest is the ability to manipulate lists, perform recursion and garbage collection (reclamation of memory that has been allocated to now-abandoned structures), and solve logic problems. Here, Turbo Prolog and Trilogy run approximately even, except for the solution of logic problems, where Trilogy has a decided advantage that is attributable to injection types and relation variables.

Although neither package performs garbage collection, Turbo Prolog appears to perform better because it considers free memory to be one large heap. Trilogy, on the other hand, has a disadvantage in that modules must confine their activities to a 64K-byte segment. This problem affected performance in the Tower of Hanoi and Disk Read benchmarks.

Trilogy ran the Sieve benchmark test, which finds all primes between 1 and 100, about 20 times faster than Turbo Prolog. The Floating Point test repeats a series of four basic operations 5000 times, and for this test, Trilogy and Turbo Prolog are about the same with 8087 emulation. The transcendental tests calculate the function in question 1000

continued

This Software Won't Run.



Without This.



And that's the way Sea-Land wants it. And a host of other big and not-so-big software developers who use our Software Sentinel. To make sure their successful software is protected. So it stays successful.

We've become used to being seen with top-notch software. A lot of the reason is how our engineers designed the Software Sentinel family. For the developer and the user. To make it the most technologically foolproof yet easiest to use software protection key you or Sea-Land can get.

For users of SEA-TRAC and the thousands of other programs we're protecting, it's a cinch to get up and running. They simply plug the Software Sentinel into the PC's parallel printer port. That's it. How much easier can it get? Users can even make unlimited backup copies. And run them wherever and whenever they need to—as long as they have the Software Sentinel key.

As long as we're talking success, there's something else you should know. Right now, our engineers are putting the finishing touches on a new microprocessor that we'll use in a whole new generation of software and data protection products. With the same high-performance and high-reliability of our past successes but with many new features. Which no doubt is going to make life even easier for you and Sea-Land.

The Software Sentinel. Making sure software developers stay successful with the successful software they've developed.

For more information on the Software Sentinel family, contact Rainbow Technologies, 18011-A Mitchell South, Irvine, California 92714; or call (714) 261-0228.

Software Sentinel Features:

- Runs under DOS and Xenix
 - Uses algorithm technique, never a fixed response
 - Minimal implementation
 - Higher level language interfaces included
 - Transparent operation
-



RAINBOW TECHNOLOGIES

18011-A Mitchell South, Irvine, CA 92714 • (714) 261-0228 • TELEX: 386078 • FAX: (714) 261-0260

©1987 Rainbow Technologies, Inc. Software Sentinel is a trademark of Rainbow Technologies, Inc.
SEA-TRAC is a trademark of Sea-Land Corporation.

times, while the factorial benchmark determines how fast 10 factorial (10!) can be calculated 1000 times. Benchmarks that exercise a logic programming language's capabilities for finding prime numbers and calculating transcendental functions are of limited interest. It is clear from the results for Trilogy that you can obtain dramatic improvements by installing an 8087.

As far as disk I/O is concerned, although Trilogy could write a 64K-byte data file, I got an insufficient stack error message when trying to read this file. Because the stack and heap share the same 64K-byte segment, recursively reading a 64K-byte file blew the segment. I modified the test program to write and read a 32K-byte file, and this worked fine. (While writing the initial version of the Disk Read test, I neglected to put in a check for end-of-file. Instead of giving a run-time error and halting execution, the machine froze and required a cold boot.)

The stack/heap problem reared its ugly head again when I was writing the program for reversing a 50-element list. The system blew the segment again after 11 iterations, regardless of how much free memory was available prior to loading the Trilogy compiler. However, I was able to write a predicate that would assemble a 50-element list and perform the reversal 10 times. In turn, I wrote the query to run this predicate to backtrack three times, so that 30 reversals were performed overall. Despite the additional overhead of having to assemble a 50-element list from a 10-element "building-block" three times (Trilogy balks if a 50-element list is presented in one chunk), Trilogy is nearly as fast as Turbo Prolog.

The Tower of Hanoi is a classic example of recursive programming. At the five-ring level, both Trilogy and Turbo Prolog are about neck and neck. However, at the seven-ring level, Trilogy begins to lag seriously. One explanation is that Trilogy spends much time churning out text to the screen. This is borne out by removing the `Print()` statement from the code—the performance increase is dramatic. I ran across the stack/heap problem trying to run the Tower of Hanoi benchmark with 10 disks.

Recalling the Zebra Puzzle from the previous discussion, it turns out there are nearly 25 billion ways of combining nationality, pet, drink, smoke, and house. A generic Prolog program will, if necessary, test all combinations of them to find an answer. Inherent in Prolog's backtracking mechanism is the "uninstantiation" of previously bound variables whenever it encounters a failure. In effect, Prolog "forgets" anything it learns

continued

The First Word on OS/2

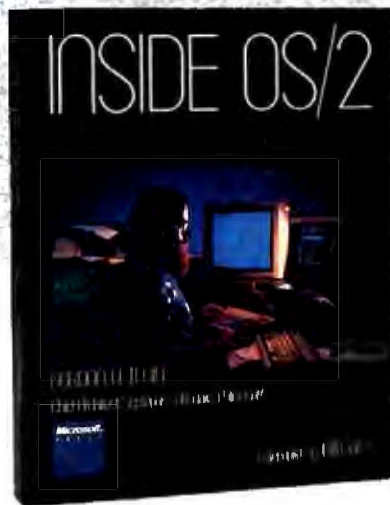

"During the next 10 years, millions of programmers and users will utilize OS/2... The best way for them to understand the overall philosophy of the system will be to read this book." Bill Gates

INSIDE OS/2. Here—from Microsoft's Chief Architect of Systems Software—is a candid and exciting technical examination of OS/2. In unprecedented detail, Gordon Letwin explores the philosophy, key development issues, programming implications, and future of OS/2. And he provides the first in-depth look at each of OS/2's design elements—how they work alone and their roles in the system. INSIDE OS/2 is a valuable programmer-to-programmer discussion of the graphical user interface, multitasking, protection, encapsulation, inter-process communication, and more. You can't get a more inside view. \$19.95.

Microsoft Press

Quality Computer Books

Available wherever books and software are sold.

Or call in your credit card order. 800-638-3030 (In MD 824-7300). Refer to ad BM38.

4th DIMENSION™

The most powerful database for a personal computer.



4th DIMENSION™ is a multi-user relational database for Macintosh™ that provides more power than any other database for a personal computer.

Records Up to 16 million
Files 99 at a time
Fields 511 per file
Links Unlimited
Subfiles 511 per file
Subfields 511 per subfile
Layouts Up to 32,000
Passwords 32,000 levels
Variables Up to 32,000

Multi-user
Import/Export Data
Multifinder™
Search/Sort
Quick Reports
Business Graphics
Programming
External Routines
Customization

Fully compatible with AppleShare™ and other HFS file servers
SYLK, DIF, and text with serial port and file communication control
Fully supports background processing under Multifinder™
Multiple conditions, ad hoc queries, wildcard, programmable searches
Instant report generation
8 kinds of graphs (pie, bar, columns, etc. plus custom pictures)
Over 200 built-in commands and operators
Add external routines written in Pascal, C, and other languages
Custom menus, check boxes, radio buttons, and dialog boxes

● To receive a demo version call (800) 538-8157 x 840 outside California, (800) 672-3470 x 840 inside California.

Circle 3 on Reader Service Card

ACIUS 20300 Stevens Creek Blvd, Suite 495 Cupertino, CA 95014 (408) 252-4444

4th DIMENSION is a trademark of ACIUS, Inc. and ACI Macintosh. AppleShare and Multifinder are trademarks of Apple Computer, Inc.

every time it backtracks. Progress toward finding a solution occurs in one quantum leap when all variables happen to satisfy all the declared facts. On the other hand, Trilogy uses relation variables and injection types in conjunction with its built-in constraints to carry forward increments of the final solution. Relation variables express some relation that exists between objects, and injection types never have the same value for different sets of arguments. The result of this approach is that the Trilogy program to solve the Zebra Puzzle backtracks only 17 times before obtaining a solution. [Editor's note: *The Trilogy source code (BMARKS.L) for the benchmarks is available on BIX, on BYTEnet, on disk, and in the Quarterly Listings Supplement. See "Program Listings" in the table of contents. To "find" source code in the Listings areas on BIX and BYTEnet, search by article title, author, or issue date.*]

Worth Taking a Look

As an experienced Prolog programmer, I have found one of the practical problems of writing procedural code in that language is the awkward mind-set that must be adopted to tame the language's tendency to backtrack. Trilogy addresses this by offering programmers the flexibility to write both logic and procedural code.

I am generally impressed with this package, although minor things about it bother me. For example, I wish I could exit to DOS to view a directory or file without having to exit Trilogy completely. (According to the company, a toolkit containing a graphics module and a DOS module along with utilities will be available for \$50.) I would like more detail in the user's manual concerning the nuts and bolts of the language.

In terms of hands-on use, the editor was not the best I've used. Also, having to learn a new set of editing commands was inconvenient. (Of course, those people familiar with the IBM PE editor will not have this problem.) When running a query, it shouldn't be so easy to run out of stack or heap—and it would be nice to have a subroutine that could report on the status of those resources, too.

Trilogy is a unique product. It's the only product I have seen that combines logic programming with procedural and database concepts. The Pascal-like syntax makes it easier for people familiar with Pascal and C to learn Trilogy than Prolog. The stack/heap problem shows that the product perhaps isn't mature, yet new languages often have a few initial kinks. I cannot see Trilogy taking the microcomputer world by storm, but for \$99.95, it's worth taking a look at if you are interested in logic programming. ■

The Ultimate MS-DOS Resource

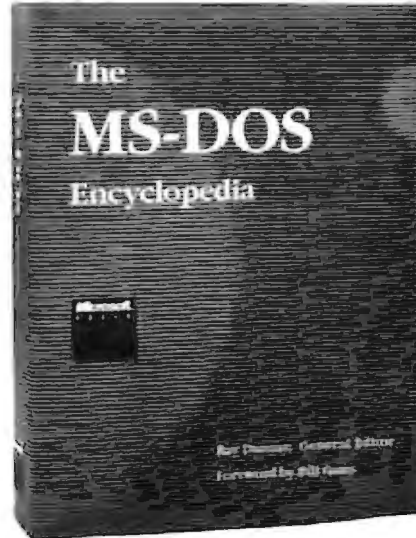

MS-DOS—the starting place for the development of over 20,000 software applications. THE MS-DOS ENCYCLOPEDIA—the starting place for data, advice, and insight that will make your MS-DOS programs reliable, robust, and efficient. THE MS-DOS ENCYCLOPEDIA is a programmer's dream. 1600 pages packed with version-specific data. Annotations of more than 100 system function calls, 90 user commands, and a host of utilities. Hundreds of hands-on examples and thousands of lines of code. Plus articles on debugging, installable device drivers, TSRs, Windows, memory management, the future of MS-DOS, and much more. Researched and written by a team of MS-DOS experts—many involved in the creation and development of MS-DOS. Covers MS-DOS through version 3.2, with a special section on version 3.3. **\$134.95.**

Microsoft Press Quality Computer Books

Available wherever books and software are sold.

Or call in your credit card order, 800-638-3030 (In MD 824-7300). Refer to ad BM38.

POWER

The FlexCache™ 386 series from Advanced Logic Research

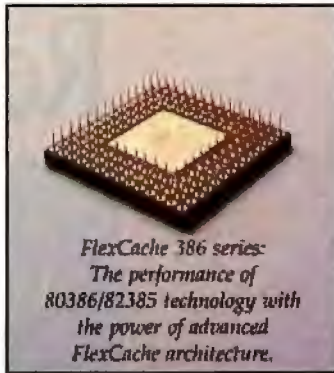

"Spending more money doesn't guarantee that you'll end up with the system you need. Make some serious comparisons of features and prices and then get the most for our money."

Compatible

Novell, DOS 3.X,
SCO Xenix 386, OS/2

Software

The philosophy of getting more for your money has become an unbroken tradition with ALR. A tradition that has been recognized by all the major trade journals with excellent reviews.

ALR 386/220, PC magazine's choice as "The Best of 1987"



Based on the ALR 386/220, PC magazine's choice as "The Best of 1987", ALR extends its product line and introduces the FlexCache 386 series. Now the fastest PCs available, the FlexCache 386 series approach minicomputer proportions and offer two new ways to get the most for your money:

FlexCache 16386 -
a 16MHz, 0-wait-state,
80386/82385 based system.

FlexCache 20386 -
a 20MHz, 0-wait-state,
80386/82385 based system.

Both systems have ALR's advanced FlexCache architecture. The flexible dual bus design provides a wide open, high-speed data channel for up to 60% faster CPU/memory through-put than the IBM PS/2 model 80-071 with the much touted microchannel architecture.

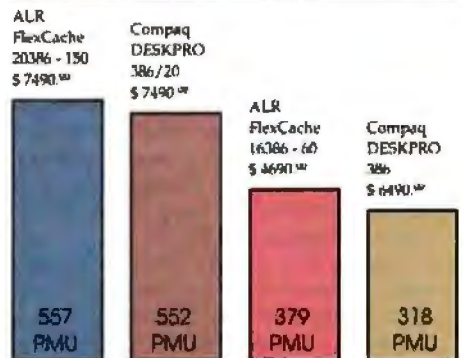

Power Meter Performance Index

FlexCache 386 series edge out Compaq's DESKPRO 386/20 & DESKPRO 386 in CPU/memory aggregate performance test.

The cache memory controller can eliminate wait-states 95% of the time

by keeping frequently used data close at hand, eliminating the need for the CPU to address main memory. This powerful blend of enhancements allows a FlexCache 16MHz CPU to move data along as fast as many 20MHz CPUs and a FlexCache 20MHz CPU to move data even faster than a Compaq DESKPRO 386/20™.

The FlexCache 386 series comes equipped with the most fixed disk capacity for your money. The FlexCache 16386 has a 66 or 100 megabyte fixed disk.

The FlexCache 20386 will give you an extra 45,000 pages of document disk storage for free.

The FlexCache 20386 comes with either a 100, 150, or 300 megabyte fixed disk. The FlexCache 20386 will give you an extra 45,000 pages of document disk storage for free when you compare it to the performance and price of Compaq's DESKPRO 386/20 model 60.

ALR
FlexCache
20386 - 150
\$ 7490.00



Disk Capacities & Transfer Rates

FlexCache 386 fixed disks store more pages of documents and achieve transfer rates of up to twice that of the competition.

FlexCache hard disk controllers transfer a full track of data in one disk revolution (1:1 interleave) instead of several disk revolutions as with (2:1 interleave) most current systems. Full track data transferring plus ESDI (Enhanced Small Device Interface) look-ahead buffering, turns what used to be a data traffic bottleneck into a super high-speed corridor.



So, FlexCache 386 systems achieve transfer rates twice that of Compaq's DESKPRO 386 and 386/20 model 60.

Advanced Logic Research offers the FlexCache 386 series as a powerful solution for today's business growth and performance needs. The FlexCache series offers power and expansion possibilities not easily exhausted. The minicomputer-style chassis of FlexCache 20386 offers space for five internal peripheral devices, allowing more data storage devices than any other PC available. With the money you save on a FlexCache system you can afford additional data storage options.

ALR
FlexCache
20386 - 150
\$ 7490.00



Internal Device Support

With the future in mind, the FlexCache 20386 is built to accommodate growth.

To make some serious feature and cost comparisons give ALR a call at (800) 366-2574 for the name of the dealer nearest you.

FlexCache 386 Series Specifications

- ALR designed and proven multi-layer system board
- Socketed for 80387 support
- 1MB 32 bit RAM, expandable to 2MB on system board
- 0-wait-state cache memory controller with its own 32KB of high-speed (35 ns) static RAM
- Enhanced 101 keyboard
- Phoenix BIOS
- Dual drive support
- OS/2 compatible

FlexCache 16386 Model 60
...\$4690.00

- FlexCache 386 series specifications
- 80386 CPU with 16MHz system clock
- 80387 support with 16MHz clock
- 66Mbyte <30ms hard disk

FlexCache 16386 Model 100
...\$6490.00

- FlexCache 386 series specifications
- 80386 CPU with 16MHz system clock
- 80387 support with 16MHz clock
- 100Mbyte <30ms hard disk

FlexCache 20386 Model 100
...\$4990.00

- FlexCache 386 series specifications
- 80386 CPU with 20MHz system clock
- 80387 support with 20MHz clock
- 100Mbyte <30ms hard disk

FlexCache 20386 Model 150
...\$7490.00

- FlexCache 386 series specifications
- 80386 CPU with 20MHz system clock
- 80387 support with 20MHz clock
- 150Mbyte <20ms, track buffered, ESDI hard disk

FlexCache 20386 Model 300
...\$9990.00

- FlexCache 386 series specifications
- 80386 CPU with 20MHz system clock
- 80387 support with 20MHz clock
- 300Mbyte <20ms, track buffered, ESDI hard disk



10 Chrysler, Irvine, CA 92718
714-581-6770
FAX: 714-581-9240
Telex: 5106014525,
Answer back Advanced Logic

From Asia or Europe call:
ALR/Weames Technology
(65) 2592521 (Singapore)
Telex: R538113 WRNTEC

FlexCache is a trademark of Advanced Logic Research, Inc. Compaq, DESKPRO 386 & 386/20 are trademarks of Compaq Computer Corp.

With a LaserPro on your desk, your software won't sit on the shelf.



Instead, your software will stay on the job. Working better than ever. Because now it's linked to LaserPro™—the laser printer line with a range of emulations unmatched in the industry.

The emulation advantage.

Put your software to work with LaserPro's wide selection of emulations. Our laser printers are compatible with all software programs that support the HP LaserJet Plus™, Diablo® 630, Epson® FX-80™, Qume Sprint® 11, and NEC Spinwriter® printers. Which means that the money you've already invested in software is still well-spent. Even today's newest software packages will leap into action with LaserPro. Printing everything from business presentations to bar codes, graphics to CAD/CAM drawings.

No hidden costs.

With LaserPro the compatibility is built right in. Our entire selection of emulations is standard. No extra cartridges. No optional cards. No extra costs. Just push-button access and hassle-free operation.

And there's more.

Prices for our full line of printers are amazingly low. Each model brings you versatile performance that over-powers the competition, but not your budget. So hang on to your software—and hook up with LaserPro. The full-featured printer line that's truly "top shelf."

For more information, contact Office Automation Systems, Inc. (OASYS), 8352 Clairemont Mesa Blvd., San Diego, CA 92111. (619) 576-9500.

Circle 187 on Reader Service Card (DEALERS: 188)

LaserPro



Excel Extraordinaire

Rich Malloy

In two words, Excel does. Microsoft has moved its popular Macintosh spreadsheet over to the IBM PC AT with all features, such as windows, pull-down menus, dialog boxes, and multiple fonts, still present.

The new version also has features that were not present on the Macintosh version. These include better keyboard, font, and auditing support. Speed is the only remaining question. Is the 80286 architecture overtaxed by the superb graphics, and is the program overly slow as a result? Common sense and conventional wisdom suggest that the program's performance will suffer for its graphical largesse. But a detailed look at benchmark results yields some dramatic surprises.

The new Excel for IBM systems, officially called Excel 2.0 (\$495), follows the original Macintosh version by about 2 years. On either the Macintosh or the AT, Excel is the paragon of bells and whistles. It does so many things, in so many different ways, that it tempts you to spend countless hours merely exploring.

You might quickly conclude that the program is huge. It comes on five 1.2-megabyte 5 1/4-inch floppy disks or seven 720K-byte 3 1/2-inch floppy disks (you can order a set of 360K-byte floppy disks by a special card). By the time you finish loading the program, you gobble up 3.6 megabytes of hard disk space. When the program is executed, it takes up the lion's share of the 640K bytes of memory that it nominally requires, yet even that is not enough. The program must frequently swap overlays into and out of memory from the hard disk. The frequency of the overlays increases as the size of your spreadsheet increases.

Although the package is popularly called Excel for the PC, Microsoft specifically states that the software requires an IBM PC AT or compatible. Several non-AT compatible machines, such as the AT&T PC 6300, are supported, however. The program can use a CGA graphics card, but an EGA, VGA, or Hercules

Microsoft's Macintosh spreadsheet shines on the IBM AT, but is it fast enough?

adapter is highly recommended. In the same way, a mouse is not required but is well worth the additional investment. (Excel supports any mouse compatible with Windows version 2.0.) Since Excel uses up such a large amount of memory, an expanded memory card (Expanded Memory Specification version 4.0) is also recommended.

As for software, Excel comes with its own run-time version of Windows 2.0. If you have a full copy of Windows 2.0, however, you can have Excel interact with other Windows applications.

The Mac Interface on an AT

The most dramatic distinction between Excel and a horde of other spreadsheet programs for the IBM PC is its user interface. Thanks to the run-time version of Windows 2.0 that comes packaged with the spreadsheet, Excel functions almost exactly like its cousin on the Macintosh. In some ways (e.g., keyboard and font support), it is actually better than the Macintosh version.

Excel's keyboard support lets you access every one of Excel's multitudinous commands and functions without ever touching a mouse. In most cases, the keyboard is fairly efficient—in some cases more efficient than the mouse.

Each menu or dialog box you choose contains an underlined letter. You can quickly choose an option by pressing that letter, or by pressing the letter in concert with the Alt key. The alternative is to press the Tab or Down Arrow key to cycle through the selections.

One problem with this technique occurs in cases where several choices begin with the same letter. The designers did, however, provide a number of shortcuts for keyboard users, and generally, the

keyboard support is very good for a mouse-based product. You don't really need a mouse, but if you get one, you'll find it is icing on a very rich cake.

Ironically, the one major fault with the interface is not

with the keyboard but with the mouse support. I asked a very experienced Macintosh user to try Excel on the IBM to see his reaction. He faulted the general "feel" of the mouse, saying it was too sensitive. (He was using the most recent Microsoft Mouse.) Excel apparently bypasses the Control program that comes with the mouse and offers only limited control over the mouse sensitivity: normal, high, or very high. The program defaults to the high selection. But even at the normal selection, the mouse seemed too sensitive; it was easy to overshoot a target area. Microsoft claims the problem is the sensitivity of the mouse and that you can adapt to the new mouse in about a week. Maybe so, but I hope they can fix this problem soon.

Excel for the IBM also has better font support than its Macintosh cousin. The Macintosh version allows only one font in a document at a time, with three variations on it: plain, bold, and italic. The IBM version allows four different fonts.

Dyed-in-the-wool Lotus 1-2-3 users could adapt to Excel fairly quickly. One possible problem might be the general command style of Excel. In 1-2-3, you use a verb-object command structure (e.g., Copy A1..B5 to C4). Excel uses an object-verb structure (e.g., A1:B5 Copy to C4). This takes some getting used to.

Macros Do Menus

At Excel's introduction, Microsoft officials said that they were using Excel to

continued

Rich Malloy is a BYTE senior technical editor. He can be contacted at BYTE/McGraw-Hill, 1221 Avenue of the Americas, New York, NY 10020, or on BIX as "rmalloy."

Excel 2.0**Type**

Spreadsheet program with graphics and database support

Company

Microsoft Corp
16011 Northeast 36th Way
P.O. Box 97017
Redmond, WA 98073-9717
(206) 882-8080

Format

Five 1/2-megabyte 5¼-inch floppy disks or seven 720K-byte 3½-inch floppy disks

Language

C

Hardware Required

IBM PC AT or compatible with 640K bytes of RAM, graphics support, and a hard disk drive. Hercules, EGA, or VGA graphics card and mouse are recommended.

Software Required

MS-DOS 2.1 or higher; Windows 2.0 is recommended.

Documentation

775-page *Reference Manual*; 395-page *Functions and Macros Manual*; 38-page *Getting Started* booklet; 82-page *Sampler*

Price

\$495
(\$250 for network user packs)

Inquiry 888.

build prototypes of new applications software. What makes this possible is Excel's extensive support for macros. With the program's exhaustive list of macro commands, you can set up a whole new system of menus and dialog boxes and even control other Windows applications.

Excel boasts many macro commands. However, most of these commands are merely other ways for you to execute Excel menu commands. But even if you only look at true macro commands (i.e., commands that perform a function that could not be performed by any other means) you would still find that Excel has an impressive number of commands.

One of the reasons that Excel has so many macro commands is that it processes macros in a unique way. Most other spreadsheets treat macros as strings of keystrokes. For example, a 1-2-3 macro to copy a cell to the right and move to the next row might have seven keystrokes:

```
/c-[right]-[left]{[down]}
```

where **-** represents the Return key, and **[right]** the right arrow key. Excel, however, converts the keystrokes into a series of commands. The copy operation would require six keystrokes (Alt-E, Alt-C, right, Enter, left, down) but would be represented by six commands:

```
=COPY()  
=SELECT("RC[1]")  
=PASTE()  
=CANCEL.COPY()  
=SELECT("R[1]C[-1]")  
=RETURN()
```

Were it not for the equal signs (which differentiate a macro command from a comment), the macro would look like some odd variation of BASIC.

Excel's approach leads to large macros, but the macros are easy to understand. And in cases where you may just want to play back some keystrokes, there is a SEND.KEYS command.

It would be very difficult to describe the power of Excel's macros in this small space. Like a programming language, it would fill a book. Instead, let me provide a few examples.

The ADD.BAR command lets you replace the main menu bar of the program with your own. If you are so disposed, you can probably replace the menu bar with a 1-2-3-style menu bar.

The ADD.MENU command lets you add pull-down menus to the preexisting menu bars or to your new menu bars. These menus can have commands that are grayed out or checked, just like Excel's menus.

The DIALOG.BOX command lets you construct a dialog box containing scrolling lists, radio buttons (a menu of choices that lets you have only one choice active at one time), and other Macintosh goodies.

The EXEC command can execute Excel itself, or another Windows application. Once open, Excel can communicate in various ways with another application. If the application supports DDE (the Dynamic Data Exchange message-passing protocol), you can use an INITIATE command to open a DDE channel to it. If DDE is not supported, you can use the clipboard or the SEND.KEYS command to send keystrokes to that application.

Two commands, CALL and REGISTER, let you access all functions in Windows' dynamic libraries. Microsoft has very little detailed information on this but hopes to have more information available for developers soon.

Excel has FOR...NEXT and WHILE...NEXT loops, too. You can set up auto-

start and auto-close macros that execute each time you open or close a particular worksheet. You can also have macros execute at a particular time of day, or when you choose a particular command.

As in most programming languages, you can insert comments anywhere and single-step through the execution of the macros. And unlike most programming languages, you can highlight areas of the macro with various fonts and shading. Your code may look as impressive as it performs.

Mac-Style Data-Entry Forms

Excel has a good complement of database features that are similar to those of 1-2-3. Excel also has a good data-entry-form feature. Data-entry forms greatly ease the process of getting information into a database. With Excel you can create not just a database form, but a Macintosh-style database form. That is, you can use radio buttons and scrolling lists just like Excel itself does. These forms are a little difficult to set up, and they run a little slower than Excel's normal dialog boxes, but they are impressive nonetheless.

Excel supports data tables in much the same way as 1-2-3 does, which is to say it does not make the job excessively easy. However, once a data table is set up, Excel lets you set up recalculation for everything but the table, thereby greatly speeding up operation.

Finding Your Mistakes

In any worksheet larger than a single screen, auditing becomes very important. Excel lets you give cells meaningful names that you can use in formulas and lets you attach notes to particular cells. It also lets you highlight all cells that are dependents or precedents of a particular cell.

One of the most interesting features of Excel is its Info window. You can set up this window to sit in the background and report various pieces of information about any cell you select. It will tell you the formatting, the precedent or dependent cells, and any notes that attach to the cell. With the Info window set up, you can easily scroll around a worksheet and check this information.

No Three-Dimensional Graphics

Excel can generate a good selection of graphs. These include the obligatory bar, area, line, and scatter graphs, as well as the old favorite pie chart. One advantage of Excel is its ability to do several variations on each of these common themes. The program also features high-quality text fonts and the ability to paste the graphs into Windows Write, the word

processor that comes with Windows version 2.0. Macintosh users may be happy to know that macros can now access all the graphics commands.

Unfortunately, Excel cannot do three-dimensional graphs. These graphs are increasingly popular and are included in some of the competing new spreadsheet programs, such as Surpass and Quattro.

This review just barely scratches the surface of Excel's features. I should also mention that color is available, if you have an EGA or VGA. The program is not copy-protected, and it includes the ability to print wide worksheets sideways.

Head-to-Head: Excel Versus 1-2-3

After reading about all these features, you might conclude that Excel just has to be slow. But is it? And if so, by how much? To find out, I tested Excel on an AT clone with a 6-MHz clock speed, 640K bytes of RAM, and a 20-megabyte hard disk drive. The system was also equipped with a Hercules-style graphics card, a monochrome monitor, and the new Microsoft Mouse. The only software I ran with Excel was MS-DOS 3.1, the mouse driver, and the mouse control panel. For each test, the program and the benchmark worksheets were "maximized" to their largest sizes.

For comparison, I tested 1-2-3 (version 2.01) on the same machine. I was tempted to use 1-2-3 with Lotus Development's Speedup add-in program, since this program can dramatically speed up 1-2-3. But in these benchmarks, where each cell is dependent, the add-in actually has the effect of slowing the program down by a small amount. Thus, I did not use this feature.

The tests I used were the same as those used in the article "Spreadsheets" in BYTE's *Applications Software Today* (Summer 1987). Three of the tests involved a simple 100- by 25-cell worksheet, where each cell was a multiple of the previous cell. The fourth test was the so-called Savage benchmark, which measures floating-point accuracy and performance by using logarithmic and trigonometric functions.

As you can see by the results in table 1, Lotus's 1-2-3 is still number one in the Simple Recalculate and Insert Row tests. Excel was only 60 percent as fast as 1-2-3 in simple recalculations and was even worse when inserting rows. However, the other two tests yielded surprising results. In the Scroll Right test, where the character-based 1-2-3 should have had a hands-down advantage, Excel was 18 percent faster. In addition, in the Savage test, both programs had approximately the same results and the same error (approximately 10^{-8}).

Excel still has some catching up to do when it comes to simple recalculations. But it is interesting to note that, as you might expect, you can make Excel go faster by decreasing the size of its viewing windows. When I decreased the size of the benchmark window to 2 by 2 cells, the Recalculate speed increased by 48 percent. Also, I was very amused and intrigued when I found that Excel's results on the AT clone matched pretty closely with those measured on the Macintosh last year. For each test, the difference is less than 10 percent.

Documentation Goes Electronic

The most exciting thing about Excel's documentation is a program called the Feature Guide. This is a Windows application that runs in conjunction with Excel and communicates with it by DDE. The Guide functions sometimes as a slide show, showing graphics and displaying various worksheets and charts. In certain practice sessions, it lets you try out a particular feature and advises you when you make a wrong keystroke. This is an impressive program and a necessary introduction to a feature-rich product such as Excel. It also is a good example of what can be done with the DDE channel of Windows.

The rest of the documentation is two fairly conventional three-ring binders; one is a general reference, and the second is on functions and macros. A small booklet shows a short introduction and has instructions on how to get started. A fourth, thin book (with disk) is a "Sampler" of very interesting applications. Included, for example, is a worksheet for a

Table 1: In the head-to-head benchmark comparisons of Excel and Lotus 1-2-3, 1-2-3 still maintains supremacy in the Simple Recalculate and Insert Row tests. But, surprisingly, Excel is 18 percent faster in the Scroll Right test. Both programs are in a dead heat in the Savage test. All times are in seconds.

Test	Excel	1-2-3
Simple Recalc	4.48	2.68
Insert Row	4.06	1.75
Scroll Right	47.38	55.81
Savage	33.02	33.55

new business plan and a set of macros for solving simultaneous equations.

I might suggest that the company add more examples to the *Functions and Macros Manual*. Several of the macro commands are intricate, and examples of each command would be helpful.

A Rare Product

The only things I might fault in Excel are the less-than-stunning recalculation speeds and the mouse support. But in view of the power and flexibility provided by the program, these criticisms seem empty.

This rare product combines extreme ease of use and exceptional power. It is one of the first products to establish a common interface across the AT and the Mac. I heartily recommend it—for both novice and expert—on both machines. ■

Microsoft Works

Nicholas M. Baran

An integrated program for the IBM PC and compatibles, Microsoft Works 1.00 (\$195) offers word-processing, spreadsheet, database, and communications modules. The package also includes a chart facility for creating graphs from spreadsheet data and a separate memory-resident macro-command processor.

Though sufficient for most tasks, Works's modules do not quite measure up to full-featured, stand-alone applications packages. The word processor module includes all the text-handling functions required for basic text processing, but it does not have the sophisticated graphics

or document management capabilities of Microsoft Word. The spreadsheet module is a basic Lotus-compatible spreadsheet without the Lotus macro language, and the database module is a nonprogrammable, single-table file manager or "flat file" system. The communications module is fine for dialing bulletin boards or conferencing systems and downloading and uploading files, but it does not include a programming or command language.

While Works is primarily intended for novice users, it has adequate capabilities

continued

Microsoft Works 1.00**Type**

Integrated software package with word processor, spreadsheet, database manager, telecommunications program, and separate macro-command processor

Company

Microsoft Corp.
16011 Northeast 36th Way
P.O. Box 97017
Redmond, WA 98073-9717
(206) 882-8080

Language

C and assembly

Hardware Required

IBM PC, XT, AT, PS/2, or compatible with 384K bytes of RAM, two 360K-byte floppy disk drives or one 720K-byte floppy disk drive (or a hard disk drive), and a CGA, EGA, VGA, or Hercules graphics adapter card; mouse, modem, and printers are optional

Format

Eight 5¼-inch floppy disks and four 3½-inch floppy disks

Documentation

578-page *Microsoft Works Reference Manual*, separate appendixes covering printers, modems, using a mouse, and MS-Key macro processor, Quick Reference card, keyboard guide

Price

\$195

Inquiry 897.

for experienced users and offers the advantage of complete integration between these four basic software applications at a reasonable price.

The package requires 384K bytes of RAM, MS-DOS 2.0 or higher, two 360K-byte or one 720K-byte floppy disk drive, and a CGA, EGA, VGA, or Hercules graphics adapter card. The program can use a Microsoft Mouse and Hayes-compatible modems.

I tested Works version 1.00 on an IBM PC XT with a Microsoft Mouse and an Orchid TurboEGA card. The program is easy to install and uses the standard setup system found in all Microsoft applications for the IBM PC. Works comes on eight 5¼-inch floppy disks and four 3½-inch floppy disks. It includes a spelling checker and an extensive on-line tutorial. Without the tutorial, Works requires about 1 megabyte of hard disk storage;

with the tutorial, the program requires 1.8 megabytes.

You can configure Works to operate with the mouse or keyboard. With the mouse option installed, you can still use all available keyboard commands and functions. However, the macro processor cannot incorporate mouse actions into recorded macros. Works also supports a wide range of printers and, by default, supports Hayes-compatible modems for communications. You can, however, configure Works for use with other types of modems.

Works uses a pull-down menu interface that is consistent throughout the four modules. You access the menus by pressing the Alt key and then selecting the command or simply pressing Alt followed by the first letter of the command. A description of the command you select appears at the bottom of the screen, and, in most cases, a dialog box appears for making additional selections or entering command parameters. With a mouse, you can point to and click on menu options and dialog boxes, and you can block off text or scroll through files.

I often pressed the Enter key at the wrong time in dialog boxes and discovered through trial and error that the Tab key was required to move to the next command parameter.

Works truly qualifies as an integrated package. You can access any of the four main application modules at any time. It assigns default file extensions to different file types so that it automatically knows which application to load with an existing file. For example, if you save a script file for a communications session, Works automatically assigns it a .WCM file extension. The next time you load the file, Works will automatically invoke the communications module. Similarly, special file extensions are assigned to spreadsheet, word-processing, and database files. You can override the assigned file extensions if you wish. Works also lets you temporarily exit to DOS.

Works lets you open up to eight files at one time. Even though you can work only on one file (i.e., the active file) at a time, you can switch from one file to the next with a single command. You can cut and paste data interchangeably between text documents, spreadsheets, graphs, and database files. The ease with which you can move data from one application to another is one of Works's most impressive features.

For example, to copy data from a spreadsheet into a word-processing file, you define the block of data in the spreadsheet, copy the data into a buffer, open the word-processing document, move the cursor to the desired location for the

spreadsheet data, and press the Enter key. You can do the same between databases and text documents and also between spreadsheets and databases, provided the data formats are consistent.

Word Processor

The Works word processor is the closest of the four modules to what I would expect of a stand-alone word-processing program and is really the best part of Works. I used the BYTE standard tests to get a feel for the performance of the word processor and was impressed with the results. [Editor's note: See "Word Processors" by Phillip Robinson in *BYTE's Applications Software Today, Summer 1987*.] The BYTE 4000-word benchmark file loaded very quickly. A global search and replace of a word that was found 400 times throughout the document took only 5 seconds to complete. Resetting the margin and subsequent document reformatting occurred almost instantaneously. Converting the file to ASCII format took about 20 seconds, and saving it as a Works document took about 8 seconds.

I also worked with a 20-page document converted from WordPerfect. The Works word processor handled all editing functions admirably within the large document. You can convert Works's text documents to straight ASCII format with linefeeds at the end of each line (e.g., suitable for transfer via modem), or into a text format with carriage returns at the end of each line, which other word processors can read. You cannot load Works documents directly into Microsoft Word; you have to save the document as a text file first.

The Works word processor includes automatic pagination and reformatting. I found the reformatting function a bit distracting when I was inserting text into an existing document. From the corner of my eye, I could see the lower text constantly repositioning itself; however, this is a characteristic I could get used to.

The formatting commands for page layout, headers and footers, italics and underlining, and so on, are all easily accessible from the pull-down menu bar on the top line of the screen. You can also switch between windows and work on different open documents.

Works shows page numbers but does not provide line numbers or cursor position and also has no facility for obtaining a word count. The spelling checker includes 80,000 words and is similar to other word processor spelling checkers, such as the one used with WordPerfect.

Perhaps the best feature of the word processor is the ease with which you can merge text from the database module for

continued

Write.

Right.

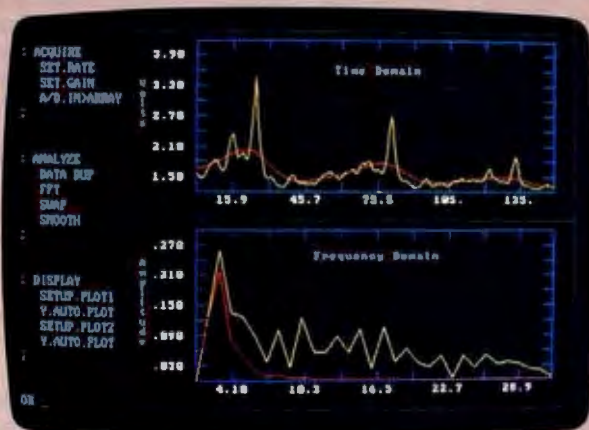

If you've got better things to do than debug pages and pages of code, you need ASYST™. It's the programming environment developed specifically for scientific and engineering applications.

ASYST simplifies data analysis and graphic display, and integrates them with data acquisition. Using ASYST, you can replace pages of low-level code with a few specialized commands. And it's easy to tailor to your changing applications. ASYST's simple configuration menus and our technical support will get you up and running quickly—and keep you there.

Call and discuss your application with one of our technical specialists. Or request more information.

Just make the next line of code you enter **1-800-348-0033**. It'll put you on-line with ASYST, the scientific way to program.

Features:

- Analog-to-Digital, Digital-to-Analog, and Digital I/O Support
- GPIB/IEEE-488 Interface
- RS-232 Interface
- Sophisticated Analysis and Graphics

System requires IBM PC, XT, AT, or 100% compatible.

ASYST
SOFTWARE TECHNOLOGIES, INC.

100 Corporate Woods
Rochester, NY 14623
716-272-0070

System Developers: Ask about our new ASYST Run-time License.

ASYST is a trademark of Asyst Software Technologies, Inc.
IBM, IBM PC, IBM PC/XT and IBM PC/AT are registered trademarks of International Business Machines Corporation.

Circle 24 on Reader Service Card

The Works spreadsheet does the job, but it is the weakest module. It takes almost 1 minute to load a 1000-row by 5-column spreadsheet.

form letters and printing mailing labels. You simply select the Insert Field command from the Edit menu and select and locate the appropriate field names from your database. When you print the document, Works automatically inserts the database data, one record at a time, generating as many documents as there are records in the database. You use the Print Labels command to generate the labels from the database.

The word processor is more than adequate for most straightforward writing tasks. I would not hesitate to use it for most of my writing requirements. The mail-merge facility is actually quite a bit easier to use than comparable mail-merge utilities in some of the high-end word processors, such as Microsoft Word or WordPerfect. The word processor is also the easiest to learn of the four modules. I'll discuss ease of use in greater detail at the end of this article.

Database

The Works database is a simple flat-file system and is adequate for maintaining straightforward databases, such as mailing or contact lists or simple financial and statistical tables. A single Works database table can contain up to 4096 records and 256 fields. You can work with a database in form or list mode. In list mode, records are displayed in rows on the screen. In form mode, one record at a time is displayed on a screen form, which you design when you define the database.

To define a database, you simply set up a form on the screen, similar to the procedure in PFS:File or Symantec's Q&A. However, I did find Works's use of the Enter key confusing. Pressing the Enter key defines the form rather than a single field. I kept losing defined fields by pressing the Enter key at the wrong time. Once I got the hang of it, however, it was simple to define fields and also to customize the form. Works provides functions for moving fields around the data and performing modifications to the data structure. The Works database supports text and numeric formats, as well as date,

time, and logical data types.

In spite of its simplicity, the Works database includes a good query facility and options for embedding formulas in fields. Field formulas can reference other field values in the database. The database uses the same library of functions as the spreadsheet module. The report generator includes options for specifying breakpoints and formatting and selecting specific data values. As mentioned in the section on the word processor, it is very simple to transfer database field values to the word processor for form letters.

As with the word processor, I ran some of BYTE's standard tests and found the performance of the database to be better than I expected for such a low-priced product. While the Works database does not include an indexing or key-field scheme, sorting a 1000-record file took only about 4 seconds. Searching the same file for a value in the last record took about 5 seconds.

My main complaint about the database is that you can't change the field delimiters if you want to save the database in ASCII format. This means that quotes surround all field values when saved in ASCII delimited format. There should be a facility for changing the delimiter to a blank or a space. On the positive side, the Works database provides a range of operations for formatting database fields and forms.

The database is quite easy to learn, though it takes a bit more effort than the word processor.

Spreadsheet

The Works spreadsheet does the job, but it is the weakest of the four modules when it comes to performance. It takes almost 1 minute to load a 1000-row by 5-column spreadsheet, and then the screen hangs temporarily (i.e., keystrokes are not recognized) until Works gets its bearings again. Another quirk is that the spreadsheet status line reports that recalculation is completed about 30 seconds before it really is. It was disconcerting to try to move on to another task and then realize the spreadsheet was still recalculating.

Actual performance of the BYTE standard tests [Editor's note: See "Spreadsheets" by Rich Malloy in *BYTE's Applications Software Today, Summer 1987*] was comparable to other spreadsheet programs. A compounded calculation involving the 1000-row by 5-column matrix and using a formula where each cell multiplies the value of the immediately previous cell by 1.001 produced an insignificant error of 2.14^{-9} over the total calculation. This result is a good indicator of the accuracy of the spreadsheet compiler. The compounded calculation took about

60 seconds, while a recalculation of a 100-by 25-cell spreadsheet took about 12 seconds. Cursor speed is also comparable to other spreadsheets, requiring about 24 seconds to traverse 100 columns.

The spreadsheet includes a standard library of arithmetic, financial, and logical functions and produces files in Lotus .WKS file format. While files are interchangeable with Lotus 1-2-3, the Works spreadsheet does not support Lotus macros or the Lotus database functions (understandably, since Works has its own database).

The spreadsheet's charting function produces the basic graph types (e.g., line, pie, bar, and area). You first select spreadsheet ranges and then assign them to the axes of the chart. The chart facility provides the normal formatting and labeling functions found in most business graph utilities.

The spreadsheet seems fine for modest-size applications, but the false completion signal with the 1000-by 5-cell spreadsheet makes me hesitate to recommend Works for large spreadsheet applications.

Communications

I tested the communications module by logging onto the BYTE Information Exchange (BIX) and uploading and downloading files. The communications module includes a handy script-file recorder for saving sign-on or log-on sequences. It recorded my log-on sequence to BIX, and from then on, I just opened the Works window and called up the BIX communications file; Works then dialed BIX and logged on.

The Works communications program supports both text and XMODEM file-transfer protocols. File transfers and captures worked without a hitch. Documents from Works' word processor saved in plain-text format transferred perfectly.

While the communications package does not include a command language, it is perfectly adequate for most users logging onto bulletin boards or conferencing systems. However, it took trial and error to get the communications system to work properly. At first, I couldn't figure out what should go in the "Modem Type" field of the dialog box. As it turns out, if you have a Hayes-compatible modem, nothing should be entered in that field. I found this out by trying various alternative values for about half an hour. Selecting different modem types is covered in the appendixes to the Microsoft and MS-Key macros reference, a separate manual included in the package.

As with the other functions of Works, once I got the hang of it, the communica-

continued

tions module was easy to use and did the job.

Macro Processor

I worked with the macro processor only briefly. Called MS-Key, the macro processor is a separate module invoked from the DOS prompt. It can run from a disk or as a memory-resident program. You can adjust the amount of RAM used by MS-Key, and you can deactivate it. I had WordPerfect's Repeat Performance keyboard enhancer (version 2.0) already loaded when I first tried MS-Key and hung up the system. So, you may have to experiment a bit if you want to run MS-Key with other memory-resident programs.

MS-Key can record any sequence of keystrokes used in Works. It includes a special macro editor for modifying previously recorded key sequences. As mentioned earlier, it does not recognize operations that the mouse performs.

The MS-Key macro processor is definitely useful for executing repetitive tasks. I tested it by recording a sequence of commands for loading a particular document and performing some search functions. With MS-Key loaded, an additional macro menu appears in the Works menu bar for executing, editing, and recording macros. Since MS-Key is really a separate program, instructions on its use are provided in a separate appendix to the Works user manual.

Ease of Use

Microsoft's sales pitch is that Works is an absolute snap for first-time users to learn and that in no time at all, novice users will be blazing through form letters, invoices, and mailing lists and downloading stock quotes from Dow Jones. I would dispute these ease-of-use claims.

The package does include a good on-line tutorial that lets you work through all the capabilities of Works. You can even start up the tutorial from within an application that you are working on. Works also includes a large on-line help facility with a topic index, explaining the various functions and commands in Works.

In contrast to the impressive on-line tutorial, the *Microsoft Works Reference Manual* is mediocre. I spent almost an hour trying to figure out how to log onto BIX or to find some information on the "Modem Type" field. There is no mention whatsoever of field delimiters in the database section. The index does not include a topic on data types. There is no direct information on how to obtain a directory of files that don't have Works file extensions. I figured out that you use *.* for that purpose. I don't think a novice user would necessarily figure that out.

Many of the technical details not covered in the reference manual are in the appendixes manual.

While this criticism may seem a bit heavy-handed, it is important not to mislead new users into thinking that Works represents a revolutionary breakthrough in ease of use. This is simply not the case. While it is easier to learn than WordPerfect, Word, or Paradox, Works requires considerable effort from the novice in understanding its concepts and capabilities.

Working Opinion

In spite of the criticisms regarding its ease of use, Works is overall an excellent package for the money. The mail-merge facility alone may be worth the money to

many users who don't want to struggle with the control codes and other confusing mail-merge commands found in most word processors. The Works word processor is competitive with many stand-alone word processors, as long as you don't need document summaries or WYSIWYG (what you see is what you get) text formats on the screen. The communications and database modules do the job, and, in spite of its quirks with large spreadsheet files, the spreadsheet does the job, too. I recommend Microsoft Works. ■

Nicholas M. Baran is an associate technical editor for BYTE. He can be reached at 425 Battery St., San Francisco, CA 94111, or on BIX as "nickbaran."

Reflex Plus for the Macintosh

Charles Spezzano

When it comes to relational database managers for the Macintosh, Reflex Plus is the fastest and easiest to use that I have seen. It lets you create relational databases from which you can link files to allow cross-accessing of information. Although it does not let you create custom menus and dialog boxes to shield the end user from the underlying structure of the program and create the illusion of a custom-designed program, it has few other shortcomings. Reflex Plus version 1.0 runs on any Macintosh with at least 512K bytes of RAM and 800K bytes of floppy disk or hard disk storage.

Reflex has evolved in three stages. It began as a program called Interface, which was a good program from the start. Then Borland bought it, renamed it Reflex for the Macintosh, and removed the copy protection while also improving the highly visual interface. The company upgraded Reflex further and called it Reflex Plus: The Database Manager. The changes are far more than nominal.

The entry forms now allow default fields, calculated fields, and display-only fields. The calculated fields automatically perform a variety of calculations during data entry. You can also create multiple entry forms for each database. One entry form might display data one record at a time, while another displays

all records at once in a tabular format. Report design has also been improved with new functions such as GROUPBY, which shows records grouped by common values in fields.

Reflex for the Macintosh could have records with a maximum size of only 1000 characters. That is the default maximum record size in Reflex Plus, but if you need more space for each record in a file, you can select Configuration from the Apple menu and then select a new maximum size of 2000 or 4000 characters. The number of characters you can enter in a single text field is limited only by the 1000-, 2000-, or 4000-character record limit minus the number of characters in other fields in the record. The program's other structural aspects are unchanged: 254 fields per record, as many records in a file as your disk can hold, and up to 15 files open simultaneously.

The new Paste Choice function serves a dual role. It lets you quickly define formulas by pointing and clicking with a mouse; and it can be used to copy a formula or field, with its attributes, from a database into another entry or report form. When defining a formula, you can create an entire path name by selecting a database file, expanding the file to see its fields and links, clicking on a linked file

continued

If you can see the difference,
you must be looking at the price.

*we never
stop
asking*

What if...

Hewlett-Packard Company
18110 S.E. 34th Street
Camas, WA 98607

Dear Reader:

This letter was printed on two of the finest printers available today. One half on a laser printer, the other on the new HP DeskJet Printer. But which one printed which half? Hard to tell, isn't it?

Small and quiet enough for your own desk, our HP DeskJet Printer gives you clean, crisp text and graphics. Just like a laser. You get perfect printing from A to Z. Look for yourself.

AaBbCcDdEeFf GgHhIiJjKkLlMm NnOoPpQq RrSsTtUuVvWwXxYyZz

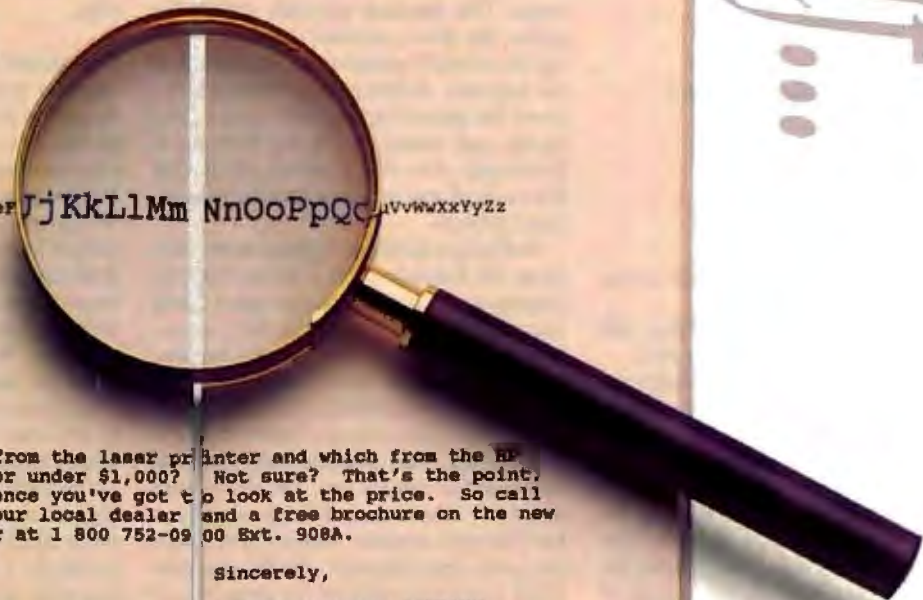

So which half is from the laser printer and which from the HP DeskJet Printer for under \$1,000? Not sure? That's the point. To see the difference you've got to look at the price. So call for the name of your local dealer and a free brochure on the new HP DeskJet Printer at 1 800 752-0900 Ext. 908A.

Sincerely,

HEWLETT-PACKARD COMPANY

Greg Wallace
Greg Wallace

Laser Printer

HP DeskJet Printer

The New HP DeskJet Printer. Laser-Quality Output for Under \$1000.



Reflex Plus: The Database Manager 1.0**Type**

Relational database manager

Company

Borland International
4585 Scotts Valley Dr
Scotts Valley, CA 95066-9987
(408) 438-8400

Format

Three 3½-inch floppy disks

Language

Assembly

Hardware Required

Any Macintosh with at least 512K bytes of RAM and 800K bytes of floppy disk or hard disk storage

Documentation

576-page *Reflex Plus User's Guide*
180-page *Learning Reflex Plus*

Price

\$279; upgrade for Reflex owners, \$95

Inquiry 896.

and expanding it to see its fields and links, and clicking on a field in a file.

Other changes in the program take care of annoying features in the previous version. In Reflex, for example, if you selected Show Header but did not put anything in the header, space was still reserved for that header. To remove the blank header, it was necessary to select the header and choose Clear from the edit menu. In Reflex Plus, by contrast, if you don't create a header, the command displayed is New Header. If you don't place anything in the header, it does not officially exist, and the command remains New Header. Only after you actually place something in the header does the command become Show Header. The two-step process is identical for footers.

You pay a lot for those improvements. Reflex used to be the greatest bargain in the Macintosh database market, retailing for \$99.95. The suggested retail price for Reflex Plus is \$279. Reflex owners can upgrade for \$95. In comparison with the competition—most of which sell for just under \$500—Reflex Plus is still a good buy, if not a great bargain.

Easy and Flexible

Reflex Plus is the easiest to use of the top five fully relational Macintosh databases

(including Omnis 3 Plus, dBASE Mac, 4th Dimension, and Double Helix II). Many users could probably muddle their way through setting up a simple name and address database without reading the new improved reference manual or the tutorial learning guide. That's because much of the program is self-evident, and its overall design fits well into the Macintosh environment.

Typing and use of a command language is minimal. For example, when you want to use one of the 55 built-in functions that give Reflex Plus many of the capabilities of a spreadsheet, you click on the field to write the formula that will incorporate the function. Then you click in the formula panel in the place that you want to paste the function name. When you choose Paste Function Name, a dialog box appears, listing the available functions. You then click on the function name you would like to paste into the formula. The program not only pastes the name, but also a generic template showing the correct syntax of the arguments of the function. At this point, you have to replace the generic syntax with actual field names and values before the formula is functional, but that's about all Reflex Plus asks of you in this ordinarily complicated process.

Building a database is just as easy. You name the database, and a screen appears displaying the database name and a blank space under it for the first field name. You type the field name, press Return, and then type the next field name. In a simple name and address database, nothing else would be required before data entry. Reflex Plus automatically sets all new fields to contain text. But if you want to specify other types of fields, six others are available: number, integer, date, logical, time, and sequence. Reflex automatically checks for data of the correct type for each field, and you can further define more specialized data checks for each field.

A number field provides up to 15 decimal places of precision and accepts exponential notation in the range of E308 to -E324. An integer field can contain whole numbers from -2,147,483,647 through 2,147,84,647. If you specify a field as a sequence field, Reflex Plus automatically assigns consecutive numbers to the records you enter in a database. A file can contain only one sequence field.

Every database file must include at least one key field or you cannot save the design. There can, however, be multiple key fields in a record. Taken together, the key fields of a record constitute the *key* of that record. This is an important concept in Reflex Plus, since there are no in-

dexes. The key for each record is unique, and Reflex Plus automatically sorts records by the key fields and displays the records in that sorted order. That can be a problem if you want to go back and check the last record entered in a database, but it makes searches very fast. It is also a very flexible system. You can change a nonkey field to a key field, even after entering records into a database, simply by moving the field above or between other key fields in the list. The change happens instantly, but when you next save the database and quit Reflex Plus, the program must then write the change to disk.

Equally flexible is Reflex Plus's tolerance for changes in the structure of a database that has records in it. You can add a new field, delete or rename an existing one or change its type, reorder the fields on an entry/display form, and change links between files—all with automatic restructuring of data by Reflex Plus.

Relational Linking

Another feature that makes Reflex Plus special is its method of creating links between files. This is the essential test of a program that claims to be relational, and Reflex Plus passes it with flying colors. When you decide to link two files, you simply add link fields to the images of the database files that you want to connect, draw a line between the link fields, and specify a type for each link.

Reflex Plus lets you set two different types of links: a single link, where a record in one file links to only one record in the other file; or a collection of links, where a record in one file links to multiple records in another file. For example, if you connect a customer file with an invoice file, the link from the customer file would be a collection of links to invoice records, because one customer record might be associated with more than one invoice record. By contrast, any single invoice record will be associated with only one customer record, so the link from the invoice file would be a single link to one customer record. Once you link files, changes made in one file are automatically reflected in the others.

In addition, when you look at a record in one file, such as the customer file used in the previous example, and you want to find information in another linked file, such as an invoice file, simply select Show Linked Record from the utility menu. This displays the record (or records) in the other database file that link to the current record in the current file.

Once data is in your files, Reflex Plus provides powerful search and sort capa-

continued

Every presenter wants to make a compelling, persuasive case. And color, you'll agree, makes all the difference. It's more eye-catching. More readily understood. More



memorable. In short, color makes any desktop presentation more effective. And research proves it.

All you need is a Hewlett-Packard ColorPro Plotter like we used here, or the HP PaintJet Color Graphics Printer. Together with a PC-IBM compatible or Apple Macintosh—you can use all the popular graphics software like Lotus Freelance Plus, Cricket Presents, HP's Graphics Gallery (used below), Microsoft Chart and Harvard Graphics.

At under \$1,300, the HP ColorPro Plotter may be just where you want to start. It will turn your ideas into colorful, easy-to-grasp visuals. Or, if you need to combine near-letter quality text with color graphics, you can rely on the HP PaintJet Color Graphics Printer for under \$1,400. Whichever you choose, you'll create desktop presentations with startling color and greater impact.

For a colorful sample overhead and the name of your nearest dealer, call 1 800 752-0900, Ext. 903A.

Freelance Plus® and Lotus® are U.S. registered trademarks of Lotus Development Corporation. Microsoft® is a U.S. registered trademark of Microsoft Corporation.
© Hewlett-Packard 1988



Circle 117 on Reader Service Card

What if...

Guess which presentation made the sale.

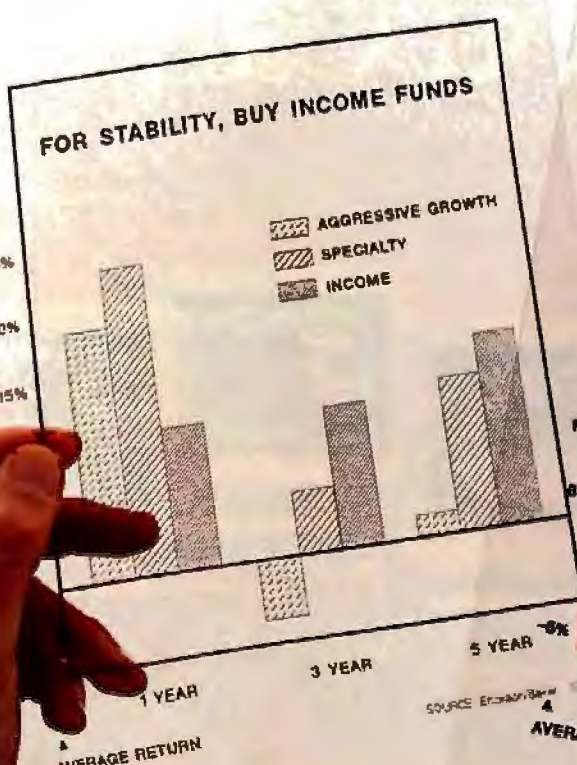
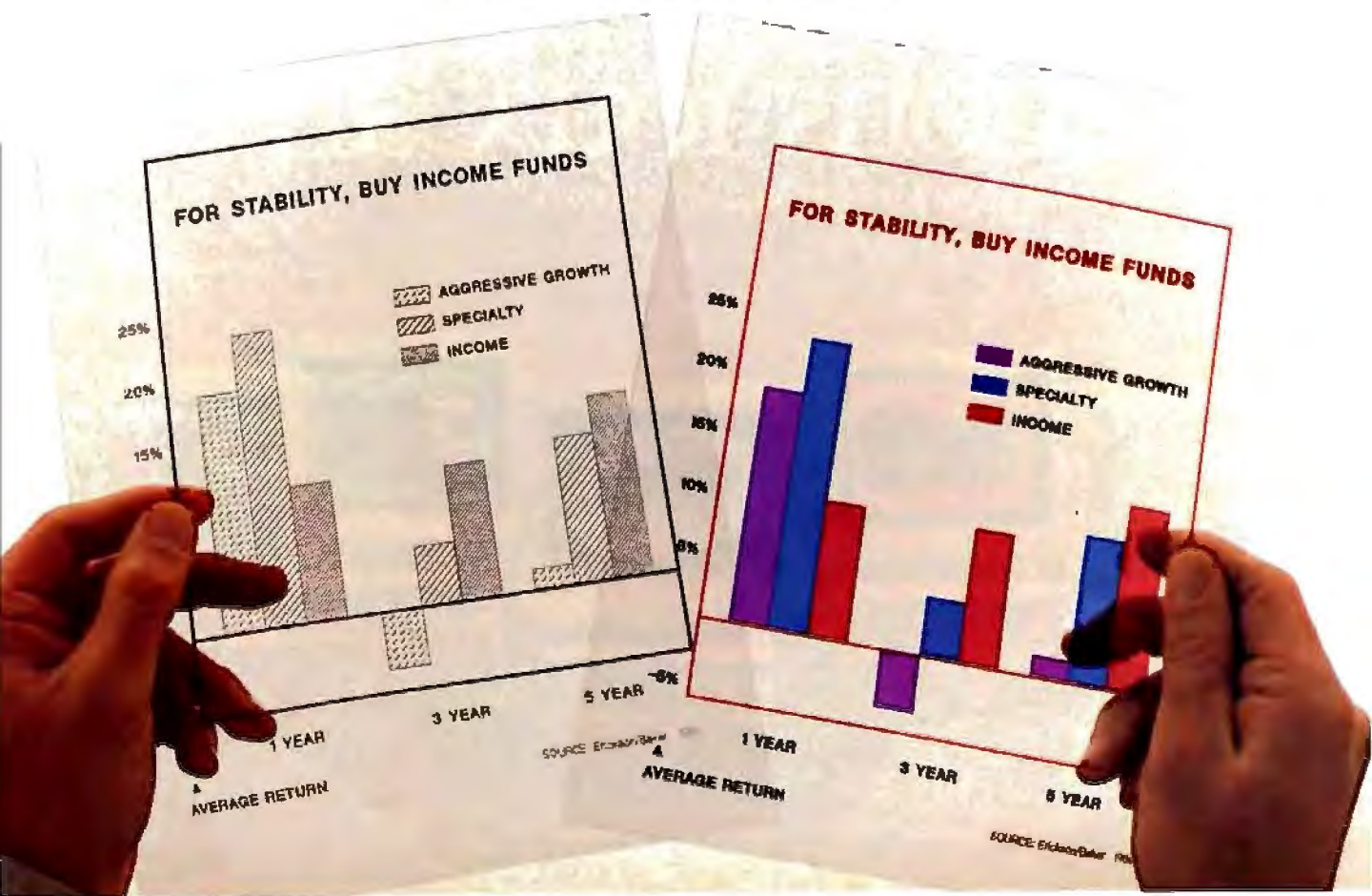

Table 1: In the benchmark tests, Reflex Plus was much faster than Double Helix II. (All times are in minutes:seconds.)

	Reflex Plus 1.0	Double Helix II 1.0
Search for last record	:05	1:13
Search for nonexistent record	:05	1:14
Index a field	<:01*	2:08

*Time does not include updating the disk, which took 1 minute upon exiting from the program.

bilities. You can use the "FormulaBuild" dialog box to easily retrieve records based on qualifications of values in fields combined with AND or OR. By pointing and clicking, you can paste the operators Equal, Not Equal, Less, Less or Equal, Greater, Greater or Equal, Starts With, and Includes into the query formula. As with constructing calculation formulas, the FormulaBuild feature lets you set up complex searches without having to memorize search formula syntax.

Unlike some relational databases, Reflex can also serve as a text-oriented database. The 4000-character maximum field size is large enough for comments on a

client or the abstract of a journal article. The Start With and Include operators can handle key word or phrase searches adequately. Even with these capabilities, text entry could be cumbersome, because you move from one field to the next by pressing the Return key. That could preclude creating separate paragraphs within a field, but Reflex Plus gets around this potential problem by letting you insert line breaks in a text field by pressing Shift-Return.

Formulating Reports

The Reflex Plus report generator is as simple and sophisticated as the rest of the program. There are two ways to create a

report. The quickest is to use the built-in table-style report that shows one record per row. Customized reports let you place fields wherever you like on the report form. You can create free-form reports that combine data from several different databases.

Finally, you can also use custom report forms to create spreadsheet-style reports where you use calculated fields to automatically perform operations on the values you enter. You might, for example, set up a tax form in which you enter values into some fields, and Reflex plus automatically calculates the value of other fields from those values you enter.

Formulas allow the inclusion of summary fields in reports for such statistics as counts, sums, averages, minimums, maximums, and standard deviations. Nesting lets you create sophisticated reports that show hierarchies of records and that can use data-file links and the contents of other reports. Unlike Reflex, Reflex Plus lets you sort on as many fields as you want, in any way you want.

When Borland transformed Interlace into Reflex, one of the improvements was to build in support for nonstandard sizes of paper. When you use the Apple ImageWriter—not the LaserWriter—you can

Solutions You Can See.

Color display monitors for personal computers.



XC1409C
CGA Compatible

XC1410C
EGA Compatible

XC1412C
PGC Compatible

XC1430C
EGA Compatible

XC1434C
AT&T Compatible

change the width and height of the paper on which Reflex Plus prints your documents. This capability lets you use a broad variety of different sizes of paper, envelopes, and labels. Reflex Plus improves further on Reflex's report-printing capability by letting you select several fonts from those you have available, whereas Reflex lets you select only the first 16 fonts that appear in your fonts menu.

Fast Performance

I ran some benchmark tests comparing Reflex Plus version 1.0 to Double Helix II version 1.0, a well-known relational database manager for the Macintosh (see table 1). I ran the tests on a Macintosh 512E that had been upgraded to 1 megabyte of RAM with a Dove 524S MacSnap memory board and SCSI port upgrade. Attached to the SCSI port was a Super-Mac DataFrame 20 hard disk drive.

The test file I used consisted of approximately 900 records with 10 fields of data. This file, originally created with Double Helix II, was tested first on Helix and then exported from that program as an ASCII text file and imported into Reflex Plus. The importing process was straightforward and flawless.

With the first test, I searched for the last record in the database on a nonkey (Reflex Plus) or nonindexed (Double Helix II) field. Then I ran a search on that same field for a nonexistent record—one that, if it did exist, would be at the end of the file. Double Helix II took about 14 times as long as Reflex Plus to perform both tests.

Finally, I indexed that field (Double Helix II), or turned it from a nonkey into a key field (Reflex Plus). Here, Reflex Plus had a built-in advantage. Helix indexed the records permanently on disk, while Reflex Plus, which loaded all 900 records into memory, only had to manipulate the order of records in RAM. However, it took only a few seconds to save the reindexed Helix database. By contrast, when I tried to quit Reflex Plus, it asked if I wanted to save the changes. The only change was that I made a field into a key field. It took 1 minute to make that change on disk. At first Reflex Plus seemed slow, but it is still faster than Helix with a database this size.

What doesn't Reflex Plus do? Besides custom menus and dialog boxes, Reflex Plus still doesn't have graphic fields, macros, or a programming language. It is not a multiuser program and, probably

Besides custom menus, Reflex Plus still doesn't have graphic fields, macros, or a programming language.

for that reason, does not offer password security. However, if you can get by without these features, Reflex Plus is a fast, easy-to-use, highly visual, fully relational Macintosh database program that retails for about \$200 less than its competition. ■

ACKNOWLEDGMENT

The author gratefully acknowledges the help of Rick Larson of North American Services Software Division in Denver for his help in obtaining the benchmarks.

Charles Spezzano is the author of "Database Managers" in BYTE's Applications Software Today (Summer 1987). He can be reached at 950 East Harvard Ave., Denver, CO 80210.

Mitsubishi Electronics can support all your monitor requirements with solutions you can see. Mitsubishi® brand name monitors continue to set the standards in quality, reliability and value. For IBM® PC, XT, AT, PS/2, Apple® Macintosh™ II or AT&T compatibility, Mitsubishi can provide the right monitor at an affordable price.

Sharper, Brighter Images On A 13V"/14" Screen.

Each Mitsubishi brand name monitor combines advanced, proven technology to produce an image that's uniformly bright along with clear, vibrant colors—all without annoying flicker.

Commitment To Customer Satisfaction.

Mitsubishi Electronics is the experienced and proven

vendor of high quality monitors for a wide range of applications, including presentation graphics, CAD/CAM, desktop publishing, or image processing.

For product information or authorized Mitsubishi Electronics representatives, please call 1-800-556-1234 Ext. 54. In California, call 1-800-441-2345 Ext. 54. Mitsubishi Electronics America, Inc., Computer Peripherals Division, 991 Knox Street, Torrance, CA 90502 (213) 515-3993.

Circle 176 on Reader Service Card (DEALERS: 177)

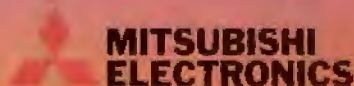

AUM1371A—
Diamond Scan
Auto-Tracking



XC1429C
IBM® PS/2™
VGA Compatible

Silicon Specialties

1-800-634-0402

From As Low As

\$346

Call For Details and Other System Configurations



Up to 640K on Mother Board Brand Name Floppy Drives, 135 Watt Power Supply, Slide Case, AT Style Keyboard, 4-10 MHz Clock Speed, (Keyboard Selectable), 8 Expansion Slots.

Hardware

DISK DRIVES

Bernoulli Box

10 Meg	\$ 865
20 Meg	1260
40 Meg	1605
Beta External	1645
Beta Internal	909
Seagate 20 MG w/WD Controller	290

COMPUTERS

AST Model 80	\$1350
Model 120	2050
All Other Models	Call

NEC Multispeed	Call
Multispeed EL	1615

Toshiba T-1000	\$ 810
T-1100 Superwiz	1649
T-3100	2799
T-3120	3175
AT & T New	Call
Sharp New	Call

Alps All models	Call
Brother Printers	Call
Citizen Printers	Call
1200	\$ 145
1401	160
MSP 40	285
MSP 45	445
MSP 50	355
MSP 55	450
Other models	Call
Diconics 150	299
Epson Printers	Call

HARD CARDS

Plus Development	Call
Mountain	Call
Everex Tape Back-up	Call

MONITORS

Amiga Monitors	Call
NEC Multisync II	\$ 549
Multisync Plus	Call
Other Models	Call
Princeton Graphics Monitors	Call
Princeton Ultrasync	480
Sony Multiscan	\$ 665
Mitsubishi Diamond Scan	\$ 489

PRINTERS

Hewlett-Packard Laser Jet Series II	1799
NEC Silentwriter	850
P 6 P-7 P-9 Series	Call
3510 3550	729
8810 8850	1045
Okiata Printers	Call
Panasonic 10801 Model II	165
10911 Model II	180
1524	535
1595	429
Other Models	Call
Star Micronics	Call
Toshiba 321 SL	499
341 SL	665
351 Model II	899

Hayes All Models	Call
Prometheus 1200B	\$ 90
2400 B New	120
Other Models	Call
US Robotics Password 1200	149
Courier 2400	299

MODEMS

Hayes All Models	Call
Prometheus 1200B	\$ 90
2400 B New	120
Other Models	Call
US Robotics Password 1200	149
Courier 2400	299

BOARDS

AST Hot Shot	\$ 330
Six Pack Plus	109
Other Models	Call
ATI EGA Wonder	175
VGA	265
Hercules Color Card	145
Graphics Card Plus	175
Intel In Board	Call
PC 1010	205
4020	310
Inboard 386	1005
Intel 386	719
Orchid Turbo EGA	449
Jet 386 Accelerator-AT	829
Tiny Turbo 286	399
Paradise 5 Pack	99
Autoswitch	Call
VGA - New	239
VGA Professional New	355
Video-7 VGA	296
Vega Deluxe	195

Software

SPREADSHEETS

Cambridge Analyst	\$ 55
HAL	104
Lotus 1-2-3 Ver 2.01	295
MS Excel	285
Multiplan 3.0	Call
PFS Pro Plan	49
Supercalc 4	269
Twin Classic	32
VP Planner	47

LANGUAGES

C Compiler (Microsoft)	Call
Fortran Compiler (Microsoft)	Call
Macro Assembler (Microsoft)	Call
Ryan McFarlan Fortran	\$339
Ryan McFarlan Cobol	539
Pascal Compiler (Microsoft)	Call
Quick Basic 4.0	Call
Turbo C	58
Turbo Jumbo Pack	159
Turbo Pascal 4.0	58

PROJECT MANAGEMENT

Harvard Total Project Manager II	\$ 289
Microsoft Project 4.0	Call
Super Project Plus	269
Timeline 2.0	265

INTEGRATIVE SOFTWARE

Ablity Plus	\$105
Enable 2.0	359
Framework II	309
MS Works	Call
PFS 1st Choice	69
Smart Software System	Best Price
Symphony	439

GRAPHICS/MICE

Chartmaster	\$199
Diagram Master	185
Genenc CAD w/Dot Plot 3.0	72
Harvard Graphics 2.1	232
JMSI Mouse w/Dr Halo III	89
In A Word	259
Logmouse	65
Logmouse w/pant	85
Microsoft Buss Mouse 1.0	Call
Microsoft Chart 3.0	Call
Microsoft Serial Mouse 1.0	Call
News Room	30
News Room Professional	65
PC Buss Plus Mouse (New Ver) w/pant	99
PC Mouse (New Ver) w/pant	89
Printmaster	29
Print Shop	32
Signmaster	132
Turbo Graphix Tool Box	38
Windows Draw!! w/cip art	159

DATA BASE MANAGEMENT

Clipper	\$ 368
dBase III Plus	379
DB-XL	79
Eureka	88
Fox Base Plus 2.0	192
Genler	188
Nutshell	75
Paradox 2.0	379
PFS Professional File	119
O & A	185
QuickCode Plus	138
QuickReport	138
Revelation	449
R Base 5000 System V	399
Relief	78
VP Expert	Call
VP Intro	Call

ACCOUNTING

BPI - G.L. A/R A/P Payroll	\$165
Computer Associates-G.L. A/R A/P	379
DIAC Easy Accounting	Call
One Write Plus	140
Time Slips	55

ACCESSORIES

Copy II Option Board	\$ 69
Masterpiece	84
Masterpiece Plus	93
MousePad by MouseTrac	9
Summasketch 12x12 Tablet Plus	359

TRAINING

Flight Simulator	Call
MS Learning DOS	Call
PC Logo	\$ 69
Turbo Tutor II	23
Typing Instructor	27
Typing Tutor IV	27

WORD PROCESSORS

Microsoft Word 4.0	\$185
Multimate Advantage II	255
PFS Professional Write	99
Volkswriter 3	132
Volkswriter Deluxe Plus	59
Webster New World Writer	55
Webster Spell Checker	32
Webster Thesaurus	39
Word Perfect	189
Word Perfect Executive	103
Word Perfect Library	55
Wordstar Pro Pack 4.0	205
Wordstar 2000 Plus 3.0	189

DESKTOP PUBLISHING

Newsmaster	\$ 48
Pagemaker	439
PFS First Publisher	49
Ventura Publishing	Call

MONEY MANAGEMENT

Tobias Managing Your Money 4.0	\$115
Dollars & Sense w/Forecast	92



No Charge for VISA and MasterCard
 We Do Not Charge Your Card Until Your Order is Shipped
 You Pay the Ground Shipping We Pay the Air
 Ground Shipping & Handling \$8.00
 Free Air shipping ONLY on orders up to 10 lbs. & Over \$50
 All product carries a manufacturer's warranty. All
 Guarantees include their period, privileges & promotional
 programs are imposed by the manufacturer only.

No APC, EPO or international orders please
 Call before submitting P.O.'s Ask for National Accounts
 Personal and Company Checks Will Delay Shipping 3 weeks
 Prices, Terms & Availability Subject to Change Without Notice
 Add 5% for C.O.D. Orders
 We Do Not Guarantee Machine Compatibility

Mailing Address
 2200 North American Parkway, Houston, TX 77057
 To purchase any item 1-800-634-0402
 To borrow any item call (800) 344-2742
 Check Line History Monday-Friday 7a.m. - 6p.m.
 Saturday 9a.m. - 12p.m.
 Order Processing Hours (800) 644-1001
 9a.m. - 3p.m. Mon-Fri



Transparent Conversions? Hah!

Jerry Pournelle

QuickBASIC 4.0 vs. Turbo BASIC and "Jerry's Choice" Awards for 1987

It has been quite a month, what with getting *Prince of Mercenaries* finished, going off to New York to make speeches and confer with my editors about *Wrath of God*, keeping up with the columns, and so forth.

Meanwhile, it's time for my annual purely subjective awards for last year's most useful products.

The New York trip was fun. Ed Yourdon hosts an annual gathering for authors who write books for the Yourdon imprint at Prentice-Hall, and he wanted someone to talk about modern technology, writing, and the future. The neat part was that he had some other speakers, so I learned a lot about publishing.

I'd meant to have this column written by now. I even set aside the whole weekend to get it done. Alas, the fates intervened. For my sins, I decided to translate a GWBASIC program into both Microsoft QuickBASIC 4.0 and Borland Turbo BASIC before I started. That shouldn't have been hard, right? I mean, the program ran fine in interpreted BASIC; how hard could it be to compile it?

Hah. I soon learned, and if I never see another GOTO statement, it will be too soon.

A Simple Job

What happened was that a couple of years ago we decided to turn Mrs. Pournelle's reading instruction system, which then existed as a series of paper workbooks, into a program for the IBM PC and compatibles.

This was long enough ago that I was still very much a BASIC enthusiast. I had the notion that it ought to be a fairly simple job, and that BASIC was the obvious choice of language. After all, once it was written, Roberta could learn enough BASIC to modify and maintain it, and I wouldn't be wired into the loop. We did an analysis of the program requirements, and it didn't look complicated; indeed, it all seemed pretty simple.

Alas, time went by, and I never got a

chance to do the program, but people kept asking us about it. Clearly, something had to be done.

That was when we asked Bruce Tonkin of T.N.T. Software to help us. Bruce writes all his software in BASIC and has done some amazing things with it. He's got a wide variety of products, all at low cost. His My Word! text editor competes in features and ease of use with some of the expensive ones, but it sells for less than \$50. You can even buy the source code (in BASIC). It's always worth having Bruce's latest catalog. Anyway, Bruce took Roberta's notions and her paper worksheets and turned them into a GWBASIC program that presented the lesson elements quite well.

Just about then we got interested in the Atari ST, and Alex Leavens—"alexL" on BIX—did a C version that makes use of the GEM interface on that machine. No one had time to work on the IBM PC version until the Atari ST version was done; but just this month the Atari version was finished.

The PC version hadn't been completely neglected. Our friend Joyce Jumper plugged away at it. In particular, she added a bunch of visuals clipped from the various Fantasy libraries. The Fantasy art folders have a wide variety of interesting sketches and drawings, ranging from people working to bundles of firecrackers going off. The visuals are mostly intended for printing by desktop publishers, but they look fine on a PC screen.

Joyce set things up so the program can use the illustrations as rewards when the students get things right. She also added a number of tunes that the machine will play. (Naturally, we set it up so nothing interesting happens if the pupils get

things wrong; after all, you don't want them to make mistakes just to see the error messages....)

Meanwhile, Roberta had learned a lot from finishing off the Atari ST version of her program.

No matter how much planning you do, when you actually get a program out there in testing, you'll find you've left out a number of things, and some of them, particularly in the user interface, will be important.

Naturally, Roberta wanted to incorporate her new features into the PC version. Unfortunately, interpretive BASIC isn't really ideal for as large and complex a program as this had become. Roberta is pretty new to programming, and this was just too much.

There was also the problem of marketing a program written in GWBASIC. Not everyone has BASIC. If your program is in interpreted BASIC, you have no choice but to distribute the source code. This may be no tragedy, but publishers don't see it that way. Also, GWBASIC can be pretty slow. It was clearly time to do something about it.

At this point, I must have taken leave of my senses. "I'll take care of it," I said. "I'll just translate the program into a compiled BASIC. Shouldn't take long." Hah.

Conversions

I suppose I should have known better, but after all, the program was running fine on Atilla the Honey, Roberta's AT&T PC 6300 Plus. It takes scads of files: as it's set up at present, there are some 65 lessons, and each lesson has a lesson-text file, a banner file that contains an illustration used to begin the lesson, and a reward file with more illustrations.

continued

Jerry Pournelle holds a doctorate in psychology and is a science fiction writer who also earns a comfortable living writing about computers present and future.

Clearly, the files should be consolidated, but that's no great trick. Transferring all those files took time, but that wasn't a problem either. Eventually, everything, including the ASCII GW-BASIC source code, was on one high-density floppy disk, and I was ready to get started.

The next step went well, too. I copied all those files onto Fast Kat, the Kaypro 386, brought up Turbo BASIC, imported the GWBASIC source code, and told Turbo BASIC to begin compiling. There was one error, a missing REMARK symbol. Turbo BASIC's integrated editor dropped me out precisely where the error was. In seconds that was fixed, and in less than a minute, the program had compiled just fine. Turbo BASIC compiles *fast*.

Running it was a different matter. The program started fine, but then it left out great hunks of the lessons. There weren't any reward illustrations, nor any tunes played. When the first lesson was done, it told me I'd completed the entire reading program. Clearly, there were a few more problems than I'd anticipated. Still, this couldn't take long. After all, I started with a working program.

Terminate the GOTO

The first thing was to get inside the program. It couldn't be too hard to understand, because the program itself is simple: it puts up text on the screen to be read by the instructor (who can be any literate person); then it puts up simple exercises for the student who's trying to learn to read; and, depending on the student's answers, it gives more instructions and more exercises. That shouldn't be too hard to follow. . . .

Alas, I'd reckoned without the GOTO statement.

Back when I first began writing this column, we had a considerable debate about GOTO: should the statement exist in modern computer languages? I took the view that it wasn't inherently bad and sometimes was the cleanest way out of a complex nest of conditionals and loops. These were times not so long after Edsger Dijkstra wrote his now famous piece, "GOTO Seen Harmful," and the craze for structured programming began. I believed in top-down structure, but I wasn't ready to give up GOTO.

I am now. Bruce Tonkin is probably as good a BASIC programmer as there is today, and the code he wrote works flawlessly in interpreted BASIC. He provides plenty of comments. Even so, I found it nearly impossible to follow the program flow without making extensive flowcharts and diagrams. Every time I thought I'd found a program thread, I'd come across something like the code in listing 1.

Incidentally, line 10070 was the one that caused the only compiler glitch: it needed a ' after the last colon and before TEACHER'S TEXT. Anyway, there were dozens of statements terminating in GOTO. It was clear they were part of the lesson parsing system, and if I looked at the code long enough, I could sort of see what was going on; but it wasn't easy.

It was also clear that this was the block where the program was going wrong. For some reason, Turbo BASIC was taking those instructions and doing something entirely different from what interpreted GWBASIC was doing.

There were also statements like 54140

```
IF ANSWERS$ = CHR$(0)+CHR$(80)
THEN RETURN:ELSE BOX = 7:GOSUB
52000. The Turbo BASIC manual says
that's illegal. To be exact, it says:
"The following statement will not compile:
IF a < b THEN c = d: ELSE e = f."
```

That's all well and good, but 54140 didn't upset the compiler at all. That was a bit frightening. If it wasn't even supposed to compile, there was a good chance that the program wasn't doing anything like what I wanted it to do. Time to see. I turned on Trace.

The result was a disaster. Our program draws things on the screen. Trace tries to put numbers and messages on the screen while the program is running. The result was a colossal mess: our data and Trace's statement numbers all mixed together. I didn't learn a thing.

All right, time to do some rewriting. In particular, the code in listing 2 not only will compile, but it will accomplish what the interpreter does with the original statement. It's also a lot easier to read. I used the Turbo BASIC editor to find every instance of ELSE and rewrote each of those statements. There were a lot of them.

When I was done restructuring the ELSE statements, the program worked better, but it still did very odd things. By then, I was about out of time. Then I remembered something. I'd recently received a production copy of Microsoft QuickBASIC 4.0 to replace the beta-test copies. If anything would compile a Microsoft BASIC program, it ought to be a Microsoft BASIC compiler. The only reason I hadn't used it in the first place was that Turbo BASIC was already on my hard disk. I'd have to install QuickBASIC 4.0 eventually; why not now?

QuickBASIC 4.0

Microsoft QuickBASIC 4.0 (which I'll call QB4 from here on) comes with a *lot* of files and libraries and such, and the program needs access to all of them. Putting all that stuff in one subdirectory makes intolerable clutter; it's better to break things up into a number of subdirectories.

Turbo BASIC has a configuration option that makes it easy to tell the program where to find the auxiliary files it needs. Alas, QB4 doesn't have that feature. You have to put the locations of your libraries and such in the PATH, and changing the PATH requires editing AUTOEXEC.BAT. When I did that, I discovered that my PATH command was now longer than a logical line, so I had to find things to eliminate from it. There were more annoyances like that, but eventually I had QB4 installed.

continued

Listing 1: The section of the GWBASIC code where the conversion problem was discovered.

```
10040 IF FLAG=1 THEN GOSUB 54000:BOX=7:GOSUB 52000:GOTO
11000:'SCREEN COMMAND
10060 IF FLAG=0 OR FLAG=9 THEN GOSUB 54100:GOTO 11000
10070 IF FLAG=5 THEN BOX=2:LSET SMALL$(LINE.COUNT):GOSUB
54300:GOTO 11000:TEACHER'S TEXT
10080 IF FLAG=4 THEN X=1:WHILE X<LEN(S$(LINE.COUNT)):GOSUB
51000:WEND:GOTO 11000
```

Listing 2: An example of an IF... THEN... ELSE statement rewritten for Turbo BASIC.

```
54140 IF ANSWERS$ = CHR$(0)+CHR$(80) THEN
RETURN
ELSE
BOX = 7
GOSUB 52000
END IF
```

THE PROGRAMMER'S SHOP

helps save time, money, and cut frustrations. Compare, evaluate, and find products.

FREE Programmer's Update Magazine

"Keeping Professional Programmers Current with Developer's Technology." *Programmer's Update* lives up to its motto with a viewpoint unique to this industry. We use our experience and contacts to bring you articles about intriguing software trends and technical issues, interviews with authors and innovators, news about products, surveys, insightful commentary and predictions, valuable resource listings. You can get a FREE sample copy today by calling our toll-free number. Mention "BY388". A personal subscription is just \$25 a year.

Our Services:

- International Sales Desk
- Compare Products
- Help Find a Publisher
- Evaluation Literature FREE
- Programmer's Update
- Dealers Inquire
- Newsletter
- Rush Order
- Over 700 products
- National Accounts Center

386 Development Tools

386 Assembler/Linker	PC	\$ 389
386 Debug - by Phar Lap	PC	\$ 129
386/DOS Extender	PC	\$ 919
DESQview PS/2	PC	\$ 109
F77L-EM - by Lahey	MS	Call
High C - by MetaWare	PC	Call
OS/286 & 386 by AI Architects	PC	Call
Paradox 386	MS	\$ 799

All Languages

APT - Active Prolog Tutor - build applications interactively	PC	\$ 49
ARITY Prolog - full, 4 Meg Interpreter - debug, C, ASM	PC	\$ 229
COMPILER/Interpreter-EXE	PC	\$ 569
Cogent Prolog Compiler	MS	\$ 179
MicroProlog Prof. Comp./Interp.	MS	\$ 609
PC Scheme LISP - by TI	PC	\$ 85
Star Sapphire	MS	\$ 429
TransLISP - learn fast	MS	\$ 79
TransLISP PLUS	MS	\$ 149
TURBO PROLOG by Borland	PC	\$ 69
Others: IQ LISP (\$239), IQC LISP (\$269)		

Basic

BAS_C - economy	MS	\$ 179
BAS_PAS - economy	MS	\$ 135
Basic Development Tools	PC	\$ 89
db/Lib	MS	\$ 119
Exim Toolkit - full	PC	\$ 45
Finally - by Komputerwerks	PC	\$ 85
Inside Track	PC	\$ 49
Match 2 by MicroHelp	PC	\$ 55
NetWorks by Exim	PC	\$ 89
QBase - screens	MS	\$ 79
QuickBASIC	PC	Call
Quick Pak by Crescent Software	PC	\$ 59
Quick-Tools by BC Associates	PC	\$ 109
Stay-Res	PC	\$ 59
True Basic	PC	\$ 79
Turbo BASIC - by Borland	PC	\$ 69
Turbo BASIC Database Toolbox	MS	\$ 69

FEATURES

SofTRAN, the Translation and Text Language by TransOptima - full procedural language like C plus pattern and nonprocedural constructs cuts development effort by up to 16 times. PC \$ 349

FORCE III, Dbase Compiler by Sophco-small. EXEs, user-defined functions, I/O directives through BIOS/DOS/ANSI/ FORCE/user-defined, extensions include FOR...NEXT loops, soundex, ID arrays. Maverick. PC \$ 109

Circle 211 on Reader Service Card

Program Objectively — for Less

Object-oriented programming tools free you from trivia tracking, make sophisticated applications practical quickly.

Consider **ACTOR**, full language and environment that lets you replace 100's of lines of code with just a few. It just may be the next standard language. Regularly \$419 (\$495 retail), until March 31, 1988 only \$399.

CALL TODAY for free detailed literature about these and other object-oriented tools. Take advantage of these special prices — **order before March 31, 1988.** Mention "BY388."

HOOPS by Ithaca Software lets you assign attributes to objects for advanced graphics applications. Include hidden line/surface removal, multiple light source rendering, and more in 3D with animation. Use natural language. Device independent, call from C, Pascal, or FORTRAN. Regularly \$549 (\$575 retail), until March 31, 1988 only \$419.

RECENT DISCOVERY

CLARION DBMS by Barrington Systems. Fast applications prototyping and development. Language, compiler, screen/report generators, editor, call other languages, read/write dBASE III + files. PC, List: \$695

C Language Compilers

AZTEC C86 - Commercial	PC	\$499
C86 PLUS - by CI	MS	\$359
Datalight Optimum - C	MS	\$ 99
Instant-C/16M	PC	Call
Lattice C - from Lattice	MS	\$259
Microsoft C 5.0 - Codeview	MS	Call
Microsoft Quick C	MS	Call
Rex - C/86 standalone ROM	MS	\$695
Turbo C by Borland	PC	\$ 67

C Libraries-Files

BTree by Soft Focus	MS	\$ 69
CBTREE - Source, no royalties	MS	\$ 99
ctree by Faircom - no royalties	MS	\$315
rtree - report generation	PC	\$239
dB2C Toolkit V2.0	MS	\$249
dbQUERY - ad hoc, SQL-based	MS	Call
dbVISTA - Object only	MS	Call
Source - Single user	MS	Call
dBx - translator	MS	\$299

C-Screens, Windows, Graphics

C Worthy Interface Library	PC	\$249
Curves by Aspen Scientific	PC	\$109
dBASE Graphics for C	PC	\$ 69
ESSENTIAL GRAPHICS - fast	PC	\$185
FontWINDOW/PLUS	PC	\$229
GraphicC - new color version	PC	\$279
Greenleaf Data Windows	PC	\$155
w/source	PC	\$259
Terminal Mapping System	PC	\$279
TurboWINDOW/C - for Turbo C	PC	\$ 75
View Manager - by Blaise	PC	\$199
Vitamin C - screen I/O	PC	\$159
VC Screen	PC	\$ 79
Windows for C - fast	PC	Call
Windows for Data - validation	PC	Call
ZView - screen generator	MS	\$149

Atari ST & Amiga

We carry full lines of Manx & Lattice.

DBASE Language

Clipper compiler	PC	\$399
dBase III Plus	PC	\$429

Call for a catalog, literature, and solid value

800-421-8006

THE PROGRAMMER'S SHOP

Full computer support software, hardware, and services

5-B Pond Park Road, Hingham, MA 02043
 Muss: 800-442-8070 or 617-740-2510 1/88

RECENT DISCOVERY

CO/SESSION - Remotely access PC and peripherals, train or trouble-shoot from off-site, 2 users on one program. Session record/playback, file transfer, terminal emulation, keyboard and voice modes. PC \$229

DBASE Language Cont.

dBASE III LANPack	PC	\$649
DBXL Interpreter by Word Tech	PC	\$ 99
FoxBASE+ Dev. - V2.0	MS	\$259
Quicksilver by Word Tech	PC	\$369

DBASE Support

dAnalyst	PC	\$ 89
dBase Tools for C	PC	\$ 65
dBrief with Brief	PC	Call
dBC III by Lattice	MS	\$169
debug III	MS	\$179
Documentor - dFlow superset	MS	\$229
Genifer by Bytel-code generator	MS	\$279
QuickCode III Plus	MS	\$189
R&R Report Writer	MS	\$139
Seek-It - Query-by-example	PC	\$ 79
Silver Comm Library	MS	\$139
Tom Rettig's Library	PC	\$ 79
UI Programmer - user interfaces	PC	\$249

DataBase & File Management

CQL	PC	\$ 359
DataFlex by Data Access	PC	\$ 899
DataFlex multiuser	PC	\$1149
Magic PC	PC	\$ 699
Paradox - original	PC	\$ 369
Paradox V2.0	PC	\$ 469
Revelation by Cosmos	PC	\$ 779

Multilanguage Support

BTRIEVE ISAM	MS	\$185
BTRIEVE/N-multiuser	MS	\$455
GSS Graphics Dev't Toolkit	PC	\$375
HALO Development Package	MS	\$389
Graphics	PS	\$209
Help/CONTROL - on line help	PC	\$ 99
HI-SCREEN XL	PC	\$129
HOOPS Graphics Library	PC	\$469
Informix 4GL-application builder	PC	Call
Informix SQL - ANSI standard	PC	Call
Instant Programmer's Help	MS	\$ 79
NET-TOOLS - NET-BIOS	PC	\$129
Opt Tech Sort - sort, merge	MS	\$ 99
Norton Guides	PC	\$ 75
Panel Plus	MS	\$395
Pfinish - by Phoenix	MS	\$209
Report Option - for Xtrieve	MS	\$109
Screen Sculptor	PC	\$ 89
SPSS/PC Plus	PC	\$749
Synergy - create user interfaces	MS	\$329
XQL - SQL for Btrieve	MS	\$649
Xtrieve - organize database	MS	\$179
ZAP Communications - VT 100	PC	\$ 89

Note: All prices subject to change without notice. Mention this ad. Some prices are specials. Ask about COD and PO's. Formats: * laptop now available, plus 300 others. UPS surface shipping add \$3/item.

Listing 3: The final working version of the IF statement.

```

10070 IF FLAG=5 THEN      ' THIS IS TEACHER'S TEXT
      BOX=2
      LSET SMALL$(LINE.COUNT)
      GOSUB 54300
      GOTO 11000 ' 11000 is SCREEN command
END IF

```

First thing, then, was to feed in the original program that ran under GW-BASIC. It wouldn't compile. QB4 kept telling me I had a duplicate definition of a variable named TEACHER. This made so little sense I wanted to sit down and cry. The program doesn't have a variable named TEACHER. There was a TEACHER\$, but...

Then I remembered something. Turbo BASIC wouldn't compile the program because it expected a remark delimiter; suppose QB4 saw things differently? Looking up variables in the QB4 documents index, I discovered that the \$ at the end of the variable isn't part of its name; in other words, QB4 won't permit you to have both TEACHER and TEACHER\$ as two different variables, and it was interpreting that TEACHER in 10070 (listing 1) as some kind of variable reference, probably a function call. Putting the REM delimiter in the appropriate place cured that problem, and the program compiled just fine.

When I ran the program under QB4, I got *exactly* the same errors I'd gotten with Turbo BASIC. The same parts of the lessons were omitted, no tunes were ever played, and the same garble appeared in the same place on the screen.

Since the two programs were reacting in the same way, it seemed reasonable to feed QB4 the new source code as I'd modified it for Turbo BASIC. Not only did that compile without a glitch, proving that Turbo BASIC and QB4 use pretty much the same syntax, but when I ran it I got the same result: the cleaned-up code ran better, but there were still plenty of errors.

By then, two things had happened: I'd used up a whole day, and I had the suspicion that both Turbo BASIC and QB4 were interpreting single-line IF statements one way, and Microsoft BASIC was interpreting them in another. The way to prove that was with Trace. I hadn't read anything about QB4 Trace, so I didn't expect much, but it couldn't hurt to try.

Now That's a Trace!

QB4's Trace doesn't work anything like Turbo's, or for that matter, BASIC

Trace. When Trace is on, QB4 swallows the program screen and flickers to the edit screen, where it highlights the statement now being executed. If there's new output to the program screen, it toggles back there.

The whole thing goes in slow motion, so that if you've got big loops, it can take forever, but the simple answer to that is to put TROFF (Trace Off) and TRON (Trace On) statements around places that you're sure work properly. Alas, in my case, there were so many GOTO statements scattered throughout the code that this was nearly impossible, so I was forced to sit there and watch the program draw lines and boxes a character at a time. The effort was worthwhile, though; in an hour, I had figured out what was wrong.

It was indeed those IF statements. There was no quick fix: I'd have to do some editing. A couple of hours later, it was done. All the IF statements had been broken up to look like those in listing 3, which, if nothing else, are a lot easier for humans to read. It seems to be easier for the compiler, too: once I'd done that, the program ran fine.

There were a couple of bugs I didn't much care for, but when I told Roberta about them, she said they were in the interpreted version, too. I spent a couple of hours cleaning them up. When I was done, the program ran better than it ever had; and now that it's all laid out in pretty print, it won't be so hard to change. There are still blocks of GOTO spaghetti, but I was able to convert some of those blocks into subroutines and replace others with functions. After a while, the code looked pretty clean.

Once I got the program running in QB4, I fed the code back to Turbo BASIC. QB4 and Turbo BASIC use the same syntax for subroutines, so those were not a problem. Functions are handled in about the same way, but the syntax used to define them is different; it took a few minutes to make the conversions. After that, the program ran fine in both Turbo BASIC and QB4.

The moral of the story is simple: it may be efficient to pack lots of statements on each line, and certainly that saves memory; but it's not good practice. Neither is

extensive use of GOTO statements, even when you're using them to structure the code. Edsger Dijkstra was right. GOTO is harmful.

The Great Compiler War

Competition is a wonderful thing. For years, Microsoft didn't have a BASIC compiler. The only real competition was CBASIC, which "compiled" to a kind of p-code and interpreted that. Then Gordon Eubanks began developing a true compiler for CBASIC, and shortly thereafter Microsoft announced BASCOM.

BASCOM went through a couple of improvement cycles, none spectacular, and emerged as QuickBASIC 2.0. QB2 wasn't as good as compiled CBASIC, but it wasn't bad, and it did have the merit of letting you develop programs in interpreted BASIC before compiling them. Compiled CBASIC could have given BASCOM/QB2 some real competition, but it was about then that Digital Research went into a funk and let all its languages languish, suffer, and darned near die.

Then Borland began development of Turbo BASIC. The word was that it would have an integral editor (as all Borland language products do) and a lot of other features that QB2 didn't have.

Microsoft's response was interesting: The company put not one, but *two* teams of first-class programmers on the job. Team One was told to develop the best BASIC compiler they knew how to write.

Team Two had an unenviable assignment: come up with enough kludges to QB2 to let Microsoft hold some kind of defensive position when Turbo BASIC came out. It seems clear to me that Microsoft was afraid Turbo BASIC would do to BASIC what Turbo Pascal has done to Pascal: dominate the market so thoroughly that the BASIC compiler Team One was developing wouldn't have a chance.

Team Two finished QB3 just about the same time that Borland was able to ship Turbo BASIC; and while QB3 was, at bottom, a kludge, it wasn't all that bad a kludge. It didn't have all the features of Turbo BASIC, but it did have an integral editor, and overall it was good enough to keep Microsoft in the ball game.

As it happens, Team One finished sooner than anyone had expected, so that QB4 followed close on the heels of QB3, close enough that it looked like it might be no more than an improved QB3; but that wasn't the case. Microsoft QB4 is an entirely new and different product, written by a different team, and has very little to do with QB3.

It does fix most of QB3's mistakes. As

continued



JDR INSTRUMENTS™

Complete customer satisfaction... superior service... friendly, knowledgeable personnel... quality merchandise... providing the best values in leading edge technology.

BEAT THE PRICE INCREASE!

349.95

20 MHz OSCILLOSCOPE

Save \$40 if you buy before April 1st when our price goes up to 389.95. This model makes frequency calculation and phase measurement quick and easy. Service technicians appreciate the TV Sync circuits for viewing TV-V and TV-H and accurate synchronization of the video signal. Blanking VITS, and V/H sync pulses. A component tester for fast troubleshooting.



BUILT-IN COMPONENT TESTER

EXCEPTIONALLY BRIGHT 5" CRT

DMM-300 \$79.95

3.5 DIGIT DMM/MULTITESTER

This full function 3.5 digit DMM offers highly accurate performance and a host of added features like audible continuity, capacitance, transistor, temperature, and conductance to help you do the job—fast. Temperature probe, test leads and battery included.

- Basic DC accuracy plus/minus 0.25%
- DC voltage: 200mv–1000V, 4 ranges
- AC voltage: 200mv–750V, 5 ranges
- Resistance: 200 ohms–20M ohms, 6 ranges
- Capacitance: 2000pf–20 μf, 3 ranges
- Transistor Tester: 0–2000 F
- Conductance: 200ms
- Fully overload protected
- Input impedance: 10M ohm



MODEL 3500

\$499.95

35 MHz DUAL TRACE OSCILLOSCOPE

Wide bandwidth and exceptional 1mV DIV sensitivity make this a powerful tool for engineers or technicians at a remarkable price. Delayed triggering allows any portion of a waveform to be isolated and expanded for closer inspection. Variable Holdoff allows stable viewing of complex waveforms.

- Exceptionally bright 5" CRT
- Delayed and single sweep modes
- Z axis intensity modulation
- X-Y operation • TV sync filter
- Fast 10ns rise time

DMM-100 \$29.95

3.5 DIGIT POCKET SIZE DMM

Perfect for the field service technician. Shirt pocket size without compromising features or accuracy. Large, easy to read 1/2" LCD display. Fully overload protected for safety. 2000 hour battery life with standard 9v cell. Probes and battery included.

- Basic DC accuracy plus/minus 0.5%
- DC voltage: 2v–1000v, 4 ranges
- AC voltage: 200v–750v, 2 ranges
- Resistance: 2k ohms–2M ohms, 4 ranges
- DC current: 2mA–2A, 4 ranges
- Input impedance: 10M ohm
- Fully overload protected
- Approx. 5" x 3" x 1". Under 7 ozs.



DMM-200 \$49.95

3.5 DIGIT FULL FUNCTION DMM

Get highly accurate performance at a very affordable price. Rugged construction, 20 amp current capability and 22 ranges make it a perfect choice for serious field or bench work. Low battery indicator and 1111-stand. Probes and 2000 hour battery included.

- Basic DC accuracy plus/minus 0.25%
- DC voltage: 200mv–1000V, 5 ranges
- AC voltage: 200mv–750V, 5 ranges
- Resistance: 200 ohms–20M ohms, 6 ranges
- AC DC current: 200μA–20A, 6 ranges
- Input impedance: 10M ohm
- Fully overload protected
- Approx. 7" x 3 1/2" x 1 1/2". Wt 11 ozs

DPM-1000 \$54.95

3.5 DIGIT PROBE TYPE DMM

Custom 80 pin LSI chip provides accuracy and reliability in such a compact size. Autoranging, audible continuity and data hold feature help you pinpoint the problem quickly. Case and batteries included.

- Basic DC accuracy plus/minus 1%
- DC voltage: 2v–500v, autoranging
- AC voltage: 2v–500v, autoranging
- Resistance: 2k ohms–2M ohms, autoranging
- Fully overload protected
- Input impedance: 11M ohm
- Approx. 6 1/2" x 1 1/2" x 3/4". Under 3-ozs.



- ★ 2 YEAR REPLACEMENT WARRANTY
- ★ 30 DAY MONEY BACK GUARANTEE
- ★ TOLL FREE TECHNICAL SUPPORT
- ★ NEXT DAY AIR SHIP AVAILABLE

Circle 131 on Reader Service Card

COPYRIGHT 1987 JDR MICRODEVICES

JDR INSTRUMENTS, 110 KNOWLES DRIVE, LOS GATOS, CA 95030
RETAIL STORE: 1256 SOUTH BASCOM AVE, SAN JOSE, CA (408) 947-8881

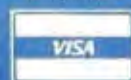

ORDER TOLL FREE 800-538-5000

an example, whereas QB3 had an entirely different version to compile programs for systems with math chips, QB4 simply uses the math chip if it's available and otherwise does without.

More importantly, QB4 has many features QB3 didn't attempt. QB4 supports recursion. It can handle modular compilation: you don't have to recompile everything every time. It has good data structures, including records.

Probably the most spectacular new features are the debugging routines. QB4's Trace is enormously powerful.

You can stop the program, make minor changes, and resume it. If you try to make too many changes, the program warns you that you'll have to recompile and start over, but it gives you a chance to abort the changes.

You can set multiple breakpoints to temporarily stop the program. There's a History routine that preserves information about where the program had been before it was stopped. There's a Watch Window, where you can observe the changing values of specified variables. All told, the QB4 debugging tools are the

most powerful I've ever seen for any BASIC.

The other fundamental difference is that QB4 "compiles" the code as you write it. Of course, you have to write it within the QB4 editor to get that feature, but that's no great hardship: the editor is well-designed and, unlike the Borland editor, works with a mouse (my Logitech Mouse worked fine).

If you really want to use your own programming editor, QB4 will compile the program as it reads it in—although if my experience with the "duplicate definition" is any indication, it isn't all that good at locating syntax errors. If you use the QB4 environment to write your code, you won't get any syntax errors: QB4 parses each line before "compiling" it.

This isn't true compilation: what QB4 is doing is translating your code into a Forth-like threaded code, not assembly language. The resulting threaded code isn't as fast as true compiled code, but it has the great merit of being easily traced. When you're finished with the program, you do an entirely different operation that produces real assembly language code, so that you end up with a stand-alone program.

QB4 really is a new product, written from scratch. There are inevitable bugs, which I have no doubt that Microsoft will correct; I expect QB4.1 by spring. So far, I haven't encountered any serious bugs, but I've heard of some.

It mildly bothers me that the "compiler" that produces memory code isn't the same as the compiler that produces the final product you'll eventually run, and I wonder if there are any hidden traps there. After all, I have good reason to know that just because a program will compile, that's no proof that it will do what you want it to. On the other hand, it doesn't bother me enough to keep me from using QB4.

I haven't done any tests on the final output of QB4 versus Turbo BASIC. The fact is that I have both compilers, and once I've developed Roberta's program, I'll try it with both; their syntaxes are sufficiently close to make that simple. Then I'll test them and see which is fastest, has the smallest code, and so forth. Whichever produces the best final code, though, there's no contest about which is the best programming environment. Microsoft wins that hands down because of the debugging tools. QB4 is a serious language, quite good enough to develop any program you like.

At the moment, then, Microsoft is winning the BASIC battle in the Compiler War. I'd recommend that serious BASIC programmers get both compilers.

continued

Compact, Low Power, Cost Effective Single Board Computers for Embedded Applications

World's smallest PC — and CMOS too!

A Motherboard and 4 Expansion Cards in the Space of a Half-Height 5-1/4" Disk Drive!

from **\$359**
Qty 1

Little Board™/PC

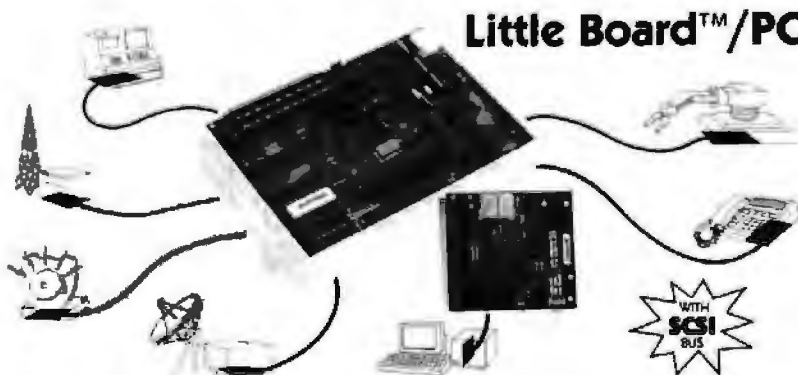

**Stackplane/
PC**



PC-bus expansion option for LB/PC

Little Board/186



High performance single board MS-DOS system 8/16 MHz

Expansion/186

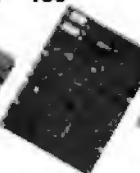

Multi-function expansion for LB/186, I/O, Serial, RAM, Math, Clock

Project Board/186



Prototype adapter for 80186 based projects and products

Little Board/80



Least expensive single board CP/M system!

Project Board/80



Prototype adapter for Z80 projects and products

Distributors • Argentina: Facionat, S.A. 41-0018 • **Australia:** Current Solutions (613) 720-3298 • **Austria:** International Computer Applications GMBH 43-1/45 45 01-01 • **Brazil:** Computadores Compuleader (41) 262-4856 • **Canada:** Tri-M (604) 438-0028 • **Denmark:** Danbil (03) 66 20 20 • **Italy:** Microcom (8) 811-9406 • **Finland:** Symmetria OY 358-0-535-322 • **France:** Egal Plus (1) 4502-1800 • **Germany, West:** IST-Elektronik Vertrieb GmbH 089-611-6151 • **Israel:** Alpha Terminals, Ltd. (03) 49-16-95 • **Spain:** Hardware & Software 204-2099 • **Sweden:** AB Akta (08) 54-20-20 • **Switzerland:** Thau Computer AG 41 1 740-41-05 • **UK:** Ambar Systems, Ltd. 0296 435911 • **USA:** Contact Ampro Computers Inc

AMPRO
COMPUTERS, INCORPORATED

1130 Mountain View/Alviso Road
Sunnyvale, California 94089
(408) 734-2800
TLX 4940302 FAX (408) 734-2939

10 REASONS WHY YOUR ADA COMPILER SHOULD BE A **JANUS/ADA** COMPILER (Besides the Price!)

1. **We're fast**

Compilation and development speed mean a lot when you're working on a large program; every minute you have to wait is time and money wasted. A Janus/Ada compiler has an average compilation speed of 400 lines per minute with a 6 MHz 8086; over 500 lines per minute with an 80186; 1100+ lines per minute on an 8 MHz 80286, and nearly 1900 lines per minute on PC Limited's 386.

2. **We work on any XXX86 machine.**

Not everybody can afford the newest technology and some of us can't afford the name brands . . . but with Janus/Ada, that doesn't matter. It doesn't need protected mode, 8087's, or PC-DOS. As long as you have an Intel 80X86 chip at the heart of your computer and some way to run or emulate MS-DOS 2.1 or higher, you can use Janus/Ada.

3. **Our product has been in use for over six years.**

We released our first compiler in 1981 and got our first review in 1982. The products we sell have had the scrutiny of customers and reviewers for over six years, changing to meet the increased sophistication of the technology and the user. Our customers come from every segment of the computing community; the government, Fortune 500, and academia. Users like yourself are able to benefit from the wide range of uses we respond to every day, as well as the built-in network of people working with Ada just like you.

4. **No copy protection.**

Our products come to you free of any form of copy protection and with a warranty insuring media replacement for defective media. We know you don't need the hassle of locking devices and other protective devices. We know you want to use Janus/Ada on your hard disk and network, and we make it easy to install, easy to maintain, and easy to use.

5. **Application programs written in Ada for as low as \$12.00.**

We offer IBM graphic routines, window handlers, scientific libraries and many other application programs written in Ada. These programs come with complete source code and documentation and are user tested.



6. **We offer embedded systems capability, like rommable, reentrant code and licensing of our source code.**

Janus/Ada is designed to make your embedded processing easy . . . with features especially created for that environment. Our code is rommable, allowing you to "burn in" the applications you create. We make our source code available in our Systems Package ("S" Pak), so you don't have to guess at the answer. If you would prefer to have us design and implement your code, we'll be more than happy to accommodate.



7. **Superior error handling.**

Nothing is more frustrating than an error in coding . . . except a bad error message which does nothing except confuse you. Our error messages tell you vital information, such as line location, cause of error and a full walkback including sub-program names. If you do a lot of development, or you just appreciate being fully informed, our error messages are sure to please!



8. **Support that won't let you down.**

Superior support services, such as the Janus/Ada bulletin board, the Janus/Ada BIX conference, a quarterly newsletter, as well as customized support services.



9. **Our compiler was developed on a micro, for a micro, in Ada.**

We have "bootstrapped" our compiler, version by version, so that we know it really works! Our compiler was developed on multiple XXX86 machines, from different manufacturers, so that it would be a true microcomputer compiler. Our products are developed in Ada, demonstrating our commitment to the language and the capabilities it can bring to you.



10. **Self paced, low cost educational tutorials.**

The Janus/Ada Extended Tutorial offers a programmer's perspective on learning Ada. This tutorial was written expressly for novices in the Ada language, by a programmer, and includes a complete set of disk based quizzes to compliment the 150 page tutorial. You can determine how quickly you pace yourself, and you won't believe you did it for \$99.95.

JANUS/ADA PASSED VALIDATION 12/11/87 . . . AND IS STILL ONLY \$99

IBM, PC, MS-DOS, and Micro Channel are trademarks of International Business Machines Corporation. The U.S. Department of Defense and the U.S. Navy are trademarks of the U.S. Government.

Copyright 1987 RR Software



SOFTWARE, INC.

P.O. Box 1512 Madison, Wisconsin 53701
(608) 244-6436 TELEX 4998168

specialists in state of the art programming

1-800-722-3248

Circle 230 on Reader Service Card

ChiWriter

Variation 2.5
now available

How are you currently producing your scientific documents? Are you using a 'golf ball' style typewriter? A regular word processor, hand lettering the special symbols? Are you fighting against a 'what-you-see-is-definitely-not-what-you-get' system with a special command language? Or are you using one of our competitors' overpriced and inflexible products? Find out how ChiWriter can solve your scientific word processing problems.

$$\frac{1}{\sqrt{2\pi}} \int_{-a}^a \frac{-(x-\mu)^2}{2} dx$$

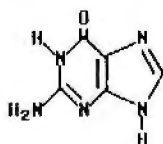

From an actual ChiWriter screen display.

Powerful Scientific/Multifont Word Processing at a Reasonable Price.

ChiWriter is a complete word processor designed especially for typing scientific and foreign language text. Its features include automatic pagination, variable headers and footers, footnotes, two text windows and intuitive formula editing commands. Best of all, ChiWriter is completely 'what-you-see-is-what-you-get'. Even entering complicated formulas is easy because the screen display corresponds exactly to the printout.

ChiWriter runs on IBM PC's with CGA graphics, one disk drive, 256K memory and Epson/IBM Graphics compatible and other 9 pin printers. Support disks with drivers and high resolution fonts for other graphics boards and printers are available.

ChiWriter is a nifty product with a price I defy you to beat and performance I defy you to snub. I know of several \$500 programs that will do the job, but for the same money you could buy ChiWriter and a vacation.

Phil Wiswell, PC Magazine

- | | |
|---------------------------------------------------------------------|----------|
| <input type="checkbox"/> ChiWriter Program | \$79.95 |
| <input type="checkbox"/> H. Res. Screen Support | \$24.95 |
| <input type="checkbox"/> Hercules, EGA, VGA, AT&T Olivetti, Toshiba | |
| <input type="checkbox"/> 24 Pin Printer Support | \$24.95 |
| <input type="checkbox"/> Laser Printer Support | \$59.95 |
| <input type="checkbox"/> HP Laser Jet Postscript | |
| <input type="checkbox"/> Chemistry Font Set | \$49.95 |
| <input type="checkbox"/> International Keyboard Support | \$19.95 |
| <input type="checkbox"/> WordPerfect Converter | \$49.95 |
| <input type="checkbox"/> Brochure | |
| <input type="checkbox"/> Shipping & handling | \$ _____ |
| \$5 U.S. & Canada, \$10 Europe, \$15 elsewhere | |

Name _____
 Address _____
 City _____ State _____ Zip _____
 Country _____
 Phone (____) _____
 Payment by Check PO VISA MC
 Card # _____ Exp _____/_____
 B2

Horstmann Software Design Corporation
 140 E. San Carlos Street, Suite #200
 P.O. Box 5039, San Jose, CA 95150
 (408) 298-0828



horstmann software

CHAOS MANOR

Zenith's FTM monitor can be tuned so that the screen is absolutely black.

Borland Turbo BASIC is neat, a solid product well worth the price. Microsoft QB4 is that and more. It's a spectacular improvement not only on QB3, but also on BASIC in general. Highly recommended.

It's Flat!

I don't suppose anyone is happy with CGA. Everyone *wants* higher resolution and better graphics. Now we have several ways to get them.

The opening move was made by NEC when that company brought out the MultiSync, a monitor that works on anything from simple monochrome to the Professional Graphics Controller (PGC). I've had one of those attached to the Golem, the huge CompuPro system that practically runs Chaos Manor, for several years now, and it has given me yeoman service. It's also the test monitor when we get new video boards.

After the MultiSync came others, and for a while it looked as if multiple-sweep-frequency monitors were the wave of the future as more and more programs were written for the EGA standard.

Then Orchid, and later Zenith, came up with a new philosophy: instead of putting the smarts in the monitor, put them in the video board. That way you can get the best monitor you can afford, add a multiple-choice video board, and run programs that output monochrome, CGA, EGA, and PGC all on the same system without hassles.

Orchid chose to let its TurboPGA board run with any multiple-sweep-frequency monitor.

Zenith, long one of the industry leaders in monitor technology, had another approach. The company designed its board to run with its flat tension mask (FTM) monitor and made that monitor run on 31.5-kHz *analog* signals, while the board can digest anything from monochrome through VGA.

The result is pretty spectacular. The FTM monitor can be tuned so that the screen is absolutely black. Colors are just gorgeous; they really stand out against that black background.

Everyone who's come upstairs since I set up the FTM monitor with the Z-449 video board has been impressed. The colors are really striking. Oddly enough, though, most think the screen is concave.

That's an illusion; it really is flat, but we're so used to convex screens that bulge out at us that at first the ZCM-1490 FTM monitor really does appear concave. The illusion vanishes after you work with it awhile.

The ZCM-1490 has a 14-inch screen, but the images are so crisp that it appears bigger. It is certainly good enough to sit and work at all day. Larry Niven is about to buy a new computer system—I've recommended the new Zenith Z-386—and he very much likes my Electrohome Color Display ECM 19 (19-inch multiple-sync monitor). Before I let him spend the money, though, I'm going to have him look at the ZCM-1490. He may get the Electrohome monitor anyway, but then, he can afford it.

The highest resolution from the Zenith Z-449 video board isn't as sharp as the best from the Orchid TurboPGA, but it's close.

I had the traditional problems with the Zenith manuals, trying to figure out the switch settings; the board didn't come with the right defaults, and when I first powered things up, it wouldn't automatically switch from EGA to CGA, so that CGA was squished into two images on the screen. Fifteen minutes spelunking the Z-449 manual fixed that, and now everything works fine.

There is one problem with the ZCM-1490 monitor: it doesn't have a degaussing button. Both my Electrohome and Intecolor high-resolution monitors have that feature, and the ZCM-1490 needs it.

If you leave the monitor on long enough, especially in an electronically noisy environment (such as next to the Z-248 with its cover off), ugly patches in inappropriate colors appear on-screen. They're easily removed by turning the monitor (but not the computer) off for 30 seconds to a minute. This won't happen more than once a day. Degaussing takes about 10 seconds on my other monitors, so the time loss isn't significant; but I do wish Zenith had put the degaussing feature into the monitor.

Other than that, I love it. So will you, when you get used to having a screen that looks concave.

The Year's Most Useful

It's time for my annual awards. Do understand: these are purely subjective, and they're from Pournelle, not from BYTE. The ground rules are simple: something I acquired this year (no matter when it first came out), used a lot, and found to be the most useful thing in its class.

First, the Year's Most Useful Computer: the Kaypro 386 wins by a land-

continued

How to get a top quality, U.S. made IBM compatible without spending a bundle...

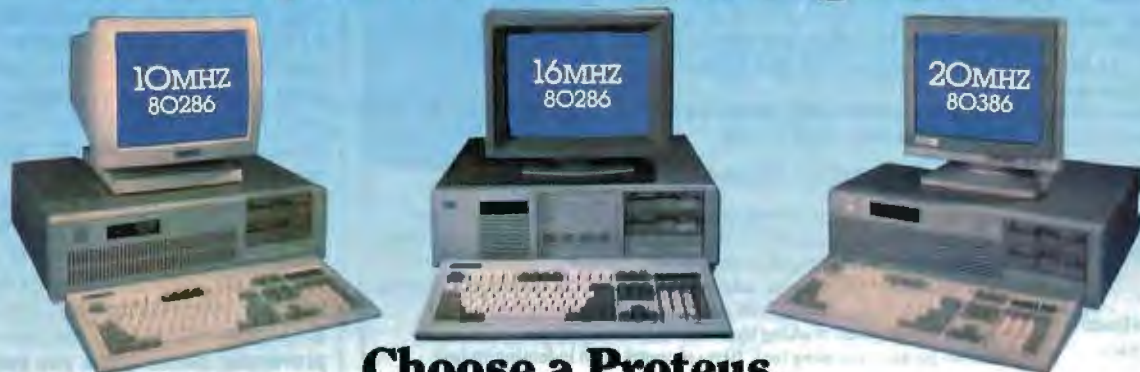

Choose a Proteus.

When you choose a Proteus, you get a lot more than just high performance at a low price. You get personal service that helps you custom tailor a system which is just right for your specific applications from our large stock of brand name hard disks, graphics boards monitors and other add-ons.

Easy Setup

When you get your new Proteus system you can have it up and running in no time. No need to spend hours, or even days, to get it to work. It comes with clearly written, easy to follow manuals, and on some models you even get built-in, ROM based, menu driven set-up, diagnostic, and utility software.

Money Back Guarantee

We're determined that you will be fully satisfied with your purchase. Use the system for a while, and if you don't like it, or any part, simply return it for a full refund - any time during the first thirty days.

15 Month Warranty

Everything you buy from us is backed by a full fifteen month warranty.

Service Wherever and Whenever You Need It.

In the rare case that something goes wrong with your Proteus system while it is still under warranty, we provide free repair at your location during the crucial first two months. No need ever to pack it up and ship

it anywhere. If the unit has exceeded the warranty period, you can still get factory authorized service, on site, at reasonable rates.

Problems at 3 a.m.?

You may be able to solve them yourself with our unique 24-hour on-line interactive support system, which is always free of charge.

There are many reasons for owning a Proteus. The experts think so too.

In a recent AT compatible product comparison, *Infoworld* (4/87) stated "...for overall best machine in power, the Proteus 286 is the clear winner. It offered the best CPU and hard disk random read/write performance of any machines tested, is remarkably easy to set up, and boasts the best support around. We recommend it."

EDITOR'S CHOICE

"...There are so many nice aspects to Proteus and the company that makes it, there isn't room to cover them all."

Business Computer Digest (3/87)

PROTEUS SYSTEMS

MODELS	286E	286F	286TX	386A
INTEL CPU	80286 10	80286 10	80286 12	80386
CLOCK SPEED	6/10MHz	6/10MHz	6/12MHz	6/10MHz opt. 20MHz
NORTON SI	10.1	11.5	15.5	23.5 opt. 33.6
BASE MEMORY	1024K	1024K	1024K	1024K to 4MB
WAIT STATES	ONE	ZERO	ZERO	ZERO
KRD SELECT SPEEDS	NO	YES	YES	YES
CLOCK, CAL-BATTERY ONBD	YES	YES	YES	YES
COPROCESSOR SOCKET	80287	80287	80287	80287/287
SERIAL PORTS	TWO	TWO	TWO	TWO
PARALLEL PORT	ONE	ONE	ONE	ONE
DO SLOTS	EIGHT	EIGHT	EIGHT	EIGHT
HARD DISK-FD CONTROLLER	YES	YES	YES	YES
FLOPPY DISKS	1.2MB	1.2MB	1.2MB	1.2MB
300K OR 1.5" FD CHOICE	YES	YES	YES	YES
KEYBOARD TYPE	84 KEY	84 KEY	101 KEY	101 KEY
FREE CUSTOMER SITE SERVICE	YES	YES	YES	YES
SYSTEM PRICE	\$1295	\$1495	\$1750	\$2395

HARD DISKS: Seagate, Minicrabe, Priate starting \$279
 MONITORS: High Res. Monochrome, Color, EGA from \$189
 ADD-ONS: EGA/CGA Mono Cards from \$89
 MEMORY EXPANSION: from \$65
 MODEMS: 300/1200/2400 from \$119
 Quantity discounts available. University and corporate 10% accepted. Payment methods: Charge card, personal, COD, terms upon approval. All prices, conditions, specs are subject to change. All trademarks registered.

TO ORDER OR FOR INFORMATION CALL TOLL FREE 1-(800) 782-8387.
 ELECTRONIC CATALOG DIAL 201-288-8577 (1200B/8/N.)

*IN NJ (201) 288-8829 Telex 510-601-0860 377 Rt. 17, Airport 17 Center
 All other calls (201) 288-8828 Hasbrouck Heights, NJ 07604

proteus
 The Intelligent Conclusion

"Proteus 386A is an excellent value by a country mile..." Info World 11/87

Even More Power & Flexibility

BRIEF 2.0

BRIEF easily conforms to your editing preferences and style, ensuring you are truly comfortable and productive.

Straight from the box, BRIEF is as much editor as most people will ever need — thanks to features like the real Undo, flexible windowing, and unlimited file size.

But BRIEF's hidden power is in its exclusive macro language. Customize BRIEF to include the commands and features YOU desire. It's fast and easy.

Users and industry press alike unanimously praise BRIEF. "Recommended." — Jerry Pournelle, Byte 12/86.

Now BRIEF 2.0 adds:

- Basic Features**
- Setup Program for easy installation and configuration. (Requires no macro knowledge).
 - Increased speed for sophisticated operations like Undo and Regular Expression Search.
 - All new documentation WITH tutorial on the Macro Language.
 - Command line editing (move cursor, add & delete characters, specify parameters).
 - Expanded Regular Expressions, with matching over line boundaries.
 - More block types, with marking by character, line or column.
 - Reconfigurable indenting for C files (supports most indenting styles)
 - Enhanced large display support, including wider displays.
 - Optional borderless windows.

Try BRIEF (\$195) for 30 days — if not satisfied get a full refund.

If you already own BRIEF, call for update info.

CALL 800-821-2492

In MA 617-337-6963

**Solution
Systems**

341 Main Street, Suite 410B
So Weymouth, MA 02190

Requires an IBM PC, AT or compatible with 192K.

And much, much more!

CHAOS MANOR

slide. It isn't that the Kaypro is all that much better than other 386 machines; indeed, Kaypro has completely upgraded its 386 line so that the Kaypro 386 you can buy now is much better than the one I have. The important thing, though, is the 386, which is to the 286 what the 286 is to a CP/M 64K-byte 8080 system. I'm very fond of my Zenith Z-248, which is as good an AT system as I know of; but it can't match a 386 for utility. Fortunately for Z-248 owners, Zenith recently announced a 386 upgrade kit.

One reason 386s are so superior is DESQview 2.01, which wins my award for the Most Useful Software of the Year. DESQview will greatly improve a 286 machine provided that you have an AST RAMPAGE AT board; but the *real* improvement comes when you run DESQview with a 386. DESQview and the Kaypro 386 haven't quite solved all my problems—I still want more memory-resident programs than the system will handle—but it beats everything else I've tried, and I've tried a lot of things. Learning DESQview is no trivial task, but it has been a lot more than worth it to me. It doesn't hurt that the people at Quarterdeck pay a lot of attention to bug reports and fix things fast.

The Most Useful Portable is the Zenith Z-183 with hard disk drive, and although at 15½ pounds it's too heavy by half, I wouldn't be without it. The supertwist backlit screen is readable in any light, the machine is rugged as all get-out, and the keyboard is wonderful; I've written a couple of hundred thousand words on that machine this year. I showed the machine to my friend Norman Spinrad, and he decided to get one to serve as his only computer. The Z-183 has EGA video output he's feeding into a Zenith EGA monitor, and he got a DataDesk Turbo-101 (101-key) keyboard: there's an input jack for that on the Z-183.

I don't know what the category is, but DataDesk keyboards have been about as useful as anything I've gotten this year. I now have Turbo-101 keyboards on just about every machine in the house—including the Macintosh Plus. The Mac version of the Turbo-101 comes with some nifty software to define function keys and the like. I've had several people do double takes when they see what looks like an AT keyboard attached to my Mac, and the notion of function keys on a Mac startles just about everyone.

The Most Useful Software for Portables is LapLink, which transfers programs from desktop to portables and back. It's painless and extremely fast, and if you have a PCompatible portable, you simply can't afford to be without it.

continued

New! Hire a Pro for Your New Turbo 4.0

Turn on the power of Turbo PROFESSIONAL 4.0, a library of more than 300 state-of-the-art routines optimized for Turbo Pascal 4.0. You'll have professional quality programs finished faster and easier.

Turbo PROFESSIONAL 4.0 includes complete source code, comprehensive documentation and demo programs that are powerful and useful. The routines include:

- Pop-up resident routines
- BCD arithmetic
- Virtual windows and menus
- EMS and extended memory access
- Long strings, large arrays, macros, and much more.

Turbo PROFESSIONAL is only \$99.

Call toll free for credit card orders.

1-800-538-8157 extension 830

1-800-672-3470 extension 830 in CA

Satisfaction Guaranteed or your money back within 30 days.

Turbo Pascal 4.0 is required. Registered owners of Turbo Professional by Sunny Hill Software may upgrade for \$30. Include your serial number.

For other information call 408-438-3608, 9 AM to 5 PM PST. Shipping & taxes prepaid for US and Canadian customers, others please add \$6 per item.

TURBO
Power

TurboPower Software 3109 Scotts Valley Dr., Suite 122 Scotts Valley, CA 95066

IDEAS TRANSLATE



LIKE YOU IMAGINE

TYPESET & MANUALS,
books FORMULAS & TABLES

in the same → **FORMAT** | **or** | **differEnt** **ONES**

BIG **or SMALL** **WIDE** **or NARROW** **LIGHT** **or BOLD** **IT'S NICE TO KNOW**
pcTeX **WON'T** **LIMIT** **YOUR**
IMAGINATION.

WITH

PERSONAL

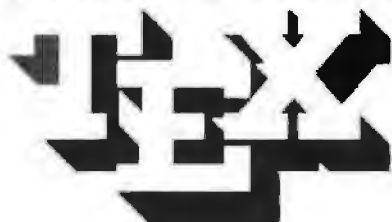

INC

To order or for information, call:

415/388-8853

or write: Personal TEX, Inc.
12 Madrona Avenue
Mill Valley, CA 94941 USA

Distributed in 14 countries;
distributor inquiries welcome

pcTeX is a registered TM of Personal TEX, Inc.
TEX is an American Mathematical Society TM
Manufacturers' product names are their TMs.

pcTeX FORMATTING/TYPESSETTING SYSTEM:

FINE TYPESET QUALITY from dot matrix or laser printers, or phototypesetters

A COMPLETE PRODUCT. Includes • our specially written pcTeX Manual that lets you use TEX immediately • custom 'macro package' formats for letters, manuals, technical documents, etc • the LaTeX document preparation system (with user's manual) macro package for article, book, report preparation • AMS-TEX, developed by the American Mathematical Society for professional mathematical typesetting

OUTPUT DEVICE DRIVERS for • Epson FX, LD • Toshiba • Cordata LP-300 Series • HP LaserJet Series • Apple LaserWriter • APS-5 phototypesetter • Linotronic • Compugraphic • Screen preview, with EGA or Hercules card

REQUIRES: IBM PC/XT, AT or compatible, DOS 2.0 or higher & 512K RAM hard disk for printer drivers & fonts

(Also available: Printer drivers, interfaces to Bitstream Fontware, Metafont, to design-your-own-type, PC Paintbrush PC Palette, FancyFont & Fontex. Complete packages, including laser printer, printer driver, pcTeX and screen previewer from \$2850. Site licenses and volume discounts available.)

Great ideas should look great on paper. And the translation is easy with pcTeX®: the best-selling full implementation of Prof. D. Knuth's revolutionary TEX formatting/typesetting program. It offers PC users the capabilities & advantages—and looks—of professional typesetting.

In a word, pcTeX gives you 'control'. Control—of design format, type & symbols, quality—for complex mathematical & engineering material, statistical tables or straight matter. You get camera/publisher-ready manuscripts to be proud of, quick & simple.

So whether you're writing the next starshot manual, a thesis on relativity or the great American novel, for a professional presentation that doesn't lose your ideas in the translation, depend on pcTeX.

From Personal TEX, Inc., starting at \$249; VISA/MC welcome. Satisfaction guaranteed.

This ad is typeset & composed using pcTeX Bitstream® fonts & laser printer. Logotype & black backgrounds done photographically.

ENCLOSURES & POWER SUPPLIES

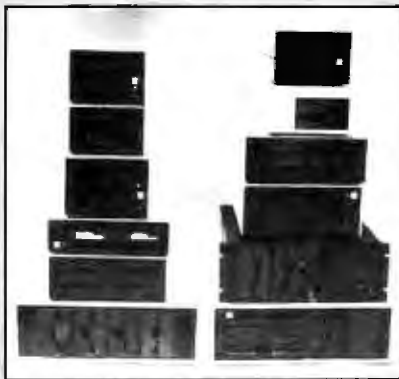

for FLOPPY WINCHESTER TAPE DRIVES

from \$100

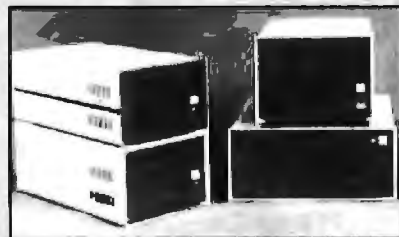

for SINGLE BOARD COMPUTERS

from \$125



for IBM & S-100 SYSTEMS from \$200

*1 piece, prices lower in quantity
(Disk drives not included)

Call or write for free catalog

INTEGRAND

RESEARCH CORP.

8620 Roosevelt Ave. • Visalia, CA 93291
209/651-1203

TELEX 5106012930 (INTEGRAND UD)

IBM and International Business Machines

CHAOS MANOR

Items Discussed

Color Display ECM 1910.....	\$2795	My Word!	\$49
Electrohome Ltd. 809 Wellington St. N Kitchener, Ontario Canada N2G 4J6 (519) 744-7111 Inquiry 901.		T.N.T. Software Inc. 34069 Hainesville Rd. Round Lake, IL 60073 (312) 223-0832 Inquiry 905.	
Fontasy.....	\$69.95	QuickBASIC 4.0	\$99
Prosoft 7248 Bellaire Ave. P.O. Box 560 North Hollywood, CA 91603-0560 (800) 824-7888 (818) 765-4444 Inquiry 902.		Microsoft Corp. 16011 Northeast 36th Way P.O. Box 97017 Redmond, WA 98073-9717 (800) 426-9400 (206) 882-8080 Inquiry 906.	
Megatrend EGA version	\$1895	Turbo BASIC.....	\$99.95
Intecolor Corp. 225 Technology Park Norcross, GA 30092 (404) 449-5961 Inquiry 903.		Borland International 4585 Scotts Valley Dr. Scotts Valley, CA 95066 (408) 438-8400 Inquiry 907.	
MultiSync II.....	\$899	TurboPGA	\$1599
Plus.....	\$1395	Orchid Technology 45365 Northport Loop W Fremont, CA 94538 (415) 490-8586 Inquiry 908.	
XL.....	\$3195	ZCM-1490.....	\$999
NEC Home Electronics (U.S.A.) Inc. Computer Products Division 1255 Michael Dr. Wood Dale, IL 60191 (800) 323-1728 (312) 860-9500 Inquiry 904.		Z-449	\$499
		Z-386	\$6499
		Zenith Data Systems 1000 Milwaukee Ave. Glenview, IL 60025 (312) 699-4800 Inquiry 909.	

The Most Useful Writer's Tool is the Amdex Laserdrive/Microsoft Bookshelf CD-ROM package. Putting all those reference works on a single CD-ROM was a stroke of genius. I predict that within 5 years, professional writers will find Microsoft Bookshelf—or a similar CD-ROM reference library—as indispensable as we now find word processors.

Probably the most subjective award of the lot is the Text Editor of the Year. Writers don't just use editor programs, they have relationships with them. I've certainly had my ups and downs with mine; but the winner this year is Q&A Write, which, despite its faults, is the most transparent editor for text creation I've tried. XyWrite III Plus, WordPerfect 4.2, and Microsoft Word 4.0 are close competitors, and each has features that put it ahead of Q&A Write in some areas; but on balance I found Q&A Write clearly ahead in the critical particulars.

Fair warning: Gordon Eubanks and Brett Walters of Symantec have been extremely responsive to my suggestions, so that in part Q&A Write has been modified to suit my fancies. They've added a splendid word/line/paragraph count command, they're changing some of the print features, and they're doing some other stuff I wanted, including making it work well with Microsoft Bookshelf. It would be surprising if I didn't consider this my favorite text editor.

Any serious computer user needs not only a text-creation editor, but a programming and general-purpose editor: something to use to alter CONFIG.SYS and AUTOEXEC.BAT and that sort of thing. The General-Purpose Editor of the Year is Logitech's Point. This comes with the Plus Package, as well as with the Publisher Package, both of which include the Logitech Mouse. I'm fond of the Logi-

continued



They Won't Run Right On The Wrong Fuel.

Low grade or dirty fuel reduces performance cars to bucking, knocking clunkers.

Computers are no different. The fact is, both machines have very specific fuel requirements. But when running right, they perform like the wind.

Refined Electricity Increases Computer Performance.

Think of an Emerson power system as your computer's own private fuel refinery. Crude electricity goes in one end; premium comes out the other.

Like good car fuel, Emerson premium electricity burns clean. No spikes, surges, sags, glitches or outages. Just refined power that puts system performance and throughput back where it was promised.

Emerson power keeps your computers and your people on the job working — even when power is completely cut off.

How To Lower Shocking Downtime Costs.

Computer components aren't designed to last forever. But their cause of death is far more likely to be poisoning than old age. Everyday short-burst electrical

fluctuations assault delicate computer circuits right under your nose. They leave no trace. Not even the flicker of a light bulb to warn you.

With each assault, a computer failure comes that much closer.

But your real costs are in idled people and lost productivity.

Emerson's premium electric power not only solves this, it protects the work your employees have already done. If this work is important to you, it alone can pay for your Emerson system in a single day.

You Need A Powerhouse Of A Company.

Emerson Electric is a major Fortune 500 corporation with more computer power protection

systems installed worldwide than anybody.

Our systems are more reliable, simpler, and easier to operate and maintain because each year we put more in R&D than much of our competition has in assets.

It pays off for you in failure-free operation that actual experience shows can exceed one million hours on the job. So your Emerson system will keep providing power on the next computers you buy. And the next.

Our products cover the gamut. Uninterruptible Power Supplies (UPS) for large mainframes to handsome, compact, inexpensive ones for your minis and PC's.

We also have a full line of power conditioning and distribution systems. Even simple surge protectors. Whatever level of protection you need, Emerson has it.

Increase the productivity of your system. Simply call 1-800-BACK-UPS for our free introductory brochure and the name of your local representative.



EMERSON
Computer Power

3300 S. Standard St.
Santa Ana, CA 92702

★ "Jerry's Choice" ★ Awards for 1987 ★

★ Most Useful Computer:

Kaypro 386 \$3995
 Kaypro Corp.
 533 Stevens Ave.
 Solana Beach, CA 92075
 (619) 481-4300
Inquiry 910.

★ Most Useful Software:

DESQview 2.01 \$129.95
 Quarterdeck Office Systems
 150 Pico Blvd.
 Santa Monica, CA 90405
 (213) 392-9701
Inquiry 911.

★ Most Useful Portable:

Zenith Z-183 \$3199
 Zenith Data Systems
 1000 Milwaukee Ave.
 Glenview, IL 60025
 (312) 699-4800
Inquiry 912.

★ Most Useful Software for Portables:

LapLink \$139.95
 Traveling Software
 19310 North Creek Parkway
 Bothell, WA 98011
 (800) 343-8080
 (206) 483-8088
Inquiry 913.

★ Most Useful Something:

**Turbo-101
Enhanced Keyboard** \$149.95
 DataDesk International
 7650 Haskell Ave.
 Van Nuys, CA 91406
 (818) 780-1673
Inquiry 914.

★ Most Useful Writer's Tool:

Amdek Laserdrive \$995
 Amdek
 1901 Zanker Rd.
 San Jose, CA 95112
 (408) 436-8570
Inquiry 915.

**Microsoft
Bookshelf CD-ROM** \$295
 Microsoft Corp.
 16011 Northeast 36th Way
 P.O. Box 97017
 Redmond, WA 98073-9717
 (800) 426-9400
 (206) 882-8080
Inquiry 916.

★ Text Editor of the Year:

Q&A Write \$199
 Symantec Corp.
 10201 Torre Ave.
 Cupertino, CA 95014
 (408) 253-9600
Inquiry 917.

Runners-up:

XyWrite III Plus \$445
 XyQuest Inc.
 44 Manning Rd.
 Billerica, MA 01821
 (617) 671-0888
Inquiry 918.

WordPerfect 4.2 \$495
 WordPerfect Corp.
 288 West Center St.
 Orem, UT 84057
 (801) 225-5000
Inquiry 919.

Microsoft Word 4.0 \$450
 Microsoft Corp.
 16011 Northeast 36th Way
 P.O. Box 97017-9717
 Redmond, WA 98073
 (800) 426-9400
 (206) 882-8080
Inquiry 920.

★ General-Purpose Editor of the Year:

Point, which comes bundled with the **Logitech Mouse** in the following packages:
Plus Package \$119
Publisher Package \$179
 Logitech Inc.
 6505 Kaiser Dr.
 Fremont, CA 94555
 (415) 795-8500
Inquiry 921.

★ Game of the Year:

Wizard's Crown \$39.95
 Strategic Simulations
 1046 North Rengsdorf Ave.
 Mountain View, CA 94043
 (415) 964-1353
Inquiry 922.

Runner-up:

Strategic Conquest Plus \$59.95
 PBI Software Inc.
 1163 Triton Dr.
 Foster City, CA 94404
 (415) 349-8765
Inquiry 923.

tech 3-button mouse anyway; the neat part is that when you buy the mouse, you get some really useful software as well.

The Game of the Year is Wizard's Crown from Strategic Simulations. It's certainly the one I've spent the most time with. A close runner-up is Strategic Conquest Plus for the Macintosh. They're both pleasant ways to waste more time than I have available.

No More Eyestrain

The problem with naming the "thing of the year" is that a lot of good stuff doesn't fall into neat categories, and sometimes

you can't pick just one. For example: 1987 was the year I finally solved my eye problems. First, I got an EGA board and the Intecolor Megatrend 19-inch EGA color monitor. That was more than good enough; indeed, when Larry Niven buys his new computer, he's going to get a 386 system, an EGA card, and either the Intecolor Megatrend or the Electrohome monitor.

Next, I installed the Orchid TurboPGA board and the Electrohome 19-inch multiple-sync color monitor. The Electrohome is perhaps not quite as crisp in EGA mode as the Megatrend, but it's

hard to tell the difference; and, of course, this combination will perform with software that outputs monochrome, Hercules, CGA, EGA, and PGC, all more or less automatically. The PGC graphics are amazingly good.

Now we have the Zenith Z-449 board and Zenith's 14-inch ZCM-1490 FTM monitor. For years, I've been saying that 19 inches is just a tad large and 13-inch monitors are too small. My first monitor was a 15-inch Hitachi monochrome for my CP/M system; I'd have thought a 14-inch monitor would be too small, but the Zenith 14-inch isn't. Combined with my

new computer glasses—focal length 28 inches—I can see that screen fine.

I'll stick with the 19-inch because when Niven and I work together, it's handy if we can both see the screen from a distance; but the 14-inch Zenith would really be good enough. So how do I pick a "year's best" out of that group? I'm not going to try. I'll just say that if you do much writing with computers, any one of these will help you a lot. You can't be too kind to your eyes.

Fair Warning

Every now and again I see computers—usually offshore-constructed clones—run at amazing speeds, but when I look inside, the critical parts are ordinary chips. "We select the good ones," one exhibitor told me at COMDEX. "Try a lot until we find parts that work."

That sounds right, but it isn't, at least not in the case of Intel chips. I've been talking to a former Intel designer, and he tells me that Intel has very elaborate test equipment.

When Intel makes a batch of expensive parts—say, 386 or 387 chips—they're put into the automated test setup and run at the highest possible speed. Most of them fail those tests; the few that pass are then

certified for that speed and sold at a premium.

The rest of the parts are tested again at lower speeds. Those that pass get certified; the others are tested at still lower speeds and become the "ordinary" stock. A few don't pass tests at even the minimum speed and are discarded.

The point is, every "ordinary" chip Intel sells has *failed a test* at higher speeds. That's guaranteed. The failure the part experienced may not be critical. Intel has excellent test equipment and can find failures that may never show up in ordinary use—but how could you know what the failure was? It might be in a little-used area, but even little-used features can be critical. So while it's fun to crank up the speed on your system, it's guaranteed that if you run Intel parts much above their certified speed, you'll get failures. Murphy's law will take care of the rest.

Winding Down

As usual, I'm out of space long before I have run out of material. I spent the day installing an AST RAMPage board in the Zenith Z-248 so I could run DESQview. It all works, but I sure learned a lot. Then too, from here I can see Paradox and Condor, two relational databases; Quat-

tro, Borland's new spreadsheet; a bunch of communications programs; stacks of stuff for the Macintosh; Turbo Tax for the IBM PC; and a partridge in a pear tree. There are also two large Federal Express boxes from BYTE in New Hampshire.

The most important package, though, is a new Unix system for the AT&T PC 6300 Plus. I want to compare it to OS/2. I've never been a great Unix fan because Unix is big and slow and takes up so much room on a hard disk—18 megabytes for the on-line manuals alone—but OS/2 seems no smaller or faster, while hard disk capacity per dollar has grown so fast that 100-megabyte systems will soon cost less than OS/2.

With luck, I'll know more about that next time. ■

Jerry Pournelle welcomes readers' comments and opinions. Send a self-addressed, stamped envelope to Jerry Pournelle, c/o BYTE, One Phoenix Mill Lane, Peterborough, NH 03458. Please put your address on the letter as well as on the envelope. Due to the high volume of letters, Jerry cannot guarantee a personal reply. You can also contact him on BIX as "jerryip."

Travel Companions.



The WorldPort 2400™ and the WorldPort 1200™ modems are the perfect travel companions for your portable computer. They work virtually anywhere in the world, including hotel rooms and phone booths, allowing you to connect in a few million more locations than other modems.

With features superior to internal units, the WorldPort line of modems is the smart choice for all your communication needs. WorldPort modems operate from their own

internal battery, drawing no power from your laptop. Cutting edge technology brings you features such as Bell and CCITT standards, direct connect and acoustic interface (300 and 1200 bps), tiny size and a tiny price. The WorldPort 1200™ can be easily upgraded to 2400 bps and both the WorldPort 2400™ and the upgrade come with Carbon Copy PLUS™ communications software.

Find out more about the travel companions that won't tie down your portable computer.

Call us today for more information about the WorldPort line of modems, or the name of your nearest dealer, at **800-541-0345** (In New York, 516-261-0423.)



Touchbase Systems, Inc.
160 Laurel Avenue
Northport, NY 11768
(516) 261-0423
TELEX: 6502848020
FAX: (516) 754-3491

WorldPort 1200 and WorldPort 2400 are trademarks of Touchbase Systems, Inc., Carbon Copy PLUS is a trademark of Meridian Technology Inc.





“It's 6:33 pm. The lines are down. And she's the closest thing I've got to a technician.

Meanwhile, I've got a sales guy here waiting to close a half-million-dollar deal, and he's screaming 'why didn't my order go through.' I have no clue. My technical staff is home watching the game. And all I keep thinking is whatever happened to that word reliability? If I could have anticipated the problem, at least I would have had a chance. As far as I'm concerned, somebody at headquarters better start talking to AT&T about getting a network management system. Or they can find themselves a new whipping boy.

AT&T comes through.”



AT&T DATAPHONE™ II Network Management System

There's no great mystery to improving your operating efficiencies. You just have to start with fail-proof data communications equipment. As follows.

AT&T's DATAPHONE II System Controller manages a fully integrated network of modems (analog, private line, switched network), multiplexers (statistical, T-1), and digital service units (switched, private line).

Networks of any size can be managed from a single point, so problems can be readily pinpointed and corrected.

Real-time diagnostics and re-routing help anticipate system failures and reduce downtime. Complete monitoring includes customized reports, menus and graphic displays that let you fine-tune your network.

To learn more, contact your AT&T Account Executive. Or call 1 800 247-1212 for the number of our office nearest you.

From equipment to networking, from computers to communications, AT&T is the right choice.

© 1988 AT&T



AT&T
The right choice.

New From Osborne/McGraw-Hill

The OS/2™ Books by The OS/2™ Experts

According to Bill Gates "Ed Iacobucci was a key architect... and made very important contributions. Ed is one of the few individuals who can explain the foundation that OS/2 will provide for the industry... what you will read here represents the real ideas behind the operating system and what can be done with it."

From the Foreword of
OS/2™ Programmer's Guide



OS/2™ Programmer's Guide

by Ed Iacobucci,
Leader of the IBM® OS/2 Design Team

Foreword by Bill Gates

Here are the techniques and insights on OS/2 version 1.0 that serious programmers need. Learn how and why the system works. Iacobucci discusses

- Dynamic linking and the system API
- Memory management in a protected environment
- OS/2 multi-tasking
- Advanced inter-process communications facilities
- The system I/O capabilities
- Session management, user interface, utilities, and more.

\$24.95, ISBN: 0-07-881300-X, 650 pages

Using OS/2™

by Kris Jamsa,
Author of the Bestseller
DOS: The Complete Reference

You'll get up to speed on OS/2 with Jamsa's expertise. This quick-paced guide covers fundamental to advanced concepts, illustrated with numerous examples and screen displays. You'll find details on

- Redirection of I/O
- System configuration
- Multi-tasking
- Similarities between DOS and OS/2
- A complete command reference with syntax charts that are unavailable elsewhere
- Tips for system configuration with analyses of configuration file entries

\$19.95, ISBN: 0-07-881306-9, 600 pages

Available at Fine Book Stores and Computer Stores Everywhere

Or Call Our Toll-Free Number 800-227-0900 (Outside California) 800-772-2531 (Inside California)
(Use Your Visa or MasterCard)

Available in Canada through McGraw-Hill Ryerson Ltd. Phone 416-293-1911



Osborne/McGraw-Hill
2600 Tenth Street
Berkeley, California 94710

Circle 192 on Reader Service Card

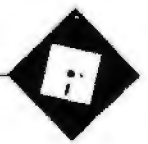

Annual Revelations

Ezra Shapiro

A plea for smarter computers, and Ezra's annual list of favorite things

In some ways, owning computers is like being a parent. I often find myself wishing my "children" had more memory, did their chores faster, and required less nagging. And I upgrade my system with add-ins, add-ons, and accessories with the same sinking feeling in the pit of my wallet that a parent experiences buying clothing for a rapidly growing infant.

I can't push this analogy too much further; I don't know a single family that sells off its kids every couple of years to buy new ones (though I've heard more than a few parents mutter wistfully that they'd like the opportunity to do so).

The frustration of computer ownership, however, is worse in one respect. There are at least some certainties to raising children; you know that in a predictable number of years, they'll grow out of infancy, out of adolescence, move away, and probably start cleaning up their own rooms. In contrast, I keep waiting for my machines to show signs of increasing maturity, but nothing seems to happen.

Once a year, I write a column that catalogs my own extremely personal choices in software and hardware, and this is the month for it. I strongly believe that confessing my prejudices provides a necessary foundation to the column; if you know I use WordStar, for example, you'll be able to take my dislike of some other word processors with a grain of salt.

As I began compiling my list, I noticed that although there have been major changes in my computing environment, the nature of the tools has changed very little in the past few years. Sure, everything has gotten faster and more powerful, but the systems have not gotten perceptibly smarter. I'm still telling my electronic children what to do in words of one syllable, and I'm still picking up after them.

So I offer the following challenge to the computer industry: You've proved that you can design systems that follow orders perfectly. Now give us systems that can

anticipate them.

Software that senses the presence of video boards and numeric coprocessors is a step in the right direction. So are natural-English query languages. But I want more.

I want a computer to say to me, "Ah. I see from the filename that you're writing your BYTE column. I'll just go ahead and load all the desk accessories you normally use for that." Or, "You seem to make typos involving transposed characters more frequently than other spelling mistakes, so I'll look for the transpositions first." Or, "When you set margins for your letterhead, the document almost always gets sent to the laser printer. Articles usually get sent as ASCII files via the modem. I'll just load the appropriate drivers for you."

To do this sort of thing today, I have to spend hours with installation and macro programs. I want my computers to be able to figure it out for themselves. I don't want to have to say a thing.

Right now, everyone is excited about adding graphics interfaces and programming languages to the environment, be it HyperCard or SQL. To me, that's just another way of phrasing the orders. Why not provide tools with some smarts? It's time to help the kids grow up.

The Soft Set

On the MS-DOS side of my computer table, I'm now using three word processors, so help me. For short documents, I'm back to WordStar, my old favorite. The upgrade to 4.0 convinced me to start using it again, and it's more than adequate for my basic needs. For longer pieces, or ones where I need computational or database operations, I'm still using Framework II. After 2 years of

Framework, it's comfortable—and as Mac-like as I need.

When I've got arcane manipulations to perform, I switch over to XyWrite III Plus. I was reluctant to try it, but it's the quickest of the three editors, extremely adept at block operations, and marvelously programmable. Even if I have to haul out the manuals, I find it easier to program XyWrite than to program Framework.

My set of memory-resident programs hasn't changed at all in the past 12 months. Aside from device drivers, I use Cruise Control, Revolution Software's magnificent program to optimize cursor speed and action depending on the foreground task; MemoryMate, Michael Fremont's free-form text database with a reminder tickler; and Ready!, the outliner from Living Videotext.

For big-league database functions, I like Borland's Reflex and Paradox. Reflex is great for analytical jobs, but it's limited to database files that fit in RAM. Paradox is the big guy for large projects. I've changed spreadsheets from Framework II to VP-Planner Plus. Now that VP-Planner is macro-compatible with Lotus 1-2-3 and features simplified menus, I'm satisfied with it. For telecommunications, I'm using Mirror II.

Over on the Mac, Microsoft Works is my primary writing tool, equipped with Lundeen & Associates' WorksPlus Spell and WorksPlus Command. WorksPlus Spell adds the best spelling checker I've ever used, and WorksPlus Command is a full macro environment—not only does it record and play back keystrokes and mouse movements, it also generates editable Pascal-like code.

continued

Ezra Shapiro is a consulting editor for BYTE. Contact him at P.O. Box 146069, San Francisco, CA 94114, or on BIX as "ezra." Because of the volume of mail he receives, Ezra, regrettably, cannot respond to each inquiry.

Items Discussed

- Cruise Control** \$29.95
 Revolution Software Inc.
 715 Route 10 E
 Randolph, NJ 07869
 (201) 366-4445
Inquiry 934.
- Desktop Express** \$149
 Dow Jones & Co. Inc.
 P.O. Box 300
 Princeton, NJ 08450
 (609) 452-2000
Inquiry 935.
- Excel (Mac)** \$395
Microsoft Works (Mac) \$295
 Microsoft Corp.
 16011 Northeast 36th Way
 P.O. Box 97017
 Redmond, WA 98073-9717
 (206) 882-8080
Inquiry 936.
- 4th Dimension** \$695
 Acius Inc.
 20300 Stevens Creek Blvd.
 Suite 495
 Cupertino, CA 95014
 (408) 252-4444
Inquiry 937.
- Framework II** \$695
 Ashton-Tate
 20101 Hamilton Ave.
 Torrance, CA 90502-1319
 (213) 329-8000
Inquiry 938.
- GraphicWorks 1.1** \$79.95
 Mindscape Inc.
 3444 Dundee Rd.
 Northbrook, IL 60062
 (312) 480-7667
Inquiry 939.
- MacCalligraphy** \$149.95
 Enzan-Hoshigumi (USA)
 P.O. Box 131
 Still River, MA 01467
 (617) 456-8255
 orders: (800) 962-6686
Inquiry 940.
- MemoryMate** \$69.95
 Broderbund Software Inc.
 17 Paul Dr.
 San Rafael, CA 94903
 (415) 492-3200
Inquiry 941.
- Microphone** \$149
 Software Ventures Corp.
 2907 Claremont Ave.
 Suite 220
 Berkeley, CA 94705
 (415) 644-3232
Inquiry 942.
- Mirror II** \$89.95
 SoftKlone Distributing Corp.
 1210 East Park Ave.
 Tallahassee, FL 32301
 (904) 878-8564
Inquiry 943.
- More** \$295
Ready! \$99
 Living Videotext Inc.
 2432 Charleston Rd.
 Mountain View, CA 94043
 (415) 964-6300
 in California: (800) 443-4310
 orders: (800) 822-3700
Inquiry 944.
- PageMaker** \$495
 Aldus Corp.
 411 First Ave. S
 Suite 200
 Seattle, WA 98104
 (206) 622-5500
Inquiry 945.
- Paradox 1.1** \$495
Reflex Plus (Mac) \$279
 Borland International
 4585 Scotts Valley Dr.
 Scotts Valley, CA 95066
 (408) 438-8400
Inquiry 946.
- PowerStation** \$59.95
Suitcase \$59.95
 Software Supply Inc.
 599 North Mathilda Ave.
 Suite 210
 Sunnyvale, CA 94086
 (408) 749-9311
Inquiry 947.
- QUED/M** \$119
 Paragon Concepts
 4954 Sun Valley Rd.
 Del Mar, CA 92014
 (619) 481-1477
Inquiry 948.
- QuicKey** \$99.95
 CE Software
 801 73rd St.
 Des Moines, IA 50312-1051
 (515) 224-1995
Inquiry 949.
- SuperGlue** \$89.95
**SmartScrap and
 The Clipper** \$59.95
 Solutions
 29 Main St.
 Montpelier, VT 05602
 (802) 229-0368
Inquiry 950.
- SuperPaint** \$149.95
 Silicon Beach Software Inc.
 9580 Black Mountain Rd., Suite E
 San Diego, CA 92126
 (619) 695-6956
Inquiry 951.
- TOPS/DOS (MS-DOS)** \$189
TOPS for the Macintosh \$189
**TOPS FlashCard (PC AppleTalk
 card)** \$239
 TOPS
 2560 Ninth St., Suite 220
 Berkeley, CA 94710
 (415) 549-5900
Inquiry 952.
- VP-Planner Plus** \$179.95
 Paperback Software International
 2830 Ninth St.
 Berkeley, CA 94710
 (415) 644-2116
Inquiry 953.
- WordStar Professional 4.0** \$395
 MicroPro International Corp.
 33 San Pablo Ave.
 San Rafael, CA 94903
 (415) 499-1200
Inquiry 954.
- WorksPlus Command** \$99.95
WorksPlus Spell \$59.95
 Lundeen & Associates
 P.O. Box 30038
 Oakland, CA 94604
 (415) 893-7587
Inquiry 851.
- XyWrite III Plus** \$395
 XyQuest Inc.
 44 Manning Rd.
 Billerica, MA 01821
 (617) 671-0888
Inquiry 852.

Occasionally, when I'm working with ASCII files, I'll shift over to QUED/M from Paragon Concepts, a nifty programmers' editor that implements the full Unix wild-card search system. I keep Microsoft Write around on the hard disk merely to convert MacWrite files into something usable.

My databases are in Reflex Plus, though I'm building an accounting system in 4th Dimension. Excel is the spreadsheet of choice. For graphics, I usually use SuperPaint, but I occasionally play with both MacCalligraphy and GraphicWorks. My favorite layout program is PageMaker 2.0a.

Communications are handled with Software Ventures' Microphone 1.1; I use Desktop Express from Dow Jones to communicate with MCI Mail. Is an outline conceivable without More from Living Videotext? Of course not. I'm also high on SuperGlue (the print-to-disk driver from Solutions), and I use SmartScrap and The Clipper, desk accessories from Solutions that simplify using graphics fragments in other programs.

In the past few months, I've picked up a number of new utilities for the Mac. Suitcase lets me cram my menus with far more desk accessories and fonts than

Apple allows. PowerStation is a Finder replacement that I find extremely useful in the confusing maze of windows generated by MultiFinder. Both are from Software Supply.

I've just purchased QuicKey, from CE Software, which lets me assign mouse movements, menu selections, and text to keyboard commands of my own choosing. I haven't worked with it long enough yet to tell if I really like it.

The Hard Set

There's been a lot of hardware activity in the past 12 months; 1987 was a year for replacements. My old Compaq portable made way for a Tandon PCA-40, a 286/EGA box with a 40-megabyte hard disk drive and a single high-density floppy disk drive. I've added a Logitech Bus Mouse and MicroSpeed's FastTRAP trackball device, and I switch between the two depending on mood. I'm being won over by the trackball, but since it uses my one lonely serial connector, I switch to the Bus Mouse when I know I'm going to need the port.

One of the Tandon's slots has an AST Premium RAMpage board, and another holds a TOPS FlashCard AppleTalk board. The Compaq lives on, by the way.

Since I haven't gotten around to installing a 360K-byte drive in the Tandon, I use the Compaq to format disks—a lowly fate for a machine that provided flawless performance for 2½ years of nearly continuous use, including 15 months spent running a bulletin board system.

The real excitement has occurred on the Macintosh side of my worktable. The Mac Plus and DataFrame 20 combo has been lent to a rabid computerphobe who was once forced to use MultiMate on an IBM PC XT. The Mac seems to be healing those deep scars; she's now sitting down at the computer *voluntarily*.

I'm using a new Macintosh SE with Apple's stock hard disk drive and an external Jasmine 160 drive. Less than a month after I purchased the computer, I ripped out the factory-installed memory and dropped in 4 megabytes of 120-ns Lightning single in-line memory modules. I also bought myself a Radius Accelerator 16 card, and it's wonderful.

I chose the Radius for two major reasons: price and convenience. At \$995, it's half the price of many other boards. And since I test software, it's often necessary for me to shut off the accelerator and deal with a stock SE. By holding

continued

The Complete 68000 C Compiler

The UniWare™ 68000 C Cross Compiler generates fully optimized code for your ROMable applications. It supports:

- * 68000
- * 68010
- * 68020
- * 68008
- * 68012
- * 68881

You won't find a more complete package — the UniWare 68000 C Compiler comes with a relocating macro assembler, type-checking linker, librarian, and all the utilities you need to put your program into ROM. And it's just \$995 under MS-DOS. Also available under UNIX.

CALL TODAY

(312) 971-8170

SOFTWARE DEVELOPMENT SYSTEMS, INC.
3110 Woodcreek Drive
Downers Grove, IL 60515

The Complete Z80 C Compiler

The UniWare™ Z80 C Cross Compiler generates fully optimized code for your ROMable applications. It supports:

- * Zilog Z80
- * Zilog Z180
- * Hitachi HD64180

You won't find a more complete package — the UniWare Z80 C Compiler comes with a relocating macro assembler, type-checking linker, librarian, and all the utilities you need to put your program into ROM. And it's just \$995 under MS-DOS. Also available under UNIX.

CALL TODAY

(312) 971-8170

SOFTWARE DEVELOPMENT SYSTEMS, INC.
3110 Woodcreek Drive
Downers Grove, IL 60515

The QMS has sold me on laser printers as the greatest thing since sliced bread.

down the mouse button on start-up, the Radius gives me the option of shutting off either the code cache, the data cache, or the whole thing.

Since the Mac itself is becoming a memory hog with MultiFinder and HyperCard, I also appreciate the fact that the card uses motherboard RAM. While it might not be as blazingly fast as accelerators with on-board memory, I didn't have to buy 4 megabytes of chips for both the 68000 and the 68020. I'll concede that other accelerators might be a hair faster, particularly for number crunching, but Radius gives me text scrolling so fast I can't make out the words as they fly by. In graphics programs, objects that used to jump slowly across the screen trying to keep up with the cursor now slide easily.

For printers, I have an Okidata Micro-

line 192, an Apple Imagewriter II, and a QMS-PS 800 laser printer. The Okidata is hooked to the Tandon, the Imagewriter II plugs into the Mac, and the QMS is on the TOPS network so both computers can have access. The Okidata has performed well for 2 1/2 years. The Imagewriter II is a recent addition, but a glance at the guts has convinced me it's the most solidly built printer I've ever owned. The QMS handles the bulk of the printing around here, and it's sold me on laser printers as the greatest thing since sliced bread.

The whole system is cabled together using TOPS networking software, the TOPS FlashCard in the Tandon, and PhoneNet connectors and wiring from Farallon.

Apology to Microsoft

In January, I attacked Microsoft for the inability of both Word 3.01 and Works 1.1 on the Macintosh to eliminate blank lines during a mail merge. I was half right. Word has problems, but Works does kill a blank line if it contains nothing but a null field. However, this feature is undocumented in both the original Works 1.0 manual and the pamphlet that accompanies the 1.1 update. According to Tim Lundeen, one of the authors of Works,

the documentation was frozen before the software was finished. Silly me to trust the manual! Sorry, Microsoft.

On the Right Track

My December column, in which I mentioned a digital control system for Märklin model trains, prompted a brief note from Richard F. Dermody, coordinator of the Computers in Model Railroading special interest group of the National Model Railroad Association. He writes, "I thought you might be interested in knowing that there are more than a few people with 'a passion for model railroading and computers' out there, as the hundreds of members in this special-interest group would indicate. 1988 will mark our seventh year of publishing a bi-monthly newsletter devoted to these two subjects. . . . There are also alternatives to the Märklin system, which unfortunately controls only Märklin trains of mostly European prototype, rather than the North American prototypes more commonly modeled in the U.S. and Canada."

If you send a stamped, self-addressed envelope, you can get further information about the group. Its address is NMRA CMR-SIG, 8431 Timber Glen, San Antonio, TX 78250-4416. ■



March Specials		Software Specials
AMARAY PS2 PRINTER STAND Universal design with paper tray . . .	\$19 ⁹⁵	MICRORIM CROSSTALK MARK IV Advanced communications. IBM . . .
AMIGA 5500 SYSTEM With Amiga color monitor . . .	\$839 ⁹⁵	MICROSOFT EXCEL Requires 1MB RAM and hard disk. IBM . . .
AMIGA 512K UPGRADE Gives you AMIG 5000 system 1MB RAM . . .	\$149 ⁹⁵	ASHTON-TATE dBase III+ Ultimate data base for IBM . . .
ATARI 520ST-FM COMPUTER Built-in 3.5" disk drive, monitor optional . . .	\$529 ⁹⁵	MICROPRO WORDSTAR 2000+ Word processor. IBM, V1.0 . . .
BORLAND QUATTRO For IBM and compatibles . . .	\$119 ⁹⁵	MERIDIAN CARBON COPY + For IBM and compatibles . . .
BORLAND TURBO BASIC Editor/compiler development . . .	\$59 ⁹⁵	BRODERBUND PRINT SHOP For IBM, Mac and Apple II series . . .
EPSON APEX80 DOT PRINTER 180 cps, NLQ mode, F/1, parallel . . .	\$199 ⁹⁵	ELECT. ARTS CHESSMASTER 2000 For IBM, Mac and Apple II . . .
EPSON FX86E DOT PRINTER 200 cps, F/1, parallel, graphics . . .	\$359 ⁹⁵	SOFTWARE PUB. FIRST PUBLISHER For IBM and compatibles . . .
EPSON LQ850 DOT PRINTER Letter quality, parallel/serial . . .	\$429 ⁹⁵	MICROSOFT QUICK C V1.0 Language development for IBM . . .
MACE UTILITIES For IBM and compatible systems . . .	\$59 ⁹⁵	ELECT. ARTS MAVIS BEACON Teaches typing for IBM, Altan ST . . .
MAGNAVOX 12" TTL MONITOR 613-green, 623-amber screen . . .	\$99 ⁹⁵	PROGRESSIVE SUPERBASE For IBM and compatibles . . .
OKIDATA 180 DOT PRINTER Parallel & Cammernote interfaces . . .	\$239 ⁹⁵	BATTERIES INC. INSTANT PAGES For IBM and compatibles . . .
ORANGE MICRO GRAPPLER C/MAC/65 Parallel, graphics interface . . .	\$69 ⁹⁵	ACTIVISION TERM PAPER WRITER Includes outline for IBM . . .
SEIKOSHA SK3000AI PRINTER 300 cps dot, IBM/Epson compatible . . .	\$449 ⁹⁵	WORD PERFECT Word processing for IBM, Amiga and ST . . .
SEIKOSHA SP1200AI PRINTER 120 cps dot, 25 cps NLQ . . .	\$179 ⁹⁵	GENERIC CADD V3.0 Dimension drawing software IBM . . .
TIMWORKS DOS-RX Disk and file utilities for IBM . . .	\$39 ⁹⁵	SPECTRUM HOLOBYTE FALCON For IBM and Macintosh . . .
WICO ANALOG JOYSTICK IBM XT/AT, Apple IIe/c/g . . .	\$29 ⁹⁵	TIMWORKS SWIFTAX 1987 New with 1987 revisions IBM . . .



Epson "Apex" PC Compatible Computer System	Blue Chip "PC" Compatible Computer
•Brand new ready-to-run system •512K RAM •Dual 360K floppy drives •Color monitor •Parallel and composite ports •DOS 3.2 •GW BASIC •First Choice software package	•512K expandable to 1MB RAM •Dual 360K floppy drives •Monochrome monitor and card •Enhanced keyboard •Parallel port •expandable
Sale Price \$919⁹⁵ List \$999	Sale Price \$619⁹⁵ List \$999

Brother Printers	Required Accessories
M1409 DOT MATRIX 180 cps/45 cps NLQ, F/tractor . . .	\$329 ⁹⁵
M1609 DOT MATRIX IBM/Epson compatible, 180 cps . . .	\$359 ⁹⁵
M1709 DOT MATRIX 240 cps 132-col, 24K buffer . . .	\$489 ⁹⁵
TWINWRITER DUAL HEAD wide body w/TF300 tractor . . .	\$999 ⁹⁵
CERTRON DD130 DISK HOLDER For 130 3.25" disks with lock . . .	\$16 ⁹⁵
CERTRON DD50 DISK CASE For 50 3.25" floppy disks . . .	\$9 ⁹⁵
ELEKTRO PACK 6100 6-outlet, surge/spike filter . . .	\$19 ⁹⁵
INLAND SPQSPL PROTECTOR 6-outlet, 1MB/8ft/surge/spike . . .	\$39 ⁹⁵

To Order Toll Free **800-221-8180** In New York, Alaska & Canada Call: (718) 417-3737

Dealer Inquiries Invited — Prices Effective Through March 31, 1988

HOW TO ORDER BY MAIL: SEND MONEY ORDER, CERTIFIED OR CASHIER'S CHECK, MASTERCARD, VISA or AMEX (include card number, Interbank No., expiration date and signature.) TO: J&R MUSIC WORLD, 59-50 QUEENS-MIDTOWN EXPRESSWAY, DEPARTMENT BHO388, MASPETH, NY 11378 DO NOT SEND CASH. Personal and business checks must clear our Authorization Center before processing. \$25 MINIMUM ORDER. Shipping, Handling & Insurance Charge is 5% of Total Order with a \$3.95 minimum. (Canadian Orders Add 15% Shipping, with a \$9.95 minimum charge.) For shipments by air, please double these charges. SORRY, NO C.O.D.'s. NEW YORK RESIDENTS PLEASE ADD SALES TAX. ALL MERCHANDISE SHIPPED BRAND NEW, FACTORY FRESH, AND 100% GUARANTEED. WE ARE NOT RESPONSIBLE FOR ANY TYPOGRAPHICAL ERRORS.

Enrich your writing style

At last! A program that enhances your writing style

Not copy protected

READABILITY (from Scandinavian PC Systems, Inc.) analyzes your writing style and shows you how to improve it. Some twenty displays show you just how readable your writing is.

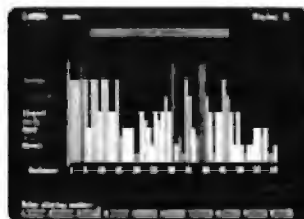

What's more, you can see which sentences deviate from the norm, and then decide whether to rewrite them or not.

Included with the program are finished analyses of a number of samples of good writing (by famous authors etc.). They help you to learn quickly how good writing should appear on the different diagrams.

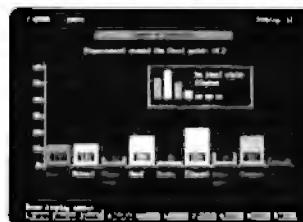

The *sentence diagram* presents the readability characteristics of your sentences, and tells you what percentages of your sentences are EASY, NORMAL and DIFFICULT.

The *word selection diagram* presents your ratio of everyday words to unusual words and tells you how much word-variety your writing incorporates.

The *word selection comments* pinpoint poorly selected words that you'll want to avoid in the future.

READABILITY also presents an *overall evaluation* of your writing by grading it on a 0-to 5 scale based on six highly relevant factors.

Finally, READABILITY summarizes the analysis by presenting and *overall review with proposals* for specific steps you can take to make your writing more readable.

Circle 296 on Reader Service Card

Textbook-style manual

An attractive, hard-cover textbook-style manual is included with READABILITY. This well-organized and easy-to-use manual tells you how to use READABILITY and explains how it functions.

PRICE
only \$
59.95



Scandinavian PC Systems, Inc. specializes in low-price programs that include carefully written textbook-style manuals which are in a class apart when it comes to user-friendliness. We believe that a manual is every bit as important as the program it supports. More than 50,000 copies of our programs have been sold in Europe.

Our other programs include: WORD PROCESSING, SPREADSHEET and DATABASE, each of which costs only \$ 49.95.

Easy as A B C

A

Write your letter, report, article or whatever it is you're working on using your regular word processor. Then convert to an ASCII file.

B

Load READABILITY and ask it to analyze your text. The results are ready in a jiffy.

C

Browse through the READABILITY displays to find out how readable your writing really is. READABILITY provides you with clear-cut advice on how to improve your writing style. Compare your results with those of your colleagues, or with a few paragraphs written by your favorite author or newspaper columnist.

READABILITY IN A NUTSHELL

The main *READABILITY diagram* presents a simple graph. By comparing its dispersement and focal point with nine analytical templates, you can grade your writing on a scale ranging from children's books to bureaucratic gobbledeygook.

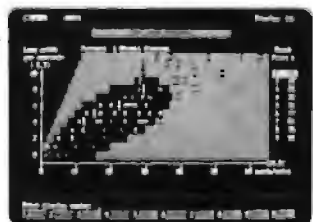

Scandinavian PC Systems, Inc.
3 Hraukside Park, Old Greenwich, CT 06870
Phone (203) 698-0823
Fax number (203) 698-0914

SCANDINAVIAN PC SYSTEMS

Scandinavian PC Systems, Inc.
54 Rodda Boulevard, Scarborough, Ontario
Canada M1E 2Z8
Phone (416) 674-4710

As your introduction to
The Library of Computer
and Information Sciences

Take Any 3 Books

(Publishers' prices shown)

DATABASE



85369 \$30.00



48441-2 \$38.95
(counts as 2 choices)

COMPUTER SCIENCE

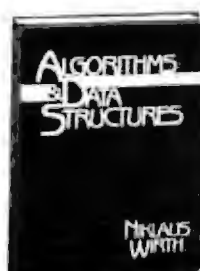

32490-2 \$37.33
(counts as 2 choices)



85623-2 \$34.95
(counts as 2 choices)



70796-2 \$36.95
(counts as 2 choices)

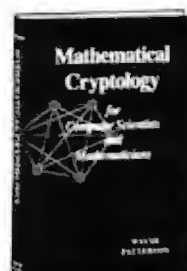

61000-2 \$37.50
(counts as 2 choices)

AI & ROBOTICS

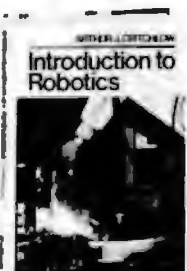

56283-2 \$35.95
(counts as 2 choices)

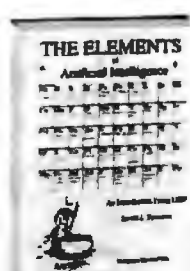

44177-2 \$37.95
(counts as 2 choices)

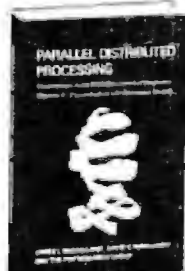

67116 \$27.50

DATA COMMUNICATIONS



41665-2 \$37.33
(counts as 2 choices)

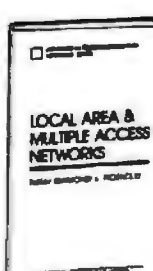

51917 \$19.95



78665-2 \$48.00
(counts as 2 choices)

MICROS



32269 \$22.95

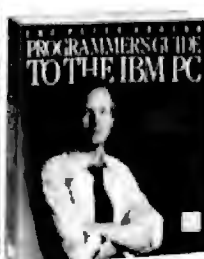

68430 \$19.95

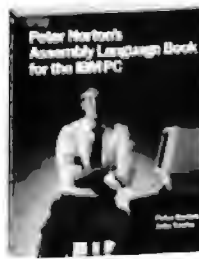

68427 \$21.95



84844 \$24.95

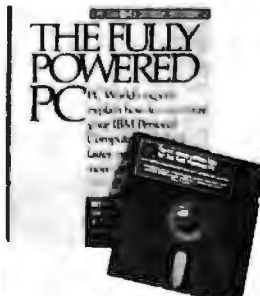

49273-2 \$39.95
(counts as 2 choices)

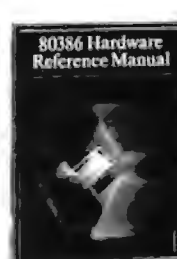

43970 \$25.00

PROFESSIONAL TOOLS



77620 \$25.00

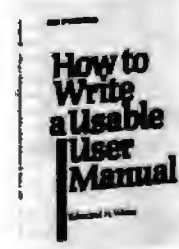

53920 \$14.95



60362 \$20.33

GRAPHICS



39477-2 \$59.00
(counts as 2 choices)



43935 \$24.95



39983-2 \$39.95
(counts as 2 choices)

for only \$1.00 Each

values
to
89.90

You simply agree to buy 3 more books—at handsome discounts—within the next 12 months.

IBM ENVIRONMENT



55022 \$25.95

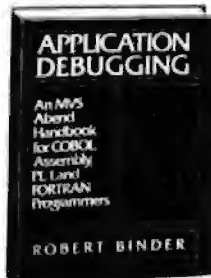

34134-2 \$39.95
(counts as 2 choices)



85700-2 \$32.95
(counts as 2 choices)



85943-2 \$32.95
(counts as 2 choices)



85945-2 \$32.95
(counts as 2 choices)

SOFTWARE DEVELOPMENT



52336-2 \$54.50
(counts as 2 choices)



41254 \$24.95

PROGRAMMING



69783-2 \$38.95
(counts as 2 choices)

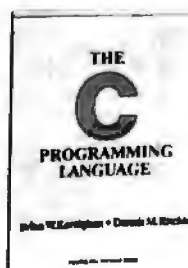

57206 \$26.67

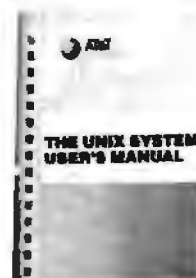

85379 \$29.95

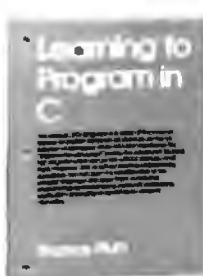

58088 \$25.00



85757 \$19.95



73870 \$25.00

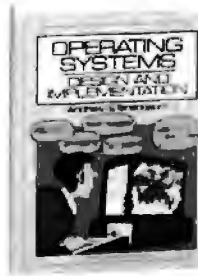

66004-2 \$36.95
(counts as 2 choices)

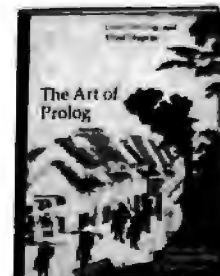

34422 \$29.95

4 Good Reasons to Join

1. The Finest Books. Of the hundreds of books submitted to us each year, only the very finest are selected and offered. Moreover, our books are always of equal quality to publishers' editions. *never* economy editions.

2. Big Savings. In addition to getting 3 books for only \$1.00 each when you join, you keep saving substantially, up to 30% and occasionally even more. (For example, your total savings as a trial member—including this introductory offer—can easily be over 50%. That's like getting every other book free!)

3. Bonus Books. Also, you will immediately become eligible to participate in our Bonus Book Plan, with savings of 65% off the publishers' prices.

4. Convenient Service. At 3-4 week intervals (16 times per year), you will receive the Library of Computer and Information Sciences News, describing the

Main Selection and Alternate Selections, together with a dated reply card. If you want the Main Selection, do nothing, and it will be sent to you automatically. If you prefer another selection, or no book at all, simply indicate your choice on the card and return it by the date specified. You will have at least 10 days to decide. If, because of late mail delivery of the News, you should receive a book you do not want, we guarantee return postage.

If reply card is missing, please write to The Library of Computer and Information Sciences, Dept. 7-ERG, Riverside, NJ, 08075, for membership information and an application.

Byte 3/88

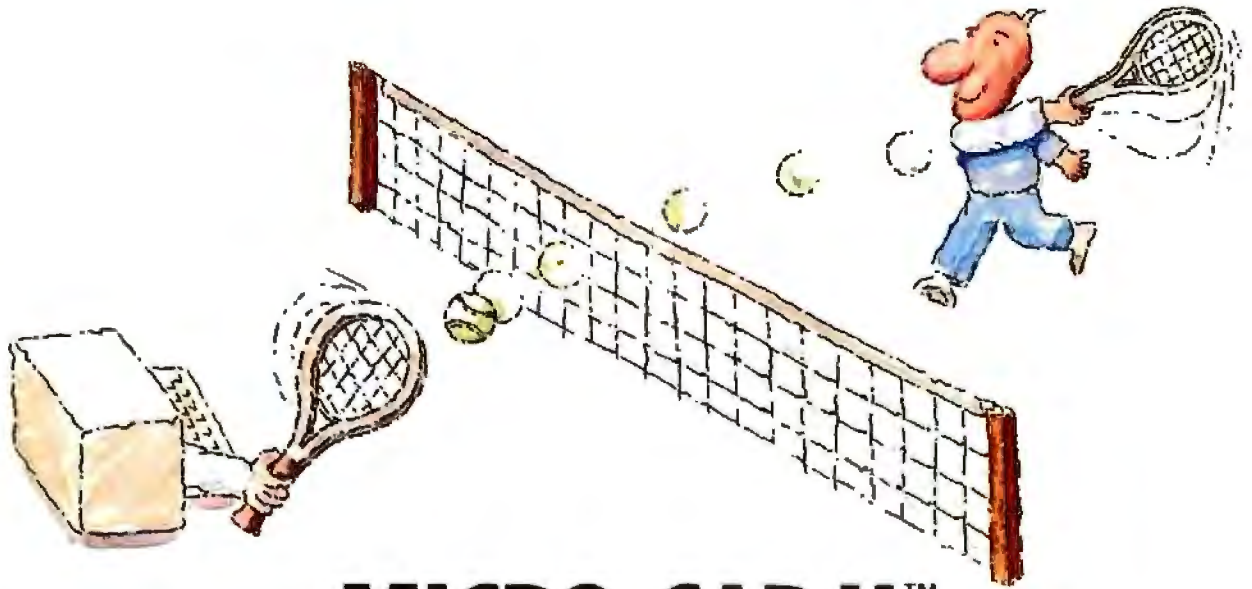

MICRO-CAP II.™

The CAE tool with fully interactive analog simulation for your PC.

Spectrum Software's MICRO-CAP II® is fast, powerful, and feature rich. This fully interactive, advanced electronic circuit analysis program helps engineers speed through analog problems right at their own PCs.

MICRO-CAP II, which is based on our original MICRO-CAP software, is a field-proven, second-generation program. But it's dramatically improved.



Schematic Editor

MICRO-CAP II has faster analysis routines. Better resolution and color. Larger libraries. All add up to a powerful, cost-effective CAE tool for your PC.

The program has a sophisticated integrated schematic editor with a pan capability. Just sketch and analyze. You can step

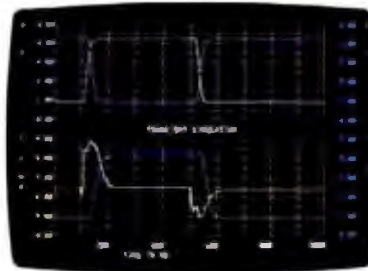

Transient Analysis

component values, and run worst-case scenarios—all interactively. And a 500-type* library of standard parts is at your fingertips for added flexibility.

MICRO-CAP II is available for IBM® PCs and Macintosh.™ The IBM version is CGA, EGA, and Hercules® compatible and costs only \$895 complete. An evaluation version is available for \$100. Call or write today for our free brochure and demo disk. We'd like to tell you more about analog solutions in the fast lane.

- Integrated schematic editor
- Fast analysis routines
- High-resolution graphic output
- Standard parts library of 500* types

*IBM versions only.

- Transient, AC, DC, and FFT routines
- Op-amp and switch models
- Spec-sheet-to-model converter*
- Printer and plotter* hard copy

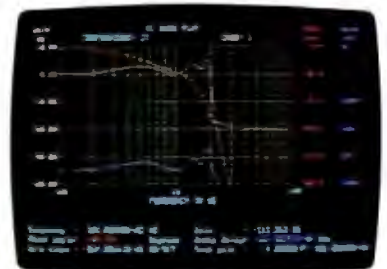

AC Analysis

Spectrum

1021 S. Wolfe Road, Dept. E
Sunnyvale, CA 94087
(408) 738-4387

MICRO-CAP II is a registered trademark of Spectrum Software.
Macintosh is a trademark of McIntosh Laboratory, Inc. and is being used with express permission of its owner.
Hercules is a registered trademark of Hercules Computer Technology.
IBM is a registered trademark of International Business Machines, Inc.

Floating-Point Processing

- 197 **Avoiding Coprocessor Bottlenecks**
by Mauro Bonomi
- 207 **Programming the 80387 Coprocessor**
by Prakash Chandra
- 217 **Floating-Point Survival Kit**
by Pete Wilson
- 229 **How to Get Better Floating-Point Results**
by Carl Byington
- 238 **Resource Guide**



Introduction

Floating-Point Processing

Numbers don't float, of course (although the wrong number can certainly *sink* a calculation), but our microcomputers perform arithmetic on numbers stored with a floating-point representation all the time. Efficient computing requires floating-point processing. Fixed-point arithmetic limits the range of the numbers being manipulated. It also adds to the complexity of the operation by demanding a great deal of scaling among numbers with different "implicit" radix points. So, floating-point arithmetic has become a modern-computing necessity.

Given that necessity, finding better ways to perform such math gains significance, particularly as microcomputers take on more demanding applications in real-time processing, CAD, and scientific computing. In the era of graphics-intensive applications, high-quality hardware and software assistance for floating point is paramount.

For example, the number of floating-point operations (FLOPs) needed to display a single graphics image can add up as follows: Compute 12,000 image points, 120,000 FLOPs; rotate and scale the image to complete its nonviewable side, 28 4-by-4 matrix transformations, 300,000 FLOPs; clip the image (to display only the viewable surfaces), 72,000 FLOPs; convert coordinates to integers for pixel mapping, 130,000 FLOPs; shading and light source calculations, 360,000 FLOPs; interpolation of unplotted points, 300,000 FLOPs. The final tally—1.5 million FLOPs to display a single high-resolution image. The reason behind the primitive graphics of early-generation microcomputers suddenly becomes clear.

The examination of floating-point processing we offer in the following pages assesses where we stand today and speculates on where we might go tomorrow. By looking at the dynamics of floating-point processing, and some of the hardware and software issues involved in doing it, we can begin to understand how important this technology has become in



personal computing.

We did not look at array processors—specialized engines for doing image-processing applications—but this class of hardware will undoubtedly become more prevalent in the future and will warrant our attention in a future issue.

Our coverage starts with "Avoiding Coprocessor Bottlenecks," in which Mauro Bonomi explains the Weitek 1167 architecture and shows where that floating-point unit (FPU) gets its performance. He explores the limitations imposed on performance by the bandwidth of the bus connecting the CPU and FPU. And in a text box to this article, BYTE's Tom Thompson assesses the performance of two Intel 80386-class floating-point

accelerators—the Intel 80387 and the Weitek 1167. He put both accelerators through their paces with a series of common test programs to show how they perform.

Next, Prakash Chandra, in "Programming the 80387 Coprocessor," explains the additional functions that the newest Intel FPU provides. Not only is it a faster-clock-rate FPU, the 80387 adds new transcendental functions. Chandra explains the important differences between the 80387 and the earlier-generation Intel floating-point processors.

In his "Floating-Point Survival Kit," computer engineer Pete Wilson reviews the floating-point fundamentals, gives some insights into techniques for measuring floating-point speed, and evaluates some of the newest computer designs for speeding floating-point operations.

Finally, Carl Byington talks about doing IEEE 754-compatible math in software without major performance sacrifices. His article, "How to Get Better Floating-Point Results," also gives some tips on designing programs that give good answers regardless of whether the floating-point operations are executed in hardware or via software emulation.

—G. Michael Vose, Senior Technical Editor
George A. Stewart, Technical Editor

Avoiding Coprocessor Bottlenecks

Overcoming bandwidth problems between the CPU and the floating-point math coprocessor

Mauro Bonomi

NUMERICS PERFORMANCE IN the millions of floating-point operations per second (MFLOPS) is vital to workstation tasks such as high-quality graphics, stress analysis, CAD, and electrical or mechanical simulations. With the increasing sophistication of business software, MFLOPS are fast becoming a necessity in many office applications as well. Linear programming, used to solve complex optimization problems in business and industrial planning, relies largely on floating-point computation. So does statistical analysis, employed in market research, product quality analysis, capacity planning, and stock portfolio analysis. The high-resolution graphics found in computer-aided drafting and desktop publishing make copious use of floating-point arithmetic (see the text box "Graphic's Prodigious Need for FLOPS" on page 198).

While high-end microprocessors such as the Intel 80386 provide general-purpose horsepower in the 3- to 4-MIPS range, their arithmetic performance lags far behind, delivering only thousands of floating-point operations per second—far too slow for compute-intensive personal workstation applications.

For higher numerics performance, system designers must turn to coprocessors and numerics accelerators. By relieving the CPU of floating-point math, these arithmetic engines can increase system performance markedly. A range of numerics accelerators are available, from conventional coprocessor chips, like Intel's 80387 and Motorola's 68882, to very fast bit-slice array processors.

Conventional coprocessors are relatively inexpensive and run standard software but offer performance levels suitable only for low-intensity numerics applications, such as spreadsheet recomputation and two-dimensional graphics. Array processors, on the other hand, are often expensive and difficult to program. They execute special operations, such as matrix multiplications and vector calculations, very rapidly. But because of their complex architectures, often featuring multiple memory banks, pipelined stages, and multiple address generators, they are not supported by standard compilers. Simple recompilation of existing software is not possible.

A variation on the conventional coprocessor is the memory-mapped coprocessor. These coprocessors reach a middle ground between conventional coprocessors and array processors; they provide standard software support like the conventional coprocessors but move up the performance curve toward array processors. Memory-mapped coprocessors vary from conventional coprocessors in one vital respect: Memory mapping attempts to deal with the bus bandwidth bottleneck.

Sun, Apollo, and Masscomp all make proprietary memory-mapped floating-point accelerators for workstations; in the personal computer world, the Weitek 1167 is the only example of a memory-mapped coprocessor.

Bottlenecks Limit Performance

The vast majority of arithmetic calculations performed by any computer employ

real numbers and so require floating-point processing. Such processing is, however, a good deal more complex than integer math. The computer must keep track of a mantissa and an exponent for every operand and perform scaling after each arithmetic operation to reduce the result to a normalized format.

Owing to silicon space limitations, microprocessors, such as the 80386 and the 68020, feature integer-only ALUs. Floating-point operations are accomplished through software subroutines. Each such operation is carried out by the integer hardware as a lengthy series of ALU steps (adds, subtracts, and shifts).

This type of software implementation places a significant drag on performance in numerics-intensive tasks. Numerics coprocessors provide dramatic gains in speed by implementing floating-point functions in specialized hardware. Coprocessors work in close conjunction with the microprocessor.

Assuming, for example, that two single-precision numbers, *A* and *B*, stored in two 80386 registers must be added and the result *C* stored back in the 80386, the following actions must be carried out: The microprocessor must instruct the coprocessor to execute an addition, pass the two operands, and then store the result after the completed operation. Clearly, the resulting system performance depends on two main factors: the raw speed

continued

Mauro Bonomi is a product manager at Weitek. He can be reached at 1060 East Arques, Sunnyvale, CA 94086.

Graphic's Prodigious Need for FLOPS

One of the most math-hungry applications is three-dimensional graphics, used extensively in CAD, computer animation, and a variety of scientific problems. Generating even the simplest image of a three-dimensional solid, for example, can consume prodigious numbers of floating-point operations. Beginning from a simple geometrical description of an object, the computer must derive a model of the object's entire surface and its relationship to the viewing screen, reflected light, and perspectival attributes.

Consider the goblet in photo A. The first step in rendering a realistic image is to create a mathematical model of the object. The goblet is defined in terms of quadratic functions representing simple geometric shapes: a sphere, cylinder, and two hyperbolic surfaces, each truncated by one or more planes. For example, the quadratic function for the sphere is $X^2 + Y^2 + Z^2 = K^2$.

The equations are next solved for various values of X and Y . The result is a set of coordinate points, representing points on the surface of the goblet. In a process known as tessellation, each point is treated as the vertex of a triangle. The surface as a whole is represented by a large number of adjacent triangles, much like a faceted gem, that approximate the smoothly curving surface of an actual goblet (see figure A). The greater the number of surface points computed, the higher the quality of the final picture. For this image, 12,000 points were computed with a total of about 120,000 floating-point calculations.

The generalized surface image must next be rotated, translated, and scaled. That is, it must be assigned an exact ori-

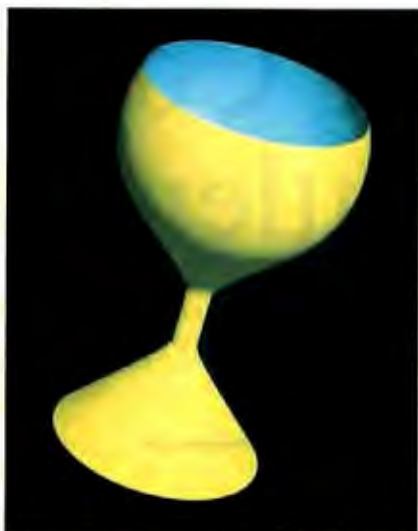

Photo A: *The goblet.*

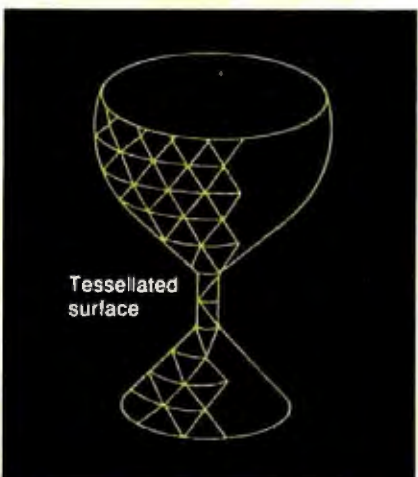

Figure A: *The tessellated goblet.*

entation, position, and size. The coordinates of each triangle vertex are multiplied by a 4-by-4 transformation matrix.

Twenty-eight floating-point operations are needed to transform each point; transforming the entire picture takes 330,000 calculations.

Once the image has been transformed, it must be determined which points fall within the viewing space (i.e., which points lie inside the picture frame). Clipping, as this process is called, involves six calculations per point for a total of 72,000 calculations. Perspective transformation comes next. The internal, three-dimensional model of the goblet is projected onto the two-dimensional coordinates of the computer screen. Screen coordinates must be converted into integer values representing pixel locations. Roughly 130,000 operations are required.

A shading model must then be used to compute the colors and intensities associated with each point on the screen. Such models take into account the properties of both the surface of the object and the light source. Light source calculations entail more than 360,000 operations for the vertex points projected onto the screen. Shading for pixels not corresponding to vertices of the tessellated image is derived via interpolation. Assuming the goblet takes up 30 percent of the screen, interpolation requires close to 300,000 calculations.

At this point, the information is complete and is ready to be displayed. All told, the image has required approximately 1.5 million floating-point operations. Many more operations are required every time the image is rotated, translated, or rescaled.

of the floating-point hardware and the efficiency of the interface between the microprocessor and the numerics coprocessor. Even if the floating-point unit (FPU) latency—the time required to generate a result from two input operands—could be reduced to 0, an inefficient interface protocol could limit system performance.

Low-Latency Data Paths

The 80386/80387 combination illustrates conventional coprocessor function. The 80387, connected to the system data bus, monitors the same program instruction stream as the microprocessor does. The microprocessor is responsible for gener-

ating all addresses for both code and data. Operands and op codes are transmitted to the coprocessor from memory via the data bus. Whenever the microprocessor detects a coprocessor instruction, it waits until the coprocessor becomes idle, lets the coprocessor begin the instruction, and then moves on to the next instruction. If the 80387 is still busy by the time the 80386 encounters another coprocessor instruction, the microprocessor waits until the coprocessor is done. This process is invisible to the programmer; it appears as though there is only a single processor.

Despite this tight coupling and ease of programming, the performance of con-

ventional numerics coprocessors suffers both from some inherent processing limitations and from interface bottlenecks. To begin with, simple operations such as adds and multiplies may require multiple passes through the hardware. This is due to limited silicon space for ALUs. Similarly, the number of on-chip registers is often relatively small. But a bigger problem is that both data and instructions are sent to conventional coprocessors via a data bus of limited bandwidth.

Memory-mapped coprocessors accelerate floating-point operations in two ways: They use dedicated 64-bit floating-point multiplier and ALU data paths, and they provide an interface that lets the co-

processor acquire data *and* instructions by using both the address and the data bus simultaneously.

For example, consider the simplified block diagram of the Weitek 1167 memory-mapped coprocessor and its interface to the Intel 80386 (figure 1). The multiplier and ALU data paths execute such operations as single-precision adds, subtracts, and multiplies in a single pass through the silicon. The 1167 multiplier and ALU flow-through time is under 200 nanoseconds for a single-precision operation. In contrast, conventional coprocessors usually require over 1.5 microseconds (7 to 8 times slower) to carry out the same operation.

The coprocessor is connected to the 80386 via the control, data, and address buses. *Instructions* (op codes) are sent to the coprocessor using the system address bus, while *data* (operands) are sent over the data bus. As the address bus specifies the instruction to be performed, the data bus can pass a 32-bit operand simultaneously. This parallelism reduces bus bottlenecks that otherwise significantly limit system performance.

View of the System Address Bus

The microprocessor treats a memory-mapped coprocessor as a distinct region of physical memory. Data-moves to and from this memory region select the coprocessor and specify both the floating-point op code, the location of the two operands, and the destination of the computational result. At the same time, the data on the data bus can provide any operand not already present in the coprocessor's registers.

Figure 2 shows the Weitek coprocessor view of the 80386 address bus. The coprocessor is mapped into the physical memory area ranging from C000000h to C000FFFFh. A given address in this area selects the coprocessor, indicates the instruction for the coprocessor to perform, and specifies the operand locations (Source1 and Source2/Destination). The most significant 16 bits of the physical address identify a coprocessor instruction. If the upper bits of the address are not equal to C000h, the address does not specify a Weitek command and is ignored by the coprocessor. The next 6 bits of the address specify the coprocessor instruction to be executed. The least significant 10 address bits specify the registers that will provide sources and destination for the instruction.

Source2 and Destination always coincide. When Source1 is set to 0, the Source1 data is provided by the system data bus. Source2 and Destination, on the other hand, always specify one of the remaining 31 32-bit registers (1 to 31) of

the coprocessor register file. This means that one of the two operands always resides in the coprocessor register file.

Generating Instructions

Coprocessor instructions for the Weitek 1167 are specified via simple 80386 memory moves. Assuming that the two single-precision operands in the 80386 registers EAX and EBX need to be added and the result is to be stored back in register EAX, the following three memory move instructions will execute the operation:

- 1) mov ADDR1, eax ; load content of EAX (A) into the Weitek 1167 register file.
- 2) mov ADDR2, ebx ; load content of EBX (B) into Weitek register file and add it to A.
- 3) mov EAX, ADDR3 ; store result C back into 80386 register EAX.

Addresses ADDR1, ADDR2, and ADDR3 are derived by filling the address fields, shown in figure 2, with the proper values. The most significant 16 bits of all the addresses are set to C000h in order to select the coprocessor. The next 6 bits are filled with the op code for LOAD, ADD, and

STORE, respectively. Finally, the least significant 10 bits will be filled with the operand addresses.

As all the above operations involve one operand coming from the bus, Source1 will always be set to 0. Source2 can instead specify any of the remaining 31 registers (1 to 31) in the Weitek 1167 register file. With the move to ADDR2, the 80386 passes a 32-bit operand (B) to the coprocessor on the data bus and specifies the floating-point instruction that needs to be executed (ADD). This is an example of the parallelism provided by the memory-mapped interface.

To hide the details of the memory-mapped interface from the programmer, memory-mapped coprocessors feature macros, one for each coprocessor instruction. Using Weitek 1167 macro notation, for example, the addition sequence above becomes

- 1) wfld ws1, EAX ; load EAX (A) into Weitek register 1.
- 2) wfadd ws1, EBX ; add Weitek register 1 (A) to EBX (B).
- 3) wfst EAX, ws1 ; store result from Weitek register 1 to EAX.

The instruction stream assumes that reg-
continued

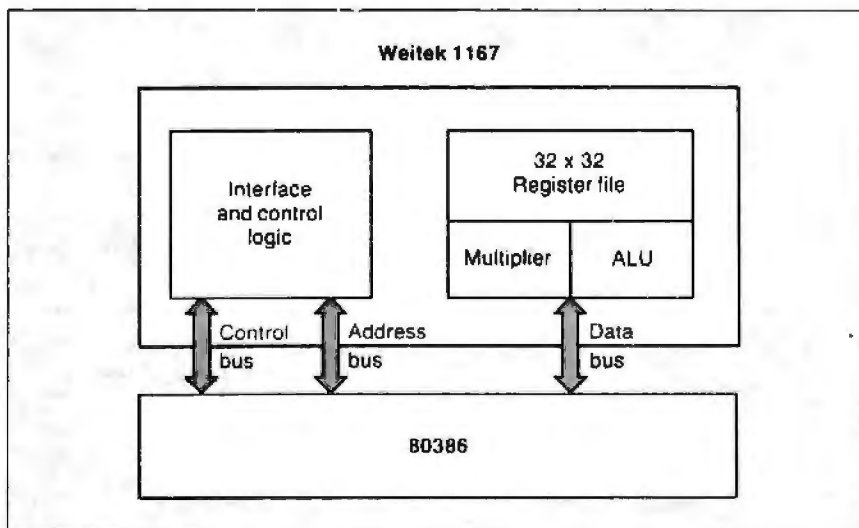

Figure 1: A block diagram of the 80386/Weitek 1167 interface.

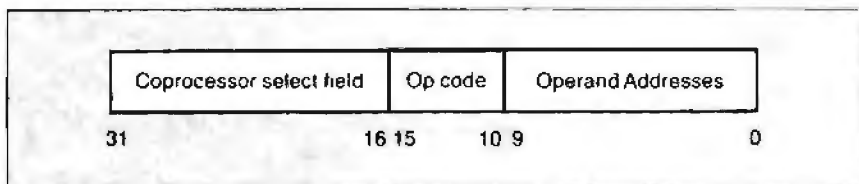

Figure 2: The Weitek 1167 view of the 80386 address bus.



Photo 1: The beach ball.

ister 1 has been used to accumulate the result inside the coprocessor.

Large Register Sets

Memory-mapped coprocessors commonly offer large internal register sets that can be used to store constants and to accumulate partial results. The accumulation of partial results in internal registers lets the coprocessor minimize the number of loads and stores between the microprocessor and the FPU.

When performing a three-dimensional graphics transformation, for example, requiring the multiplication of a large number of vectors of four elements each by a 4-by-4 transformation matrix, the programmer can store all 16 matrix coefficients in the coprocessor register file and then use them to transform all the vectors.

C programmers can define all variables processed by the coprocessor as temporary variables. The compiler will

then allocate such variables to coprocessor internal registers, thus holding the number of store and load operations between microprocessor and coprocessor to a minimum.

To appreciate the performance differences between conventional and memory-mapped coprocessors, see "The Intel 80387 vs. the Weitek 1167" by Tom Thompson, on page 205.

Compiling: An Example

The beach ball picture shown in photo 1 was generated on a 20-MHz Compaq Deskpro 386/20 with an EGA graphics card. The C code for this simple graphics example is presented in listing 1. The program uses the Phong shading technique to compute the intensities and colors of the surface of the ball. The idea behind this technique is to compute normal (perpendicular) vectors to each point on the surface using an interpolation scheme and then apply the shading model at each pixel displayed.

The program involves a large number of floating-point computations on single-precision numbers, including the four basic instructions (add, subtract, multiply, and divide), as well as special functions (sine, cosine, and square root). The C program was compiled with a MetaWare High C compiler that supports both the Weitek 1167 and the 80387 coprocessor. The compiler generates either 80387 or Weitek 1167 object code. Users choose the desired coprocessor by setting a special switch on the command line when giving the compile command.

Running without a floating-point coprocessor, with the 80386 emulating

continued

Listing 1: The C code to generate the beach ball. (Code written by Bruce Holloway of Weitek.)

```
#include <math.h>
#include <stdio.h>
#include <time.h>

clock_t start, stop;
float pi;
int colors[]={3,6,10,13,6,3,10,13,6,3,13,1
0},d[]={640,350,1},i,k,
palette[]={000,010,001,011,020,002,022
,077,040,004,044,060,006,066,007,077},
x,y,x_min,x_max,y_min,y_max;
unsigned short random;
```

```
main()
```

continued

BYTEK's NEW 135 MULTIPROGRAMMER™ OFFERS 18/12 PROTECTION PLAN

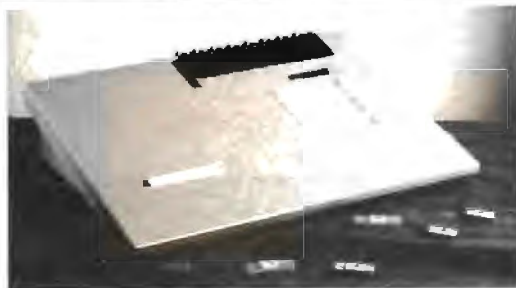

BYTEK

Call us today at:
1-800-523-1565

In Florida: (305) 994-3520
FAX: (305) 994-3815
TELEX: 4998369 BYTEK

BYTEK's 135 programs virtually any 24-, 28-, & 32-pin (E)EPROM from 16K to megabit devices. Sets of devices, 16- & 32-Bit Wide, can be downloaded into RAM via the RS232 & programmed in one easy operation. As a stand alone Gang Duplicator, up to 8 EPROMS can be copied at one time, (optional 16 EPROMS).

UNIVERSAL: With standard 256K x 8 RAM, expandable to 2 MegaByte, the 135 supports more devices than any other production programmer on the market today. Options available to program 40 pin EPROMS, (E)PLD/GALs, Bipolar PROMs, & 40 pin Micro Computer Devices.

18/12 PROTECTION PLAN: BYTEK offers a full 18 Month Warranty, & 12 Month FREE Device Updates.

BYTEK

CORPORATION
INSTRUMENT SYSTEMS DIVISION

1021 South Rogers Circle, Boca Raton, FL 33487

MODEL 24

high performance

DATA EXCHANGE SYSTEM



UP
TO
4½MB
BUFFER

Engineered for speed, flexibility and expandability

BayTech

Bay Technical Associates, Inc., Data Communications Products Division
200 N. Second St., Bay Saint Louis, MS 39520 USA
Telex 910-333-1618 BAYTECH. Telephone 601-467-8231 or toll-free
800-523-2702

CHECK THE SPECS

- The Data Exchange System, Model 24, allows high speed exchange of data between computers, printers and other peripherals.
- Powerful 16-bit CPU plus multiple high performance I/O processors allow super high speed transfer of data demanded by new faster computers and software.
- Optimum flexibility: Select the right combination of serial and parallel ports, and set *any* of these ports as a peripheral port or as a computer port.
- Basic unit expandable to 24 ports by 4-port modules offered in serial/parallel combinations.
- Standard 512KB buffer expandable to 4½ megabytes, to handle big print/plot jobs and many small ones.
- Buffer memory dynamically allocated to maximize buffer utilization.
- Simultaneous data input and output on *all* ports, so no devices are kept waiting.
- Computer-to-computer communication concurrent with all other operations.
- Full duplex communication allows file transfer capability with many communications software packages.
- Compatible with virtually all computers, printers, plotters, modems and other peripherals.
- Pop-up RAM resident PC support software allows peripheral selection via hot key.
- Super fast throughput allows data to pass through with no apparent processing delays.
- Many user-definable parameters including separate baud rates, flow control and parity for each port.
- Internal serial-to-parallel and parallel-to-serial conversion.
- Cascading capability to increase available number of ports.
- Unlimited hotline tech support.
- Designed and manufactured in the U.S.A.

Circle 36 on Reader Service Card

It's just your basic quantum leap.



Microsoft® QuickBASIC 4.0 is no longer your basic BASIC. Now, because of a revolutionary breakthrough, you can run, test, debug, then continue running your program and see the results. Instantly. Which is why we call it "instant programming."

Other compilers make you wait while they compile your program at an unimpressive rate of 12,000 lines per minute. But Microsoft QuickBASIC 4.0 translates your program into executable code at a breathtaking 150,000 lines per minute. You get all the speed you can possibly use right when you need it. While you're developing your program.

And for the first time in BASIC, you'll find the most sophisticated debugging tools around. Like the freedom to change a running program on the fly. Without restarting. And you also get instant syntax checking, watch expressions, even runtime type checking.

Besides all these advances in the environment, Microsoft QuickBASIC 4.0 gives you a sophisticated collection of language extensions: records, recursion, huge arrays and true functions. There's even interlanguage calling that lets you call subroutines from other Microsoft languages.

And if you think all this means you might have to give up phenomenal execution speed, think again. Microsoft QuickBASIC 4.0 gives high performance executable code that's the fastest anywhere.

About the only thing that isn't more advanced in Microsoft QuickBASIC 4.0 is the price.

It's still just \$99. And it's still backed with a 30-day money back guarantee. Microsoft QuickBASIC 4.0.

To make a quantum leap in your programming, you need a quantum leap in your language.

Microsoft® QuickBASIC 4.0

For the name of your nearest Microsoft dealer, call (800) 541-1261, Dept. A44. Microsoft is a registered trademark of Microsoft Corporation. Offer valid in the 50 United States only.

Circle 170 on Reader Service Card (DEALERS: 171)

```

for (i=0,p=0;i<11;i++)
  if (p<(q-n0*v[1][0]+n1*v[1][1]+n2*v[1][2])) {
    p=q;
    k=colors[i];
  }
/* Aggregate ambient, diffuse, & specular intensities &
do dither. */
i=k-2.5+2.5*ln+t+(random=37*random+1)/65536.;
/* Clamp values outside range of three color levels to
black or white. */
if (i<k-2) i=0; else if (i>k) i=15;
draw_dot();
}
}
stop=clock();
reg_reset();
printf("\t\t\t\tTime = %3.2f seconds", ((double) (stop-
start))/CLK_TCK);
while (clock()-stop<5*CLK_TCK);
/* Put EGA in 80-column mode. */
video_int(0x03);
}

```

Listing 2: Sample of compiler output for the 80387.

```

;      s=r*r-s*s;
0214 d9 46 c8      fld     dword ptr -56[bp]
0217 d8 c8        fsqr
0219 d9 46 c4      fld     dword ptr -60[bp]
021c d8 c8        fsqr
021e de e9        fsub
0220 d9 5e c4      fstp   dword ptr -60[bp]
;      x_max=b+a*sqrt(s);
0223 d9 46 c4      fld     dword ptr -60[bp]
0226 d9 fa        fsqrt
0228 d8 4e fc      fmul   dword ptr -4[bp]
022b d8 46 f8      fadd   dword ptr -8[bp]
022e e8 ----e      call   _mwt trunc
0231 a3 0054r      mov    @FONGBALL+84,ax

```

Listing 3: Sample of compiler output for the Weitek 1167.

```

;      s=r*r-s*s;
0380 64:a2 0719      wload  .S fr2,fr25 ; mov al,fs:[]
038c 64:a2 081a      wmul   .S fr2,fr2   ; mov al,fs:[]
0390 64:a2 0b7a      wmul   .S fr26,fr26 ; mov al,fs:[]
0394 64:a2 107a      wsub   .S fr26,fr2  ; mov al,fs:[]
;      x_max=b+a*sqrt(s);
0398 64:a2 471a      wcvtsd .S fr2,fr26 ; mov al,fs:[]
039c 66:64:ff 36 0c18 push   .S fr2      ; push fs:[]
03a2 66:64:ff 36 0c1c push   .S fr3      ; push fs:[]
03a8 e8 ----e      call   sqrt
03ab 64:a2 45a1      wcvtsd .S fr4,fr13 ; mov al,fs:[]
03af 64:a2 45a8      wcvtsd .S fr6,fr12 ; mov al,fs:[]
03b3 64:a2 889a      wmul   .D fr2,fr6   ; mov al,fs:[]
03b7 64:a2 8098      wadd   .D fr2,fr4   ; mov al,fs:[]
03bb 64:a2 bcla      wfix   .D fr2,fr2    ; mov al,fs:[]
03bf 66:64:a1 8c18 wator   .D fr2,eax        ; mov eax,fs:[]
03c4 66:0f a4 c2 10      shld   edx,eax,16
03c9 a3 0054r      mov    @FONG1167+72,ax

```

80387 instructions, the program takes 8 minutes to complete. Adding a 20-MHz 80387 reduces the execution time to a little more than 28 seconds. Finally, the Weitek memory-mapped coprocessor cuts execution time by about 3 times, down to only 10 seconds. The 200 percent perfor-

mance improvement was achieved by simply recompiling the source code with no hand-coded optimizations.

Samples of the compiler output for both the 80387 and the Weitek 1167 are provided in listings 2 and 3. When compiled for the 80387, the code line

$s=r*r-s*s$ is translated into the code stream in listing 2.

The same equation is translated into 1167 memory moves by the compiler when the Weitek coprocessor is selected. The Weitek object code shown in listing 3 makes efficient use of coprocessor registers. The equation result s ($s=r*r-s*s$), for example, is not stored back into the 80386 but is left in the coprocessor register file and is then used by the instruction ($x_max=b+a*\sqrt{s}$), thus minimizing the data transfers between the microprocessor and the coprocessor and freeing up the system bus.

Programming for Performance

When writing high-level language code for a memory-mapped coprocessor, some simple techniques can lead to significant performance improvements in the compiled code. First, variables used only in specific subroutines can be defined as local variables. The compiler then allocates such variables to coprocessor registers and will not store them back to main memory at the end of each instruction.

In the case of the 1167, the assembly language programmer has access to special instructions not otherwise available to compiler users. The multiply-accumulate (wfmac) instruction is an example. This instruction, useful in implementing matrix multiplications, specifies the multiplication of the two input operands, followed by the addition to a previously calculated partial result. A single memory move can then specify two floating-point instructions (multiply and add), further decreasing the burden on the system bus.

Additional assembly-level instructions that can improve the system performance are block moves—that is, moves of blocks of data to or from adjacent memory locations. A block move effectively encodes a stream of floating-point instructions. It is useful in loading and unloading the entire contents of the coprocessor register file, as well as in implementing vector adds and multiplies.

Boiling Down

Accelerating floating-point performance boils down to more than just clock rates and the size of machine words. We need the hardware assistance of dedicated ALUs and multipliers. But equally important is the need for efficient ways to move data and instructions between the main processor and the math coprocessor.

Removing the coprocessor instruction stream from the data bus—using the address bus to transmit op codes—leaves more room for passing operands. This strategy is one way to increase data bus bandwidth and improve processor/coprocessor interaction. ■

The Intel 80387 vs. The Weitek 1167

Tom Thompson

AS THE OTHER articles in this section explain, the new generation 80386 floating-point hardware improves upon the math coprocessors previously available. To find out if they really deliver on their collective promise to enhance floating-point performance, I ran several tests to determine how the 80387 and Weitek WTL 1167 stacked up.

The Compaq 386/20 lets you use this new generation of math coprocessor. While the 80387 is a single chip, the Weitek 1167 is a set of three chips designed to work in parallel with the Intel 80386 and provide floating-point performance superior to the 80387. Compaq supplies this coprocessor on a cleverly designed Weitek Coprocessor Board that also has an 80387 socket. This unique ability to use both coprocessors within the same computer gave BYTE the opportunity to compare the floating-point performances of both.

Compaq's Weitek Coprocessor Board comes in a kit costing \$1999 that contains the coprocessor board, a special interconnection board, a 38-page installation guide, and a tool for removing the 80387 from its socket. The board has a PC-form factor with a standard PC-card edge connector for mounting it in the computer. The interconnection board plugs into the 80387 socket on the Deskpro's motherboard and attaches to two male connectors on the coprocessor board, opposite the PC edge connector. This second pair of connectors lets the computer communicate with the 80387 when it's placed on the coprocessor board. Because of the location of the motherboard's 80387 socket, you must install the Coprocessor Board in slot 2.

The installation guide uses photos and detailed text to guide you step by step through the board installation. However, the disassembly procedure used is complex: You are required to remove the Deskpro's entire motherboard just to remove the 80387 and install the interconnection board on its socket. I used a shortcut by removing the reinforcement bracket, the RF shield, and the 32-bit memory board in slot 1. This saved me a lot of disassembly work and having to run SETUP to reconfigure the system. (My guess is that Compaq wants you to go through the elaborate disassembly process to avoid stressing the mother-

board when the interconnection board is attached.)

When you have removed the 80387 from the computer, you then place it in the 80387 socket on the coprocessor board. Once the 80387 is in place, you mount the coprocessor board by very carefully sliding it (since you have three connectors to mate instead of one) into slot 2.

The Tests

I ran a number of benchmarks (compiled with MetaWare's High C version 1.4) to test both the Weitek coprocessor and 80387's handling of floating-point operations, transcendental functions, and a mix of the two. A compiler switch directed High C to generate either Weitek coprocessor- or 80387-specific instructions. The transcendental run-time libraries are from Weitek and licensed to MetaWare for use with its compiler. I used Phar Lap's version 1.1 Linker and DOS Extender to run the benchmarks in the 80386 protected mode.

The Float and Calcpi benchmarks are floating-point intensive. Calcpi computes the value of π from a Taylor series expansion. Although the arctangent is used in Calcpi, it is used only once, so that benchmark can safely be said to be floating-point intensive. The Whetstone

and John Walker's Fbench benchmarks are representative of a mix of floating-point and transcendental functions. The Whetstone has few transcendental function calls, while the ray-tracing algorithms in Fbench make heavy use of them. Finally, Dr. Dobbs' Savage benchmark uses only transcendental functions.

The results are shown in table 1. As you can see, the Weitek coprocessor easily outperforms the 80387 in floating-point operations. However, only a modest gain in performance is seen with the transcendental functions, notably with the Savage benchmark. This is because the WTL 1167 supports these functions as run-time libraries, not in silicon. The mixed-instruction benchmarks (Fbench and Whetstone) are probably more representative of real-world applications.

Since the benchmark programs are coded in C, all floating-point values are processed as double-precision. You can obtain better performance using single-precision values. ■

Tom Thompson is a BYTE technical editor with a BSEE degree from Memphis State University. He can be contacted at BYTE, One Phoenix Mill Lane, Peterborough, NH 03458, or on BIX as "tom_thompson."

Table 1: The Weitek Coprocessor Board ran 7 percent to 68 percent faster than the 80387 processing double-precision numbers in our benchmarks.

	Weitek 1167	Intel 80387	% Improvement
Fbench	3.35	4.01	16
Float	0.35	1.03	66
Savage	2.63	2.84	7
Calcpi			
Loop time	0.14	1.37	
Benchmark	0.99	3.11	68
KiloFLOPs per sec.	590.99	287.40	
Whetstone			
Execution time	0.35	0.57	38
Whets per sec.	2906469	1759199	

A Compaq 386/20 with 20-MHz 80386/80387 was used with Compaq's Weitek Coprocessor Board. One thousand iterations were run for the Fbench test, and 125,000 iterations were executed for Calcpi. All times are in seconds. "Improvement" indicates the improvement in execution speed compared to the 80387.

Who can explain the mysteries of nature? Such as why lightning always seems to blackout the power and your PC, just as you're putting the finishing keystrokes on an 87-page report?

That's where Deja View™ flash-back software comes in.

Deja View runs on your IBM PC, PS/2 or compatible, automatically protecting your work in progress from power failures and surges. Accidentally pulled plugs. Frozen keyboards. System crashes. Unintentional reboots. Inadvertently deleted information on your screen. And a thousand other potential disasters.

Even after your PC goes down, Deja View will flash you right back to where you were before the problem. And you can continue as if the mishap never occurred.

Deja View is a non-copy-protected, memory-resident utility that runs along with your application program. It automatically copies all of your PC's RAM and video memory onto your hard disk, saving your work in progress. You decide the frequency of the Auto-Save function, by number of keystrokes or specified time intervals. Or use the Save-Now key as needed.

Deja View also lets you flip back and forth between two different applications by depressing just three keys. You don't need to save work files, exit one application, and then load the new application and work files.

Now there's no need to buy an expensive battery back-up system. With a price of only \$95, can you really afford to be without Deja View?

So call Meridian Technology today, or see your local dealer. And if disaster should strike, you'll know your work in progress is safe. And you'll be glad you've experienced Deja View.

Deja View and Use it or lose it are trademarks of Meridian Technology, Inc. Other products are trademarks of their manufacturers.

DÉJÀVIEW™
Use it or lose it.™

MERIDIAN TECHNOLOGY INC. ■■■■■

7 Corporate Park, Suite 100
Irvine, CA 92714. (714) 261-1199

**You're about
to experience
Deja View.™**

Circle 160 on Reader Service Card (DEALERS: 161)

Programming the 80387 Coprocessor

A look at the differences between this FPU and its older cousins

Prakash Chandra

THE 80387 CHIP is a math coprocessor for the 32-bit 80386 microprocessor. The 80387—actually called a Numerics Processor Extension (NPX) by its maker, Intel Corp.—implements the IEEE 754-1985 Standard for Binary Floating-Point Arithmetic and provides numerics capabilities that include support for floating-point, extended-integer, and binary-coded-decimal (BCD) data types. The 68-pin 80387 operates independently of the real, protected, and virtual-8086 modes of the 80386.

While maintaining upward object-code compatibility with the 8087 and the 80287, the 80387 contains a variety of new instructions, including instructions to compute sine and cosine functions, and it extends the capabilities of many existing instructions. Object-code compatibility ensures that any program running on the 8087 or the 80287 will run on the 80387 without recompilation.

Let's look at the key differences between the 80387 and the earlier 8087/80287 floating-point units (FPUs). For a description of the performance characteristics of the 80387, see the text box "80387 Performance" on page 212.

Architectural Overview

The 80287 was designed before the final IEEE-754 standard was approved. The 80387, on the other hand, fully conforms to the standard, including automatic normalization of denormal operands, support of only the affine interpretation of infinity (the 80287 supports both affine and projective interpretations), and IEEE 754-compatible unordered and partial

remainder instructions.

The programmer of an 80386/80387 computer system can view the 80387 as a means to add extra registers, new data types, and trigonometric, exponential, and arithmetic instructions to those of the 80386.

• *Register set:* As figure 1 shows, an 80387 contains a set of eight 80-bit general-purpose registers that are individually addressable, plus three 16-bit registers and two 48-bit registers. The general-purpose registers are organized in the form of a stack. The top of the stack is designated by the TOP field of the 80387 status-word register (described later). Numeric instructions address the eight general-purpose registers relative to the top of the stack. In the rest of this article, I'll use ST to indicate the top of the stack and ST(*i*) (with $i = 0, \dots, 7$) to represent the *i*th register from the top of the stack.

The three 16-bit registers in the 80387 are known as status-word, control-word, and tag-word registers. The overall state of the 80387 is stored in the status word. The control-word register is used to control processing options in the 80387. The tag word indicates the contents of each register in the general-purpose register stack.

The function of the tag word is to optimize the 80387's performance and stack handling by making it possible to distinguish between empty and nonempty register locations. It also allows programmers of exception handlers to check the contents of a stack location without the need to perform complex decoding of actual data.

The 48-bit instruction and data-pointer registers provide for user-written exception handlers. These registers, which are actually located in the 80386, can be referenced only by a subset of 80387 instructions and are used by the 80386 to save the instruction address, the operand address (if any), and the instruction op code whenever the 80386 decodes an 80387 instruction.

• *Data types:* As figure 2 shows, the 80387 supports seven data types in three different formats—binary integer, BCD integer, and binary real. Internally, all numbers are stored in the extended-precision real format.

• *Special numeric values:* A real number in the 80387 has three parts—sign, significand, and exponent. The 1-bit sign indicates whether the number is positive or negative. The number's significant digits are held in the significand field. The exponent field determines the location of the "decimal" point within the significant digits.

The data format of the 80387 also permits representation of special numeric values. A significand of 00...00B (B=binary) and a biased exponent of 00...00B represent the value 0. A 0 can be positive or negative. Infinity is another special numeric value, represented by a significand of 1.00...00B and a biased exponent of 11...11B. The

continued

Prakash Chandra is a technical marketing engineer at Intel Corp. He can be reached at 3065 Bowers Ave., Santa Clara, CA 95051.

is used in an arithmetic operation before it has been initialized, it will cause the operation to be performed on a signaling NaN. If the invalid operation exception were unmasked, an exception would occur to identify the offending variable.

A quiet NaN in the 80387, which contains a 1 in the most significant bit of its significand, behaves the same way as a NaN in the 80287.

New Instructions in the 80387

The 80387 contains seven new instructions not in the 80287. Of these, three are transcendental instructions, three are unordered compare instructions, and one is an IEEE-754 partial-remainder instruction. Table 1 summarizes these new instructions. The text box "Processor Initialization and Control" on page 210 explains another key difference between the 80387 and 80287.

• **Trigonometric instructions:** The trigonometric functions accept a practically unrestricted range of operands. The instruction FCOS computes the cosine of the contents of ST and replaces it with $\cos(ST)$. The value contained in ST must be in radians, and its absolute value must be less than 2^{63} . If the operand is within this range, the C2 bit (the eleventh bit) of the status word is cleared. The C2 bit is set to 1 if the operand of FCOS is outside the range and ST remains unchanged. The instructions FPREM and FPREM1 can be used to reduce the operand to a specified range.

The FSIN instruction works the same way as the FCOS instruction. It replaces the contents of ST, which must be expressed in radians, with $\sin(ST)$. The operand range restriction for FCOS also applies for FSIN. The FSINCOS instruction computes both the sine and the cosine of the contents of ST. First, the contents of ST are replaced by $\sin(ST)$, and then $\cos(ST)$ is pushed onto the stack. The operand range requirements for FCOS apply to FSINCOS, too.

• **Unordered compare instructions:** In addition to all the compare, test, and examine operations of the 80287, the 80387 offers three new instructions—FUCOM, FUCOMP, and FUCOMPP—to perform unordered comparisons. The FUCOM instruction operates like the FCOM (compare real) instruction in that it compares the value on the top of the stack to the source operand, where the source operand can be in a register or on the stack, or a single- or double-real memory operand. This instruction will not, however, generate an invalid-operation exception if one of the operands is a NaN. Table 2 shows the values of the condition code bits in the status word (bits 9, 10, 11, and 15) for various situations. If either oper-

and is a NaN, the condition bits of the status word are set to unordered.

FUCOMP and FUCOMPP behave like FUCOM and also pop the stack once and twice, respectively.

• **IEEE 754-compatible remainder instruction:** The IEEE 754-compatible partial-remainder instruction in the 80387, FPREM1, computes the remainder of the division of ST by ST(1). The result is stored in ST. The instruction finds a remainder r and a quotient q such that

$$r = ST - ST(1) \times q,$$

where q is the integer nearest to the exact value of $ST/ST(1)$. FPREM1 always produces exact results, and therefore the 80387's rounding control mode has no effect on the result.

If the FPREM1 instruction is used on operands that differ greatly in magnitude, it can consume large amounts of time and will also increase the computer's interrupt latency, since the 80387 can be interrupted only between instructions. The instruction, therefore, may terminate before the calculation has been completed. If this happens, the C2 bit of the status

The 80387 provides the system designer with significant enhancements in features and speed over the 80287.

word is set, indicating incomplete calculation. The contents of ST in this case contain only the partial remainder. FPREM1 can reduce the exponent of ST by up to (but not including) 64 in one execution. If the reduction is complete, the C2 bit of the status bit is set to 0, and C3, C1, and C0 contain the least-three significant bits of the quotient generated. The FPREM1 instruction differs from the 8087/287 instruction FPREM in two ways:

1. Remainder r produced by the instruction FPREM is in the range $0 \leq r <$

continued

Table 1: The new instructions added to the 80387 instruction set.

Instruction	Function
FCOS	Cosine
FSIN	Sine
FSINCOS	Sine and cosine
FUCOM	Unordered compare real
FUCOMP	Unordered compare real and pop
FUCOMPP	Unordered compare real and pop (twice)
FPREM1	IEEE Standard partial remainder

Table 2: The values of the condition code bits in the 80387 status word for various conditions.

Order	C3 (ZF) (Bit 15)	C2 (PF) (Bit 11)	C0 (CF) (Bit 9)	80386 Conditional branch
ST > operand	0	0	1	JA
ST < operand	0	0	1	JB
ST = operand	1	0	0	JE
Unordered	1	1	1	JP

Table 3: The operand ranges for the 80387 compared to the 80287.

Instruction	Function	80387 Operand range	80287 Operand range
FPTAN	Partial tangent	$ ST(0) < 2^{63}$	$ ST(0) < \pi/4$
FPATAN	Arctangent	Unrestricted	$ ST(0) < ST(1) $
F2×M1	$2^x - 1$	$-1 \leq ST(0) \leq 1$	$0 \leq ST(0) \leq 0.5$
FSCALE	Scale	Unrestricted	Undefined in $0 < ST(1) < 1$

$|ST(1)|$, or $-|ST(1)| < r \leq 0$, depending on the sign of the dividend. FPREM1, on the other hand, produces a remainder r such that $-|ST(1)|/2 < r < |ST(1)|/2$.

2. The low-order three bits of the quotient as reported in the status word bits C3, C1, and C0 may differ by 1 in some cases because FPREM1 and FPREM choose the value of quotients differently.

Extended Operand Range

The 80387 has extended the operand ranges of four instructions: FPTAN, FPATAN, F2XMM1, and FSCALE. Table 3 compares the operand ranges for the 80387 with those for the 80287.

The allowed operand range for the FPTAN (partial tangent) instruction in the 80387, which computes the function $y = \text{TAN}(ST)$ (ST is in radians), is $|ST(0)| < 2^{\pi}$. The corresponding range for the 80287 is $|ST(0)| < \pi/4$. The FPTAN instruction reduces the operand internally using an internal $\pi/4$ constant, which is more accurate than the value obtained using a constant instruction like FLDPI.

The F2XMM1 instruction in the 80387 computes the function $y = 2^x - 1$, $-1 \leq x \leq 1$. This represents an increase in the range from $0 \leq x \leq 0.5$ in the 80287.

Instructions FPATAN (arctangent) and FSCALE in the 80387 have unrestricted operand ranges. The arctangent instruction FPATAN computes the function $\theta = \text{ARCTAN}(y/x)$, where x and y indicate the contents of $ST(0)$ and $ST(1)$, respectively. Although the range of the operands is unrestricted, the range of the result depends on the relationships between the operands, as shown in table 4.

FSCALE, which scales the top of the stack by the power of 2 given in $ST(1)$, has no restriction on the range of value in $ST(1)$ as the 80287 did. If $0 < |ST(1)| < 1$, the scaling factor is taken to be 0 in the 80387. This contrasts with the 80287, which produces an undefined result.

Rounding Control

Constants 0, 1, π , $\log_2 10$, $\log_2 e$, $\log_2 2$, and $\ln 2$ can be loaded onto the 80387 stack using FLDZ, FLD1, FLDPI, FLDL2T, FLDL2E, FLDL2G, and FLDLN2 instructions, respectively. These constants have full extended-real precision (64 bits) and are accurate to approximately 19 decimal digits. The 80387 allows rounding of these internal constants according to the rounding control (RC) bits (bits 11 and 12) of the control word. If the RC bit is set to the Nearest rounding mode, the 80387 produces the same constant as produced by the 80287.

Denormal Operations

The 80387 allows the use of denormal operands with FBSTP (packed decimal

Processor Initialization and Control

During initialization of an 80386 system, system software must recognize the presence or absence of an FPU and set flags in the 80386 machine status word to reflect the state of the numeric environment. If an 80387 is present, it must also be initialized.

Recognizing the 80387

Listing A shows a routine to determine the presence of a coprocessor (8087, 80287, or 80387). The algorithm first tries to determine if a coprocessor is present by examining the status and control words. An affirmative test confirms

the presence of a coprocessor. To test for the presence of an 80387, both positive and negative infinities are generated and their values compared. Since the 80387 differentiates between positive and negative infinities, this comparison indicates that the two infinities are different. The 80287, however, does not differentiate between the two infinities.

This program sets the word at $SS:FFFEH$ to 0 if no FPU is present, to 1 if an 8087 or 80287 is present, and to 2 if an 80387 is present. Once this test has been performed and the word at $SS:FFFEH$ appropriately set, a program

Listing A: A routine to check for the presence of a math coprocessor.

```

dgroup    group    data
cgroup    group    code

code segment public 'code'
    assume  cs:cgroup,ds:dgroup
;
; Look for an 8087, 80287, or 80387 NPX.
; Note that we cannot execute WAIT on 8086/88 if no 8087 is
; present.
; Set word at SS:FFFEH to 0 for no NPX, 1 for 8087 or 80287, 2
; for 80387
;
test_npx:
    fninit                ; Init NPX, must use non-wait form!
    mov  si,0ffffh        ; Set offset of status variable
                                ; SS:FFFEH can be accessed at any time
    sub  si,bp            ; [BP+SI] points at SS:FFFEH
    xor  dx,dx            ; Clear NPX status flag
    mov  word ptr [bp+si],5A5AH ; Initialize temp to non-zero
                                ; value
    fnstsw [bp+si]        ; Must use non-wait form of fstsw
                                ; It is not necessary to use a WAIT
                                ; instruction
                                ; after fnstsw or fnstcw. Do not use one
                                ; here.
    cmp  [bp+si],dl       ; See if correct status with zeroes was
                                ; read
    jne  set_flags        ; Jump if not a valid status word,
                                ; meaning no NPX
;
; Now see if ones can be correctly written from the control
; word.
;
    fstcw [bp+si]        ; Look at the control word do not use
                                ; WAIT form
                                ; Do not use a WAIT instruction here!

```

BCD store and pop), FDIV (divide real), FIST (integer store), FISTP (integer store and pop), FPREM (partial remainder), and FSQRT (square root) instructions. This differs from the 80287, which raises an

invalid-operation exception when denormal operands are passed to these instructions.

Exceptions occur whenever the 80387 receives an invalid operand or produces a

needs to just examine the value at SS:FFEH to determine which FPU is present. This can also be used to execute different code, depending on whether an 80287 or an 80387 is present.

80387 Initialization

There is a difference in FPU initialization between the 80287 and the 80387. Either the FINIT or FNINIT instruction initializes the 80387 to a state compatible with the state of the 80287 after FINIT or a hardware RESET. A hardware RESET of the 80387, however, leaves it in a state that is *not* the same as its state

after a FINIT or FNINIT instruction. The two states have these differences:

1. The mask bit for the invalid-operation exception is reset.
2. The invalid-operation exception flag of the status word is reset.
3. The exception-summary bit of the status word is set.

These settings cause the FPU to assert the ERROR# output to indicate that an 80387 is present. It is, therefore, necessary to execute an FNINIT instruction after a hardware reset of the 80387.

```

mov ax,[bp+si]      ; See if ones can be written by NPX
and ax,103fh       ; See if selected parts of control word
                    ; look OK
cmp ax,3fh         ; Check that ones and zeroes were
                    ; correctly read
jne set_flags      ; Jump if no npx is installed
;
; Some numerics chip is installed. NPX instructions and WAIT
                    ; are now safe.
; See if the NPX is an 8087/287 or 80387.
; This code is necessary if a denormal exception handler is
                    ; used or the
; new 80387 instructions will be used.
;
inc dx             ; Indicate 87/287 by default status=1
fldl              ; Must use default control word from FNINIT
fldz              ; Form infinity
fdiv              ; 8087/287 says +inf = -inf
fld st           ; Form negative infinity
fchs              ; 80387 says +inf <> -inf
fcompp            ; See if they are the same and remove
                    ; them
fstsw [bp+si]     ; Look at status from FCOMPP
mov ax,[bp+si]
sahf              ; See if the infinities matched
je set_flags      ; Jump if 8087/287 is present
;
; An 80387 is present. If denormal exceptions are used for an
                    ; 8087/287,
; they must be masked. The 80387 will automatically normalize
                    ; denormal
; operands faster than an exception handler can.
;
inc dx            ; Set status variable to 2
set_flags:
mov [bp+si],dx

```

result that cannot be represented. When an exception occurs, the 80387 does one of the following:

1. Handles the exception itself by invoking

the default exception handler. This happens when the exception is masked (i.e., the corresponding mask bit in the control word is set to 1).

2. Signals the host (80386) that an excep-

tion has occurred and invokes a user-supplied exception handler. This is the case when the exception is unmasked—that is, the mask bit in the control word is set to 0.

Types of Exceptions

The 80387 recognizes six types of exceptions: (1) invalid operation; (2) divide-by-zero; (3) denormal operand; (4) numeric overflow; (5) numeric underflow; and (6) inexact result. These six types are described in detail below.

- *Invalid operation*: An invalid-operation exception occurs in two situations: An arithmetic instruction encounters an invalid operand, or a stack operation results in a stack overflow or underflow. As described earlier, the 80387 recognizes two kinds of NaNs—signaling and quiet. An invalid-operation exception is usually raised only upon encountering a signaling NaN. The instructions FCOM, FIST, and FBSTP, however, flag an invalid-operation exception on quiet NaNs. The 80287, on the other hand, signals an invalid-operation exception upon encountering any kind of NaN, since it does not differentiate between two NaNs.

While the 80287 defines and supports special handling for pseudozero, pseudo-NaN, pseudoinfinity, and unnormal formats, the 80387 neither generates nor supports these formats and raises an invalid-operation exception whenever it encounters them in an arithmetic operation.

- *Divide-by-zero*: A zero-divide exception is reported whenever an attempt is made to divide a finite number by 0. This can happen in instructions like FDIV, FDIVP, FIDIV, FDIVR, FDIVRP, and FIDIVR that do explicit divides or in instructions that do divides internally, such as FYL2X ($y \times \log_2 x$) or FXTRACT (extract exponent and significand). If the zero-divide exception is masked, the 80387 responds by returning infinity signed with the exclusive-OR of the signs of the operands in the case of divide (FDIV, etc.) and FYL2X instructions. For FXTRACT, ST(1) is set to negative infinity and ST is set to 0 with the same sign as the original operand. In the event of an unmasked divide-by-zero exception, the operands remain unchanged.

- *Denormal operand*: The 80387 reports a denormal-operand exception whenever an attempt is made to operate an arithmetic instruction on a denormal operand. The masked response for the instruction is to set the DE-bit (bit 2) of the status word and to then proceed with the instruction.

The 80387 does not raise an invalid-operation exception when it encounters a

continued

INFO 286[®]

TURBO SYSTEM

The fastest IBM™ AT™ Compatible

SUPERCHARGED SPEED

12MHz

286 CPU

10 MHz option available



Features:

- Intel 80286-10 microprocessor
- 6/12 MHz switchable clock speed
- Expandable to 1MB on board
- Chips & Technology VLSI chipset
- CMOS memory to maintain system configuration
- Legal BIOS
- Clock/calendar with battery backup
- 8 I/O slots - 6 w/62 & 36-pin card-edge connectors
- 2 w/only 62-pin card-edge connectors
- 200W power supply (220V-110V)
- XT size case w/keylock protection, reset switch, and LEDs for turbo, hard drive, and power on/off
- Enhanced keyboard w/separate cursor, keypad, and cross top function keys
- 20% smaller than IBM's AT™ system
- Operation manual
- Assembled and tested

FCC Class B Approved!

Dealers and distributors welcomed

Immediate delivery available
Full one year warranty

Please call for more information on FCC approved add-on cards and AT™ compatible components!!

800-322-4556 MAIL ORDER HOT LINE

Increase your profit margin!

Taiwan

Low Price!
High Quality!

Manufacture Direct

May Computers Corp.

(Manufacture Direct)

8210 Katella Ave., #D, Stanton, CA 90680

(714) 897-2037 (10 Lines)

Telex: 3/20112 MAY / FAX: (714) 897-9173

80387 COPROCESSOR

80387 Performance

The 80387 provides a considerable speed improvement over its predecessor, the 80287. This has been accomplished by using a higher clock speed, an optimized core that takes fewer clocks per instruction than the 80287, and new transcendental instructions. Benchmark results on a system using a 20-MHz 80386 and 80387 show that the Double-Precision Whetstone Performance Index for the 80387 is 1.8 mega-Whetstones. Whetstone is a measure of the number of floating-point computations that can be computed by the processor per unit time.

Using an 80387 in a Compaq Deskpro 386/20 Model 30 reduces the time to remove hidden lines from a sample draw-

ing of the space shuttle using the AutoCAD version 2.62 HIDE command by a factor of 2.6 over the 80287 used in a Compaq Deskpro 286 Model 40. (Source: Compaq Deskpro 386/20 Personal Computer Features/Specifications).

For results of performance tests performed at BYTE on the 80387, see table 1 in "The Intel 80387 vs. the Weitek 1167" by Tom Thompson on page 205.

Compilers available for the 80386 from Green Hills, MetaWare, Silicon Valley Software, Language Processors, and Austec provide a switch for the 80387 that allows the compiler to generate in-line 80387 instructions.

Table 4: The result range of operands depends on the relationship between the operands.

Sign(y)	Sign(x)	y < x ?	Final result
+	+	Yes	$0 < \text{atan}(y/x) < \pi/4$
+	+	No	$\pi/4 < \text{atan}(y/x) < \pi/2$
+	-	No	$\pi/2 < \text{atan}(y/x) < 3 \times \pi/4$
+	-	Yes	$3 \times \pi/4 < \text{atan}(y/x) < \pi$
-	+	Yes	$-\pi/4 < \text{atan}(y/x) < 0$
-	+	No	$-\pi/2 < \text{atan}(y/x) < -\pi/4$
-	-	No	$-3 \times \pi/4 < \text{atan}(y/x) < -\pi/2$
-	-	Yes	$-\pi < \text{atan}(y/x) < -3 \times \pi/4$

Table 5: The rounding modes of the 80387.

Rounding mode	Sign of true result	Result
To nearest	+	$+\infty$
	-	$-\infty$
Toward $-\infty$	+	Largest finite positive number
	-	$-\infty$
Toward $+\infty$	+	$+\infty$
	-	Largest finite negative number
Toward 0	+	Largest finite positive number
	-	Largest finite negative number

denormal operand in FSQRT, FDIV, or FPREM, or upon conversion to BCD or to integer. The operation proceeds by first normalizing the value. The 80287 will raise an invalid operation in such cases. Furthermore, the 80387, in contrast with the 80287, reports a denormal exception if a denormal operand is found in transcendental instructions and in EXTRACT.

• *Numeric overflow and underflow:* Numeric overflow and underflow exceptions occur when the exponent of a numeric result is too large or too small, respectively, to be represented in the destination format.

The masked response to the numeric overflow exception depends on the

continued

Disk Technician+™

 Automated AI Software System

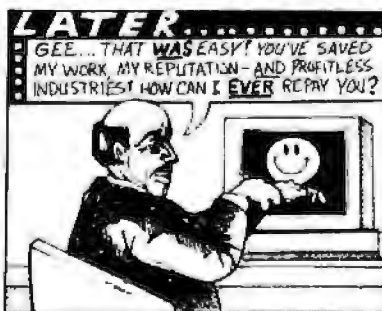
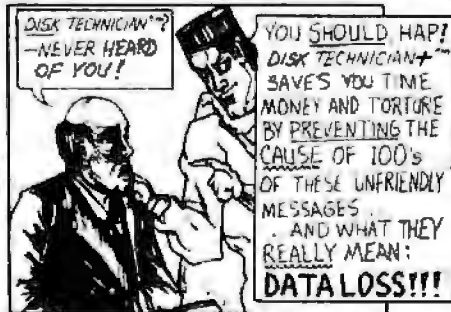
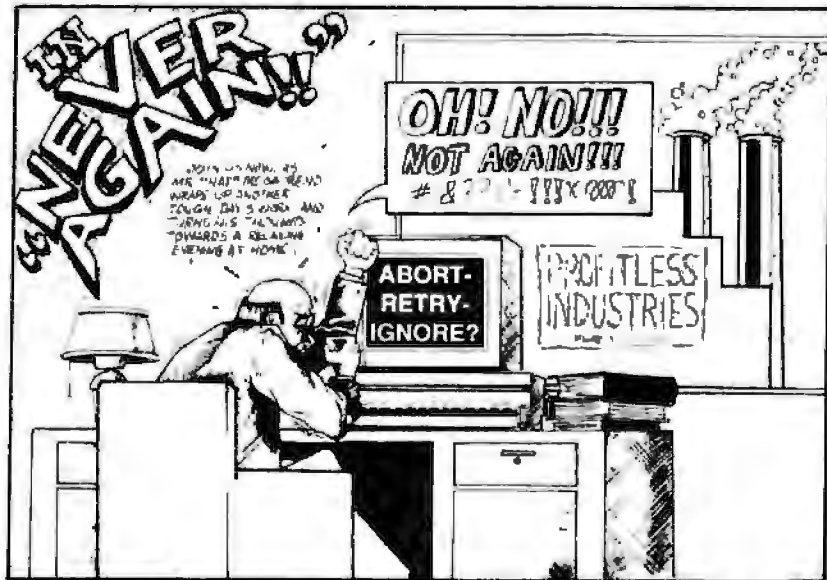
INTRODUCING THE AD-VENTURES OF
★★DISK★★
TECHNICIAN™ **OUR HERO IN THE WAR AGAINST THE COSTLIEST PROBLEM IN BUSINESS COMPUTING TODAY!!!**



Disk Technician+™

 Automated AI Software System

Each Disk Technician+ Automated AI Software System is designed to work with 2 hard disk drives, up to 136 megabytes each with MFM-type controllers, or up to 208 megabytes each with RLL-type controllers, — provided they are partitioned in up to 24 logical drives — no larger than 32 megabytes each — on IBM PC:XT:AT, derivatives and true hardware/software bios compatible IBM clones. Requires a single 5-1/4" floppy drive and 512K of RAM.

"Because You Cannot Afford To Lose Data."

Now Available at Your Local Dealer or Order Factory Direct!
 VISA • Mastercard • Eurocard accepted. Need More Information? Just Call or Write Today!
800 847 5000 or 619 274 5000

PRIME SOLUTIONS INC™
 We Make Technology Easy And Affordable™
 1940 Garnet Avenue - San Diego, CA 92104

See Reviews In: PC Magazine - New York Times
 New York Law Journal - Tokyo PC Newsletter
 PC-Computer Reseller News - PCM-REMark

SWITCHING POWER SUPPLY

1 For PC-AT 220W	3 For PC-XT 135W, 155W
	
2 For BABY AT 200W	
	
4 For TV GAME	a. 5V/7A, 12V/1A, 5V/1A b. 5V/10A, 12V, 1A, 5V/1A
	

CYE

CHUNG YU ELECTRONICS CO., LTD.
 P.O. BOX 30-535 TAIPEI, TAIWAN, R.O.C.
 FAX, 002-886-02-3971968 TLX, 24451 CYELEC
 TEL. 002-886-02-3918100, 3414596

rounding mode. Table 5 shows the results of the computation for various rounding modes. The masked response in the case of rounding mode set to chop (i.e., toward 0) is to produce the most positive or the most negative number. The 80287 will not report an overflow exception in a similar situation. It will, in fact, signal overflow only when the rounding control mode is *not* set to round to 0.

If the overflow exception is not masked in the 80387, it raises the precision exception (inexact result). When the result is stored on the stack, the significand is rounded according to the precision control (PC) bits (bits 9 and 10) of the control word, or according to the op code. In the 80287, on the other hand, the precision exception is not reported, nor is the significant rounded.

The underflow exception is flagged by the 80387 if the true result is so small that it cannot be represented in the destination format. When the underflow exception is masked, it is signaled when there is a loss of accuracy in the result. The 80287 will report the underflow exception on underflow if rounding is toward 0, regardless of loss of accuracy.

If the underflow exception is unmasked and the result is to be stored on the stack, the significand is rounded according to the precision control bit of the control word in the 80387. The 80287 does not round the significand on the stack.

- *Inexact result:* If an operation produces a result that cannot be represented exactly in the destination format, the inexact-result exception is reported. The inexact exception is also raised in the event of an underflow exception with a loss of accuracy.

The 80387 does not give precedence to the denormalized exception, whether it is masked or not. In the 80287, the unmasked denormal exception takes precedence over all other exceptions.

Programming Examples

Listing 1 shows an example of 80387 code to compute $y=e^z$. Note that $e^z = 2^{z \times \log_2 e}$. The program first checks to find out whether an 80387 or an 80287 is present. This is done by examining the value stored at SS:FFFEH. If an 80387 is present, the code takes advantage of the fact that the instruction F2XM1 accepts operands in the range $-1 < z <= 1$. First, the largest integer X that satisfies the condition $z \times \log_2 e = x + y$ is found. Note that all values of y satisfying the above condition must lie in the range $-1 < y <= 1$. The expression $2^{x \times \log_2 e}$ is computed by computing the expression $2^x \times [(2^y - 1) + 1]$. Slightly different code is used to compute e^z if an 80287 is pre-

POWER TOOL.

Introducing 4x488™

You get intelligent IEEE-488 and RS232 ports to make instrument programming fast and easy.

You can have up to 4 Mbytes of memory on the same board for your largest programs, RAM disks, and data acquisition tasks.

Compatibility is built-in so you can run your favorite programs or create new ones with our advanced programming tools.

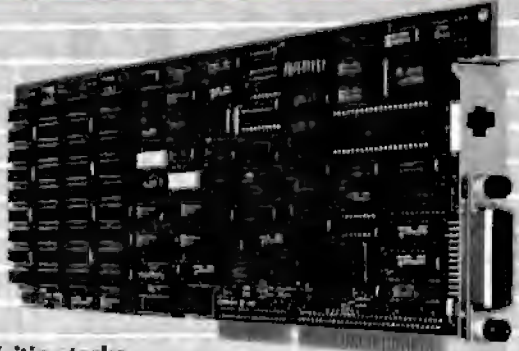

To get your FREE demo disk—call 617-273-1818.

Capital Equipment Corp.
 Burlington, MA 01803

The bottom line—IEEE-488, RS232, par. port, 4MB EEM LIM, runs DOS and OS/2.

Listing 1: A code sample illustrating the use of 80387 instructions.

```

; compute ez, assume Z is in ST
FLDI
CMP SS:BYTE PTR 0FFFFH,1 ; 80287 or 80387?
JE USE_287
; 80387 found
FLDL2E ; load log2e
FMUL ST, ST(2) ; ST = Z * log2e
FST ST(2)
FPREM ; reduce ST between -1 and 1 F2XMI
FADD
FSCALE
FSTP ST(1)
RET
USE_287: ; 80287 found
FCHS
FLDL2E
FMUL ST, ST(2)
FST ST(2)
FIST
JB NEG_VAL
FPREM
FSCALE ; positive value
F2XMI
FSUBR
FMUL ST, ST(0)
FSCALE
FSTP ST(1)
RET
NEG_VAL: ; negative value
FPREM
FCHS
FSCALE
F2XMI
FSUB ST, ST(1)
FMUL ST, ST(0)
FDIV
FCHS
FSCALE
FSTP ST(1)
RET

```

Listing 2: Sample code illustrating the use of built-in transcendental functions.

```

; compute ARCSIN(Z), assume Z in ST
FST ST(1) ; ST(1) = ST = Z
FMUL ST, ST(0) ; ST = Z^2
FLDI
FSUBR ; ST = 1-Z^2
FSQRT ; ST = SQRT(1-Z^2)
FPATAN ; ST = ARCTAN(Z/SQRT(1-Z^2))
RET

```

sent, since the F2XMI instruction in the 80287 supports only operands in the range $0 < z <= 0.5$.

An example of how to compute the function $\text{ARCSIN}(z)$ is illustrated in listing 2. It makes use of the relationship $\text{ARCSIN}(z) = \text{ARCTAN}(z/\text{SQRT}(1-z^2))$.

New Look

The 80387 provides the system designer with significant enhancement in features

and speed over the 80287. It fully conforms to the IEEE 754-1985 Standard for Binary Floating-Point Arithmetic. While maintaining object-level compatibility with the 8087 and the 80287, it provides the 80287 set of floating-point instructions with additional trigonometric, un-ordered comparison, and partial-remainder instructions. The operand ranges for some 80287 instructions have been expanded in the 80387. ■

IEEE-Z

Our Personal486™ IEEE (GPIB) interfaces for PC/AT/386 & PS/2s are packed with these easy-to-use features:

- DOS device driver loads at power-on
- Hewlett-Packard style commands
- Automatic error indication
- BASIC ON SRQ GOSUB capability
- DMA transfers over 300K bytes/s
- Up to four IEEE boards/computer
- NEC-7210 compatible software
- Serial/Parallel/IEEE port redirection
- DMA and interrupt channel sharing
- Compatible with popular languages (no extras to buy), including BASICA, GWBASIC, Quick BASIC, Compiled BASIC, Turbo BASIC, True BASIC, TBASIC, Turbo Pascal, Microsoft Pascal, Turbo C, Microsoft C, Aztec C, Lotus 1-2-3/Symphony/Fortran, ASYST, DADISP, Test Windows, AutoCAD, and many more.

- 30 day money-back guarantee
- 2 year warranty
- Call or send for your FREE Technical Guide

Lotech

(216) 439-4091 Tel: 6502820654 Fax: (216) 439-4093
 25971 Cannon Road • Cleveland, Ohio 44146
 London 01748 6612 87 • Paris 01 48 01 76 • Zurich 00 821 9444
 Milan 02 4120560 • Tokyo 03 31 01 40 • Amsterdam 010 60 5533
 Vienna 01222 253626 • Munich and other European, South African and
 Middle East countries, not listed (099) 710031

Circle 124 on Reader Service Card



"THE A★STAR'S CPU PERFORMANCE IS SUBSTANTIALLY ABOVE THAT OF THE IBM PS/2 MODEL 60."

-INFOWORLD



WHO CARES!

For about \$5300, you could own an IBM PS/2 Model 60. But for as little as \$1100, you could own a Wells American A★Star[®] that can outperform it. Of course, for nearly the same money as an A★Star, you could also own any number of Asian built no-name clones.

But then you wouldn't be getting the exclusive ownership advantages that *only* the A★Star offers. Advantages like an 80286 CPU that runs the new MS OS/2 operating system and can also run at 6, 8, 10, 12, 14 and now...16 MHz! And you wouldn't be getting schematics. (Ours are free!) Or GE/RCA on-site maintenance. Or a no questions asked money-back guarantee. Oh, and there's one more little item you wouldn't get... peace of mind. Wells American has been making microcomputers longer than IBM!

In fact, we've probably been making microcomputers longer than *anybody*!

But hey, who are we kidding? Not everyone cares about quality, reputation, support or serviceability. That's why there are mail-order houses. And, as hard as it is to believe, not everyone cares about money or performance. Maybe that's why there's IBM (and Compaq[®]...and all the others). But, for computer users who *do* care, there is, fortunately, a vendor who also cares...Wells American. And, we'd like to prove it to you. Call us with the page number of this ad. It's worth a big discount on your next A★Star computer system.

Call today. 803/796-7800. This offer *is* limited.



Corporate Headquarters: 3243 Sunset Boulevard • West Columbia, South Carolina 29169 • 803/796-7800 • TWX 510-601-2645

IBM, OS/2 and PS/2 are trademarks of International Business Machines Corporation.

Floating-Point Survival Kit

*An insider's look at number-crunching fundamentals,
standards, benchmarks, and high-performance designs*

Pete Wilson

MICROCOMPUTERS HAVE NEVER been better at number crunching. In computation-bound applications, high-end microprocessors actually can outstrip some minicomputers. And they're getting better.

The performance of the new 32-bit machines is an order of magnitude greater than the old 80286-family devices. Now every vendor (of microprocessors, personal computers, and workstations) is increasingly claiming magnificent performance levels on sundry benchmarks.

While this is fun for the vendors, it can be confusing to purchasers. How can you judge how good a design might be for number crunching? What, if anything, do the various benchmarks mean? To help provide some answers, I'll review the fundamentals of floating-point arithmetic, examine some issues in building floating-point systems, skim over some benchmarks, look at how machine designers get high-performance floating point, and then wrap it all up with some words of advice.

What Is Floating Point?

Integer arithmetic is useful for many applications. However, when an application needs to deal with a very wide dynamic range of values, integers fall short. A 32-bit processor, doing integer arithmetic, can deal simply with a range of values where the largest value is no more than 2^{32} (about 4000 million) larger than the smallest, while a 16-bit machine can handle—with the same ease—a range of just 65,536 to 1.

The need for wider ranges arises in sit-

uations as disparate as quantum cosmology (mixing subatomic dimensions with astronomical distances in the same program) and CAD (where the smallest components have tolerances in microns but the complete project covers some city blocks).

We could deal with these situations by doing multiword (e.g., 96-bit) integer arithmetic with our processors, but it is usually more convenient to use floating-point arithmetic. Floating point buys—for a given bit budget—a vastly wider dynamic range in values. The price paid is that the answers have less resolution and the execution time or hardware cost is greater than if we had been able to stick with word-length integer arithmetic.

A 32-bit processor doing integer work represents each integer as a word: all 32 bits of the word are used to represent the size of the variable. A 32-bit processor doing floating-point work breaks each 32-bit word up into two separate fields: one field is a number, while the other is a scaling factor for that number. Many choices are possible for the meanings of these two fields: For example, the value field could represent an amount in the range 0.25 to 0.5, while the scaling factor represents the number of places to shift the value field left (positive factor) or right (negative factor) to compute the value of the number.

Doing arithmetic in floating point has a number of pitfalls; things don't always work the way you might expect. To illustrate some of these issues, I'll work through some simple examples. First, let's adopt a floating-point format which

packs an unsigned 24-bit value field (the mantissa, also known as the significand) and a signed 8-bit scale field (the exponent) into a 32-bit value. The mantissa represents numbers in the range 0.25 to (nearly) 0.5 (so the most significant bit of the mantissa means 0.25, and the least significant bit means 2^{-24}) and is unsigned to keep the examples simple. This format can deal with numbers in the range of about 0.25×2^{-128} to 0.5×2^{127} , or about 10^{-40} to 10^{40} .

Using this representation, let's look at converting the values from fixed-point binary to floating point. Fixed-point binary represents numbers as *Integer.Fraction*, where *Integer* is a (possibly multiword) bit pattern representing the integer portion of a number, and *Fraction* is a (possibly multiword) bit pattern representing the fractional part; the most significant bit of the fractional part has value 0.5, and the least significant bit of *Integer* has value 1. We shift the binary point in *Integer.Fraction* until its value lies in the range 0.25 to 0.5; that value becomes the mantissa. The number of shifts required becomes the exponent of the floating-point number. If the original number was larger than 0.5, we shifted it down, so the exponent is a negative number; if the value was smaller than 0.25, we shifted the binary fixed point up, and

continued

Pete Wilson, a computer architecture engineer at Prisma Inc., can be reached at 5465A Mark Dabbling Rd., Colorado Springs, CO 80918. When this article was written, he worked for INMOS Corp.

Implementing Floating Point

Implementing IEEE floating point in hardware or software is not easy. First, the standard itself calls for some complex operations. Second, it matters to some customers that the results are correct. (You wouldn't want an air traffic control system to have errors in the floating-point hardware used in the radar systems to track the planes.) The combination is a nuisance because it is too complex to test—there are too many possible combinations to look at (suppose you wanted to test the double-length operations; then there are four operations (+, -, *, /) to be done on pairs of 64-bit numbers; this corresponds to $2^{(4+4+4+4)}$ or about 10^{30} . At a nanosecond per operation, this takes about 10^{20} seconds, which is too long to wait to bring something to market, even if we had some means of getting the correct answers fast enough to do the comparisons.)

Because of this, when INMOS decided to build the T800—a microprocessor combining a 32-bit integer CPU, an IEEE floating-point unit (FPU), 4 kilobytes of memory, an eight-channel direct memory access (DMA) driving interprocessor communications channels plus other facilities—it was necessary to take a different approach.

The approach was simple; if it's impossible to show by testing that the design is correct, then it is necessary to create a design which is provably correct. The situation is much the same—but noticeably more complex—as the exercises we did at school in geometry to prove relationships (e.g., the Pythagorean theorem). The basis is to have a language of some form (Pythagoras used the language of geometry) in which you can describe the situation and which has appropriate rules that allow you to demonstrate that two statements in the language either do or don't mean the same thing. Then you write a description of IEEE arithmetic and a description of your design and show that they are equivalent. Then your design is correct.

In practice, more than one language was needed. It was done like this: First, a description of IEEE arithmetic was written in a language called Z, which was created by Jean-Raymond Abrial and has been developed and used extensively by members of the Oxford University Programming Research Group (PRG), with whom INMOS worked very closely in this project. Z was de-

signed to tackle the problems of specifying real systems. You specify things in Z quite straightforwardly; the example in figure A shows a Z specification of the range checking that needs to be done inside IEEE arithmetic.

The specification is labeled with its name and consists of a box with an upper and a lower portion. The upper portion is equivalent to the declaration section of

a programming language; here it says that there is something called Areg that is a Floating_Point_Register, and something called Error_Flag that is a Boolean. Both have values associated with them; the names are the values prior to the operation, and the primed names are the values after the operation.

The lower portion of the box contains constraints on the values that the things

a) Floating check integer range module

```
Areg, Areg' : Floating_Point_Register
```

```
Error_Flag, Error_Flag' : bool
```

```
forall Z
```

```
Areg' = Areg
```

```
forall Areg e [MinInt, MaxInt] -> Error_Flag' = Error_Flag
```

```
forall Areg e [MinInt, MaxInt] -> Error_Flag' = true
```

b) High-level Occam representation

```
IF
  Areg.Exp < LargestINTExp
  SKIP
  (Areg.Sign = NEGATIVE) AND (Areg.Exp =
    LargestINTExp) AND
    (Areg.Frac = MSBit)
  SKIP
  TRUE
  setError(ErrorFlag)
```

c) Low-level Occam representation

```
SEQ
  AregSignNEGATIVE := (Areg.Sign = NEGATIVE)
  ExpZbus := (Areg.Exp - LargestINTExp)
  ExpZbus := ExpZbus < 0
  IF
    AregSignNEGATIVE
    /*... do the negative case */
    NOT AregSignNEGATIVE
    IF
      ExpZbusNeg
      SKIP
      NOT ExpZbusNeg
      setError(ErrorFlag)
```

Figure A: Example of the specification language Z and its equivalents in Occam and microcode.

in the upper portion can have. Here *fv* is a function that returns the value of a floating-point register (*Z* is the set of floating-point values). We see that the values of *Areg* before and after the operation are the same; and we see that whenever the value in *Areg* (looked upon as a floating-point number) is in the range [*MinInt* to *MaxInt*], the value of the *Error_Flag* after the operation is

whatever it was before, and that if the value in *Areg* isn't in that range, then *Error_Flag* contains the value true after the operation.

The first step in the exercise was to create specifications for all the operations needed for IEEE arithmetic in this form to provide a formal specification of just what IEEE arithmetic is. The next step is to create an equivalent descrip-

tion in another language—one that will be more useful in describing an implementation with its microcode, registers, and other detailed nasties—and to prove that the *Z* description and the new description are the same.

The language Occam was chosen for this; Occam has a formal semantics (i.e., every legal Occam statement has an unambiguous meaning) and so it is possible to demonstrate the equivalence of an Occam program to a *Z* specification. The Occam specification of the range-checking operation is shown; it is as close as practical to the *Z* specification. Proving that this is correct means proving two assertions—first, that there is an exponent (*LargestINTExp*) such that every register with a smaller exponent has a value in the range [*MinInt*..*MaxInt*]; second, that a register with a negative exponent sign bit, an exponent of *LargestINTExp*, and a mantissa with only the implied most significant bit set has a value of *MinInt*.

The Occam description is then moved a step closer to a real implementation by involving facilities and operations that are available from the microcode. This description is then itself taken and transformed yet again to use a microcode instruction pointer. Finally, this last Occam representation is taken and converted into real microcode.

To ensure that these successive transformations are all correct, two methods are used. One is to use the formal semantics of Occam; you can demonstrate that two programs in Occam do or do not have the same effect (if they have the same effect, if one is correct then the other one must be). The other is to use automatic translators—for example, getting microcode from Occam text can be done by a program which is analogous to a C compiler's preprocessor: it is a pattern-matching and textual-substitution program.

Being able to do something "in principle" isn't quite good enough in practice, and the design work wasn't done in the sequence outlined here. Rather, what happened was that the *Z* specification of the arithmetic was done first, and then an Occam implementation of the IEEE package that already existed (it implemented the floating point for the INMOS T414) was shown to be equivalent; this involved two transformations.

continued

d) Microcode-like Occam

```
INT NextInst;
SEQ
  NextInst := FloatingPointCheckIntegerRange
  WHILE NextInst <> NOWHERE
    IF
      NextInst = FloatingPointCheckIntegerRange
      SEQ
        AregSignNEGATIVE := (Areg.Sign = NEGATIVE)
        ExpZbus := (Areg.Exp - LargestINTExp)
        ExpZbus := ExpZbus < 0
        IF
          AregSignNEGATIVE
            /*... do the negative case */
          NOT AregSignNEGATIVE
        IF
          ExpZbusNeg
            NextInst := NOWHERE
            NOT ExpZbusNeg
            NextInst := OutOfRange
            NextInst=OutOfRange /* now setting error has
                                its own microinstruction /
        SEQ
          SetError(Errorflag)
          NextInst := NOWHERE
          /*... other microinstructions */
```

e) Microcode version

```
FloatingPointCheckIntegerRange:
ConstantLargestINTExp
ExpXbusFromAreg      ExpYbusFromConstant
ExpZbusFromXbusMinusYbus

GOTO Cond1FromAregSign -> (Cond0FromExpZbusNeg ->
                          (...),
                          Cond0FromExpZbusNeg ->
                          (NOWHERE, OutOfRange)
```

so the exponent is positive.

Shifting occurs a great deal in floating-point work; any processor that wants to get reasonable performance without a coprocessor will normally provide a specialized instruction set for the operation. The instruction—*normalize*—examines the number to be converted, starting at the most significant bit. It moves down the word until it finds two adjacent bits of different value; suppose bit n and $n-1$ are found to be 0 and 1. The mantissa is then simply obtained by shifting the whole word left by (word length $-n$) bits and setting the exponent to n .

Grainy Numbers

Given this picture, a number of facets of doing arithmetic in floating point can now be illuminated. First, note that it is not possible to represent exactly all numbers using floating-point format. For our 32-bit format, for example, it is possible to represent every integer between 0 and 2^{24} (8,388,608). But we cannot exactly represent all the fractions, nor can we represent all the integers larger than 2^{24} ; 2^{24} is represented as 0.5×2^{26} ; the smallest value we can add to that is $2^{26} \times$ the least significant bit of the mantissa, which is 0.5×2^{-24} , with a value of 0.5×2^2 . This is 2. So the "next" number after 8,388,608 is 8,388,610. This example shows that there are gaps in the numbers that can be exactly represented.

This phenomenon is often referred to as the "graininess" of floating-point numbers; just as high-speed photographic film can obscure fine detail by its large grain size, so can each floating-point number represent a range of numbers in the real world up to a certain limit on detail.

This graininess has two important side effects; first, if you try to add a very small number to a very large number, the result can be that the large number is unchanged. So don't try to write program loops that say FOR $i=0$ TO 100000000 STEP 1 unless you're sure that adding the step size actually changes the number. And if you subtract two large values, the result can be inexact, so be careful when using the results of such subtractions. A related problem is that since the numbers aren't exact, it is not unusual to find that the program that says IF $a=b$ THEN ... doesn't work reliably.

How is the number 0 to be represented? Looking at the situation simply, any floating-point number with a 0 mantissa has a value of 0. But the rules say that mantissae have to be in the range 0.5 . . . 0.25, so properly speaking we cannot have a floating-point 0 in the number scheme. Instead, most schemes have a special representation for 0. This might

be mantissa=0, exponent = -127, for example. Such "special case" representation is useful because it gives us access to lots of bit patterns that are not legal floating-point numbers that we can use to indicate special circumstances. Now, for example, we can choose another of the bit patterns to mean infinity, so rather than just complaining "overflow" when we divide the largest possible number by the smallest, we can set the result to infinity.

Sometimes it is useful to relax the rule that says the mantissa must be in the normalized range. For example, try dividing 0.25 by the largest possible number. The result is a quarter of the smallest possible number, which we could represent simply enough if we allow the mantissa to have a value outside the 0.25 . . . 0.5 range.

Numbers like this, whose mantissae are too small, are called "denormalized." Their only real problem is that they are even less accurate than the normalized numbers. Nevertheless, they are still useful—provided the programmer has been careful with the organization of the arithmetic—in that they provide some indication of the answer even when the exact value is unrepresentable.

The Need for Standards

Suppose we change our floating-point format from 24-bit mantissa and 8-bit exponent to have a wider dynamic range—say 22 bits of mantissa and 10 bits of exponent. Then we'll find that running exactly the same program with this scheme will, in general, give us quite different answers from our initial scheme.

This is what used to happen when people moved programs from one computer to another. The various computers all had slightly different floating-point schemes, and programmers had to be highly competent numerical analysts to design programs that were robust enough to provide useful answers when they were moved between floating-point schemes. This was a real nuisance; it was a situation crying out for a standard.

Such a standard now exists: the IEEE standard 754-1985. The document specifies a standard for the representation of binary floating-point numbers and for the rules governing rounding, truncating, and accuracy. All the major manufacturers of microprocessors support the standard (e.g., Intel's 8087, 80287, and 80387; Motorola's 68881 and 68882; INMOS' T800 and T414).

The standard specifies three formats—for single length, double length, and extended-format floating-point values. Single length fits in 32 bits and comprises 24 bits of mantissa and 8 bits of exponent; double length puts 53 bits of mantissa and 11 bits of exponent into 64 bits, and

extended uses 80 bits for a 64-bit mantissa and 16-bit exponent.

Accuracy and Loops

Why use the double format instead of the single? Often, single-length operations go faster (especially multiply and divide) and need less memory. The problem is that, loosely speaking, every time you combine a pair of numbers you lose up to a bit of accuracy. Suppose you multiply two single-length floating-point numbers. The result should have 48 bits of mantissa, but it only has 24 bits; if renormalization was necessary, some bits that mattered will have been lost. The same things happen—even worse—with division.

So if you write a program that does lots of operations repeatedly on a set of numbers, they slowly lose accuracy as low-order bits slip off the bottom. The simple cure is to use as many bits of mantissa as possible—thus the attraction of double-length and extended formats.

The effects of this accumulating round-off error are worst in programs that keep crunching on numbers; big loops that compute stuff on one iteration and use the results in the next, which produces results for the next iteration (and so on), are obvious dangers.

Measuring Performance

Now suppose that you have a numerically demanding application and you need to choose a system on which to run it. With the more or less universal adoption of the IEEE standard, you can be reasonably sure (barring implementation errors—see the text box "Implementing Floating Point" on page 218) that all the alternatives will give you the same (hopefully correct) answer. But they'll take varying amounts of time to do it. If you need very high performance, then it can matter which machine you buy.

There are two classical answers to the problem. One is the not very helpful suggestion that you try your application out on every machine and then buy the fastest: the problem with this is that the cost can be very high (even if you can find a machine nearby) and that, in any case, your application is likely to change. So then you'd have to do the whole exercise over again. What's needed is some program whose performance on a range of machines is a good predictor of how well other programs will run on those machines. All you need to do is to find a good predictor program, run it on the candidate machines, and choose the fastest.

This is the second classical answer: the predictor programs are called benchmark

continued

programs, and the whole process of benchmarking is fraught with pitfalls. While in practice the only realistic way to get some hint of comparative performance is to use benchmark programs, it is important to understand both the needs of your own application and the strengths and weaknesses of the benchmarks themselves.

As an example, consider the benchmarks that have become accepted as indicators of integer performance: The Sieve of Eratosthenes and the Dhrystone are both widely used. Trouble is, neither of these is any good at predicting the performance of a real program on the machines. The Sieve is a very small program, so it fits completely inside the instruction cache of many modern microprocessors when real applications generally won't; the result is that the Sieve is an optimistic predictor of performance for machines with an instruction cache. (Examples of microprocessors with instruction caches are Fairchild's Clipper chip set, Intel's 80386-equipped Above-Board, INMOS' T800, and Motorola's 68020.)

And the Dhrystone spends far too much time doing string manipulations. Not only do real applications spend less time manipulating strings than the Dhrystone does, but strings are dealt with quite differently between languages. As a result, Pascal Dhrystones for a computer can be quite different from C Dhrystones.

This difference arises because in Pascal (and Ada, the original Dhrystone implementation language) the length of a string is always known—it's attached as a byte count to the front of the string. In C, the length isn't known, but the last character is followed by a zero. So to copy a string from one place to another in Pascal, you can use a block move (on a machine that has the instruction), while in C you have to generate code that first finds the end of the string.

So it is important to understand just

what a benchmark is trying to measure as well as knowing how well it does it, and it is unlikely that comparing even nominally equivalent programs in different languages can be relied upon.

Floating-Point Benchmarks

The usual floating-point benchmarks are the Whetstone, Linpack, Savage, and the Livermore Loops. Each takes a different view of what is interesting.

The *Whetstone* originated in England at the National Physical Laboratories (NPL) in the 1960s. Originally written in Algol 60, it was intended to represent a typical medium-size scientific computation mix. The idea was that if you were a scientist or an engineer, the performance of a computer with the Whetstone benchmark would be a reasonable indicator of how well the machine would do with a wide range of programs of interest to you. Such programs do a lot of floating-point, array, and trigonometric work. The benchmark consists of a set of little tasks; the time for each task is noted, and the machine's performance is measured as a weighted sum of the individual times.

As an aside, today's compilers can totally destroy the usefulness of a benchmark program if it isn't written properly (by noticing, for example, that a result computed inside a loop is never used, a compiler can decide not to generate code for that piece of program; then it will notice that the loop isn't controlling any code, and remove that. Pretty soon you have a null program). The Whetstone was carefully written, and seems to be proof against optimizing compilers. The Dhrystone, whose whimsical name is a pun on Whetstone, regrettably is not proof against optimizing compilers.

Linpack is a different kettle of fish. Owners of supercomputers tend to have them spend much of their time solving partial differential equations numerically, and the Linpack benchmark is simply

a standard program with a standard set of data that does just that. Unlike the Whetstone—which is a contrived program intended to exhibit balanced behavior—Linpack is a real program used for real work. However, it does have the major weakness (as a benchmark) of being a very poor predictor of general performance for the very reason that it does just one job.

Further, a computer's performance on the Linpack benchmark is mostly an indicator of how quickly the machine can run a single inner loop of the program. This loop can be vectorized quite nicely, so machines like the Cray run it very quickly.

The *Savage* benchmark isn't about speed at all. It was designed to indicate how reliable—in the sense of accurate—the trigonometric routines in a floating-point implementation are.

At first glance, this seems strange: surely all IEEE-standard packages will produce exactly the same accuracy? Not so; even standards have "gotchas." The IEEE standard specifies three ways of doing sums—the single length (32 bits; 24 mantissa, 8 exponent), double length (64 bits; 48 mantissa, 16 exponent), and extended (80 bits; 64 mantissa, 16 exponent). Implementations have some freedom about just how they use these.

For example, assume that you're a floating-point coprocessor and have been given three single-length numbers and asked to do some sums with them. Because you're feeling kind toward the world, you convert the numbers to extended format, work on them in that format, and convert back to single length. This use of extended format provides extra precision to the answer, surely something that the world will be grateful for.

This approach is used by the Intel family of floating-point processors, and on the surface it sounds like a good idea; since the FPUs always work in 80-bit for-

continued

FAST DISC™

FASTEST ACCESS IN THE WORLD

0.02 msec

Compatible with ALL Computers — PC, Macintosh, VAX, VME, Multibus, etc

16 to 589 mb Fixed 16 to 350 mb Removable

Digital Electronic Systems • Estill Springs, Tennessee 37330 • 615-649-5137

CAPTURE YOUR WILDEST IMAGININGS

Come SIGGRAPH '88 in Atlanta where computer graphics trailblazers will take you on a great adventure. Explore the diverse ways graphics are used in science, academia, industry and the arts. Listen to computer graphics pioneers describe bold, new advances. Learn how to give life to your most daring ideas. Venture into the era of electronic visualization.

ACM SIGGRAPH '88
15th Annual Conference
on Computer Graphics
and Interactive Techniques
Atlanta, Georgia
August 1-5, 1988

Sponsored by the
Association for Computing
Machinery's Special
Interest Group on
Computer Graphics in
cooperation with the
IEEE Technical Committee
on Computer Graphics

Please send a copy of the SIGGRAPH '88 advance program to:

Name _____
Address _____
City _____
Zip Code _____
Company _____
State/Country _____
Telephone _____

Members of ACM SIGGRAPH will automatically receive these materials in the mail in April and need NOT return this coupon.

ACM SIGGRAPH '88
Conference Management
111 East Wacker Drive, Suite 600
Chicago, IL 60601
(312) 644-6610

Image: IBM Computer Graphics Service - M. Ortner / B. Spauldiner / Milan / Italy



mat, you get the best possible answers (without any speed penalty, since the processors are built around an 80-bit ALU), and the approach is allowed by the standard.

But the approach can lead to some bizarre side effects. Suppose you've written a program that needs to compute the value of $(a/b)*c$. Being a little unsure of yourself, you do it step by step as a sequence of operations: First you calculate a/b (and store the result somewhere, say x), and then you multiply the result by c . So your program might say

```
float sum(a,b,c)
float a, b,c;
{
  float x;
  x = a/b;
  return x * c;
}
```

Testing it, you find that the steady approach has paid off and that it works, so now—flush with success—you get rid of the temporary variable x :

```
float sum(a,b,c)
float a, b,c;
{
  return (a/b)*c;
}
```

Running it again, you get a different answer. Of course, what happened was that in the first example, the program computed a/b in extended precision, shrank the result down to single length, and used that for the division. In the second case, the sum was done in extended precision all the way through, and so the answer could be different since the rounding done could be different.

The same sort of thing can happen if your compiler-writer wasn't too careful about the code generated. If you wrote $x = c*(a/b) - d*(a/b)$, the compiler should notice that a/b is used twice, work it out just once, and reuse the result. Optimizing compilers will also note reuse of an expression across several lines of program and try to do the same thing (this is called common subexpression elimination) to speed up execution.

If the compiler generates code that causes the FPU to save the result of evaluating a subexpression in memory, then it is important that the result be saved as an extended-precision number; this takes up 10 bytes of memory and lots of store cycles. Sloppy coding might save it as a single-length result, so that if you compiled with optimization off you'd get no subexpression elimination and one answer, while compiling with optimization on would give the elimination and

yield a different answer.

To return to the Savage benchmark: As indicated, it is intended to provide you with an indication of the accuracy of the trigonometric routines in your implementation, and it does that by computing the value of an expression whose value is known exactly (from trig identities, rather than by doing the calculation to exact accuracy).

Finally, the *Livermore Loops* are, in a sense, an up-to-date version of the Whetstone. Like the Whetstone, they attempt to indicate how well a machine will work on a range of scientific applications by providing a sequence of subtests. Unlike the Whetstone, though, the performance figure isn't a single figure formed as a weighted average of the individual times. Rather, the "official" benchmark results indicate performance in MFLOPS (million floating-point operations per second) in terms like the average, the fastest, the slowest, and the standard deviation. So you get an idea of the spread of capability of your machine rather than just a single-point figure; immediately, this makes the Loops a better predictor than the other benchmarks for scientifically oriented work.

The Loops themselves (so-called because they consist of a number of program loops representing the vital portions of many interesting problems in physics and math) only have one drawback (for our purposes); they're written in FORTRAN while most personal computer system analysts and testers use C.

High-Performance Floating Point

Next we look at how to design a computer to get it to give a high floating-point performance. As with everything, we need first to identify what the problem is before trying to fix it; from the earlier discussions, it seems that the Livermore Loops give a useful indicator of what needs to be done in number crunching, so we'll use that as a guide. Looking at the Loops, we quickly come to these conclusions: Most floating-point sums involve complex expressions and array access.

As an example, here is the code for Livermore Loop 7:

```
DO 7 k = 1, n
  X(k) = U(k) + R*( 2(k) + R *
  Y(k) ) + T*(U(k+3) + R*(U(k+2)
  + R * U(k+1) ) + T*(U(k+6) +
  R*(U(k+5) + R * U(k+4) ) )
7 CONTINUE
```

This is FORTRAN for "execute that loop n times with k varying from 1 to n ." Look at what the code is doing; for example, look at what needs to be done to do some of the work, like computing $R * U(k+4)$.

First, we need to compute the address of the array element. This involves getting the address of the base of the array (this is FORTRAN, and COMMON at that, so it's in a fixed location in memory), adding $(k+4)$ times the word-length of a floating-point number to that address, reading that location from memory, then getting the value of R (in a register, say, since it's going to be used a lot) and multiplying them together. And that's if our compiler-writer had been naughty; really, we should check that the element we're accessing actually is inside the array.

The first thing that's obvious is that having a processor with an infinitely fast floating-point multiply isn't a complete cure: all that accessing takes time, instructions, and memory accesses. In fact, it looks like the biggest problem is getting data to an FPU. So two routes are taken to minimize the loading times.

First, clever compilers can look at the code and save some time. In this example, we look at quite closely bunched elements in an array; the elements we look at next time around are close to the previous time's elements. So a compiler would take advantage of this by using a pointer (and store the pointer in a register, if the machine has registers); accessing $U(k+4)$ comes down to reading the contents of memory at location $4 * 8 + (\text{register } 4)$ —that is, 32 bytes beyond where register 4 is pointing (assuming 64-bit values). Then the register is incremented at the bottom of the loop by 4 bytes, and around we go again. This also lets the bounding-checking be done once per loop iteration, rather than on every access.

The result of this transformation is that each array access is now just an indexed load, which is a lot quicker. But it will still take the machine at least 10 (one for each read plus a write) memory cycles to compute the value for $X(k)$, plus the time for an add (to increment the pointer), plus whatever code is needed to check the loop end conditions; typically, this will total at least 25 integer instructions. The program runs faster, but even with infinitely fast floating-point work, it still takes 25 integer-instruction times per loop iteration. And it's pretty difficult to get infinitely fast FPUs.

Or is it? Look at the code again. It is a sequence of fetching things from memory, operating on them, fetching other things from memory, operating on those, and then combining the results. To do $R*(U(k+2) + R*(U(k+1)))$, we need to get $U(k+1)$, multiply it by R , then get $U(k+2)$ and add that in, and then multiply by R . If we design the FPU/processor interface properly, we can get $U(k+1)$ from memory, give it to the FPU, give R

continued



NOW THERE'S AN EASIER WAY TO CATCH UP ON YOUR PAPER WORK.

If keeping up has you falling behind, try CompuServe's exclusive Executive News Service—an electronic clipping service that puts the power and scope of the world's most respected news sources at your fingertips.

The Executive News Service can provide you with all types of important information. Keep an eye on financial and economic situations. Follow national and international market fluctuations, economic conditions, and the business, political or economic events that affect specific companies.

Keep informed of specialized areas of technology or the expanding health care industry. Stay on top of the upcoming elections. Or follow your favorite sports team on

and off the field. Travel with the Olympics from Calgary and Seoul.

A single keystroke can give you The Associated Press news wire, Reuters Financial Report, McGraw-Hill News, *The Washington Post* and OTC NewsAlert. When you need the most current news, it's there

CompuServe's Executive News Service does all the work for you. Just enter the words and phrases that define your interests. Executive News Service screens the sources around the clock, then electronically files the stories for you to read at your convenience.

CompuServe's standard usage rate is the same any time of day. So you can go

Circle 60 on Reader Service Card

online as inexpensively during the day as you can at night.

CompuServe delivers it all, plus a variety of other information, entertainment and communications options. You can access CompuServe with almost any computer and modem. To buy a Subscription Kit, see your nearest computer dealer. To receive our informative brochure, or to order direct, call 800-848-8199. In Ohio and Canada, call 614-457-0802.

CompuServe®

Information Services, P.O. Box 20212
5000 Arlington Centre Blvd., Columbus, Ohio 43220

800-848-8199

In Ohio and Canada, call 614-457-0802.

An H&R Block Company

to the FPU, and tell it to multiply them together. While it's doing that, we go and read $U(k+2)$ from memory, hand it to the FPU, and tell it to add it in. By the time we tell the FPU to do the addition, we'll have had several instruction times for the FPU to have finished the multiply.

This approach of letting the FPU and the CPU run in parallel is the other half of getting floating-point performance out of normal machines, and has been adopted by all the microprocessor vendors. The effect, given a sufficiently fast FPU (one that can do a floating-point add in about the time the CPU can do a memory read and an instruction or so), is to get the computational power of an infinitely fast FPU for a wide range of real programs.

The Supercomputer Advantage

That sort of approach, with computers typical of today's workstations and high-end personal computers, can result in systems which can do a sustained 1 or 2 MFLOPS; you can get this from a T800, or from an Intel/Weitek 80386/1167 combination, for example. The limit is the variable accessing and control, rather than the FPU times. How does a Cray go so much faster?

Well, there are some obvious differences. First, the memory is quicker (and so is the machine that fetches operands). But, perhaps surprisingly, for many computations, the Cray isn't so very much faster. For example, a T800-20 can hit 2.5 million (64-bit) Whetstones per second, while a Cray X-MP-1 hits 26.6 million. Then supercomputers are only 10 times as fast as a microprocessor. But on Linpack, where the T800 will offer perhaps a little below 1 MFLOP, the X-MP-1 will be a hundred times faster. Why the difference?

Consider doing a vector multiplication. To do this, you take each element in a row of a matrix, each element in a column, multiply the corresponding ele-

ments pairwise, and add up the answers. Then you repeat the operation lots of times.

Now assume you have an FPU with two inputs, and that you have a clever block-move instruction in your CPU. You could move the row elements one by one into one input, and the column elements one by one into the other. Then you tell the FPU to multiply together its inputs, and you'll get a sequence of outputs. If you then attach another FPU to the output of the first FPU, and tell it to add what it sees on its input to what it's already got, you can get the complete (row \times column) computation done in no more time than it takes to blast the values from memory.

The block moves have to be clever (the elements are not side by side), so successive values are some distance apart. This sort of extra hardware resources lets Crays go faster than normal processors, but only on the right sort of problem.

Suppose that 100 MFLOPS or so isn't enough. How do we go much faster? Brute strength helps: faster technologies squeeze down the cycle times of machines so that they go ever faster. Today's limit for traditional supercomputers seems to be around 1000 MFLOPS; if we want to go faster, another approach is needed.

The only approach that seems to have the right sort of promise is the obvious one—do more things at once. There are a couple of different approaches to this: one connects up fairly small numbers of horribly quick computers, and the other—more relevant here—connects up large numbers of microprocessors.

Typical examples of the latter are Intel's iPSC Hypercubes (which use bucketloads of 80386s), Floating Point Systems T-Series and Meiko's Computing Surface (which both use INMOS transputers), systems from Ametek and BBN (which use 68000-family machines), plus NCube (which uses a cus-

tom microprocessor). These machines all offer the promise of going faster as you add processors to them; being microprocessor-based gives them excellent price/performance.

But unlike Crays, which have compilers that can take care of the clever hardware efficiently, these machines don't have compilers which can take a "normal" program and massage it automatically so that the awesome power of a collection of 1024 T800s can be brought to bear. But with the price/performance offered by the approach (Floating Point Systems' top machine is quoted at 18 giga-FLOPS, for example), it is becoming increasingly attractive to rewrite code especially for these machines. This has relevance, since you can buy multiprocessor add-in cards for personal computers, so this extra performance is there for many personal computer owners (for instance, the CSA PC add-in card described on page 220).

Not Written in Stone

We've seen some of floating point's quirks and pitfalls, had a look at benchmarks, seen how supercomputers do even better, and finished by seeing how the ordinary microprocessor is turning the tables on the supercomputers.

In the course of the discussion, I hit on the Livermore Loops as the best all-around benchmark, spoiled only by the fact that they're in FORTRAN; this leaves the Whetstone benchmark as the most widely useful microprocessor benchmark for the moment. Do bear in mind, though, that benchmark results should not be written in stone: A better compiler, a faster clock speed, a bigger cache, and faster memory can all overturn the league tables. Remember that the final choice of a machine should be made by using knowledge of the complete needs, not by simply referring to some published tables. ■

PC voice mail, now only \$199.



**INCLUDES
HAYES®
COMPATIBLE
MODEM!**

Watson®, hailed by one reviewer as "the premier voice mail station" at \$498, is an even better value at \$199. Watson eliminates telephone tag and gives you big-system features like auto speed-dial, auto answer, message forwarding, and built-in 300/1200 bps modem. For an ear-opening business applications demo,

call **1 (800) 6-WATSON** (in Mass., (617) 651-2186). To order, call **1 (800) 533-6120** (in Mass., (617) 655-6066). Credit Cards Accepted.

Watson®

Natural MicroSystems Corporation

DEBUGGING SWAT TEAM

*Order Eco-C88 Rel. 4.0 New Modeling Compiler
and get C-more at no extra charge!*

Seek and Correct

You already know that fast compilation does not mean fast program development. Backing up for bogus error messages and removing the bugs takes time. Eco-C88's "Seek and Correct" three-way error checking finds even the most elusive bugs, clearing the path for swift program development.

Double Barrel Error Checking

Eco-C88 nails syntax errors cold and tells you about the error in plain English. And there's no avalanche of false error messages, either. Other compilers can generate up to four times the number of error messages actually present; they leave it up to you to guess which ones are real. You'll be more productive with Eco-C88 because there is no guess work.

Eco-C88 provides ten levels of semantic error checking. You can select from almost no checking to the fussiest you've ever seen. Eco-C88's "picky flag" finds subtle errors that slip by other compilers.

Eco-C88 also features:

- All data types, plus ANSI Enhancements
- Robust library, including many new ANSI functions
- CED editor with online function help, split windows, compile-edit-link capability
- New, expanded manual with sample programs for the library functions

C-more Source Code Debugger

Finally, if a really nasty bug persists, put C-more, our source code debugger, to work. With C-more you can watch your program as it executes, single-step it, set simple or conditional breakpoints, test complex expressions, use variables as indexes into other variables, initialize and trace variables, examine CPU registers, display results with printf()-type options and much more. C-more can help you track down bugs in minutes rather than days.

The price for Eco-C88 is \$99.95. And, for a limited time, we'll give you our C-more debugger at no extra charge.

Ecosoft Inc.

6413 N. College Ave.
Indianapolis, IN 46220

(317) 255-6476 (Tech Info)
(800) 952-0472 (Orders)

Circle 294 on Reader Service Card

Memory Options

Model	Code Size	Data Size
Small	64K	64K
Compact	64K	1 Meg
Medium	1 Meg	64K
Large	1 Meg	1 Meg

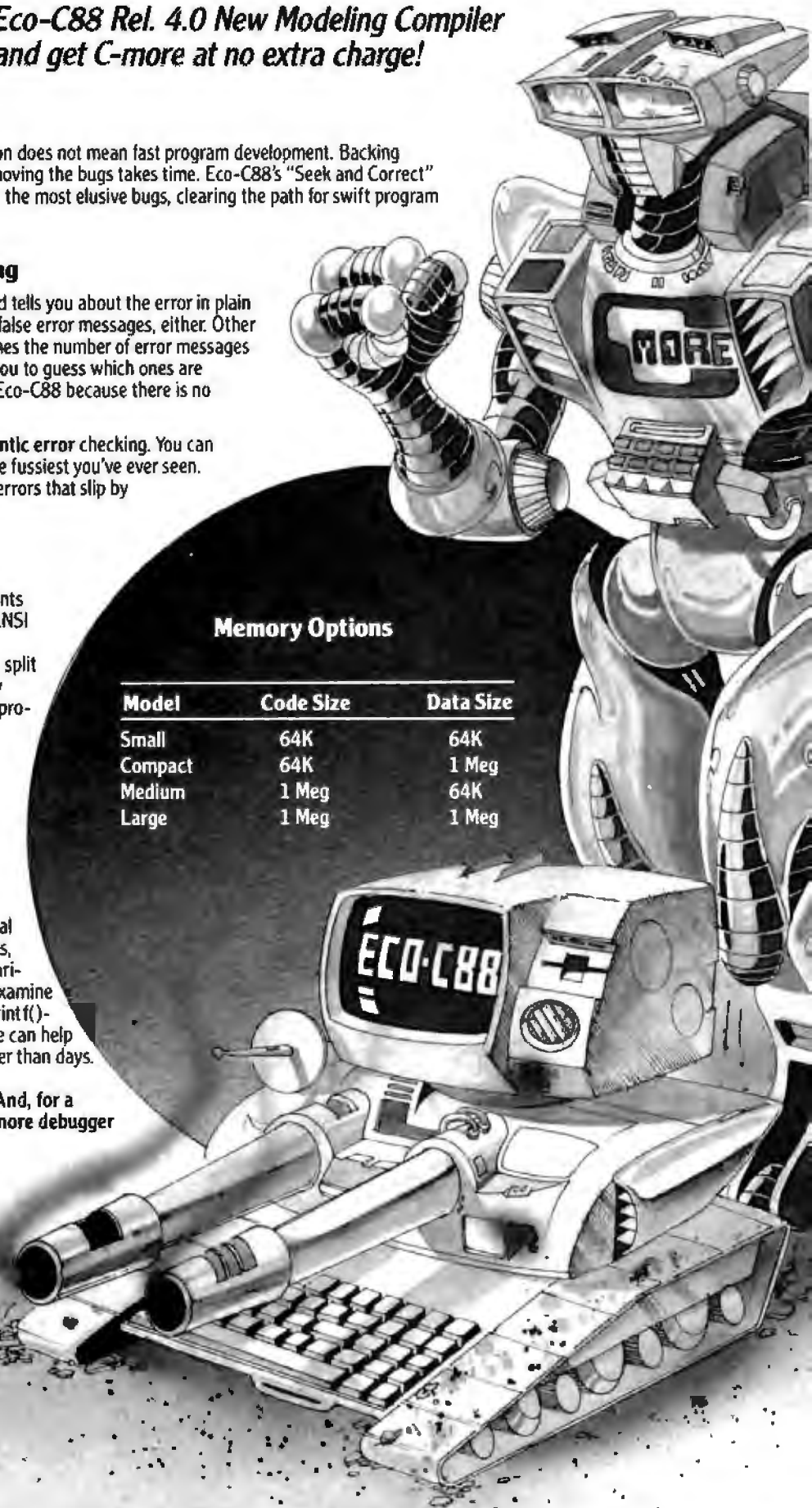

LOWEST CPM.
LEAST
DUPLICATED READERS.
SMALLEST
RATE INCREASE.

Other computer magazines have been raising their rates way out of proportion to their circulation growth (costs up 30 or 40 percent). We've raised ours a modest 7%.

While other magazines are breaking the \$30, \$40, \$50, and even \$100 B&W CPM barriers, ours remains an attractive \$25.28.

While other PC books are scrambling to figure out how to juggle the PC and Mac, we're already delivering. With a combined 95% PC, and 38% Mac penetration.

While other magazines fight head to head for the same readership, 45% of our paid readers do not read any other major PC-specific books.

And, when they're not reading BYTE, they're busy buying product. In fact, 90% of our subscribers directly influence their company's microcomputer purchasing decisions.

You'd like to find a way to keep your media budget in line. We're it. Call Dennis Riley at (603) 924-9281 for more facts.

Sources: Fall 1987 ARI Study; 1987 Subscriber Profile Study

BYTE
IT'S INDISPENSABLE.

How to Get Better Floating-Point Results

With or without an FPU, careful program design is the only sure way to guarantee the validity of floating-point computations

Carl Byington

FLOATING-POINT COPROCESSOR units (FPUs) are the key to getting good number-crunching performance out of personal computers, and yet they are usually extra-cost options. To be fair to users who haven't added one to their computers, a software designer has to write software that will use an FPU if one is present or perform the necessary operations using the main processor otherwise. In a compiler system, the component that takes care of this is called a floating-point emulator.

Unfortunately, all emulators are not alike. They do not behave identically nor always emulate the hardware exactly. This means that a given program may produce different results, depending on whether an FPU is present, and, if not, depending on which emulator is used.

But you can solve or at least control the problem by designing the high-level algorithm carefully, based on a few principles that derive from an elementary understanding of the emulation process and floating-point representation systems.

This article discusses some of the trade-offs involved in emulating floating-point hardware and explains the implications for programmers. All the specific examples in this article apply to the Ryan-McFarland RM/FORTRAN version 2.4 8087 emulator, which I helped design and implement. Previous versions of the compiler had used the emulator provided by Intel. We (the compiler design team) knew we could significantly speed up the emulation by writing a new emulator with a different set of design goals. The Intel emulator was designed to produce an ex-

act emulation of the 8087 chip. It calculates results more precisely (and therefore more slowly) than is required by the RM/FORTRAN compiler. The Intel emulator also fails to take full advantage of the 8086 instruction set. For instance, many internal variables are maintained in memory, rather than in registers.

The 8087 chip can work with numbers in three basic formats: the 32-bit (24-bit significand) single precision; 64-bit (53-bit significand) double precision; and 80-bit (64-bit significand) temporary. I will refer to these various formats by the number of significand bits (24, 53, and 64).

The version 2.4 emulator was designed to produce results accurate to 60 bits. The primary design goal was to increase the speed of floating-point computations subject to the 60-bit precision requirement. A secondary goal was to increase the precision beyond 60 bits whenever possible so long as the speed was not reduced. A third goal was to make the emulator as small as possible, but this was not allowed to interfere with the first two goals. The speed objective is easily understandable, but why choose 60-bit precision when both the 8087 hardware and the Intel emulator calculate results to 64-bit precision? We did this because it doesn't affect the precision of the results produced by a FORTRAN program.

Precision and How to Keep It

Three factors control the precision of the results produced by a FORTRAN program: the algorithm (sequence of operations) and input data the program uses, the order of those operations after the

compiler has optimized and rearranged the code, and the precision of individual operations within the FPU or emulator.

The entire FORTRAN system (compiler and emulator) has no control over the first factor; that is left up to the programmer. The second and third factors are related in that the choice of precision in the emulator needs only to match the precision requirements of the compiler.

RM/FORTRAN assumes that intermediate results need to be calculated to only 24 (REAL) or 53 (DOUBLE PRECISION) bits. Intermediate results will be calculated to a greater precision if there is no performance penalty. The emulator calculates the standard add, subtract, multiply, and divide functions to 64-bit precision; and it calculates the square root, tangent, arctangent, exponential, and logarithm functions to 60-bit precision.

Only two things can be done with the result of an arithmetic operation: It can be stored in a FORTRAN variable or used as an operand of another arithmetic operation. In the former case, the result's precision will be reduced to 53 bits. In the latter case, two further possibilities apply. The result may be used directly with its full precision, or the compiler optimizer may choose to store it in a compiler-generated temporary variable for later reuse, in which case the temporary

continued

Carl Byington (1909 Avenida Feliciano, Rancho Palos Verdes, CA 90732) is the founder of 510 Software Group, which specializes in language run-time support systems and database applications.

variable will have a maximum precision of 53 bits.

Consider the FORTRAN statements

```
DOUBLE PRECISION A,X,Y,Z
A = X+(Y+Z)
```

One possible 80x87 FPU code sequence to calculate A is

```
FLD X ;floating point load X
FADD Y ;floating point add Y
FADD Z ;floating point add Z
FSTP A ;floating point store A
```

The register operand for the second FADD can have up to 64 significant bits, since it was calculated by the first FADD.

Now consider a second code sequence that might be generated if the subexpression Y+Z appeared in more than one expression in the FORTRAN program:

```
FLD Y ;floating point load Y
FADD Z ;floating point add Z
FST T ;save subexpression in temp T
...
FLD T ;floating point load T
FADD X ;floating point add X
FSTP A ;floating point store A
```

Here the precision of T is only 53 bits (a double-precision temporary generated by the compiler), and the results may not be identical to those produced by the first code sequence.

The compiler and emulator guarantee that each elementary arithmetic operation is accurate to at least 53 bits. You can still write FORTRAN code that is exact in the mathematical sense and yet produces very imprecise results. Two common causes for this loss of precision are subtraction of two numbers that are almost identical and addition of two numbers of widely different magnitudes. As an ex-

ample of the first situation, consider the problem of finding the roots of the quadratic equation $x^2 + 2bx + c = 0$.

The standard formula gives us

$$x_1 = -b + \sqrt{(b^2 - c)},$$

$$x_2 = -b - \sqrt{(b^2 - c)}.$$

If these were implemented with infinitely precise arithmetic and the coefficients b and c were known exactly, they would produce the exact roots of the quadratic equation. But when they are used in a FORTRAN program, several things happen. Here are the FORTRAN statements:

```
x1 = -b + Sqrt(b**2 - c)
x2 = -b - Sqrt(b**2 - c).
```

First, the coefficients can be known exactly but represented only imprecisely in FORTRAN variables with 53-bit precision. Second, the individual arithmetic operations are implemented with only 53-bit precision. Let us see what effect this has on the precision of the result when b is approximately -2^{20} and c is approximately 1. The result x_1 will have 53 bits of precision; x_2 will have only a few bits of precision (note that we're now using FORTRAN rather than algebraic variables). Why did this happen?

Consider the computation of x_2 . The expression $b**2$ will be calculated to 53 bits and is approximately 2^{40} . The value of $b**2 - c$ is calculated to 53 bits, but only a few high-order bits of c take part in this calculation. The expression $Sqrt(b**2 - c)$ is calculated to 53 bits and is almost exactly the same as $-b$. The final step in the calculation of x_2 is a subtraction involving operands that are almost identical; the result of this subtraction has only a few bits of precision.

Look at the FORTRAN numbers A, B, C, and D in table 1a. A and B share 50

high-order bits. $A - B$ is C, which has 50 high-order 0s. D is the result of normalizing C, so the high-order bit of D is 1. But the low-order 0s in D are an artifact of the floating-point arithmetic, and they have no significance. D is really known to only three bits of precision, even though its representation in a FORTRAN variable will have 53 significant bits.

This is essentially what has happened in the final subtraction in the calculation of x_2 above. An alternate formula is $x_2 = c/x_1$, which can be calculated to 53 bits of true precision. The quad program in listing 1 demonstrates the different results obtained using these two approaches. Note that the computation of the error in x_1 is itself an ill-posed computation with no significant bits. The compiler has calculated that error (variable x_3) twice with two different results.

Now we'll look at an example where you lose precision by adding numbers that are very far apart. Consider the numbers in table 1b. The magnitude of A is very different from the magnitude of B. C is B modified so that the exponent will match the exponent of A. Note that in order to make the exponents match, all the bits of B have been lost. D is $A + C$, which is the same as A. In this case, you have not lost any precision, since the sum is still correct to 53 bits.

Now consider the problem of calculating the sum of the power series $1 + r + r^2 + r^3 + r^4 + \dots$, where r is in the interval (0, 1). If r is .99, then the sum of the infinite series is 100. If the first 2000 elements are added in the order indicated, starting with the first and largest element, the partial sum will eventually become much larger than subsequent series elements, producing a problem similar to that illustrated in table 1b.

This problem can be partially solved by summing the series starting with the smallest elements first. The loss of precision is then not so severe, although it still occurs. The only way to eliminate this problem is to use an array of accumulators and add the next series element into the appropriate accumulator. A far better algorithm in this case is to throw away the series expansion and calculate the mathematically equivalent expression $1/(1 - r)$.

The series program in listing 2 demonstrates these techniques. The do 15 loop initializes the sumx array. The index statement function calculates a subscript for the sumx array. The array element at that position should either be 0 or have a value close to the value of the series element $r**i$. The do 16 loop checks for array elements that have become too large and effectively propagates the carry. The do 25 loop finally adds the

continued

Table 1: Results of computations involving (a) subtraction of nearly equal numbers and (b) addition of numbers of widely different magnitudes.

a) C = A - B and D = C (normalized).

```
A = 0 xxxxxxxxxxxxxxxxxxxxxxxxxxxxxxxxxxxxxxxxxxxxxxxxxxxxxxxxxxxxyy x 226
B = 0 xxxxxxxxxxxxxxxxxxxxxxxxxxxxxxxxxxxxxxxxxxxxxxxxxxxxxxxxxxxww x 224
C = 0 0000000000000000000000000000000000000000000000000000000zz x 226
D = 0 zzz0000000000000000000000000000000000000000000000000000000 x 224
```

b) A and B are to be added, C = B (normalized), D = A + C

```
A = 0 xxxxxxxxxxxxxxxxxxxxxxxxxxxxxxxxxxxxxxxxxxxxxxxxxxxxxxxxxxx x 23
B = 0 yyyyyyyyyyyyyyyyyyyyyyyyyyyyyyyyyyyyyyyyyyyyyyyyyyyyyyyy x 2-10
C = 0 0000000000000000000000000000000000000000000000000000000000 x 23
D = 0 xxxxxxxxxxxxxxxxxxxxxxxxxxxxxxxxxxxxxxxxxxxxxxxxxxxxxxxxxxx x 23
```



WE PROVIDE
THE TOOLS
FOR A
SUCCESSFUL
PRESENTATION.

CLUB

New Club® Class. It changes the face of business travel with amenities like gourmet cuisine, fine wine and a supremely comfortable seat, in addition to the full complement of courtesies you see above. So that you emerge from your flight not only feeling refreshed, but looking that way. Club Class. It's a most attractive way to fly.

Circle 297 on Reader Service Card

BRITISH AIRWAYS

The world's favourite airline. 

MARCH 1988 • BYTE 231

A MESSAGE TO OUR SUBSCRIBERS

FROM TIME TO TIME we make the BYTE subscriber list available to other companies who wish to send our subscribers material about their products. We take great care to screen these companies, choosing only those who are reputable, and whose products, services, or information we feel would be of interest to you. Direct mail is an efficient medium for presenting the latest personal computer goods and services to our subscribers.

Many BYTE subscribers appreciate this controlled use of our mailing list, and look forward to finding information of interest to them in the mail. Used are our subscribers' names and addresses only (no other information we may have is ever given).

While we believe the distribution of this information is of benefit to our subscribers, we firmly respect the wishes of any subscriber who does not want to receive such promotional literature. Should you wish to restrict the use of your name, simply send your request to the following address.

BYTE MAGAZINE

ATTN: SUBSCRIBER SERVICE
P.O. Box 7643
TEANECK, NJ 07666-9866



Listing 1: (a) A FORTRAN program illustrating ill-formed and well-formed calculations of the quadratic formula, followed by (b) a sample run of the program.

```
(a)
      program quad
      double precision b, c, x1, x2, x3, x4
10     write (6, 1)
      write (6, *) 'Enter coefficients b and c separated by
           spaces: '
      read (5, *) b,c
      if (c .eq. 0.0) stop
      write (6, 1)
      write (6, 3) b, c
c
      write (6, *) 'Method one.'
      x1 = -b + sqrt(b**2-c)
      x2 = -b - sqrt(b**2-c)
      x3 = x1**2 + 2*b*x1 + c
      x4 = x2**2 + 2*b*x2 + c
      write (6, 2) x1, x2, x3, x4
c
      write (6, *) 'Method two.'
      x1 = -b + sqrt(b**2-c)
      x2 = c/x1
      x3 = x1**2 + 2*b*x1 + c
      x4 = x2**2 + 2*b*x2 + c
      write (6, 2) x1, x2, x3, x4
c
      goto 10
c
1     format (1x)
2     format (' x1 solution      ', D25.18 /
$         ' x2 solution      ', D25.18 /
$         ' error in x1      ', D25.18 /
$         ' error in x2      ', D25.18)
3     format (' b              ', D25.18 /
$         ' c              ', D25.18)
      end
```

(b)

Enter coefficients b and c separated by spaces: -3e7 1

```
b          -0.300000000000000000D+08
c          0.100000000000000000D+01
Method one.
x1 solution  0.5999999999999998510D+08
x2 solution  0.149011611930476563D-06
error in x1  -0.800024414062500000D+01
error in x2  -0.794069671630857155D+01
Method two.
x1 solution  0.5999999999999998510D+08
x2 solution  0.166666666666666670E-07
error in x1  -0.794067302812500000D+01
error in x2  -0.220580931992175877D-14
```

Enter coefficients b and c separated by spaces: -3e8 1

```
b          -0.300000000000000000D+09
c          0.100000000000000000D+01
Method one.
x1 solution  0.600000000000000000D+09
x2 solution  0.000000000000000000D+00
error in x1  0.000000000000000000D+00
error in x2  0.100000000000000000D+01
```

continued

FUJITSU'S DX2000 SERIES PRINTERS

Switching from computer paper to letterhead is as simple as 1...2...3.

Instructions:



1. Push



2. Pull



3. Push

Push a button. Pull a lever. Push a button.

It's that easy to switch from computer paper to letterhead using a Fujitsu DX2000 Series 9-wire dot matrix printer.

There's no wrestling with continuous forms or optional tractors. No wasting time loading and unloading paper. And automatic feeding of cut-sheet paper is faster with the optional, single-bin sheet feeder.

More Efficient, More Productive.

The DX2000 Series printers are available in either 80- or 136-character column widths and both produce up to 135 lines of copy per minute. Or an average-size memo in draft quality in just 11 seconds.

Print speeds range from 54 characters per second in near-letter-quality mode to 324 cps in draft quality.

Each printer can create letters, spreadsheets, descriptive charts and professional graphs. For brilliant 7-color printing, you can get an optional easy-to-install color kit.

Quiet, Reliable, Compatible.

Listen. The DX2000 printers are quiet.

What's more, they can give you years of trouble-free printing without taking time off.

And that's not all. Each printer is compatible with the

most popular software packages, using Epson® FX80, JX80, IBM® Graphics Printer® or IBM Proprinter® commands.

For pricing and more information on the DX2000 series or any of our complete line of daisywheel, dot matrix, band or laser printers, call 800-626-4686.

Make the easy switch to Fujitsu printers.



DX2300



DX2400

A COMPANY WITH CHARACTER AND DRIVE

FUJITSU

FUJITSU AMERICA
Computer Products Group

FOR MORE INFORMATION ON THE DX2000 SERIES PRINTERS, CALL 800-626-4686

BYTE's Subscriber Benefits Program

Your BYTE subscription brings you a complete menu of the latest in microcomputer technology every 30 days. The kind of broad-based objective coverage you read in every issue. *In addition*, your subscription carries a wealth of other benefits. Check the check list:

BONUSES

✓ **Annual Separate Issues:** In addition to BYTE's 12 monthly issues, subscribers also receive our annual IBM PC issue free of charge, as well as any other annual issues BYTE may produce.

✓ **BYTE Deck:** Subscribers receive five BYTE postcard deck mailings each year—a direct response system for you to obtain information on advertised products through return mail.

✓ **Reader Service:** For information on products advertised in BYTE, circle the numbers on the Reader Service card enclosed in each issue that correspond to the numbers for the advertisers you select. Drop the post-paid card in the mail and we'll get your inquiries to the advertisers.

✓ **TIPS:** BYTE's Telephone Inquiry System is available to subscribers who need *fast response* from advertisers. After obtaining your Subscriber I.D. Card, dial TIPS and enter your inquiries. You'll save as much as ten days over the response to Reader Service cards.

✓ **Free Programs Via BYTENet:** You get access to the BYTENet Bulletin Board Service, which allows you to download, via



modem, valuable program listings. There is no connect charge for this service.

✓ **Subscription Service:** If you have a problem with, or a question about your subscription, you may call our service department toll-free at 800-423-8272 (in New Jersey call 800-367-0218) during regular business hours (Eastern Time). You can also use Subscription Service to obtain back issues. Should you care to correspond, use the following address: P.O. Box 6821, Piscataway, N.J. 08855.

✓ **Editorial Indices:** Available through our customer service department P.O. Box 328, Hancock, New Hampshire 03449.

PAID SERVICES

✓ **BIX:** BYTE's Information Exchange puts you on-line 24 hours a day with your peers via computer conferencing and electronic mail. All you need to

sign up is a microcomputer, a modem, and telecomm software. For further information and cost, call 1-800-227-BYTE.

✓ **Program Listings:** Listings of programs that accompany BYTE articles are now available on BIX, on disks or in quarterly printed supplements (see reply cards in this issue for cost information), or call 1-800-258-5485.

✓ **Microform:** BYTE is available in microform from University Microfilm International in the U.S. and Europe. See Contents page for cost information.

DISCOUNTS

- ✓ One-year subscription at \$22.95
- ✓ Two-year subscription at \$39.95
- ✓ Three-year subscription at \$55.95
- ✓ One-year group subscription for ten or more at \$18.95 each. (Call or write for details.)

TOLL-FREE NUMBERS FOR YOUR CONVENIENCE:

Subscriptions & Back Issues:
1-800-423-8272
(in N.J., 1-800-367-0218)

BIX: 1-800-227-BYTE

Program Listings Orders:
1-800-258-5485

BYTE



It's indispensable.

UNLEASH YOUR 80386!

Your 80386-based PC should run two to three times as fast as your old AT. This speed-up is primarily due to the doubling of the clock speed from 8 to 16 MHz. The new MicroWay products discussed below take advantage of the real power of your 80386, which is actually 4 to 16 times that of the old AT! These new products take advantage of the 32 bit registers and data bus of the 80386 and the Weitek 1167 numeric coprocessor chip set. They include a family of MicroWay

80386 compilers that run in protected mode and numeric coprocessor cards that utilize the Weitek technology.

The benefits of our new technologies include:

- An increase in addressable memory from 640K to 4 gigabytes using MS-DOS or Unix.
- A 12 fold increase in the speed of 32 bit integer arithmetic.
- A 4 to 16 fold increase in floating point

speed over the 80387/80287 numeric coprocessors.

Equally important, whichever MicroWay product you choose, you can be assured of the same excellent pre- and post-sales support that has made MicroWay the world leader in PC numerics and high performance PC upgrades. For more information, please call the Technical Support Department at

617-746-7341

After July 1988 call 508-746-7341

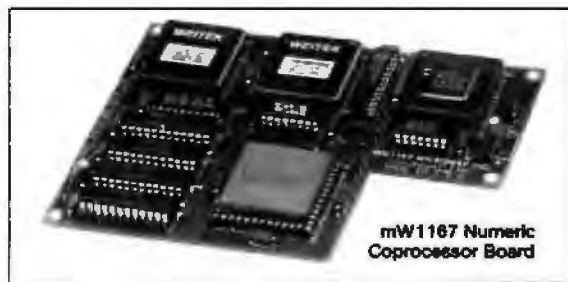

mW1167 Numeric Coprocessor Board

MicroWay[®] 80386 Support

MicroWay 80386 Compilers

NDP Fortran-386 and NDP C-386 are globally optimizing 80386 native code compilers that support a number of Numeric Data Processors, including the 80287, 80387 and mW1167. They generate mainframe quality optimized code and are syntactically and operationally compatible to the Berkeley 4.2 Unix f77 and PCC compilers. MS-DOS specific extensions have been added where necessary to make it easy to port programs written with Microsoft C or Fortran and R/M Fortran.

The compilers are presently available in two formats: Microport Unix 5.3 or MS-DOS as extended by the Phar Lap Tools. MicroWay will port them to other 80386 operating systems such as OS/2 as the need arises and as 80386 versions become available.

The key to addressing more than 640 kbytes is the use of 32-bit integers to address arrays. NDP Fortran-386 generates 32-bit code which executes 3 to 8 times faster than the current generation of 16-bit compilers. There are three elements each of which contributes a factor of 2 to this speed increase: very efficient use of 80386 registers to store 32-bit entities, the use of inline 32-bit arithmetic instead of library calls, and a doubling in the effective utilization of the system data bus.

An example of the benefit of excellent code is a 32-bit matrix multiply. In this benchmark an NDP Fortran-386 program is run against the same program compiled with a 16-bit Fortran. Both programs were run on the same 80386 system. However, the 32-bit code ran 7.5 times faster than the 16-bit code, and 58.5 times faster than the 16-bit code executing on an IBM PC.

NDP Fortran-386™\$595
NDP C-386™\$595

MicroWay Numerics

The mW1167™ is a MicroWay designed high speed numeric coprocessor that works with the 80386. It plugs into a 121 pin "Weitek" socket that is actually a super set of the 80387. This socket is available on a number of motherboards and accelerators including the AT&T 6386, Tandy 4000, Compaq 386/20, Hewlett Packard RS/20 and MicroWay Number Smasher 386. It combines the 64-bit Weitek 1163/64 floating point multiplier/adder with a Weitek/Intel designed "glue chip". The mW1167™ runs at 3.6 MegaWhetstones (compiled with NDP Fortran-386) which is a factor of 16 faster than an AT and 2 to 4 times faster than an 80387.

mW1167 16 MHz\$1495
mW1167 20 MHz\$1995

Monoputer™ - The INMOS T800-20 Transputer is a 32-bit computer on a chip that features a built-in floating point coprocessor. The T800 can be used to build arbitrarily large parallel processing machines. The Monoputer comes with either the 20 MHz T800 or the T414 (a T800 without the NDP) and includes 2 megabytes of processor memory. Transputer language support from MicroWay includes Occam, C, Fortran, Pascal and Prolog.

Monoputer T414-20 with 2 meg¹\$1495
Monoputer T800-20 with 2 meg¹\$1995

Quadputer™ can be purchased with 2, 3 or 4 transputers each of which has 1 or 4 megabytes of memory. Quadputers can be cabled together to build arbitrarily fast parallel processing systems that are as fast or faster than today's mainframes. A single T800 is as fast as an 80386/mW1167 combination!

Blputer™ T800/T414 with 2 meg¹\$3495
Quadputer 4 T414-20 with 4 meg¹\$6000

¹Includes Occam

80386 Multi-User Solutions

AT8™ - This intelligent serial controller series is designed to handle 4 to 16 users in a Xenix or Unix environment with as little as 3% degradation in speed. It has been tested and approved by Compaq, Intel, NCR, Zenith, and the Department of Defense for use in high performance 80286 and 80386 Xenix or Unix based multi-user systems.

AT4 - 4 users\$795
AT8 - 8 users\$995
AT16 - 16 users\$1295

Phar Lap™ created the first tools that make it possible to develop 80386 applications which run under MS-DOS yet take advantage of the full power of the 80386. These include an 80386 monitor/loader that runs the 80386 in protected linear address mode, an assembler, linker and debugger. These tools are required for the MS-DOS version of the MicroWay NDP Compilers. Phar Lap Tools\$495

PC/AT ACCELERATORS

287Turbo-10 10 MHz\$450
287Turbo-12 12 MHz\$550
287TurboPlus-12 12 MHz\$629
FASTCACHE-286 9 MHz\$299
FASTCACHE-286 12 MHz\$399
SUPERCACHE-286\$499

MATH COPROCESSORS

80387-20 20 MHz\$895
80387-16 16 MHz\$495
80287-10 10 MHz\$349
80287-8 8 MHz\$259
80287-6 6 MHz\$179
8087-2 8 MHz\$154
8087 5 MHz\$99

MicroWay

The World Leader in PC Numerics

P.O. Box 79, Kingston, Mass. 02364 USA (617) 746-7341
32 High St., Kingston-Upon-Thames, U.K., 01-541-5466
St. Leonards, NSW, Australia 02-439-8400

BACK ISSUES FOR SALE

	1985	1986	1987	1988
Jan.	\$6.00			\$6.00
Feb.	\$6.00	\$6.00	\$6.00	\$6.00
March	\$6.00		\$6.00	
April	\$6.00		\$6.00	
May	\$6.00		\$6.00	
June	\$6.00	\$6.00	\$6.00	
July		\$6.00	\$6.00	
Aug.	\$6.00	\$6.00	\$6.00	
Sept.	\$6.00	\$6.00	\$6.00	
Oct.	\$6.00	\$6.00	\$6.00	
Nov.	\$6.00		\$6.00	
Dec.	\$6.00	\$6.00	\$6.00	

SPECIAL ISSUES and INDEX

BYTE '83-'84 INDEX	\$2.00
BYTE 1985 INDEX	\$2.50
1984 Special Guide to IBM PCs	\$4.75
1985 INSIDE THE IBM PCs	\$4.75
1986 INSIDE THE IBM PCs	\$5.00
APPLICATIONS SOFTWARE TODAY SPECIAL	\$4.00

Circle and send requests with payments to:
BYTE Back Issues
 One Phoenix Mill Lane
 Peterborough, NH 03458
 (603) 924-9281

Check enclosed
 Payments from foreign countries must be made in US funds payable at a US bank

VISA MasterCard

CARD # _____ Exp. _____

SIGNATURE _____

The above prices include postage in the US. Please add \$.50 per copy for Canada and Mexico; and \$2.00 per copy to foreign countries surface delivery. Please allow 4 weeks for domestic delivery and 12 weeks for foreign delivery.

NAME _____

ADDRESS _____

CITY _____ STATE _____ ZIP _____

FLOATING-POINT PROCESSING RESOURCE GUIDE

FLOATING-POINT SURVIVAL KIT

Computer Systems Architects
 950 North University Ave
 Provo, UT 84604

The PART 1 processor board provides four T800s each with a megabyte; plugs into a PC compatible
Inquiry 955.

Logical Systems
 742 Fourth St. SW
 Corvallis, OR 97333.

A transputer C compiler assembler/linker package, written in C; includes the source code to the complete compiler.
Inquiry 956.

ANSI/IEEE Standard 754-1985 for Binary Floating-Point Arithmetic
 IEEE Computer Society, Los Alamitos, CA, 1985.

IMS T800 Data Sheet. INMOS Corporation, P O Box 16000, Colorado Springs, CO 80935

McMahon, F. H. *The Livermore FORTRAN Kernels: A Computer Test of the Numerical Performance Range.* Technical Report UCRL-53745. Lawrence Livermore National Laboratory, National Technical Information Services, U. S. Department of Commerce, Springfield, VA

Roscoe, A. W., and C. A. R. Hoare. *The Laws of Occam Programming* Oxford University Computing Laboratory, Programming Research Group, 8-11 Keble Rd., Oxford OX1 3QD, U. K.

Barrett, Geoff. *Formal Methods Applied to a Floating Point Number System.* Oxford University Computing Laboratory, Programming Research Group.

FLOATING-POINT HARDWARE

Data Translation Inc
 100 Locke Dr.
 Marlboro, MA 01752
Array processors, floating-point accelerators, and other plug-in boards for PC compatibles.
Inquiry 957.

Motorola Semiconductor Products Inc.
 3501 Ed Bluestein Blvd
 Austin, TX 78721
68881 floating-point coprocessor unit.
Inquiry 959.

Intel Corp.
 3065 Bowers Ave
 Santa Clara, CA 95051
80x87 floating-point coprocessor units.
Inquiry 958.

Weitek Inc
 1060 East Arques
 Sunnyvale, CA 94086
Floating-point coprocessor chip sets
Inquiry 960.

EMULATING FLOATING-POINT HARDWARE

Cody, William J., and William Waite. *Software Manual for the Elementary Functions.* Englewood Cliffs, NJ: Prentice-Hall, 1980.

Hart, John F., E. W. Cheney, et al. *Computer Approximations.* New York: Robert E. Krieger Publishing Company, 1978

Isaacson, Eugene, and Herbert Bishop Keller. *Analysis of Numerical Methods.* New York: John Wiley and Sons, 1966

Knuth, Donald. *The Art of Computer Programming—Seminumerical Algorithms.* Reading, MA: Addison Wesley, 1969

C programmers are talking about C_talk™ The easy way to add the POWER of OBJECT-ORIENTED Programming to C

C_talk extends your C compiler to a real Object-Oriented Language (OOL). It is not a new language; it simply adds Smalltalk-like features to C:

- Encapsulation
- Messaging (Dynamic Binding)
- Inheritance

C_talk offers all of the advantages of OOLs:

- A highly modular software design methodology
- Reusable software components
- Extendable software components

Plus the advantages of C:

- Speed, size, flexibility
- Ease of application delivery
- Access to C libraries and C tool sets.

C_talk consists of an application development environment with:

- A powerful Smalltalk-like Browser for browsing, defining and editing an application's object class hierarchy
- A Preprocessor for converting object class descriptions into standard C programs that are compatible with popular C compilers
- An integrated, semi-automatic Make utility for controlling the preprocessing, compiling and linking of an application, object classes, C files or libraries

C_talk is designed to run on an IBM® PC (or compatible) with one of the following C compilers: Microsoft® C, Lattice C, Turbo C, or CR6. A system configured with a hard drive and mouse is highly recommended.

To order:
 LNS, Inc.
 Software Products Dept.
 7090 Shady Oak Road
 Eden Prairie, MN 55344
 (612) 944-0170

Circle 53 on Reader Service Card
 Shipping \$3-\$5
 GST International

IBM is a registered trademark of International Business Machines Corporation. Microsoft is a registered trademark of Microsoft Corporation. LNS is a trademark of LNS, Inc.

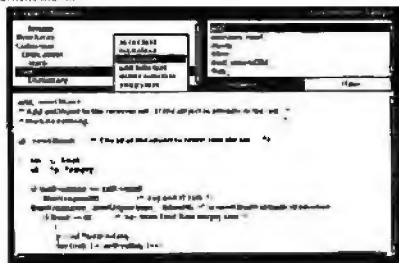

ONLY
 \$149.95



Circle 53 on Reader Service Card
 (DEALERS: 54)

The new Diconix 300 desktop plain paper printer.
So quiet, so small, so fast, you could mistake it for the Diconix 150.
Before you decide on a PC printer, reflect on this.

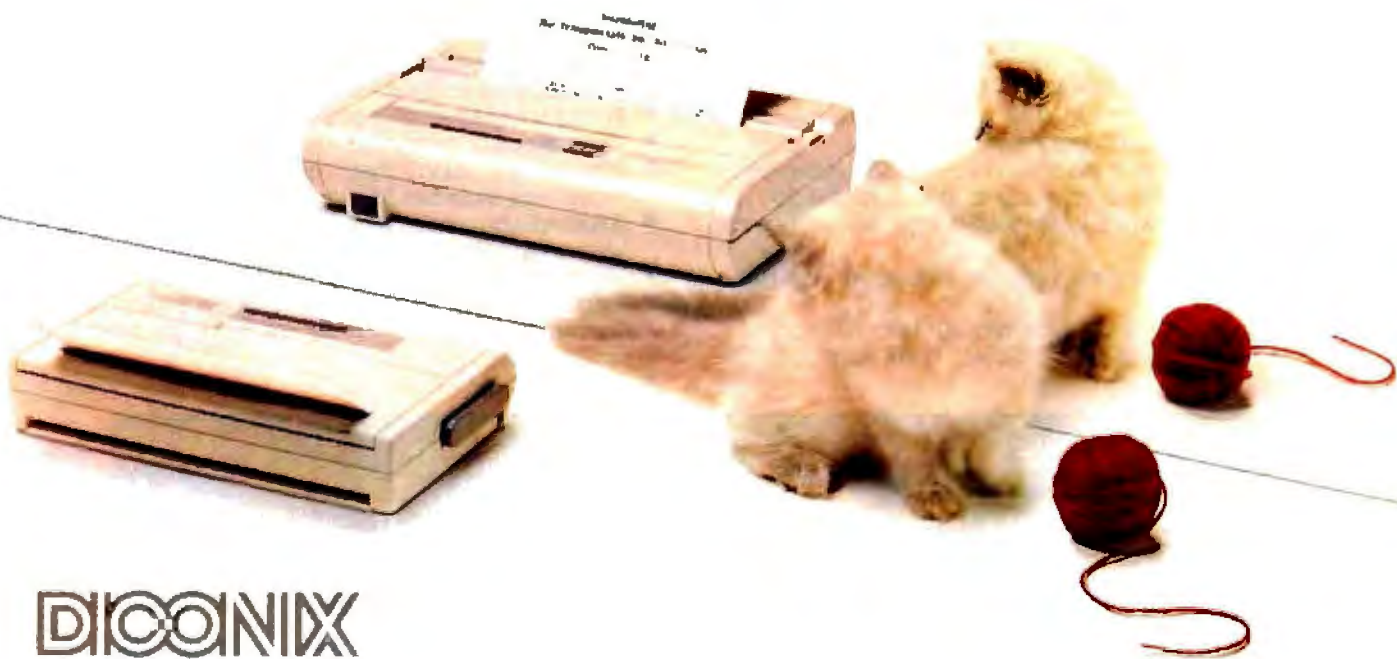

DICONIX

A Kodak Company

3100 Research Boulevard
Dayton, Ohio 45420
1-800-DICONIX

- Semi-automatic paper handling
- 308 characters per second
- IBM & Epson emulation

Circle 311 on Reader Service Card

Micron Memory Boards

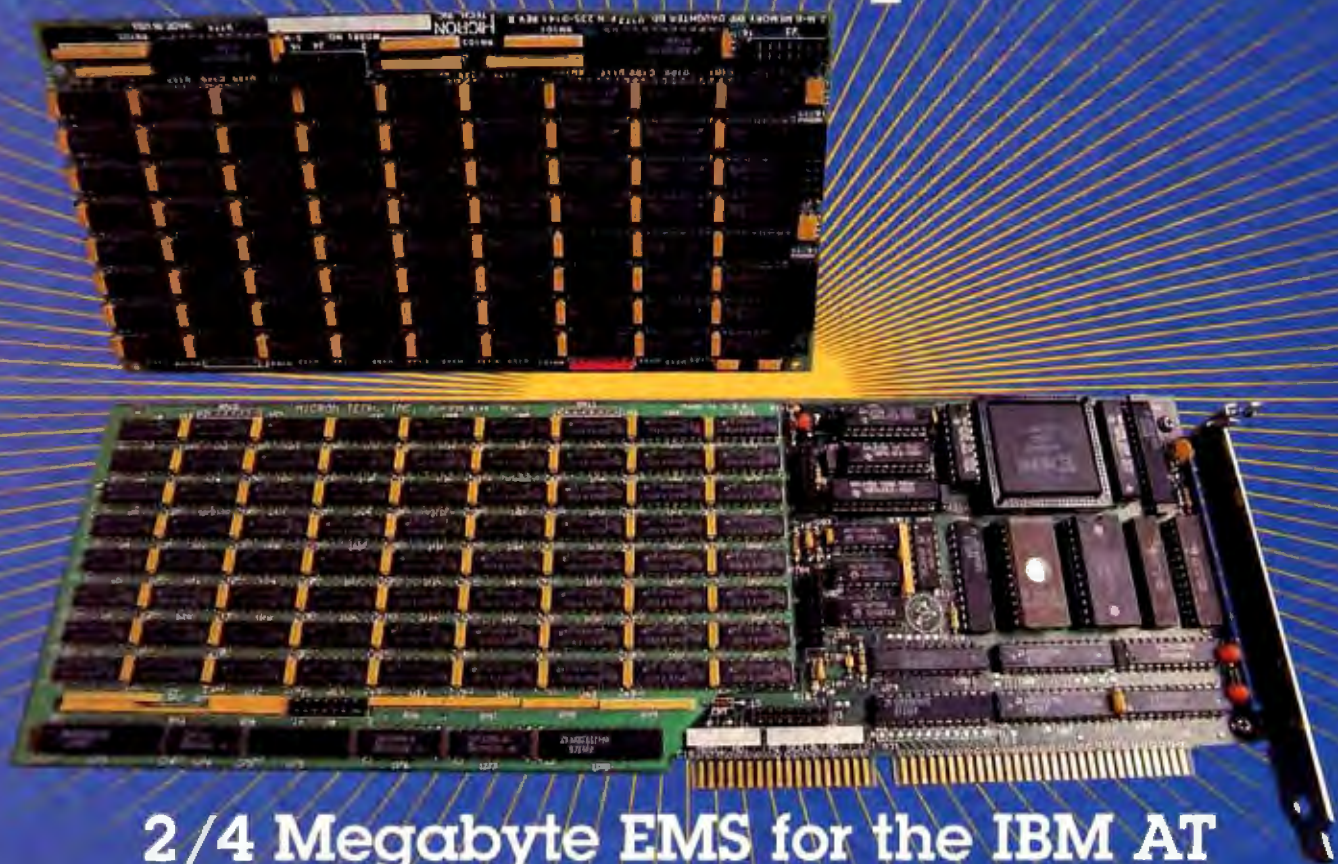

2/4 Megabyte EMS for the IBM AT and Compatibles

- The first and only* hardware board that fully supports EMS, EMS 4.0 and EEMS
- Fully populated with 2 or 4 MB of Micron's own dynamic RAM memory components
- Purchase 2 MB mothercard and 2 MB daughtercard separately or together to fit in a single slot!
- Designed to work with 80286 and 80386 based systems
- Provides expanded and/or extended memory operation
- Automatically configures around bad memory
- Compatible with DOS, OS/2, UNIX and XENIX operating systems
- Operating speeds up to 8 MHz zero wait-state and 12 MHz with one wait-state
- Backfills conventional memory to 640KB
- Data is parity protected
- Easy-to-use installation and configuration software—no switches to set!
- RAM diagnostics, RAM disk and print spooler software included
- Warranted for 2 years to registered users
- Each board is tested under a wide range of environmental conditions to insure high reliability and quality
- Made in the USA

Operating Speeds	2MB	Order Number	4MB
Up to 6 MHz with zero wait-state			
Up to 10 MHz with 1 wait-state	MB-26-DH		MB-46-DH
Daughtercard for MB-26-DH	MB-26-DD		
Up to 8 MHz with zero wait-state			
Up to 12 MHz with 1 wait-state	MB-28-DH		MB-48-DH
Daughtercard for MB-28-DH	MB-28-DD		

Micron Technology, Inc.
Systems Group
2805 East Columbia Road
Boise, Idaho 83706
1-800-MICRON-1
(208) 386-3800

MICRON

TECHNOLOGY, INC.

*As of time of publication. Circle 166 on Reader Service Card

IBM PC, AT and OS/2 are registered trademarks of International Business Machines Corporation. UNIX is a registered trademark of AT&T. XENIX is a registered trademark of Microsoft Corporation.

Features

- 243 **Ciarcia's Circuit Cellar:
The BCC180 Multitasking
Controller**
**Part 2: Memory Management
and Windowing**
by Steve Ciarcia
- 249 **Better Bit-Mapped Lines**
*by Jerry R. Van Aken and
Carrell R. Killebrew Jr.*
- 255 **Focus on Algorithms:
Multicolumn Paged Text**
by Dick Pountain
- 265 **It's All in the Symbols**
by Merrill Cornish
- 273 **System Calls in Modula-2**
by Richard P. Rankin



HypertExpert Systems

...something totally new from Knowledge Garden

HYPertext

Hypertext lets you link related concepts, logic or procedures. It adds a whole new dimension to written material like training manuals, help systems and reference works. Hypertext allows users to access information in a non-linear fashion by following a train of thought. Hypertext lets the reader control the level of detail and the type of information displayed. But that's just one side of the coin.

EXPERT SYSTEMS

The other key ingredient to real exchange of knowledge via the computer is control by the author. That's why integration of hypertext and expert systems is such a breakthrough — it lets communication take place between teacher and pupil, author and reader, expert and novice. It lets each side REACT to what the other says.

Announcing KnowledgePro™, a new development environment, from Knowledge Garden. It integrates **hypertext** with **expert systems** to create the world's first **knowledge processor**. KnowledgePro is unlike anything you have seen before.

KNOWLEDGE PROCESSOR

The age of packaged knowledge is upon us. PC's now have the power to manipulate, store and retrieve knowledge using KnowledgePro, **a language for experts**, and **a tool for beginners**. KnowledgePro is the first system to provide an effective, simple and aesthetic medium for the communication of knowledge on disk.

Big corporations can now construct expert systems for internal use quickly and without expensive AI training. Individuals can author knowledge bases for commercial or educational use.

KNOWLEDGEPRO

KnowledgePro is a totally new development environment created by Bev and Bill Thompson. It costs \$495 plus \$5 shipping and handling and runs on IBM PC, XT, AT or PS/2 with 512k memory. KnowledgePro is not copy-protected and there are no run-time fees. A working demonstration disk is available for \$30 with full credit towards purchase of KnowledgePro. Call today to order your copy.

A LANGUAGE FOR EXPERTS

KnowledgePro is for experts because it provides a wide variety of structures to work with. It has many advanced features, like inference, list processing, topics, procedural control and inheritance. You can write new procedures in other languages and interface to other programs. You can read DBASE III and LOTUS 123 data directly into the knowledge base.

A TOOL FOR BEGINNERS

KnowledgePro let's you communicate knowledge, easily and without spending weeks on the details. KnowledgePro handles the details for you. It provides easy access to colors, windows and mouse control. It's been called the BASIC of the 80's because anyone can get results quickly — and then grow into more sophisticated features at their own pace.

TO ORDER

Call 518-766-3000 (American Express, Visa, M/C accepted) or mail your **check** today.

Knowledge Garden, Inc.
473A Malden Bridge Rd.
Nassau, NY 12123

The run-time version of KnowledgePro is free on the electronic networks or \$15 from Knowledge Garden complete with useful example applications.



Another intelligent tool in the Knowledge Garden family of products.

Published by



IBM is a registered trademark of International Business Machines Inc. KnowledgePro is a trademark of Knowledge Garden Inc. DBASE III is a trademark of Ashton Tate. LOTUS 123 is a registered trademark of Lotus Development Corp. Photo: Tchernikov ©

Part 3: Memory Management and Windowing

The BCC180 Multitasking Controller

The BCC180's multitasking BASIC compiler can operate on a variety of hardware—even on an IBM PC



For the past two months, I've been discussing a 64180-based multitasking computer, the BCC180 (see photo 1). In common with most of my projects, it is hardware, but because of its unique multitasking capabilities, I have made much of the presentation a tutorial on multitasking. This month, I'll conclude with a discussion of the memory management and windowing capabilities of BASIC-180.

Memory and the 64180

The 64180 processor has two great advantages over the Z80. First, it contains a wide variety of on-board peripherals, including timers and universal asynchronous receiver/transmitters (UARTs). Second—and more important—it has an on-board memory management unit (MMU).

The MMU lets the 64180 directly address up to 1 megabyte of memory. The memory connected to the 64180 is called physical memory; it is the entire "universe" of memory available to the processor. The memory that can be addressed with any one map, or configuration, of the MMU is called the logical address space. Every address generated by a user's program is a logical address.

The MMU's role is to translate logical addresses into physical addresses. If, for

Photo 1: *The BCC180 (tall board in the rear) shown here in a typical process-control configuration. In addition to the BCC180's own functions, this system has 32 channels of 12-bit A/D and 16 channels of optoisolated AC I/O.*

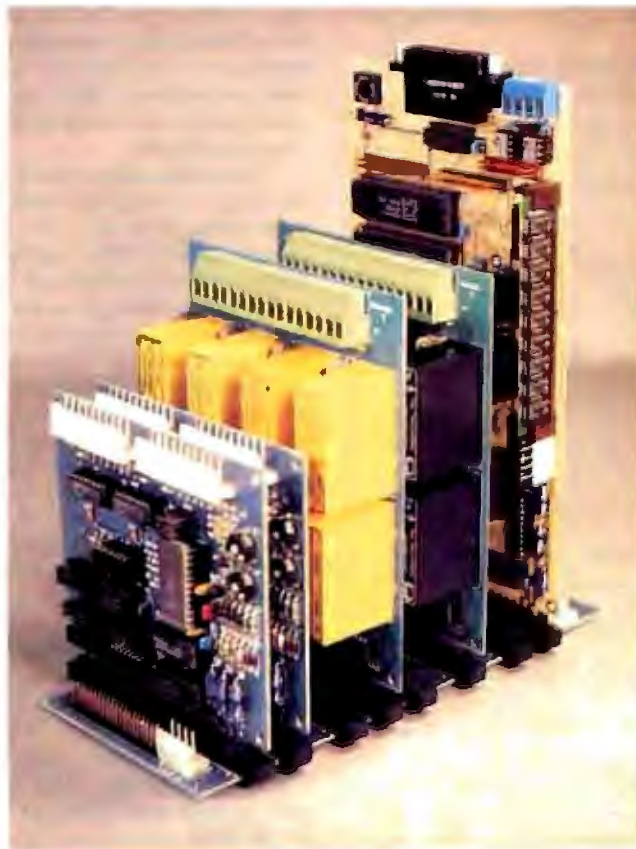

example, a program tries to reference location 0, this is a reference to logical address 0. The actual physical address will be a function of the mapping of the MMU. It may indeed use physical address 0 (on power-up, the MMU translates every logical address to exactly the same physical address). Or, if the program had set the MMU, it could use physical address 10000 hexadecimal. (For the remainder of the article, all addresses will be in hexadecimal unless otherwise specified.)

The 64180's MMU lets programs segment the memory on any one map into three different areas. For instance, references to logical addresses 0 to 3FFF could access physical addresses 0 to 3FFF, references to logical addresses 4000 to 7FFF could access physical addresses 10000 to 13FFF, and the last half of the logical space could access physical addresses 40000 to 47FFF. Virtually any combination is possible.

Using All Available Memory

Although the MMU provides a fairly convenient way to handle large amounts of memory while still maintaining Z80 compatibility,

it is not magic. The MMU is useless unless applications programs are specifically written to use it. None of the thousands of existing CP/M programs can take advantage of the power of the MMU; even running on a 64180, they are still limited to 64K bytes of memory. Handling the MMU is not trivial. Only a handful of programs have been written to take advantage of this powerful feature. Fortunately, BASIC-180 is one of these.

Writing a compiler that generates code to automatically remap the MMU is a

continued

Steve Ciarcia (pronounced "see-ARE-see-ah") is an electronics engineer and computer consultant with experience in process control, digital design, nuclear instrumentation, and product development. The author of several books on electronics, he can be reached at P.O. Box 582, Glastonbury, CT 06033, or on BIX as "sciarcia."

pretty tough task. How would you do it? One approach is to start compiling code from address 0 until FFFF is encountered, then (or shortly before) drop in code to remap the MMU so the next 64K-byte region is available, and so on. This approach can be made to work, but you pay a high price in terms of performance. Every FOR...NEXT, GOTO, and GOSUB may require MMU remapping. Worse, every time a program calls built-in run-time routines (of which there are always many), software may have to remap the MMU.

Interestingly enough, the IBM PC's famous lack of performance is partially due to this. Although the PC does not use a conventional MMU, addresses are pretty much limited to 16 bits. Address references outside a 64K-byte region must involve manipulation of the 8088's segment registers, hampering the machine's performance.

BASIC-180 takes a unique approach. In all operational modes except MAPCOMPILE (which I'll describe later), when a BASIC-180 program is running, it ignores the MMU. (Of course, BASIC-180 does initially configure the MMU, but this occurs only at the program's start.) This ensures that BASIC-180 is compatible with all Z80 systems. You can compile programs of any size to disk, even though the compiler uses only around 48K bytes. If you compile a program using the MAPCOMPILE command, BASIC-180 uses the memory map shown in figure 1.

BASIC-180 compiles the "run-time package"—or library of support code required by a program—at logical address 0 to 3FFF. The compiler maps these logical addresses to the same physical addresses (0 to 3FFF).

The variable area consists of both variables defined in the program and temporaries required by the run-time routines. This area must reside in RAM, whereas all the compiled code typically is in EPROM. The temporary area is compiled from the top of logical memory (64K) down for as far as is required. If 16K bytes of RAM is needed, it is compiled to logical address C000 to FFFF. This area is mapped to physical addresses starting at 7FFFF and down.

Finally, BASIC-180 compiles the user's program into logical addresses between the run-time and RAM areas. Every task is

compiled to the same range of logical addresses. Thus, the lead task starts at address 4000, as does task 1, task 2, and so on. Although these tasks have the same logical address, they reside in memory at different physical addresses. The upshot is that, since a given task "sees" only its own logical space, multiple tasks executing on the same system are largely unaware of one another.

Context Switching

The trick to the success of this approach is context switching. In a multitasking environment, only one task can be executing at any specific moment. BASIC-180 takes advantage of this fact by having the context switcher remap the MMU whenever a tick interrupt is received. The currently executing task's context is saved, and this task is mapped out ("into the ozone," as the experts say) and the next task mapped in. Now, the new task is at the same logical address space as the last one was and can start running.

On the BCC180, a hardware interrupt drives the software context switcher to sequence multitasking. The interrupt is provided by the 64180's internal timer number 0, which BASIC-180 configures to generate 60 interrupts per second. The interrupts from the timer invoke BASIC-180's context switcher, which must then suspend execution of the current task and decide which task to execute next.

The context switcher is structured around a table called the task control block (TCB). Each TCB entry includes the task's current state (e.g., active and suspended), its reschedule interval (specified on the task's RUN statement), how many ticks are left until the interval elapses, the task's priority, the task's memory management map (so the context switcher knows where the task exists in physical memory), and the task's current stack pointer.

Each time the context switcher is invoked, it examines every entry in the table to determine which task must run next, searching in order of priority. The switcher checks tasks' states to find those that are either *suspended* (whose execution was stopped in midstream by an interrupt) or *ready* (they've never been executed but are now ready for execution). It examines tasks of equal priority in a round-robin fashion, giving them all an equal chance to execute.

The switcher starts a ready task at that task's first executable location, and a suspended task at the location it left off when last interrupted. If no task currently requires processor time, the context switcher idles, waiting for the next interrupt. (See table 1 for a further breakdown of task states.)

Context switching is a complex procedure, requiring a substantial number of instructions. The TCB is arranged in a doubly sorted order (by round-robin and by task priority) to speed TCB searches. At 60 ticks per second, less than 5 percent of the processor's time is consumed by context switching.

The process of remapping the MMU occupies a tiny percentage of the context-switching time, so little processing overhead is added. The system can therefore manage large multitasking programs with numerous tasks that sprawl across a megabyte of memory at little expense of processor time.

The 64180's MMU has a minimum mapping resolution of 4K bytes. Therefore, each task compiled by BASIC-180 will take at least 4K bytes, since each task must reside in a separate map.

The revision 1 mask of the 64180 in a plastic leadless chip carrier (PLCC) package supports 20-bit address spaces or 1 megabyte of RAM. BASIC-180 has a somewhat arbitrary limit of 32 tasks per program. In a 1-megabyte address space, each task can therefore take up to 32K bytes (since 32K bytes \times 32 tasks = 1 megabyte). This is quite reasonable, since the run-time package uses 16K bytes. If 16K bytes of RAM is required for variables and temporaries, 32K bytes is left for tasks in the

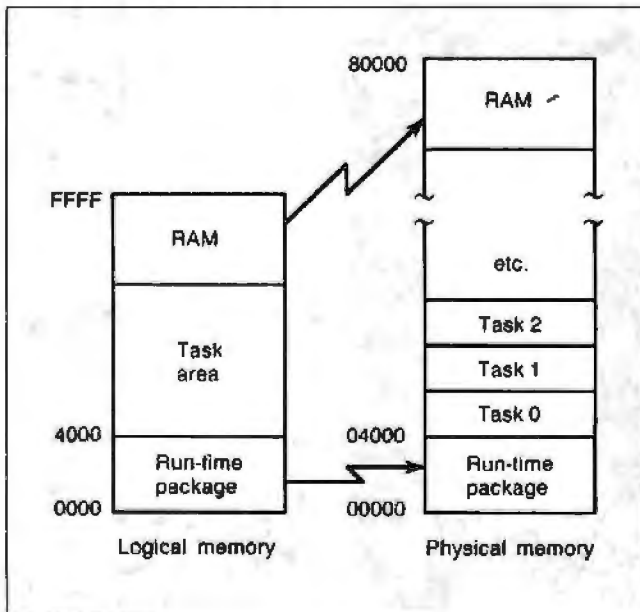

Figure 1: Memory map for programs compiled using the MAPCOMPILE command, showing the relationship between logical memory and physical memory.

logical address space (16K run time + 16K variables/temporaries + 32K program = 64K, the *logical* address space of the 64180).

As you can see, in BASIC-180 large programs are intrinsically tied to multitasking. Nonmultitasking programs are restricted to 64K bytes of total memory use. This encourages programmers to think in terms of segmenting a program into separate, asynchronous activities. A future Circuit Cellar will cover a multiprocessor system, in which this programming style becomes very important.

Interactive Compilation

I don't have the patience to use most high-level languages. The scenario usually goes like this: You invoke an editor, enter the program, call up the compiler, which inevitably points out a few misplaced semicolons (I thought the computer was supposed to relieve me of trivia...), so you have to go back to the editor, fix the code, and recompile, by now hoping desperately that some other silly syntactical mistake isn't still lurking.

After the compiler is finally happy, you repeat the same process with the linker. (Oh, no! The linker looks at only seven characters of a symbol, but my language recognizes eight! Back to the editor, boys.) Finally, you're ready to test the program. If it doesn't work, you'll often edit lots of print statements into the code to try and localize the problem. No wonder programmers get only 10 lines of good code a day.

BASIC-180 supports two very different development environments. You can write and test code on the BCC180 itself, or you can write and at least partially test code on a host computer like the SB180. This kind of cross-development environment is nice because you can use all the resources of the operating system.

The most important of these is the disk system. (I'm seriously considering adding a floppy disk drive and small computer system interface [SCSI] hard disk interface board to the BCC bus very soon. Circuit Cellar Ink will contain news of that construction project.) You can save various versions of the source and compiled code, adapt portions of old programs for use in a new one, and take advantage of operating-system utilities to ease the development process.

The downside of developing code on a host system is the lack of compatible I/O. In any process-control system, the BCC180 will no doubt be connected to unusual I/O devices not available to the host development system (e.g., parallel I/O lines connected to contact closures, relays, and so forth). For the present, this involves a trade-off.

Most systems use limited access to I/O. If speed is not the overriding consideration, you should use well-designed modular code to segment the I/O drivers into driver routines. When operating in a cross-development mode, you can replace these drivers with code that simulates the behavior of the physical devices. Perhaps only limited simulation is practical, but you can still test much of the code.

BASIC-180 will run on the SB180 just as it does on the BCC180. The BASIC source code is 100 percent compatible. BASIC-180 will even run on an IBM PC under a CP/M simulator like ZSIM from Z-World.

On a cross-development system, you can compile and test BASIC code in one of three ways: interactively, using the DISKCOMPILE command, or using the MAPCOMPILE command.

When compiling interactively, BASIC-180 appears to operate just like an interpreter. You sign on to the BASIC and edit, run, test, and modify programs, all under the control of BASIC-180. BASIC-180 includes a line editor for easy entry and alteration of programs. Using the SAVE and LOAD commands, you can save code to and load it from disk.

The RUN command starts a BASIC program executing, as in

Table 1: Task states.

Active: The task is actually executing. Only one task can be active at any time.

Ready: The task has as yet not been executed but is ready for execution as soon as CPU time becomes available

Suspended: The task was executed but was preempted by a clock tick. It is ready to resume execution from where it left off as soon as CPU time becomes available

Waiting: The task was executing but put itself in an idle mode. The CPU will restart the task after a specified amount of time measured in clock ticks

Dormant: The task has not been made available for execution. It requires no CPU time.

an interpreter. However, when you issue RUN, BASIC-180 compiles the program into true native machine code, then executes it. The program—being compiled instead of interpreted—runs faster. Furthermore, the RUN command causes BASIC-180 to compile the program to RAM—not disk—so compilation is also speedy. (On the SB180, compilation is over 150 BASIC statements per second.) Best of all, you can test, modify, and retest the program in seconds, just as in an interpreter. As far as I'm concerned, this is the only way to develop code. Only a few other languages now use this approach.

Once you have your program working the way you want it to, you can compile it to an efficient disk file using the DISKCOMPILE command. BASIC-180 reads the BASIC source code from a disk file, converts it to native 64180 object code, and saves it to a stand-alone executable file, just like any other CP/M program.

You can use DISKCOMPILE to create program files that you ultimately convert to Intel hexadecimal format and burn into EPROMs for stand-alone execution on the BCC180. BASIC-180 always generates ROMable code. This means that programs created with BASIC-180 require only limited operating-system support, if any, and the code and data areas of a BASIC-180 program are kept separate. BASIC-180 lets you define where RAM should be, so you can support the segmented memory typical of ROM-based systems.

To create large multitasking programs, you use BASIC-180's MAPCOMPILE command. MAPCOMPILE produces a root .COM file that contains a loader and the run-time routines. It then generates a file for each task. These files have the extension .Txx, where xx is the task number. When you invoke the root program (by typing its name, just as you would for any other .COM file), the built-in loader reads each of the task files from disk into the proper area of physical memory, remapping the MMU as required.

Plug and Go

A truly unique feature of the BCC180 version of BASIC-180 is that the compiler itself, and not just the compiled code, can operate from ROM on the BCC180. Most languages need a great deal of operating-system support. A few interpreted BASICs operate from ROM (like the ROM BASIC for the IBM PC), but you'll find few ROM-resident BASIC compilers.

BASIC-180 supports its interactive development environment even in ROM. You'll find nearly all the features available on disk-based systems in the ROM version, including a line editor.

continued

The ROM version of BASIC-180 requires just the BCC180 board, a terminal, and a power supply (you'll need the optional BCC180 EPROM programmer board to generate ROM-based programs). When powered up, the BASIC or a system monitor is available immediately. You can enter, edit, and test programs, just as if you were using an interpreter.

The great advantage of developing code on the BCC180 is that you have all the BCC180's resources available. There is no need to write I/O simulation routines; you can develop critical I/O handlers interactively. Without disks, however, there would seem to be no way to save BASIC source or compiled code. Fortunately, past experience suggested a solution to this problem.

One of the better features of my 8052-based BCC52 is its on-board EPROM programmer that functions like write-once mass storage. I can't stand to rekey programs, so when Softaid's people designed this BASIC-180, I had them add the ability to save programs directly to EPROM in the same manner as the BCC52. When you connect the BCC180's auxiliary EPROM burner, you can use ROMSAVE and ROMLOAD to save and retrieve programs to and from an EPROM (27256). BASIC-180 burns a tokenized (compressed) form of the BASIC source program into the EPROM.

Of course, BASIC-180 doesn't create any sort of file structure on the EPROM. ROMSAVE simply burns each program into the next unused spot in the EPROM, assigning that program a

(a)

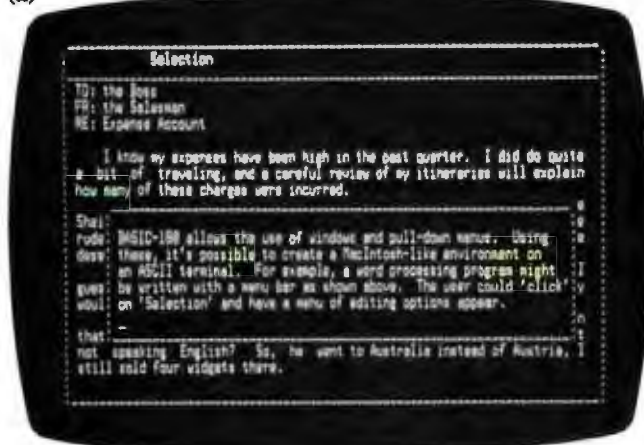

(b)



Photos 2a and 2b: BASIC-180's multitasking windows are sophisticated enough to simulate a Macintosh environment on a serial terminal, as shown in (a) and (b) above.

sequential number that ranges from 1 to the number of programs in the EPROM. You load a program from an EPROM using ROMLOAD, which requires as an input argument the ROMSAVE-generated number of the program.

You can also use MAPCOMPILE to compile programs into the EPROM. In this case, MAPCOMPILE burns the programs into the EPROM at the compiled physical addresses, so that you can create a program that executes on power-up by placing the EPROM in the appropriate BCC180 ROM socket(s).

Windowing

When I first ran into multitasking, I was confused as to how different tasks would handle terminal display I/O. What happens when I program three tasks to simultaneously display results? Do I end up with a jumbled mess of asynchronous PRINT statements going to a common display? Of course not.

BASIC-180 gives you a complete set of window control statements. A window is a subsection of the CRT display terminal with a definable size and position. A window can be any size (up to 24 lines by 80 characters), and you can have up to 10 windows in use at once. When your program selects a window, all output will go to that window until the program selects another. The window's borders act as barriers to PRINT statements (see photos 2a and 2b).

BASIC-180 lets you assign windows to tasks, so that you might assign window 1 to task 4 and window 2 to task 12. All output from task 4 will then go to window 1, and all output from task 12 will go to window 2.

The following BASIC-180 statements control windowing:

WINDOW defines a window's size and location.

WSELECT selects a window for output.

WFRAME draws an outline around a window.

WCLEAR erases a window.

WSAVE saves the contents of a window to an array.

WUPDATE restores to the screen a window that has been saved with WSAVE.

The following program defines a square window 10 characters wide and high, whose upper left corner is at column 10, row 10, on the CRT. It is defined as window number 1. A box is drawn around it using the "_" and "|" characters:

```

10 WSELECT 1
20 WINDOW 10,10,20,20
30 WFRAME "_", "|"

```

All subsequent PRINT statements will send their output to this window.

The WSAVE and WUPDATE statements let you write programs with pop-up or pop-down windows, so you can create programs with a Macintosh-like user interface. WSAVE saves on-screen data located behind the pop-up/pop-down window, and WUPDATE restores the screen after the window has been removed.

The following program draws three windows side by side on the screen and assigns a task to each one. All three tasks then run concurrently, each one writing to the window assigned to it:

```

5 INTEGER T1,T2,T3,A,B,C,D,I
10 ERASE
100 DATA 1,1,10,10
105 DATA 1,12,10,22
110 DATA 1,26,10,35
200 FOR I=0 TO 15 STEP 4
210 WSELECT I / 4
220 READ A,B,C,D

```

continued

STATGRAPHICS®

New Version—2.6
Upgrades Available



Select the points you want to remove from your regression model...

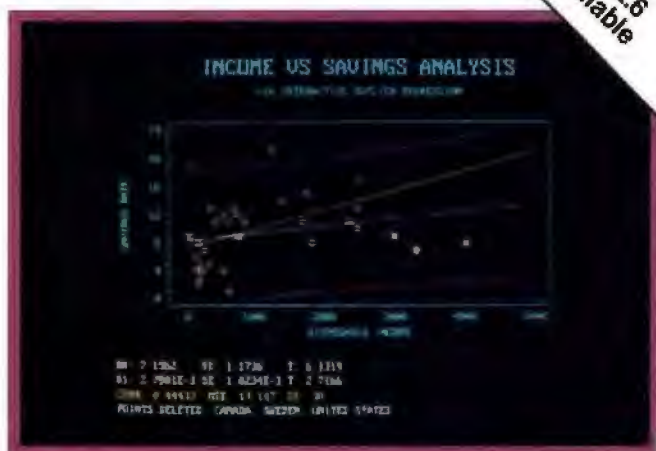

... Then press F6 to refit the model and recalculate the statistics.

Because "Statistical Graphics" Is Better Than Just Statistics and Graphics

Most of today's PC statistical packages give you all the statistics you'll ever need. Some even give you a few graphics. But only STATGRAPHICS from STSC gives you integrated statistical graphics in an environment you control.

Unique "What If" Interactivity

STATGRAPHICS lets you explore data relationships fully, producing higher quality, more timely solutions. Define your data and assumptions, run the procedure and review the results, modify data and assumptions repeatedly and take another look—and another. All without leaving the procedure or making permanent changes to your data.

Integrated Statistical Graphics

Coupled with STATGRAPHICS' interactive environment are over 50 types of graphs—traditional pie and bar charts, histograms, 3-D line and surface plots, quality control charts, and more. All are integrated with the procedures so that they can be displayed instantly and modified repeatedly.

Query data points, do on-screen forecasting and model fitting, overlay graphs, or zoom-in on any area for a closer look. With flexibility like that, you can spot and investigate visual trends in your data—trends you may have missed if you looked only at the numbers.

Over 250 Statistical Procedures

- Direct Lotus® and dBASE® interfaces
- ANOVA and regression analysis
- Experimental design
- Quality control procedures
- Multivariate techniques
- Nonparametric methods
- Exploratory data analysis
- Forecasting, time series analysis, and more.

STATGRAPHICS—

The Best Way to Do Statistics!

Put the power of STATGRAPHICS to work for you today—all for only \$895*. For our free convincer kit or the name of a dealer near you, call

(800) 592-0050 ext. 400

In Maryland, (301) 984-5123;
Internationally, (301) 984-5412.
Telex 898085 STSC ROVE

STSC STSC, Inc.
2115 East Jefferson Street
Rockville, Maryland 20852

*Suggested retail price in U.S. and Canada. International prices vary. Available through dealers and distributors worldwide. STATGRAPHICS, PLUS*WARE, Lotus, and dBASE are registered trademarks of Statistical Graphics Corporation, STSC, Inc., Lotus Development Corporation, and Ashton-Tate, respectively.

A PLUS*WARE® PRODUCT

Circle 254 on Reader Service Card

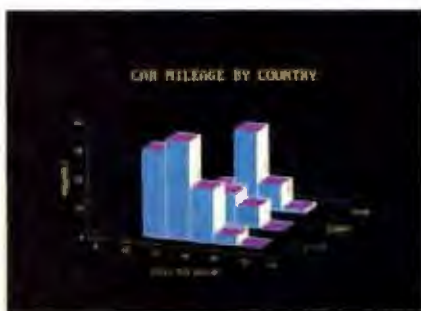
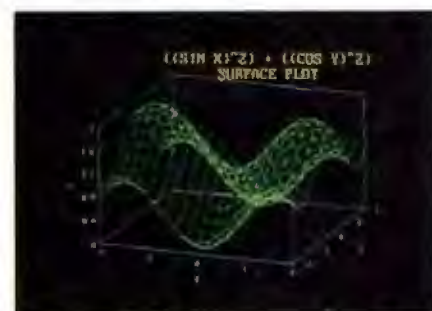

A wide variety of graphs supported on over 100 displays, printers and plotters, including the new IBM PS/2™ Series.

```

230 WINDOW A,B,C,D
240 WFRAME "_", "|"
250 WINDOW A + 1, B + 1, C - 1, D - 1
260 NEXT I
300 RUN 1, 30
301 RUN 2, 50
302 RUN 3, 70
310 GOTO 310
1000 TASK 1
1010 WSELECT 0
1020 WCLEAR
1030 FOR T1=1 TO 9:
    PRINT "TASK 1": WAIT 5:
    NEXT T1
1040 EXIT
1100 TASK 2
1110 WSELECT 1
1120 WCLEAR
1130 FOR T2=1 TO 9:
    PRINT "TASK 2": WAIT 5:
    NEXT T2
1140 EXIT
1200 TASK 3
1210 WSELECT 2
1220 WCLEAR
1230 FOR T3=1 TO 9:
    PRINT "TASK 3": WAIT 5:
    NEXT T3
1240 EXIT

```

Windowing makes extensive use of the cursor-positioning commands of the terminal you're using but, since no standard exists for terminal cursor positioning, the disk-based version of BASIC-180 comes bundled with an installation program that lets you configure it for your terminal or terminal emulator (the ROM-based version has patch points). BASIC-180 can support virtually any terminal's format.

In Conclusion

Finally, I am the quintessential nonprogrammer. I even design hardware to get around programming. The BCC180 and BASIC-180 do serve my purpose, and I hope you find them useful as well. Indeed, they let you work in an easy language, and they support the multitasking that has become so essential as applications become more complex. But, foremost, they raise personal computing performance to a level you would expect only in more expensive microcomputer systems.

Next Month

The Circuit Cellar SmartSpooler. ■

I'd like to acknowledge and personally thank Ken Davidson and Jack Ganssle for their efforts on the BCC180 project. Ken Davidson's extensive knowledge of the HD64180 helped us avoid the omnipresent hardware design pitfalls, and Jack Ganssle's superb software talents helped explain multitasking in a way that can really be understood.

Editor's Note: Steve often refers to previous Circuit Cellar articles. Most of these past articles are available in book form from BYTE Books, McGraw-Hill Book Co., P.O. Box 400, Hightstown, NJ 08250.

Garcia's Circuit Cellar, Volume I covers articles in BYTE from September 1977 through November 1978. *Volume II* covers December 1978 through June 1980. *Volume III* covers July 1980 through December 1981. *Volume IV* covers January 1982 through June 1983. *Volume V* covers July 1983 through December 1984. *Volume VI* covers January 1985 through June 1986.

It's virtually impossible to provide all the pertinent details of a project or cover all the designs I'd like to in the pages of BYTE. For that reason, I have started a bimonthly supplemental publication (with no advertising) called Circuit Cellar Ink, which presents additional information on projects published in BYTE, new projects, and supplemental applications-oriented materials. For a one-year subscription (6 issues), send \$14.95 to Circuit Cellar Ink, P.O. Box 3378, Wallingford, CT 06494. Credit card orders can call (203) 875-2199.

For more information on MTBASIC for Z80, 64180, or MS-DOS machines, contact Softaid Inc., 8930 Route 108, Columbia, MD 21045, (301) 964-8455.

The following items are available from

Micromint Inc.
4 Park St.
Vernon, CT 06066
For orders: (800) 635-3355
For information: (203) 871-6170
Telex: 643331, Fax: 2038722204
Inquiry 932.

1. A 9-MHz assembled and fully socketed BCC180 computer/controller board with 32K bytes of static RAM, ROM monitor, BASIC-180 development software (same as item 3), and user's manuals. BCC180-I-20.....\$395; for additional 256K DRAM, add \$100
2. BCC180 PAK evaluation system. Contains a 9-MHz BCC180 board with 32K-byte static RAM, ROM monitor, BASIC-180 development software, MB08 eight-slot backplane, CCO1 10-inch card cage, UPS10 35-watt switching power supply, and user's manuals. BCC180-PAK\$595; for additional 256K DRAM, add \$100
3. BASIC-180 multitasking BASIC compiler for ROM- or disk-based development. Contains both BASIC-180 EPROM for direct use on BCC180 board and BASIC-180 disk for direct use or software development on SB180. Includes 100-page user's manual. Compiled code may be freely used without further license. BASIC-180 DEV\$250
4. An auxiliary 27256 EPROM programmer board for the BCC180. BCC180PROG5.....\$89

The following items are available from

CCI
P.O. Box 428
Tolland, CT 06084
(203) 875-2751
Inquiry 933.

1. A 9-MHz BCC180 computer/controller complete kit with 32K bytes of static RAM, ROM monitor, BASIC-180 development software, and user's manual. BCC180-KIT-20.....\$295
2. BCC180 auxiliary 27256 EPROM programmer board full kit. BCC180PROG5K.....\$74

For either source above, all payments should be made in U.S. dollars by check, money order, MasterCard, Visa, or American Express. Surface delivery (U.S. and Canada only): add \$5 for U.S., \$8 for Canada. For delivery to Europe via U.S. airmail, add \$14. Three-day air freight delivery: add \$10 for U.S. (UPS Blue), \$25 for Canada (Purolator overnight), \$45 for Europe (Federal Express), or \$60 for Asia and elsewhere in the world (Federal Express). Shipping costs are the same for one or two units.

There is a multiline Circuit Cellar bulletin board system (running TBBS 2.01M) that supports past and present projects in BYTE and Ink. You are invited to call and exchange ideas and comments with other Circuit Cellar supporters. The 300/1200/2400-bps BBS is on-line 24 hours a day at (203) 871-1988.

To receive information about the Circuit Cellar Ink publication for hardware designers and developers, please circle 100 on the Reader Service inquiry card at the back of the magazine.

Better Bit-Mapped Lines

Bresenham's Line Algorithm provides a quick way to approximate lines on a bit-mapped display

Drawing a line is a fundamental operation in a computer graphics system, but representing a line on a bit-mapped display is not as simple as it seems. The problem is that computers cannot represent a straight line exactly. Since few pixels are likely to lie exactly on the line, a line algorithm must choose a connected set of pixels that follows the path of the line as closely as possible.

Early computer graphics systems used a digital differential analyzer (DDA) algorithm to choose the pixels for drawing a line. DDA line generation suffers because the algorithm uses floating-point arithmetic, which is slow in a typical computer system. A line algorithm using simple integer arithmetic would be much faster.

In 1965, Jack Bresenham of IBM published a fast line-drawing algorithm that uses only integer addition and subtraction. This article derives Bresenham's Line Algorithm from basic principles and provides source program listings in Pascal. [Editor's note: Source code listings for this article are available on BIX, on BYTENet, on disk, and in the Quarterly Listings Supplement. See "Program Listings" in the table of contents.]

Drawing a Line Faster

Figure 1 illustrates the basic principle of Bresenham's algorithm. A line segment extends from the origin to a point (a,b) , and the equation that must be satisfied by all points on this line is

$$f(x,y) = b \times x - a \times y = 0.$$

Points that do not satisfy this equation lie to one side or the other of the line. As Bresenham's algorithm tracks the line from beginning to end, it measures the value of $f(x,y)$ at regular intervals in order to choose pixels along the way to represent the line. At a point (x,y) located below the line, $f(x,y)$ is positive (i.e., $b \times x - a \times y > 0$). Above the line, $f(x,y)$ is negative. By monitoring the sign of the function at or near the current pixel, the algorithm can tell whether it is moving too far above or below the line, and make a course correction when choosing the next

Jerry R. Van Aken is a member of the development team for the TMS34010 graphics system processor. Carrell R. Killebrew Jr. is responsible for engineering and marketing for the TMS34010 in personal computers and commercial applications. Both can be contacted at Texas Instruments, P.O. Box 1443, Mail Station 712, Stafford, TX 77251.

pixel. This is a powerful technique that has been extended to computer drawing of more complex curves such as circles, ellipses, and other conic sections.

Figure 2 is a line drawn by the algorithm. The line segment starts at $(0,0)$, ends at $(10,4)$, and is defined by the equation

$$f(x,y) = 4 \times x - 10 \times y = 0.$$

The algorithm selects the pixels in figure 2 that lie as close as possible to the actual line. As the line is drawn from left to right, each new pixel is selected to be either the pixel directly to the right of the previous pixel (a horizontal move), or the pixel above and to the right of the previous pixel (a diagonal move).

The algorithm chooses between these two pixels by determin-

continued

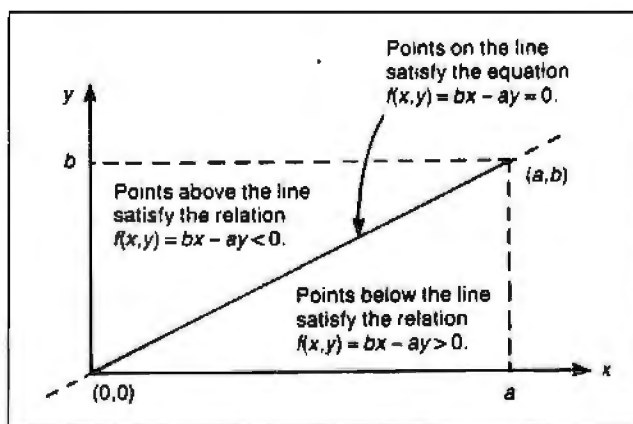

Figure 1: Basic principles of the algorithm.

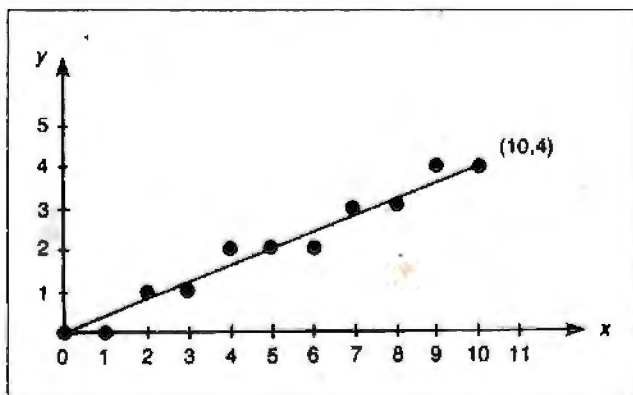

Figure 2: Pixel approximations of line from origin to $(10,4)$.

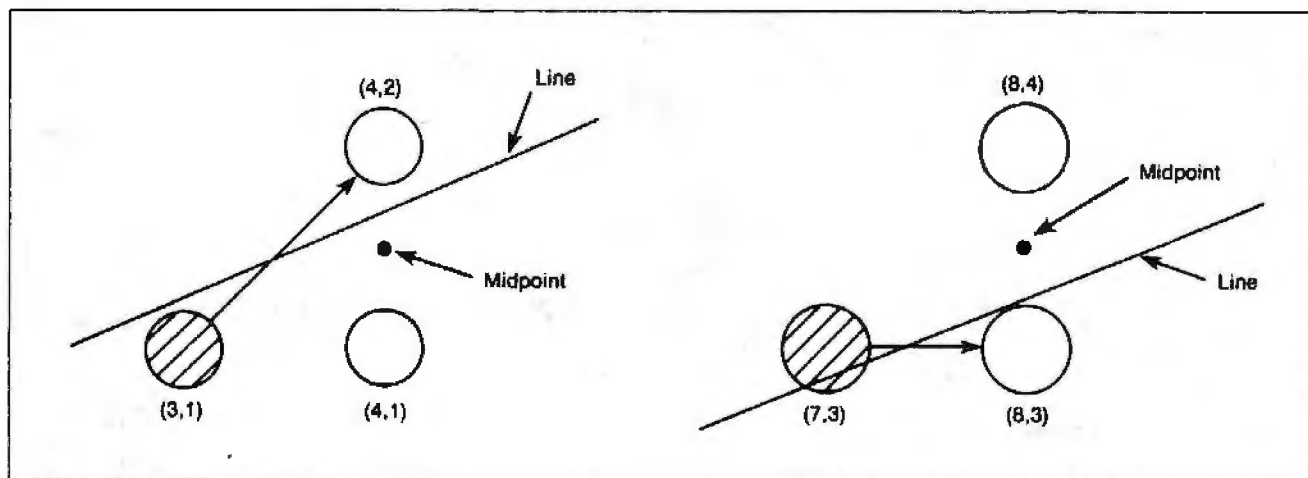

Figure 3: Examples of the decision process.

Listing 1: A line algorithm restricted to the first octant.

```

procedure draw_line (a, b: integer);
    { a is the endpoint x
      coordinate. }
    { b is the endpoint y
      coordinate. }

var x,          { current x coordinate }
    y,          { current y coordinate }
    d,          { decision variable }
    i:          { loop index }
    integer;

begin ( draw_line )
    x := 0;      { line starts at (0,0) }
    y := 0;
    for i := 0 to a do { Draw the a+1 pixels
                        in the line. }
        begin
            draw_pixel(x,y);
            d := b * (x + x + 2) { Evaluate line
                                formula at
                                midpoint. }
                - a * (y + y + 1);
            if d < 0 then { Is midpoint above
                          the line? }
                x := x + 1; { Yes, step
                              horizontally. }
            else
                begin { Midpoint is below the
                       line, }
                    x := x + 1; { so step diagonally. }
                    y := y + 1
                end { else }
            end { for }
        end; { draw_line }
    
```

ing which is closer to the actual line. It does so by checking whether the point exactly halfway between the two pixels lies above or below the line. If the line passes below the midpoint, it chooses the lower pixel; otherwise, it chooses the upper pixel.

Figure 3a shows where the algorithm chooses the upper pixel. It illustrates the decision process performed by Bresenham's algorithm in selecting the pixel at (4,2) in figure 2. The pixel at (3,1) is already turned on, having been selected in the previous

step. The problem now is to choose between the pixels at (4,1) and (4,2). To make this decision, the algorithm evaluates the function $f(x,y) = 4 \times x - 10 \times y$ at a point lying at (4,1.5), halfway between the two pixels under consideration. At the midpoint, the function evaluates to $4 \times 4 - 10 \times 1.5 = 1$. Since this is a positive value, the midpoint must lie below the line. The pixel at (4,2) therefore lies closer to the line, and is selected.

Figure 3b is an example where the algorithm selects the lower of the two pixels it considered. This figure illustrates the selection of the pixel at (8,3) in figure 2. The algorithm chooses the pixel at (8,3) over the one at (8,4) by observing that the function $f(x,y)$ evaluated at the midpoint (8,3.5) is $4 \times 8 - 10 \times 3.5 = -3$. The negative value indicates that the midpoint is located above the line. The pixel at (8,3) therefore is closer to the line than the one at (8,4) and is selected.

The Basic Algorithm

Listing 1 is a rudimentary form of the algorithm capable of drawing the line shown in figure 2. It takes as its input arguments the endpoint coordinates a and b . For the sake of simplicity, assume that the starting point is always (0,0) and that the endpoint coordinates (a,b) satisfy the relation $0 \leq b \leq a$, where a and b are integers. (In other words, point (a,b) lies in the first octant of Cartesian coordinate space.) The algorithm is easily extended to overcome these restrictions, as we will show later.

A drawback to this form of the algorithm is that each iteration of the inner loop requires two multiplications, which are more time-consuming than simple operations such as addition. A later version of the algorithm will replace the multiplications with simpler operations in order to speed up line drawing. The line drawn by the algorithm in listing 1 is described by the equation $f(x,y) = b \times x - a \times y = 0$. At the start of iteration i of the for loop, a single pixel is drawn at the current location $(x[i], y[i])$ by the function draw_pixel. As illustrated in the examples of figure 2, the two candidate pixels for the next point to be drawn are located at $(x[i] + 1, y[i])$ and $(x[i] + 1, y[i] + 1)$, and the midpoint of these two pixels is at $(x[i] + 1, y[i] + \frac{1}{2})$. The algorithm chooses between the two candidate pixels based on the sign of $f()$ evaluated at the midpoint, which is $b \times (x[i] + 1) - a \times (y[i] + \frac{1}{2})$. The algorithm in listing 1, in fact, assigns twice this value to variable d , called the decision variable:

$$\begin{aligned}
 d[i] &= 2 \times f(x[i] + 1, y[i] + \frac{1}{2}) \\
 &= b \times (2 \times x[i] + 2) - a \times (2 \times y[i] + 1).
 \end{aligned}$$

Multiplying $f()$ by 2 ensures that d is an integer for all values of

a ; the factor of 2 has no other effect, since the sign of d will always be the same as that of $f()$ evaluated at the midpoint.

Speeding Up the Algorithm

You can make the algorithm in listing 1 faster by reducing the calculations required to evaluate d during each iteration of the loop. In general, d increases by $2 \times b - 2 \times a$ for a diagonal step, and by $2 \times b$ for a horizontal step. A little algebra shows that this is always true. In stepping diagonally from a point

$$(x[i], y[i])$$

to

$$(x[i] + 1, y[i] + 1),$$

the value of d changes from

$$d[i] = 2 \times b \times x[i] + 2 \times b - 2 \times a \times y[i] - a$$

to

$$d[i + 1] = 2 \times b \times x[i] + 4 \times b - 2 \times a \times y[i] - 3 \times a$$

(a change of $2 \times b - 2 \times a$). When a horizontal step is taken from a point

$$(x[i], y[i])$$

to

$$(x[i] + 1, y[i]),$$

the value of d changes from

$$d[i] = 2 \times b \times x[i] + 2 \times b - 2 \times a \times y[i] - a$$

to

$$d[i + 1] = 2 \times b \times x[i] + 4 \times b - 2 \times a \times y[i] - a$$

(a change of $2 \times b$). By calculating these two values prior to entering the drawing loop, you can improve line-drawing performance. This way, you reduce updating d during each iteration to simply incrementing d by the appropriate loop constant.

Listing 2 is an improved version of the algorithm in listing 1. It eliminates the two multiplies per loop, and updates decision variable d incrementally. It calculates the initial value of d in terms of the initial values of x and y as follows:

$$d[0] = b \times (2 \times x[0] + 2) - a \times (2 \times y[0] + 1) = 2 \times b - a$$

where $x[0] = y[0] = 0$. Two new variables, `nondiag_inc` (which equals $2 \times b$) and `diag_inc` (which equals $2 \times b - 2 \times a$) are created to increment d during each iteration.

A Fast Unrestricted Algorithm

The algorithm in listing 2 is still subject to the restrictions that the starting point must lie at (0,0) (the origin), and the endpoint coordinates must satisfy $0 \leq b \leq a$ (which restricts the ending point to the first octant of Cartesian coordinate space). In listing 3, both restrictions have been removed by using symmetry and translation. This is the final form of Bresenham's algorithm.

Figure 4 illustrates how you can use symmetry to draw lines in any of the eight octants. Although each of the eight lines is in a different octant, the lines all have the same shape because they follow identical sequences of diagonal and nondiagonal steps in moving from the starting point to the ending point. The symmetry of the eight lines in figure 4 results from the fact that the algo-

continued

LOOK!
It's Flow Charting II+!

The ultimate fast track tool—for internal auditors, public auditors, secretaries, engineers, managers and line leads. Performance power WITH A PLUS, for even faster and easier construction, editing and printing of flowcharts and org charts.

- Text auto centering
- Smart line mode
- Internal mouse driver
- 10 text fonts
- Ega support
- Comprehensive, friendly manual

Give your charts the PLUS for only \$229*. Contact your local software dealer—or call us.

PATTON & PATTON
Sales and Marketing

81 Great Oaks Blvd., San Jose, CA 95119
1-800/672-3470, ext. 897 California
1-800/538-8157, ext. 897 Outside California
408/629-5044 International
*plus shipping. In California add tax.

Excellence in charting the flow of ideas

Listing 2: A faster line algorithm, but still restricted to the first octant.

```

procedure draw_line (a, b: integer);
{ a is the endpoint x coordinate. }
{ b is the endpoint y coordinate. }
var x,          { current x coordinate }
    y,          { current y coordinate }
    d,          { decision variable }
    diag_inc,   { d's increment
                 for diagonal steps }
    nondiag_inc: { d's incr. for
                 non-diagonal steps }
                integer;
begin { draw_line }
  x := 0;      y := 0; { start at (0,0) }
  d := b + b - a; { initial value for d }
  nondiag_inc := b + b;
  { Evaluate the d increment values. }
  diag_inc := b + b - a - a;
  for i := 0 to a do { Draw the
                    a+1 pixels in the line. }
    begin
      draw_pixel(x,y);
      if d < 0 then { Is midpoint
                    above the line? }
        begin { Yes, step horizontally. }
          x := x + 1;
          d := d + nondiag_inc { Update the
                               decision variable. }
        end { if-then }
      else
        begin { Midpoint is below the line, }
          x := x + 1; { so step diagonally. }
          y := y + 1;
          d := d + diag_inc { Update the
                             decision variable. }
        end { else }
      end { for }
    end; { draw_line }

```

Listing 3: Final form of Bresenham's Line Algorithm.

```

procedure draw_line (xstart, ystart, xend,
                    yend: integer);

var x, y,          {current x and y coordinates}
    d,             {decision variable}
    a, b,         {line displacements in x and y}
    dx_diag,      {diagonal x step for next pixel}
    dy_diag,      {diagonal y step for next pixel}
    dx_nondiag,   {nondiagonal x step for next
                  pixel}
    dy_nondiag,   {nondiagonal y step for next
                  pixel}
    diag_inc,     {d's incr. for diagonal steps}
    nondiag_inc,  {d's incr. for nondiagonal
                  steps}
    swap:         {temporary variable for swaps}
                  integer;

begin(draw_line)
  x := xstart;    {line starting point}
  y := ystart;
  {Determine drawing direction and step to the
  next pixel.}
  a := xend - xstart; {Calculate difference
                      in x}
  b := yend - ystart; {Calculate difference
                      in y}

```

```

{Determine whether ending point lies to right
or left of start point.}
if a < 0 then {Drawing towards smaller
              x-values?}
  begin {Yes, because a is negative.}
    a := -a; {Make a positive }
    dx_diag := -1 {and set x-movement
                  accordingly.}
  end
else {Draw is towards larger x-
     values.}
  dx_diag := 1; {Set x-movement towards
                larger x.}
{Determine whether ending point lies above or
below starting point.}
if b < 0 then {Drawing towards smaller y-
              values?}
  begin {Yes, because b is negative.}
    b := -b; {Make b positive and}
    dy_diag := -1 {set y-movement
                  accordingly.}
  end
else {Draw is towards larger y-
     values.}
  dy_diag := 1; {Set y-movement towards
                larger y.}
{Identify octant containing ending point. }
if a < b then {Is y-diff. larger than
              x-diff.??}
  begin {Yes, so swap a and b }
    swap := a;
    a := b;
    b := swap;
    dx_nondiag := 0; {Since y difference is
                     larger, x}
    dy_nondiag := dy_diag {doesn't change on
                           nondiagonal}
  end{if-then} {steps, but y changes
               every step.}
else {When x-diff. is larger than }
  begin {y-diff., x changes every
        step,}
    dx_nondiag := dx_diag; {and y changes
                            only on the}
    dy_nondiag := 0 {diagonal steps.}
  end{else}
  d := b + b - a; {Initial value for d is
                  2*b-a.}
  nondiag_inc := b + b; {Set initial d
                        increment values}

  diag_inc := b + b - a - a;
  for i := 0 to a do {Draw the a+1 pixels.}
    begin
      draw_pixel(x,y);
      if d < 0 then {Is midpoint above the
                    line?}
        begin {Yes, step nondiagonally.}
          x := x + dx_nondiag;
          y := y + dy_nondiag;
          d := d + nondiag_inc {Update the
                               decision variable.}
        end{if-then}
      else {Midpoint is below the line,}
        begin {so step diagonally.}
          x := x + dx_diag;
          y := y + dy_diag;
          d := d + diag_inc {Update the decision
                             variable.}
        end{else}
      end{for}
    end;{draw_line}

```

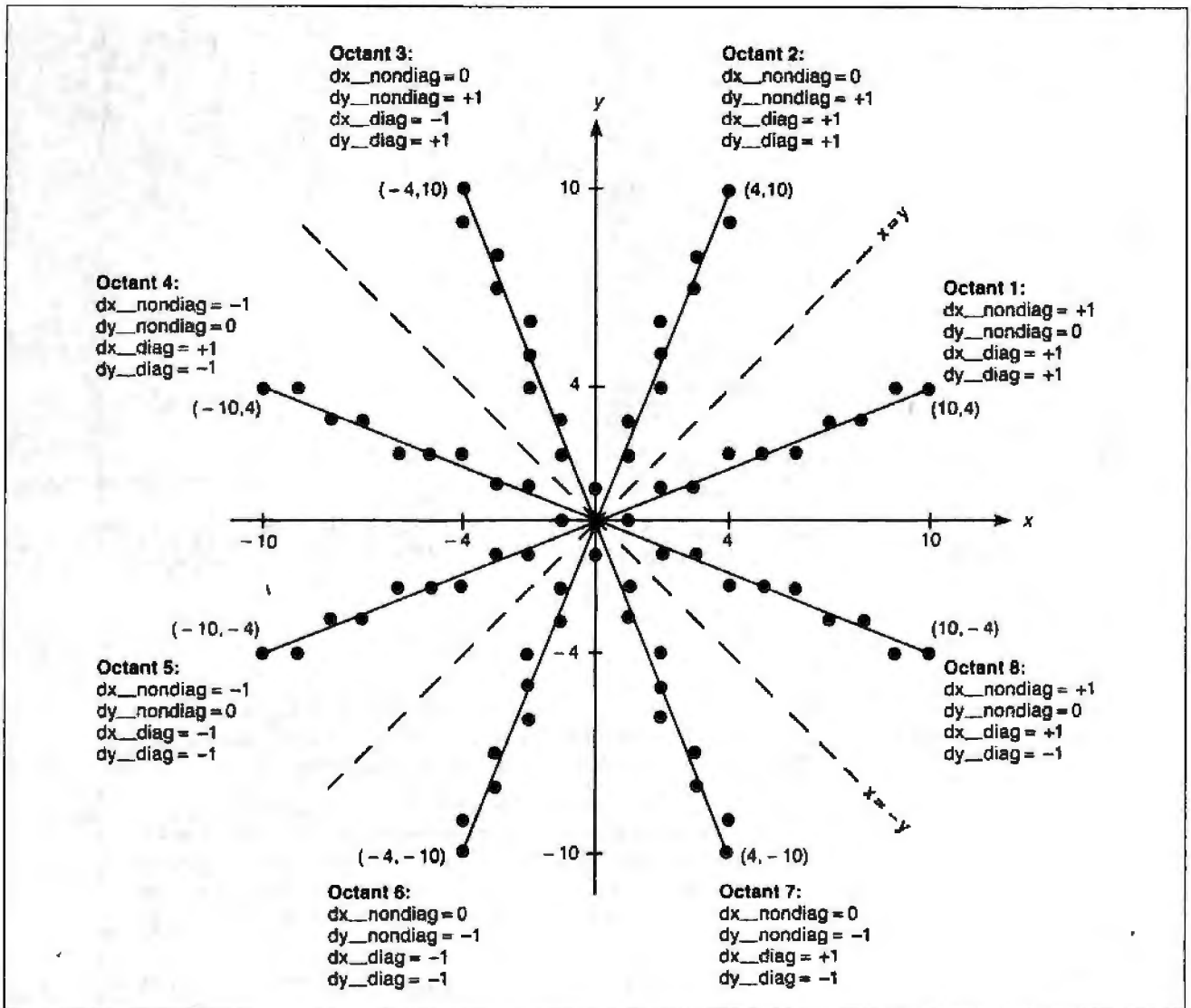

Figure 4: Eight-way symmetry used for the general algorithm.

algorithm uses the same values of a and b (for this example, $a = 10$, $b = 4$) for each of the lines. The only difference between drawing in one octant and another is the direction of diagonal and nondiagonal steps. The algorithm in listing 3 tests the endpoints to determine in which octant the line lies. After the target octant is determined, the x and y increments for diagonal and nondiagonal steps are adjusted to draw the line in the proper direction.

In listing 3, nondiagonal steps cause x and y to increment by $dx_nondiag$ and $dy_nondiag$; diagonal steps cause x and y to increment by dx_diag and dy_diag . Figure 4 shows the values of these increments in each of the eight octants.

The final step in achieving the general form of the algorithm in listing 3 is to allow the line to begin at points other than the origin. Whereas variables a and b represented the coordinates of the endpoint in listings 1 and 2, in listing 3 they represent the distances in x and y from the starting point to the ending point; a is set to the larger of these distances, and b to the smaller.

Described in geometric terms, when the algorithm initially assigns values to parameters a and b , it effectively translates the starting point of the line to the origin.

At this point in the algorithm, the ending point of the translated line is at (a, b) , and variables a and b contain information

regarding both the shape of the line and the octant of the translated ending point. In the three subsequent tests of the values of a and b (Is $a < 0$? Is $b < 0$? Is $a < b$?) the octant information is stripped away from a and b , leaving only the shape information. Meanwhile, all information regarding the octant of the ending point is transferred to the x and y increments dx_diag , dy_diag , $dx_nondiag$ and $dy_nondiag$. All this takes place prior to entering the `for` loop in listing 3.

Practical Implementations

In a real graphics system, you should encode the algorithm in listing 3 in assembly language to make it run as fast as possible. For instance, a typical CAD diagram might contain hundreds of lines, and the user waits while the computer draws the diagram on the screen. The programmer should put the most effort into speeding up the `for` loop, since this is executed once for each pixel drawn, and one line may contain hundreds of pixels.

By comparison, the code that precedes the `for` loop executes only once per line. The call to the `draw_pixel` procedure should be replaced by in-line code for the `draw_pixel` operation in order to remove the subroutine call overhead from the inner loop. ■



Actual unretouched screen image.



Actual unretouched screen image.

Screen stars with The Visible Edge.

What gives Princeton's new generation of screen stars the Visible Edge is a screen image of incomparable clarity and resolution. Where brilliant colors and infinite shades of gray, with striking contrast and dimension, are commonplace.

The versatility of the Princeton family of monitors gives the new generation (and present generation) of computers, the greatest autosynchronous horizontal/vertical scan range combination available (ULTRASYN and MAX-15). The clarity of .28mm dot pitch (ULTRASYN and PSC-28). 1024x750 display resolution (MAX-15). And the entire spectrum of color, with the ease and comfort that can only accompany an ergonomically designed monitor.

Experience a world of unlimited vision. And the technology that's made our high level of quality, service, value and performance, second nature. Experience the Visible Edge. And see what we do best. For more information call (609) 683-1660 x 100.

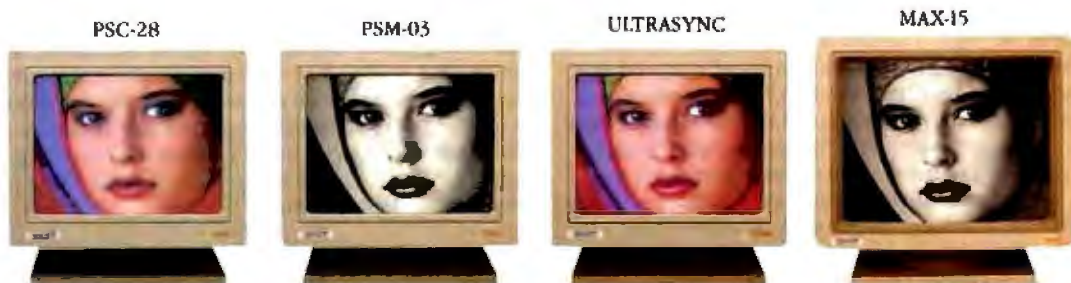

IBM PS/2 COMPATIBLE

IBM PC/XT/AT & PS/2 Macintosh II COMPATIBLE

PRINCETON
GRAPHIC SYSTEMS
THE VISIBLE EDGE

601 Ewing Street, Building A, Princeton, New Jersey 08540 (609) 683-1860

Circle 206 on Reader Service Card

NOW AVAILABLE FOR ULTRASYN:
AC-100 DATA CABLE FOR MAC II

Multicolumn Paged Text

Use this program to lay out text in columns and to explore desktop-publishing software technology



Until recently, multiple-column text was something you found on newspaper and magazine pages, but not on the output from computers. The two main output devices used by computers—the CRT monitor and the line printer—were physically designed to produce single columns of text.

Then, graphic displays and desktop publishing arrived, and the market is now flooded with programs that organize text into pages, using multiple columns, typefaces, and type sizes. Increasingly, personal computer word-processing software is beginning to offer multiple columns for printed output (e.g., Microsoft Word), on the screen, or for both (e.g., Word-Perfect).

The reason for wanting multiple columns is largely one of readability. The small point sizes used to cram more words into newspapers and magazines make for far too many words across a whole page width for comfortable reading. This would be particularly true in the case of broadside-size newspapers, where a line would hold more than 50 words; the human eye has a tendency to lose its horizontal tracking accuracy if asked to scan across too many words on a single line.

Breaking the text up into multiple columns ensures that each line contains a more readable number of words—typically, 6 to 12. Using multiple narrow columns also allows the layout designer greater flexibility in fitting several articles on the same page, particularly important in newspaper work. Books tend to employ larger point sizes and wide margins, yielding around 12 words across the page, and are rarely set in columns.

In the good old days of 9-pin dot-matrix printers with cobby typefaces, multiple-column output from a personal computer was neither necessary nor particularly desirable. A low-cost printer gets only about 13 words on an 80-column line anyway, and those are composed of fixed-width characters, possibly justified by crude insertion of full character spaces. Now that laser printers are common—and even dot-matrix printers can manage proportional spacing and near-letter-quality (NLQ) typefaces—columns start to make sense.

Apart from page layout and readability, another valuable use for multiple columns is the economical generation of lists. If you have to print 2000 short items, it is both wasteful and unsightly

to print them in a single spindly column on 32 sheets when they will fit in four columns on 8 sheets. It was precisely this application that prompted me to write a utility for arranging text into multiple columns. I use a text editor that lacks this facility, but I have no intention of learning a new editor just to get it.

Before writing such a utility, it's important to decide exactly what you hope to achieve. Multiple-column-text programming covers a broad spectrum of difficulties. At the most difficult end of the spectrum is the provision of multiple columns on the screen, interactively, with automatic reformatting, word wrap, and line wrap. This means that new text can be inserted at any point on any line, excess words will wrap over onto the next line, and excess lines will wrap up to the top of the next column.

This is the sort of facility the next generation of word processors will offer as a matter of course. To achieve it requires storing the text in a dynamic data structure, something like an array of circular lists of circular lists. This can make screen updating a strenuous chore, especially if you're using a bit-mapped graphic display. It is not something you can retrofit to a text editor like

continued

Figure 1: *The process of writing a two-dimensional array of characters up and down, then reading the same array across, yields the desired transformation to three-column text.*

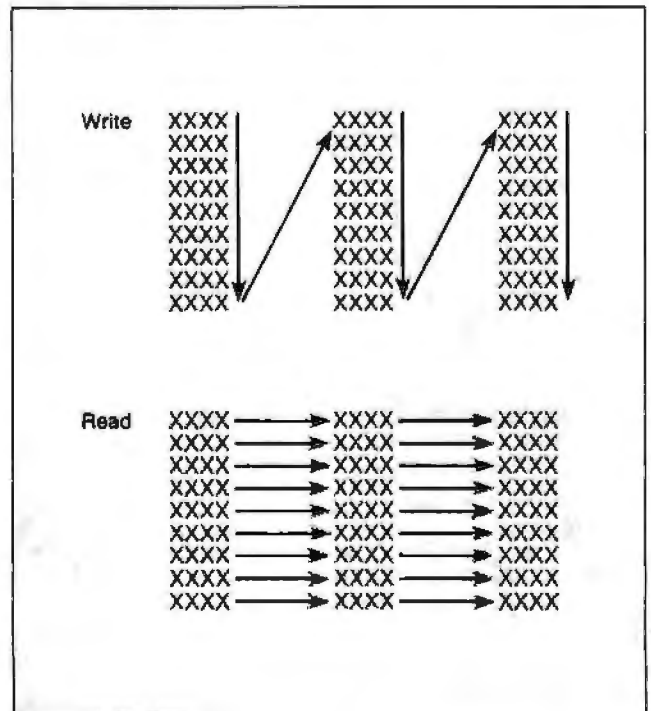

Dick Pountain is a technical author and software consultant living in London, England. He can be contacted c/o BYTE, One Phoenix Mill Lane, Peterborough, NH 03458, or on BIX as "dickp."

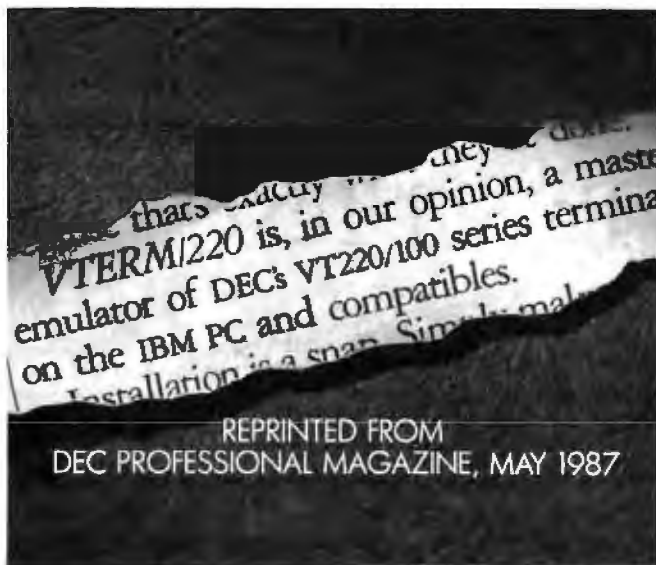

(WITH REVIEWS LIKE THESE, WHO NEEDS CLEVER HEADLINES?)

Find out why magazines like DEC Professional and PC Week and over 60,000 PC users appreciate the convenient yet powerful features of VTERM/220, VTERM III and VTERM/4010.

Send in this coupon to see for yourself the most functionally complete emulation of DEC VT220, VT100, VT52 or Tektronix 4010 terminals.

VTERM*

I would like to find out why magazines like DEC Professional, PC Week and others rate VTERM/220 so highly.

Please send me the DEC Professional and PC Week reviews.

Please send me information on your free 30-day evaluation of VTERM/220, VTERM III and VTERM/4010.

NAME _____ TITLE _____

COMPANY _____

ADDRESS _____

CITY _____ STATE _____ ZIP _____

PHONE NUMBER _____

Write: Coefficient Systems Corporation
611 Broadway, New York, N.Y. 10012

or call (212) 777-6707 ext 414

FAX: (212) 228-3137 TELEX: 6503156498

*VTERM refers to VTERM/220, VTERM III and VTERM/4010 from Coefficient Systems Corporation

mine, unless you have the source code and a lot of spare time on your hands.

At the opposite end of the difficulty spectrum we have a simple DOS utility that takes a plain ASCII text file and outputs another file with the text paged in a specified number of columns with a specified number of lines per page. This was my own coward's preference.

The root principle in implementing multiple-column output is delay. Both video display units and printers are physically capable of printing only single lines of text, ended by a carriage return. But if we are printing in, say, three columns, each physical output line will actually consist of three short logical lines from different places in the text.

The first two logical lines, therefore, need to be held back until the third one is reached before printing them all. If we regard output as a continuous data flow, we need a data structure that acts as a delay line, holding back logical text segments until the structure collects a full physical line.

However, in the case of my simple program, there is no need to regard output as a continuous data flow. Instead, you can think of output as a batch process, in which whole pages are collated and then output as units. In this case, we can build a data structure to act as a mold or template for the desired page; words "pour" into the mold until it is full, and then the "casting" is sent to the output file, complete with a page number.

Since this is a batch process whose dimensions are fixed from the start, a two-dimensional array of strings will be a perfectly good data structure to represent the page. This would not be a good choice if we were trying to implement interactive word wrap and line wrap, as we would have to move along many array

continued

Listing 1: Pseudocode for the word-wrap algorithm.

```

Program Pager
PageNumber <- 1
WHILE not at end of input text

    FOR Column FROM 1 TO ColumnsPerPage
        -- Fill the page template
        FOR Line FROM 1 TO PageLength
            IF not at end of input text
                THEN read a line from input ->
                    Page[Column, Line]
            ELSE fill with blanks -> Page[Column,
                Line]
        ENDIF
    ENDFOR
ENDFOR

PhysicalLine <- empty string
-- Write physical lines to output
file
FOR Line FROM 1 TO PageLength
    FOR Column FROM 1 TO ColumnsPerPage
        APPEND Page[Column, Line] TO
        PhysicalLine
    ENDFOR
    APPEND (enough blanks to pad out to
        column width) TO PhysicalLine
    WRITE PhysicalLine -> output file
    WRITE Carriage Return -> output file
ENDFOR
WRITE PageNumber -> output file
PageNumber <- PageNumber + 1
ENDWHILE
    
```

Now from NRI comes the first course of its kind . . . anywhere!

Learn to use, program, and service today's digital electronic music equipment as you build your own computer-controlled music center



Now NRI puts you at the heart of the most exciting application of digital technology to date! With NRI's new at-home training in Electronic Music Technology, you get hands-on experience with the equipment that's revolutionizing the music industry—Atari ST Series computer with built-in MIDI ports, Casio CZ101 digital synthesizer with advanced MIDI capabilities, and ingenious MIDI software that links computer keyboard to synthesizer keyboard—all yours to train with and keep.

This year, over \$1.5 billion worth of digital electronic music instruments—keyboards, guitars, drum machines, and related equipment—will be sold in the U.S. alone. Who's buying this new-tech equipment? Not just progressive musicians and professional recording technicians, but also thousands of people who have never touched a musical instrument before. And there's good reason why.

Something called MIDI (Musical Instrument Digital Interface) has suddenly transformed musical instruments into the ultimate computer peripherals . . . and opened up a whole new world of opportunity for the person who knows how to use, program, and service this extraordinary new digital equipment.

Now NRI's breakthrough Electronic Music Technology course puts you at the forefront of this booming new technology with exclusive hands-on training built around a MIDI-equipped computer, MIDI synthesizer, and MIDI software you keep.

Dynamic New Technology Opens Up New Career Opportunities for You

The opportunities are unlimited for the person who's trained to take advantage of today's electronic music phenomenon. Now you can prepare for a high-paying career as a studio technician,

sound engineer, recording engineer, or road technician . . . even start your own new-age business providing one-stop sales and service for musicians, technicians, and general consumers alike. Or simply unleash your own musical creativity with the breakthrough training and equipment only NRI gives you.

Only NRI Gives You an Atari ST Computer, Casio Synthesizer, and Innovative MIDI Software You Train With and Keep

The Atari ST Series computer included in your course becomes the heart of your own computer-controlled music center. With its tremendous power, superior graphics capabilities, and built-in MIDI interface, the 16/32-bit Atari ST has almost overnight become the computer of choice for today's most knowledgeable electronic musicians.

The Casio CZ101 digital synthesizer, also included in your training, is the perfect complement to your Atari ST. The polyphonic, multitimbral CZ101—which stores up to 32 voices internally—"communicates" with your ST computer through MIDI, bringing life to virtually any sound you can imagine.

Plus, you get ingeniously designed MIDI software that opens up amazing new creative and technical possibilities . . . you actually build your own 4-input audio mixer/amplifier . . . and you test the electronic circuits at the core of today's new-tech equipment with the hand-held digital multi-meter included in your course.

No previous experience necessary—in electronics or music!

No matter what your background, NRI gives you the skills you need

to take advantage of today's opportunities in electronic music technology.

With your experienced NRI instructor always available to help, you master the basics of electronic theory step by step, gaining the full understanding of electronics that's now so essential for technicians and musicians alike. You move on to analyze sound generation techniques, digital logic, microprocessor fundamentals, and sampling and recording techniques . . . ultimately getting first-hand experience with today's explosive new technology as you explore MIDI, waveshaping, patching, sequencing, mixing, special effects, and much more.

Plus, even if you've never been involved with music before, NRI gives you enough basic training in music theory and musical notation to appreciate the creative potential and far-reaching applications of today's electronic music equipment.

Send Today for Your FREE Catalog

For all the details about NRI's innovative new training, send the coupon today. You'll receive a complete catalog describing NRI's Electronic Music Technology course plus NRI courses in other high-tech, in-demand electronics fields.

If the coupon is missing, write to NRI School of Electronics, McGraw-Hill Continuing Education Center, 3939 Wisconsin Avenue, Washington, DC 20016.

NRI School of Electronics
McGraw-Hill Continuing Education Center
3939 Wisconsin Avenue
Washington, DC 20016



CHECK ONE FREE CATALOG ONLY

Electronic Music Technology Computers and Microprocessors
 TV/Video/Audio Servicing Basic Electronics

Name _____ / Please Print _____ Age _____

Street _____

City _____ State _____ Zip _____

NRI is accredited by the Accrediting Commission of the National Home Study Council #171-034

Implementing this algorithm is quite straightforward in an interpreted language like BASICA because such languages allow the dimensioning of arrays at run time.

elements every time a new word was inserted.

A crude outline algorithm for the paging process is this: First, fill the template with words from the input by writing up and down the columns; second, write an output file by reading the template across all the columns at once.

For three columns, we could represent the process in a diagram like the one found in figure 1. We achieve the required transformation by looking at the same data structure from two different viewpoints.

We need to refine one aspect of the problem before we can proceed. I have talked lightly of words "pouring" into an array, but we actually have more to consider here. If we have prepared the input text with a text editor, it will already be formatted into lines of some length, according to the margin settings of the text editor.

When we page the text into multiple columns, they will be much narrower than the typical margins for a single-column document. Hence, the routine that fills the array needs to word-wrap the input text to this narrower column width. If we are

talking about a sophisticated paging utility, it should also be able to justify the wrapped text and intelligently hyphenate it. But this means that the Fill routine needs to incorporate much of the capability of a good text editor.

It seemed silly to me to reinvent the wheel, when I already had a tool (my text editor) to hand that could handle these formatting chores superbly. The paging program I wrote therefore takes text files that have already been formatted to the correct column width using the text editor. At the same time as you reduce the margins, you can justify the text, if required, and arrange features like column headings to fit properly into the paged format, using all the facilities of the text editor.

The only inconvenience lies in having to write an extra intermediate file of this "galley" text, formatted to column width. But even on my slow computer, this takes only seconds. On the other hand, the construction of the paging utility itself is greatly simplified (it needs to know only how to wrap columns), and consequently the program goes very fast.

The algorithm can now be presented more formally in pseudocode (see listing 1). Implementing this algorithm is quite straightforward in an interpreted language like BASICA because such languages allow the dimensioning of arrays at run time. The program can decide on the dimensions of the Page array after it has asked the user for the number of columns and lines per page required.

Compiled languages like Pascal, C, or compiled BASIC impose a slight complication in that arrays can be dimensioned only at the time the program is compiled; obviously, it is unacceptable to have a different version of the program for every conceivable page layout. Fortunately, some calculation shows

continued

ADVANCING HARD DISK STORAGE



PERSTOR
PERSTOR SYSTEMS INC.

Perstor Systems, Inc., 7631 E. Greenway, Scottsdale, AZ 85260 (602) 991-5451

While other RLL controllers require drives approved for RLL encoding, the PERSTOR 200 Series Controllers allow you to upgrade current hard disk systems or create new systems with standard MFM drives or RLL approved drives.

Our competitors offer only a 50% increase in capacity with their controllers, while we have advanced the RLL standard to allow for a 90% or 100% increase in capacity.

If performance is the issue, the Perstor controllers are the answer, delivering up to a 110% increase in your data transfer performance.

FEATURES:

- **ADVANCED CAPACITY** 90% or 100% increase in capacity.
- **ADVANCED PERFORMANCE** As much as a 110% increase in performance in your PC, XT, AT, or compatible.
- **ADVANCED COMPATIBILITY** Compatible with either MFM or RLL approved drives* with oxide or plated media. *(Miniscribe, Seagate, Maxtor, Newbury, CDC, and more.)
- **ADVANCED VERSATILITY** Compatible with most PC, XT, AT, or 386 based systems in a single design.

All of this means you can upgrade current systems or design new systems with higher capacity, performance, and quality.

*CDC is a trademark of Control Data Corporation. Maxtor is a trademark of Maxtor Corporation. Miniscribe is a trademark of Miniscribe Corporation. Newbury is a trademark of Newbury Data, Inc. Seagate is a trademark of Seagate Technology.

SmarTEAM™

Offers A Choice



World Wide Agents:

U. S. A.
PDM
(713) 488-8830
MicroAge
(206) 746-8045

CANADA
BUDGETRON INC.
(416) 673-7800

NORWAY
PROFESSIONAL
SYSTEM A/S
(02) 253350

BENELUX
COMPUTATA BV
(0) 73-422045

ITALY
DATATEC
(06) 8321-213

W. C.
RVS
(089) 35-10-071

FINLAND
MIKROMERIOY
(90) 550-155

ICELAND
TAEKNIVAL
(1) 68 16 65

SWEDEN
PROFESSIONAL
SYSTEMS A/S
(08) 7 33 00 95

H.K.
ONFLO
(3) 7224195

SINGAPORE
PET
292-9155

SAUDIARABI
AL-JASSIM
(3) 832-2148

PHILLIPINE
RANK
(2) 40-2391

SmarTEAM The Smart Choice

SmarTEAM 2400

- * Bell 103/212A, CCITT V.22/22 bis
- * Auto dial, auto answer, auto speed selection
- * ASYN/SYN operation
- * Fully compatible with Hayes.

SmarTEAM 2400 MNP

- * Sophisticated error checking and error correcting
- * Provided MNP mode and NON-MNP mode.
- * Compatible with Hayes AT command.
- * ASYN/SYN operation.

SmarTEAM 9600 PLUS

- * Utilizes the latest MNP class 6 to give error free data transfer.
- * Cheaper telephone bills with the MNP data compression provides throughput of up to 19200 bps with 9600 bps link.
- * Battery-backed CMOS RAM preserves configuration against power failures for up to 30 days.
- * Communicates with any MNP or NON-MNP modem which supporting Bell 103/212A, CCITT V.22/22bis/V.27/V.29 modulation standards.

MNP is trade mark of MICROCOM Inc. HAYES is trade mark of Hayes Microcomputer Product, Inc.



TEAM TECHNOLOGY INC.

40 Fl., No. 270, Nanking E. Rd.,
Sec. 3, Taipei, Taiwan, R.O.C.
Tel: (02)741-4270 (5 Lines)
Fax: 886-2-7712985
Telex: 19725 TEAMTECH

SmarTeam

U.S.A. SALES AND SERVICE CENTER SmarTEAM INC.

19205 Parthenia St., Suite #J, Northridge, Ca. 91324
Tel: (818)886-9726 Service No: (818)886-9729
Fax: (818)886-6731

Circle 261 on Reader Service Card

Adding Diagrams

It's easy to adapt the multicolumn-paged-text algorithm to run text around diagrams. You can define a "window" area—a space to be left blank for the later addition of a diagram—by the column and line numbers of its top left and bottom right corners. If we call these window coordinates $X1, Y1$ and $X2, Y2$, for $X1=1, Y1=4$ and $X2=2, Y2=7$, we have the window area shown in figure A.

To modify the program to produce window areas, we need to change the test on line 6 of procedure `ReadInPage` in listing 2 so that it checks whether the line currently under consideration falls outside the window. If so, the program reads input into that line; otherwise, the program should pad the line with blanks (in the same way that lines are padded on the last page, after the program reads end of file):

```
if not eof(InputFile)
  and not ((Column in [X1..X2]) and
    (Line in [Y1..Y2]))
```

The only other change to the program text required is some way of reading in $X1, Y1, X2$, and $Y2$. For the purpose of experiment, you can add them as four extra command-line parameters to be read in by `GetPageParams`.

This crude mechanism will of course make a window in the same place on every page, which is seldom what we want. However, it is no more difficult conceptually, and takes only a little more programming effort, to have a different window on every page. You need to store the window coordinates for each page in an array `Window[]`, which is indexed by `PageNumber` and the four coordinate types. For pages with no window, set all coordinates to 0. The extra declarations needed are

```
type WindowCoord = (Left,Right,Top,Bottom);
var Window: array [1..MaxPages, WindowCoord] of
  integer;
  X1,X2,Y1,Y2: integer;
```

The format for a document now consists of a sequence of records of the following form:

<pagenumber>, <X1>, <Y1>, <X2>, <Y2>

This information is kept in a separate ASCII file that gets read into the `Window` array when the program starts.

The next logical refinement is to include the contents of another file to fill the window so created. These files can contain

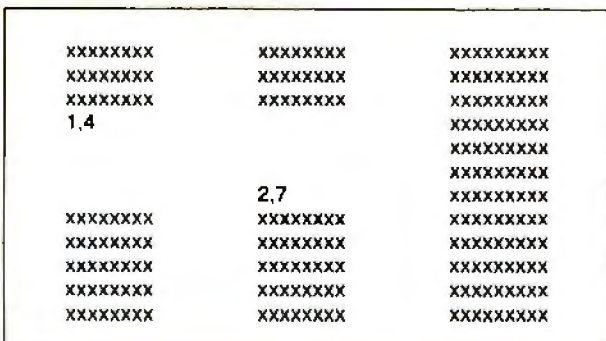

Figure A: Defining a window area for multicolumn text.

diagrams, bar charts, and tables drawn using block graphics characters. Bit-mapped graphics present enormous problems, but the truly dedicated (or crazy) could achieve even this on Epson-style printers using bit-image mode.

The principle is quite simple. Rather than filling the window area with blank lines, the program fills the area with slices from the diagram file. A function called `DiagramSlice` reads lines from the included diagram file and adjusts them to the proper length. The procedure `ReadInPage` now looks like this:

```
procedure ReadInPage;
var Column,Line: Integer;
begin
  X1 := Window[PageNumber,Left];
  Y1 := Window[PageNumber,Top];
  X2 := Window[PageNumber,Right];
  Y2 := Window[PageNumber,Bottom];
  for Column := 1 to ColsPerPage do
    for Line := 1 to LinesPerPage do
      if not Eof(InputFile)
        and not ((Column in [X1..X2])
          and (Line in [Y1..Y2]))
        then readln(InputFile,Page[Column,Line])
        else Page[Column,Line] := DiagramSlice;
    end;
```

Now the format of a document has an extra element: the name of a diagram file. The record structure is <pagenumber>, <X1>, <Y1>, <X2>, <Y2>, <diagramfile name>. Alternatively, you might now prefer to put the X, Y coordinates into the diagram file itself.

I've shown a simple version of `DiagramSlice` in listing A. I've left the gruesome details of reading in the format from a file and opening the appropriate diagram files to you. All of a sudden, `PageMaker` and `Ventura Publisher` start to look quite cheap at the price, don't they?

Listing A: A simple version of the function to read lines from the diagram file and adjust them to the proper length.

```
function DiagramSlice: Stringtype;
var TempSlice: Stringtype;
  WindowWidth: integer;
begin
  if Eof(IoputFile)
  then DiagramSlice := Blankline
  else
    begin
      WindowWidth := CharsPerline*(X2-X1+1);
      readln(DiagramFile,TempSlice);

      (Crop if long...pad if short)
      TempSlice := Copy(TempSlice,1,WindowWidth)
        + Space(WindowWidth-
          length(TempSlice));
      if Column = X1
      then DiagramSlice := TempSlice
      else DiagramSlice := ' '
    end
  end
```

Listing 2: The column-wrap program in Turbo Pascal code.

```

program Page;

const
  MaxColsPerPage = 6;
  MaxPageLength = 60;
  MaxCharsPerLine = 40;
  PageWidth = 80;
  Blanks = ' ';

type
  Linetype =
    string[MaxCharsPerLine];

var
  Page:
    array[1..MaxColsPerPage,1..Max
      PageLength] of Linetype;
  BlankLine: Linetype;
  ColsPerPage, PageLength,
  PageNumber, CharsPerLine:
    integer;

  InputFile, OutputFile: text;
  InputFileName, OutputFileName:
    string[127];

Procedure InitFiles;
begin
  if paramCount = 0
  then begin write('Must specify an input
    file');
    halt
  end;
  InputFileName := paramStr(1);
  if (pos('.',paramStr(1)) <> 0) or
    (pos('.',paramStr(1)) <> 0)
  then begin
    writeln('Mustn't PAGE a PAGED
      file!!');
    halt
  end;
  if pos('.',paramStr(1)) = 0
  then OutputFileName := paramStr(1)+'.pag'
  else OutputFileName :=
    copy(paramStr(1),1,pos('.',par
      amStr(1))+'.pag';
  Assign(OutputFile, OutputFileName);
  Assign(InputFile, InputFileName);
  Reset(InputFile);
  if ioresult <> 0
  then begin
    writeln('File ',InputFileName,'
      not found');
    halt
  end;
  Rewrite(OutputFile);
  if ioresult <> 0
  then begin
    writeln('Error opening output
      file: is disk full?');
    halt
  end
end ;

procedure GetPageParms;
var error: integer;
begin
  val(paramStr(2),ColsPerPage,error);
  if (error <> 0) or (ColsPerPage >
    MaxColsPerPage)
  then begin
    write('Bad column parameter');

```

```

    halt
  end;
  val(paramStr(3),PageLength,error);
  if (error <> 0) or (PageLength >
    MaxPageLength)
  then begin
    write('Bad line parameter');
    halt
  end;
end;

procedure ReadInPage;
var Column, Line: Integer;
begin
  for Column := 1 to ColsPerPage do
    for Line := 1 to PageLength do
      if not eof(InputFile)
      then
        readln(InputFile,Page[Column,
          Line])
        else Page[Column,Line] := BlankLine
    end;

function Spaces(Num:integer):Linetype;
begin
  Spaces := Copy(Blanks,1,Num)
end;

procedure WriteOutPage;
var Column, Line: integer;
begin
  for Line := 1 to PageLength do
    begin
      for Column := 1 to ColsPerPage do
        write(OutputFile,
          Page[Column,Line+
            Spaces(CharsPerLine-
              Length(Page[Column,
                Line])));
        writeln(OutputFile)
      end;
      writeln(Outputfile,
        Spaces(38)+'<',PageNumber,'>')
    end;
end;

begin
  Initfiles;
  GetPageParms;
  PageNumber := 1;
  CharsPerLine := PageWidth div
    ColsPerPage;
  BlankLine := Spaces(CharsPerLine);
  while not eof(InputFile) do
    begin
      ReadInPage;
      write('.');
      WriteOutPage;
      PageNumber := PageNumber + 1;
    end;
  Close(InputFile);
  Close(OutputFile)
end.

```

Listing 3: A version of the GetLine procedure; not very smart, this version wraps only whole words.

```

const   CR = #13;
        LF = #10;

var LineBuffer: Linetype;

procedure GetLine(VAR Infile: text;
                  LineLength: integer;
                  VAR NextLine: Linetype);

var NextWord: Linetype;
    Full: boolean;

    procedure GetNextWord;
    var Chr: char;
    begin
        NextWord := '';
        while (Chr <> ' ') and not
            eof(Inputfile) do
            begin
                read(Infile,Chr);
                if Chr <> LF
                then begin
                    if Chr = CR then Chr := ' ';
                    NextWord := NextWord + Chr
                end
            end
        end
    end;
end;

```

```

begin
    Full := false;
    while not Full and not eof(Infile) do
        begin
            GetNextWord;
            if NextWord <> ' '
            then if Length(NextWord)+Length(Line
                Buffer) > LineLength
                then Full := true
                else begin
                    LineBuffer := LineBuffer
                        + NextWord;
                    Full := false
                end
            end;
            NextLine := LineBuffer;      { Flush
                out result)
            LineBuffer := NextWord;      { Save
                leftover word for next time)
        end;
    end;
end;

```

that the size of the problem is such that a fudge is possible.

My printer (as is the case with most printers) uses A4 paper, which holds 60 lines of text with 80 characters per line. The largest number of columns I would ever want on such paper is six. The smallest number of columns I would ever want is two (otherwise, why use the program at all?), and two columns on my paper means at most a 40-character column width.

Six columns of 60 lines with 40 characters comes to around 15K bytes of storage. An array of this size will hold the most columns I will ever need, at the most characters per line I could ever need, and it's well within the memory limits of even modest computers. So to hell with elegance, let's waste bytes. We declare an array of this size and use as many columns and lines of it as are needed.

The program's source code in Turbo Pascal 3.0 is shown in listing 2. In this simple version, the name of the input file, the number of columns, and the number of lines per page must be given on the command line from which the program is invoked. For space reasons, I've kept the error checking quite rudimentary. A sample command line could be

```
C: >page byte40.doc 3 60
```

Before you can use this line, though, you'll need to format byte40.doc to a right margin of 26 (80/3), and justify it if desired, using your regular text editor. The program automatically renames the output file, in this case to byte40.pag.

In the version of the program I use in real life, I've added a system of template files, like a very poor man's Ventura Publisher. A template file specifies a page style, including the number of columns, page length, left- and right-page margins, header text, and rules. I keep a separate template file for each format I use regularly, and the template filename is given as the second parameter to Page in place of the numeric parameters used here.

To make Page into a stand-alone program (i.e., one that can accept an input file in any format and perform its own word wrapping), it's necessary only to write one new procedure—let's call it GetLine—and substitute a call to it for the statement

```
Readln(InputFile,Page[Column,Line])
```

at line 7 of ReadInPage.

The snag, as I've already suggested, is that GetLine will need to be quite a large procedure if you want it to be as smart as your average text editor; for example, doing intelligent hyphenation is in itself a suitable subject for several articles. To get you started, listing 3 contains a very slow, dumb version of GetLine, which can wrap only whole words. You could improve the speed by buffering more text in memory rather than reading single characters, as I have done here. The call in ReadInPage now takes the form

```
GetLine(InputFile,CharsPerLine,Page[Column,Line])
```

When you get as far as writing a GetLine procedure that word-wraps, hyphenates, and can perform justification with proportionally spaced fonts, you are well on your way to having a real desktop-publishing program. The next logical step is to deal with running columns around holes for pictures.

Batch methods of page layout like the one I have described here are far from ideal in applications where text runs around complex picture layouts. In such cases, it's more appropriate to use an interactive or WYSIWYG (what you see is what you get) design program that shows you the layout on the screen so that you can position the pictures. However, the program can be adapted, as described in the text box "Adding Diagrams" on page 260, to serve in the simple case of one diagram per page, where the diagrams are character-based (e.g., using IBM block graphics characters). ■



Unretouched Photo

Buy The One On The Left And You'll Have To Put It Where The Sun Don't Shine.



The monitor on the right, however, can be placed anywhere you like. Even in direct sunlight. It's the new *Flat Technology Monitor* from Zenith Data Systems—winner of *PC Magazine's* coveted "Technical Excellence Award" in the hardware category for 1987.

You Have To See Zenith To Believe It

So clear. So precise. So lifelike. It's the only monitor with a completely flat screen. A breakthrough that has redefined monitor quality forever. Industry experts are already convinced. And once you see it in person, you'll be a believer, too.

Bigger, Brighter, Glare-Free

Our Flat Technology Monitor has an impressive 14-inch display. And even though it's bigger, it's 50% brighter than conventional CRT's and it has 70% greater contrast. So you get colors with greater depth and definition that make your reports, charts and graphs come alive like never before.

The Flat Technology Monitor is virtually glare-free. So you can work longer without the usual headaches

and eyestrain. And that means greater productivity. But to get the whole picture, you have to see it with your own eyes.

Backward And Forward Compatibility

You also get full compatibility with the high resolution VGA Video generated by IBM's new PS/2* computers. And with Zenith's Z-449 or other VGA-class video cards, you can enjoy CGA, MDA, Hercules and EGA graphics as well.

Experience Zenith's Latest Technology Breakthrough

Obviously, a mere picture can't do justice to our new Flat Technology Monitor. It demands a face-to-face evaluation. For a hands-on demonstration, call today for the name of your nearest authorized Zenith Data Systems dealer—the Flat Technology Monitor is available in quantities right now.

1-800-553-0305



**data
systems**

THE QUALITY GOES IN BEFORE THE NAME GOES ON*



FREE!

Electronics...The Magazine That Gives You Technology With Perspective.

There's simply no other magazine like Electronics! It brings to your desk the comprehensive coverage and perspective you need, no matter what your job or responsibilities are. Electronics provides you with technical information on computers, data processors, peripheral equipment, office and business machines, communications equipment and semiconductors. Information that keeps you abreast of industry breakthroughs, trends and business directions. It gives you the savvy needed to compete.

Each issue focuses in on the meaningful technological developments and concerns driving the electronics industry.

Why Is Electronics Free to Professionals Like You?

By controlling circulation, we make our readership fit our editorial. Editorial for important people, like you, who need the important information only Electronics provides.

And it's yours, FREE...if you qualify. Simply fill out and return the adjacent card. If you qualify, we'll start your subscription with the very next issue of Electronics.



Electronics

It's All in the Symbols

Numbers aren't everything; in fact, the "things" that they can represent might be in the minority.

We've always had symbols as names; now we're investigating symbols as numbers. We tend to relate what we hear to what we already know. Numbers are what we already know, so we tend to think of symbols as numbers, or as representing numbers; but symbols aren't numbers. And symbolic processing is *not* just another way of saying numeric processing.

Symbols are not truly symbols when they are used as variable names. Conventional programming languages use the term *symbol* to mean the name of a program variable. Lisp has variables named by symbols, but they aren't the same as the symbols we are discussing.

What makes symbolic processing symbolic is that the values a variable is allowed to assume now include other symbols as well as the traditional numbers. For example,

```
(setf a 1)      ; assignment of a number value
(setf b 'a)    ; assignment of a symbol value
a => 1         ; value of a is the number 1
b => a        ; value of b is the symbol a
```

One common misconception is that symbolic processing is artificial intelligence. While AI would probably be impossible without it, symbolic processing is also useful for things unrelated to AI. Another misconception is that you use symbolic processing so you don't have to explicitly declare the types of your numbers. If you need type checking for your numbers, you might want to use Lisp, but you don't necessarily need symbolic processing.

A third misconception is that symbolic processing means you do garbage collection. Not true; garbage collection can benefit any language—numeric or symbolic—that allows you to allocate run-time data. Its usefulness is not restricted to symbolic processing.

Now you know what symbolic processing is *not*, but what *is* it? In reality, symbolic processing means processing nonnumeric "things" that we can't reasonably represent as numbers. Thus, we represent these things as symbols. Symbolic processing is the natural complement of numeric processing. First, however, we must accept that there is something other than numbers.

With COBOL, FORTRAN, Pascal, C, and so on, we've been quietly indoctrinated to believe that data is numbers. While there's nothing wrong with that premise in context—that is,

within the limits of procedural languages—the power of computing extends a lot further. This article describes how symbols differ from numbers, why we can't use numbers where we need symbols, and how the things we need symbols for are unique and valuable.

What Is Numeric Processing?

Venerable FORTRAN II supported only numeric data types. FORTRAN IV added logical data types. COBOL added more numeric types, such as packed decimal and an almost nonnumeric data type, characters. Characters were invented to record nonnumeric things, but we all *knew* that they were really small integers that always fit into 8 bits.

Since FORTRAN, most language designers have accepted the implied dictum: Data is numbers. And yet, the question "Are numbers enough?" always existed. As a partial response, Pascal's designers included sets, and C's developers recently added enumeration types.

But these two concessions to nonnumeric processing still have conveniently numeric internal representations. A set is really a one-dimensional array of 1-bit integers, while an enumeration resembles the assembly language practice of equating names to successive integers.

Numeric processing is a definite success story. The problem lies in our assumption that since it has been used for everything we've thought of so far, it should be used for everything we *can* think of.

It's All in the Data Types

If, as an experienced programmer, you are given a choice of any implementation language you wish to use for an application, your choice would probably be fairly predictable. For vector number-crunching applications, you would probably use FORTRAN; for business data processing, COBOL; for text pattern matching, SNOBOL; for systems programming, C; and so on. These choices have nothing to do with which language is best; they are purely pragmatic. Each particular language offers the data types and data structures needed to clearly and concisely describe a specific type of problem, plus the library functions to manipulate those structures.

For example, let's suppose you need to read a text file and produce a sorted list of words, the number of times each word occurs, their average length, and so on. How would you implement this program in FORTRAN 66, which has neither a character data type nor a string data structure?

Nothing's impossible. You could use FORTRAN's A1 format to read characters into an array. You could mimic string

continued

Merrill Cornish is a member of the group technical staff at Texas Instruments (P. O. Box 2909, Mail Station 2201, Austin, TX 78769-2909) and is working on Lisp system software.

storage by maintaining pairs of start/end indexes into that array, one pair per string. You could make the dimensions of the various fixed-size arrays larger than you'll ever need. You could write FORTRAN functions to access these pseudostrings, compare them for equality, order them, print them, and so on. You could make it work, but would you want to? You would have already written a significant amount of FORTRAN code before you even considered the original application.

However, there is a better solution. Consider the relative ease with which you could implement this application in C. C already understands that characters are characters and not stunted integers. C already knows how to store characters in strings. The standard C libraries already contain the necessary character-manipulation functions, such as `strlen`, `strcmp`, `strcpy`, and so on.

In short, C has the data types and data structures to support the application, and FORTRAN 66 doesn't. With C, you start programming the application immediately. With FORTRAN, you start by creating a virtual language within which you can then implement the application. When you do finally get to coding the application itself, the in-line FORTRAN housekeeping needed to make arrays of integers look like strings of characters constantly intrudes on the logic of the application. FORTRAN doesn't provide the *abstraction* we need for this problem; C does.

Symbol Data Types

In high-school English, many of us had to diagram sentences by breaking them into clauses, phrases, subjects, verbs, and so on. What if you had to implement such an analysis in a program? Remember, we aren't talking about understanding; we don't

care what the sentences *mean*—we just want to classify the words in them.

While C has excellent string-handling capabilities, this is not a string problem; it's a symbol problem. C's string-handling facility is mainly interested in the physical aspects of string representation. Given the words *is*, *was*, and *were*, C's `strlen` function could tell you that they are 2, 3, and 4 characters long, respectively. But we need to know that they are all verbs, not nouns, adjectives, or adverbs; that *is* and *was* are singular while *were* is plural; and that *is* is present tense while *was* and *were* are past tense. Also, given the words *are* and *ARE*, C's `strcmp` function would tell you that they are different, although they are the same word.

C is doing what it is supposed to do. C is interested in the characters in a string, but we are interested in the *word* represented by the string and in its grammatical properties. C sees the word as a collection of individual characters and is unaware of any higher meaning to that collection. In other words, this time C doesn't provide the particular abstraction that we need.

Why Strings Won't Do

So far, we've seen how a true symbol data type would simplify our implementation. But, even if a string-based implementation isn't our first choice, shouldn't it still be an acceptable second choice?

The real question is: How acceptable is the extra code you have to write to get C to see the big picture and stop dealing with words as bags of characters?

For example, C programmers sometimes use strings as symbolic mnemonics, such as the string argument `r` telling `fopen` to open a file for reading. It's not always appropriate, however, to try to distinguish symbols by their printed representation. Consider the sentence: "BILL PAID HIS REPAIR BILL." Is the first BILL equal to the second BILL? C's `strcmp` function would think so.

Once your analysis determines that the subject is BILL and the object is BILL, then a C program would claim the sentence's subject and object are the same. But they aren't. The subject is a man, and the object is a piece of paper. The fact that this particular subject and object happen to have the same printed representation is merely coincidence.

The notion of symbolic data types introduces distinctions that never seemed important with numeric data types. For example, the Lisp predicate `eq` compares two symbols to see if they represent the same object, the same piece of memory. Therefore, `(eq subject object)` would return false since BILL, the subject string, is physically a different data structure from BILL, the object string. They are two different objects that just happen to be represented by the same characters.

The Lisp predicate `equal` compares the contents of two objects rather than the objects themselves. As a rule, if two objects print the same, `equal` will say they are the same. So in Lisp,

```
(eq subject object) => false
(eq subject subject) => true
(equal subject object) => true
```

The point is that when you deal with symbolic data types, you need more than the plain bit-pattern comparisons that number crunchers use.

The Power in Abstraction

Programmers have a vested interest in abstraction. Alan Turing showed us that even a very rudimentary machine can compute almost anything imaginable. But the process of programming a Turing Machine is tedious (see "The Turing Machine" by Isaac Malitz in the November 1987 BYTE). Abstraction is one of the



Finally! A Keyboard Protector That:

- **PROTECTS CONTINUOUSLY - 24 HOURS A DAY** - Against computer downtime due to liquid spills, dust, ashes, staples, paper clips and other environmental hazards.
- **REMAINS IN PLACE** during the operation of your keyboard. SafeSkin is precision molded to fit each key - like a "second skin."
- **EXCELLENT FEEL** - The unique design eliminates any interference between adjacent keys, allowing smooth natural operation of your keyboard.
- **SafeSkin IS VIRTUALLY TRANSPARENT** - Keytops and side markings are clearly visible. In fact, SafeSkin is so clear, sometimes you may not know it's there!
- **DURABLE - LONG LASTING** - SafeSkin is not a "throw-away" item. Many of our protectors have lasted over 3 years under continuous daily use, without failure.

SafeSkin is available for most popular PC's and portables including: IBM, APPLE, AT&T, COMPAQ, DEC, EPSON, KEYTRONICS, NEC, TANDY, TOSHIBA, WANG, WYSE, ZENITH. Specify computer make and model. Send \$29.95. Check or M.O., VISA & MC include exp. date. Dealer inquiries invited. Free brochure available.

Merritt Computer Products, Inc.

4561 S. Westmoreland / Dallas, Texas 75237 / 214/339-0753

things that makes programming bearable.

At the binary level, underneath the abstraction, the code breaks down to all ones and zeros. But the point of a programming language is to provide an abstraction that suppresses the things we don't care about while leaving the features we consider important out in the open and available. Furthermore, as we go from one application to another, our notion of what's important can shift radically.

FORTRAN provided us with at least three major abstractions that have appeared in virtually all languages since: DO loops, floating-point numbers, and I/O statements. While there are many ways of writing a loop, FORTRAN programmers are more interested in what's inside the DO loop than in the mechanics of indexing; so FORTRAN included a DO loop abstraction. Floating-point representations are a whole field of study, but FORTRAN programmers needed to use floating-point numbers, not study them; so FORTRAN included a floating-point abstraction.

And everyone needs to do I/O, but few want to write yet another ASCII-to-integer conversion. So FORTRAN included a FORMAT statement. (You might well argue that a FORTRAN FORMAT statement is *not* the best of all possible worlds, but that's not the point. Even FORMAT's arcane syntax still lets you think more in terms of what you want printed than how to output each character.)

Despite FORTRAN's successes, its array abstraction doesn't do too well on the word-counting application. The meaning of any number in a FORTRAN array is independent of any other number in that array. In contrast, a character in a C string has little meaning by itself. Instead, all the characters in the string taken together have a meaning. This distinction of individual

meaning versus group meaning isn't just a pedantic nicety: It underlies why C does better than FORTRAN at itemizing words in a file.

However, when we try to parse a sentence, C's abstraction of strings as a collection of related characters doesn't help much. We don't want to spell the words; we don't even care what the words are; we just want to identify their respective parts of speech. C's abstraction isn't wrong; it just isn't the one we need.

Verbosity and Fragility

Working without the abstractions you need exacts a definite cost in verbosity and fragility. The verbosity is due to the additional source code you must add to do the things that a language with a more appropriate abstraction would have done for you. You can hide much of this source code inside function calls, but too much of it usually ends up in the form of manual programming conventions.

For example, a complex number is made up of a pair of ordinary numbers called its real and imaginary parts. Since FORTRAN was designed with abstractions for numerical analysis, it had complex numbers from the start. If you have declared A, B, and C as complex numbers, then the simple statement $A = B \times C$ is sufficient to cause the real and imaginary parts of B and C to be multiplied, recombined, and stored into the real and imaginary parts of A.

However, if FORTRAN didn't have complex numbers, we would have to handle the process ourselves. First, to represent a complex number, we could use a one-dimensional array of two elements for its real and imaginary parts. What would a simple

continued

GET A GREAT RETURN ON FOUR INVALUABLE INVESTMENTS!

Let's face it! We all invest in products we can't afford because we assume that the price tag is an indication of the quality we'll receive. You pay more, therefore, you get more. This is not necessarily true! Now, GTEK[®], INC. has paved the road to engineering excellence by creating high-quality products with an affordable price tag. Take a look and see!

NEW! GTEK[®]'s NEW ROMX-2 Eeprom Emulator is a programmer's dream come true. Performing the same functions of an eeprom, this product literally eliminates the old-fashioned methods of erasing and programming eeproms, thereby, saving hours of unnecessary programming time and frustration. Furthermore, this product pays for itself with the first project you work on.



GTEK[®]'s Model 9000 Eeprom Programmer is another cost-effective, high-performance product that has been proclaimed the fastest programmer on the market. Its quick pulse and intelligent programming algorithms give you SUPER FAST programming speed and you can program the chip of your choice, including single chip processors and megabit parts.



NEW! TEN TIMES FASTER than GTEK's original gang programmer, the NEW MODEL 9800 GANG PROGRAMMER has SUPERSONIC quick pulse programming algorithms. What's more, you'll get your programming completed 8 TIMES FASTER by programming 8 eeproms at a time. Plus, the 9800 programs megabit parts.



NEW! In a class all by itself, the NEW PCS5-8X Multiport Serial Board has impressed the market with its unlimited functions. This board has 100% Dos compatibility on all 8 ports and an enhanced INT 14H Bios device driver. A truly state-of-the-art product.

ORDER TOLL FREE 1-800-255-GTEK (4635)
FAX: 1-601-467-0935 TELEX 315814(GTEK UD)
MS & Technical Support 1-801-467-8048

GTEK[®], INC.

DEVELOPMENT HARDWARE & SOFTWARE
P. O. Box 2310
Bay St. Louis, MS 38521-2310 U.S.A.

multiplication of two complex numbers, $A = B \times C$, look like?

$$A(1) = B(1) \times C(1) - B(2) \times C(2)$$

$$A(2) = B(1) \times C(2) + B(2) \times C(1)$$

The best abstraction that we could devise in FORTRAN would probably be a complex multiply function, such as CMULT(A,B,C), which is an improvement, but the fact that you don't have a true complex-number data type still shows.

Given the statement $A = B \times C$ in FORTRAN IV, where variable names beginning with A have been declared to be implicit complex numbers, the language's automatic memory-allocation abstraction would have allocated A for you. But before you used the CMULT(A,B,C) function above, you would have had to declare A yourself as DIMENSION A(2). Custom functions (and macros) can make do-it-yourself abstraction-building less painful, but the pretender still isn't as good as the real thing.

The actual load/add/store sequences executed by the hardware in these examples are identical. The difference is the level of abstraction available to the programmer. The lack of an appropriate abstraction is a definite programming liability.

In addition to being more verbose, your code also becomes more fragile, because the verbosity exposes more of the language's housekeeping as source code. The extra code provides more opportunity for errors, which can be introduced by anything from typographical errors to overlooking a special programming convention (i.e., when you did *this*, you forgot to do *that*). The code is also subject to errors due to its lack of intuitiveness. You could mistake it for a fragment of matrix multiplication; if you can't fathom its purpose, you can't be sure if it needs fixing.

The Next Step

This discussion of abstractions leads us to three real points:

- Each problem has its own preferred set of abstractions. If the programming language you are using doesn't provide the relevant abstractions, you will have to code them yourself.
- Conventional languages almost universally provide abstractions of numeric things and can perform numeric processing. Languages that provide abstractions of nonnumeric things can perform symbolic processing.
- The historical progress of computing is closely tied to the available abstractions—that is, the available programming languages. Symbolic processing is the next evolutionary step.

Of all the things that exist in the world and in our minds, we need to be able to abstract them before we can represent them in the ones and zeros of a computer. At present, abstractions have not wandered too far from the concept that data is numbers. Now, we are beginning to suspect that the things in this universe that numbers can represent may be in the minority.

Our progress beyond the bounds of numbers has come in stages. First, we found that symbolic operands couldn't always be represented in a 32-bit memory word, so we set up pointers as a general data representation. Next, we found that there were relationships too complicated to be described in a multidimensional array, so we devised trees. Then, we found that memory usage was too sophisticated for static allocation, so we created dynamic run-time allocation and de-allocation. Now, we are finding a need to process symbols that don't represent numbers. The idea of symbolic processing began when we first realized that data needn't be numbers: we have yet to see all the possibilities of that idea. ■

IN-HOUSE DATA TRANSMISSION MARATHON

Out of breath at 50 feet? Now go the distance.

Are your RS-232 data lines out of breath before they cross the finish line? Are you restricted from placing your computers and peripherals where you need them due to the 50 foot limit imposed by the RS-232 standard?

Now you can extend your serial data communication lines up to 5000 feet without even

breathing hard. Using standard, inexpensive twisted pair telephone wiring and our easy-connect LD series long line drivers, you can achieve data rates in excess of 56 kilobits per second. Contact us today and we'll rush to get you more information... FAST.

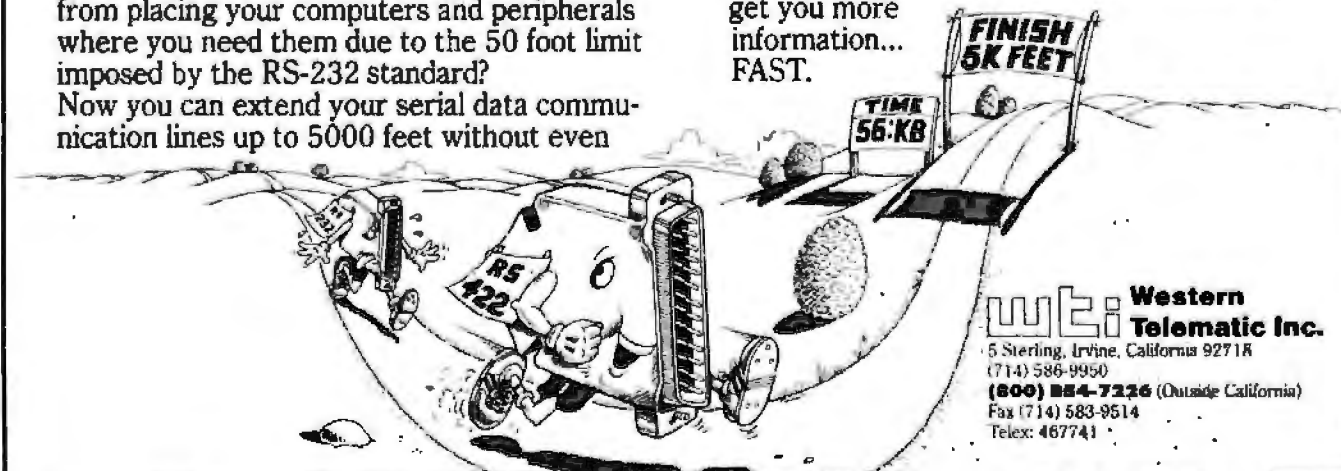

wte: Western Telematic Inc.
5 Sterling, Irvine, California 92718
(714) 586-9950
(800) 854-7226 (Outside California)
Fax (714) 583-9514
Telex: 467741

continued from page 36

to stay late or work over lunch to learn something for their own sake—and the corollary is that management somehow can only rarely spare anyone long enough to send them to school or do training on company time.

There is a vicious cycle of ignorance and excuses for not learning and for not training at work in companies where management still perceives that the company is too small to support an active training program, in-house or out.

The company buys hardware and software because they are tools to use in processing data that is relevant to the company's business. That data is the property of the company, even when people move on or are replaced or promoted.

From personal experience, I know how hard it is to have the personnel department call the week after the director leaves, asking if anyone can help the new guy with this Visifile application that is running on a PC that had an oddball accelerator card, and what does "General Failure reading drive C" mean, anyway? And no, no one can find any backups or program disks or manuals, but we have to use it to get the time cards out, so since you're a programmer, why don't you fix it *right now*?

The now ex-director was a fairly knowledgeable PC user who had available the Lotus 1-2-3, dBASE, and WordStar that we could support, and he had gotten an IBM PC XT despite a request for an AT because he couldn't justify the more expensive machine. So, since he wanted to save himself the trouble of learning programs new to him, he brought from home (or bought without telling anyone) Visifile, PFS:Professional Write, Multiplan, ProKey, and several truly off-the-wall programs and some hardware to make himself feel that even though he didn't get an AT, he is still better equipped than the average guys who don't know how to work the angles and get what they want. Time cards, reports, and sensitive personnel records are now tied up in files and formats that are accessible only through programs no one else knows anything about. It appears that the hard disk drive is failing sporadically, with no backups in sight.

Your arguments boil down to encouraging personal creativity and initiative; mine boil down to being able to pick up and go on, even when that creative person has picked up and moved on, leaving someone else to clean up behind him. As in so many other things, there is a balance to be struck. In my mind, the critical factor in determining that balance is the degree to which disruption of company business will take place if a customized

and personalized hardware/software set-up is left for a new person to take over.

Standards serve the interests of the company mostly from a standpoint of continuity, and I have grown to appreciate continuity of service, and a predictable level of quality of service and product, as absolutely key ingredients in the success of any business.

At the very least, I will forever more make one demand: No matter what else goes on, no matter what hardware or software is used, I set a minimum standard and procedures for at least a weekly

backup. This includes all users backing up all data files and turning those backups over to the DP department for off-site or fire-safe storage.

The DP mentality has more than tradition and bureaucratic mindset as its motive force. There are real concerns that can be addressed only by the implementation of standards at some level.

Charles Hahn
Orange, CA

Thank you. You do a good job of telling the MIS side of the story. —Jerry ■

"Developing my application in C would have taken 6 months to a year, but in Actor it took 2 months."
—Brian Fenske, Boeing Commercial Airplane Company

**"To C
or not
to C..."**



Actually, you don't have to make the choice. Once C was ideal for all PC programming. But it has been complicated by windowing and graphical interfaces. Now windows development with C is difficult, time-consuming and error-prone. You need a new language that simplifies windows programming. Introducing Actor®.

Actor is the first interactive object-oriented language made for commercial development. Its powerful browsers, inspectors and debuggers give you more insight into a windowing environment than C ever will. But your C work is not lost. C libraries can be linked to Actor. Plus, its procedural syntax is easy for C programmers to learn.

Actor comes with windowing classes built in. Customize Actor's classes to create stand-alone windowing applications. And objects give you another layer of independence for a smooth transition to OS/2 and Presentation Manager. It's the quickest and easiest way to write a windowing program.

"You can write Windows programs much faster with Actor than with C or assembly language."
—PC Magazine, June 9, 1987

T e c h S p e c s

- Runs with Microsoft Windows 1.04, 2.0 and 386. Extended memory under 2.0 and 386.
- Pure, single-inheritance object-oriented language, incrementally compiled.
- Dynamic linking to C, Pascal, Assembler, or Fortran libraries. Pass data in C structures.
- Pascal and C-like syntax.
- Programming tools: Browser, Inspector, Debugger, File Editor.
- Full access to MS-Windows systems calls, multitasking, and DDE.
- Fast device-independent graphics: lines, shapes, icons, cursors, bitmaps, metafiles, Turtle graphics, sample control language using YACC.
- 150 classes, 1500 functions, fully extensible.
- Window styles: tiled, overlapping, popup, child, edit, dialogs.
- Controls: list boxes, scroll bars, buttons, check boxes.
- Data structures: stacks, arrays, queues, lists, dictionaries, sets, sorting, hashing, intervals.
- AI support: frames, symbols, dictionaries, lists, symbolic programming, functional arguments. Parsing and lexical analysis YACC compatible.
- String manipulation: substring, concat, append, insert, remove, search.
- 643-page manual includes tutorial and reference.
- No license fees. Generates stand-alone applications.
- Fastest interactive OOL available.
- Fast incremental garbage collector.

Actor \$495 • Academic price \$99 • Academic site license \$99 • Manuals for site license \$35 • New! Language Extension \$99 • Shipping \$5 US, \$25 Int'l

The Whitewater Group
Technology Innovation Center
906 University Place, Evanston, Illinois 60201 -
(312) 491-2370

Actor is a registered trademark of The Whitewater Group, Inc.



“Unlimited.”

un·lim'it·ed, a. [L. limitus]: *The ability to expand your personal computer's storage capacity beyond your wildest imagination.*

Up until now, the concept of unlimited PC storage capacity was about as practical as cramming all your office files into your briefcase. Storage capacity could only be stretched as far as the fixed capacity of your hard disk. Or to the limit of your patience for shuffling through stacks of floppies.

But imagine instead that you could insert and remove hard disks as easily as a VCR cassette — your PC's storage capacity would then be virtually limitless.

That's exactly the idea behind the Tandon Personal Data Pac, the world's first and only



number of self-contained, portable Personal Data Pacs that can be inserted and removed as easy as a floppy. Now a whole business worth of software and data can fit neatly into your briefcase. Ready to go anywhere your business will take you.

And when you are done for the



day, your entire information base can be simply locked away where only you can get at it.

If you want to share your software and data with others, the Tandon Personal Data Pac offers you the cheapest and most reliable “network” possible. Simply

transfer what you need from one Pac to another, and turn a shared PC into a dedicated workstation, just for you.

If your travels with the Data Pac take you on a bumpy road, don't worry. Your software and files will be safe and secure inside the Pac's rugged housing. It can even take a trip in the mail or an occasional fall off your desk.

See your Tandon Dealer today or call us at 1-800-556-1234, ext. 171 (in California 1-800-441-2345, ext. 171) and learn the new definition for personal computing.

The possibilities are limitless.



Tandon

*We're redefining
personal computing.*

Just What The Doctor Ordered. And The Lawyer. And The Architect...

The Quantus Turbo AT

- Monochrome monitor
- Half-height 40Mb hard drive
- 80286 running at 6-10MHz
- 1Mb RAM
- 8 expansion slots
- Text/graphics card
- Speaker
- 1.2Mb floppy drive
- 101-key enhanced keyboard
- 200 watt power supply
- 3 year limited warranty

\$1495
COMPLETE

The Quantus MT386

- Monochrome monitor
- Full-height 80Mb hard drive
- 80386 running at 4.77/6/8/10/16MHz
- 2Mb RAM
- 8 expansion slots
- Text/graphics card
- Speaker
- 1.2Mb floppy drive
- 101-key enhanced keyboard
- 200 watt power supply
- 3 year limited warranty

\$2995
COMPLETE

The Quantus Turbo XT

- Monochrome monitor
- Half-height 20Mb hard drive
- 8088 running at 4.77-8MHz
- 640K RAM
- 8 expansion slots
- Text/graphics card
- Speaker
- 360K floppy drive
- 84-key keyboard
- 150 watt power supply
- 2 year limited warranty

\$795
COMPLETE



QUANTUS

Quantus Microsystems
One Butterfield Park
Spofford, NH 03462

(800) 255-0125 (603) 363-4564
(800) 356-9001 (603) 886-3220

System Calls in Modula-2

Here's how to use Modula-2 to interact with your computer at the BIOS and DOS level



Niklaus Wirth created Pascal to help teach programming, but people discovered they had problems using it in real-world situations. For example, Pascal cannot access the computer's hardware at a low level. Wirth resolved this problem when he designed Modula-2, a successor to Pascal that was meant to be used in the real world.

It's easy to use Modula-2 to program an IBM PC or PS/2 at a lower level than you might normally use in another high-level language. The source code listing accompanying this article illustrates programming at the ROM BIOS level and the DOS level through Modula-2. I've tried to annotate it as much as possible for easy reading. [Editor's note: *The program MODDOS.MOD is available on BIX, on BYTEnet, on disk, and in the Quarterly Listings Supplement. See "Program Listings" in the table of contents. To "find" source code in the Listings areas on BIX and BYTEnet, search by article title, author, or issue date. Some archived files may contain numerous listings for a single article. A description of the file also accompanies each entry.*]

MODDOS.MOD gets, sorts, and prints directory entries matching a filename pattern; gets and prints the amount of available space on a specified disk; renames files; clears the screen; and locates the cursor in a specific place on the screen. I compiled and linked the source code with the Modula-2/86 package from Logitech. Because other Modula-2 implementations may provide a slightly different set of library modules from those of Logitech, you may need to change some of the identifiers in the source code listing.

You should watch out for several identifiers. SWI generates a software interrupt and is used for ROM BIOS calls. DOSCALL is used to call DOS routines and functions. ADDRESS is a data type for variables that can simultaneously be considered a pointer to a word or a record containing the segment and offset address of a variable. ADR is a function that returns the address of a variable.

FROM . . . IMPORT <module names>: If the names of the modules to be imported are different from Logitech's, you will have to change the references to them here. The implementation and definition modules for both the Yes and Vidserv files are available at the tail end of MODDOS.MOD. You should extract these files, compile them separately, and import them as shown in the IMPORT section. Each IMPORT declaration names the module to be referenced and must also include the names of each variable, type, or procedure to be included in the final product. The ones used here, except as mentioned above, are supplied with the

Modula-2/86 package as parts of the standard library.

In practice, MODDOS.MOD could have been written in distinct modules, compiled, and then merely called by a main driver program. To make the program more readable, however, I have combined the necessary parts into one module.

Getting the Directory

To use DOS to get the directory entries, I use the Modula-2 procedure DOSCALL to perform various DOS functions. If your Modula doesn't have a similar procedure, you can accomplish the same thing by issuing interrupt 21H with the DOS function number in the AH register (more on how to do that later).

The procedure FindMatch (see listing 1) locates the disk transfer area (DTA) and finds the first file that matches the wild-card pattern given in the global variable filename. The procedure gets the address of the current DTA by executing DOS call 2F hexadecimal (decimal 47); the DOS call returns the address in the variable DiskTransferArea, which was earlier declared as an ADDRESS. We will use the value of DiskTransferArea in this and other procedures to locate other useful information. When we call DOS with the value 4E hexadecimal (decimal 78) to start searching, we must provide it with the address of the pattern we want to match (FileNamePattern) and a CARDINAL number describing which files to look for (attribute, a global variable). The value of attribute is the sum of any or all of the following values:

- 1 read-only files
- 2 hidden files
- 4 regular files
- 16 subdirectories

For example, if you wanted to find all the regular and hidden files matching the pattern, you would set attribute to 6. There are also attribute values for getting the volume label (value of 8), and only files marked for archiving (value of 32), but these file types are of limited use.

When you execute DOS call 4E hexadecimal, DOS returns the first filename that matches the given wild-card pattern and attribute type. The name is an ASCIIZ string (an ASCII filename ended by a zero or null character), and it is located 30 bytes past the beginning of the DTA. Both AsciiZFileName and CharacterPointer point to this location, and they are both incremented in the process of filling the character array directory with the filename to which both pointers point.

The beauty of Modula-2 over Pascal in this instance is that the use of pointers (CharacterPointer is defined as being of type

continued

Richard Rankin is finishing his M.S. in computer science at the University of Arkansas. You can reach him at P.O. Box 3036, Fayetteville, AR 72702.

byteptr, which is a POINTER TO CHAR) allows us to circumvent Modula-2's type checking. This means that Character-Pointer or any other variable of type byteptr can be used to locate integers, characters, or any other basic type, although characters are the only byte-size information we would probably need to access. Variables declared as POINTER TO WORD are also useful for transferring 16-bit words into program variables. If you're familiar with Pascal, notice that there is no need to declare an ARRAY as PACKED. All characters are stored in a byte, instead of a word, so packing is effectively done all the time.

The next step is to determine the file's size, a 4-byte quantity that starts at DiskTransferArea+26. The variable cardinal points to this word, which is the low-word portion of the file size returned by DOS. (The high-word portion is located 28 bytes into the DTA.) If you were programming in 8086 assembly language, you would have to remember that the 8086 (and other members of its family) saves words as low byte/high byte. In Modula-2, however, since cardinal is a POINTER TO CARDINAL, assigning the dereferenced pointer to a variable of type CARDINAL (the statement CardinalSize:=cardinal;) causes the language to convert the memory locations properly.

The final result for this value has to be in a variable of type REAL, since the file size may take on values larger than the 65,535-byte limit of a CARDINAL variable. I first convert it to a string, then to a real because both these procedures already exist (and no such cardinal-to-real procedure does); the end result is the REAL variable sizelow.

When a program calls DOS function 4E hexadecimal, DOS also saves the information needed to find the rest of the matching files that meet my criteria. The FindNext procedure (not listed here, but part of file MODDOS.MOD) will cycle through the

directory until no more matches are found, using this information DOS has stored. You also have access to an error code and other file-related data; the attribute byte is at DiskTransferArea+21, a 2-byte time stamp is at DiskTransferArea+22, and a 2-byte date stamp is at DiskTransferArea+24.

The final procedure, GetDir, uses FindMatch, FindNext, and several other procedures to prompt the user for a wild-card pattern; then it gets, formats, and prints the files that match it.

Overall, this solution has the best of both worlds—the speed and simplicity of predefined DOS functions and the formatting and arithmetic conveniences of a high-level language. Note that the code to read in a filename and get its size involves duplication in the FindFirst and FindNext procedures. These blocks of code could have been modularized into shorter, more efficient procedures.

Free Space on a Disk

My next example uses DOS to help locate and print the available free space on a disk. A simple DOS call to function 36 hexadecimal (54 decimal) in procedure FreeSpace returns the number of available disk clusters, the total number of clusters, and the bytes per sector. If an error occurs, the DOS function returns FFFF hexadecimal or 65535 decimal in the variable error. If there is no error, it returns the number of sectors per cluster. As before, we convert certain cardinal numbers to strings, then to real variables so that the variable realfreebytes is big enough to hold any values given to it.

Renaming Files

The procedure for renaming a file, RenameFiles (see listing 2), is even simpler. The two input parameters to this procedure are

MOUNTAIN'S FILES KEEPS YOUR DATA

Mountain's FileSafe delivers the broadest range of reliable and affordable tape backup systems for users of IBM® PS/2, XT, AT® and most compatible computers.

FileSafe40
Four ways to get our most economical units, with convenient, pocket-size DC2000 cartridges.

A MOUNTAIN OF BACKUP FROM 40-600MB.

Now you can have 40, 60, 150 or 300 megabytes of tape cartridge backup in one internal or two zero-foot-print external versions.

Need higher capacity? Daisy-chain two 300-megabyte systems and get a whopping 600 megabytes of tape backup!

Which is just what you need for

those big storage-intensive applications like desktop publishing, file servers and data base management.

Every FileSafe system includes Mountain's latest generation of powerful, automatic and menu-driven tape backup software that tens of thousands of professional, business and government systems users rely on daily

to protect their irreplaceable data.

What's more, Mountain supports the most popular single and multi-user operating systems. Plus local area networks like Novell, PCnet, TOKEN RING™ and many more.

FileSafe60
60MB, high-speed tape backup systems using the popular DC500 cartridge.



the current filename (`oldname`) and the desired new filename (`newname`). This procedure uses the `ADR` function to get the filenames' addresses to pass to DOS, then calls on DOS function 56 hexadecimal (86 decimal) to do the work of renaming the file. Since this DOS function actually changes the file's directory entry, you can use it to move a file among subdirectories on the same disk, but you can't use it to rename a file from one drive to another.

Using ROM BIOS Calls

For examples of using the IBM PC or PS/2 ROM BIOS calls in Modula-2, I've added two functions to the library, `CLs` (clear the video screen) and `GotoXY` (go to a specified row and column); see listing 3. The ROM BIOS calls in this Logitech version are done through a Modula-2 procedure called `SWI`, which stands for software interrupt.

Logitech recommends that you push the 8086 base pointer before an `SWI` call and pop it immediately after. You can use the `CODE` procedure, which merely inserts its parameters directly into the final program, to create short assembly language sequences. `CODE(55h)` means to push the base pointer onto the stack, and `CODE(5Dh)` means to pop it. The `SETREG` procedure does exactly what it sounds like—it lets you set the value of a register directly.

Both ROM BIOS procedures use the interrupt value of 10 hexadecimal (16 decimal) to request video services. The call format is `SWI(10h, parameter)`. By changing the parameter, this interrupt can activate such items as disk services, printer services, time and date services, and communications-port services. In general, anything that is available to an assembly language program is available to Modula-2 through the `DOSCALL`,

`SWI`, and `CODE` procedures.

The `DOSCALL` and `SWI` procedures differ in that the former takes place at a much higher language level. The `DOSCALL` functions are similar to any Modula-2 procedure in that they use parameters specified in the heading of the procedure being called. The `DOSCALL` procedures then set the proper register values, generate the interrupt, and return the proper values.

When you use the `SWI` procedure, on the other hand, you must set the register values yourself. These values are passed "as is" when the software interrupt occurs. The values returned, if any, are placed in the proper return registers, and you use the `GETREG` procedure to return the value to your program variables.

If you don't like dealing with system interrupts, Modula-2 makes it simple to write your own library procedures to do the low-level work you want to hide. This means that you can write a series of library procedures to handle `SWI` calls, returning the values to your program in variables. From that point on, you can call your software-interrupt procedures with the same format as the `DOSCALL` procedures instead of recoding them each time and worrying about which parameter goes in what register. Modula-2's modularity is perfect for that sort of thing.

Clearing the Screen

You can clear the video display in several different ways. One quick way is to reset the screen mode to the mode it's already in; this effectively clears the screen on the IBM PC and many compatibles. A second way is to write blanks through the screen locations yourself. Since screen accesses wrap around if you write past the end of the screen (because you specify the screen page

continued

SAFE™ TAPE BACKUP FAIL-SAFE.

ASK FOR FILESAFE AND RELAX.

An industry leader for over a decade, Mountain backs all FileSafe systems with a full 12-month limited warranty. And a worldwide reputation for responsive service and support.

If you're looking for high-performance tape backup for your PC, look to Mountain. We've got the widest range of systems to keep your data Fail-Safe, simply ask for FileSafe by name and relax.



FileSafe 200/600
Daisy-chain for up to 600MB—
the highest capacity in high-
speed tape cartridge backup

FileSafe 150
One cartridge covers nearly
every size hard disk system



Call us today for more information and the name of your nearest FileSafe tape backup dealer or distributor

Circle 298 on Reader Service Card



Mountain

THE PEAK OF PERFORMANCE
1-800-458-0300

Mountain Computer, Inc. 240 Hacienda Ave., Campbell, CA 95008
(408) 379-4300, TLX 373-1724 UB, FAX 408-379-4302

Mountain products are distributed and sold worldwide. *registered trademarks and *trademarks of Mountain Computer, Inc. and International Business Machines Corp. ©1987 Mountain Computer, Inc. Specifications and availability subject to change without notice.

Listing 1: The FindMatch procedure finds the first file that matches the wild-card string in the variable filename. This procedure is part of a larger file, MODDOS.MOD (see main text for details), and some of the variables listed here are declared elsewhere in MODDOS.MOD.

```
PROCEDURE FindMatch (VAR error :CARDINAL;
                    VAR NumberFound
                        :CARDINAL);

(* This procedure uses DOS call 2Fhex to
locate the disk transfer area, and DOS call
4Ehex to find the first file that matches our
directory path and wild-card pattern. When
this routine is called, DOS also provides the
information required to find additional files
matching the specifications *)

VAR sizelow, sizehigh :REAL;
    CardinalSize :CARDINAL;
    cardinal :cardinalptr;
    StringOfCardinal :string;
    okay :BOOLEAN;

BEGIN

    FileNamePattern:=ADR(filename);
    DOSCALL(2Fh, DiskTransferArea);
    DOSCALL(4eh, FileNamePattern,
            attribute, error);
    AsciiZFileName:=
        DiskTransferArea+30; (* filename
                             starts 30 bytes into the
                             DiskTransferArea *)
    CharacterPointer:=AsciiZFileName;
    NumberFound:=1; (* increment the
                     counter for number of
                     matching files found *)
    counter:=1;
    WHILE CharacterPointer^(<>nul DO
        (* ASCIIZ string, so it will
         have a 0 byte at end *)
        directory(NumberFound, counter):=
            CharacterPointer^;
        AsciiZFileName:=AsciiZFileName+1;
        counter:=counter+1;
        CharacterPointer:=AsciiZFileName;
    END;
    cardinal:=DiskTransferArea+26;
    (* set pointer to low
     order word of size *)
    CardinalSize:=cardinal^;
    CardToString(CardinalSize,
                 StringOfCardinal, 12);
    StringToReal(StringOfCardinal,
                 sizelow, okay);
    cardinal:=DiskTransferArea+28;
    (* high order word of size
     located 28 bytes into
     DiskTransferArea *)
    CardinalSize:=cardinal^;
    CardToString(CardinalSize,
                 StringOfCardinal, 12);
    StringToReal(StringOfCardinal,
                 sizehigh, okay);

    sizelow:=sizelow+(sizehigh*65536.0);
    RealToString(sizelow, 0, 12,
                 sizes[NumberFound], okay);

END FindMatch;
```

Listing 2: The RenameFiles procedure changes the directory entry of a given file, or it returns an error message.

```
PROCEDURE RenameFiles(VAR newname, oldname
                     :filearray);

VAR newfile, oldfile :ADDRESS;
    error :CARDINAL;

BEGIN
    oldfile:=ADR(oldname); (* the DOS calls
                             require the
                             ADDRESSES of *)
    newfile:=ADR(newname); (* the filenames *)
    error:=0;
    DOSCALL(56h, oldfile, newfile, error);
    CASE error OF
        3: WriteString('PATH NOT FOUND');
           WriteLn |
        5: WriteString('ACCESS DENIED');
           WriteLn |
        17: WriteString('PATH NOT FOUND');
            WriteLn
    ELSE ;
        END; (* CASE *)
    END RenameFiles;
```

Listing 3: The GoToXY and Cls procedures. This listing contains a complete module, Vidserv, which should be compiled separately and brought into another program through the IMPORT statement. GoToXY moves the cursor on the video display to a given row and column. Cls clears the screen by scrolling it up 24 lines.

```
DEFINITION MODULE Vidserv;

FROM SYSTEM IMPORT AX, BX, CX, DX, CODE,
                  SETREG, SWI;
FROM InOut IMPORT Write;

EXPORT QUALIFIED
    GotoXY, Cls, Tab;

PROCEDURE GotoXY( col, row :CARDINAL);
PROCEDURE Cls ();
PROCEDURE Tab(spaces :CARDINAL);

END Vidserv.

IMPLEMENTATION MODULE Vidserv;

FROM SYSTEM IMPORT AX, BX, CX, DX, CODE,
                  WORD, BYTE, DOSCALL,
                  SETREG, SWI;
FROM InOut IMPORT Write;

PROCEDURE GotoXY( col, row :CARDINAL);
    VAR row1, coll :CARDINAL;
        dx :WORD;

BEGIN
    row1:=row-1; (* adjust row, col back to
                  0,0 *)
    coll:=col-1;
    dx:=WORD(coll+(row1*256));
```

continued

```

CODE(55H);      (* push BasePointer *)
SETREG(AX,200H); (* position cursor
                    function *)
SETREG(DX,dx);  (* raw in dh, col in dl *)
SETREG(BX,0H); (* current page number *)
SWI(10H);      (* ROM call for video
                    services *)
CODE(5DH);      (* pop BasePointer *)

END GotoXY;

PROCEDURE Cls ();
  VAR bottom :WORD;

BEGIN
  bottom:=WORD(79+(24*256));
                    (* set bottom to
                    column 79 in
                    register DL *)
                    (* and row 24 in register
                    DX *)
CODE(55H);      (* push BasePointer *)
SETREG(AX,600H); (* scroll up - register
                    AH=6 *)

SETREG(CX,000H); (* upper left row and
                    column - 0,0 *)
SETREG(DX,bottom); (* lower right row in
                    dh, col in dl*)
SETREG(BX,700H); (* blank line video
                    attribute *)
SWI(10H);      (* ROM call for video
                    services *)
CODE(5DH);      (* pop BasePointer *)

END Cls;

(* This procedure is not covered in the
   article: *)

PROCEDURE Tab(spaces :CARDINAL);
  VAR counter :CARDINAL;
  BEGIN
    FOR counter:=1 TO spaces DO
      Write(' ');
    END; (* FOR .. DO *)
  END Tab;

END Vidserv.

```

being affected, and the wrap occurs within that page), it doesn't really matter whether you start from the first screen location or not. If you don't start from the first screen location, though, your cursor will return to the position from which it started. If you want the cursor to end up in a certain position (upper left corner, for example) after the screen is cleared, you can use the GotoXY procedure to move it.

The procedure Cls clears the screen by scrolling up 24 lines. I chose to do it this way to provide a base procedure for you to change and make more useful. The call to Cls, which appears in listing 3, has no parameters. Notice, though, that the CX register contains the upper left coordinates of the window to be scrolled, and the DX register contains the lower right coordinates. This information makes it simple to change the procedure to a generic window-clearing procedure that clears a specified rectangle of text. All you need to do is add parameters to Cls, like this:

```
Cls(upperX,upperY,lowerX,lowerY)
```

and correctly insert the parameters into the CX and DX registers. If you separately compile this as a module, you can use it in

all your programs to clear either the whole screen or some portion of it.

Moving the Cursor

The GotoXY procedure (see listing 3) uses the requested row and column screen coordinates as its parameters. GotoXY subtracts 1 from each coordinate (allowing users to think of rows and columns that start numbering at 1, not 0), places the proper values into the correct registers, generates a software interrupt, and voilà!, your cursor is where you want it to be. This is another simple procedure that can be written once, compiled separately, and used by any program you write in the future.

Access and Control

Modula-2 is not a perfect programming language, but it offers the best features of Pascal (block structure and strong type checking) and C (low-level access to hardware). It also has several advantages over Pascal itself, most notably its separate compilation of modules, its cleaner syntax, additional programming constructs, and an improved I/O interface. Now that affordable Modula-2 implementations exist for most 16-bit microcomputers, you should consider getting to know it. ■

Custom Imprinted Keys, Keytop Shells, Snap-on KeyCaps™, and Keytop™ Labels

Available in a rainbow of colors for IBM and most other keyboards. Produced to your exact specifications by our competent engineering staff and precision imprinted for wear-resistance and compatibility to your present keys. Hoooleon keyboard enhancements also include keytop kits, keyboard protectors, individual key lockouts, vinyl templates, keytop expanders, plus much, much more. Call or write for our free 1988 Catalog today. (602) 634-7515

FROM THE LEADER IN
KEYTOP INNOVATIONS

Hoooleon
CORPORATION

P. O. BOX 201, DEPT. BYTE
CORNVILLE, AZ 86325



PICK BIX BRAINS

... With a 10 Day Trial Membership

If you've thought about joining **BIX** before but weren't sure it was what you needed, now is the time to try it. Because now for a limited time, we're inviting you to try **BIX** for 10 days. If at any time during this 10 day trial period you don't feel **BIX** has made you a more knowledgeable microcomputer user, we'll refund your entire registration fee. You pay only for time spent on the system.* (See log-on instructions for hourly rates).

Explore **BIX** in your home or office. Put its power to work for you and unleash your full microcomputer potential — programming, designing, specifying, researching — and more.

Try **BIX** for 10 full days and see what it can do for you. Explore more than 160 conferences. Access vendor support. Speak to expert consultants. Research new products and systems, and download public domain software.

Prepare yourself for success

It takes a sharp mind and hard work to stay ahead, and having the right tools helps.

Today, you can put one of the most powerful instruments for career advancement to work for you: **BIX**.

- Learn about new products before they hit the market.
- Get quality marketplace feedback on the products you're thinking of purchasing before you invest.
- Research problems and find the solutions that no one else has been able to render.
- Access some of the most advanced public domain software available in the industry.
- Increase your working knowledge of micros to make more confident purchasing decisions and recommendations.

Join **BIX** and arm yourself with the latest in microcomputer-related information

BIX's exclusive *Microbytes* newswire gives you complete, daily, up-to-date computer industry information. You'll gain insight from **BYTE** editors and writers who analyze new products and their potential impact, inform you of the latest mergers and acquisitions, and report late-breaking news from important seminars and conferences.

Talk to colleagues worldwide

You'll stay on top of your company's

business with **BIX's** electronic mail service.

"Talk" to your east coast, west coast — even European — contacts all in the same day.

Or, simply communicate with other **BIX** users worldwide. Share information and ideas privately, or in conference.

Choose any option for online access with a one time \$39 membership fee

- Use MasterCard, VISA or American Express and begin your 10 day trial use of **BIX** right now.
- The 10 day trial also applies if you open an individual pre-paid account on **BIX**. Trial commences once we open your account and notify you.
- Other billing options including qualified corporate accounts are available. (Sorry, our 10 day trial is not available for these accounts.) Call or write **BIX** for details.

Use credit cards for immediate access or call the **BIX** Helpline for information on any other payment option at, 1-800-227-2983 (from U.S. and Canada) 603-924-7681 (in New Hampshire and elsewhere).

Act now! Our 10 day trial offer is subject to cancellation at any time.

* To notify **BIX** that you wish to discontinue service at any time during the trial period, call the **BIX** Helpline, and your entire membership fee will be refunded.

** **BIX** can be accessed via Tymnet throughout the U.S. and Canada. For the Tymnet number nearest you, call the **BIX** Helpline or Tymnet at 1-800-336-0149.

† If your local Tymnet number is a toll call you will receive additional charges from your local phone company at their prevailing rate.

‡ Continental U.S. Tymnet rates. Rates from other areas are available from **BIX**.



BIX is easy to join

To log-on to **BIX**, simply:

Set your computer's telecommunications program for full duplex, 8 bit characters, no parity, 1 stop bit OR 7-bit characters, even parity, 1 stop bit. Use 300 or 1200 baud.

Call your Tymnet number ** and respond as follows:

Tymnet Prompt	You Enter
Garble or request for "terminal identifier"	a
login:	bix<CR>
BIX logo name:	bix.038 <CR>

Callers outside the U.S. who have a communicating computer or terminal and a packet switching account with their host country phone system

can reach **BIX** by entering 310690157800. To commence registration, enter the code listed at the **BIX** logo/name prompt.

After you register, you'll automatically be taken to the **BIX** Learn Conference, an online tutorial that will show you how to begin using the system immediately. Time spent in the Learn Conference is FREE. Complete system documentation will be sent to you within a few days.

Access time will be billed at the following hourly rates.†

Off-Peak Time \$11/hr. (\$9 **BIX**, \$2 Tymnet)††
(7 PM - 6 AM weekdays, all day weekends and holidays)

Peak Time \$20/hr. (\$12 **BIX**, \$8 Tymnet)††
(6 AM - 7 PM weekdays)

BIX

BY TELECOMMUNICATIONS EXCHANGE

One Phoenix Mill Lane
Peterborough, NH 03458

THE BUYER'S MART

A Directory of Products and Services

THE BUYER'S MART is a monthly advertising section which enables readers to easily locate suppliers by product category. As a unique feature, each BUYER'S MART ad includes a Reader Service number to assist interested readers in requesting information from participating advertisers.

RATES: 1x—\$475 3x—\$450 6x—\$425 12x—\$375
Prepayment must accompany each insertion. VISA/MC Accepted.

AD FORMAT: Each ad will be designed and typeset by BYTE. Advertisers must

furnish typewritten copy. Ads can include headline (23 characters maximum), descriptive text (250 characters maximum), plus company name, address and telephone number. Do not send logos or camera-ready artwork.

DEADLINE: Ad copy is due approximately 2 months prior to issue date. For example: March issue closes on January 7. Send your copy and payment to THE BUYER'S MART, BYTE magazine, 1 Phoenix Mill Lane, Peterborough, NH 03458. For more information call Mark Stone at BYTE 603-924-3754.

ACCESSORIES

PROTECT YOURSELF!!!

Ergo-Vision™ Plus 2 Radiation Filter with patented nickel mesh protects you from radiation, static, and glare. Reduces electromagnetic radiation by 90% +, electrostatic charge to 0 and eliminates glare. Anti/Rad/Stat/GI filter \$99. Anti/Stat/GI \$39. a/ft \$3. Check/COO. Specify monitor manufacturer & model #. Free catalog.

Abelson Communications

Dept. B, POB 1031, Rockville Centre, NY 11570
516-766-7782

Inquiry 551.

ACCESSORIES

SELF-INKING PRINTER RIBBON

Awarded United States Patent #4701082
Lasts 10-15 times longer than the conventional ribbon
For printers using 1/8" width open spool ribbon.

Okidata-82A-83A-84-92-93	Dec LA 180120
TeleType-33, 38	Dec LA 3058M 1443
Star Gemini 10X	TeleType-Model 40
Excal	TI 800810, 820, 880

Contact us by mail, phone or telex and we will forward you a brochure

CONTROLLED PRINTOUT DEVICES, INC.

POB 869, Baldwin Rd., Arden, NC 28704
(704) 684-9044 • TELEX: (FILMON-AREN) 577454

Inquiry 556.

ACCESSORIES

POLAR FILTER

- Prevent the glare, flicker and shake caused by the reflection of outside light which are common causes of eye fatigue
- Prevent the aggravated nearsightedness (proved by test) and weakening of eye nerves
- Blocks out 100% of Ultraviolet rays

COMES IN VARIOUS SIZES EVEN FOR TV's 12", 14", 18", 20", 21", 27", 37", 48" respectively. Cashier's check, money order, or COO, wholesalers welcome.

UNLIMITED Computer Systems

11175 Mt. View Ave., #K, Loma Linda, CA 92354
Ph # (714) 796-7974 Fax # (714) 796-3931

Inquiry 561.

FREE CATALOG

Thousands of parts and new surplus electronic parts at super low prices. FAST ORDER PROCESSING AND SHIPPING (95% of all orders shipped within 48 hours)

CALL OR WRITE FOR A FREE CATALOG.

ALL ELECTRONICS CORPORATION

P.O. Box 567, Van Nuys, CA 91408-0567

1-800-826-5432

Inquiry 552.

FREE CATALOG

Valuable Computer Supplies Source for Diskettes • Disk Packs • Dust Covers • Furniture • Data Cartridges • Printer Supplies • Cleaning Supplies • Tapes • Ribbons • Paper • Copier Supplies • Surge Protectors • Cables • Print Wheels • LOT MORE • LOW PRICES • Bulk Diskettes as low as 30¢ each

Call, Write or Circle Inquiry Card for a FREE Catalog

GAAN COMPUTER SUPPLIES

166 B East Sunnyside Ave., Campbell, CA 95008

(800) 523-1238, In Calif. (408) 270-6747

Inquiry 557.

ARTIFICIAL INTELLIGENCE

FamilyCare™ Software

This comprehensive medical diagnostic expert system spares expensive, unnecessary trips to a physician by guiding you quickly through possible symptoms and giving you specific directions for medical care, home treatment, and medications. Includes hundreds of symptoms, injuries, and diseases of newborns through teenagers.

FamilyCare™ Software

Lumdin Laboratories, Inc.
2945 Greenfield Rd., Suite #216, Southfield, MI 48076
800/426-8426 or 313/559-4561

Inquiry 562.

SOFTWARE PACKAGING, DISKS

Cloth binders & slips like IBMs. Vinyl binders, boxes, and folders—many sizes. Disk pages, envelopes & labels. Low qty. imprinting. Bulk & branded disks. Much More! Low prices. Fast service. Call or write for FREE CATALOG.

Anthropomorphic Systems Limited

376-B East St. Charles Road
Lombard, IL 60148

1-800-DEAL-NOW (312) 829-5160

Inquiry 553.

COMPUTER TAPES

Nine Track 6250 Bpi Used
2400' & 1200' Reels

\$ 2.90 Each

Replacement Guaranteed

Prism Development Corp.

918-299-0772

Inquiry 558.

YOUR OWN EXPERT SYSTEM

MicroExpert, an affordable expert system shell, allows you (beginner or programmer) to see how a system works as you build it yourself. Software includes tutorial for design of knowledge base and creation of rules. Source code provided.

IBM PC: 852109-2 Apple II: 852110-6

\$49.95

McGraw-Hill Book Company

P.O. Box 400, Hightstown, NJ 08520

1-800-2-MCGRAW

Inquiry 563.

JOB PROTECTION

If your job depends on your computer, you should have our FREE catalog! Call (800) 356-5794 Ext. 8939 for a FREE catalog from the world's largest manufacturer of single phase uninterruptible power supplies. Call or write today!

BEST POWER TECHNOLOGY, INC.

P.O. Box 280, Necedah, WI 54648
In Wis. (608) 565-7200 Ext. 8939

(800) 356-5794 EXT. 8939

Inquiry 554.

500

Letter size, 20#, continuous paper computer forms, invoices, statements, letterheads, etc. OFFSET PRINTING, AS LOW AS 08¢ EA. Send/Fax: (516-293-0113) the drafts/samples, or direct lead to our computer: (516-293-0153), WE SET THE PAGE FREE. Free UPS shipment in 5 days. Matching envelopes same low price. For 2nd color, add 02¢ EA. NY residents add sales tax. MC/VISA, # & Exp. date.

SFTC

40 SARAH DR., E. FARMINGDALE, NY • 11735-1210

516-293-0110

Inquiry 559.

muLISP™-87 for MS-DOS

Fast, compact, efficient LISP programming environment. muLISP programs run 2 to 3 times faster & take 1/2 to 1/3 the space of other LISP's. 450 Common LISP functions, multi-window editing & debugging, flavors, graphics primitives, lessons & help, demo programs, comprehensive manual.

Soft Warehouse, Inc.

3615 Harding Ave., Suite 506, Honolulu, HI 96818
(808) 734-5801

Inquiry 564.

BAR CODE

PRINT BAR CODES AND BIG TEXT

On your EPSON/IBM/OKI/LaserJet printers. 1" tall text-readable at 50 ft. Code 39, 2 of 5, UPC/EAN, MIL-STD, AIAG. Menu-Driven. Any format/size. File input. Design label on 1 screen \$279. Other simple programs for bar codes from \$49. 30 day \$ back guarantee.

Worthington Data Solutions

417-A Ingalls St., Santa Cruz, CA 95060
(800) 345-4220 In CA: (408) 458-8935

Please see our ad on page 42.

RE-INK FABRIC RIBBONS

Cut ribbon cost by using Borg Ribbon Inkers. Do all cartridge ribbons with just one inker. Choose from 3 models. Manual E-Zee Inker — \$39.50
Electric E-Zee Inker — \$89.50
Ink Master (Electric) — \$159.00

1000's of satisfied users in 5 years. Moneyback guarantee.

BORG INDUSTRIES

625 MAIN ST., JANESVILLE, IA 50647
1-800-583-2404

Inquiry 555.

IBM PC ACCESSORIES!

Our FREE Catalog includes hundreds of Switches, Cables, Buffers, Data Converters, Signal Boosters, Print Spoolers, PC Tools, Surge Protectors & More for your IBM PC. LOW Direct Prices, SAME DAY Shipping & Satisfaction GUARANTEED!

Write or Call for a FREE CATALOG Today!

Tipz Computer Accessories

P.O. Box 690, San Francisco, CA 94101-0690
800-387-8479 or 415-626-4333

Inquiry 560.

BAR CODE

BAR CODE READERS

For PC/XT/AT, and ALL PS/2 models—attaches as 2nd keyboard, reads as keyed data. External mounting via velcro to side of monitor. OR can be short slot mounted in PCs. PC—\$385. PS/2—\$399. RS-232 Model—\$399. Reads UPC, EAN, 2 of 5, Code 39. MagStripe option +\$100. 30 day \$ back.

Worthington Data Solutions

417 A Ingalls St., Santa Cruz, CA 95060
(800) 345-4220 In CA: (408) 458-9938
Please see our ad on page 42

PRINT BAR CODES/BIG TEXT FROM YOUR PROGRAM

Add bar codes and big graphics text to your program. Print from inside of dBASE, BASIC, C, etc. Bar codes UPC, EAN, 2 of 5, Code 39. Epson/Ok/IBM dot matrix text up to 1/2" LaserJet fonts up to 2" (144 pts). Call: \$159-\$239. 30 day \$5 back guarantee.

Worthington Data Solutions

417 A Ingalls St., Santa Cruz, CA 95060
(800) 345-4220 In CA: (408) 458-9938
Please see our ad on page 42

BARCODE BARGAINS

Buy direct and save. We'll beat any written quotes for competing equivalent bar code readers or bar code label generation software. Call or write for brochures. Quantity discounts, warranty, same day shipping. Bar codes are all we do at ITS.

International Technologies & Systems Corp.
1950 White Star Dr., Diamond Bar, CA 91795
(714) 861-7977 Telex 285716 ITSCO UR

Inquiry 565.

BAR CODE MADE EASY

PERCOM® E-Z-READER® keyboard interfaces and multiuser RS-232 models make it easy to add bar code to virtually any computer terminal WITHOUT SOFTWARE MODIFICATION. Immediate shipping. 1 year warranty. Bar code printing software available. Call for details on fast, accurate, easy data entry. Substantial reseller discounts.

PERCOM®

2190 W. 11th St., Eugene, OR 97402
(503) 344-1189

Inquiry 566.

READ & PRINT BAR CODES

Fast, reliable data entry into your programs as if from your keyboard. Internal unit for PC, XT, AT PS/2-M30. RS-232 unit for DOS & Non-DOS systems (incl. all PS/2). Stainless steel wand and LASER interfaces. Powerful Bar Code and Text printing software.

Seagull Scientific Systems

601 University Ave., Suite 150, Sacramento, CA 95825
(916) 386-1776

BAR CODE READERS

Among the industries best and most widely used barcode reader, reads all major barcode formats (code 39, 2 of 5, UPC/EAN, codebar), connects between keyboard & system, advanced CMOS uses keyboard power supply, connects to all IBM compatibles and DIN terminals, completely OS independent, software independent. Same day ship. 1 year warranty, 30 day satisfaction guarantee. CALL for prices too low to advertise.

Solutions Engineering Sales

8653 Georgia Ave., Silver Spring, MD 20910
800-635-6533

Inquiry 568.

BAR CODE

DATA INPUT DEVICES

Bar Code & Magnetic Stripe Readers for microcomputers & terminals, including IBM PS/2 & others, DEC, AT&T, CT, Wyse, Wang. All readers connect on the keyboard cable & are transparent to all software. Low cost bar code print programs & magnetic encoders are also available. GSA approved.

TPS Electronics

4047 Transport, Palo Alto, CA 94303
415-856-6833 Telex 371-9097 TPS PLA

Inquiry 569.

BUSINESS OPPORTUNITIES

FREE LIST

100 P.C. BUSINESSES

Personal Computer Owners can earn \$1000 to \$5000 monthly selling simple services performed by their computer. Work at home - in spare time. FREE list of 100 best services to offer. Write:

A.I.M.B.X

P.O. Box 60369, San Diego CA 92106-8369

Inquiry 570.

COMMUNICATIONS

MULTI-USER BBS (FOR IBM PC AT)

TEAMate — a mainframe quality BBS. A mini CompuServe. Full screen cursor-controlled interface, topic outline structure, public and private topics, audit trails, xmodem, integrated mail, content retrieval and more. MS-DOS, XENIX and UNIX versions.

MMB Development Corporation

1921 No. Sepulveda Blvd., Suite K, Manhattan Beach, CA 90266
1-800-832-6032

Inquiry 571.

COMPUTER BOOKS

Books! Books! Books!

If it's published and about IBM or compatible computers, we probably have it. Books about applications, programming, operating systems, utilities, hardware and much more. Write us today and we'll send you our latest catalog. Send \$1 to:

Book Express

Dept. 100, 851 Wedner Ct. South, Buffalo Grove, IL 60089

Inquiry 572.

COMPUTER INSURANCE

COMPUTERS + INSURANCE = SAFEWARE

Call toll free for information

- HOME COMPUTERS
- BUSINESS COMPUTERS
- OVERSEAS COMPUTERS
- LEASED COMPUTERS
- COMPUTERS LEASED TO OTHERS
- COMPUTERS TAKEN TO SHOWS
- COMPUTERS HELD FOR SALE
- OTHERS COMPUTERS IN YOUR CARE

SAFEWARE,

The Insurance Agency Inc.

CALL TOLL FREE 1-800-848-3469

Inquiry 573.

CROSS ASSEMBLERS

CROSS ASSEMBLERS for VAX VMS and PC/MS DOS

Faster Version 2.1 Now Available
Relocatable Macro Cross Assemblers,
Linkers, Librarians
Targeted to almost all Microprocessors

ENERTEC, INC.

BOX 1312, Lanedale, PA 19446
215-362-0966 MC/VISA

Inquiry 574.

CROSS ASSEMBLERS

CROSS ASSEMBLERS

Macro, PC Compatible, Relocatable, Conditionals, Fast, Reliable from \$150
also: Disassemblers

EPROM Programmer Board

MICROCOMPUTER TOOLS CO.

Phone (800) 443-0779

In CA (415) 825-4200

912 Williams Dr., Concord, CA 94518

Inquiry 575.

680X0 Cross Assemblers

Now, inexpensive quality 680X0 Cross Assemblers that use your IBM PC or compatible. All versions include extensive listing facilities, up to 32 char labels, sorted symbol tables, INCLUDE files, PATH names, ORG, DC, DS, EQU, many other directives (except MACRO), printed manuals. Basic versions create S-records. Listing versions create either S-records or relocatable modules, and include a linker which creates S-records or binary output files. Not only protected. Minimum requirements are 386K, DOS 2.0X, & 1.6M+ D600.

Basic: \$800/68010—\$40.95 Linking: \$600/68010—\$29.95
Basic: \$800/68010—\$149.95 Linking: \$600/68010—\$149.95

Check: VISA, MC accepted. MN residents + 6% sales tax. No PC or 680X0, please.

RAVEN Computer Systems

Box 12116, St. Paul, MN 55112 (612) 836-0365

Inquiry 576.

ASSEMBLERS & TRANSLATORS

Over 20 high quality, full function, fast relocatable and absolute macro assemblers are available immediately. Source language translators help you change microcomputers. Call for info about MS/DOS, CPM/80. ISIS versions.

RELMS™

P.O. Box 8719

San Jose, California 95150

(408) 356-1210

TWX 910-379-0014

Inquiry 577.

Disassemble MPU OBJECT CODE on your PC

Relocatable, symbolic disassemblers are now available for the Motorola, Intel, RCA, TI, Rockwell, & Zilog micros! Automatic label generation, assembly capability and much more. Call and ask for what you need.

RELMS™

P.O. Box 8719

San Jose, California 95150

(408) 356-1210

TWX 910-379-0014 (800) 448-4880

Inquiry 578.

DATA CONVERSION

MEDIA CONVERSION/DATA TRANSLATION

More than just a straight dump or ASCII transfer! Word Processing, DBMS, and Spreadsheet data on Disk or Tape transferred directly into applications running on Mainframes, Minis, Micros, Dedicated Word Processors, Typesetters, and Electronic Publishing systems. IBM PS/2 & Macintosh supported #1 in the translation industry!

CompuData Translators, Inc.

3325 Wilshire Blvd., Suite 1202, Los Angeles, CA 90010
(213) 387-4477

Inquiry 579.

DATA/DISK CONVERSION

Get the Expertise You Need

Disk/Disk • Tape/Disk • OCR

Over 1,000 formats! 3 1/2", 5 1/4", or 8 inch disks. 9 track mag tape, 10 MB Bernoulli cartridge. Data base and word processor translation. Specialists in Government Security Data. Call for free consultation.

Computer Conversions, Inc.

9580 Black Mt. Rd., Ste J, San Diego, CA 92128

(619) 693-1697

Inquiry 580.

THE BUYER'S MART

DATA/DISK CONVERSION

DISK CONVERSIONS

Media transfer to or from: IBM, Xerox, DEC, Wang, Lanier, CPT, Micom, NBI, CT, also WP, WS, MS/WRD, DW3, MM, Samna, DEC DX, MAS 11, Xerox-Writer, ASCII.

FREE TEST CONVERSION CONVERSION SPECIALISTS

531 Main St., Ste. 835, El Segundo, CA 90245
(213) 545-6551 (213) 322-6319

Inquiry 581.

DISK & TAPE CONVERSIONS AUTOMATICALLY

SAVE TIME AND MONEY

Over 1000 formats from Mini, Micro Mainframe, Word Processors, & Typewriters.

TAPE Conversions as low as \$23.00 MB

DISK Conversions as low as \$25.00 per Disk

Call or write TODAY for a cost saving quotation.

CREATIVE DATA SERVICES

1210 W. Latimer Ave., Campbell, CA 95008

(408) 866-6080

Inquiry 582.

Call Toll Free 1-800-431-2577 CONVERSIONS

Tape-to-Disk/Disk-to-Tape/Optical Scanning
Most popular 5 1/4" and 8" floppy disk formats. 9 track tape, and 1/4" tape. Almost any font or page format can be read by our scanners.

DCC DATA SERVICE

1200 18th St N.W. Ste. 704, Washington, DC 20036

D.C. (202) 482-1418 CT (203) 746-6684

Inquiry 583.

IBM PC to HP

FILE COPY

IBM PC to HP File Copy allows IBM PCs, PS/2, compatibles to read, write files written by Hewlett Packard Series 70, 80, 200, 300, 1000, 8000's. We offer custom work using our file copy utilities and program translators. Call for estimate, catalog, data sheet.

Oswego Software 312/554-3567

507 North Adams St. Fax 312/554-3573

Oswego, Illinois 60543 Telex 858-757

Inquiry 584.

CONVERSION SERVICES

Convert any 9 track magnetic tape to or from over 1000 formats including 3 1/2", 5 1/4", 8" disk formats & word processors. Disk to disk conversions also available. Call for more info. Introducing OCR Scanning Services.

Pivar Computing Services, Inc.

165 Arlington Hgts. Rd., Dept. #B

Buffalo Grove, IL 60089 (312) 459-6010

Inquiry 585.

dBASE III COMPILERS

FREE dBASE III + COMPILER DEMO DISK

Don't buy Clipper™ until you see our FREE dBASE Compiler Evaluation Kit. Includes DEMO DISK with 8 PRG's and results of compiling with Clipper, QuickLiver & FoxBASE+. Also 15 benchmark tests, complete magazine reviews, and detailed brochures about all 3 compilers. FREE. No obligation. Call 24 hours, 7 days.

dataBASE Specialties (415) 652-2790

P.O. Box 2879, Oakland, CA 94618

dBASE GRAPHICS

EASY dBASE GRAPHICS

Wary of complicated graphing programs?

Announcing dPICT.

dPICT is expressly designed to be easy to use. Type two words; in three minutes you see four presentations of your dBASE data.

Pick one. That's all. \$49.95

Requires IBM PC or compatible

Paragon Tech

1581 Garland Ave., Tustin, CA 92680

Inquiry 586.

DEMOS/TUTORIALS

INSTANT REPLAY III

Build Demos, Tutorials, Prototypes, Presentations, Music, Timed Keyboard Macros, and Menu Systems. Includes Screen Maker, Keystroke/Time Editor, Program Memorizer, and Animator. Rec'd Great Reviews! Simplest the BEST. Not copy protected. No royalties. 60 day satisfaction money back guar. IBM and Compat. \$149.95 U.S. Chk/Cr. Crd. Demo Diskette \$5.00

NOSTRADAMUS, INC.

3191 South Valley Street (ste 252)

Salt Lake City, Utah 84109 (801) 487-9662

Inquiry 587.

DESKTOP PUBLISHING

Professional Type Composition

MP-XL—Hard-core typography and Typefonts for the HP LaserJet II, Okidata LaserLine 6, or Ricoh PC 6000 Laser Printers. H&J, Indents, Tabs, Graphics, 1/4 pt. leading, random mix of size & face, 6-72 pt. fonts. MP-XL complete with 22 fonts, PI + Bkmm 6-24 pt. \$195. M/C VISA. Many additional type faces available 6-30 pt.

Micro Print-X, Inc.

P.O. Box 581, Ballinger, TX 76821

(915) 368-2343

Inquiry 588.

DISK DRIVES

PS/2 DRIVES FOR PC's AT's

CompatiKII/PC \$329

CompatiKII/AT \$300

Built-in floppy controllers—no problem. Supports multiple drives and formats. Lets your computer use IBM PS/2 1.4M diskettes plus more! Call for further information or to place an order. VISA/MC/COD/CHECK

Micro Solutions Computer Products

132 W. Lincoln Hwy., DeKalb, IL 60115 815/758-3411

Inquiry 589.

DISKETTES

DISKETTES ALL BRANDS

Xidex DS/DD Bulk 5 1/4" w/Tyvek35

3M DS/DD/RH Boxed 5 1/4"70

CompuDisk DS/DD Boxed 5 1/4"40

Ashlon Tate Degaused 5 1/4"25

Fuji DS/DD Bulk 3 1/2" 1.00

Xidex HD Boxed 5 1/4" 1.00

We carry Sony & Maxell

1-800-544-0141

CompuTech Products Inc.

10085-B Sandmeyer La., Philadelphia, PA 19116

Inquiry 590.

5 1/4" DISKS 23.9¢

MINIMUM QUANTITY 1000 Pcs.

3 1/2" DISKS \$80 per 100

Lowest Advertised Price in the Solar System!

5 1/4" DS/DD premium quality diskettes. These are un-aided, previously programmed, factory erased diskettes. Guaranteed replacement. SLEEVES AND LABELS INCLUDED.

Doublers: Call for FREE Sample. \$239.00 per 1,000

Large Qty. Prices Available. Sold in 1,000 increments.

Customer pays all shipping charges. Send check or money order to:

ELECTRONIC LIQUIDATORS

P.O. Box 1352, Melrose, MA 02176 (617) 862-9363

Inquiry 591.

DUPLICATION SERVICES

SOFTWARE DUPLICATION

- One Stop Shopping
- Custom Packaging
- Copy Protection
- Technical Support
- Drop Shipping
- Fast Turnaround
- Competitive Pricing

SATISFACTION GUARANTEED

800-222-0490 NJ 201-462-7628

MEGASoft

P.O. Box 710, Freshkill, NJ 07728 See our ad on page 282

Inquiry 592.

SOFTWARE PRODUCTION

- Disk duplication
- All formats
- EVERLOCK copy protection
- Label/sleeve printing
- Full packaging services
- Warehousing
- Drop shipping
- Fulfillment
- 48-hour delivery
- Consultation & guidance

Star-Byte, Inc.

713 W. Main St., Lansdale, PA 19448

215-368-1200 800-243-1515

Inquiry 593.

FRAMEWORK II USERS

FRAMEWORK II FRED DICTIONARY

Automatic functions dictionary.

—immediate access to a full screen function reference.

Development tools, menus, FW tips, books info., more

Built-in automatic database filtering/menu

Programs disk + manual booklet \$39.95 inc. sht.

3.5" add \$2.00. req. "FRAMEWORK II"

Not FW serial # copy protected. Send check or money order to

M. FRANKEL

189 FRANKLIN St., NY, NY 10013

Inquiry 594.

FLOWCHARTS

FLOW CHARTING II+ HELPS YOU!

Precise flowcharting is fast and simple with Flow Charting II+.

Draw, edit and print perfect charts: bold and normal fonts, 24 shapes — 95 sizes; fast entry of arrows, bypasses & connectors.

Fast Insert Line. shrink screen displays 200-column chart, 40 column edit screen for detail work, much more!

PATTON & PATTON

81 Great Oaks Blvd., San Jose, CA 95119

1-800/672-3470, ext. 897 (CA residents)

1-800/538-8157, ext. 897 (Outside CA)

408/629-5044 (Outside the U.S.A.)

Inquiry 595.

HARDWARE

DISCOUNT CLONES

• XT Turbo — \$435.

• AT 8/10 MHz — \$885.

• Seagate ST225 20MB hard drive with controller — \$388.

• 386 25MHz — \$2,880.

• Hayes compatible 1200 baud modem — \$88.

• Evermax EGA — \$198.

• HP Laser Jet Series II — \$1795.

Automated Business Solutions

516-379-3985

30 day money back guarantee • 1 yr parts & labor warranty

Dealer Inquiries Invited. Please call for complete price list.

Inquiry 596.

DIGITAL SIGNAL PROCESSOR

The Model 10 for the IBM PC/XT/AT is based on the TI TMS32010 and is designed for applications in communications, instrumentation, speech, and numeric processing. A 1K complex FFT takes 90 ms. Offered with 12 bit 80 KHz A/D and D/A and continuous data acquisition & playback option. \$650 and up.

DALANCO SPRY

Suite 241, 2900 Connecticut Ave, NW,

Washington DC 20008

(202) 232-7899

Inquiry 597.

THE BUYER'S MART

HARDWARE

CHIP CHECKER

• 74/54 TTL • CMOS • 8000 Nat. • Signetics
• 14/4000 CMOS • 9000 TTL
• 14-24 Pin Chips • 3" • .8" IC widths
Tests/identifies over 650 digital chips with ANY type of output in seconds. Also tests popular RAM chips. IBM compatible version \$259. C128 • C64 version \$159

DUNE SYSTEMS

2803 Wills Dr., St. Joseph, MI 49085

(616) 883-2352

Inquiry 598.

HARDWARE

SANYO 550/555 USERS

3.67 2MHz TURBO BD. W/8068-2 \$79.95
IBM STYLE CGA VIDEO BD. \$199.95
IBM STYLE RS-232 \$79.95
SANYO RS-232 \$49.95
768K MEMCLK/EXPANSION BD. \$249.95
20 MEG HARD DISK SYSTEM \$599.95
COMPOSITE MONO MONITOR \$199.95
550 COMMUNICATIONS SOFTWARE \$49.95

TAMPA BAY DIGITAL

1750 Drew St., Clearwater, FL 34615

*** FREE CATALOG *** 813-443-7049

Inquiry 604.

HUMOR

BIT O' HUMOR JOKES ON DISKETTE

Over a thousand great jokes, limericks, puns and fortune cookies on diskette for your MS-DOS computer. LAN compatible. Fire up your office machines every morning with refreshing humor. Advanced software features timing delays, custom joke database and category selection. \$24.95 includes program. Specify 5.25" or 3.5" diskette.

PLEASURE INTERFACE

P.O. Box 391471, Mountain View, CA 94039

Inquiry 610.

INDUSTRIAL STRENGTH SINGLE BOARD COMPUTER

Has optimum features for monitor + control applications. 16 Chan A/D • 4 RS232/422 Ports • 48 Prog I/O Lines • 8 Opto I/Os • 8 HiDrive O/UTs • 4 Timers • Watchdog • 104K Memory • 5.25 x 8.0 Options. Resident FORTH OS with Target Compiler, Editor, Assembler. • Auto Load/Start; 5 MHz 8085 • 4 Chan D/A • Battery Backed Clock/RAM • Networking • PC Support.

E-PAC 1000 + \$249.00 E-PAC 2000 + \$449.00

EMAC INC.

P.O. Box 2042, Carbonate IL 62902 (818) 529-4825

Inquiry 599.

GREAT PRICES!

Brand new Laser Sanyo (formerly Emerson) Color Graphics Terminals at close-out prices. Includes 30-day warranty.

* 16 colors from 4096 palette
* 640 x 480 resolution
* DEC VT100/ANSI X3.64 compatible
* Tektronix 4010/4014/Plot 10 compatible

\$695 (Model 7107)

Call 714-974-4113 or write: Wells Data Systems, 2461 E. Orangeflor Ave., Fullerton, CA 92631. In Canada, call 1-800-387-9637.

Inquiry 605.

INFORMATION

The Tables of ERP

The "Economic Report of the President" has concise tables of the major economic indicators (GNP, Employment, Inflation, Population and much more.) The Tables of the 1988 Report are now available on disk in (CAL, WKS, CSV, or TXT) formats for (PC or MAC or most CP/M)—\$29.95

FAIRFACTS

Box 538, San Rafael, CA 94915

Inquiry 611.

FREE CATALOG

Protect your computer power from black-outs, brown-outs, audio/video hash and surge! Complete line of low cost Emergency Power Supply units, Line Conditioners and Surge Suppressors prevent damage and loss of valuable data. Prevent errors, malfunctions and false printouts! Send for money saving catalog today.

INDUS-TOOL

730 W. Lake St., Chicago, IL 60606

Phone 312-648-2191

Inquiry 600.

HARDWARE/ADD-ONS

Z80 / HD64180/CP/M™ CO-PROCESSORS

Plug-in co-processors for PC, PC/AT.

Blue Thunder Z80 co-processors
8 MHz \$249.95 10 MHz \$399.95
12.5 MHz \$599.95

HD64180 co-processors \$295 and up
All co-processors with CP/M emulator. Software only emulator Z8IM only \$99.95.

Z-WORLD 916-753-3722

1772A Picasso Ave., Davis, CA 95616

See our ad on page 299.

Inquiry 606.

87C51 PROG. \$125.00

The UPA 87C51 Programming Adapter lets you use your general purpose programmer to program the 87C51, 8751H, AMD8753H, 87C252, and 8752BH. Also lets you program the 87C51/8751H security bits and the 87C51 encryption array. It's very simple and VERY cost effective.

LOGICAL SYSTEMS CORPORATION

6184 Teal Station, Syracuse NY 13217

(315) 478-0722 Telex 8718817 LOGS

Inquiry 601.

HARDWARE/COPROCESSOR

AT/FORCE RISC SYSTEM

Replace Bit-Slice Technology

5-MIPS IBM/AT coprocessor and software system with new Force Core from Harris Semiconductor. Forth Optimized RISC Engine Core Set comprises 6 HCMOS standard cell chips: Core, Interrupt Controller, 1-cycle Multiplier, and 2 Stack Controllers. Forth development language included. \$499.95.

SILICON COMPOSERS (415) 322-8763

210 California Ave., Suite K, Palo Alto, CA 94306

Inquiry 607.

NorthStar

Sales and service. NorthTech Specializes in Horizon and Advantage hardware/software/support. Largest full service distributor of NorthStar products in United States. We buy-sell-trade NorthStar products and peripherals. • complete repair facilities • tech support and training • all hardware and software in stock • same day service available • ten years of customer satisfaction

NorthTech Support Services, Inc.

Oberlin, Ohio / Arlington, Virginia

1-800-426-7898 216-775-0529

Inquiry 602.

PC MINI-SUPERCOMPUTER

Up to 40 MIPS in Your PC!

Fill your PC/XT/AT with 1 to 6 PC4000 boards for a high speed PC-RISC system. The PC4000 uses the NC4016 RISC Engine which executes high level Forth in silicon. Each PC4000 is a general purpose parallel coprocessor that delivers speeds in the 5 to 7 MIPS range over a 100 times faster than a PC. uses Forth, C or Assembler. From \$1295.

SILICON COMPOSERS (415) 322-8763

210 California Ave., Suite K, Palo Alto, CA 94306

Inquiry 608.

LEGAL

DESIGNED FOR LEGAL WORK

The SoftWare™ Substantive System. "This could save a law office 30% — 45% of the time to process pleadings." *Brief*, 9/87. Version 3.3 \$159. Free brochure.

TSC

The Software Company

P.O. Box 872687, Washita, AK 99687

(907) 745-6267

Inquiry 614.

NEW/USED APPLES & STUFF

MACINTOSH — Call
Apple Parts — Call
Mac accessories—hard drives Call
We buy, sell & horse-trade — Apple, IBM.

SHREVE SYSTEMS

2421 Malcom St., Shreveport, LA 71108

318-855-8743 4-9 p.m. • FAX-318-865-2006

International inquiries welcome C.S.T.—VISA/MC

Inquiry 603.

HRDWR./POWER PROTECT

PC D/A CONVERTER

16 CHANNEL 12 BIT RESOLUTION

16 Analog outputs on a short slot configured IBM PC I/O card. Output ranges: +5, 10 +/2.5, 5 and 10V. Accuracy: +/- 2.5 mV. Price: \$350 Delivery: Stock

ULTRALINK

P.O. Box 1809, Minden NV 89423

1-800-852-8273 702-782-9758

Inquiry 609.

MAILING LIST PROGRAMS

COMPUTERIZED ZIPCODE DIRECTORY

ZIPLIST Data file of USPS zip codes. Includes city, state and county information.
Two Sizes: \$1,000 zipcode—\$195.00 90,000 records—\$248.00
Speed Data entry. Vary up codes. Compatible with most database software. On disk or tape.
ASSIGN-A-ZIP 5-digit zip assignment by street address.
CLEAN-A-LIST Editing software for existing mailing lists.

DCC DATA SERVICE

1200 16th St. N.W., Ste 704

Washington, DC 20036

(202) 452-1419 1-800-431-2577

Inquiry 615.

THE BUYER'S MART

MEMORY CHIPS

MEMORY CHIPS

41258-19-12-10 Call 51000 (1 Meg) Call
 4184-15 Call 51258 for Compaq 386 6.43
 4184-12 Call 8087-3-2 86/143
 41128 Piggy Back for AT 3.89 80287-6-8-10 155/233/280
 41484-12 (84Kx4) 3.37 80387
 414256 (256Kx4) Call NEC-V-80-8 Call
 2764,27128,27256,27512 Call Mouse \$49
 Prices subject to change

ESSKAY 1-800-327-3237
 718-353-3353

Inquiry 616.

MISCELLANEOUS

WHY PAY RETAIL PRICES?

Why spend your precious time searching the stores/catalogs for the computer/office equipment/supplies you want? Through our program you can save time and obtain name brand items at low prices. Free trial membership! For more information:

THE ULTIMATE BUYER'S SOURCE
 308 Crocker #46941-A Mt. Clemens, MI 48048
 1-800-327-4226

Inquiry 617.

NEURAL NETWORKS

Neural Net + Compiler

Networkz demos neural net finding nearest match of input word to list of words. PL/D compiles Networkz and itself for retarget to new CPUs. Three manuals total 150 pages. All source. Need PC/XT/AT w 256KB. October 1987 issue of BYTE, page 46, has more info.

Networkz: 79.95 PL/D: 124.95 Both: \$154.95
DAIR Computer Systems
 3440 Kenneth Dr. Palo Alto, CA 94303
 (415) 494-7081

Inquiry 618.

OPTICAL SCANNING

STOP TYPING!

OCR SERVICE BUREAU — We Scan EVERYTHING
 Previously Printed Material
 • Invoices • Books • Documents • Phone Bills
 • Output to • 3 1/2" • 5 1/4" • 8 1/2" • MAC •
 1800 BPI • WORM • CD ROM
 We Convert EVERYTHING.
 All Word Processing and Data Bases Supported.
 Kurzweil & Peltair Scanning
 Phototypesetting & Printing • Day & Night Service
DATASCAN
 1 World Trade Ctr., New York, NY 10048 (212) 838-5727

Inquiry 619.

PROGRAMMER'S TOOLS

Affordable CASE

A new concept in Computer Aided Engineering for developing PC/DOS applications! C Dispatcher generates fast, efficient C code for command and menu driven applications. Develop, document, and change easily. Many features. For many compilers.

Amaryllis Inc.

583 Watuquacod Rd., Bolton, MA 01740
 (617) 365-5456

Inquiry 620.

FINITE STATE COMPILERS

Software designed as Finite State Programs develop quicker, run faster and use less memory than sequentially coded programs. Our Editor forms state tables, the Compilers state programs in: ADA, BASIC, C, FORTRAN & PASCAL.

\$100 Editor (With primer) \$75 per Compiler
 IBM PC 128K RAM Dos 2.0+

AYECO 5025 Nassau Circle, Orlando
 INCORPORATED FL 32808 (305) 295-0930

Inquiry 621.

PROGRAMMER'S TOOLS

TLIB™ 4.0 Version Control

The best gets better! They loved TLIB 3.0. "packed with features... [does deltas] amazingly fast... excellent"—PC Tech Journal Sept 87. "has my highest recommendation"—R. Richardson, Computer Shopper Aug 87. Now TLIB 4.0 has: branching, more keywords, wildcards & file lists, revision merge, LAN and WORM drive support, more. MS/PC-DOS 2.x & 3.x \$99.95 + \$3 s&h Visa/MC

BURTON SYSTEMS SOFTWARE

P.O. Box 4156 Cary, NC 27519 (919) 469-3068

Inquiry 622.

AMADEUS AND MODULA-2

For better programming Modula-2
 Amadeus is a complete and powerful environment for developing applications in M2 (Logitech) on PCs. Amadeus includes an application editor with macrocode generator and a run-time support composed of 25 modules which supply windowing, ISAM database, improved interface for Btrieve, manual creation, full I/O procedures, special support of the HP-Vectors (touch screen...), and much more. Developers: Amadeus will increase your efficiency. Ease of use of dedicated database programs with the power of M2 programming was the aim. With complete manual. Only \$349! Free demo disk available.

ID NOUVELLES SA

CP 877, 1061 LAUSANNE, SWITZERLAND

Inquiry 623.

Modula-2

Repertoire, now at rel 1.5, is the largest and most widely used M2 library in the world. Includes extensive low-level, user interface, and ultra-sophisticated database tools suitable for use with bitmaps, text, lists, structured records, etc. Only \$89. From the creators of ModBase, EmsStorage, and Graphix. Complete manuals for all products available on free demo disks. MCV/ISA/AMEXP/COOD.

PMI 4536 SE 50th, Portland, OR 97206
 (503) 777-8844; BUX: pmi

Inquiry 624.

PUBLIC DOMAIN

\$3.00 SOFTWARE FOR IBM PC

Hundreds to choose from, wordprocessors, databases, spreadsheets, games, x-rated, lotto, communications, business, music, bible, art, education, language and useful utilities for making your computer easier to learn. Most programs have documentation to the disk.

Write for your FREE catalog today!

BEST BITS & BYTES

P.O. Box 8245, Dept-B, Van Nuys, CA 91409
 (818) 781-9975

Inquiry 625.

RENT SOFTWARE \$1/DISK

Rent Public Domain and User Supported Software for \$1 per diskfull or we'll copy IBM (3 1/2" also), Apple, C-64, Sanyo 550 and Mac. Sampler \$3. VISA/MC. 24 hr. info/order line. (619) 941-3244 or send #10 SASE (specify computer) Money Back Guarantee!

FutureSystems

Box 3040 (T), Vista, CA 92083
 office: 10-6 PST Mon.-Sat. (619) 941-8761

Inquiry 626.

QUALITY SOFTWARE IBM/COMPATIBLES

Get a Word Processor, Spreadsheet, Database, Money Manager and 5 arcade games plus our 10,000 program catalog for ONLY \$10.00 (+ s/h)

800-992-1992 (National)

800-992-1993 (Ca only)

819-942-9998 (Foreign)

VISA, MC, AMEX Accepted (COD + 1.90)

The International Software Library

511-104 Encinitas Blvd., Encinitas, CA 92024

Inquiry 627.

PUBLIC DOMAIN

FREE SOFTWARE

The PUBLIC DOMAIN USERS GROUP provides public domain software for IBM, CP/M, C64 & C-128 computers. PDUG is one of the oldest (est. 1982) & largest (over 10,000 members worldwide) users groups.
 SPECIAL OFFER—Send \$10 and receive not only our 1 year membership but also our new member disk free (contains 21 great programs) Or for more info send a SASE (specify computer) to

PUBLIC DOMAIN USERS GROUP

P.O. Box 1442-BM, Orangepark FL 32067
 904-284-3512 (ORDER LINE)

Inquiry 628.

SECURITY

BIT-LOCK® SECURITY

Piracy SURVIVAL 5 YEARS proves effectiveness of powerful multilayered security. Rapid decryption algorithms. Reliable/small port transparent security device. PARALLEL or SERIAL port. Countdown and timeout options also available. KEY-LOK™ security at about 1/2 BIT-LOCK cost.

MICROCOMPUTER APPLICATIONS

7805 S. Windemere Circle, Littleton, CO 80120
 (303) 922-8410 or 798-7883

Inquiry 629.

SOFTWARE/ACCOUNTING

dBASE BUSINESS TOOLS

- General Ledger
- Accounts Recvbl.
- Order Entry
- Sales Analysis
- Purch Ord/Inventory
- Accounts Payable
- Job Costing
- Estimating

\$99 EA. + s&h w/dBASE 2, 3 or 3+ SOURCE CODE

DATAMAR SYSTEMS™ Cr. Crd/Chtw/COD

4876-B Santa Monica Ave.
 San Diego, CA 92107 (619) 223-3344

Inquiry 630.

SOFTWARE/A.I.

Learn AI Fast

If/then™ is a book and a disk of Lotus spreadsheets "A marvelous little AI training package... you'll find it an excellent tutorial... this product is a must!"

Extra Shapiro, BYTE, Aug. '87, p.283

If/then is only \$89.95

If/then Solutions

1 Mallorca Way, #301B SF, CA 94123 415-346-8888
 Lotus 1-2-3 rel 2 required. \$3 for shipping in A. \$6 elsewhere

Inquiry 631.

SOFTWARE/ARCHITECTURE

NATURAL 3-D NAVIGATION

3 Vanishing Points Navigator: Great help for artists & architects. Navigator provides rapid moving natural views and the capability for unusual slanted rotation. The perspective can also be suppressed or enhanced \$449.95 + \$4.00 S&H (may change without notice.)

◆ Require IBM PC or compatible (256K up)

Demo-disk \$7.00 + \$1.00 S&H (Version 2.0)

bp-Coding Systems, Inc.

2445 University Heights Ave., Boulder, CO 80302
 telephone (303) 449-3640 • facsimile (303) 442-1967

Inquiry 632.

SOFTWARE/BASIC

XGRAF DRAWS IN BASIC!

FINALLY XGRAF replaces QuickBASIC's poor drawing commands with assembly language calls that work on Hercules, EGA, VGA, CGA and EEGA screens. Only \$99.00 + \$4.00 S&H. Call us at 1-800-423-3400 (9:00 AM to 8:00 PM EST)

KOMPUTERWERK, INC.

851 Parkview Blvd., Pittsburgh, PA 15215
 For info., call (412) 782-0384

Inquiry 633.

THE BUYER'S MART

SOFTWARE/BUSINESS

DATA ENTRY SYSTEM

Head-down data entry with two-pass verification for the PC/XT/AT & compatibles. Loaded with features like: Auto dup & skip, verify bypass, range checks, & table lookups. Fully menu driven only \$395. Call for free 30 day trial period.

COMPUTER KEYS

21929 Makah Rd., Woodway, WA 98020
(206) 778-6443

Inquiry 634.

TSAS8-TRANSPORTATION

A general purpose system for solving transportation, assignment and transshipment problems. Solves transportation problems with up to 510 origins and/or destinations by applying the Transportation Simplex Algorithm. Menu-driven with features similar to LP88. Requires 192K. \$149 with 8087 support user's guide. VISA/MC.

EASTERN SOFTWARE PRODUCTS, INC.

P.O. Box 15328, Alexandria, VA 22309
(703) 360-7600

Inquiry 635.

dfELLER Inventory

Business inventory programs written in modifiable dBASE source code.

dfELLER Inventory \$199.00

Requires dBASE II or III, PC-DOS/CPM

dfELLER Plus \$200.00

with History and Purchase Orders

Requires dBASE III or dBASE III Plus (For Stockrooms)

Feller Associates

550 CR PPA, Route 3, Ishpeming, MI 49849
(806) 496-8024

Inquiry 636.

SOFTWARE/CHURCH

PowerChurch Plus®

Fast, friendly, reliable church administration system. Full fund accounting, mailing lists, membership, contributions, attendance, word processing, accts payable, payroll, multi-user support, and much more - all for \$695 complete. FREE demo version.

F1 SOFTWARE

P.O. Box 3096, Beverly Hills, CA 90212
(213) 854-0865

Inquiry 637.

ROMAR CHURCH SYSTEMS™

Membership-61 fields plus alternate addresses, letters, reports any field(s). Offering-256 funds, optional pledge, statements, post to 256/yr. Finance-gen ledger w/budget, up to 500 subtotals & 99 depts., month & YTD reports anytime for any month. Attendance-8 service times, 250 events per service, 60 consecutive weeks. Available for floppy, 3 1/2" & hard disk. Ad too short? Write for free 48-page guide.

Romar Church Systems, Attn: BJB

P.O. Box 4211, Elkhart, IN 46514
(219) 262-2188

Inquiry 638.

SOFTWARE/CREDIT

CREDIT REPAIR SYSTEMS Software

Now you can clean up your credit for a fraction of the cost with no hassles or problems from a credit repair agency.

For IBM PC/XT/AT or compatibles

For free information write:

C-SYSTEMS

P.O. Box 77399, Colorado Springs, CO 80907

Inquiry 639.

SOFTWARE/DISK LABELING

SOFTWARE/DISK LABELING

"Diskette Labeler"

Makes professional labels for 5.25" disks on your printer with combination of 23 character Title, 120 File Names, 10 lines of 80 character Comments, and complete Stats. Includes permanent adhesive. For IBM & compatibles with IBM/Epson compatible dot matrix printer. \$49 + \$4 s/h.

WeedPatch Productions, Inc.

Box 716, Hockessin, DE 19707
(800) 451-0474 (302) 239-9266

Inquiry 640.

SOFTWARE/ENGINEERING

Affordable Engineering Software

FREE APPLICATION GUIDE & CATALOG

Circuit Analysis • Root Locus • Thermal Analysis • Plotter Drivers • Engineering Graphics • Signal Processing • Active/Passive Filter Design • Transfer Function/FFT Analysis • Logic Simulation • Micro-strip Design • PC/MSDOS • Macintosh • VISA/MC Accepted

BV Engineering • (714) 781-0252

2023 Chicago Ave., Unit B-13, Riverside, CA 93111

Inquiry 641.

OPTIMIZATION WITH MICRO-DOT

Micro-Dot is an efficient, nonlinear, constrained optimizer for engineering design. Written in FORTRAN. Micro-Dot is a general purpose program that can be used interactively or linked with user supplied programs to solve a wide range of design, analysis and management problems. Demonstration Diskette \$15, applicable towards purchase. VISA/MC/Check.

Engineering Design Optimization, Inc.

1275 Camino Rio Verde, Santa Barbara, CA 93111
(805) 967-0058

Inquiry 642.

PROFESSIONAL SOLUTIONS

FOR PCs and MS-DOS

DEFLECTION OF BEAMS OF UNIFORM OR VARIABLE CROSS SECTION (not an FE-program). Statistically determine problems & continuous beams. SIMPLE OR MULTIPLE SHRINK-FITS. Shrinkage pressures, stresses, torsional holding ability etc. HERTZ. Pressure between bodies.

MICROMIN® — Software

Don Stauner, P.O. Box 344, Merriford, OK 74044
Recorded Message: (800) 336-2072, ext. 5776

Inquiry 643.

SIMULATION WITH GPSS/PC®

GPSS/PC® is an IBM personal computer implementation of the popular mainframe simulation language GPSS. Graphics, animation and an extremely interactive environment allow a totally new view of your simulations. Simulate complex real-world systems with the most interactive and visual yet economical simulation software.

MINUTEMAN Software

P.O. Box 1717Y, Stow, Massachusetts, U.S.A.
(617) 897-5662 ext. 540 (800) 223-1430 ext. 540

Inquiry 644.

Circuit Analysis — SPICE

Non-linear DC & Transient; Linear AC.
• Version 3B1 with BSIM, GaAs, JFET, MOSFET, BJT, diode, etc. models, screen graphics, improved speed and convergence.
• PC Version 2G8 available at \$95.
Call, write, or check inquiry # for more info.

Northern Valley Software

28327 Restrock Dr., Rancho Palos Verdes, CA 90274
(213) 641-3677

Inquiry 645.

SOFTWARE/ENGINEERING

HIGH PERFORMANCE & LOW COST

Practical engineering analysis software for IBM PC & compatibles.

Features/Capabilities:

Linear/Nonlinear static & dynamic analysis for 3D structures. • Interactive and pre- & post-processing
• Interactive graphics • Easy to use •

Peas Engineering Consultants Inc.

P.O. Box 94-121, Taipei, Taiwan ROC

Inquiry 646.

FREE ENGINEERING MAGAZINE

Personal Engineering is a monthly magazine sent free of charge (USA only) to scientists/engineers who use PCs for technical applications. Topics each month include Instrumentation • Data Acq/Control • Design Automation. To receive a free sample issue and qualification form either circle below or send request on letterhead to:

Personal Engineering Communications

Box 1621, Brookline, MA 02146

Inquiry 647.

HI-RES GRAPHS & STATS

Join scientific, educational, research & engineering institutions across the country analyzing data provided by user-friendly packages:

ENGINEERING TOOL KIT • STATS TOOL KIT
PROCESS CONTROL CHART TOOL KIT
BIOMEDICAL RESEARCH CHART TOOL KIT

IBM/Macintosh \$99-\$129 ea.

SOFT-WARE TOOLS

P.O. BOX 8751, BOISE, IDAHO 83707

(208) 343-1437

Inquiry 648.

CIRCUIT ANALYSIS FOR WORKSTATIONS

ECA-2, an advanced analog circuit simulator, now available for Apollo workstations, includes:

- AC, DC, Transient, Fourier analysis
- Worst Case, Monte-Carlo, nonlinear simulation.
- Larger circuits, faster simulations than SPICE.

ECA-2 Apollo \$3,000. Apollo Eval Kit \$380.

ECA-2 IBM PC/XT/AT \$675. PC Eval Kit \$95.

Call 313-663-8810 for DEMO.

Tatum Labs, Inc.

1478 Mark Twain Ct., Ann Arbor, MI 48103

Inquiry 649.

SOFTWARE/GENERAL

WOULD YOU LIKE TO KNOW?

Your I.Q.? Memory Level? Response Time?

Coordination? Visual Perception?

Expand your mind with MENTOR™—software that lets you explore your hidden talents. 58 psychometric exercises, incl. 25 I.Q. tests. IBM PC/Compatible • 256K • CGA/EGA/VGA • \$49.95 • VISA/MC
No shipping charge to anywhere in the world

Heuristic Research, Inc.

3112-A West Cumbert Ave., Midland, TX 79701
800-443-7380 (in TX, collect 815-694-5836)

Inquiry 650.

SOFTWARE/GEOLOGICAL

FREE CATALOG!

Geological and scientific software for all applications: log plotting, gridding/contouring, hydrology, digitizing, 3-D solid modelling, synthetic seismogram, fracture analysis, image processing, scout ticket manager, over 60 programs in catalog. Macintosh tool.

RockWare, Inc.

7185 W. 30th Ave., Denver, CO 80215 USA
(303) 238-8113

Inquiry 651.

THE BUYER'S MART

SOFTWARE/GRAPHICS

PC TECHNICAL GRAPHICS

TEKMAR is a graphics library for the EGA or Tecmar Graphics Master. Similar to PLOT-10, includes WINDOW, VIEWPORT, AXIS. Support for HP, Hi plotters. Curve fitting, complete plotting program. Log, semi-log, multi-axis, 3-D, contours. Jerry Pournelle (Aug 86 Byte). "As good as any I have ever seen..." Demo disks, literature available.

Advanced Systems Consultants
21115 Devonshire St., #329, Chatsworth, CA 91311
(818) 407-1059

Inquiry 652.

POPULAR HGRAPH™

SCIENTIFIC 2D & 3D graphic routines for IBM PC and VAX. Powerful, easy to use. Multiple fonts, device and machine independence. Uses max resolution. Links with FORTRAN, Pascal, Turbo Pascal, Logitech Module-2.

\$79.00 Custom software development
Graphics editor available soon.

HeartLand Software, Inc.
234 S. Franklin, Ames, IA 50010
(515) 292-8216

Inquiry 653.

FLOT PEN PLOTTER EMULATOR

Use your dot matrix or laser printer as an HP pen plotter. Fast hi-res output. Vary line width. Includes VPLOT virtual plotter utility to capture plotting commands. Supports NEC PS/P6, IBM Proprinter, Epson LQ/MX/PX, HP Laserjet. Uses Hercules, CGA, EGA or VGA for screen preview. \$64 check or m.o.

HORIZON SOFTWARE

Suite 805, 24-18 Steinway St., Astoria, NY 11103
212-418-8469

Inquiry 654.

GRAPHICS PRINTER SUPPORT

AT LAST! Use the PrtSc key to make quality scaled B&W or color reproductions of your display on any dot matrix, inkjet, or laser printer. GRAFPLUS supports all versions of PC or MS-DOS with IBM (incl. EGA, VGA), Techar, and Hercules graphics boards \$49.95.

Jewell Technologies, Inc.
4740 44th Ave. SW, Seattle, WA 98116
800-628-2828 x 527(206) 937-1081

Inquiry 655.

FORTRAN PROGRAMMER?

Now you can call 2-D and 3-D graphics routines within your FORTRAN program.

GRAFOMATIC: 75 callable routines for screen output. \$135.
PLOTOMATIC: Pen plotter driver. \$135.
For the IBM PC, XT, AT and compatibles. We support a variety of compilers, graphics boards and plotters.

MICROCOMPATIBLES
301 Prelude Drive, Dept. B
Silver Spring, MD 20901
(301) 593-0883

Inquiry 656.

CGA → Hercules™ Graphics

Mode-BGA™ allows you to use business graphics, games, BASIC graphics and other CGA specific software with your Hercules™ Monochrome Graphics adaptor and monochrome monitor. Works with all CGA programs. \$79.95 (+ \$5 s&h) for the 3k-TSR version. 30-day money back guarantee. Call or write:

T.B.S.P. Inc.
2205 Westwood Blvd., Suite 793, Los Angeles, CA 90064
(213) 312-0154

Inquiry 657.

SOFTWARE/LANGUAGES

SERIES 32000 MODULA-2 COMPILER

National Semiconductor's 32000 family of microprocessors and Modula-2 have common characteristics that make them the ideal combination for virtually any embedded microprocessor system. Both are well designed and easy to use. The Modula-2 compiler helps you develop and maintain your software in a fraction of the time spent writing programs in Assembler, C, or ADA. Includes EDITOR, COMPILER, LINKER, DECODER and MAKE UTILITY. With Modula-2 you can create your own software module libraries—all in source form, including the target runtime support module. Low-cost compiler board for IBM PC/XT/AT bus \$750
High performance compiler board for IBM PC/XT/AT bus \$1085
High performance compiler board for Micro Channel bus \$1085

ALOIS SCHONBACHLER
Frieschurzgasse 14, CH-8004 Zurich, Switzerland
41-1-241-0514

Inquiry 658.

THE PL/M CONNECTION

- Your link to the IBM PC from PL/M 86
- Write programs—Create utilities
- Build application systems
- Complete system interface libraries
- Dos 1, Dos 2, Dos 3, Bios, Graphics
- Large and compact memory modules
- 200 page Technical Reference Manual
- Complete source in PL/M 86 and Assembler
- Demonstration utilities with source

CompuFirm Corporation
7941 Balboa Ave., Ste 210, San Diego, CA
(619) 571-0228

Inquiry 659.

DRUMA FORTH-83

Strict '83 STANDARD. Developed for in house use. No 64K limitation. 64K speed & compactness to 320K.

- IBM PC/XT/AT & compatibles, DOS 2.0+
- ROM: Headerless code, separated variables
- Editor, assembler, file & DOS interfaces
- Many powerful and innovative features
- Full Pkg \$79, Demo \$18, S&H \$2, VISA/MC

DRUMA FORTH-83, DRUMA INC.
P.O. Box 610097, Austin, TX 78761
Orders: 512-323-0403 BBoard: 512-323-2402

Inquiry 660.

Prospero Software of London, England is now

in the U.S. to serve your programming needs. To introduce our products, we have an introductory offer for the following products:

Pro-Fortran-77 reg. \$390.00 special \$199.00
Pro Pascal reg. \$390.00 special \$199.00

Both products are ANSI and internationally validated for MS-DOS machines.

To order, call 1-800-327-8730 (VISA/MC) or mail your check for \$199.00 plus \$5.00 shipping to:

Prospero Software, Inc.
100 Commercial St., Suite 306, Portland, ME 04101

Inquiry 661.

MULTI-USER DEVELOPMENT PLATFORM

Gain the 80386 edge for your applications with THEOS C, an advanced compiler for the new THEOS 386 multi-user, multitasking operating system. Meets ANSI C standard, plus offers the power of 250 additional functions for VDI graphics, real-time processing and file access. Provides UNIX and DOS source code compatibility. Breaks 64K limitation. Two-volume manual set. BASIC Language package also available. For complete multi-user solutions, call us today.

THEOS Software Corp.
1777 Bethel Dr., Suite 360, Walnut Creek, CA 94596
(415) 935-1118 FAX (415) 935-1177

Inquiry 662.

SOFTWARE/LASER FONTS

LaserJet Fonts

FASTfont downloads 10 times faster — EASY! MS-DOS program to select (by title) & group fonts. Download immediately or in groups. Any fonts work. FASTfont — \$79. Also BIGfont — 8 fonts in sizes from 10 pts. to 158 pts. (2 inches) — print from any word processor — easy commands. \$159. 30 day \$5 back.

Worthington Data Solutions
417A Ingalls St., Santa Cruz, CA 95060
(800) 345-4220 In CA: (408) 458-9938
See our ad on page 42

SOFTWARE/LOANS

Execamort™ Amortizer +

Loan Amortization reports—simple or complex, extra payments, points/fees, APR's (per Regulation Z), balloons, active for universal yield/APR, PV, FV, amort/retire, PMT/EACrow changes, more. IBM-PC/XT/AT/PS2 compatible. Simple yet complete—great for finance services. Acclaimed nationwide by Bank/CPA/CM/AM/Ex. 80 day MBG.

Electrosonics

36380 Garfield #1, Fraser, MI 48026
800/858-8448, 313/791-0770.

Inquiry 663.

SOFTWARE/MAPS

PC MAPPING SOFTWARE

Mapinfo software can:

- Display color maps from 52 ft. to 5,000 miles across the screen.
- Find addresses you type in
- Overlay data directly from dBASE III
- Color or shade boundaries
- Cost only \$750. Maps also available

Mapinfo Corp.

200 Broadway, Troy, NY 12180
1-800-FASTMAP In New York, (518) 274-8873

Inquiry 664.

SOFTWARE/MATHEMATICS

What? You've never seen a complex function?

Try $f(z)$ - The Complex Variables Graphing Package for PC's with CGA/EGA

"Let our animated screens show you what the printed page cannot."

Lascaux Graphics

(212) 654-7429

Inquiry 665.

SOFTWARE MUSIC

MUSIC SOFTWARE CATALOG!

Just published! Our new Musician's Music Software Catalog and it's better than ever! Over 80 pages of detailed information on the leading MIDI software programs, interfaces, and accessories—everything for the modern musician. Send \$3 for a 2-year catalog subscription including SALE! updates.

Digital Arts & Technologies

Dept. B71, P.O. Box 11, Milford, CT 06460
203-874-9080

Inquiry 666.

SOFTWARE/PRINTER

PRINTER GENIUS

Powerful memory resident printer management — Control printer features from menus or within documents — Print spool to disk files — Background print — Directory & file browse — Edit mail text — Redirect output — User friendly pop-up screens — 92 page manual — Preset for all printers — Completely flexible — PC MS-DOS — \$69 + \$4 S/H — VISA/MC

Nor Software Inc.

527 3rd Ave., Suite 150, New York, NY 10018
(212) 213-9118

Inquiry 667.

SOFTWARE/SCIENTIFIC

Data Acquisition & Analysis on PC's

- FOURIER PERSPECTIVE: Advanced Digital Signal Analysis
- PRIME FACTOR FFT software library. Call from Turbo Pascal, C, Fortran, Basic. Up to 60,000 data points. 2D interface available. Non-angular FFT's now possible in a multitude of dimensions.
- 2 & 3D Scientific Graphic packages with plotter support from Gadsden Software.
- Data Acquisition & Control Boards from Metrabyte, Analog Devices, Sun-Down, Standbury Tree, National Instruments, Corlec, & Tecmar
- Data Acquisition & Analysis Software—LABENCH, Nanoboc, Aegis, UniScope, Lotus Measure with 12-99/synchrony, & Quiv-Curtis
- Call for FREE Application Assistance & Technical Literature

Alligator Technologies — (714) 850-9984
P.O. Box 11386 Costa Mesa, CA 92627

Inquiry 668.

THE BUYER'S MART

SOFTWARE/SCIENTIFIC

NONLINEAR DYNAMICS

Tools for Studying Mathematical and Experimental Systems

* Ordinary and Delay Differential Equation Solvers * Bifurcation Diagrams * 2- and 3-D Plotting, Sequential Magnification, Poincaré Sections * Next Maximum, 1-D & Circle Maps * Phase Portraits with Multiple Initial Conditions * Spectral Analysis, Fractal Dimensions, Lyapunov Exponents
DS.I \$250.00 DS.II \$350.00

DYNAMICAL SYSTEMS, INC.

P.O. Box 35241, Tucson, AZ 85740, 602-791-7896

Inquiry 669.

ORDINARY/PARTIAL DIFFERENTIAL EQN SOLVER

FOR THE IBM PC & COMPATIBLES

MICROCOMPATIBLES INC.

301 Prelude Dr., Silver Spring, MD 20901

(301) 593-0683

Inquiry 670.

SCI-GRAF and SCI-DATA

SCI-GRAF produces huge hi-res graphs thru easy menus or linkable C libraries. Supports log scales, error bars, screen and printer output.

SCI-DATA performs least squares and normal curve fits, scaling and polar coordinate transformations.

Prices start at \$59.85.

Microcomputer Systems Consultants

Box 747, Santa Barbara, CA 93102

(805) 963-3412

Inquiry 671.

CONVERT UNITS

Memory resident *Quikinfo™* for IBM converts engineering units quickly, easily. Pops up from any program. Numbers can be imported/exported to applications. Includes tables of physical constants. User may customize units/tables. \$49 + \$3 s/h.

Piles Development

2110 Crystal Hills, Houston, TX 77077

(713) 493-3679

Inquiry 672.

Scientific/Engineering/Graphics Libraries

Turbo & Lightspeed Pascal, Modula-2, C

Send for FREE catalogue of software tools for Scientists and Engineers. Includes: Scientific subroutine libraries, device independent graphics libraries (including EGA, HP plotter and Laserjet support), scientific charting libraries, 3-D plotting library, data acquisition libraries, menu-driven process control software. Versions available for a variety of popular languages.

Quinn-Curtis

49 Highland Ave., Needham, MA 02184

Inquiry 673.

SOFTWARE/SORT

OPT-TECH SORT/MERGE

Extremely fast Sort/Merge/Select utility. Run as an MS-DOS command or CALL as a subroutine. Supports most languages and filetypes including Briefs and dBASE. Unlimited file sizes, multiple keys and much more! MS-DOS \$149. XENIX \$249.

(702) 586-3737

Opt-Tech Data Processing

P.O. Box 678 - Zephyr Cove, NV 89448

Inquiry 674.

SOFTWARE/SPORTS

VARSITY BATTING STATS

VARSTATS Softball/Baseball batting statistics program is a very convenient coaches' tool—game data entry from book in 5 mins. Track teams up to 18 players x 68 games. Easy to use. VARSTATS refined by coach/programmer over many seasons. PC's, Jr.'s, & compatibles (DOS 2.10 +, 256K). \$29.95 pdd by ck only.

JWM Software Associates

3124 David Ave Palo Alto, CA 94303

Inquiry 675.

SOFTWARE/TAX PREP.

TAX PAK

Sch A B C D E F R S Fms 1040, 1040A, 2106, 2119, 2441, 3468, 3800, 3903, 4562, 4884, 4797, 4972, 6251, 6252, 6582, 6596, 6606, 6615, IRS appnd print for IBM PC CPM (280) CPM86 Keypro 4 Morrow kg Professional incds Batch Processing & Tax Organizer \$185 (sep \$25) Personal has abrvd list of forms & features \$37. Updt \$125 & \$27. GA CA NY \$75.

Candelaria Works

3955 Club Dr., Atlanta, GA 30319

(404) 286-2420

Inquiry 676.

TaxEase™ System

Federal & State returns on single disk—only \$89.95. Easy to use. Calculates automatically, performs complex "What if" options, prints IRS-approved forms. AZ, CA, CO, DC, GA, IL, IN, MA, MD, MI, MN, MO, NC, NJ, NY, OH, OK, PA, VA, WI. Requires Lotus 1-2-3 or comp. spreadsheet VISA/MC \$3 s/h chg. Money back guarantee. Professional package available—\$99.

Park Technologies, Inc.

P.O. Box 1317, Clifton Park, NY 12065

518/877-5881 or 800/423-3189 outside NY

Inquiry 677.

SOFTWARE/TOOLS

DISK CACHE

Accelerate XT or AT PERFORMANCE with FLASHBACK Disk Cache. FLASHBACK automatically retains recently accessed disk data and neighboring data in memory for immediate access. Programs are instantly retrieved and run up to 10 times faster! \$19.95 + \$3 S/H. 60 day \$ back. Check/NOVISA/MC.

sep designs, inc.

14810 N Ninth St. Phoenix, AZ 85022

(602) 863-2861

Inquiry 678.

SCREEN MANAGER

MENU, WINDOW, and DATA ENTRY Support for the Professional Programmer! Interfaces to most languages. BASIC, C, FORTRAN, COBOL, PASCAL, ASSEMBLER. 100 Page Manual. Thirty day money back guarantee. No Royalties from \$79. VISA/MC

The West Chester Group

P.O. Box 1304, West Chester, PA 19380

(315) 844-4206

CALL FOR FREE DEMO

Inquiry 679.

STATISTICS

STATA

Statistics and graphics join to make STATA the most powerful package for the PC. No comparable program is as fast, friendly, and accurate. \$20 Demo. Quantity discount available. Call toll-free for more information. AX/VISA/MC.

1-800-STATAPC

Computing Resource Center

10801 National Boulevard, Los Angeles, CA 90064

(213) 470-4341

Inquiry 680.

STATISTICS

DISK & TAPE CONVERSIONS AUTOMATICALLY

SAVE TIME AND MONEY

Over 1000 formats from Mini, Micro Mainframe, Word Processors, & Typesetters

TAPE Conversions as low as \$23.00 MB

DISK Conversions as low as \$25.00 per Disk

Call or write TODAY for a cost saving quotation.

CREATIVE DATA SERVICES

1210 W Lallier Ave., Campbell, CA 95008

(408) 856-5080

Inquiry 681.

NUMBER CRUNCHER STAT SYS

Menu-driven Multiple & stepwise regression, ANOVA, time series, discriminant cluster and factor analysis, principal components, scatter plots, histograms, t-tests, contingency tables non-parametrics. Import export data Spreadsheet, sort, join, merge \$99. MS DOS Graphics program, \$59.

NCSS-B

865 East 400 North, Kaysville, UT 84037

801-546-0445

Inquiry 682.

STATISTIX™ II

Comprehensive, powerful and incredibly easy-to-use. Full screen editor, transformations, linear models (ANOVA, regression, logit, PCA, etc), ARIMA, most standard stat procedures. Clear, well organized documentation. Satisfaction guaranteed. \$169 PC DOS, \$99 Apple II.

NH ANALYTICAL SOFTWARE

P.O. Box 13204, Roseville, MN 55113

(612) 631-2852

Inquiry 683.

RATS! Version 2.1

Best selling econometrics program. Over 4000 copies sold. OLS, 2SLS, logit, probit and much more! Forecasting with ARIMA, VAR. Exponential smoothing. Model simulations. Support for daily/weekly data. High quality graphics to screen, plotter, printer. \$200-\$300. VISA/MC. Demo available.

VAR Econometrics, Inc.

P.O. Box 1818, Evanston, IL 60204-1818

(312) 864-8772; (800) 822-8038

Inquiry 684.

StatPac Gold™

Voted World's Best Statistical & Forecasting Package in 1987 by PC World Magazine readers. Six times more votes than the next closest competitor. More comprehensive & easier to use than all others. Get the facts. Call now for your FREE brochure.

1-800-328-4907

Walonic Associates, Inc.

6500 Nicollet Ave. S., Minneapolis, MN 55423

(612) 866-9022

Inquiry 685.

SOFTWARE/SORT

OPT-TECH SORT/MERGE

Extremely fast Sort/Merge/Select utility. Run as an MS-DOS command or CALL as a subroutine. Supports most languages and filetypes including Briefs and dBASE. Unlimited file sizes, multiple keys and much more! MS-DOS \$149. XENIX \$249.

(702) 586-3737

Opt-Tech Data Processing

P.O. Box 678 - Zephyr Cove, NV 89448

Inquiry 674.

ADVERTISE YOUR COMPUTER PRODUCTS HERE

for as little as \$375 in

THE BUYER'S MART

For more information call

Mark Stone at BYTE

603-924-3754

Inquiry 686.

THE BUYER'S MART

TAXES

TAXES—RECEIPTS SUMMARIES

Enter business or personal tax receipts • Get listings/summaries/archived files • Enter your own deduction sets (up to 40) • Enter your own account names for deduction set (up to 9) • Create Tax Receipt files, Update/edit any existing file, Archive files to floppy, List & Summarize data by account/data/deduction, (expdate, amount, datepd), MS/DOS IBM or compatible. Call or write: (805) 985-4815

J. McCollum Inc.

5310 Seabreeze Way, Oxnard, CA 93035

Inquiry 687.

UTILITIES

PERSONAL POP-UP

Create and access your own memory-resident reference and help files with the KeyNotes® Reference System. Open the KeyNotes "window" and return to the primary application with single keystrokes. Compatible with all popular programs. For IBM PC and compatibles. \$99.95 + \$5.00 shipping. To order, call or write:

Digital Learning Systems

4 Century Dr. Parsippany, NJ 07054
800-992-0284 (in NJ 201-638-6640)

Inquiry 688.

PEP Your Data to MS-DOS!

PEP ("Printer Emulation Package") is a unique software product which makes your MS-DOS system appear to be an intelligent serial printer. Converting your data from another operating system is as easy as printing it! Diskette plus 90 page typeset manual, \$64.95 U.S. (Not copy protected.) Specify 5 1/4 or 3 1/2 inch diskette size; add \$5 for both formats.

Intelpro

13 Saratoga Dr., Kirkland, Quebec, Canada H9H 3J9
(514) 694-6862

Inquiry 689.

MATCH PRINTERS TO PC

Match-A-Printer adapts most printers to PC/PS2 and compatibles. With this resident driver, get the full extended IBM ASCII character set on most printers. French, Spanish, German, Italian, Swedish, Greek, etc. and logic symbols. Works great with Apple ImageWriter and D.M.P. Epson and most daisy wheel printers. Some character compatibility now, great for academic and engineering application. Introductory Price \$59.95 & \$2.95/H. California residents add 6 1/4% sales tax. MD/Check.

MATCH SOFTWARE

8426 Coldwater Canyon, North Hollywood, CA 91606-1113
Toll free # 1 (800) FLOPPYO

Inquiry 690.

UTILITIES

COPY AT TO PC

The 1.2mB drive has long been known to READ but NOT reliably WRITE on 360k floppies. With "COPYAT2PC"™ 1.2mB drives CAN reliably WRITE 360k floppies saving a slot for a second hard disk or backup tape. "COPYAT2PC" (Not Copy Protected) offers the preferable SOFTWARE SOLUTION. ONLY \$79 + \$4 S/H VISA/MC/COD UPS 8/R

MICROBRIDGE COMPUTERS

655 Skyway, San Carlos, CA 94070
Order toll free 1-800-523-8777
415-593-8777 (CA) 312-334-1868 (NY)
TELEX EZLNK 62873089 Dealer Inquiries Invited

Inquiry 691.

Recover deleted files fast!

Disk Explorer now includes automatic file recovery. You type in the deleted file's name. Disk Explorer finds and restores it. Disk Explorer also shows what's really on disk, view, change or create formats, change a file's status, change data in any sector. MS-DOS \$75 U.S. Check/Credit card welcome.

QUAD SOFTWARE LIMITED

45 Charles St. E. 3rd Fl.
Toronto, Ontario, Canada M4Y 1S2
(416) 961-8243

Inquiry 692.

HANDS OFF THE PROGRAM®

- Locks Hard Disk
- Restricts Floppy Use.
- Protects Subdirectories
- Normal Use of DOS Commands and Application Software
- IBM PC, XT, AT and True Compatibles
- DOS V2.0 and Higher. Hard Disk System.
- Keep Other People's HANDS OFF Your System.
- \$88.95 VISA/MC

SYSTEM CONSULTING, INC.

314 Canterbury Dr., Pittsburgh, PA 15238
(412) 963-1624

Inquiry 692.

\$59.95!!

Buy the RED Utilities now! Programs include: Disk cache to speed hard disk. Printer spooler. Batch file compiler. Path command for data files. Wild card exceptions. Protect hard disk from accidental formatting. Sort directories. Over 10 more programs. IBM PC. Visa/MC.

The Wenham Software Company
5 Burley St., Wenham, MA. 01984 (617) 774-7036

Inquiry 693.

WORD PROCESSING

HEBREW / GREEK / ARABIC

Russian and European Languages. Full featured, multi-language word processor supports on-screen foreign characters with no hardware modifications. \$350 (dot matrix) or \$500 (laser) + \$5 s/h. Or send \$15 + \$4 s/h for demo. Req. 512K/graphics

Gamma Productions, Inc.

710 Wilshire Blvd., Suite 609, Santa Monica CA 90401
(213) 394-8622

Inquiry 694.

CompareRite™

CompareRite saves editing time by comparing two documents and generating a third that shows the differences in an average of two seconds per page. CompareRite highlights changes the way you want to see them. Works with all major word processing programs. Price — \$129.95 + shipping/handling

JURISoft, Inc.

763 Massachusetts Ave., Dept 1101, Cambridge, MA 02138
1-800-252-5656 ext. 1101

Inquiry 695.

DuangJan 1.3

Bilingual word processor for English and one of these: Armenian, Bengali, Euro/Latin, Greek, Hindi, Khmer, Lao, Russian, Tamil, Telugu, Thai, Viet, . . . or create your own language with font editor. \$69 + \$4 s/h (+ \$10 for LaserJet) + \$49 Demo \$5. IBM compatibles.

MegaChomp Company

3524 Cottman Avenue, Philadelphia, PA 19149 1636
(215) 331-2748/8138

Inquiry 696.

PC-Write™ Shareware Ver. 2.71

Fast, full featured word processor/text editor for IBM PC. With spell check, screen clip, mailmerge, split screen, ASCII files, macros. Easy to use. Supports 400 printers - LaserJet + and PostScript. Software, User Guide, and Tutorial on 2 disks for \$16. Try it, then register with us for only \$89 and get User Manual, 1 year tele-support, newsletter and 2 upgrades. 90-day guarantee. VISA/MC.

Quicksoft 1-800-888-8088 CALL TODAY!
219 First N., #224-BYTC, Seattle, WA 98109

Inquiry 697.

Subscription Problems?

We want to help!

If you have a problem with your BYTE subscription, write us with the details. We'll do our best to set it right. But we must have the name, address, and zip of the subscription (new and old address, if it's a change of address). If the problem involves a payment, be sure to include copies of the credit card statement, or front and back of cancelled checks. Include a "business hours" phone number if possible.



BYTE

Subscriber Service, P.O. Box 7643, Teaneck, NJ 07666-9866

Compu\$ave

Call Toll Free: 1-800-624-8949

BOARDS

Above Board 286	318	Artist 1	859
ATI EGA Wonder	175	ATI V.L.P.	269
AST Rampage XT	199	VM1 IM 1024	2375
AST Rampage 286	299	BOCA RAM AT	145
AST 5251-I1	559	NEC GB-1	208
Genoa EGA Plus	225	NEC MWA 1024	819
Orchids Tiny Turbo	285	Paradise Auto	139
Paradise VGA Pro	359	Paradise 480	149
Talltree J-Laser A1	425	Paradise VGA	245
Talltree J-RAM AT3	215	Quadram HPG	SAVE
Video 7 Vega VGA	275	Vega Deluxe	195
ADC Alloy BNW Everex Number 9 Orchid			CALL
Hercules-STB-Tseng Verticom Intel			CALL

MONITORS

Samsung TTL	85	Amdel 410A	139
Mitsubishi 1377A	479	Amdel 1280	658
Mitsubishi 9919	2585	Thomson 450-A	149
NEC MultiSync II	548	Taxan 770	519
NEC MultiSync	889	PGS LM300	489
NEC MultiSync XL	2049	PGS Ultra	495
Sigma Laser 19"	1699	Zenith 1490	619
Vericom 2 Page	1795	Taxan Crystal	1499
NEC MultiSync GS	182	Wyse 700	678

SCANNERS

Datacopy Model 730	1145
PGS LS-300 With OCR Software & Adapter	979
Panasonic FX-RS 505	979
AST Hewlett-Packard Taxan/Others	SAVE

COMPUTERS

NEC Multispeed	1299	AST Model 80	SAVE
NEC Multispeed EL	1565	AST Model 90	SAVE
NEC Multispeed HD	2425	AST Model 120	SAVE
Sharp 4502	1209	AST Model 140	SAVE
Sharp PC-7000A	1295	AST 386	SAVE
Sharp PC-7100	1969	AT&T 6386	SAVE
Yoshida 3100 2U	2949	Toshiba 1000	785
Yoshida 1100	1429	Toshiba 3200	3795
Yoshida 1200	2345	Zenith Z-181	1525
Yoshida 5100	4495	Zenith Z-183	2069
Acer 80386 16MHz/0 Wait/40M Drive			3065
Packard Bell 286 12 MHz 640K 1 2M Dr			1499
Sperry IT 1M 44 M Drive Keyboard			2785
Televideo 386 16 MHz 2M 1 2M Drive			2495
Wyse 286 10 MHz 640K 1 2M Drive			1339
Wyse 2189 8 MHz 512K 1 2M Drive			1129
Acer 80386 16 MHz/0 Wait/1 2M Drive			2599
Wyse 2214 12.5 MHz/0 Wait/1 2M Drive			1945
Wyse 386: 16 MHz/1M/1 2M Drive			2575
Allot/ITT Mitsubishi Samsung/Tandon			CALL

TERMINALS

Link MC1	325	Adds 1010	299
Allos V	469	Wyse 30	279
Link 125	369	Wyse 50	352
Kumron KT70 PC	359	Wyse 60	392
Televideo 905	289	Wyse 85G	419
Televideo 955	369	Wyse 99GT	472
Amplex/Hazeltine/Liberty IBM/Quine			CALL

PLOTTERS

Calcomp 1041 GTB	4495	Enter SP500	669
Calcomp 1043GT	6495	Joine 3700	3099
Calcomp 1042GT	7695	Joine 4000	4095
Houston 41 42	2095	Houston 56A	3895
Houston DMP 52	2795	Houston 61	3295
Houston DMP 52 MP	3295	Houston 62	4495
Roland 990	1199	Enter SP 1200	3085
Roland 1300	5345	Roland 880	509
Numonics-Taxan-Versatec-Other Models			CALL

DIGITIZERS

Calcomp 17 - 24	3045	Calcomp 12 - 12	389
Calcomp 44 - 60	4795	GTCC 24 - 36	2099
Karta IS 8.5 x 11	259	GTCC 36 - 48	2495
Karta IS 12 x 12	349	Hitech 11 - 11	455
Karta IS 12 x 17	575	Scriptel	SAVE
Calcomp 36 - 48	4395	Summa 12 x 12 + 369	
Numonics 20 - 20	1245	Summa 12 x 18	629

MODEMS

MultiTech 224E	368	Anchor 1200	79
MultiTech 224EC	329	AST 9600	795
Packard Bell 1200	98	AST 2400B	299
Anchor 2400 E	145	Hayes 1200	275
Prometheus 2400 B-2	125	Hayes 1200B	255
Prometheus 2400G	159	Hayes 2400	415
Racal-Vadic 2400VP	395	Migent Pocket	155
USR Courier 2400	322	Novation Parrot	89
USR Courier 2400E	365	USR HST 9600	665
Ven-Tel 2400 MMP	462	Ven-Tel 18000	949
Avalex/Case/Everex/UDS/Zoom			CALL

PRINTERS

Citizen 1280	139	Alps 224	465
Citizen MSP40	295	Alps 324	475
Citizen MSP45	429	NEC P660	422
Citizen Premier 35	465	NEC CP660	519
Discolor D150	295	NEC P760	592
Citizen 180 D	158	NEC CP760	582
Okidata 393	959	NEC P5AL	835
Panasonic 1080/M2	169	NEC P9AL	1078
Panasonic 1091/M2	189	NEC P2200	329
Panasonic 1524	549	Toshiba 321SL	495
Panasonic 1595	462	Toshiba 341SL	659
Star NX1000	178	Toshiba 351SX	1079
Data South/110h Fujitsu/OTC/Data Pro/TT			CALL
Butters Sheet Feeders/ Switches/ Tractors			SAVE

LOW PRICES FOR LASER PRINTERS

AST Turbo P/S	3045	AST Turbo EL	1765
HP Laser Jet II	1719	Canon B-11	1545
Oliv Laserline 6	1365	NEC 890	3229
Taxan Crystal Jet	2445	Panasonic 4450	SAVE
Toshiba Page 12	2545	Quadrizer	2399

DISK DRIVES

Miniscribe 6053	585	Bermouth II	SAVE
Miniscribe 30M Card	398	CDC 130M	1679
Miniscribe 6085	799	Plus Card 204M	535
Seagate 20M Kit	275	Plus Card 40M	819
Seagate 30M Kit	215	Seagate 40M	395
Toshiba 3 5" Kit	109	Seagate 4096	849
AST/Alloy/Everex/Genoa/Maynard/Mizcor			CALL
Mountain/Prum/Talkgrass/Teac/Tecmar			CALL

**HOURS: MON-FRI 7AM-6PM / SAT 9AM-2PM
IN ARIZONA CALL (602) 437-4855**

CompuSave: 4207 S. 37th St., Phoenix, AZ 85040 Prices Reflect Cash Discounts And Are Subject To Change Without Notice. Major Credit Cards And Selected PD's Are Accepted. We Cannot Guarantee Compatibility. CompuSave Is A Division Of Adlanko Corporation.

Before you spend less (or more) than 39¢ on a diskette, read this...

Everyone loves a bargain, and a 26¢ 5.25 DSDD diskette sure looks like a good one. But after five years in the business of selling disks, we know that it isn't.

All diskettes are not created equal

U S Diskette manufacturers test their diskettes to assure they meet certain quality specifications. Three types of disks emerge from this process: those that are unusable, those that meet "ANSI" standards (40% or more of the disk is usable), and those that are "high-clip" (65% or more of the disk is usable.) Only the latter disks become brand name disks. And only the latter type of disk can become a Super Star™ disk.

No gimmicks, no hidden charges, and no insult to your intelligence

Super Star diskettes come with a lifetime guarantee and packed in polybags, with Tyvec™ (not paper) sleeves, write-protect tabs, and user-ID labels. We don't think these are "luxuries" and we don't charge more for them. We don't tack on a "small order" surcharge or the like. We don't add a surcharge if you pay with a credit card. The price is the price we advertise whether you order 50 disks or 500. And our shipping charges are approximately our shipping costs. We profit by selling lots of disks not by shipping lots of disks. It's those cute little extra charges that can turn a 26¢ ANSI disk into a 36¢ ANSI disk before you can say "I've been had."

We believe in service, not lip service

Over 90 percent of our business comes from referred or reordering customers. That says a lot about our disks and our service. Our order takers are trained to know whether we stock the disks for your computer. They have current information on what is and isn't in stock. When an item is available, it ships within 48 hours, barring snowstorms, hurricanes or plagues. When something is not available, we tell you when you can realistically expect it. We don't

keep our customers by making empty promises. Most important of all, our order takers are trained to say things like "thank you."

We know some people are motivated to buy based purely on price. After all, if you're in the market for a really cheap diskette, that's what you'll get. But if you're data is worth more than the price of the disk, give us a try. With our quality, our lifetime guarantee, and our prices, we're the best value going.

Super Star 5.25 SSDD .39 ea
Super Star 5.25 DSDD .39 ea
Super Star 5.25 SS96TPI .51 ea
Super Star 5.25 DS96TPI .59 ea
Super Star 5.25 Hi Dens for AT 1.09 ea

Super Star 3.5 SSDD 1.16 ea
Super Star 3.5 DSDD 1.19 ea
Super Star 3.5 Hi Dens 4.69 ea

1-800-255-5874

8 a.m. to 5 p.m. CST
(In Illinois, call 312-492-5050)

Call for printer ribbons, diskettes, disk cases and other computer supplies

Order information: Minimum purchase is \$25.00. Super Star diskettes sold in quantities of 50. Shipping charges: \$3.00 per 100 diskettes or fraction. We accept Visa and MasterCard. COD orders accepted with a \$5.00 charge. Open accounts (Net 15) available to qualifying public and private organizations. International inquiries welcome.



Disk World, Inc.
2200 West Greenleaf Street, Evanston, Illinois 60202

Now Available...Jameco's NEW Winter/Spring Flyer #136 with 48 pages of Computer Peripherals, Components & More!

Jameco Solderless Breadboard Sockets

Part No.	Dim. L' x W"	Contact Points	Binding Posts	Price
JE20	6 1/2 x 3 1/4	200	0	\$ 2.29
JE21	3 1/4 x 2 1/4	400	0	\$ 4.49
JE22	6 1/2 x 1 1/4	630	0	\$ 5.95
JE23	6 1/2 x 2 1/4	830	0	\$ 7.49
JE24	6 1/2 x 3 1/4	1,380	2	\$14.95
JE25	6 1/2 x 4 1/4	1,660	3	\$22.95
JE26	6 1/2 x 5 1/4	2,390	4	\$27.95
JE27	7 1/4 x 7 1/4	3,220	4	\$37.95

Jameco's IBM PC/XT/AT Compatible Motherboards

Award BIOS ROMs included

JE1001

JE1000	4.77MHz (PC/XT)	\$ 84.95
JE1001	4.77/8MHz (PC/XT)	\$ 99.95
JE1002	4.77/10MHz (PC/XT)	\$119.95
JE1007	6/8/10/12MHz (AT)	\$349.95

Jameco Computer Power Protection

JE1190

JE1190	Power Base	\$29.95
JE1191	8-Outlet Power Strip	\$11.95
JE1192	300 Watt Back-Up	\$269.95
JE1193	500 Watt Back-Up	\$349.95

Zuckerboard TANDY 1000 Expansion Memory Half Card

Expand the memory of your Tandy 1000 (128K Version) to as much as 640K. Also includes DMA controller chip.

TE512 TANC	Includes 512K RAM. Plug-in Clock option chip (only)	\$119.95 / \$39.95
------------	-----------------------------------------------------	--------------------

30Meg Hard Disk Drive Board for Tandy 1000, 1000A, 1000SX, 1200, 3000 and 3000HL

T30MB Board. \$599.95

30005	Logic Data Book - Vol. II (84)	\$19.95
30009	Internal Data Book (87)	\$14.95
21388	CMOS Cookbook (86)	\$14.95
210830	Intel Memory Handbook (87)	\$17.95
230643	Intel Microsystem Handbk. Set (87)	\$24.05

TA450S	3mm Industries (4.68" sq, 50 pins)	\$11.95
SU2A1	EG&G Rontron (3 1/2" square, 34 pins)	\$11.95

Upgrade 10MHz PC/XT Compatible Kit

JE1059...\$499.95 (EGA Monitor and Card not included)

Total 380K RAM

Jameco's 4.77/10MHz Turbo IBM PC/XT Compatible Kit

JE1002 4.77/10MHz Turbo Motherboard (Zero-K RAM - Includes Award BIOS ROMs)..... \$119.95

JE1014 Max Turbo PC/XT Compatible Case..... \$69.95

JE1015 XT/AT Comp. Keyboard \$59.95

JE1021 5 1/4" HDD Disk Drive (Beige Bezel)..... \$89.95

JE1031 Mini 150W Turbo PC/XT Comp. Power Supply..... \$89.95

JE1043 360K/720K/1.2MB Floppy Controller Card..... \$49.95

4164-150 16K RAM (85,536x1) (2 Chips, 150ns)..... \$4.98

41256-150 512K RAM (262,144x1) (18 Chips, 150ns)..... \$85.50

50404-15 112K RAM (63,536x4) (4 Chips, 150ns)..... \$19.80

Regular List \$569.98 SAVE \$70.03!

JE1006 IBM PC/XT Comp. 10MHz Turbo Kit .. \$499.95

12" Amber Monochrome - TTL Input, High Resolution (PC/XT/AT) AMBER..... \$109.95 \$99.95

14" RGB Color - CGA Compatible Amber/Green/Color Switchable, 640 x 200 Resolution (PC/XT/AT) TTX1410..... \$279.95

14" EGA Color - EGA/CGA Compat., 720 x 350 (max.) resolution (PC/XT/AT) TE5154..... \$399.95

14" Ultrascan Color - CGA/EGA/PGA/VGA Compatible, 600 x 560 (max.) Resolution (PC/XT/AT) 4375M..... \$579.95 \$549.95

Graphic Display Cards

JE1059 EGA Card and Monitor \$499.95

JE1050	Mono Graphics Card w/Printer Port (PC/XT/AT)	\$59.95
JE1052	Color Graphics Card w/Printer Port (PC/XT/AT)	\$49.95
JE1055	EGA Card with 256K Video RAM and Printer Port (PC/XT/AT)	\$149.95
JE1071	Multi I/O with Drive Controller and Mono Graphics (PC/XT)	\$119.95

Multifunction, I/O and Expansion Cards

JE1060	I/O Card with Serial, Game, Parallel Printer Port and Real Time Clock (PC/XT)	\$59.95
JE1061	RS232 Serial Hand Card (PC/XT/AT)	\$29.95
JE1065	I/O Card with Serial, Game and Parallel Printer Port (AT)	\$59.95
JE1078	Expand to 384K (incl zero-K) Multifunction w/Serial, Game, Parallel Printer Port & Real Time Clock (PC/XT)	\$79.95

Floppy and Hard Disk Controller Cards

JE1040	360KB Floppy Disk Drive Controller Card (PC/XT)	\$29.95
JE1041	20/40MB Hard Disk Controller Card (PC/XT)	\$79.95
JE1043	360K/720K/1.2MB Floppy Disk Cont. Card (PC/XT/AT)	\$49.95
JE1045	360K/720K/1.2MB Floppy/Hard Disk Controller Card (AT)	\$159.95

Additional Add-Ons Available!

COMPUTER PERIPHERALS

Seagate 20, 30, 40 and 60MB Half Height Hard Disk Drives

ST225K (Pictured)

ST225	20MB Drive only (PC/XT/AT)	\$259.95
ST225K	20MB w/Controller (PC/XT)	\$289.95
ST238	30MB Drive only (PC/XT/AT)	\$299.95
ST238K	30MB w/Cont. (PC/XT/AT)	\$329.95
ST251	40MB Drive only (PC/XT/AT)	\$439.95
ST251XT	40MB w/Cont. Card (PC/XT)	\$499.95
ST251AT	40MB w/Cont. Card (AT)	\$539.95
ST277	60MB Drive only (PC/XT/AT)	\$549.95
ST277K	60MB w/Cont. Card (AT)	\$659.95

Jameco PC/XT & AT Compatible Disk Drives

JE1022 (Pictured)

JE1020	360K Black Box (PC/XT/AT)	\$ 89.95
JE1021	360K Beige Box (PC/XT/AT)	\$ 89.95
JE1022	1.2MB Beige Box (AT)	\$109.95

Datronics

2400/1200/300 Modems

• Hayes command compatible • Bell 103/212A compatible • Auto-dial/auto-answer • FCC approved • 1-year warranty • Includes MaxiMite Communication Software

1200H	1200/300 Baud Internal Modem	\$ 79.95
2400S	2400/1200/300 Internal Modem	\$174.95
1200C	1200/300 Baud External Modem	\$119.95
2400E	2400/1200/300 External Modem	\$219.95

Prometheus 1200B Internal Modem PM1200B-2S (Software incl.) \$149.95 \$119.95

Jameco Extended 80-Column Card for Apple IIe

• 80 Col./64K RAM • Doubles amount of usable Apple IIe memory • Auto-dial/auto-answer • Ideal for word processing • Complete with instructions

JE864 \$39.95

ADD12 (Disk Drive II, II+, IIe) \$99.95

TEST EQUIPMENT

Kingdom and Metex Digital Multimeters

KD302:

- Pocket Size in handy carry case
- 3 1/2 Digit LCD
- Auto or manual ranging
- Audible continuity tester
- Tests: AC/DC Voltage, Resistance and Continuity
- One Year Warranty
- Size: 4 1/2" L x 2 1/4" x 1 1/4"

KD302 .. \$27.95

M4650:

- Handheld, high accuracy
- 4 1/2 Digit LCD
- Manual ranging with Overload Protection
- Audible continuity tester
- Tests: AC/DC Voltage, Resistance, Continuity Capacitance and Frequency
- One Year Warranty
- Size: 7 1/2" L x 3 1/4" W x 1 1/4" H

M4650 .. \$79.95

U.S. Funds Only
Shipping: Add 5% plus \$1.50 Insurance
(May vary according to weight)

California Residents:
Add 6%, 6 1/2% or 7%
Sales Tax
FAX 415-592-2503
3/88



Data Sheets - 50¢ each
Prices Subject to Change

Send \$1.00 Postage for a FREE 1988 CATALOG

Telex: 176043

©1988 Jameco Electronics

1355 SHOREWAY RD., BELMONT, CA 94002 • FOR ORDERS ONLY 415-592-8097 • ALL OTHER INQUIRIES 415-592-8121



FCC APPROVED!

Sub-Mini AT!
The Space Saver
3-DR. Capability
8-Expansion Slots!

Comes with:

- 6-10-12 MHz Speed, 1 wait state
- 8 Expansion Slots
- Award Software BIOS
- 1 ea. 1.2MB high density floppy drive
- Floppy & HD controller
- 512K RAM (Expandable to 1M)
- 200-watt power supply
- AT Style keyboard
- Assembled & Tested
- Expansion options available

Order # MAT-1 **\$965.00**

XT Turbo Basic System

- 4.77/8MHz keyboard selectable
- 8 expansion slots
- Award Software BIOS
- XT Style slide case
- 256K RAM Expandable to 640K)
- XT Style keyboard
- Assembled & Tested
- Expansion options available

AT Turbo Basic System

- 6/10MHz, 0/1 wait state (6/12MHz option)
- 8 expansion slots
- Award Software BIOS
- 512K RAM (Expandable to 1M)
- 1.2MB high density floppy drive
- Floppy & HD controller
- 200-W power supply
- AT Style keyboard
- Assembled & Tested
- Expansion options available

Order # XT-TURBO 1

\$290.00

Order # ATTURBO-1

\$945.00

PERIPHERALS

- | | |
|-------------------------------------|----------|
| 1. Floppy Disk Controller - 2Dr. | \$29.00 |
| 2. Floppy Disk Controller - 4Dr. | \$34.00 |
| 3. WDC H.D. Controller | \$75.00 |
| 4. WDC H.D. Controller - RLL | \$105.00 |
| 5. Floppy & HD Controller - XT/AT | \$155.00 |
| 6. WDC Floppy & HD Controller | \$155.00 |
| 7. 0-384K Multifunction Card | \$79.00 |
| 8. Multi I/O (Ser/Par/Game/Clk) | \$54.00 |
| 9. Multi I/O With Controller | \$75.00 |
| 10. Multi I/O For AT (Ser/Par/Game) | \$52.00 |
| 11. 0-640K RAM Card | \$40.00 |
| 12. 0-2M EMS RAM Card For XT | \$96.00 |
| 13. 0-2M EMS RAM Card For AT | \$119.00 |
| 14. Color Graphics Card | \$45.00 |
| 15. Color Graphics Card W/Printer | \$55.00 |
| 16. EGA Card (Made in USA) | \$139.00 |
| 17. Mono Gr. Card W/Printer | \$50.00 |
| 18. XT Turbo Motherboard W/BIOS | \$95.00 |
| 19. 6/10 MHz AT Motherboard | \$370.00 |
| 20. 8/12 MHz AT Motherboard | \$410.00 |
| 21. 6/12 Mini AT Motherboard | \$410.00 |
| 22. XT Style Keyboard | \$47.00 |
| 23. AT Style Keyboard (AT/XT) | \$54.00 |
| 24. Enhanced Keyboard (AT/XT) | \$67.00 |
| 25. 150-watt Power Supply | \$49.00 |
| 26. 150-watt Power Supply-UL | \$60.00 |
| 27. 200-watt Power Supply-UL | \$95.00 |
| 28. XT Flip Top Case | \$32.00 |
| 29. XT Slide Case | \$34.00 |
| 30. XT Slide Case (AT Style) | \$47.00 |
| 31. AT Slide Case | \$63.00 |
| 32. Mini AT Slide Case | \$54.00 |

ORDER HOT LINE 1-800-543-5107
 Technical Information (714) 990-2097

Hours: Mon. - Fri. 9:00 am - 6:00 pm PST

JAWIN COMPUTER PRODUCTS

565 W. Lambert Rd., #C
 Brea, CA 92621

Terms: Please add 5% (or \$2.00, whichever is higher) plus 25% for each \$100.00 CA residents please add 6% sales tax. We accept VISA/MC/Cash. Personal checks please allow 2 weeks to clear. All merchandise is warranted for 1 year unless otherwise stated.

MAXELL
100% CERTIFIED
5 1/4" BULK DISKS

5 1/4" DS/DD 59¢

5 1/4" DS/HD 1.59

3 1/2" DS/DD 1.09

Price based on quantity of 300 includes sleeves, labels and tabs.

800-222-0490

In NJ 201-462-7628

• 24 Hour Shipment •

MEGAsoft

P.O. Box 710, Freehold, NJ 07728

Circle 158 on Reader Service Card

IEEE-Z

Easiest IEEE 488(GPIB/HPIB) Interfaces for your PC, PS/2, Macintosh, HP and more!

- Controllers
- Converters
- Extenders
- Buffers
- Boards



Call or send for your **FREE** Technical Guide

IOtech (216) 439-4091

25971 Cannon Road - Cleveland, Ohio 44146
 Telex 6502820864 - Fax (216) 439-4093

Circle 125 on Reader Service Card

Dealers!

Network-OS LAN Systems - Includes Boards, Cabling, Terminators and Software. Two-user hardware and software for under \$1,000 list!

Close-Up Remote Communications - Support your customer without leaving your office. Authored by Cogitate for Norton-Lambert!

Context Sensitive Help for DataFlex, RM/COBOL, Clipper and dBase III - Puts your application's documentation "on line."

DataFlex Database Management - True Multi-User database for MS/PC-DOS, Unix and Xenix. Site licensing available.

Dump/Restore-XT - Seven utilities for the MS/PC-DOS user.

Call or write today for our catalog and pricing!

COGITATE, INCORPORATED
 "A Higher Form of Software"
 24000 Telegraph Road
 Southfield, MI 48034
 (313) 352-2345/Telex: 386581
 Visa/MasterCard Accepted

Circle 56 on Reader Service Card

9-TRACK MAG. TAPE SUBSYSTEM*
FOR THE IBM PC/XT/AT AND...



For information interchange, backup and archival storage AK Systems offers a 9-track, IBM format-compatible *9-track magnetic tape subsystem for the IBM PC, featuring:

- IBM format 1600/3200 and 800 cpi
- Software for PC-DOS, MS-DOS, XENIX.
- Also for AT&T, DEC, VAX, VME, S-100, RS-232, IEEE 488.

AKSystems

3091 Main St.
 Chesham, CA 91311
 (818) 758-6700
 TWX 910-460-2071
 FAX 818-753-4303

* IBM format 1600/3200 and 800 cpi

Circle 8 on Reader Service Card

Why waste your time formatting disks?

Preformatted disks save you time and money!

Memorex • Nashua • 3M
 5 1/4" (from 48c) • 5 1/4" HD • 3 1/2" • 3 1/2" HC

Call toll-free TODAY!
1-800-321-4668

In Colorado (303) 234-0871.
 Open 8:00 to 5:30 Mountain Time, Monday-Friday

ALF
 ALF Products, 1315F Nelson St.
 Denver, CO 80215

Circle 9 on Reader Service Card

PAL/EPROM PROGRAMMER CARD
 For PC/XT/AT Systems

NEW - VERSION 2 OF SOFTWARE AND HARDWARE

Programs 20 and 24 Pin Intel 85, 71, AMD, ALTEGA, CYPRESS, RIGOH, and PANATEC PALS Supports EPLO, polarity, RA, and shared product form types. Functions include: Read, Write, Verify, Protect, Edit, Print, and File load and save of program. JEDEC supported. Software included.

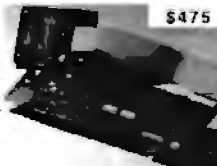

\$475

100MHZ LOGIC ANALYZER CARD
 For PC/XT/AT Systems

24 Channels at 25KHz-25MHz
 4 Channels at 100 MHz
 Internal Clock up to 160 MHz
 External Clock up to 25 MHz
 Threshold Voltage TTL ECL or variable from 10 to +10v
 Can Stack Multiple Boards
 All Software included



\$1199

CALL NOW FOR ORDERS AND TECHNICAL INFO (201) 994-6669
 Link Computer Graphics, Inc. 4 Sparrow Dr., Livingston, NJ 07039. TLX: 9112489305 LINK COMPUTER

Circle 142 on Reader Service Card

Multi Line BBS Information Host System

InfoQuest has announced the first reasonably priced professional Bulletin Board/E-Mail System that instantly transforms any IBM or compatible computer into a secure, reliable Information Host System.

Multi-User On-Line Database

A flexible database feature provides the virtually unlimited organization of either structured or unstructured databases, each with its own "Key-Word Search" capabilities.

Features like these, combined with a fully integrated Electronic Mail System, make this com-

plete and comprehensive package the only choice for any serious business application.

9600 Baud & Beyond Modem Support

There's no reason to limit yourself to "snail's paced speeds." Now a simple software setup allows you to configure various modems at different baud rates on up to 16 dial-up telephone lines at speeds from 300 to 19,200 BPS.

A list of hundreds of systems presently on-line include several major corporations along with many successful new start-up firms. Each

report their complete satisfaction with this unique product.

Extensive upload options allow the organization and presentation of data, graphics, text and program files into an easy-to-use download library available to users so authorized.

Priced at Only \$395.

This revolutionary software system installs in minutes out of its professionally documented package and is available with a money-back guarantee. To order, or for additional information, contact InfoQuest, (818) 991-5112.

Solving your scientific and engineering problems just got simpler.

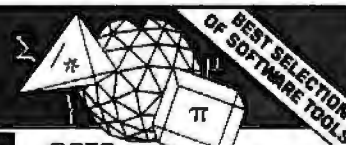

**BEST SELECTION
OF SOFTWARE TOOLS**

Science & Engineering Software Co. is the only source with all the software you need to solve your specialized problems. Statistical data analysis, circuit design, data acquisition and signal analysis, solving complex equations, 3D CAD/CAM, high-tech graphics, technical word processing and more.

- No one offers you more variety.
- If you don't see a title, we'll special order it.
- If you don't know the publisher, we'll find it.
- Over 300 programs available
- We offer a 30-day, money-back guarantee.*

CIRCUIT DESIGN SCHEMATIC CAPTURE

HVERRE, Wintek Corp.	\$ 849
MICRO-CAP II, Spectrum Software	759
PAGE D-R, CAD Software	CALL
PAGE PCB, CAD Software	CALL
PAGE RECAL, CAD Software	CALL
PIRATA, MicroSim	CALL

Call for Options

Schematics II, Omnetron	449
SMARTWORK, Wintek Corp.	849
Temp PCB, ACCEL Tech.	495
Temp RECAL, ACCEL Tech.	495

DATA ACQUISITION SIGNAL ANALYSIS

Asystat Plus, Macmillan	\$ 849
Ayastat, Macmillan	489
DADSP, DSP Systems	749
DADSP-488, DSP Systems	175
Fourier PERSPECTIVE II, Adigator Trans.	329
HYPERSIGNAL, Hyperceptant	309
LASTECH Azetras, Lab Tech. Corp.	CALL
LASTECH CHROM, Lab Tech. Corp.	709
LASTECH Notebook, Lab Tech. Corp.	759
LASTECH Real Time Access, Lab Tech. Corp.	269
Lotus Measurs	445
O. E. D. A. and Diastrol, Harco Scientifics	799
SNAP-CALC, HEM Data Corp.	350
SNAP-FFT, HEM Data Corp.	295
SNAPSHOT STORAGE SCOPE	495
UnitScope Junior, Untel Software	109
UnitScope Level 1, Untel Software	315
UnitScope Level 2+, Untel Software	499

GRAPHICS LIBRARIES

HALO, Medco Cyromerics	\$ 215
Keeps, Ithaca Software	319
Graphic, Scientific Endavors	315
DS Graphics Dev. Toolkit	375

PLOTTING AND GRAPHING

ChartMaster PC, Interchart Software	\$ 369
Desktop Graph, Milohon Associates	269
Graphic, Scientific Endavors	269
PLDTZ, Curious Technical Soft.	319
TECH*GRAPH*PAD, binary engineering	259

TURBO VIEW

High-speed 3D viewing program which shows fast viewing of AutoCAD drawings in both orthographic and true perspective. Fast smooth motion interaction to your AutoCAD drawings!

Price: \$4.99

EQUATION SOLVERS

Brooks: The Solver, Borland	\$ 109
MathCAD 2.0, MathSoft	279
mathMATH, Microsoft	185
SolveIT!, Structural Scientific Software	79
Solver-Q, SOCC	79
TECHsolver Plus, Universal Tech Sys	395

CAD

Autocheck, by AutoCAD	\$ 65
Speed Enhanced Version	79
Design CAD, American Small Bus. Comp.	219
Drafts 1 Plus, Foresight	239
Drafts 3-D Modeler, Foresight	189
EASYCAD, Evolution Computing	139
ECAD, Cetron Engineering	439
FASTCAD, Evolution Computing	1,849
Generic CADD	89
Generic 3-D Solid Modeling	159
3-D Rendering Models	119
to-A*Vision, Micrograph	499
LinearCAD, DSI Link	89
PRO-3D/PC, Embling Technologies	355
TurboCAD, MSA Group	79

AUTOCAD ADD-ONS

AutoCAL, Systems Unit of CA	\$ 275
AutoHAPPY, Systems Unit	189
FOIMPLEX, Systems Unit	89
Turbo View, Sublogic Corp.	Special 439

APL LANGUAGE

APL*PLUS/PC, STSC	\$ 439
APL*PLUS PC TOOL, STSC	209
Packet APL, STSC	75

SCIENTIFIC/TEXT PROCESSING

CHEM-TEXT, Molecular Design Ltd.	\$1,500
EXACT, Technical Support Software	419
EXP, Brooks/Cole Publishing	129
For Math, Shantle Software	379
Local Manuscript	445
PC TEX, Personal TEX	229
TJ Sel. Word Proc., TCI Software Res.	499

STATISTICS

ABSTAT, Anderson Bell	\$ 315
CSS, StatSoft	469
Microstat, EcoSoft	319
MSA STATPAK, Northwest	749
P-STAT	859
SPSS/PC	749
StatPac Gold, Waverly Associates	539
STAT-2, StatSoft	135
SYSTAT	409

ADDITIONAL SEE PRODUCTS

ATLAS*GRAPHICS, STSC	\$ 339
Atena, Curtis Technical Soft.	29
Engineer's Aide, Eng Prog Concepts	649
LASCAN 1000 Calculator	55
PC-Math, The Math Works	659
Control System Toolbox	375
System ID Toolbox	379
POINT FIVE, Pacific Crest	279
The Professional Wheel, Data Int.	139
The Scientific Wheel, Data Int.	139
Unika, Curtis Technical Soft.	25

BASIC LANGUAGE

Microsoft's QuickBASIC	\$ 85
T BASIC, TransEra Corp.	445
Turbo BASIC, Borland	89
Turbo BASIC Toolboxes	CALL

C COMPILERS

Lattice C	\$ 275
Microsoft C	289
Quint C, Microsoft	65
Turbo C, Borland	89

Ordering Information

All orders American Express, M.C., VISA and PERSONAL CHECK. There is no surcharge on credit cards or C.O.D. New York State residents must add sales tax. Shipping and handling \$3.95 per copy. Rush service is available. * International orders add \$10.00 export surcharge. * Prices and options may change without notice. * Dealers & Corporate Buyers call for special rates. * Mail orders may include phone number. * Add for initials before you buy. Some manufacturers won't ship returns if you don't ship order.

GOTO

FORTRAN LANGUAGE

DIFF-8-0, Microcomputes	\$ 449
Extand, Design Decisions	119
Graphics or Plots, Microcomputes	119
Lahay FORTRAN	CALL
Lahay Personal FORTRAN	89
MathPac, Systolic Systems	445
Microsoft FORTRAN w/CodeView	299
Numerical Analysis, Magus	249
RM/FORTRAN, Ryan-McFarland	479
Spide/H/L Library, Laboratory LTD.	135
SP/PC, Lattice	279

GAUSS

GAUSS Prog. Lang., Aptech Sys	\$ 186
GAUSS Math & Stat System	339

MODULA-2

Logitech Modula-2 Dev. Sys.	\$ 199
Modula-2, B&B Tools, Quinn-Curtis	69

PASCAL

Mitrosylor D.A. Tools	\$ 89
Other Turbo Pascal ADD-ONS	CALL
Pascal-2, Oregon Software	329
Turbo Pascal, Borland	89
Developer Toolkit	269
Numerical Methods Toolkit	69
Turbo Pascal B&B Tools, Quinn-Curtis	69

X-ASMS SIMULATORS

Microsoft, Notes, Ultrason, Quest	CALL
-----------------------------------	------

Call for your FREE catalog today!
In the U.S. CALL
1-800-333-3141
International Orders 914-332-0756

Science & Engineering SOFTWARE CO.

55 South Broadway, Tarrytown, NY 10591

PcPRIME Systems, Inc.

**30-DAY MONEY BACK
OPEN 7 DAYS**



Boston
59 Prince St.
Boston, MA 02145
1-800-451-5279

Atlanta
5231 E. Imperial Drive, Suite 206
Sandy Springs, GA 30083
1-800-451-5279

New York
135 W. 28th St. 8th Fl.
New York, NY 10001
212-627-4485

Los Angeles
6851 Warner St., Suite 734
Huntington Beach, CA 92647
1-800-451-5279

Wire Transfer
Chemical Bank
305 Seventh Ave., NY, NY 10001
(For the Use of PcPRIME Systems, Inc.)
Acct. # 021 020877

FAX: (212) 627-6864

PcPRIME 88

640K 8 MHz
10 MHz Optional



Fully IBM® Compatible
Phoenix BIOS

\$650

- 100% IBM XT Compatible
- Phoenix BIOS Installed
- One 12" High Res. Amber Monitor (720x350)
- Hercules Graphics Emulation Card w/ Printer Port
- Intel 80286 Running at 4.77/8.0 MHz
- 640K RAM on Board
- Two 5 1/4" 360K Half-Height Floppy Direct Drives
- 2 Fully IBM Compatible Expansion Slots
- Runs all MS-DOS Programs including 1-2-3, WordStar, Simultron, Database Plus, AutoCAD, WordStar, WordPerfect, etc.
- Operates MS-DOS, PC DOS, GW Basic, Novell, Xenix, Unix
- Keyboard Selectable 4.77 and 8.0 MHz
- Accepts an IBM Parts
- 150 Watts 110/220 VAC Power Supply w/Four Cables
- Keyboard w/LEDs, Enlarged Return/Shift Keys w/84 Keys
- Two Printer Ports/One Serial Port/One Light Pen Port
- Multi-I/O Card Controls Two Floppy Drives
- Printer Port/Name Port/Serial Port 2nd Optional
- Battery Back-up w/Real Time Clock/Calendar
- 80287 Math Co-Processor Socket Installed on Board
- 6 EPROM Sockets also Installed on Board
- Power-on Self Testing of System Components
- Speaker for Audio or Music Use
- Nickel Plated, Enamel Coating, Heavy Duty Metal Case
- Six Slots Still Left Open after Systems Configuration
- Optional 2.5 MB RAM Card for Expanding Memory
- Optional 14" Dual Frequency Servit-Based Monitor
- Optional 12" Server Based Monitor
- Optional Black/White or Green Monitor
- Optional 10 MHz or NEC V 20 Microprocessor
- Optional Enhanced Keyboard w/101 Keys & 12 F Keys
- Optional 1200/2400 Internal External Modem
- Optional 12 MB 3 1/2" Drive
- Optional 720K/1.44 MB 3 1/2" Half-Height Floppy Drive
- Optional Color Systems w/High Res. (640x200 or 640x400)
- Optional 20/30 MB Hard Disk Systems
- Optional Autowatch EGA Systems/Printer of all kinds
- Ready for Network's Multi-User Mouse Joy Stick Interface
- Ready for 20/30MB Tape Backup Installation

PcPRIME 88 W/20 MB & 1 Floppy
Seagate ST 225, 65 MS \$900
PcPRIME 88 w/30 MB & 1 Floppy
Seagate ST 238, 65 MS \$950

Network/Multi-User Installations

PcPRIME 286

ONE MEGabyte 10 MHz
12 MHz/"0" Wait Optional



Fully IBM® Compatible
Phoenix BIOS

\$1,100

- 100% IBM AT Compatible
- Phoenix BIOS Installed
- One 12" High Res. Amber Monitor (720x350)
- Hercules Graphics Emulation Card w/ Printer Port
- Intel 80286 Running at Dual Speed 6 and 10 MHz
- Chip Technology VLSI Chip Set
- Runs all MS-DOS Programs including 1-2-3, WordStar, Simultron, Database Plus, AutoCAD, WordStar, WordPerfect, etc.
- Operates MS-DOS, PC DOS, GW Basic, Novell, Xenix and Unix
- One Megabyte RAM on Board
- 8 Expansion Slots. Six 16-Bit Two 8-Bit
- WD-Combined Hard Disk/Floppy Disk Controller Controls Two Hard Disks and Two Floppies
- Keyboard w/LEDs and Enlarged Return/Shift Keys w/84 Keys
- Accepts an IBM Parts
- 220 Watts 110/220 VAC Power Supply w/Four Cables
- Hardware Reset Button/Turbo Light Indicator Installed
- One Fullsize 12 MB Half-Height High Density Floppy
- One RS-232 Serial Card w/2nd Port Optional
- Real-Time Clock & Calendar w/Battery Back-up
- Nickel Plated, Enamel Coating, Heavy Duty Metal Case
- Speaker for Audio or Music Use
- Power-On Self Testing of System Components
- 80287 Math Co-Processor Socket Installed on Board
- Power and Hard Disk Indicator Lights Installed
- Five Slots Still Left Open after Systems Configuration
- Ready for OS/2 Operating Systems
- Optional 3.5 MB RAM Card for Expanding Memory
- Optional 14" Flat Screen Servit Based Monitor
- Optional Black/White or Green Monitor
- Optional Enhanced Keyboard w/101 Keys & 12 F Keys
- Optional 720K/1.44 MB 3 1/2" Half-Height Drive
- Optional 360K/5.25" 100 Half-Height Floppy Direct Drive
- Optional 1200/2400 Internal External Modem
- Optional Color Systems w/High-Res. (640x200 or 640x400)
- Optional 12" or 14" Wait MHz Systems
- Optional Autowatch EGA Systems/Printer of all kinds
- Optional 14" Flat Screen Servit Based Monitor
- Optional 14" Flat Screen Servit Based Monitor
- Ready for 40/80/130 MB Hard Disk Installation
- Ready for 20/30MB Tape Backup Installation
- Ready for Network's Multi-User Mouse Joy Stick Interface
- Ready for Mouse/Joy Stick Interface

PcPRIME 286 Systems ... \$1,600
W/40 MB Seagate ST-251, 40 MS

ALL PcPRIME SYSTEMS FEATURE:

- Operating Manual for Monitor, Keyboard, Motherboard
- 30-Day Money Back Guarantee
- Fully Set-Up and Diagnostic Tested in America
- 72 hours Burn-in Period
- 30-Day Money Back Guarantee
- One Year Fully Warranted Labor & Parts
- Shipping incl UPS
- We Ship APDs and FPOs too
- Ready for Immediate Delivery

PcPRIME 386

ONE MEGabyte 16 MHz
"0" WAIT



Fully Compaq Compatible
Phoenix BIOS

\$2,300

- 100% Compaq 386 Compatible
- Phoenix 386 or Award BIOS Installed
- One 12" Servit-Based High Res. 1720x350 Amber Monitor
- Hercules Graphics Emulation Card w/ Printer Port
- Intel 80386 32-Bit Running at 16 MHz 1/2 Wait State
- Runs all MS-DOS Software including Lotus 1-2-3, WordStar, AutoCAD, Flight Simulator, Database Plus, Symphony, etc.
- Operates MS-DOS 2.1, 3.1, 3.2, 3.3, GW Basic, PC DOS, Unix, Xenix
- Keyboard Switchable between 16 MHz 1/2 Wait or 8 MHz
- One Megabyte Parity Checked Static Column RAM on Board
- 8 Expansion Slots 2 8-Bit, 5 16-Bit, 1 32-Bit
- 20-Bit Star Can Support Up to 16 Megabytes of RAM
- Three Address Modes:
 1. 8086 Compatible Real Address Mode
 2. Protected 80286 Virtual Address Mode
 3. Protected 80386 Virtual Address Mode
- Stream Interrupts/Seven Direct Memory Access (DMA)
- 64 Terabytes of Virtual Address Space
- 80287/80287 Math Co-Processor Socket Installed on Board
- Real Time Clock & Calendar on Board w/Battery Back-up
- Enhanced Keyboard w/LEDs and Enlarged Return Shift Keys
- Software Utility to Emulate Expanded Memory for Lotus 123, Etc.
- WD-Combined Hard Disk/Floppy Disk Controller Controls Two Hard Disks and Two Floppies
- Hardware Reset Button/Turbo Indicator Light/Speaker Installed
- Internal Address Bus/Memory Interface BIOS at 32-Bit
- Integrated Memory Management Utility/386 Memory Support
- Hardware Fixed Point Multiply and Divide
- Standard & MHz 1/0 Channel Firing/Optional Inst. Execution
- 220 Watts 110/220 VAC Power Supply w/Four Cables
- One Fullsize 12 MB Half-Height High Density Floppy
- One RS-232 Serial Card w/2nd Port Optional
- Nickel Plated, Enamel Coating, Heavy Duty Metal Case
- Power-On Self Testing of System Components
- Power and Hard Disk Indicator Lights Installed
- Five Slots Still Left Open after Systems Configuration
- Optional Black/White or Green Monitor
- Optional 14" Flat Screen Servit Based Monitor
- Optional Enhanced Keyboard w/101 Keys & 12 F Keys
- Optional 720K/1.44 MB 3 1/2" Half-Height Floppy Drive
- Optional 1200/2400 Internal External Modem
- Optional Color Systems w/High-Res. (640x200 or 640x400)
- Optional 20/30 MHz Systems
- Optional Autowatch EGA Systems/Printer of all kinds
- Ready for 40/80/130/160 MB Hard Disk Installation
- Ready for 20/30MB Tape Backup Installation
- Ready for Network/Multi-User/Multi-Tasking Systems
- Ready for Network File Servers/Mouse/Joy Stick

PcPRIME 386 Systems ... \$2,600
W/40 MB Seagate ST-251, 40 MS



Terribly Fast.

- Enlarged Shift/Return Keys w/ Tactile Feel
- Power Lock Key Installed
- Contrast Adjusting Knob
- Brightness Adjusting Knob
- Turbo Speed Light Indicator
- Hold the a/Back Button
- 8" High Res. 1720x350 Dual Frequency Amber Monitor Accepts Both Mono and Color Card
- Dimension 17.3" x 8.2" x 16.8"
- Weight 25-28 LBS
- 150W or 200W Power Supply
- Three Half-Height Drive Slots
- Reinforced Aluminum Frame
- 7 Expansion Slots Available
- Optional EGA/Color Systems

PcPRIME 88 Portable Configured Same as PcPRIME 88 W/20 MB Seagate ST-225, 65 MB, One Floppy	\$1,000 \$1,300
PcPRIME 286 Portable Configured Same as PcPRIME 286 W/40 MB Seagate ST-251, 40 MS	\$1,600 \$2,150
PcPRIME 386 Portable Configured Same as PcPRIME 386 W/40 MB Seagate ST-251, 40 MS	\$2,600 \$3,500

Circle 195 on Reader Service Card



Solver-Q
A Numerical Analysis & Equation Handling Program
"... This is a wonderful program."
Mathematics Instructor.
"... it was a life saver..."
Statistics Professor.

- Enter equations easily, edit, and solve it's that simple.
- Equations readable from any ASCII text file.
- Symbolic manipulation.
- Up to 1000 non-linear equations.
- Requires IBM PC, 256k or more.
- \$40 academic, \$90 commercial.

See Nov. '87 BYTE "WHAT'S NEW" page 94

University of Wisconsin-Madison
1025 West Johnson Street
Madison, WI 53706
800/282-8243, WI 800/362-3020

Circle 232 on Reader Service Card

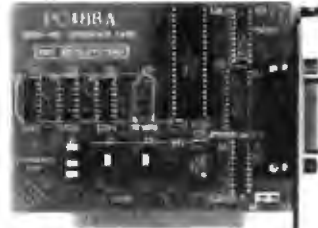

PC488 \$145
LOW COST PC/XT/AT INTERFACE FOR IEEE-488 (GPIB/HPIB)

- SHORT CARD FOR PC/XT/AT & COMPATIBLES
- 1 GP & INTERRUPT LEVELS
- 1 OF 2 DMA CHANNELS
- UP TO 4 BOARDS PER COMPUTER
- CONTROLLER / TALKER / LISTENER
- INCLUDES SOFTWARE DRIVERS
- CUSTOM SOFTWARE SUPPORT AVAILABLE
- COMPATIBLE WITH MOST IEEE488 SOFTWARE PACKAGES FOR THE IBM PC
- QUANTITY DISCOUNTS

Call today for details!!!

B&C MICROSYSTEMS
355 West Olive Ave, Sunnyvale, CA 94086
PH: (408)730-5511 FAX: (408)730-5521 TELEX: 964185
VISA & MC accepted.

Circle 34 on Reader Service Card

Set up a complete graphics workstation on your PC for under \$100!

PC-PLOT-III graphics terminal emulator software package enables IBM PC's and compatibles to appear to a mainframe as DEC-VT-100/200, VT-52, Retrographics VT-640 or Tektronix 4010/4014 and 4027 terminals. The program also provides valuable communication commands and more.

An enhanced version, PC-PLOT-IV, further allows complete Tektronix 4105 terminal emulation.

For more information call **614/882-4786**



659-H Park Meadow Rd. Westerville, OH 43081

Circle 167 on Reader Service Card

SPECIAL EPROM PROGRAMMER



APROTEK 1000 ONLY \$225.00
COMPLETE WITH PERSONALITY MODULE

117 AC POWER-RS-232 CONNECT
-8 BAUD RATES - HANDSHAKE TO HOST
ALLOWS READ, WRITE, VERIFY & COPY

Come complete with IBM-PC, Apple IIe, or CPM (Specify Computer) Driver Program on Disc

Programs the following 5 Volt 24 or 28 pin devices: 2716 series through 27512, 28xx series, 88764 plus others. Please Specify Personality Module desired with order. Additional Personality Modules only \$15.00 ea. Full 1 year warranty.

TO ORDER CALL 1-800-962-5800 OR WRITE:
APROTEK
1071 A AVENIDA ACASO Atlix
CAMARILLO CA 93010 \$4.00 Shipping USA
Info: 180519872464 VISA or MC Add'l 3
We Accept Govt, School & Large Corp. P.O.

Circle 23 on Reader Service Card

PC+MIDI = MUSIC

It's a simple equation. To plug your PC or PC-compatible into the modern world of music-making, use the complete line of MIDI software and hardware from VOYETRA TECHNOLOGIES.

- SEQUENCER PLUS: 65-track total MIDI recorder/editor
- CONVERSION PLUS: file converter for music notation programs
- PATCH MASTER: network organizer and sound librarian
- OP-4001: PC/MIDI interface card

"I've never seen a more powerful, easy-to-use music and recording system bug-free!" (PC COMPANION)

For more information contact VOYETRA TECHNOLOGIES, Dept. PC, 426 MI Pleasant Avenue, Mamaroneck NY 10543 or call (914) 698-3377

Circle 276 on Reader Service Card

SAVE ON 9 TRACK TAPE SYSTEM
FOR IBM PC/XT/AT



- Mainframe to PC Data Transfer
- High Speed Backup
- All Software, Complete System
- Service and Support easy installation

call (818) 343-8506 or write to
Contact Computer Corp.
P.O. Box 153 Tarzana, Calif. 91356

CONTECH

Circle 67 on Reader Service Card

DISKS To Go



100% certified and tested. Error free life time warranty. All disks include generic white box, Tyvek sleeves, labels, write protect tabs, shrink wrapped.

- 5.25 Black Disks, DS/DD36 ea.
- 5.25 Color Disks, 8 Colors Available, DS/DD46 ea.
- 5.25 Black Disks, DS/HD86 ea.
- 5.25 Color Disks, 8 Colors Available, DS/HD94 ea.
- 3.5 Blue or Gray Disks, DS/DD98 ea.
- 3.5 Color Disks, 7 Colors Available, DS/DD 1.10 ea.

BULK MEDIA AVAILABLE

- 5.25 DS/DD32 ea.
- 5.25 DS/DD Colors42 ea.
- 5.25 DS/HD82 ea.
- 5.25 DS/HD Colors90 ea.
- 3.5 DS/HD Blue or Gray95 ea.
- 3.5 DS/DD Colors 1.07 ea.
- 5.25 Tyvek Sleeves0275 ea.
- 5.25 Paper Sleeves0175 ea.
- 5.25 Label Sheet08 ea.
- 3.5 Label Sheet20 ea.
- 5.25 White Box15 ea.
- 3.5 White Box14 ea.

LABELS To Go

CONTINUOUS FORM LABELS

Size	Across	Box Qty.	Price Per/1000
2 1/4 x 7/16	1 across	10,000	\$1.95
2 1/4 x 7/16	4 across	20,000	\$1.95
2 1/2 x 15/16	1 across	5,000	\$2.18
2 1/2 x 15/16	3 across	15,000	\$1.98
3 x 15/16	4 across	20,000	\$2.00
3.3 x 15/16	4 across	20,000	\$2.05
3 1/2 x 15/16	1 across	5,000	\$1.90
3 1/2 x 15/16	2 across	10,000	\$1.90
3 1/2 x 15/16	3 across	15,000	\$1.90
3 1/2 x 15/16	4 across	20,000	\$1.90
4 x 15/16	1 across	5,000	\$3.21
4 x 15/16	3 across	15,000	\$3.21
4 x 1-7/16	1 across	5,000	\$3.25
4 x 1-7/16	3 across	15,000	\$3.25

Prices quoted for full boxes only. All orders F.O.B. Westville, NJ. COD orders - add \$1.90.

1040 Broadway
Westville, NJ 08093
609-456-6996
FAX# 609-456-7172

All orders F.O.B. Westville, NJ.
COD orders add \$1.90. Visa & MC accepted.
All orders shipped same day.

RS-422/232 CURRENT LOOP



DS-225

- Single channel async communication board for IBM PC/XT/AT
- Software selectable to be RS/422/485, 232 or Current Loop
- Selectable Address & Interrupt

1-800-553-1170



478 E. Exchange St., Akron, OH 44304
(216) 434-3154 TLX: 5101012728

Circle 212 on Reader Service Card

Power Control

110/220 AC by your IBM-PC



The boards allow you to Control/Monitor high voltage AC/DC power lines with your IBM-PC/XT/AT or compatible while providing optical isolation.

1-800-553-1170



478 E. Exchange St., Akron, OH 44304
(216) 434-3154 TLX: 5101012728

Circle 213 on Reader Service Card

RS-422 Communications Board

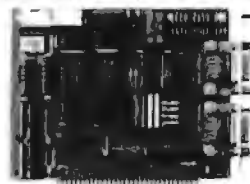

- For IBM PC/XT/AT/PS/2
- Dual channel RS-422/RS-485
- Selectable/shareable interrupts
- Differential drivers to 4000 ft.
- Immediate delivery

1-800-553-1170



Leaders in Communication Technology
478 E. Exchange St., Akron, OH 44304
(216) 434-3154 TLX: 5101012728

Circle 214 on Reader Service Card

72 Digital I/O



PXB-721

Parallel Expansion Board

- For IBM-PC & Compatibles
- 72 Digital I/O Lines
- Simple Programming
- Uses One Expansion Slot
- Fast Delivery

\$195

1-800-553-1170

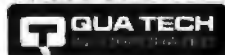

478 E. Exchange St., Akron, OH 44304
(216) 434-3154 TLX: 5101012728

Circle 215 on Reader Service Card

MODULAR DATA ACQUISITION



- FOR IBM & Compatibles
- Flexible and Inexpensive
- Money Back Guarantee
- Free Technical Support

Fast Delivery

1-800-553-1170



Leaders in Communication Technology
478 E. Exchange St., Akron, OH 44304
(216) 434-3154 TLX: 5101012728

Circle 216 on Reader Service Card

IEEE-488



MXI-100

- GPIB controller board for IBM PC/XT/AT
- Control up to 14 Devices
- User friendly Software Commands
- DMA Transfer to 200k byte/sec.

\$345.00 including software



478 E. Exchange St., Akron, OH 44304
(216) 434-3154 TLX: 5101012728
800-553-1170

Circle 217 on Reader Service Card

RS-232 Communications Board



- For IBM-PC/XT/AT & comp.
- Dual RS-232C Interface
- Optional software supports COM1, COM2, COM3, COM4
- Jumper selectable interrupts

Fast Delivery

1-800-553-1170



478 E. Exchange St., Akron, OH 44304
(216) 434-3154 TLX: 5101012728

Circle 218 on Reader Service Card

WAVEFORM SYNTHESIZER

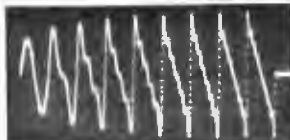

- For IBM PC/XT/AT and compatibles
- Generates user-definable signal
- Up to 2000 points per envelope

\$795.00

1-800-553-1170



478 E. Exchange St., Akron, OH 44304
(216) 434-3154 TLX: 5101012728

Circle 219 on Reader Service Card

RS-422 Communications Board FOR

PS/2

MODELS 50, 60, 80

- DUAL CHANNEL
- ADDRESS SELECTABLE
- BAUD RATE TO 256 K
- INTERRUPT SELECTABLE

1-800-553-1170



Leaders in Communication Technology

478 E. EXCHANGE ST
AKRON, OH 44304
(216) 434-3154 TLX: 5101012728
FAX: (216) 434-1409

Circle 220 on Reader Service Card

MASTER THE "NEW ELECTRONICS" WITH MCGRAW-HILL'S Contemporary Electronics Series

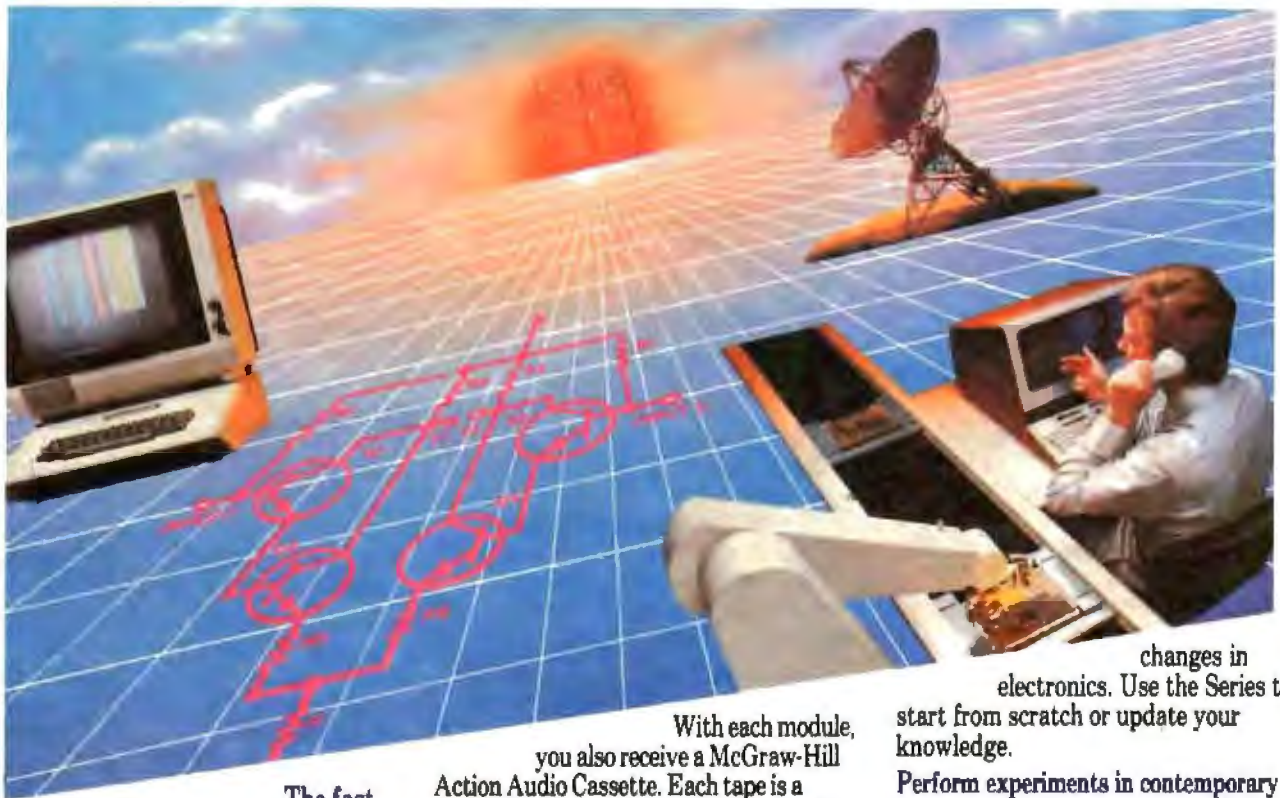

The fast, easy and low cost way to meet the challenges of today's electronic innovations. A unique learning series that's as innovative as the circuitry it explains, as fascinating as the experiments you build and explore!

From digital logic to the latest 32-bit microprocessor, you master one subject at a time with the McGraw-Hill Contemporary Electronics Series. Fifteen unique *Concept Modules*, sent to you one every 4-6 weeks, give you a handle on subjects like opto-electronics, transistors, integrated circuits, logic circuits, and more.

Each *Concept Module* goes right to the heart of the matter. You waste no time on extraneous material or outdated history. It's a fast, efficient, and lively learning experience... a non-traditional approach to the most modern of subject matter.

Unique Interactive Instruction

Your learning experience is reinforced through the integration of vividly illustrated text with actual electronic experiments.

With each module, you also receive a McGraw-Hill Action Audio Cassette. Each tape is a dynamic discussion that drives home the key facts about the subject. Indexed binders preserve backup material, notes and tapes for convenient referral.

Understand digital logic... microprocessors... and more.

McGraw-Hill's Contemporary Electronics Series is an extraordinary opportunity to update your understanding of today's most important technological

changes in electronics. Use the Series to start from scratch or update your knowledge.

Perform experiments in contemporary electronics.

Throughout your series, laboratory experiments reinforce every significant point. This essential experience... dynamic, hands-on demonstrations of theory in practice... will help you master principles that apply all the way up to tomorrow's latest VLSI (very large scale integrated) circuitry.

See other side for more details →

SEND THIS CARD TODAY!

YES! I'm interested in learning contemporary electronics and would like to examine the first module in the series. If I decide to keep it, I will pay just \$19.95 plus \$2.25 shipping and handling. I will then receive future modules automatically, one every 4 to 6 weeks. Each of the 15 modules in the series is \$19.95 plus \$2.25 shipping and handling, and comes on the same 15-day Free Examination basis. There is no minimum number of modules that I must buy, and I may cancel at any time simply by notifying you.

If I do not choose to keep the first module, I will return all materials in good condition and pay nothing. Future modules will be canceled, and I will be under no further obligation.

Name _____ (Please Print)

Address _____

City _____ State _____ Zip _____

Phone No. (_____) _____

All orders subject to approval and payable in U.S. funds only. Available in U.S. and Canada only.

2080-038

Your adventure begins with Module 1

With your first module, you'll use the latest digital integrated circuits to build an oscillator circuit that demonstrates digital signals—verified visually by the flash of light emitting diodes (LEDs).

You'll learn concepts applicable to all electronic circuits. With the first module, you will be able to identify the major passive components like resistors, capacitors, inductors, diodes and transformers, and active components such as transistors and integrated circuits.

Each module adds more to your expanding knowledge of the new electronics. You'll cover every important subject in contemporary electronics:

- Digital logic
- Digital gates (TTL, CMOS, ECL, NMOS)
- Flip-flops, counters, and registers
- Op-amps and applications
- Power supplies (plus IC and switching regulations)



Working with actual electronic components, you discover first-hand the operation of the circuitry found in contemporary electronic devices.

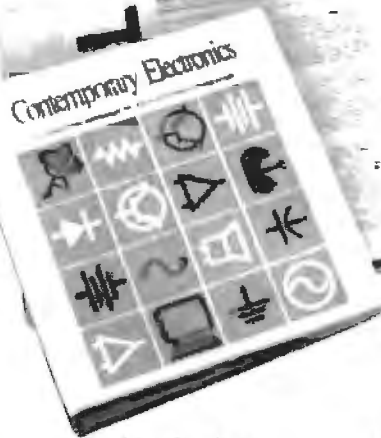

- Combinational logic circuits (ROMs, PLAs, decoders, etc.)
- Circuit analysis, AC theory, LCR networks
- Transistors (bipolar and FETs, diodes, thyristors)
- Integrated circuits (linear and digital)
- Oscillators and function generators
- Modulation and demodulation
- Optoelectronics
- Digital multimeters and scopes
- Microprocessors
- Electronic troubleshooting
- Data communications
- Robotics and industrial controls
- and more!

For anyone interested in electronics

The Contemporary Electronic Series is designed for anyone from hobbyist to professional. It's for you if you're looking for new fields of interest... if you're a teacher who wants an update in contemporary circuits... an industrial manager

With your first module, you get easy-to-follow text and interactive audio instruction. Plus you build this solderless breadboarding system, which you'll use throughout the Series to construct electronic circuits and bring concepts to life.



or supervisor... a doctor, an engineer, a chemist, or anyone who finds electronics playing an increasingly important role in their work. It's even for electronics engineers, technicians and scientists who feel their training needs freshening up. It's the quickest, most convenient, and probably the least expensive way to do it. And the only one that gives you hands-on experience.

15 day no-risk trial

We invite you to prove to yourself that the Contemporary Electronics Series is all we say it is... without risk and without committing yourself in any way. Return the reply card and we'll send you the first module for a free, 15-day examination. If you're not absolutely certain that this is an enjoyable as well as highly effective way to learn, simply return the module to us.

If you want to continue, we'll ship the remaining modules automatically, about once a month, for only \$19.95 plus \$2.25 for shipping and handling.

Return the postage-paid reply card today! And let McGraw-Hill guide you into the fascinating world of Contemporary Electronics. If the card has been used, write us for ordering information.

SEND CARD TODAY FOR YOUR FIRST MODULE!



BUSINESS REPLY MAIL

FIRST CLASS MAIL PERMIT NO 10008 WASHINGTON D C

POSTAGE WILL BE PAID BY ADDRESSEE

McGraw-Hill Continuing
Education Center
3939 Wisconsin Avenue
Washington, D C 20077-9265

NO POSTAGE
NECESSARY
IF MAILED
IN THE
UNITED STATES



McGraw-Hill
Continuing Education Center
3939 Wisconsin Avenue
Washington, D.C. 20016

Send card today for your first module!



BYTE LISTINGS YOUR WAY!

It's easy. Now there are three ways to get source-code listings that go with BYTE articles—on disk, in print or on line.

LISTINGS ON DISK

BYTE listings on disk are right for you if you want to compile or run programs quickly. Disks are now available by annual subscription as well as individual orders. BYTE offers listings in 11 popular disk formats.

LISTINGS IN PRINT

This print supplement contains source-code listings described in the issues of BYTE.

LISTINGS FROM BIX

(BYTE Information Exchange) By joining BIX, you can download BYTE source-code listings at standard BIX rates. See BIX informational ad listed in Reader Service index in this issue.



FOR DIRECT ORDERING CALL TOLL FREE: 800-258-5485

Call: M-F, 8:30 a.m. to 4:30 p.m. Eastern Time

(603-924-9281 for New Hampshire residents)

For credit card orders only.

ON DISK

Please send me single disks in the format checked for the following 1987 issues:

- | | |
|-----------------------------------|---------------------------------------|
| <input type="checkbox"/> January | <input type="checkbox"/> August |
| <input type="checkbox"/> February | <input type="checkbox"/> September |
| <input type="checkbox"/> March | <input type="checkbox"/> October |
| <input type="checkbox"/> April | <input type="checkbox"/> November |
| <input type="checkbox"/> May | <input type="checkbox"/> December |
| <input type="checkbox"/> June | <input type="checkbox"/> IBM PC Issue |
| <input type="checkbox"/> July | |

Disks of listings for December 1985 and all 1986 issues are available at the prices stated at the right. Please mark the appropriate format and note the issue date below.

Month _____
Year _____

	IN USA:		OUTSIDE USA:	
	Single Month (one disk)	Annual Subscription (13 disks)	Single Month (one disk)	Annual Subscription (13 disks)
5 1/4 inch: <input type="checkbox"/> IBM PC <input type="checkbox"/> Apple II <input type="checkbox"/> Kaypro 2 CP/M <input type="checkbox"/> Tandy Mod 4 <input type="checkbox"/> MS-DOS 8 Sector <input type="checkbox"/> TI Professional	<input type="checkbox"/> \$8.95	<input type="checkbox"/> \$69.95 (Save \$48.40)	<input type="checkbox"/> \$10.95	<input type="checkbox"/> \$89.95 (Save \$52.40)
3 1/2 inch: <input type="checkbox"/> Apple Macintosh <input type="checkbox"/> Atari ST <input type="checkbox"/> Amiga <input type="checkbox"/> HP 150 <input type="checkbox"/> IBM PS/2	<input type="checkbox"/> \$9.95	<input type="checkbox"/> \$79.95 (Save \$49.40)	<input type="checkbox"/> \$11.95	<input type="checkbox"/> \$99.95 (Save \$55.40)
8 inch: <input type="checkbox"/> CP/M	<input type="checkbox"/> \$9.95	<input type="checkbox"/> \$79.95 (Save \$49.40)	<input type="checkbox"/> \$11.95	<input type="checkbox"/> \$99.95 (Save \$55.40)

IN PRINT

1987 Annual Supplement Subscription Rates

IN USA:
only \$18.00
(Save \$9.80)

OUTSIDE USA:
only \$21.00
(Save \$10.80)

1987 Supplement Issues

IN USA:

- January through March 1987 for only \$6.95
- April through June 1987 for only \$6.95
- July through September 1987 for only \$6.95
- October through December 1987 for only \$6.95.

OUTSIDE USA:

- January through March 1987 for only \$7.95
- April through June 1987 for only \$7.95.
- June through September 1987 for only \$7.95
- October through December 1987 for only \$7.95

1986 Supplement Issues

IN USA:

- January through June 1986 for only \$8.85
- July through September 1986 for only \$6.95.
- October through December 1986 for only \$6.95
- 1986 Annual Subscription for only \$18.00 (Save \$4.85)

OUTSIDE USA:

- January through June for only \$9.95
- June through September for only \$7.95
- October through December for only \$7.95.
- 1986 Annual Subscription for only \$21.00 (Save \$4.85)

COMBINED DISK AND PRINT SUBSCRIPTION

Bundled together, giving you the convenience of disk-based source-code plus the ease of reference of print.

	IN USA:	OUTSIDE USA:
	Annual Subscription (13 disks & 4 issues)	Annual Subscription (13 disks & 4 issues)
5 1/4 inch: <input type="checkbox"/> IBM PC <input type="checkbox"/> Apple II <input type="checkbox"/> Kaypro 2 CP/M <input type="checkbox"/> Tandy Mod 4 <input type="checkbox"/> MS-DOS 8 Sector <input type="checkbox"/> TI Professional	<input type="checkbox"/> \$84.95 (Save \$59.20)	<input type="checkbox"/> \$104.95 (Save \$69.20)
3 1/2 inch: <input type="checkbox"/> Apple Macintosh <input type="checkbox"/> Atari ST <input type="checkbox"/> Amiga <input type="checkbox"/> HP 150 <input type="checkbox"/> IBM PS/2	<input type="checkbox"/> \$94.95 (Save \$62.20)	<input type="checkbox"/> \$114.95 (Save \$72.20)
8 inch: <input type="checkbox"/> CP/M	<input type="checkbox"/> \$94.95 (Save \$62.20)	<input type="checkbox"/> \$114.95 (Save \$72.20)

Listings card

Name _____
Address _____
City _____ State _____ Zip _____
County or Parish _____ Country _____
Credit Card # _____
Exp. Date _____ Signature _____ Date _____

- Check enclosed
- MasterCard
- VISA
- U.S. Funds enclosed (If ordering from outside the U.S. please remit in U.S. funds drawn on a U.S. bank. Thank you.)

Please allow 4-8 weeks for delivery

BYTE

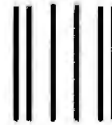

NO POSTAGE
NECESSARY
IF MAILED
IN THE
UNITED STATES

BUSINESS REPLY MAIL
FIRST CLASS MAIL PERMIT NO. 10 PETERBOROUGH, NH

POSTAGE WILL BE PAID BY ADDRESSEE

BYTE Listings

One Phoenix Mill Lane
Peterborough, NH 03458-9990



EPROM PROGRAMMER

From
\$250.00



PC BASED OR
STAND-ALONE / RS-232

From A Name You Can Trust

LOGICAL DEVICES INC.

1201 N.W. 65th Place
Ft. Lauderdale, FL 33309

1-800-331-7766 (305) 974-0967
Telex 383142 Fax (305) 974-8531

Circle 143 on Reader Service Card
(DEALERS: 144)

P-tral
BASIC to Pascal

\$179

TRANSLATOR

Translate your BASIC source programs to Pascal source. P-tral, now available for the IBM PC and compatibles, will translate MS-BASIC/BASICA to Turbo Pascal

(Req Dos 2.0 or later w/ANSI.SYS).

Also available for the Apple II series (incl. IIGS) and converts Applesoft to Apple Pascal.

(212) 206-6490 / 924-0576
WOODCHUCK INDUSTRIES
340 WEST 17TH STREET (#2B)
NEW YORK, NY 10011

Circle 286 on Reader Service Card

DATAFLEX™

- Multi-user Database!
 - Powerful!
 - Multiple Operating System Compatibility!
 - Attractive Dealer Pricing!
 - Full Dealer Support!
- Dealer Inquiries Invited

COGITATE

24000 Telegraph Road
Southfield, Michigan 48034 USA
(313) 352-2345

Circle 55 on Reader Service Card

PAL®/EPLD PROGRAMMER

From
\$689.00



Stand Alone/RS-232 Programs and Verifies 20/24 pin PLDs from MMI, TI, National Cypress, Lattice, AMD, Altera
PAL is a registered trademark of MMI

From A Name You Can Trust

LOGICAL DEVICES INC.

1201 N.W. 65th Place
Ft. Lauderdale, FL 33309

1-800-331-7766 (305) 974-0967
Telex 383142 Fax (305) 974-8531

Circle 145 on Reader Service Card
(DEALERS: 146)

29¢

5.25 DSDD
DISKETTES

100% CERTIFIED
100% GUARANTEED

NAME BRAND QUALITY AT DISCOUNT PRICES

96 TPI DISKETTES 49¢

COLORED VINYL AND CUSTOM LABELS
WRAP-IT SHRINK WRAPPING KIT
CALL FOR QUANTITY DISCOUNTS

DISKETTE PACKAGING MACHINERY

3.5 & 5.25 SLEEVING

LABELING, PRINTING, BULK PACKAGING
VACUUMING, DEGAUSSING

WESCORP WORLD TRADE

1-(800)-338-1805 1-(203)-739-7791

MC/ISA

Circle 279 on Reader Service Card

Share Your Printers!



This Buffered Automatic Print-Controller has 4 Parallel Inputs, and 2 Parallel Outputs! PC and Laser Compatible! Simultaneous Data Path, Multiple Copies and Numeric Display! 64K Buffer is Expandable to 256K! Automatic or Manual Operation! The Best 4 to 2 Printer-Sharing Choice!!!

64K Model Only \$279!

MaxTech Computer Products

Call (918) 437-2600

Call for Best Price Cables + Switches!
No Minimum. COD's and NARPs accepted
Shipping + Handling added. 3% surcharge
on MC/Visa. POB 690958 Tulsa, OK 74169

Circle 154 on Reader Service Card

MUST LIQUIDATE AT HUGE SAVINGS TO YOU!



Hayes
Compatible!

INTERNAL COMPUTER TELEPHONE MODEM

Your Telecommunications Link! Use this intelligent 300/1200 baud Card Modem for a wealth of information. Access large data banks on topics from finance to agriculture. Check the stock market and more. It incorporates LSI microprocessors designed for the IBM PC, AT, PC-XT and compatibles. Plugs into any card slot! Expand your applications, order this closeout item now!

- Hayes Command Set Compatibility
- Auto-Answer and Auto Dial.
- Programmable Dialing, Auto Redial.
- Bell 212A/103 Compatible.
- Accessible Time Base, Help Commands.
- TouchTone/Pulse Dialing, Can Access Long Distance Services.
- On-Board Speaker with Volume Control.
- Diagnostics Help Identify Problems.

**One-Year Limited Factory
Warranty on Parts and Labor.**

List ... **\$199.99** **\$79**

Liquidation Price
Item H-3159-7340-953 S/H: \$5.00 ea.

IBM PC, AT, PC-XT are registered trademarks of International Business Machines Corp.

Credit card customers can order by phone, 24 hours a day, 7 days a week.

Toll-Free: 1-800-328-0609

SEND TO:

GOME Authorized Liquidator

1405 Xenium Lane N/Minneapolis, MN 55441-4494

Send ... Card Modem(s) Item H-3159-7340-953 at \$79 each, plus \$5 each for insured shipping, handling (Minnesota residents add 6% sales tax. Sorry, no C.O.D. orders)

My check or money order is enclosed (No delays in processing orders paid by check)

PLEASE CHECK

Acct No _____ Exp. / _____
PLEASE PRINT CLEARLY

Name _____

Address _____ Apt # _____

City _____

State _____ ZIP _____

Phone (____) _____

Sign Here _____

PC-LabCard SERIES
Lab, Industrial and Engineering I/O Cards
for IBM PC/XT/AT



PCL-714 Super-Lab Card
5 powerful functions in one...

- A/D Converter : 14 bits, 16 differential channels
- D/A Converter : 14 bits, 2 channels
- Digital Input : 16 channels, buffered
- Digital Output : 16 channels, buffered
- Counter/Timer : 3 channels

Software & Daughter Boards

- PC-LabDAS : Menu driven data acquisition software
- UnitScope : Oscilloscope/waveform analysis software
- Screw terminal board, relay output board and opto-isolated D/I board available.

PC-LabCard SERIES
Lab, Industrial and Engineering I/O Cards
for IBM PC/XT/AT

PCL-714	(14 bits) A/D + D/A + D/I + D/O + Timer/Counter Card	\$495
PCL-712	(12 bits) A/D + D/A + D/I + D/O + Timer/Counter Card	\$295
PCL-720	Digital I/O & Counter Card	\$160
PCL-725	Relay & Opto-isolated D/I Card	\$240
PCL-738	Stepping Motor Control Card	\$395
PCL-742	RS-422 Interface Card	\$130
PCL-748	IEEE-488 Interface Card	\$395
PCL-750	Prototype Development Card	\$ 70
PCL-754	PC Slot Extension Kit	\$ 50
PCLS-700	Data Acquisition & Control Software	\$195
PCLS-705	Waveform/Oscilloscope Software	\$125

Dealer and OEM inquiries welcome
Call for free catalog!



1460 Tully Rd #802
San Jose, CA 95122
TEL: (408) 293-6786
FAX: (408) 293-4697

AVPROM™
\$295

For IBM-PC's & compatibles, menu-driven AVPROM programs EPROMs up to 8x faster than serially connected units (20 sec. for 2764)

- Programs 2716 thru 27512A and CMOS variants
- 4- and 10 socket gang versions too

Call for prices
For complete specs free 32 pg development tool catalog, call

800-448-8500,
or 207-236-9055

AVOCET

SYSTEMS INC.
120 Union St., Rockport, ME 04856

Circle 19 on Reader Service Card

SOFTJET

LASERJET PREVIEW SOFTWARE

High speed software simulation of the HP LaserJet laser printer softJET allows accurate, on-screen previewing of output from any application(s) including word processors and text formatters. Can be run memory resident or stand alone. All PCL commands are supported including soft fonts, graphics, rules, patterns and macros. For the IBM PC and PS 2 with CGA, EGA, VGA or Hercules graphics.



\$120.00
(604) 732-4323



Theta Systems Corporation
307 - 2150 West Broadway
Vancouver, B.C., Canada
VBK 4L9 (604) 732-4323

Circle 263 on Reader Service Card

Motion Control & Data Acquisition



on your IBM PC or Apple II and all compatibles

Smart 2 Axis Motion Controller: For many types of motors & encoders. New IC (from HP) allows changes & monitoring on the fly. Optically isolated. W/SOFTWARE \$450 in U.S.

Four Axis Stepper Driver: With SOFTWARE & motor for instant automation. \$95

Fast A/D Board: With programmed gain, 650 KHz, 4 inputs, \$220. Complete Scope hardware & SOFTWARE \$525. Also: 12 Bit A/D Relay Driver, Real Time Clock. Circuit developers Project Book \$25

How do you do it? Use our Local Applications Bus, LAB 40. One host adapter (\$150) supports up to 8 boards like those above, on a 50 ft. ribbon cable.

Please call (415) 755-1978 for free literature.

Computer Continuum

(415) 755-1978
75 Southgate Ave., Suite 6 Modem: (415) 755-1824
Daly City, CA 94015
Telex: 3727438

Circle 260 on Reader Service Card

BIG MOUTH™

REAL VOICE Digital Recording
for your PC XT AT or Compatible

- ◆ **VOICE MAIL SYSTEM**
Full-Featured Unlimited Boxes
- ◆ **TELEMARKETING**
Intelligent Inbound and Outbound Capabilities User Definable Structure
- ◆ **ADVANCED ANSWER CAPABILITIES**
Tailored Message Form, Timed Calls Touch-Tone Remote
- ◆ **AUTODIALER—DATABASE**
Auto Search and Sort Auto Re-dial
- ◆ **VOICEPAD™**
Voice AND Sound Effects for your Programs, Demos and Tutorials

Complete with Hardware, card software, phone cable and external speaker

\$239.00 - 5 yr
(415) 339-TALK

Talking Technology, Inc.
6558 Lucas, Suite 301 Oakland CA 94611

Circle 260 on Reader Service Card

6800/6809
Micro Modules



OEM 6800/6809 MICROCOMPUTER MODULES for dedicated control and monitoring. Interfaces for sensors, transducers, analog signals, solenoids, relays, lamps, pumps, motors, keyboards, displays, IEEE-488, serial I/O, floppy disks.

WINTERK

Winterk Corp
1801 South Street
Lafayette, IN 47904
317-742-8428

Circle 285 on Reader Service Card

עברית

FOREIGN LANGUAGES
ON THE IBM PC & PS/2

Use Arabic, Cyrillic, Farsi, French, German, Greek, Hebrew, Italian, Spanish, Turkish, Vietnamese, etc.. in popular software: WordPerfect, Wordstar, Volkswriter, PC-Write, Dbase, Spreadsheet, Basic, Prolog, Desktop Publishing. Dot matrix and laser option.

EGAS\$75 VGAS\$85 CGA/MDAS\$95
Arabic/Hebrew EGAS\$125 MDAS\$175

VN Labs

4320 Campus Dr., Suite 114
Newport Beach, CA 92660

(714)474-6968

Ελλην

Русский

Circle 275 on Reader Service Card

ROSE ELECTRONICS DATA SWITCHES



SHARE computers, printers, any parallel or serial device
ELIMINATE cable swapping
INEXPENSIVE way to network
COMPATIBLE with all computers
Businesses, Schools, Homes

WE ALSO OFFER
Data Buffers, Line Drivers
Modems, Protocol Converters
Parallel - Serial Converters
Cables, Computers, Printers,
Disk Drives, and more

AUTOMATIC CARETAKER is ideal for a business or school to share a printer or modem among many computers. Operation is fully automatic with no software required.
Parallel or Serial 8 channels \$295 6 channels \$365

MANUAL HARD SWITCH is operated with the flip of a switch. 2 2 and 2 4 models allow simultaneous communication.

Serial 1 2 \$50 1 4 \$ 99 2 2 \$109 2 4 \$159
Parallel 1 2 \$79 1 4 \$129 2 2 \$119 2 4 \$159

LED and spike protection on serial models add \$20

CODE ACTIVATED PORTER connects one computer to multiple peripherals. A software code selects the peripheral.
Parallel or Serial 4 channels - \$295 6 channels - \$395
Buffer option 64K - \$100 256K - \$250

REMOTE TELEPATH connects multiple computers to multiple peripherals. A selector at each computer or terminal chooses up to 4 peripherals and displays busy status.
4 4 \$495 4 8 \$795 selector - \$38

Give a Rose to your computer
ROSE ELECTRONICS (713) 933-7673
P.O. BOX 74271
HOUSTON, TX 77274
MC & VISA Accepted
Dealer inquiries invited
CALL US FOR ALL YOUR INTERFACE NEEDS

Circle 229 on Reader Service Card

C

See how well you can program for

Z80 or HD64180

This professional, IBM PC based, compiler is a complete implementation of the "C" language for the Z80 or HD64180 microprocessor. Includes features such as: function prototyping, 31-character names, single precision floating point, full library source, M80-L80 and SLR Systems compatibility, etc. Hi-Tech™ "C" has been established for years in Australia. Pricing from \$195.00. We also have Z80/HD64180 co-processor cards for IBM-PC and PC/AT. Call for a full catalog of Microprocessor development tools

Z-World

1772A Picasso Ave
Davis, CA 95616
(916) 753-3722



"Z80 Specialists"

In Germany, iSystem Tel: 08131/1687

**8080
Z80
HD64180
CP/M-80**



D64180

Develop code for embedded microprocessors on your IBM-PC using our software tools and coprocessor cards. Test your software on our Z80 and HD64180 coprocessor cards. Execute your CP/M-80 development tools at clock speeds up to 12.5 MHZ! Use our remote debugger to debug in your target system. Complete development systems for less than \$1000.

Z-World

1772A Picasso Ave
Davis, CA 95616
(916) 753-3722



In Germany, iSystem Tel: 08131/1687

Circle 292 on Reader Service Card

Circle 293 on Reader Service Card

LOWEST PRICE

TURBO XT BASIC SYSTEM \$329.00
 * 4.776 MHZ W/PHOENIX BIOS
 * 256K RAM EXPANDABLE TO 640K
 * AT STYLE KEYBOARD
 * XT CASE W/160 WATT PS
 * 360K FLOPPY W/CONTROLLER
 * 10 MHZ OPTIONAL ADD \$15.00
 * 1 YEAR LIMITED WARRANTY AS ABOVE W/MONO, MONITOR & MONOGRAPHICS CARD **\$449.00**

TURBO AT BASIC SYSTEM \$849.00
 * 870 MHZ W/PHOENIX BIOS
 * 512K RAM EXPANDABLE TO 1MB
 * AT CASE W/200 WATT PS
 * 84 KEY AT KEYBOARD
 * 1.2 MB FLOPPY DRIVE
 * FD/HD CONTROLLER
 * 1 YEAR LIMITED WARRANTY

12008 INTERNAL MODEM \$79.00
 VORTEX EGA CARD (640/350) **\$98.00**
 ATI VGA CARD (800/600) **\$199.00**
 SEAGATE 20MB HD W/CONTROLLER **\$285.00**

QUANTITY DISCOUNT AVAILABLE
CALL FOR OTHER PRODUCTS

TYSTAR MANUFACTURING, INC.
214-630-6025

Circle 270 on Reader Service Card

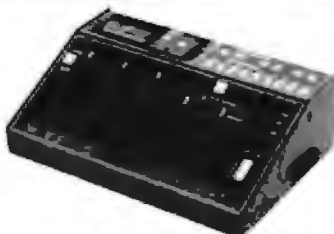

UNIVERSAL EEPROM PROGRAMMER \$495

- No personality modules; Device selection by menu
- Built in Eraser/Timer options (\$50), Flash pad
- Direct technical support, Full 1 year warranty.
- Stand alone duplication & verify (2428 pins)
- Quick polar algorithm (27256 under test)
- All 2428 pin parts to 1 Mbit; CMOS; EEPROMS
- 8741, 7, 4, 8, 8M, 9, 9M, 81, C81, 32, 55, 9761 & more
- IBM-PC, Apple, CPM or Unix driver; Auto baud RS232
- Object code Hex, Binary, Intel & Motorola 8,16,32 bit
- Kits from \$95. Manual with complete schematics. Call today for details!!

B&C MICROSYSTEMS

355 WEST OLIVE AVE SUNNYVALE, CA 94086
 PH (408) 730-5511 FAX (408) 730-5521 TELEX 984115
 See our display ad on page 234. VISA & MC accepted

Circle 33 on Reader Service Card



Sure it's insured?

SAFWARE® Insurance provides full replacement of hardware, media and purchased software. As little as \$39/yr. covers:
 • Fire • Theft • Power Surges
 • Earthquake • Water Damage • Auto Accident

For information or immediate coverage call
1-800-848-3469

In Ohio call 1-614-262-0559



SAFWARE, The Insurance Agency Inc

Circle 231 on Reader Service Card

SCR The Smart Cash Register

- Cash Register/Point of Sale/Inventory
- 100% dBASE III data files
- Import into 1-2-3, Accounting, and most other programs
- Interface to Bar Code, Receipt Printer, Cash Drawer, Register

WE CARRY ALL HARDWARE, TOO!!!

ORDER NOW
(915) 837-7180

SCR — Box 714 Alpine, TX 79831

Circle 235 on Reader Service Card

WITH TYVEK SLEEVES

29¢ ea.

1000+

BULK 5¼" DISKS
Double Side-Double Den.

100% Tested & Certified Error Free, at Minimum 55% Clipping Level or Higher. "Lifetime Warranty". With Tyvek Sleeves & Write on Labels

100	200	600
.38¢ each	.35¢ each	.32¢ each

DEALERS WELCOME

Telex #4933362 • Fax #405-495-4598
Shipping Charges Vary With Quantity Call

Delaware 1-800-451-1849
 Oklahoma 1-800-654-4058
 Nevada 1-800-621-6221

Minimum Order \$25 • Visa, MasterCard or Exp'd, COD add \$25 UPS Delivery • US Mail for AFO, FPO Air Mail or PR add \$10. International for PAL

Qume RIBBONS

Multistrike I	1.99
Multistrike II	2.05
Multistrike III	2.55
Multistrike IV	4.29
Fabric IV	4.39
SuperStrike	3.35

● Printwheels ●

96 character	3.65
130 character	6.00

RIBBON PRICES PER EACH AT ONE DOZEN

Delaware 1-800-451-1849
 Oklahoma 1-800-654-4058
 Nevada 1-800-621-6221

Minimum Order \$25 • Visa, MasterCard or Exp'd, COD add \$25 UPS Delivery • US Mail for AFO, FPO Air Mail or PR add \$10. International for PAL

TELEX #4933362 - FAX #405-495-4598

Dysan CORPORATION

Orders Accepted Worldwide

5¼" D-Side D-Density	5¼" HIGH Density
1195	1395

RX 50 Format	1395	5¼" S-Side 96 tpi	1295	5¼" D-Side 96 tpi	1350
--------------	------	-------------------	------	-------------------	------

8"		
S-Side S-Den. 1795	S-Side D-Den. 1995	D-Side D-Den. 2295

QUANTITY DISCOUNTS

Delaware 1-800-451-1849
 Oklahoma 1-800-654-4058
 Nevada 1-800-621-6221

Minimum Order \$25 • Visa, MasterCard or Exp'd, COD add \$25 UPS Delivery • US Mail for AFO, FPO Air Mail or PR add \$10. International for PAL

Telex #4933362 • Fax #405-495-4598

#E \$55



Chips of Note

#F \$55



Human Dimensions

Striking 16" x 20" Limited Edition Prints from the pages of Byte. Each print is signed and numbered by the artist, Robert Tinney.

Limited Edition Classics

You've seen them on the cover of Byte — now enjoy these delightful images as stunning limited edition prints! Each print pictured here is published in an edition strictly limited to only 1000 signed and numbered prints, and each is accompanied by its own Certificate of Authenticity.

These gorgeous reproductions are printed on select 100% cotton fiber stock, this is a museum grade acid-free paper, highly resistant to yellowing and cracking. You will be assured of a print which will retain its color and beauty for generations.

Price and Shipping

The price of Byte Limited Editions, which depends on the number of unsold prints in each edition, is shown above each print pictured here. In addition, a 15% discount is available if you order two or more prints.

Your prints will be shipped flat, usually within a week of our receipt of the order. Shipping is via UPS Blue Label.

Guarantee

Ship your prints back to us within 30 days of your order, and you will be given a complete, no-questions-asked refund.

#A \$60



Intelligent Reflections

#B \$55

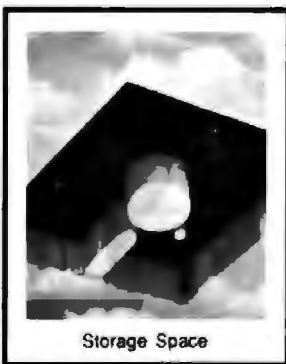

Storage Space

#C \$55



Technological Breakthrough

#D \$55



Number Crunching

Yes! Send me the following Byte Limited Editions.

QTY	#	TITLE	AMOUNT
			\$
			\$
			\$
			\$
			\$
			\$
			\$
Deduct 15% if ordering two or more prints.			\$
Shipping: \$4 (\$20 overseas)			\$
TOTAL			\$

Please send your COLOR brochure

- I have enclosed U.S. check or money order.
 C.O.D. (via UPS—stateside orders only)
 VISA MasterCard American Express

Card #: _____

Expires: _____ Signature: _____

Ship my Print(s) to:

Name: _____

(Business): _____

Address: _____

City: _____

State: _____ Zip: _____

mail this coupon to:

**Robert Tinney
Graphics**

1864 North Pamela Dr.
Baton Rouge, Louisiana
70815

For VISA, MasterCard or
American Express orders,
or for more information

Call 1-504-272-7266



TIMELINE INC.

HAPPY
NEW YEAR!

ORDER DESK ONLY

Continental U.S.A.
(800) 872-8878

Inside California
(800) 223-9977

L.A. & Technical Info
(213) 217-8912

OEM INQUIRIES
WELCOME

\$25

INCREDIBLE PRICE
← **BLOWOUTS!** →

\$99

(0-K MEMORY)

188 WATT SWITCHING POWER SUPPLY

What a DEAL at \$25.00!

On/off switch in the front. Built in filter for easy power cord plug-in. Two 4-pin power plugs for floppy and/or hard disk drives. Large quantity in stock, but **ORDER NOW: WHILE THEY LAST!**

Output: +5.05V at 22A
+12.02V at 4A
-12.0V at 1A
+12.59 Reg., 1.5A D.C.
Dim: 13½L X 5½W X 2¾H

AST™ ADVANTAGE!™ MULTIFUNCTION CARD FOR YOUR IBM PC/AT

Serial, parallel and game port standard 128Kb memory expandable to 1.5 Mb Piggyback allows expansion to 3.0 Mb.

Board with: 512K Memory..... \$175.00
1Mb Memory..... \$235.00
1.5Mb Memory..... \$299.00
Option for 2nd Serial Port \$ 20.00

We bought these from an OEM — BULK PACK. So, no AST™ box or manual. We supply our own manual. 1 Year Warranty.

NIPPON PERIPHERALS FULL HEIGHT HARD DISK DRIVE

Wow! \$7500

10 Mb Unformatted
8.2 Mb Formatted
75 ms average access time

WITH WESTERN DIGITAL ½ CARD

\$149.00

★ FLOPPY DRIVES ★

OLIVETTI

"The Quietest Drive"
DIRECT DRIVE

\$65.00

360K DS/DS 1/2 HT.

QUME

TRACK 142

\$65.00

360K DS/DS 1/2 HT.

REMEX

RFD 480

\$35.00

360K DS/DD 2/3 HT.



THE SPY IN THE SKY

NEC UPD791D

(CHARGE COUPLED DEVICE)
4096 ELEMENT

This unit is a 4096 element linear image sensor that comes with a pre-amplifier board and A/D board. The device can be used for optical character recognition, document scanning or as a spectrometer.

LINEAR IMAGE SENSOR

\$99.00

SCSI CONTROLLER ADAPTEC 4070A

\$99.00

I/O for the ST412-506 interface using RLL encoding

FULCRUM TRACK BALL

- Stationary Mouse
- PC Magazine Editors

\$89

First Choice for CAD Use

ORIG. PRICE ~~\$1390~~
NOW **\$499**

NEED A
COLOR MONITOR
FOR YOUR
MAC II™?

"Makes all other Color
Monitors look like faded
curtains against this profes-
sional graphics display"

1 YEAR WARRANTY
ASK ABOUT OUR COLOR
MONITORS FOR IBM PS/2

1-9 499
10-99 449
100-499 399
500-999 375
1000+ "Let's Talk"

(NO SHORTAGES HERE!)

1490 W. ARTESIA BLVD, GARDENA, CA 90247

Continental U.S.A.

(800) 872-8878

Inside California

(800) 223-9977



L.A. Area & Technical Info

(213) 217-8912

15% Restocking fee for returned orders.

Minimum Order: \$25.00. Shipping & handling charges via UPS Ground: \$.50/lb. UPS Air: \$1.00/lb. Minimum Charge: \$4.00. We accept cashiers checks, MC or VISA. No personal check COD's. Items reflect 5% cash or check discount. California residents add 6½% sales tax. We are not responsible for typographical errors. All merchandise subject to prior sale. Phone orders welcome. Foreign Orders require special handling. Prices subject to change without notice.

**TIME
LINE**

The Amazing A-BUS

NEW

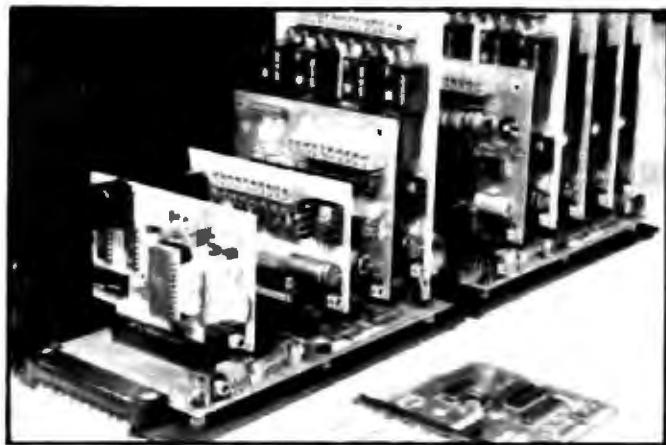

An A-BUS system with two Motherboards
A-BUS adapter (IBM) in foreground

Plug into the future

With the A-BUS you can plug your PC (IBM, Apple, TRS-80) into a future of exciting new applications in the fields of control, monitoring, automation, sensing, robotics, etc.

Alpha's modular A-BUS offers a proven method to build your "custom" system today. Tomorrow, when you are ready to take another step, you will be able to add more functions. This is ideal for first time experimenting and teaching.

A-BUS control can be entirely done in simple BASIC or Pascal, and no knowledge of electronics is required!

An A-BUS system consists of the A-BUS adapter plugged into your computer and a cable to connect the Adapter to 1 or 2 A-BUS cards. The same cable will also fit an A-BUS Motherboard for expansion up to 25 cards in any combination.

The A-BUS is backed by Alpha's continuing support (our 11th year, 50000 customers in over 60 countries).

The complete set of A-BUS User's Manuals is available for \$10

About the A-BUS:

- All the A-BUS cards are very easy to use with any language that can read or write to a Port or Memory. In BASIC use INP and OUT for PEEK and POKE with Apples and Tandy Color Computers
- They are all compatible with each other. You can mix and match up to 25 cards to fit your application. Card addresses are easily set with jumpers
- A-BUS cards are shipped with power supplies (except PD-123) and detailed manuals (including schematics and programming examples)

Relay Card

RE-140: \$129

Includes eight industrial relays. (3 amp contacts SPST) individually controlled and latched. 8 LED's show status. Easy to use (OUT or POKE in BASIC). Card address is jumper selectable.

Reed Relay Card

RE-156: \$99

Same features as above, but uses 8 Reed Relays to switch low level signals (20mA max). Use as a channel selector, solid state relay driver, etc.

Analog Input Card

AD-142: \$129

Eight analog inputs. 0 to +5V range can be expanded to 100V by adding a resistor. 8 bit resolution (20mV). Conversion time 120us. Perfect to measure voltage, temperature, light levels, pressure, etc. Very easy to use.

12 Bit A/D Converter

AN-146: \$139

This analog to digital converter is accurate to 0.25%. Input range is -4V to +4V. Resolution 1 millivolt. The on board amplifier boosts signals up to 50 times to read microvolts. Conversion time is 130ms. Ideal for thermocouple, strain gauge, etc. 1 channel. (Expand to 8 channels using the RE-156 card)

Digital Input Card

IN-141: \$59

The eight inputs are optically isolated, so it's safe and easy to connect any "on/off" devices, such as switches, thermostats, alarm loops, etc. to your computer. To read the eight inputs, simply use BASIC INP (or PEEK)

24 Line TTL I/O

DG-148: \$65

Connect 24 input or output signals (switches or any TTL device) to your computer. The card can be set for input, latched output, strobed output, strobed input, and/or bidirectional strobed I/O. Uses the 8255A chip.

Clock with Alarm

CL-144: \$89

Powerful clock/calendar with battery backup for Time, Date and Alarm setting (time and date); built in alarm relay, led and buzzer. Timing to 1/100 second. Easy to use decimal format. Lithium battery included.

Touch Tone® Decoder

PH-145: \$79

Each tone is converted into a number which is stored on the board. Simply read the number with INP or POKE. Use for remote control projects, etc.

A-BUS Prototyping Card

PR-152: \$15

3 1/2 by 4 1/2 in. with power and ground bus. Fits up to 10 I.C.s



ST-143



CL-144

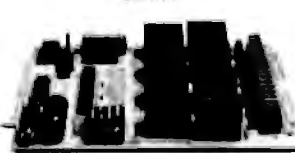

RE-140



IN-141



AD-142

Smart Stepper Controller SC-149: \$299

World's finest stepper controller. On board microprocessor controls 4 motors simultaneously. Incredibly it accepts plain English commands like "Move arm 10 2 inches left". Many complex sequences can be defined as "macros" and stored in the on board memory. For each axis, you can control coordinate (relative or absolute) ramping, speed, step type (half, full, wave), scale factor, units, holding power, etc. Many inputs: 8 limit & "wait until" switches, panic button, etc. On the fly reporting of position, speed, etc. On board drivers (350mA) for small steppers (MO-103). Send for SC-149 flyer. Remote Control Keypad Option RC-121: \$49. To control the 4 motors directly, and "teach" sequences of motions. Power Driver Board Option PD-123: \$89. Boost controller drive to 5 amps per phase. For two motors (eight drivers). Breakout Board Option BB-122: \$19. For easy connection of 2 motors. 3 ft. cable ends with screw terminal board.

Stepper Motor Driver ST-143: \$79

Stepper motors are the ultimate in motion control. The special package (below) includes everything you need to get familiar with them. Each card drives two stepper motors (12V bidirectional 4 phase, 350mA per phase). Special Package: 2 motors (MO-103) + ST-143 PA-181: \$99

Stepper Motors MO-103: \$15 or 4 for \$39

Pancake type 2 1/4" dia. 1/4" shaft 7.5/step, 4 phase bidirectional 300 step/sec. 12V, 36 ohm bipolar. 5 oz-in torque same as Airpak K82701-P2

Current Developments

Intelligent Voice Synthesizer, 14 Bit Analog to Digital converter, 4 Channel Digital to Analog converter, Counter/Timer, Voice Recognition

A-BUS Adapters for:

IBM PC, XT, AT and compatibles. Uses one short slot	AR-133: \$69
Tandy 1000, 1000 EX & SX, 1200, 3000. Uses one short slot	AR-133: \$69
Apple II, II+, IIe. Uses any slot	AR-134: \$49
TRS-80 Model 102, 200. Plugs into 40 pin "system bus"	AR-136: \$69
Model 100. Uses 40 pin socket. (Socket is duplicated on adapter)	AR-135: \$69
TRS-80 Mod 3, 4, 4D. Fits 50 pin bus. (With hard disk use Y-cable)	AR-132: \$49
TRS-80 Model 4P. Includes extra cable. (50 pin bus is recessed)	AR-137: \$62
TRS-80 Model 1. Plugs into 40 pin I/O bus on KB or E/I	AR-131: \$39
Color Computers (Tandy). Fits ROM slot. Multipak or Y-cable	AR-138: \$49

A-BUS Cable (3 ft, 50 cond.) CA-163: \$24

Connects the A-BUS adapter to one A-BUS card or to first Motherboard.

Special cable for two A-BUS cards: CA-162: \$34

A-BUS Motherboard MB-120: \$99

Each Motherboard holds five A-BUS cards. A sixth connector allows a second Motherboard to be added to the first (with connecting cable CA-161: \$12). Up to five Motherboards can be joined this way to a single A-BUS adapter. Sturdy aluminum frame and card guides included.

Add \$3.00 per order for shipping.
Visa, MC, checks, M.O. welcome.
CT & NY residents add sales tax.
C.O.D. add \$3.00 extra.
Canada: shipping is \$5
Overseas add 10%



ALPHA Products

242-B West Avenue, Darien, CT 06820

Technical info (203) 856-1808
Orders only 800 221-0916
Connecticut orders: (203) 348-9436
All lines open weekdays 9 to 5 Eastern time

DiskMASTER®
The Ultimate Diskette Value ...

Discover the Difference ...
2 FOR 1 LIFETIME WARRANTY

NOW IN COLOR

- ✓ Pkg'd in 6 different colors, bulk or boxed
- ✓ Backed by 2 for 1 Lifetime Warranty
- ✓ 100% tested and certified
- ✓ Made to exceed A.N.S.I. specs by 52.5% with a guaranteed clipping level of 65% or above
- ✓ Includes tyvek envelopes (not paper), write protect tabs and user labels
- ✓ Brand-name quality at affordable prices

5-1/4" - 48 TPI DS-DD	OS-HD 96 TPI IBM-AT Compatible
.49	BULK COLOR OR GRAY .90
.59	BOXED COLOR .99

AMERICA'S CENTECH® Premium Quality Color Diskettes

✓ TIMELESS WARRANTY

- ✓ 75%+ clipping level guaranteed
- ✓ Performance exceeds A.N.S.I. spec. by 88%
- ✓ Each disk 100% tested and certified
- ✓ 15 COLORS for data organization
- ✓ Pkgs include tyvek sleeves, w/p tabs, & ID labels

5-1/4" - 48 TPI DS-DD	OS-HD 96 TPI IBM-AT Compatible
.84	PLASTIC STORAGE BOX COLOR 1.39
.63	BULK COLOR 1.15
3-1/2" - 135 TPI DS-DD COLOR	3-1/2" - 135 TPI BLACK DS-HD
1.75	PLASTIC STORAGE BOX 4.90

3M Call for best prices!

BASF

5-1/4" 48 TPI DS-DD	OS-HD 96 TPI IBM-AT Compatible
.75	1.25

Nashua

5-1/4" - 48 TPI DS-DD	OS-HD 96 TPI IBM-AT Compatible
.50	BOXED *1.00*

BULK

32¢ 5-1/4" DS/DD 48 TPI Exceeds ANSI specifications + 6¢ FOR TYVEK

ORDERING INFORMATION

TERMS: P.O. orders accepted, government and schools on net 30. SHIPPING: U.S. orders add \$3.00 per 100 diskettes or fraction thereof, add \$3.00 for COD orders.
PRICE PROMISE: We will better any lower delivered price on the same products and quantities advertised nationally.

Toll Free Order Line: **1-800-233-2477**
Information Line: **1-801-561-0092**

DISC INTERNATIONAL
SUPPLY COMPANY
1375 W. 8400 S. / WEST JORDAN, UT 84088
HRS: 8 AM TO 5 PM (MTRL. TIME)

3M Call for best prices!

BASF

5-1/4" 48 TPI DS-DD	OS-HD 96 TPI IBM-AT Compatible
.75	1.25

Nashua

5-1/4" - 48 TPI DS-DD	OS-HD 96 TPI IBM-AT Compatible
.50	BOXED *1.00*

BULK

32¢ 5-1/4" DS/DD 48 TPI Exceeds ANSI specifications + 6¢ FOR TYVEK

ORDERING INFORMATION

TERMS: P.O. orders accepted, government and schools on net 30. SHIPPING: U.S. orders add \$3.00 per 100 diskettes or fraction thereof, add \$3.00 for COD orders.
PRICE PROMISE: We will better any lower delivered price on the same products and quantities advertised nationally.

Toll Free Order Line: **1-800-233-2477**
Information Line: **1-801-561-0092**

DISC INTERNATIONAL
SUPPLY COMPANY
1375 W. 8400 S. / WEST JORDAN, UT 84088
HRS: 8 AM TO 5 PM (MTRL. TIME)

HARD DISK CONTROLLERS

ADAPTEC	
PC-XT Controller ST506412	\$45
2072 PC/XT RLL	\$68
3530 SCSI to Tape CMC 36	\$78
4000 SCSI to ST506415	\$89
4070 SCSI to ST506412 RLL	\$96
4520 SCSI to ESDI	\$98
5500 SCSI to ST506412	\$125
5586 SCSI to SMD	\$175
XEBEC	
S1410 SASI Controller	\$109
S1420 SASI to 5 1/4" Floppy & Hard Disk Controller	\$99
Apple II, II+, IIe Host Adapter	\$23
Toshiba PC to SAS/SCSI Host Adapter	\$29
9205 Multibus Hard Disk Controller	\$199
9306D IEEE 488 (HPB) to ST506412 Controller	\$69
1490 SASI to SMD Controller	\$149
OTHERS	
OMTI 20C, I. SASI Controller	\$90
OTC 518A SASI Controller	\$98
Shugart 8610-13 or 4 SAS/SCSI Controller	\$75
WD 1002-SHD Xebec Compatible SASI Controller	\$109

* Call for cable prices
* Controller manuals \$8 each

Computer Surplus Store "WE BUY AND SELL"
Phone 408-434-1060
FAX 408-434-0931
Telex 1561447
MCA/VISA/Discover/COD's

Circle 63 on Reader Service Card

SPEECH THING™
For all PCs, compatibles, laptops

\$69.95 CLEAR, CLEAN, DIGITIZED SPEECH & MUSIC, UNLIMITED TEXT-TO-SPEECH Attaches outside the computer.

Now get popular speech technologies in ONE product! Speech Thing is a full featured 8 bit D/A sound converter. Easy attaches outside the computer - no slots required. Software includes pre-recorded speech vocabularies, synthetic text to speech (speaks any ASCII text), demo programs, and complete editing features. Price only \$69.95. Also available: Voice Master PC plug in board for digital recording, editing, and VOICE RECOGNITION. (Requires Speech Thing for sound output.) Only \$79.95. Patented price/performance breakthrough!

TO ORDER BY MAIL include \$4 shipping & handling (\$6 Canada, \$12 overseas) per order. Visa, MasterCard phone orders accepted. 30 day money back guarantee, one year warranty. Other voice I/O systems available for Apple, Commodore, and Atari computers.

Call or write today for FREE Product Catalog

COVOX INC. (503) 342-1271
675 Conger St., Eugene, Oregon 97402

Circle 68 on Reader Service Card

GRAPHICS TOOLKIT
COMPATIBLE WITH PC/XT/AT AND NEW PS/2

\$59.95 LIMITED INTRODUCTORY OFFER (ADD \$3 S/H)

- SUPPORTS NEW VGA GRAPHICS MODES
- 50+ FUNCTIONS
- SUPERFAST SAVE/RESTORE FUNCTION
- FREE LISTING UTILITY
- DATA COMPRESSION ALGORITHM
- ALL SOURCE CODE INCLUDED
- ROUTINES WRITTEN IN MICROSOFT C AND ASSEMBLER
- NO ROYALTIES
- PROGRAMMER SUPPORT PROVIDED

DEVTRONICS, INC.
1571 HIGH STREET
ATLANTIC BEACH, FLA. 32235

ORDERS ONLY: 1-800-532-4230 VISA/MC/AMEX
TECHNICAL INQUIRIES: (904) 241-3281

Circle 76 on Reader Service Card

ROMDISK™

EPROM & SRAM Disk and Drive Emulators for IBM PC, XT, AT and Compatibles

FEATURES

- Disk and drive emulators up to 12 MB - standard and cassette version
- Cassette versions available using SRAM or EPROM technology to ROMDISK
- Develop programs on a diskette and smart copy directly to ROMDISK
- Programming utilities provided for ROMDISK
- Autooperating and file modes - operate up to four units per computer
- Fast EPROM programming - approximately 180KB/min

APPLICATIONS

- Industrial control, instrumentation and manufacturing test systems in environments hostile to disks
- Unattended remote site installations
- Debugs PC systems and workstations requiring automatic capability, reliability and high performance
- Military equipment requiring ruggedization and operational reliability

Low prices from \$495 (ICE-1900) to \$1295 (ICE 1.2MB)

CURTIS, INC. • 812/884-5064
10 Aramonte Circle
St. Paul, MN 55127
IBM is a registered trademark of IBM Corporation

Circle 72 on Reader Service Card

NEW! INSTANT TERMINAL

"EXACT TERMINAL EMULATION AND COMMUNICATIONS SOFTWARE"

- PRECISE EMULATION OF THE DEC VT52, VT100, VT102, VT220
- EXPANSION MODULES FOR OVER 40 EXACT EMULATIONS
- 9 FILE TRANSFER PROTOCOLS
- EASY TO USE, QUICK TO INSTALL, AND MUCH MORE
- IBM PC, XT, AT, PS/2

FOR INFORMATION 800/548-9777

ONLY \$97.50

SCITRONICS
303/593-9540
TELEX 450236

Circle 243 on Reader Service Card

EPROM PROGRAMMER \$349

BP MICROSYSTEMS

THE EP-1's A GREAT VALUE & HERE'S WHY:

- READS PROGRAMS, COPIES OVER 300 EPROMS FROM 29 MANUFACTURERS INCLUDING 776 27513, 2804 28256, 27011
- READS & WRITES INTEL, MOTOROLA, STRAIGHT HEX AND BINARY
- OPTIONAL HEADS PROGRAM INTEL 8251, 8251, 8252, 8256
- MENU-DRIVEN CHIP SELECTION BY MFG & PIN NO. TABLES
- FAST, SLOW, QUICK PULSE PROGRAMMING ALGORITHMS
- SPLITS FILES BY BASE ADDRESS AND CLOCK/VEH (16 & 32 BIT)
- ALL INTELLIGENCE IN LINE 280 MICROPROCESSOR BASED
- 5 1/2, 21, 25 VOLT PROGRAMMING FOR CMOS AND 4 BUFFER PARTS
- FREE PC DOS SOFTWARE
- GOLD TENDON 26 SOCKET
- SAME DAY SHIPMENT
- ONE YEAR WARRANTY
- MONEYBACK GUARANTEE
- RS232 TO ANY COMPUTER
- 8 BAUD RATES TO 38400
- GENERATES CHECKS CHECKSUMS
- TWO FREE FIRMWARE UPDATES
- UV FRASERS FROM \$34.95

CALL TODAY FOR MORE INFORMATION

BP MICROSYSTEMS
800/225-2102 713/461-9430 TELEX 1561477
10681 HADDINGTON #190 HOUSTON, TX 77043

Circle 44 on Reader Service Card



**Presto!
A Link to
Mainframe
Graphics**

Find out how our whole family of EMU-TEK graphics terminal emulation software makes good sense for the work you do. Call today for more information.

FTC DATA SYSTEMS

(714) 995-3900
(800) 962-3900 (800) 972-3900 (CallH.)
10801 Dale St., Suite M-2
San Diego, CA 90680

Circle 99 on Reader Service Card

ATTENTION p*cad USERS

Now you can increase the productivity of your software by using the new...

RAPICAD buffer/decoder.
Two buffers in one unit with parallel and serial in/out. Up to 1 Meg total memory.

NO EXTERNAL DECODER needed any more... because RAPICAD is fully p*cad box compatible and software transparent, allowing the use of p*cad and any other software with any printer, plotter, laser, etc.

Prices as low as **\$995.00**



INTECTRA Inc.
2629 Terminal Blvd.
Mtn. View, CA 94043
(415) 964-5018

Serial Data \$495 Analyzer Introductory Offer

DataScout™ turns your PC into a tool for solving RS-232 interfacing problems.



Features:

- Monitor full duplex async data
- Log Monitored Data to Disk
- Post Acquisition Analysis
- Inject Data in Either Direction
- Integrated Breakout Box
- 9 LEDs Monitor Signal Levels
- Simple menu driven interface

HTE HiTech Equipment Corp.
9560 Black Mtn. Rd.
San Diego, CA 92126
(619) 588-1892

Circle 118 on Reader Service Card

ZSTEM **VT240 Smart Terminal Emulator and Communications Program**
for the IBM XT, AT, PS/2 and compatibles

VT241 \$295
plus your PC or compatible

- Emulate a VT240/241 at 2-4 times the speed.
- Complete VT240 ANSI console including true double-high double-wide characters, true graphics control, national multilingual support, and downloadable fonts.
- At least 128 columns (compatible w/112-column mode on the CGA, EGA, VGA, and Hercules adapters).
- Full Tektronix 4010/4014, steel and KeGIS graphics support.
- KERMIT and XMODEM transfers.
- Logperman Base Net/Out and VMS Services for MS-DOS support.

Also available VT220, VT100, D400, 4014 emulators and the PowerStation™ VT200 style keyboard.

KEA SYSTEMS LTD.
Suite #12, 7150 West Broadway, Vancouver, B.C. Canada V6K 4J9
Telephone (604) 732-7411 Telex: 04-352848 VCR Fax: (604) 732-0715
Order desk: 800-863-6702 Toll Free
30 day money back guarantee. **AMERICA/USA**

Circle 137 on Reader Service Card

9-Track Tape Subsystem for the IBM PC/XT/AT



Now you can exchange data files between your IBM PC and any mainframe or mini-computer using IBM compatible 1600 BPI 9-Track tape. Unit can also be used for disk backup. Transfer rate is up to 4 megabytes per minute on PCs and compatibles. Subsystems include 7" or 10 1/2" streaming tape drive, tape coupler card and DOS or XENIX compatible software.
Prices start at \$2,995.

QUALSTAR*
9621 Irondale Ave., Chatsworth, CA 91311
Telephone: (818) 882-5822

Circle 221 on Reader Service Card

16-BIT RESOLUTION ANALOG-TO-DIGITAL CONVERTER
12,000 SAMPLES/SEC
for IBM PC, XT & AT
SINGLE PIECE PRICE \$475

We manufacture a broad line of data acquisition and control hardware and software for Apple and IBM computers.

Call for quotes on custom hardware or complete systems.

LAWSON LABS, INC.
5700 RAIBE ROAD
COLUMBIA FALLS, MT 59912
406-387-5355

Circle 141 on Reader Service Card

DISK COTECH WORLDWIDE SALE!!

WHY RISK THE UNKNOWN...when you can get premium quality disks from the Leader and Inventor of magnetic media... **for less!!**

- 100% tested & certified at 85% or higher clipping error
- Study: *Master PC's* journal • Made in the USA • **LIFETIME WARRANTY** •

DISK-KING® NEW IMPROVED

5.25" DS-DD Diskettes:	Bulk	Boxed
DS-DD-48TPI.....	.38	.42
DS-DD-48TPI Color48	.55
DS-HD-96TPI "AT".....	.90	.95
DS-HD-96TPI "AT" Color95	1.05

3.5" DS-DD 135 TPI:

DISK-KING	1.09	1.19
DISK-KING Color	1.19	1.29

All 5 25" diskettes are supplied with 1 track # drivers, color-coded ID labels, and 100% COLOR DISKS IN RAINBOW ASSORTMENT

DISK COTECHnicolor™

DS-DD-48 TPI	5.25"	DS-HD-96 TPI
.75	Plastic Library Box	1.25
.59	Color Bulk	1.19
DS-DD-135TPI.....	3.5"	DS-HD 135TPI
1.49	Plastic Library Box	3.90

3M **MARK Q**
performance through quality

DS-DD	Quantity Discounts Available	DS-HD
.78	5.25"	1.55
1.59	3.50"	4.75
1.50	SS/SD	8.00" DS/DD 1.99
.50	3M's Highland	1.20
.52	3M's No Logo	

3M **MARCH SPECIAL** **FREE 1+3+8 GET**

BUY	5.25" DS-DD/HD	21
20 Bx	Lowest Price Ever!	53
50 Bx	on 3M Data Products	108
100 Bx	Lifetime Warranty	

3M Headcin Kit 5 25" 6.99
3M Headcin Kit 3 5/8" 10.99
3M Mag. Tape 1200' w/seal 7.99
3M Mag. Tape 2400' w/seal 10.99
DC-1000 12.75 DC-300XL/P .. 19.45
DC-2000 17.25 DC-600A 21.65

BASF **FREE** **Color-Coded Modular Flexy Files a \$9.95 value!**

5.25" DS-DD in Plastic Library Case	75
5.25" DS-DD in *Minidex/60	81
3.50" DS-DD in *Microdex/25	1.49
5.25" DS-HD-96 TPI	1.19
3.50" DS-DD-135 TPI	1.45
5.25" DS-DD BASF No Logo	42

NASHUA pre-formatted also available!!!

5.25" DS/DD-48 TPI	52
5.25" DS-HD-96 TPI	1.09
5.25" DS-DD-96 TPI	1.15
3.50" DS-DD-135 TPI	1.39

BULK 5.25" DS-DD-48TPI - 36 for Types/labels **29¢**

RIBBONS STORAGE
—Please call for information—

ORDERING INFORMATION

TERMS: VISA, MasterCard or AMEX. COD add \$3.00. Freight collect 7% cash discount. P.O.s accepted from recognized institutions and corporations on first 30 days. Shipping: \$4-100 or fewer disks. Foreign orders: AFD/FPD. Please call. Reduced shipping on large quantities. HRS. 8 a.m. to 6 p.m. (mountain time).

Toll Free Order Line: **1-800-523-9681** Information Line: **1-801-572-3589**
TLX-9102404712 FAX-801-572-3327

DISK COTECH
DISKCO TECHNOLOGIES, INC.
P.O. Box 1339 Sandy, Utah 84092
MARCH 1988 • B Y T E 305

 **CAT™ 8MHZ**
BASE SYSTEM

- 256K (Optional 640K)
- 150 Watt Power Supply
- AT Style Keyboard
- 4.77 or 8 MHZ Keyboard Selectable
- FDC Controls 4 Disk Drives
- 8087 Socket
- 360K Floppy Drive

\$36900



 **CAT™ 286-10**
BASE SYSTEM

- 512K (120 NS)
- 200 Watt Power Supply
- AT Style Keyboard
- Western Digital Controller
- Teac 1.2 Meg Floppy
- Legal Bios w/manuals
- Systems Documentation
- 1 Year Warranty
- Clock Calendar
- 10 MHZ - 0 Watt State w/100 NS

\$89800



OPTION A
12" Mono Amber Monitor
Graphics Card
w/wpar port
\$49800

OPTION B
640x200 Color Monitor
Graphics Card
w/wpar port
\$73600

OPTION C
12" Mono Amber Monitor
Graphics Card
w/wpar port
20 Meg Hard Drive
\$79800

OPTION A AT
12" Mono Amber Monitor
Graphics Card
w/wpar port
\$109900

OPTION B AT
640x200 Color Monitor
Graphics Card
w/wpar port
\$126500

OPTION C AT
12" Mono Amber Monitor
Graphics Card
w/wpar port
20 Meg Hard Drive
\$132500

HARD DRIVES

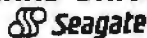

COMPLETE KITS

- ST225** 20Meg w/cont. & Cables **27900**
 - ST238** 30Meg w/cont. & Cables **29900**
 - ST251** 40Meg 1/2 HT 40 Mil w/software **42900**
 - ST4051** 40Meg Full HT w/software . . . **45900**
- ST225 & ST238 come with Western Digital Controllers

1 Yr. Warranty
Bitcom Software

MODEMS



- EV-920** EverCom 12 300/1200bps . . . **8400**
 - EV-940** Internal 300/1200/2400 . . . **17900**
 - EV-945** External 300/1200/2400 . . . **23900**
 - EV** Pocket Modem . . . **13900**
- US Robotics—Complus—AddA**
- 1200 Baud w/Bitcom 1 yr Warranty . . . **6900**
 - 1200 Baud External, 1 yr Warranty . . . **11900**
 - 2400 Baud Internat., 1 yr Warranty . . . **14900**

ALL HAYES
COMPATIBLE

POWER SUPPLIES

- 150 Watt
 - UL Approved
 - Direct PC Replacement
- \$5900**

3 1/2 DISK DRIVES

Requires DOS 3.21 or Above
720K w/mounting Brackets
10900

TAPE BACKUPS



- 40Meg Internal XT or AT **34900**
by TEAC
- 60Meg Internal w/Qic-02 **59500**
- 60Meg External w/Qic-02 **86800**

LOGITEC MICE

- Logitech C-7 Bus or serial **8800**
- Logi cadd Mouse & Cadd **14900**
- Logi Publisher Mouse & Publisher **12900**
- Logi Paint **11900**

COPROCESSORS

- Intel 8087 5Mhz **10200**
 - Intel 8087 8Mhz **14900**
 - Intel 80287 6Mhz **17900**
 - Intel 80287 8Mhz **24900**
 - Intel 80287 10Mhz **28900**
 - Intel 80387 16Mhz **43800**
 - Intel 80387 20Mhz **78700**
- MEMORY UPGRADES**
- 41128 150NS **200 ea**
 - 256k 100NS **600 ea**
 - 256k 120NS **500 ea**
 - 256k 150NS **400 ea**

DIAMOND SCAN MONITOR

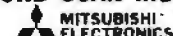

- 1371A • EGA-CGA-PGA-MDA
 - NTSC Video • 800x560
- List **88900** Mead's **\$50900**
- EGA VIDEO CARDS**
- EVEREX EV857B Autoswitch **13900**
 - EVEREX EV857 Autoswitch w/wpar **14900**
 - EVEREX EV660 PGA **84900**
 - ATI EGA Wonder **20900**
 - ATI VIP **30900**

- Irwin Tape Back Up
110D 10Meg **22900**
- FLOPPY DRIVES**
- Qume 1/2HT 360k **7900**
 - Mitsubishi 1.2Meg **7900**
 - Toshiba 720k 3 1/4 **10900**
 - Tandon TM100-2A **8900**

LIQUIDATION SALE — ALL ITEMS LISTED BELOW

50% — 80% OFF LIST PRICE

MEAD Computer has just purchased these items from an OEM at a liquidation price
We are passing these savings and warranties on to you!

- Western Digital
Controllers**
- WA 1 MEG 4 XT **7900**
 - WA 2 MEG 4 XT **8900**
 - WA 4 MEG 4 FDC
for AT **14900**
 - WA 4 MEG 4 A
4 Meg 400k **8900**
 - WA 4 MEG 4 A
4 Meg 800k **8900**

MITSUBISHI
1.2 Meg Disk Drive

- 5 1/4" Black Face Drive
- Half HT Floppy
- New - 90 Day Warranty

List **19900** Mead **7900**

10MEG HARD DRIVE

- Full Height/Factory Fresh
- 80 Mil. Sec
- 3 Month Warranty

List **29900** Mead **10900**

RETURN OF A SELL OUT
LQ1500 EPSON TRACTORS

- Epson discontinued these but Mead has acquired last 450 units

List **9900** Mead **4900**

Epson Bar Code Reader — Call

3M Equivalent Data Cartridges

- DC 300 XLP
- 45 Meg (450 II)
- Individually Wrapped
- 5 Year Warranty

List **3900** Mead's **1400 ea**

Intel Above Board

- 2010 - 128K Exp. to 2Meg
- PC AT Compatibles
- Provides Conventional-Expanded & Extended

List **54500** Mead's **19900**

TANDON TM100-2A

- This was the original drive used by IBM
- Full Height
- 360k

List **24900** Mead's **8900**

MOUSE

- Requires Slot & Serial Port
- Compatible with PC-XT
- Mouse System Compatible
- 3 Button Mouse

List **9900** Mead's **3900**

NEC COMPOSITE MONITOR

- 12" Green Screen
- JB1201 New 90 Day Warranty
- Work w/IBM jolt color graphic adaptor!

SANYO APPLE

List **19900** Mead **7900**

ALL TRADEMARKS ARE REGISTERED
with their respective companies

800-654-7762

SALES
7AM—6PM PST

702-294-0204

Customer Service • Order Status
9AM—4PM PST

FAX
702-294-1168

VISIT OUR SHOWROOM
30 Minutes from
Las Vegas





1000 Nevada Highway • Unit 101
Boulder City, Nevada 89005

NO SURCHARGE FOR MC/VISA

TERMS:
MC • VISA • CDD • CASH

Purchase Orders from Qualified Firms
Personal Checks • AE add 4%

SHIPPING: (Minimum 6²⁵)
UPS • Federal Express

COMPLETE 12 MHz ZERO-WAIT 286 SYSTEM WITH 32MB HARD DRIVE!

Can you believe it? *Yes you can!*

32 MB hard drive. 12 MHz ZERO Wait State. Fully AT compatible. Our *complete* 286 system ready to plug in and fly right out of the box! At the amazing price of only \$1,295!

How is it possible? By buying direct from the manufacturer that's how. ZEOS International offers you the finest, best-backed fully AT compatible systems available . . . at *factory direct* prices.

We think you'll agree, this is the very best value you'll find anywhere.

And every ZEOS® system is fully assembled, burned-in and tested in our own laboratories. We would like to build one for you. Give us a call today!

OTHER ZEOS OPTIONS:

- Basic System Only: Everything except a hard drive. \$995
- Complete 77MB hard drive system! Only \$1,595
- EGA Upgrade. 14" EGA color monitor with ZEOS EGA card. Fully tested. Add \$495
- Many other drives and options available. Call Toll Free for details, 800-423-5891.

ZEOS® Customer Assurance Program

Compare not only our features but the ZEOS® Customer Assurance Program as well: 1. Full refund within 30 days of shipment if you are not absolutely satisfied. 2. One full year limited warranty on parts and labor. 3. Federal Express replacement of any failed parts for your first year of ownership.

ONLY
\$1,295⁰⁰

NEW! ZEOS® 286 Motherboards!

ZEOS® 80386 motherboards, 16 or 20 MHz, Zero-Wait state. Up to 16MB of 32-bit memory *on board*. Plus *on board* options include Weitek 1167 Math Co-processor, 80387, 80287, FDC and SCSI HDC. Ideal for upgrades and OEM systems. Only \$1395.00

STANDARD FEATURES INCLUDE:

- 12" High Resolution Amber Screen TTL Monitor with Tilt & Swivel base. Easy on the eyes!
- 80286 CPU Zero-Wait State Motherboard with 8 I/O slots and socket for 80287 Math Co-processor.
- 6/12 MHz Dual Speed, Keyboard Selectable, Zero Wait-State. Phoenix BIOS!
- Deluxe AT-style Case, Security Keylock, Reset Button, LEDs.
- Full 101 key AT-style Keyboard, Mechanical Tactile with Pleasant "Click" Feel.

- Heavy Duty 200W Power Supply.
- Real Time Clock/Calendar with Battery Backup.
- 512K, 80ns Memory expandable to 1MB on the Motherboard.
- Hard and Floppy Drive Controller.
- Serial and Parallel/Printer Ports.
- 1.2 MB High Capacity Floppy Drive.
- 32MB hard drive.
- High Resolution Monochrome Graphic Card.
- FCC approved.

And More!

AT is a registered trademark of IBM Corporation.

Due to currency fluctuations and other factors beyond our control, prices are subject to change without notice.

Call for complete warranty details.

In Minnesota Call: 612-633-4591
FAX Orders Dial: 612-633-2310



**ORDER NOW TOLL FREE
800-423-5891**

ZEOS
INTERNATIONAL, LTD.

530 5th Avenue NW, Suite 1000
St. Paul, MN 55112

Circle 302 on Reader Service Card

MONTGOMERY GRANT

115 Nassau St. NY, NY. 10038 Bet. Beekman & Ann Sts. (212)732-4500 Open Mon-Fri, 8:30-6:30 Sun 9:30-5:30 / Closed Sat

Penn. Station, Amtrack Level Beneath Madison Sq. Garden, NY, NY. (212)594-7140 Open Mon-Wed, 8:30-8 / Thurs & Fri, 8:30-9 / Sat & Sun, 10-7

FOR ORDER & INFORMATION CALL TOLL FREE OPEN 7 DAYS A WEEK

1 (800) 345-7058
1 (800) 345-7059

IN N.Y.S. CALL (212)732-4500

FOR CUSTOMER SERVICE CALL (718)965-8686 MON-FRI 9AM-4PM

EPSON EQUITY 1+



IBM PC/XT COMPATIBLE PACKAGE

- 640K RAM w/Clock Calendar • 360K Drive
- Keyboard
- Serial/Parallel Ports • Box of 10 Diskettes
- 12" High Resolution Monitor

\$769

Same Pkg. w/One Floppy \$1049 & 20 MB Hard Drive

Same Pkg. w/Two 360K Floppy Drives \$849

IBM XT



HARD DRIVE PACKAGE

- IBM XT Computer • IBM Keyboard
- 256K RAM Expandable to 640K • 360K Disk Drive • 20MB Hard Drive • Package of 10 Diskettes • (Monitor Optional)

\$1499

IBM XT Package with 2 360K Floppy Drives \$1279

IBM PERSONAL SYSTEM 2 MODEL 50



w/720K Floppy Drive & 20MB IBM Hard Drive

\$2599

Personal System II Model 25.....\$1049

PS II Model 25 w/Color Monitor.....\$1299

PS II Model 50 w/441KB Hard Drive & 1 720 k Floppy Drive.....\$3599

IBM Personal System II Monitors

8503 Mono.....\$249

8512 Color.....\$479

8513 Color.....\$529

IBM PERSONAL SYSTEM 2



- MODEL 30 PACKAGE
- IBM Computer • Two 720K Drives
 - 640K RAM • Built-in Graphics
 - Serial/Parallel Ports • Optional 12" Monitor

\$1199

PS/2 Model 30 w/720 Floppy Drive & 20MB IBM Hard Drive \$1599

NEC POWERMATE I PACKAGE



IBM PC/XT/AT COMPATIBLE

- 800286 8 MHz Processor • 640K RAM • 1.2 MB Floppy • 12" Monitor

\$1349

w/20MB Hard Drive.....\$1579

POWERMATE II with monitor \$1879

HARD DRIVES

HARD DRIVES & CARDS

SEAGATE	20MB 1/2 Ht. w/Controller.....	\$279
	30MB 1/2 Ht. w/Controller.....	\$319
	40 MB 1/2 Ht. w/Controller.....	\$449
EVEREX EGA CARD.....		\$139.95
MINISCRIBE	40MB 1/2 Ht. w/Controller.....	\$369
CMS 20MB Card.....		\$339
CMS 30MB Card.....		\$379

COMPAQ DESKPRO MODEL 2.....\$1150

DESKPRO 286 MODEL 1.....	\$2190
DESKPRO 286 MODEL 20.....	\$2899

PRINTERS

EPSON	STAR
FX-86E.....	NX-1000.....
FX-286E.....	NX-15.....
FX-800.....	NB-2410.....
LQ-800.....	NB-2415.....
LQ-850.....	
LQ-1000.....	
LQ-1050.....	
EX-800.....	
EX-1000.....	

OKIDATA
OKI-120.....\$189.95
OKIMATE20&139.95
OKIDATA180.....\$219.95

PANASONIC
1080H.....\$159.95
1092.....\$279.95
1091H.....\$199.95

TOSHIBA
321-SL.....\$478.95
341-SL.....\$649.95
351-IL.....\$798.95

Laserjet Series II \$1649

commodore PC10-1



- IBM PC/XT COMPATIBLE PACKAGE
- PC10-1 Computer
 - 512K Expandable to 640K
 - 360K Disk Drive
 - Enhanced Keyboard
 - Serial & Parallel Ports • 12" Monitor & Adapters • Package of 10 Diskettes
 - All Hook-up Cables

\$529

Same Package with 20MB Hard Drive \$789

VENDEX HEADSTART PC/XT COMPATIBLE



- 4.7 MHz • Dual Floppy Drives • 7 Expansion Slots • 512K Expandable to 768K • Parallel & Serial Ports • Mouse • Available in Color or Monochrome System • Over \$1000 Worth of Software - NO CHARGE!

Mono System \$899

Color System \$1049

IBM PC/XT COMPATIBLE PACKAGE



- Keyboard • 640K RAM Power-TurboSpeed 4.7/8 MHz • Two 360K Floppy Drives • MS-DOS • Mono-Graphics Card • High Resolution Mono Monitor • FREE Word Processing Software

\$679

apple PACKAGES



- Apple IIG or IIE Keyboard • 5.25" Disk Drive • 12" Monitor • All Hook-up • Cables and Adapters • Package of 10 Diskettes
- APPLE IIC \$579
APPLE IIE \$799
- Apple IIGS Computer • 3.5" Drive • Apple RGB Color Monitor • Pkg. of 10 Diskettes • All Cables & Adapters • Apple Software \$1379

- MAC PLUS Computer Package.....\$1579
- IMAGEWRITER Printer.....\$449
- MAC SE Computer w/Dual Drive.....\$1949
- MAC SE Computer w/20MB APPLE Hard Drive.....\$2499
- APPLEWORKS Software.....\$89

LAPTOPS MONITORS

TOSHIBA

NEC MULTISPEED EL.....	\$1549
NEC MULTISPEED.....	\$1249
TOSHIBA 1200.....	\$2299
TOSHIBA 3100/20.....	\$3050
TOSHIBA 1200.....	\$2295
25NTH 181.....	\$1549
25NTH 183.....	\$2239
SPARK by DATAVUE	
840K w/2720K DRIVES.....	\$1099
SPARK EL.....	\$1199

\$799

COMMODORE 1902 RGB Color Monitor.....\$214

THOMPSON 14" CGA Monitor.....\$289

THOMPSON ULTRA SCAN.....\$469

MAGNAVOX EGA Monitor.....\$339

with EGA Card.....\$459

Commodore AMIGA 500 NOW IN STOCK!

Commodore AMIGA 2000 LOW PRICE!

AMIGA 1010 DISK DRIVE \$449
AMIGA 1020 DISK DRIVE \$499
AMIGA 507 - 512K EXPANSION \$149

1024 RGB COLOR MONITOR BRIDGE CARD RF MODULATOR THESE & ALL OTHER PERIPHERALS IN STOCK

commodore 128 PACKAGE

Commodore 128 Computer • Commodore 1571 Disk Drive • Commodore 1902 Color Monitor • Commodore 1515 80 Column Printer \$729

commodore 64/c PACKAGE

Commodore 64/C Computer • Commodore 1541 Disk Drive • Computer Printer • 12" Computer Monitor \$399

AMIGA 500 w/1084 \$769

AMIGA 500 w/1084/1010 \$979



NO ADDITIONAL SURCHARGE FOR CREDIT CARD ORDERS

United checks cash checks. MasterCard Visa AMEX, Diners Club, Circle K, Money, Discover Card and C.O.D.'s accepted. No additional surcharge for credit card orders. Non-certified checks must wait 1-4 weeks clearance. Money orders are non-certified checks. Please add 5% for shipping and handling. Minimum shipping charge is \$18. APO, FPO and PO Box addresses please call for shipping charges. N.Y. residents add applicable sales tax. Prices and availability subject to change without notice. Not responsible for typographical errors. Status of defective merchandise must have your return authorization number or return will not be accepted. IBM PC/XT are registered trademarks of International Business Machines Corp. All orders can be shipped Air Express - call for details. For your protection, we check for credit card theft.

Circle 182 on Reader Service Card

TELEX 422132 HMOLLER

FAX NO. 212-564-1497

Byte 3/88



SATISFACTION GUARANTEED
OR YOUR MONEY BACK!
8 MHz TURBO-XT

- 840K of RAM
- 360K Disk Drive
- 150 Watt Power Supply
- 4.77 & 8 MHz
- 8 Slots
- Deluxe Keyboard
- Disc Controller

OPTION A

- High Resolution Amber Flat Screen
- High Resolution Graphics Card
- Parallel Printer Port

ADD \$148

OPTION B

- Hi-Res RGB Color Monitor
- High Resolution Graphics Card
- Parallel Printer Port

ADD \$298

OPTION C

- Hard Disk Drive, Cables
- Dual Hard Disk Controller

30 MB XT 20 MB AT
ADD \$298 ADD \$298

Turbo-AT

\$798

- 640K of RAM
- Expands to 1 MB
- 200 Watt Power Supply
- AT-Style Keyboard
- One Year Warranty
- Clock/Calendar



200 CPS

\$199⁹⁵

List Price \$649



STAR RADIX LV210

- 200 CPS Bi-directional
- 17 x 9 Near Letter Quality
- IBM Graphics
- Parallel & Serial

- 16K Buffer
- Adjustable Pusher Tractor
- One Year Factory Warranty
- Limited Quantity

ARC TURBO 386

\$1988



- 101 Key Enhanced Keyboard
- One Year Warranty

- 16 MHz 80386 CPU
- 512K of RAM
- 1.2 MB Disk Drive
- 8 Expansion Slots
- MIPS Speedmeter
- 200 Watt Power Supply
- Dual Hard Disk and Floppy Disk Controller

TOWER TURBO 386

\$2798

- 80386 CPU
- 16 MHz, 0 Wait States
- 2 Megabytes of RAM

- 275 Watt Power Supply
- Western Digital Hard Disk and Floppy Disk Controller
- Two Year Factory Warranty on Mother Board

30 MB HARD DISK

Complete Kit with
Controller for Your PC/XT



\$298

AT DRIVES
40 Megabyte
33 MS \$398

20 MB PC/XT Kit
\$248

360K DISK DRIVE
Half Height, IBM Compatible



\$65

Limited Full Height
Quantity TM100-2 **\$119**

LASER PRINTER

\$995*

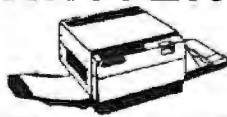

- *Interface Required
- 300 x 300 DPI Resolution
- 8 Pages Per Minute

- HP LaserJet+ Interface \$98
- 1.5 MB RAM \$198
- Extra Toner Cartridge \$59

**1200 BAUD
DELUXE MODEM**

\$75

Including Free Software
Hayes Compatible 1/2 Slot Card
On-board Speaker

- 1200 External \$99
- 2400 Internal w/software ... \$149
- 2400 External \$169

EGA PACKAGE

\$498

- List Price \$988
- Hi-res EGA Video Card... \$148
- Hi-res EGA Monitor... \$378
- Dual Mode Monitor
- Non-glare .31 mm Dot Pitch
- 640 x 350, 640 x 200
- EGA, CGA, MDA & HGA
- 100% IBM Compatible
- 256K of Video RAM

**HI-RES RGB
MONITOR**

\$258

- List Price \$699
- 640 x 240 14" Non-glare Tube
- 640 x 200, 16 Colors
- Includes Free Cable & Tilt-n-Swivel
- Manufactured By Samsung

HARDCARD



- 21 MB Card Hardcard 20 \$338 \$568
- 43 MB Card Hardcard 40 \$488 \$828

**NEC
MULTISYNC**

\$559

13" Color Monitor

MOUSE

\$58

With Software

**MICROSOFT
MOUSE**

Serial or BUS
\$118

With Software

EPSON PRINTERS

LX-800
9 PIN, 180 CPS

\$198

List Price \$299

- LX-800, FX-86e, FX-286e, LQ-800, LQ-850, LQ-1050
- LQ-1000, EX-800, EX-1000, LQ-2500, GQ-3500



LQ-500
24 PIN, 180 CPS

\$349

List Price \$499

NO-SLOT CLOCK

For Your PC-XT (Clone) or Apple



\$49

- Uses No Slots
- 20 Year Battery
- Includes Software
- Plug-in Clock Board for PC...MS



Math Co-Processor

- 8087 \$109
- 8087-2 \$149
- 8087-1 \$199
- 80287 \$179
- 80287-8 \$249
- 80287-10 \$299

3 1/2" DISK DRIVE

FOR YOUR PC/XT/AT
\$128

720K Disk Drive For
Mass Storage or for
Down Loading to your
Lap-Top Computer
Requires DOS 3.20

Includes Mounting Kit



LASERJET II

\$1798



List Price \$2595

JADE COMPUTER

4901 W Rosecrans Ave. Box 5046
Hawthorne, CA 90251-5046



Prices at our six store locations will be higher.
We accept cash, checks, credit cards or purchase orders from qualified firms and institutions. Minimum prepaid order \$15.00.

PLACE ORDERS TOLL FREE!
Continental U.S.A. (800)421-5500
Inside California (800)262-1710
All Others (213) 973-7707
Fax Machine (213) 675-2522

Ca & Tx residents add sales tax. Prices & availability subject to change without notice. Shipping & handling charges via UPS Ground 50¢/lb UPS Air \$1.00/lb Minimum charge \$3.00.

FEDERAL EXPRESS
FREE WHEN YOU PAY
GROUND RATES!
NO SURCHARGE!

S-100™

"THE PC PEOPLE"

SINCE 1977

Circle 258 on Reader Service Card
(DEALERS: 259)

PC COMPATIBLE SYSTEMS



FastData Mini-AT - 80286-10 runs 11.5 Norton SI, 512K-1Mb RAM, Award Bios, only 16" wide, 8 slots, room for 3 half-ht drives. Speed, drive, power LED's, key, reset & turbo switch on front panel. AT-Style Keyboard, 200W 110/220V P/S, FCC app., 1 yr warr... \$725

SUPERturbo XT - AT-Style Case & Keyboard, 10 MHz 8088-1, 120nSEC RAM 640k, 150W P/S, 360K Flpy. FCC app. 1 yr parts & labor warranty... \$425

AST Premium 286™ \$55./mo.*

Model 140 with 44Mb Dr, 1Mb RAM, S&P Ports, Clk/Cal, RT-Style Keyboard, 3-G Plus Card with EGA, CGA, HGC, MS-DOS 3.2, GW-Basic

AST Premium Workstation..... CALL

AST Premium/386 - 20 MHz, 0 Watt..... CALL

* 1 to 5 year leases available to qualified businesses.

FORTRON

80386-16 MHz Server with 2Mb RAM, 0 watt, 1 para, 2 ser. ports on Mb; 8 AT, 4 XT slots, 230W, maxiswitch enhanced keyboard, up to 6HH drive, 80287 socket, WD-WA2ctrl, 1.2Mb flpy drive..... \$2,576

INDECH

5191 Basic System - 12 Slots, 80286-10 ("0" watt), 512K-1Mb, 238W P/S, WD-WA2 Ctrl, 1.2Mb Flpy Dr, Keyboard, MS-DOS 3.3 & GW-Basic, Manual & Set-Up. Will Run Novell Non-Ded 286!!..... \$1,275

MONITORS & TERMINALS



SAMSUNG

Samsung EGA Tit 'n' Swivel, 14" Monitor..... \$359

Samsung 14" Tit 'n' Swivel Color Hi-Res..... \$249

Samsung 12" TTL Tit 'n' Swivel Amber..... \$ 79

OTATUNG*

CM-1365 RGB 13" 5-Color Text Switch..... \$299

CM-1495 OmniScan 14" PGA, EGA, HGC, CGA \$649

MM-1422 Dual Freq, T 'n' S 14" Grn/Ambr..... \$119

Montem Viking dual page 19" or 24" paper white or color monitors up to 1280 x 960.....CALL

MDS Genius full page for PC, PS/2 & MAC.....CALL



IBM 3151 ASCII terminal..... \$429

3 year on-site warranty!



WYSE 50..... \$379

WYSE 60..... \$419

WYSE WY700 1280 x 800... \$759

CONNECTIVITY

4-User Network Special

NOVELL

Server/Work Station:

INDECH 6/8 MHz AT-Fileserver - 12 slots, 238W Power Supply, Serial & Parallel Ports, Monitor, 1.2 Mb Floppy, 1 Mb RAM, 72 Mb Hard Drive, 60Mb Tape.

450 Watt U.P.S.

NOVELL ELS NetWare 286 Level I (4-users) Network set-up is Menu Driven!

4 ArcNet Cards, Cables & 1 Passive Hub

3 **FastData SUPERturbo XT's** - Ea. Incl: 640K, 4.77/10MHz, 8088-1 CPU, AT-Style Key-board, & Amber Tit 'n' Swivel Monitor FCC Approved.

**** A COMPLETE NETWORK ****

RETAIL..... \$9,258 **NOW ONLY** \$5,995



The Tower of Power...
The ARC Skyscraper!

ARC 386s Skyscraper - 6/16 MHz "0" Watt, 2Mb 80ns RAM on M.B., 1.44 Mb 3.5 Floppy Drive, 101 Keyboard 2-32, 4-16, & 2-8 bit slots, serial and parallel ports..... \$2,375.

ARC 386i Desktop - 6/16 MHz 1 Watt, 512K RAM, 1.2 Mb, 5.25 Floppy Drive, MS-DOS 3.2..... \$1,880.

ARC Turbo 12 - 1.5 MHz 80286-1 Watt, 1 Mb RAM, 1.2 Mb Flpy, MS-DOS 3.2..... \$1,195.

ARC Model 10 XT - 8088-10 MHz, 640K RAM, 360K Floppy, Serial, Parallel, Game, Clock/Calendar, MS-DOS 3.2..... \$ 588.

ARC Options

AT-Style Maxiswitch Keyboard..... \$ 69

RT-Style 101 Maxiswitch Keyboard..... \$ 79

Mitsubishi 360K Floppy Drive..... \$ 95

Mitsubishi 1.2 Mb Floppy Drive..... \$125

Monitors..... See Monitors

Drives..... See Drives

Ask about 1 & 2 year on-site service.

PC COMPATIBLE SOFTWARE*

Data Base Management

Ashton-Tate dBase III Plus..... \$378

KnowledgeMan 2.01..... \$285

PFS: Professional File..... \$125

R:Base 5000 System V..... \$415

Communications

Carbon Copy Plus (Mentlan)..... \$118

Crosstalk XVI (Microsoft)..... \$ 88

Microsoft Access..... \$137

Word Processors

NewWord (Wordstar 4.0 clone)..... \$178

WordStar 4.0..... \$334

MultiMate Advantage II..... \$268

PFS: Professional Write..... \$ 99

Word Perfect..... \$212

Integrated / Spreadsheets

Enable 2.0 (software group)..... \$375

Framework II (Ashton-Tate)..... \$375

Lotus 1-2-3..... \$298

Multiplan 1.11..... \$138

PFS: First Choice..... \$ 69

Symphony (Lotus)..... \$438

Desktop Publishing

PFS: First Publisher..... \$ 54

Xerox Ventura 1.1..... \$519

Graphics & Mice

Harvard Graphics..... \$188

IMSI OptiMouse Serial..... \$ 88

IMSI Genius Mouse Serial..... \$ 59

Microsoft Bus Mouse..... \$ 98

SummaMouse-Optical..... \$ 78

Project Management

Harvard Total Project Manager..... \$284

* Compatibility with PC/XT/AT Clones not guaranteed.

LASER PRINTERS

H.P. LaserJet Series II
8 Pgs/min, 8 Internal fonts,
512K RAM HP, LaserJet Plus
compatible..... \$ 1,799!



Brother HL-8 1 Mb, 20 fonts..... CALL

NEC Model 890 PS..... CALL

AST TurboLaser/EL 512K-3Mb, Ricoh Engine,
Upgradeable to PostScript..... \$1,678

AST TurboLaser/PS Ricoh, Postscript, AppleMac/PC
IF, 3Mb, 35 fonts, 300dpi, Fast Graphics! \$2,995

PRINTERS & PLOTTERS

brother HR-20
\$ 415



M-1709..... \$439 / **M-1509**..... \$339

HR-40..... \$569 / **HR-60**..... \$699

houston instrument CALL

Ask about Nationwide Service!

Panasonic

1080 Model 2..... \$179 **1091 Model 2**..... \$199

1092 I..... \$329 **1592**..... \$449

1695..... \$499 **3131**..... \$299

3151..... \$489

DRIVES

PRIM

ID 130 133Mb, 20mSEC w/ Installation Hardware/
Software (Maxtor XT-1140 Compatible)..... \$2,168

ID75 74Mb, 20mSEC..... \$995

ID100 103Mb 20mSEC w/AT RLL Ctrl..... \$1,179

ID230 233Mb 20mSEC w/software, RLL Ctrl..... \$2,549

V150 43Mb 30mSEC..... \$699

Everex 60I 60 Mb Internal Tape..... \$739

Fujitsu 360K flpy dr..... \$ 79 / 1.2 Mb..... \$125

Micropolis 85Mb 28mSEC..... \$ 888

Mitsubishi MF501..... \$ 95 / **MF504 1.2Mb**..... \$125

Mitsubishi 3.5" 1.4 Mb Floppy..... \$139

Mitsubishi 3.5" 720K..... \$115

Seagate 20 Mb PC Subsystem..... \$ 275

Seagate 30 Mb PC Subsystem, ST-238&Ctrl..... \$329

Teac FD-55-BV 48pl..... \$ 95 / **FD55GV 1.2**..... \$125

MODEMS & BOARDS

ANCHOR

1200 External..... \$119 / **1200 Internal**..... \$ 79

2400 External..... \$149 / **2400 Internal**..... \$129

CTS 2424 ADH ASYNCH/SYNCH (Hayes)..... \$229

CTS 2424 AMH Class 4 MNP Error Correct..... \$289

MultiTech..... CALL

Prometheus ProModems - Close Out!..... CALL

U.S. Robotics Personal Modems..... CALL

6-PAK Plus..... \$119

RAMPAGE-286-512K..... \$400

RAMPAGE XT-266K..... \$256

Hot Shot 286-10XT Accel. Bd..... \$369

ADVANTAGE-AT-512K..... \$275

Intel Above Board/286-512K 4020..... \$339

Microsoft Mach 10 / Window / Mouse..... \$324

COMPUTER ACCESSORIES

Data Display for overhead projectors..... \$695

FREE Carrying Case! - While Inventory Lasts

Power Savers 400-1000W Models..... FROM..... \$495

800-528-3138 Orders Only 602-991-7870 Customer Service

S-100 Div./696 Corp. • 14151 N. 76th St. • Scottsdale, AZ 85260 • TELEX 9103806778 SNSCORP FAX 602-483-0920

Advised prices are cash - prepaid, VISA or M.C. Only. Customers qualifying for terms calculate addl charges in the following way: P.O.'s & AMEX + .95 C.O.D.'s + .99 Shipping first 6 lbs. min. \$5.00
*Fees FedEx only applies to orders from 1-9 lbs & over \$50. Sales tax AZ res. only. All returns subject to a restocking fee or full credit towards a future purchase. All prices subject to change without notice.

California Digital

17700 Figueroa Street • Carson, California 90248



Color Monitor
Better Than **EGA**
\$1095 **\$459**

Ideal for CAD/CAM and Desk Top publishing applications. The Roland CD/240 color monitor and graphic adapter card has a resolution of 720 pixels by 400 lines on a .31mm dot pitch 12" non-glare screen. Technical specifications of the CD/240 exceed EGA and approach VGA standards. Comparable monitor and card packages retail at over \$1095. California Digital has made a special purchase and is able to offer this outstanding value at only \$459.

Also Available: Amdek • Conrac • Hitachi • Magnavox • Mitsubishi • NEC • Panasonic • Princeton • Samsung • Sony • Teatung • Tazun • Thompson • Zenith



Xerox Laptop \$189

The Xerox Sunrise 1810/1815 is by far the best value we have ever seen in a laptop computer. This is the ideal computer for students, journalists or anyone who has to capture data away from their desk. The Sunrise is a self contained battery and AC portable. The Xerox Sunrise was originally priced at \$2995. Xerox has since elected to drop the computer from their product line. California Digital has purchased all the remaining inventory and is making the unit available at a fraction of its original cost.

This laptop features a built in three line 90 column liquid crystal display, 54K of memory along with both RF monitor and television outputs. The internal 300 baud Bell 103 full duplex and 1200 baud Bell 202A half duplex modem is capable of auto dialing. The unit has both centronics parallel and a serial port programmable to 19,200 baud. Self contained micro cassette is capable of capturing data from the keyboard as well as doubling as a audio recorder for dictating messages.

An optional dual floppy disk drive module is available for only \$150. Also available, for \$59 is an 80 column printer that mounts in the drive module. The Sunrise features a CP/M operating system which allows the operator to use any program in Xerox 5^{1/4}" format and over 5000 CP/M programs available in public domain. While files from the Sunrise may be transferred to IBM/PC type computers, the 1810 is NOT compatible with the IBM/PC computer.

9600 BPS Modem \$379



The Amdek asynchronous modem is CCITT compatible and operates 9600 bps on a four wire dedicated phone line. Amdek's suggested price is \$1495. Limited quantities available at only \$379. Also available 19.2 kbps units. Please phone for additional information.

\$129 PLOTTERS

The Sweet "P" 100 was private labeled for the Epson corporation under the Conrux Brand. This plotter makes short work of translating financial and numeric data into a graphic presentation. Many ready to run programs such as AutoCAD and Lotus 1-2-3 already support this plotter.

The Sweet "P" 100 features programmable paper sizes up to 8 1/2 by 120 inches, 8 inch per second plot speed and 0.004" stop accuracy. Easy to implement Centronics interface allows the Sweet "P" 100 immediate use with the printer port of most personal computers.

This is your opportunity to purchase a plotter which was originally priced at \$795 for only \$129.

Also available is a support package which includes demonstration software, interface cable, a multicolor pen assortment and a variety of paper.



HEWLETT PACKARD LASER JET II \$1795

Standard features of the new Hewlett Packard Series II Laser printer: 512 K byte memory expandable to 4 Megabytes, both serial and parallel ports. List price \$2495. California Digital price \$1795. Memory upgrade, type fonts and toner cartridges available.

Other Laser Printers available:
Texas Instruments • Okidata • Apple • Ricoh
Quam • AST Research • GMS • Xerox • Canon
Cudram • Centronics • CIE C/tech • DataProducts

Smarteam 2400 \$239



The Smarteam 2400 offers all the features of the Hayes Smart Modem 2400 for a fraction of the price. Now is your opportunity to purchase a 2400 baud modem for only \$239. Also available: The Smarteam 1200 at only \$129.

MODELS	\$119
Avistar 1200HC external, Hayes compatible	\$119
CTS 1200 baud modem	89
Hayes Smartmodem 2400 baud modem	529
Smarteam 2400 Hayes Compatible	259
Smarteam 1200 Hayes Compatible, 300/1200	119
Smarteam 1200B IBM 1200 baud card	119
UltraLink 1200 data and voice, Bell 202	99
Prometheus 1200 super features	265
Prominimus 1200B internal PC	159
Signamax Mark VI, 300 baud internal PC	35



HPGL • 11" by 17" \$795

Western Graphics Model 2000 operates under the Hewlett Packard graphic language and has both parallel and serial interface. Size "B" plotter, 11" by 17" flat bed with eight self capping color pens. Maximum plotting speed 11" per second, resolution 508mm with repeatability of .004".

To blow out the remaining inventory, California Digital has slashed the price of MP/2000 to \$795. Hurry! only 180 plotters left.



21 Megabyte Gold Card \$379

The Gold Card from Silicon Valley Computers features shock mounted automatic head unloading, 15 watt drive coupled with a 250 byte sector buffer and advanced DMTC controller for maximum reliability, 30,000 hour MTBF and a 2 year warranty - the best cost per megabyte hardcard available. Also available the 30 Meg Gold Card at only \$419.

Model	Price	Model	Price
Model 100	\$149	Model 200	\$199
Model 300	\$249	Model 400	\$349
Model 500	\$449	Model 600	\$549
Model 700	\$649	Model 800	\$749
Model 900	\$849	Model 1000	\$949

TELETYPE MODEL 40 \$119



The Teletype Model 40 CRT is a continuous duty communication terminal that has recently come off lease from the United States Navy. It is seldom that California Digital becomes involved in the marketing of USED products but we felt that this terminal represented such an exceptional value that we had to offer this equipment to our customers.

The Model 40 CRT terminal has a RS-232 and current loop serial interface as well as a printer port. The language features back mode, full screen editing as well as DCL/DC3 select capabilities.

21 Megabyte Hard Disk Kit \$269

The "INSIDER 21" is a shock mounted 21 Megabyte hard drive kit. Complete with shortcard controller, software utilities, instructions and cable, the "INSIDER 21" is ready for immediate installation. This rugged system handles 40 G's and includes a SASI interface that allows tape back-ups and other peripherals to be added to your system. Manufacturer's ONE YEAR warranty included, all this for only \$269.



	One	Two	Ten
REMEX 480 1/2 height for PC	39	35	29
TANDON 65L/2 360K, 1/2 ht.	79	75	72
TANDON 101/4 full ht. 96 TP.	119	109	99
FUJITSU 514" half height	95	89	82
MITSUBISHI new 501 half ht.	119	109	105
MITSUBISHI 504A AT comp.	149	139	135
TEAC FD55BV half height	109	99	89
TEAC FD55FV 96 TPI, half ht.	119	109	105
TEAC FD55GF for IBM AT	149	139	135
PANASONIC 455 Half Height	109	99	89
PANASONIC 475 1.2 Meg./96	119	115	109
Switching power supply		49	
Dual enclosure for 5 1/4" drives		59	

Quick Link \$59



The Quick-Link 300 gives you an instant link to any dial up data base, such as Dow Jones, Western Union, or the Source. The Quick-Link has four user programmable log-on keys, allowing the operator, with only one key stroke, to dial the data base, log-in, and give the password. All this information is permanently stored in non-volatile RAM. Features include video output to television or monitor, auto dial, auto-log, full sized keyboard, 300 baud modem and 1200 baud auxiliary printer port. All this is available for only \$69.

Five inch Winchester Disk Drives

Price does not include controller. each drive →

SEAGATE 225 20 Meg. 1/2 Ht.	269	259
SEAGATE 235 30 Meg. RLL	299	289
SEAGATE 4026 26 M. 35ms.	559	539
SEAGATE 4051 51 M. 35ms.	695	659
SEAGATE 4098 96 M. 35ms.	859	829
MINISCRIBE 3425 25 m. 85ms.	279	249
MINISCRIBE 3650 50 m. 61 ms.	419	399
FUJITSU 2242 55 M. 35ms.	1299	1229
FUJITSU 2243 86 M. 35ms.	1695	1619
ROOIME RD-204E 53 Meg.	995	959
CONTROL DATA 94155-86 M.1820	1779	1719
MAXTOR XT1140 140 Meg.	2595	2529
TOSHIBA MK5670 M. 30ms.	1799	1729

• Winchester Controllers for IBM/PC •

XEBEC 1220 with floppy controller	189
DTC 5150CX	119
DMTI 5520 half card	99
DMTI 5527 RLL controller	129
ADAPTEC 2070 RLL controller	179
ADAPTEC 2010A	159
WESTERN DIGITAL WD/1002WX2	89

• SCSI/SASI Winchester Controllers •

XEBEC 1410A 5 1/4" foot print	219
WESTERN DIGITAL 1002-05E 5 1/4"	299
DMTI 20L	89

• Winchester Accessories •

Installation Kit (with manual)	10
Winchester enclosures and supply	139
Dual 20/34 cable set	20
Switching power supply	40

3 1/2" DISK DRIVES

SONY MP-53W 720K/Byte	129	125	119
SONY MP-73W, 2 Meg.	159	149	call
TEAC 35FN 720 K/Byte	129	119	115
TEAC 35HN/30, 2 Meg.	159	149	145
5 1/4" form factor kit			20

8" DISK DRIVES

QUME 642 double sided	189	179	175
QUME 641 single sided	119	109	99
SHUGART 851R dbl. sided	319	309	299
REMEX RFD-6000 dbl. sided	189	179	165
OLIVETTI 851	189	179	165

Shipping. First five pounds \$3.00, each additional pound \$ 50
Foreign orders: 10% shipping, excess will be refunded.
California residents add 6 1/2% sales tax. • COD's discouraged.
Open accounts extended to state supported educational institutions and companies with a strong "Dun & Bradstreet" rating.

TOLL FREE ORDER LINE
(800) 421-5041
TECHNICAL & CALIFORNIA
(213) 217-0501

Telex • (213) 217-1951



C's IC's, Parts, Components... Shipped Fast!

West Coast's Largest Selection... Call for More

RAM Upgrades!

...priced in sets of 9

- 64K/120ns \$18.95
- 64K/150ns 16.95
- 256K/100ns 48.95
- 256K/120ns 39.95
- 256K/150ns 34.95

DYNAMIC RAMS

4118/200ns	\$1.29	4464/150ns	\$3.49
M44352/200ns	5.85	41256/100ns	5.45
4164/200ns	1.95	41256/120ns	4.69
4164/120ns	3.95	41256/150ns	3.95
4184/PRN QME	2.75	41264/150ns	11.85
4418/200ns	3.75	4128/150ns	4.19
4418/150ns	4.18	1 MEG/100ns	32.95
4464/120ns	6.49	TMS 4161/150ns	6.95

STATIC RAMS

2102LP/450ns	\$ 88	0116/120ns	\$2.95
2101/450ns	1.70	6116LP/150ns	2.45
2112/450ns	2.89	6254LP/120ns	4.95
2114/450ns	88	6254LP/150ns	4.45
2114Z	1.19	8254/150ns	4.25
2114LZ	1.99	8255B/120ns	12.85
6116/150ns	2.45	8255B/100ns	19.85

74 HCT SERIES

74HC100	\$2.25	74HC161	\$1.65	74HC154D	\$1.99
74HC102	2.5	74HC163	65	74HC154	1.99
74HC104	2.5	74HC164	65	74HC1563	2.99
74HC108	2.5	74HC175	65	74HC1564	2.99
74HC110	2.5	74HC176	1.29	74HC1573	1.99
74HC127	30	74HC240	1.29	74HC1574	1.99
74HC174	49	74HC244	1.29	74HC1640	1.99
74HC138	50	74HC245	1.29	74HC1646	2.99
74HC157	65	74HC257	65	74HC1563	2.99
74HC160	65	74HC259	1.10	74HC1564	2.99

LINEAR

CA3080	\$1.19	LM205	\$1.10	LM3000	45
CA3090	1.19	LM207	75	LM3004	1.25
CA3090	1.19	LM273	75	LM3011	1.59
LF347H	1.49	LM733	30	LM3014	2.75
LF354H	1.49	LM734	30	LM3015	2.75
LF358H	1.89	LM737	30	LM3016	2.75
LF411	1.89	LM740	65	LM3024	3.95
LM1001	1.00	LM741	65	LM3044	3.95
LM1009H	1.00	LM742	65	LM3045	3.95
LM1317H	2.99	LM743	65	LM3046	3.95
LM1317T	1.75	LM744	65	LM3047	3.95
LM1318	1.75	LM745	65	LM3048	3.95
LM1319	95	LM746	65	LM3049	3.95
LM1320	1.00	LM747	65	LM3050	3.95
LM1321	1.00	LM748	65	LM3051	3.95
LM1322	1.00	LM749	65	LM3052	3.95
LM1323	1.00	LM750	65	LM3053	3.95
LM1324	1.00	LM751	65	LM3054	3.95
LM1325	1.00	LM752	65	LM3055	3.95
LM1326	1.00	LM753	65	LM3056	3.95
LM1327	1.00	LM754	65	LM3057	3.95
LM1328	1.00	LM755	65	LM3058	3.95
LM1329	1.00	LM756	65	LM3059	3.95
LM1330	1.00	LM757	65	LM3060	3.95
LM1331	1.00	LM758	65	LM3061	3.95
LM1332	1.00	LM759	65	LM3062	3.95
LM1333	1.00	LM760	65	LM3063	3.95
LM1334	1.00	LM761	65	LM3064	3.95
LM1335	1.00	LM762	65	LM3065	3.95
LM1336	1.00	LM763	65	LM3066	3.95
LM1337	1.00	LM764	65	LM3067	3.95
LM1338	1.00	LM765	65	LM3068	3.95
LM1339	1.00	LM766	65	LM3069	3.95
LM1340	1.00	LM767	65	LM3070	3.95
LM1341	1.00	LM768	65	LM3071	3.95
LM1342	1.00	LM769	65	LM3072	3.95
LM1343	1.00	LM770	65	LM3073	3.95
LM1344	1.00	LM771	65	LM3074	3.95
LM1345	1.00	LM772	65	LM3075	3.95
LM1346	1.00	LM773	65	LM3076	3.95
LM1347	1.00	LM774	65	LM3077	3.95
LM1348	1.00	LM775	65	LM3078	3.95
LM1349	1.00	LM776	65	LM3079	3.95
LM1350	1.00	LM777	65	LM3080	3.95
LM1351	1.00	LM778	65	LM3081	3.95
LM1352	1.00	LM779	65	LM3082	3.95
LM1353	1.00	LM780	65	LM3083	3.95
LM1354	1.00	LM781	65	LM3084	3.95
LM1355	1.00	LM782	65	LM3085	3.95
LM1356	1.00	LM783	65	LM3086	3.95
LM1357	1.00	LM784	65	LM3087	3.95
LM1358	1.00	LM785	65	LM3088	3.95
LM1359	1.00	LM786	65	LM3089	3.95
LM1360	1.00	LM787	65	LM3090	3.95
LM1361	1.00	LM788	65	LM3091	3.95
LM1362	1.00	LM789	65	LM3092	3.95
LM1363	1.00	LM790	65	LM3093	3.95
LM1364	1.00	LM791	65	LM3094	3.95
LM1365	1.00	LM792	65	LM3095	3.95
LM1366	1.00	LM793	65	LM3096	3.95
LM1367	1.00	LM794	65	LM3097	3.95
LM1368	1.00	LM795	65	LM3098	3.95
LM1369	1.00	LM796	65	LM3099	3.95
LM1370	1.00	LM797	65	LM3100	3.95
LM1371	1.00	LM798	65	LM3101	3.95
LM1372	1.00	LM799	65	LM3102	3.95
LM1373	1.00	LM800	65	LM3103	3.95
LM1374	1.00	LM801	65	LM3104	3.95
LM1375	1.00	LM802	65	LM3105	3.95
LM1376	1.00	LM803	65	LM3106	3.95
LM1377	1.00	LM804	65	LM3107	3.95
LM1378	1.00	LM805	65	LM3108	3.95
LM1379	1.00	LM806	65	LM3109	3.95
LM1380	1.00	LM807	65	LM3110	3.95
LM1381	1.00	LM808	65	LM3111	3.95
LM1382	1.00	LM809	65	LM3112	3.95
LM1383	1.00	LM810	65	LM3113	3.95
LM1384	1.00	LM811	65	LM3114	3.95
LM1385	1.00	LM812	65	LM3115	3.95
LM1386	1.00	LM813	65	LM3116	3.95
LM1387	1.00	LM814	65	LM3117	3.95
LM1388	1.00	LM815	65	LM3118	3.95
LM1389	1.00	LM816	65	LM3119	3.95
LM1390	1.00	LM817	65	LM3120	3.95
LM1391	1.00	LM818	65	LM3121	3.95
LM1392	1.00	LM819	65	LM3122	3.95
LM1393	1.00	LM820	65	LM3123	3.95
LM1394	1.00	LM821	65	LM3124	3.95
LM1395	1.00	LM822	65	LM3125	3.95
LM1396	1.00	LM823	65	LM3126	3.95
LM1397	1.00	LM824	65	LM3127	3.95
LM1398	1.00	LM825	65	LM3128	3.95
LM1399	1.00	LM826	65	LM3129	3.95
LM1400	1.00	LM827	65	LM3130	3.95
LM1401	1.00	LM828	65	LM3131	3.95
LM1402	1.00	LM829	65	LM3132	3.95
LM1403	1.00	LM830	65	LM3133	3.95
LM1404	1.00	LM831	65	LM3134	3.95
LM1405	1.00	LM832	65	LM3135	3.95
LM1406	1.00	LM833	65	LM3136	3.95
LM1407	1.00	LM834	65	LM3137	3.95
LM1408	1.00	LM835	65	LM3138	3.95
LM1409	1.00	LM836	65	LM3139	3.95
LM1410	1.00	LM837	65	LM3140	3.95
LM1411	1.00	LM838	65	LM3141	3.95
LM1412	1.00	LM839	65	LM3142	3.95
LM1413	1.00	LM840	65	LM3143	3.95
LM1414	1.00	LM841	65	LM3144	3.95
LM1415	1.00	LM842	65	LM3145	3.95
LM1416	1.00	LM843	65	LM3146	3.95
LM1417	1.00	LM844	65	LM3147	3.95
LM1418	1.00	LM845	65	LM3148	3.95
LM1419	1.00	LM846	65	LM3149	3.95
LM1420	1.00	LM847	65	LM3150	3.95
LM1421	1.00	LM848	65	LM3151	3.95
LM1422	1.00	LM849	65	LM3152	3.95
LM1423	1.00	LM850	65	LM3153	3.95
LM1424	1.00	LM851	65	LM3154	3.95
LM1425	1.00	LM852	65	LM3155	3.95
LM1426	1.00	LM853	65	LM3156	3.95
LM1427	1.00	LM854	65	LM3157	3.95
LM1428	1.00	LM855	65	LM3158	3.95
LM1429	1.00	LM856	65	LM3159	3.95
LM1430	1.00	LM857	65	LM3160	3.95
LM1431	1.00	LM858	65	LM3161	3.95
LM1432	1.00	LM859	65	LM3162	3.95
LM1433	1.00	LM860	65	LM3163	3.95
LM1434	1.00	LM861	65	LM3164	3.95
LM1435	1.00	LM862	65	LM3165	3.95
LM1436	1.00	LM863	65	LM3166	3.95
LM1437	1.00	LM864	65	LM3167	3.95
LM1438	1.00	LM865	65	LM3168	3.95
LM1439	1.00	LM866	65	LM3169	3.95
LM1440	1.00	LM867	65	LM3170	3.95
LM1441	1.00	LM868	65	LM3171	3.95
LM1442	1.00	LM869	65	LM3172	3.95
LM1443	1.00	LM870	65	LM3173	3.95
LM1444	1.00	LM871	65	LM3174	3.95
LM1445	1.00	LM872	65	LM3175	3.95
LM1446	1.00	LM873	65	LM3176	3.95
LM1447	1.00	LM874	65	LM3177	3.95
LM1448	1.00	LM875	65	LM3178	3.95
LM1449	1.00	LM876	65	LM3179	3.95
LM1450	1.00	LM877	65	LM3180	3.95
LM1451	1.00	LM878	65	LM3181	3.95
LM1452	1.00	LM879	65	LM3182	3.95
LM1453	1.00	LM880	65	LM3183	3.95
LM1454	1.00	LM881	65	LM3184	3.95
LM1455	1.00	LM882	65	LM3185	3.95
LM1456	1.00	LM883	65	LM3186	3.95
LM1457	1.00	LM884	65	LM3187	3.95
LM1458	1.00	LM885	65	LM3188	3

256K STATIC

32K x 8 \$12.95
150ns

256K DRAM

41256 \$3.95
150ns

STATIC RAMS

2112	256x4	(450ns)	2.99
2114	1024x4	(450ns)	4.99
2114L-2	1024x4	(200ns)(LOW POWER)	1.49
TMM2016-100	2048x8	(100ns)	1.95
HM6116-3	2048x8	(200ns)(CMOS)	1.75
HM6116-3	2048x8	(150ns)(CMOS)	1.85
HM6116LP-4	2048x8	(200ns)(CMOS)(LP)	1.85
HM6116LP-3	2048x8	(150ns)(CMOS)(LP)	1.90
HM6116LP-2	2048x8	(120ns)(CMOS)(LP)	2.25
HM6264LP-15	8192x8	(150ns)(CMOS)(LP)	3.98
HM6264LP-12	8192x8	(120ns)(CMOS)(LP)	4.49
HM43256LP-15	32768x8	(150ns)(CMOS)(LP)	12.95
HM43256LP-12	32768x8	(120ns)(CMOS)(LP)	14.95
HM43256LP-10	32768x8	(100ns)(CMOS)(LP)	19.95

DYNAMIC RAMS

4116-250	16384x1	(250ns)	4.9
4116-200	16384x1	(200ns)	8.9
4116-150	16384x1	(150ns)	9.9
4118-120	16384x1	(120ns)	1.49
NR4332	32768x1	(200ns)	6.95
4164-180	65536x1	(150ns)	1.75
4164-120	65536x1	(120ns)	1.99
MCM6665	65536x1	(200ns)	1.95
TM84164	65536x1	(150ns)	1.99
4164-REFRESH	65536x1	(150ns)(PIN 1 REFRESH)	2.95
TM84416	16384x4	(150ns)	3.75
41128-150	131072x1	(150ns)	5.95
TM84484-15	65536x4	(150ns)	4.95
41256-180	262144x1	(150ns)	3.95
41256-120	262144x1	(120ns)	4.49
41256-100	262144x1	(100ns)	6.49
HMS1258-100	262144x1	(100ns)(CMOS)	6.95
1 MB-120	1048576x1	(120ns)	31.95
1 MB-100	1048576x1	(100ns)	34.95

EPROMS

2708	1024x8	(450ns)(25V)	4.95
2716	2048x8	(450ns)(25V)	3.49
2718-1	2048x8	(360ns)(25V)	3.95
2732	4096x8	(450ns)(25V)	5.95
2732A	4096x8	(250ns)(21V)	3.95
2732A-2	4096x8	(200ns)(21V)	4.25
27C84	8192x8	(250ns)(12.5V CMOS)	4.95
2784	8192x8	(450ns)(12.5V)	3.49
2784-200	8192x8	(200ns)(12.5V)	3.69
2784-250	8192x8	(200ns)(12.5V)	4.25
MCM68798	8192x8	(350ns)(21V)(24 PIN)	15.95
27128	16384x8	(250ns)(12.5V)	4.25
27C288	32768x8	(250ns)(12.5V CMOS)	7.95
27C58	32768x8	(250ns)(12.5V)	5.95
27S12	65536x8	(250ns)(12.5V)	11.95
27C512	65536x8	(250ns)(12.5V CMOS)	12.95

uA-V Program Voltage

★ ★ ★ ★ HIGH-TECH ★ ★ ★ ★

8052AH WITH BASIC \$34.95

- SINGLE CHIP MICRO-CONTROLLER WITH BASIC IN ROM
- BUILT-IN SERIAL-PORT, THREE 16 BIT TIMERS, FIVE INTERRUPTS AND 256 BYTES OF RAM
- REQUIRES VERY FEW PARTS TO BUILD AND EASY-TO-PROGRAM CONTROLLER
- BASIC INTERPRETER IS OPTIMIZED FOR CONTROL APPLICATIONS

★ ★ ★ ★ SPOTLIGHT ★ ★ ★ ★

8000		8200		8255		159	
8031	3.95	8203	14.95	8255 5	1.99		
8035	1.45	8205	3.29	8259	1.95		
8039	1.95	8212	1.49	8269 5	2.29		
8052AH BASIC	34.95	8216	1.49	8287	2.29		
8080	2.49	8224	2.25	8272	4.95		
8085	1.95	8228	2.25	8274	4.95		
8086	6.49	8237	3.95	8275	16.95		
8088	6.99	8237-5	4.78	8279	2.49		
8088-2	7.95	8243	1.95	8279-5	2.95		
8155	2.49	8250	6.95	8282	3.95		
8155-2	3.95	8251	1.29	8283	3.95		
8741	9.95	8251A	1.89	8284	2.75		
8745	7.95	8253	1.99	8286	3.95		
8749	9.95	8253-5	1.95	8287	3.99		
8766	14.95	8255	1.49	8288	4.95		

INTEL MATH COPROCESSORS

8087	\$99.95	80287-8	\$249.95
8087-2	\$59.95	80287-10	\$309.95
80287	\$179.95	80387-16	\$499.95

TOLL FREE
800-538-5000
U.S. AND CANADA

74LS00

74LS00	16	74LS112	25	74LS241	69
74LS01	18	74LS122	45	74LS242	69
74LS02	17	74LS124	48	74LS243	69
74LS03	18	74LS124	2.75	74LS244	59
74LS04	18	74LS125	38	74LS245	79
74LS06	18	74LS126	38	74LS246	49
74LS08	18	74LS132	38	74LS253	49
74LS08	18	74LS133	49	74LS257	39
74LS10	16	74LS136	39	74LS258	49
74LS11	22	74LS138	39	74LS259	1.29
74LS12	22	74LS138	38	74LS260	69
74LS13	26	74LS145	99	74LS266	39
74LS14	39	74LS147	99	74LS273	78
74LS16	26	74LS148	99	74LS279	39
74LS20	17	74LS151	39	74LS280	1.95
74LS21	22	74LS153	39	74LS283	69
74LS22	22	74LS154	1.48	74LS289	88
74LS23	22	74LS155	39	74LS293	69
74LS28	25	74LS155	49	74LS299	1.49
74LS30	17	74LS157	35	74LS322	95
74LS32	18	74LS159	29	74LS323	2.48
74LS33	28	74LS160	29	74LS386	38
74LS37	26	74LS161	39	74LS367	39
74LS38	26	74LS182	43	74LS386	39
74LS42	39	74LS183	39	74LS373	79
74LS47	75	74LS184	49	74LS374	78
74LS48	69	74LS185	85	74LS378	99
74LS51	17	74LS186	85	74LS377	79
74LS53	29	74LS189	99	74LS390	1.19
74LS74	24	74LS173	48	74LS393	79
74LS75	29	74LS174	39	74LS504	1.49
74LS76	29	74LS179	39	74LS624	1.95
74LS83	49	74LS191	40	74LS640	99
74LS86	49	74LS192	69	74LS670	89
74LS96	22	74LS193	69	74LS678	89
74LS80	39	74LS194	69	74LS682	89
74LS92	49	74LS195	69	74LS688	2.40
74LS93	39	74LS196	69	74LS793	2.95
74LS95	49	74LS197	69	28LS2521	2.80
74LS107	34	74LS221	69	26LS31	1.80
74LS109	36	74LS240	69	28LS32	1.95

7400

7400	19	LM071	69	LM567	79
7402	19	LM072	1.09	NE570	2.95
7404	19	LM074	1.95	NE592	98
7406	29	LM082	99	LM723	49
7407	29	LM084	1.49	LM733	98
7408	24	LM301	1.49	LM741	29
7410	19	LM309K	1.25	LM747	69
7411	25	LM311	59	MC1330	1.69
7414	48	LM311H	89	MC1350	1.19
7416	25	LM317K	3.49	LM1458	35
7417	25	LM317I	69	LM1488	49
7420	19	LM318	1.49	LM1489	49
7430	19	LM319	1.25	LM1496	85
7432	29	LM329	7900	ULN2003	79
7435	29	LM323K	3.49	XR2209	3.95
7442	69	LM324	34	XR2011	2.95
7445	69	LM331	3.95	LM2917	1.95
7447	39	LM334	1.19	CA3046	89
7473	24	LM335	1.79	CA3146	1.29
7474	34	LM336	1.75	MC1373	1.29
7475	45	LM338	4.49	MC1370	99
7476	35	LM339	59	MC1480	89
7483	50	LM340	7800	MC1487	2.95
7489	59	LF353	59	LM3900	49
7486	35	LF356	99	LM3911	2.75
7489	2.15	LF357	34	LM3909	59
7490	39	LM358	59	LM3914	89
7493	35	LM380	89	MC4024	3.49
74121	25	LM383	1.95	MC4044	3.99
74123	49	LM385	89	RC4356	1.25
74124	35	LM385	79	LM4888	99
74150	1.35	LM394H	0.95	LM13600	1.49
74151	35	TL494	4.20	75107	1.49
74153	55	TL497	3.25	75110	1.95
74154	1.49	NE555	29	75150	1.95
74187	95	NE556	49	75154	1.95
74189	1.65	NE558	79	75188	1.25
74191	69	NE564	1.95	75189	1.25
74184	85	LM565	95	75451	3.99
74168	1.00	LM566	89	75452	3.99
74175	69	NE590	2.50	75477	1.29
74267	65	NE590	2.50	75477	1.29

LINEAR

CMOS/HIGH SPEED CMOS

4001	19	4066	28	74HC157	1.09
4011	19	4069	1.19	74HC164	55
4012	25	4070	25	74HC165	2.95
4013	35	4081	22	74HC246	85
4015	29	4093	48	74HC273	69
4018	29	14411	9.95	74HC273	69
4017	49	14433	14.95	74HC274	69
4018	59	14438	9.95	74HC280	69
4020	59	4503	49	74HC202	28
4021	69	4511	89	74HC204	28
4023	25	4518	85	74HC205	28
4024	49	4528	75	74HC232	27
4025	25	4538	89	74HC244	45
4027	35	4702	5.95	74HC238	85
4028	85	74HC00	2.1	74HC239	85
4040	85	74HC02	2.1	74HC2161	78
4042	85	74HC04	2.1	74HC2240	85
4044	89	74HC08	2.8	74HC244	85
4046	89	74HC10	2.8	74HC245	85
4047	89	74HC14	3.5	74HC273	85
4049	29	74HC32	39	74HC273	85
4060	29	74HC74	35	74HC274	85
4061	69	74HC86	45	74HC293	85
4062	89	74HC138	45	74HC4017	1.15
4063	89	74HC139	45	74HC4040	1.09
4060	89	74HC151	85	74HC4060	1.45

8500 1.0 MHz

8507	2.25
85C02 (CMOS)	7.95
8520	1.45
8522	2.89
8526	13.95
8537	8.99
8545	2.95
8561	2.95

2.0 MHz

8502A	2.69
8520A	2.35
8522A	5.95
8532A	2.95
8548A	3.95
8561A	4.95

3.0 MHz

8502B	4.25
-------	------

Z-80 2.5 MHz

Z80-CPU	1.25
Z80A-CPU	1.29
Z80A-CTC	1.59
Z80A-DART	5.95
Z80A-DMA	5.95
Z80A-PIO	1.89
Z80A-SIO 0	5.95
Z80A-SIO 1	5.95
Z80A-SIO 2	9.95

8.0 MHz

Z80B-CPU	2.78
Z80B-CTC	4.29
Z80B-PIO	4.25
Z80B-DART	6.98
Z80B-SIO 0	12.95

20 MEG HARD DISK DRIVE ON A CARD \$349!

BARGAIN HUNTERS CORNER

DIABLO D25 PRINTER

THIS OFFICE WORKHORSE LISTED AT \$695
A REAL STEAL AT \$279.95!

- ★ LETTER QUALITY AT 20 CPS, 132 COL.
- ★ USES STANDARD DIABLO 630 PRINT-WHEELS AND RIBBONS
- ★ 10, 12, 15 PITCH AND PROPORTIONAL
- ★ SERIAL AND PARALLEL INTERFACE
- ★ QUIET OPERATION - LESS THAN 58 db
- ★ AUTO PAPER LOAD, FRICTION FEED
- ★ FULL XEROX WARRANTY!

ONLY \$279.95

PARALLEL OR SERIAL CABLE (PLEASE SPECIFY) \$19.95

HURRY—QUANTITIES LIMITED!
SPECIAL ENDS 3/31/88

CAPACITORS

TANTALUM					
1.0µF	15V	12	1.0µF	35V	45
6.8	15V	42	2.2	35V	19
10	15V	45	4.7	35V	38
22	15V	50	10	35V	09
DISC					
10µF	50V	05	001µF	50V	05
22	50V	05	005	50V	05
33	50V	05	01	50V	07
47	50V	05	05	50V	07
100	50V	05	1	12V	10
220	50V	05	1	50V	12
MONOLITHIC					
.01µF	50V	14	1µF	50V	15
.047µF	50V	15	47µF	50V	28
ELECTROLYTIC					
RADIAL			AXIAL		
1µF	25V	14	1µF	50V	14
4.7	50V	11	10	50V	18
10	50V	11	22	16V	14
47	35V	13	47	50V	19
100	16V	15	100	35V	19
220	35V	20	470	50V	28
470	25V	30	1000	16V	28
2200	16V	70	2200	16V	70
4700	25V	148	4700	16V	128

SOLDER STATION

- UL APPROVED
- ADJUSTABLE HEAT SETTING W/ TIP TEMP HEADOUT
- QUICK HEATING & RECOVERY
- RANGE 200°-900°F

\$49.95

EXTENDER CARDS FOR IBM

EXT-8088 \$29.95
EXT-80286 \$39.95



WIREWRAP PROTOTYPE CARDS

FR + ENCL GLASS LAMINATE GOLD PLATED EDGE CARDS FINISH



XT

HOTEL CARDS HAVE 50th SCREENED LEADERS & MOUNTING BRACKET

IBM-PR1 \$27.95
WITH .5V AND GROUND PLANE

IBM-PR2 \$29.95
AS ABOVE WITH DECODING LAYOUT

AT

IBM-PRAT \$29.95
LARGE .5V & GROUND PLANES

SOLDERLESS BREADBOARDS

WBU-D	100 TIE POINTS	2.95
WBU-T	630 TIE POINTS	6.95
WBU-204-3	1360 TIE POINTS	17.95
WBU-204	1660 TIE POINTS	24.95
WBU-206	4390 TIE POINTS	29.95
WBU-208	3220 TIE POINTS	39.95

PAGE WIRE WRAP WIRE PRECUT ASSORTMENT IN ASSORTED COLORS \$27.50

100mm: 5.5", 6.0", 6.5", 7.0"
250mm: 2.5", 4.5", 5.0"
500mm: 3.0", 3.5", 4.0"

SPOOLS

100 feet \$4.30 250 feet \$7.25
500 feet \$13.25 1000 feet \$21.95

Please specify color
Blue, Black, Yellow or Red

SOCKET-WRAP I.D.™

- SLIPS OVER WIRE WRAP PINS
- IDENTIFIES PIN NUMBERS ON WRAP SIDE OF BOARD
- CAN WRITE ON THE PLASTIC, SUCH AS AN IC #

PINS	PART #	PKG. OF	PRICE
8	IDWRAP 08	10	1.88
14	IDWRAP 14	10	1.98
18	IDWRAP 18	10	1.98
18	IDWRAP 18	5	1.85
20	IDWRAP 20	5	1.85
22	IDWRAP 22	5	1.95
24	IDWRAP 24	5	1.85
28	IDWRAP 28	5	1.95
40	IDWRAP 40	5	1.95

PLEASE ORDER BY NUMBER OF PACKAGES (PKG. OF)

SWITCHES

SPDT	MINI TOGGLE ON-ON	1.25
DPDT	MINI TOGGLE ON-ON	1.50
DPDT	MINI TOGGLE ON-OFF ON	1.75
SPST	MINI PUSHBUTTON N/O	.39

DIP SWITCHES

4 position	85	7 position	.95
5 position	90	8 position	.95
6 position	90	10 position	1.25

"SNAPABLE" HEADERS

CAN BE SNAPPED APART TO MAKE ANY SIZE HEADER, ALL WITH 1" CENTERS

1x40	STRAIGHT LEAD	.99
1x40	RIGHT ANGLE LEAD	1.49
2x40	2 STRAIGHT LEADS	2.49
2x40	2 RIGHT ANGLE LEADS	2.99



25 PIN D-SUB GENDER CHANGERS \$7.95



EMI FILTER \$4.95 LINE CORDS

2 conductor 39C 3 conductor 59C
3 conductor w/female socket \$1.49

RESISTOR NETWORKS

SIP	10 PIN	9 RESISTOR	.69
SIP	8 PIN	7 RESISTOR	.59
DIP	16 PIN	8 RESISTOR	1.09
DIP	16 PIN	15 RESISTOR	1.09
DIP	14 PIN	7 RESISTOR	.99
DIP	14 PIN	13 RESISTOR	.99

36 PIN CENTRONICS

IDCEN38	RIBBON CABLE	3.95
CEN36	SOLDER CUP	1.85
IDCEN36 F	RIBBON CABLE	4.95
CEN36PC R	Angle PC Mount	1.85

EDBECARD CONNECTORS

100 Pin ST	S-100	125	3.95
100 Pin WW	S-100	125	4.95
62 Pin ST	IBM PC	100	1.95
80 Pin ST	APPLE	100	2.95
44 Pin ST	STD	180	1.85
44 Pin WW	STD	150	4.95

VOLTAGE REGULATORS

7805CT	.49	7812K	1.39
7808T	.49	7905K	1.89
7812T	.49	7912K	1.49
7815T	.49	78L05	.49
7905T	.59	78L12	.49
7808T	.59	79L05	.49
7912T	.59	79L12	1.49
7818T	.59	LM323K	4.79
7805K	1.69	LM338K	5.95

DISCRETE

1N751	.15	4N25	.69
1N4148B5	1.19	4N33	.39
1N400410	1.19	4N37	1.19
1N5402	.25	MCT-2	.59
K8P02	.55	MCT-6	1.29
2N2222	.25	TIL-111	.99
2N2222	10	2N3906	10
3N2907	.25	2N4401	.25
2N3055	.79	2N4402	.25
2N3904	10	2N4403	.25
4N28	.69	2N6048	1.75
4N27	.69	TP131	.49

WHY THOUSANDS CHOOSE JDR

- QUALITY MERCHANDISE COMPETITIVE PRICES
- MOST ORDERS SHIPPED IN 24 HOURS
- FRIENDLY, KNOWLEDGEABLE STAFF
- MONEY BACK GUARANTEE (ASK FOR DETAILS)
- TOLL FREE TECHNICAL SUPPORT
- EXCELLENT CUSTOMER SERVICE



DATABASE

- ERASES 2 EPROMS IN 10 MINUTES
- VERY COMPACT, NO DRAWER
- THIN METAL SHUTTER PREVENTS UV LIGHT FROM ESCAPING

\$34.95



IDC CONNECTORS/RIBBON CABLE

DESCRIPTION	ORDER BY	CONTACTS					
		10	20	26	34	40	50
SOLDER HEADER	IDHxxS	.82	1.29	1.88	2.20	2.58	3.24
RIGHT ANGLE SOLDER HEADER	IDHxxSR	.85	1.35	1.76	2.31	2.72	3.39
WIREWRAP HEADER	IDHxxW	1.86	2.98	3.84	4.50	5.28	6.63
RIGHT ANGLE WIREWRAP HEADER	IDHxxWR	2.08	3.28	4.22	4.45	4.88	7.30
RIBBON HEADER SOCKET	IDHxx	.83	.89	.95	1.29	1.49	1.69
RIBBON HEADER	IDMxx	~	5.50	6.25	7.00	7.80	8.50
RIBBON EDGE CARD	IDExx	.85	1.26	1.35	1.75	2.05	2.45
10' GREY RIBBON CABLE	RCxx	1.60	3.20	4.10	6.40	8.40	7.50

FOR ORDERING INSTRUCTIONS SEE D-SUBMINIATURE CONNECTORS BELOW

D-SUBMINIATURE CONNECTORS

DESCRIPTION	ORDER BY	CONTACTS						
		9	15	19	25	37	50	
SOLDER CUP	MALE	DBxxP	.45	.59	.69	.89	1.35	1.55
	FEMALE	DBxxS	.49	.69	.75	.76	1.39	2.29
RIGHT ANGLE PC SOLDER	MALE	DBxxPR	.49	.69	---	.70	2.27	---
	FEMALE	DBxxSR	.55	.75	---	.85	2.49	---
WIREWRAP	MALE	DBxxPWW	1.89	2.56	---	3.89	5.60	---
	FEMALE	DBxxSww	2.78	4.27	---	6.84	9.95	---
IDC RIBBON CABLE	MALE	IDBxxP	1.39	1.99	---	2.25	4.25	---
	FEMALE	IDBxxS	1.45	2.05	---	2.38	4.49	---
HOODS	METAL	MHOODxx	1.09	1.15	1.25	1.25	---	---
	GREY	HOODxx	.39	.39	---	.39	.69	.78

ORDERING INSTRUCTIONS: INSERT THE NUMBER OF CONTACTS IN THE POSITION MARKED "X" OF THE ORDER BY PART EXAMPLE: A 10 PIN RIGHT ANGLE MALE PC SOLDER WOULD BE DB15PR NUMBER LISTED

MOUNTING HARDWARE 50¢

IC SOCKETS/DIP CONNECTORS

DESCRIPTION	ORDER BY	CONTACTS								
		8	14	16	18	20	22	24	28	40
SOLDERTAIL SOCKETS	xxRT	11	.11	.12	.15	.18	.15	.20	.22	.20
WIREWRAP SOCKETS	xxWW	.59	.59	.69	.99	1.99	1.39	1.49	1.69	1.99
ZIF SOCKETS	ZIFxx	---	4.95	4.95	---	5.95	---	5.95	6.95	9.95
TOOLED SOCKETS	AUGATxxST	.82	.79	.89	1.09	1.29	1.39	1.49	1.69	2.49
TOOLED WW SOCKETS	AUGATxxWW	1.30	1.80	2.10	2.40	2.50	2.90	3.15	3.70	5.40
COMPONENT CARRIERS	ICCx	.49	.55	.69	.99	.99	.99	.99	1.09	1.49
DIP PLUGS (IDC)	IDPxx	.95	.49	.58	1.29	1.49	---	.99	1.49	1.59

FOR ORDERING INSTRUCTIONS SEE D-SUBMINIATURE CONNECTORS ABOVE

3 VOLT LITHIUM BATTERY \$1.95 HOLDER \$1.49

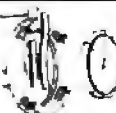

Dear Mr. Rose,

I am writing to compliment the service I received yesterday on a phone call to JDR. I spoke to a salesperson named Helen. She went out of her way to assist. It is service like this that keeps us coming back to JDR.

Thanks!

Jim Miskewitz

CALL FOR VOLUME QUOTES

COPYRIGHT 1988 JDR MICRODEVICES

Circle 132 on Reader Service Card

64K DRAM 4164 \$179
150ns**256K DRAM** 41256 \$395
150ns**MONITOR STANDS****MODEL MS-100 \$12.95**

• TILTS & SWIVELS • STURDY PLASTIC CONSTRUCTION

MODEL MS-200 \$39.95• TILTS AND SWIVELS • BUILT-IN SURGE SUPPRESSOR
• BUILT-IN POWER STATION INDEPENDENTLY CONTROLS
UP TO 8 120 VOLT AC OUTLETS • UL APPROVED**NASHUA DISKETTES**

BOXES OF 10	5 1/4" DS/DD 360K	\$9.95	5 1/4" DS/HD 1.2M	\$24.95
	5 1/4" DS/HD 1.2M	\$24.95	5 1/4" DS/DD 720K	\$16.95

49¢ 39¢
BULK QTY 50 BULK QTY 250

5 1/4" DISKETTE STORAGE FILE \$8.95• HOLDS 70 5 1/4" FLOPPIES
• STURDY, ATTRACTIVE
SMOKED ACRYLIC CASE
• COMPLETE WITH HINGED
DIVIDERSVERSION FOR 3 1/2"
FLOPPIES AVAILABLE
\$8.95**2 WAY SWITCH BOXES \$39.95**• CONNECT 2 PRINTERS TO 1 COMPUTER OR VICE VERSA
• SERIAL & PARALLEL MODELS AVAILABLE
• ALL LINES SWITCHED
• GOLD PLATED CONNECTORS & QUALITY SWITCHES**6' INTERFACE CABLES**

MEETS FCC REQUIREMENTS 100% SHIELDED

IBM COMPATIBLE PARALLEL PRINTER	\$9.95
CENTRONICS (MALE TO FEMALE)	\$15.95
CENTRONICS (MALE TO MALE)	\$14.95
IBM COMPATIBLE MODEM CABLE	\$7.95
RS232 SERIAL (MALE TO FEMALE)	\$3.99
RS232 SERIAL (MALE TO MALE)	\$9.99
COILED KEYBOARD EXTENDER	\$7.95

JOYSTICK \$19.95• SET X-Y AXIS FOR AUTO
CENTER OR FREE MOVE
MENT
• FIRE BUTTON FOR USE
WITH GAME SOFTWARE
• INCLUDES ADAPTOR
CABLE FOR IBM**SWITCHING POWER SUPPLIES****PS-135 \$59.95**• FOR IBM XT COMPATIBLE
• UL APP., 135 WATTS
• .5V 16A, .12V 4.2A
• .5V 5A, 12V 5A
• ONE YEAR WARRANTY

PS-135/150

PS-150 (NEW MODEL) \$69.95• FOR IBM AT COMPATIBLE
• 200 WATTS
• .5V 22A, .12V 8A
• .8V 5A, .12V 5A
• ONE YEAR WARRANTY

PS-200

PS-A \$49.95• FOR APPLE TYPE SYSTEM
• .5V 8A, .12V 3A
• .5V 1A, .12V 1A
• APPLE CONNECTOR

PS-1558

PS-1558 \$34.95• 75 WATTS, UL APPROVED
• BY POWER SYSTEMS
• .5V 7A, .12V 3A
• .12V 280mA, .5/300mA**MONITORS****SAMSUNG
MONOCHROME**• IBM COMPATIBLE TTL
INPUT
• 12" NON-GLARE,
LOW DISTORTION,
AMBER SCREEN
• RES- 720 x 350
• SWIVEL BASE
• 1 YEAR WARRANTY**\$129.95****MULTISYNC BY NEC \$599.95**• ORIGINAL CGA, EGA, VGA COMPATIBLE MONITOR
• AUTO FREQUENCY ADJUSTMENT
• RESOLUTION AS HIGH AS 800 x 640**EGA BY CASPER \$399.95**• 15.75 - 21.95 KHz SCANNING FREQUENCIES
• RES. 640 x 200 - 350 • 31mm DOT PITCH
• 14" BLACK MATRIX SCREEN • 16 COLORS FROM 64**RGB BY CASPER \$279.95**• COLOR GREEN/AMBER SWITCH • RES. 640 x 240
• RGB/IBM COMPATIBLE • 14" NON-GLARE SCREEN
• .38mm DOT PITCH • CABLE FOR IBM PC INCLUDED**MONOCHROME BY SAKATA \$89.95**• IBM COMPATIBLE TTL INPUT
• 12" NON-GLARE GREEN SCREEN
• CABLE FOR IBM PC INCLUDED**TOLL FREE****800-538-5000****U.S. AND CANADA****20MB HARD DISK ON A CARD**• SAVES SPACE AND REDUCES
POWER CONSUMPTION
• IDEAL FOR PCs WITH FULL
HEIGHT FLOPPIES
• LEAVES ROOM FOR A HALF
LENGTH CARD IN ADJACENT
SLOT**\$349****RITEMAN II PRINTER**• 180 CPS DRAFT, 32 CPS NLD MODE
• SUPPORTS EPSON/IBM
GRAPHICS
• 9 x 9 DOT MATRIX
• FRICTION AND
PIN FEEDS
• VARIABLE LINE
SPACING & PITCH**\$219.95**

IBM COMPATIBLE PRINTER CABLE \$8.95

REPLACEMENT RIBBON CARTRIDGE \$7.95

DISK DRIVES**5 1/4" SEAGATE HARD DISK DRIVES**

ST-225	HALF HEIGHT 20MB	65ms	\$259
ST-238	HALF HEIGHT 30MB	65ms (RL)	\$299
ST-251	HALF HEIGHT 40MB	40ms	\$489
ST-277	HALF HEIGHT 60MB	40ms (RL)	\$649
ST-4038	FULL HEIGHT 30MB	40ms	\$559
ST-4056	FULL HEIGHT 80MB	28ms	\$895

1/2 HEIGHT FLOPPY DISK DRIVES

5 1/4" TEAC FD-55B DS	DD 360K	\$99.95
5 1/4" TEAC FD-55F DS	QUAD 720K	\$119.95
5 1/4" TEAC FD-55G DS	HD 1.2M	\$129.95
5 1/4" FUJITSU M2551A DS	DD 360K	\$89.95
5 1/4" FUJITSU M2553K DS	HD 1.2M	\$119.95
5 1/4" DS	DD 360K	\$69.95
5 1/4" DS	HD 1.2M	\$109.95
5 1/4" MITSUBISHI DS	DD (AT OR XT)	\$129.95

DISK DRIVE ACCESSORIES

1/2 HT MOUNTING HARDWARE FOR IBM	\$2.95
MOUNTING RAILS FOR IBM AT	\$4.95
5 1/4" POWER CABLE FOR 5 1/4" FDDs	\$2.95
5 1/4" FDD POWER CONNECTORS	\$1.95

DRIVE ENCLOSURES WITH POWER SUPPLIES

CAB-2SV6	DUAL SLIMLINE FOR 5 1/4"	\$49.95
CAB-1FH5	FULL HEIGHT FOR 5 1/4"	\$69.95
CAB-2SV8	DUAL SLIMLINE FOR 8"	\$209.95
CAB-2FH8	DUAL FULL HEIGHT FOR 8"	\$219.95

EASYDATA MODEMS

All models feature auto-dial/answer/redial on busy, power up self test, touchtone or pulse dialing, built-in speaker, Hayes and Bell Systems 103 & 212A compatible, full or half duplex, PC Talk III Communications software with internal models and more

**INTERNAL**

12H	1200 BAUD 1/2 CARD	\$89.95
24B	2400 BAUD FULL CARD	\$179.95

EXTERNAL

(NO SOFTWARE INCLUDED)

12D	1200 BAUD	\$119.95
24D	2400 BAUD	\$219.95

COMPUTER CASES

Attractive, sturdy steel cases fit the popular sized motherboards and include speakers, faceplates expansion slots and all necessary hardware.



XT STYLE FLIP-TOP	\$34.95
XT STYLE SLIDE-TOP	\$39.95
AT STYLE SLIDE-TOP	\$89.95

• FRONT PANEL KEYLOCK AND LED INDICATOR

JR. AT STYLE FLIP-TOP	\$149.95
-----------------------	----------

• INCLUDES 180 WATT POWER SUPPLY

• FRONT PANEL KEYLOCK AND LED INDICATOR



Visit our retail store located at 1256 S. Bascom Ave. in San Jose, (408) 947-8881

JDR Microdevices

110 Knowles Drive, Los Gatos, CA 95030

Toll Free 800-538-5000 • (408) 866-6200

FAX (408) 378-8927 • Telex 171-110

COPYRIGHT 1988 JDR MICRODEVICES

JDR MICRODEVICES AND THE JDR MICRODEVICES LOGO ARE REGISTERED TRADEMARKS OF JDR MICRODEVICES. JDR INSTRUMENTS IS A TRADEMARK OF JDR MICRODEVICES. IBM IS A TRADEMARK OF INTERNATIONAL BUSINESS MACHINES CORPORATION

ALL MCT PRODUCTS CARRY A 1 YEAR WARRANTY

INTERFACE CARDS

FROM MODULAR CIRCUIT TECHNOLOGY



MCT-MF

DISPLAY CARDS

MCT-MQP MONOCHROME GRAPHICS \$59⁹⁵

TRUE HERCULES COMPATIBILITY SUPPORTS LOTUS 123
SOFTWARE DRIVER ALLOWS COLOR GRAPHICS PROGRAMS TO RUN ON A MONOCHROME MONITOR • PARALLEL PRINTER PORT

MCT-EBA ENHANCED GRAPHICS ADAPTOR \$149⁹⁵

100% IBM COMPATIBLE PASSES IBM EGA DIAGNOSTICS
256K OF VIDEO RAM ALLOWS 640 x 350 IN 16 OF 64 COLORS
COMPATIBLE WITH COLOR AND MONOCHROME ADAPTOR

MCT-CG COLOR GRAPHICS ADAPTOR \$49⁹⁵

COMPATIBLE WITH IBM COLOR GRAPHICS STANDARDS
SHORT SLOT SUPPORTS RGB, COLOR & COMPOSITE MONOCHROME
640/320 & 200 RESOLUTION, LIGHT PEN INTERFACE

MULTIFUNCTION CARDS

MCT-MF MULTIFUNCTION \$79⁹⁵

ALL THE FEATURES OF 6 PACK - AT HALF THE PRICE
0-384K DYNAMIC RAM USING 4164s
SERIAL, PARALLEL, GAME PORTS, CLOCK/CALENDAR

MCT-M6MIO MONOGRAPHS I/O \$119⁹⁵

TOTAL SYSTEM CONTROL FROM A SINGLE SLOT
2 FLOPPY CONT, SERIAL, PARALLEL, GAME PORT, CLOCK/CAL
RUN COLOR GRAPHICS SOFTWARE ON A MONOCHROME MONITOR

MCT-MIO MULTI I/O FLOPPY \$79⁹⁵

A PERFECT COMPANION FOR OUR MOTHERBOARDS
SERIAL, PARALLEL, GAME PORT, CLOCK/CALENDAR
SUPPORTS UP TO 2 360K FLOPPIES, 720K WITH DOS 3.2

MCT-IO MULTI I/O CARD \$59⁹⁵

USE WITH MCT-FH FOR A MINIMUM OF SLOTS USED
SERIAL PORT, CLOCK/CALENDAR WITH A BATTERY BACK-UP
PARALLEL PRINTER PORT ADDRESSABLE AS LPT1 OR LPT2

MCT-ATMF AT MULTIFUNCTION \$139⁹⁵

ADDS UP TO 3 MEGABYTES OF RAM TO THE AT
USER EXPANDABLE TO 1.5 MB OF MEMORY (ZERO K INSTALLED)
INCLUDES SERIAL PORT AND PARALLEL PORT

MCT-ATIO AT MULTI I/O \$59⁹⁵

USE WITH MCT-ATFH FOR A MINIMUM OF SLOTS USED
SERIAL, PARALLEL AND GAME PORTS
USES 16450 SERIAL SUPPORT CHIPS FOR HIGH SPEED OPERATION

MCT-RAM MEMORY CARDS \$59⁹⁵

A CONTIGUOUS MEMORY SOLUTION IN A SHORT SLOT!
USER SELECTABLE CONFIGURATION AMOUNTS UP TO 576K USING 64K & 288K RAM CHIPS (ZERO K INSTALLED)

MCT-EMS EXPANDED MEMORY CARD \$129⁹⁵

2 MB OF LOTUS/INTEL/MICROSOFT COMPATIBLE MEMORY FOR AT
CONFORMS TO LOTUS/INTEL EMS • USER EXPANDABLE TO 2 MB
EXPANDED/CONVENTIONAL MEMORY, RAMDISK AND SPOOLER

MCT-ATMS AT VERSION \$139⁹⁵

DRIVE CONTROLLERS

MCT-FDC FLOPPY DISK CONTROLLER \$29⁹⁵

QUALITY DESIGN OFFERS 4 FLOPPY CONTROL IN A SINGLE SLOT
INTERFACES UP TO 4 FDDs TO AN IBM PC OR COMPATIBLE
SUPPORTS BOTH DS/DD AND DS/GD WITH DOS 3.2

MCT-HDC HARD DISK CONTROLLER \$79⁹⁵

HD CONTROL FOR WHAT OTHERS CHARGE FOR FLOPPY CONTROL
SUPPORTS 16 DRIVE SIZES INCLUDING 5, 10, 20, 30 & 40 MB
DIVIDE 1 LARGE DRIVE INTO 2 SMALLER, LOGICAL DRIVES

MCT-FDC-1.2 1.2MB FLOPPY CONTROLLER \$89⁹⁵

ADD VERSATILITY & CAPACITY TO YOUR XT
SUPPORTS 2 DRIVES, BOTH MAY BE 360K OR 1.2 MEG
ALLOWS DATA TO FLOW FREELY FROM XTs TO ATs

MCT-FH FLOPPY/HARD CONTROLLER \$139⁹⁵

SYSTEM STARTED FOR SLOTS? SATISFY IT WITH THIS TIMELY DESIGN
INTERFACES UP TO 2 FDDs & 2 HDDs, CABLING FOR 2 FDDs & 1 HDD
SUPPORTS BOTH DS/DD & DS/GD WITH DOS 3.2

MCT-ATFH AT FLOPPY/HARD CONTROLLER \$149⁹⁵

FLOPPY/HARD DISK CONTROL IN A TRUE AT DESIGN
SUPPORTS UP TO 2 360K/720K/1.2MB FDDs
AS WELL AS 2 HDDs USING STANDARD CONTROL TABLES



1/2 HEIGHT HARD DISK DRIVES

40 MB \$469
60 MB \$649

Drives are Seagate models ST-251 (40 MB) & ST-277 (60 MB RLL) 5 1/4" half heights
FAST 40ms access time!

1/2 HT HARD DISK SYSTEMS

20 MB \$289
30 MB \$329

Systems include Seagate 1/2 height hard drive, drive controller, cables & instructions. All drives are pre-tested & warranted for 1 year.

IBM COMPATIBLE MOTHERBOARDS

FROM MODULAR CIRCUIT TECHNOLOGY

MCT-TURBO TURBO 4.77/8 MHz \$99⁹⁵

4.77 OR 8 MHz OPERATION WITH 8088-2 & OPTIONAL 8087-2 CO-PROCESSOR
FRONT PANEL LED SPEED INDICATOR AND RESET SWITCH SET SUPPORTED
CHOICE OF NORMAL/TURBO MODE OR SOFTWARE SELECT PROCESSOR SPEED

MCT-XTMB STANDARD MOTHERBOARD \$87⁹⁵

8 SLOT (2 EIGHT BIT, 6 SIXTEEN BIT) AT MOTHERBOARD
HARDWARE SELECTION OF 6 OR 3 MHz
1 WAIT STATE

MCT-ATMB 80286 6/8 MHz \$379⁹⁵

KEYLOCK SUPPORTED, RESET SWITCH, FRONT PANEL LED INDICATOR
SOCKETS FOR 1 MB OF RAM AND 80287
BATTERY BACKED CLOCK

MCT-BATMB MINI 80286 \$389⁹⁵

REPLACEMENT BOARD FOR XT STYLE CHASSIS
OPERATE AT 6-10 MHz WITH UP TO 1MB ON-BOARD MEMORY (ZERO K INSTALLED)
SOCKET FOR 80287 MATH CO-PROCESSOR
BATTERY BACKED CLOCK

8 SLOTS, 2 EIGHT BIT, 6 SIXTEEN BIT
USES CHIPS & TECHNOLOGY CHIP SET FOR RELIABILITY AND SMALL SIZE

IBM COMPATIBLE KEYBOARDS

FULL ONE YEAR WARRANTY



MCT-5339 \$79⁹⁵

IBM ENHANCED STYLE LAYOUT
SOFTWARE AUTOSENSE FOR XT OR AT COMPATIBLES
LED INDICATORS
AUTO REPEAT FEATURE
SEPARATE CURSOR PAD

MCT-5080 \$59⁹⁵

IBM AT STYLE LAYOUT
SOFTWARE AUTOSENSE FOR XT OR AT COMPATIBLES
LED INDICATORS
AUTO REPEAT FEATURE

MCT-5150 XT STYLE LAYOUT \$49⁹⁵

MCT-5151 HB5151™ EQUIV. \$89⁹⁵

WHY BUY A SYSTEM FROM JDR?

- BUILD IT YOURSELF AND SAVE!
- MONEY BACK GUARANTEE (ASK FOR DETAILS)
- LEARN ABOUT THE INNER WORKINGS OF A COMPUTER
- YOU CAN ASSEMBLE A SYSTEM IN ABOUT 2 HOURS WITH A SCREWDRIVER & OUR EASY-TO-FOLLOW INSTRUCTIONS
- MOST ORDERS SHIPPED IN 24 HOURS
- QUALITY COMPONENTS AND COMPETITIVE PRICES
- TOLL FREE TECH SUPPORT IN THE U.S. AND CANADA

BUILD YOUR OWN 256K XT COMPATIBLE

- MOTHERBOARD
- 256K OF MEMORY
- 135 WATT POWER SUPPLY
- FLIP-TOP CASE
- XT STYLE KEYBOARD
- 360K FLOPPY DRIVE
- DRIVE CONTROLLER
- MONOCHROME MONITOR
- GRAPHICS ADAPTOR

FOR ONLY \$498¹⁵

ANYONE CAN BUILD A SYSTEM IN ABOUT 2 HOURS USING A SCREWDRIVER AND OUR EASY-TO-FOLLOW INSTRUCTIONS!

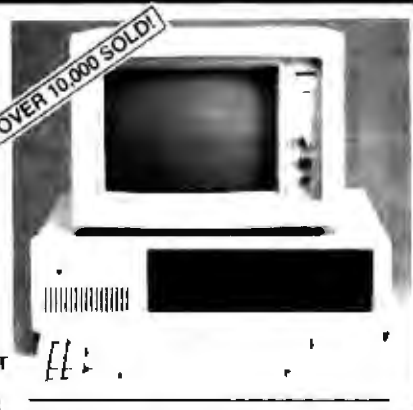

DEVELOPMENT TOOLS

FROM MODULAR CIRCUIT TECHNOLOGY

MCT-EPROM PROGRAMMER \$129⁹⁵

PROGRAMS 27xx & 27xxx EPROMS UP TO 27512
SUPPORTS VARIOUS PROGRAMMING FORMATS AND VOLTAGES
SPLIT OR COMBINE CONTENTS OF SEVERAL EPROMS OF DIFFERENT SIZES
READ, WRITE, COPY, ERASE CHECK AND VERIFY
SOFTWARE FOR HEX AND INTEL HEX FORMATS

MCT-EPROM-4 4 GAND PROGRAMMER \$189⁹⁵

MCT-EPROM-10 10 GAND PROGRAMMER \$289⁹⁵

MCT-PAL PAL PROGRAMMER \$269⁹⁵

MCT-MP PROCESSOR PROG. \$199⁹⁵



EDITORIAL INDEX BY COMPANY

Index of companies covered in articles, columns, or news stories in this issue.
Each reference is to the first page of the article or section in which the company name appears.

INQUIRY #	COMPANY	PAGE	INQUIRY #	COMPANY	PAGE	INQUIRY #	COMPANY	PAGE
937	ACIUS.....	187	773	GREEN HILLS	207	759	PACIFIC RIM SYSTEMS	67
857	ACTIVISION.....	89	774	GTCO.....	67	953	PAPERBACK SOFTWARE INTERNATIONAL.....	187
765	ADVANCED DIGITAL.....	67		GW INSTRUMENTS	67	930	PARADISE SYSTEMS	102
799	ALDUS	67, 187		HECHT-NIELSEN NEUROCOMPUTER	11	948	PARAGON CONCEPTS.....	187
945			757	HEWLETT-PACKARD	11, 67, 121	781	PC-SYSTEMS.....	67
928	AMERICAN MITAC.....	102	780			888	PERSONAL COMPUTER PERIPHERALS.....	134
	ANSA SOFTWARE	11	883			892		
772	ANTEX ELECTRONICS	67	764	HONEYWELL	67	796	PINETREE SOFTWARE.....	67
	APOLLO.....	197	984	IBM	11, 51, 102, 115	902	PROSOFT	169
891	APPLE COMPUTER.....	11, 134		IGC TECHNOLOGY	11	856	PROXIMITY TECHNOLOGY	89
894				INMOS.....	217	758	QMS.....	67
938	ASHTON-TATE	11, 187	903	INTECOLOR	169	762		
981	ATI TECHNOLOGIES	102	958	INTEL.....	217, 238	931	QUADRAM.....	102
	AUSTEC.....	207		INTELLIGENT ACCESS.....	11		QUINTUS COMPUTER SYSTEMS.....	11
	AWARD SOFTWARE	11	926	INTELLIGENT GRAPHICS.....	102	886	RADIUS	139
858	BINARY ENGINEERING	89		INTERFACE SOLUTIONS	11	786	RAY TRACING	67
782	BLAISE COMPUTING	67		INTERNATIONAL COMPONENT MANUFACTURING	11	934	REVOLUTION SOFTWARE	187
924	BOCA RESEARCH	102	778	ITAC SYSTEMS	67		RISING STAR INDUSTRIES	11
859	BORLAND INTERNATIONAL	89,		JASMINE TECHNOLOGIES	11	800	SALINON	67
896		155, 169, 187	797	KNOWLEDGE GARDEN	67	798	SANTA RITA SOFTWARE	67
907				LANGUAGE PROCESSORS	207	975	SCOA SYSTEMS.....	102
946				LEVCO.....	137	777	SEMICONDUCTOR PHYSICS.....	67
941	BRODERBUND SOFTWARE.....	187	944	LIVING VIDEOTEXT	187	985	SIGMA DESIGNS.....	102
	BROOKTREE.....	134	751	LLOYD I/O.....	67	951	SILICON BEACH SOFTWARE.....	187
784	BSOFT SOFTWARE.....	67	754			951	SILICON VALLEY SOFTWARE.....	207
788	BYTE BY BYTE	67	956	LOGICAL SYSTEMS.....	217, 238	795	SIMON & SCHUSTER SOFTWARE	67
771	CATAMOUNT	67	927	LOGITECH	102	976	SMT	102
933	CCI	243	854	LOTUS DEVELOPMENT.....	89, 155	943	SOFTAID	243
949	CE SOFTWARE	187	851	LUNDEEN & ASSOCIATES.....	187	779	SOFTKLONE DISTRIBUTING	187
776	CH PRODUCTS	67	887	MACMEMORY.....	137	947	SOFTWARE INTERPHASE.....	67
794	CHIPSOFT	67	790	MASSCOMP.....	197	942	SOFTWARE SUPPLY	187
	CIRRUS LOGIC	11		MATH WORKS.....	67	950	SOFTWARE VENTURES	187
792	CLEAR LAKE RESEARCH	67		METAWARE	197, 205, 207		SOLUTIONS.....	187
983	COMPAQ	102, 115, 197, 205	932	MICRO DESIGN	11	986	SPEECH SYSTEMS	11
899	COMPLETE LOGIC SYSTEMS.....	145	954	MICROMINT	243	889	STB SYSTEMS	102
955	COMPUTER SYSTEMS ARCHITECTS.....	217, 238	897	MICROPRO INTERNATIONAL.....	187	893	SUN	197
801	CONSUMERS SOFTWARE.....	67	898	MICROSOFT	127, 155, 169, 187	767	SUPERMAC TECHNOLOGY	134
775	CYBEX	67	906			783	SUPRA	67
769	DATA TRANSLATION	67, 238	936				SWANSON ANALYSIS SYSTEMS.....	67
957			789	MICROTECTURE	67	760	SYSTEMS MANUFACTURING TECHNOLOGY	67
	DATACOPY	11	939	MINDSCAPE	187	905	T. N. T. SOFTWARE	169
793	DATA X	67	766	MONITERM	67	895	TANDY/RADIO SHACK	127
787	DATUM SYSTEMS	67	959	MOTOROLA SEMICONDUCTOR PRODUCTS	238	977	TATUNG OF AMERICA.....	102
768	DELTA GOLD COMPUTER.....	67	752	NEC HOME ELECTRONICS (U.S.A.) INC.	67, 169	855	TECHNOLOGY MARKETING GROUP.....	89
	DEST	11	884	NEC INFORMATION SYSTEMS	102,	978	TECMAR	102
935	DOW JONES & COMPANY	187			121, 127		TEKKNOWLEDGE	11
770	DRESSELHAUS COMPUTER PRODUCTS	67	929	NSI LOGIC	102	979	TEXAS INSTRUMENTS	11
901	ELECTROHOME	169		OLDUVAI	11		THOMSON.....	102
791	ENCODE	67		ORACLE.....	11		3COM	11
940	ENZAN-HOSHIGUMI (U.S.A.)	187	908	ORCHID TECHNOLOGY	155, 169	952	TOPOLOGIX	11
	FAIRCHILD.....	217					TOPS	187
890	4SITE TECHNOLOGIES	134						
785	GALACTIC INDUSTRIES	67						
	GENERAL COMPUTER.....	137						
763	GENEST TECHNOLOGIES	67						
925	GENOA SYSTEMS	102						

INQUIRY #	COMPANY	PAGE	INQUIRY #	COMPANY	PAGE
	TOSHIBA	127		WORTHINGTON DATA SOLUTIONS	11
980	TSENG LABORATORIES	102			
	U.S. AIR FORCE.....	11	852	XYQUEST	187
761	VEN-TEL.....	67	753	ZENITH DATA SYSTEMS	67, 102, 115, 169
987	VIDEO SEVEN.....	11, 102	756		
			885		
960	WEITEK.....	197, 238	909		
			988		

COMING UP IN BYTE

Products in Perspective:

We begin this section with brief discussions of many new products in What's New. Short Takes will consider the following: Windows 2.0, Deskjet, Extra, Zenith Flat Screen, Sharp 4521, Oracle, and Sprint.

The Product Focus for April looks at 37 dot-matrix printers. If you're looking for a printer, check this out.

System reviews include the WYSE 386 and the Amiga 2000.

Hardware reviews cover liquid-crystal-shutter printers and two hardware debuggers, AT Probe and Periscope III.

Products up for discussion in software reviews are Microsoft C 5.0, FORTRAN 386, and Wendin DOS.

Application reviews feature Interleaf for the Macintosh and Byline.

Rounding out this section are the unique viewpoints of columnists Jerry Pournelle and Ezra Shapiro.

In Depth:

Our highlighted subject will be memory management, and the following topics will be covered: a memory management primer, OS/2 virtual memory management, implementing Unix on the 80386, and memory management on the Macintosh.

Features:

In Ciarcia's Circuit Cellar, Steve will present his SmartSpooler. Another article will look at Gordon Letwin's new book on OS/2, and we'll also provide information on a program called Fuzzy Prolog.

Protect Your Copies of BYTE

NOW AVAILABLE:

Custom-designed library files or binders in elegant blue simulated leather stamped in gold leaf.

Binders—Holds 6 issues, opens flat for easy reading.

\$9.95 each, two for \$18.95, or four for \$35.95.



Files—Holds 6 issues.

\$7.95 each, two for \$14.95, or four for \$27.95.



Order Now!

Mail to: Jesse Jones Industries, Dept. BY,
499 East Erie Ave.,
Philadelphia, PA 19134

Please send _____ files;
_____ binders for BYTE magazine.

Enclosed is \$_____. Add \$1 per file/binder for postage and handling.
Outside U.S.A. add \$2.50 per file/binder (U.S. funds only please).

Charge my: (minimum \$15)

_____ American Express _____ Visa

_____ MasterCard _____ Diners Club

Card # _____ Exp. Date _____

Signature _____

CALL TOLL FREE (24 hours):
1-800-972-5858

Name _____

Address _____ (No P.O. Box)

City _____

State _____ Zip _____

Satisfaction guaranteed.

Pennsylvania residents add 6% sales tax.

Allow 5-6 weeks delivery in the U.S.

BYTE

Important TIPS* for BYTE Subscribers: Receive Product Information 10 Days Earlier!



All you need is a touch-tone telephone and your subscriber I.D. number. See instructions facing the Reader Service Index in the back of this issue for outrageous time-saving opportunities!

*BYTE's Telephone Inquiry Processing Service

BYTE ADVERTISING SALES STAFF:

Dennis J. Riley, Advertising Sales Manager, One Phoenix Mill Lane, Peterborough, NH 03458, tel. (603) 924-9281

NEW ENGLAND
ME, NH, VT, MA, RI, ONTARIO
CANADA & EASTERN CANADA
Paul McPherson Jr. (617) 262-1160
McGraw-Hill Publications
575 Boylston Street
Boston, MA 02116

ATLANTIC
NY, NYC, CT, NJ (NORTH)
Leah G. Rabinowitz (212) 512-2094
McGraw-Hill Publications
1221 Avenue of the Americas—
39th Floor
New York, NY 10020

Dick McGark (203) 968-7111
McGraw-Hill Publications
Building A—3rd Floor
777 Long Ridge Road
Stamford, CT 06902

EAST
PA, NJ (SOUTH),
MD, VA, W VA, DE, D.C.
Daniel Ferro (215) 496-3833
McGraw-Hill Publications
Three Parkway
Philadelphia, PA 19102

SOUTHEAST
NC, SC, GA, FL, AL, TN
Carolyn F. Lovett (404) 252-0626
McGraw-Hill Publications
4170 Ashford-Dunwoody Road
Suite 420
Atlanta, GA 30319

MIDWEST
IL, MO, KS, IA, ND, SD, MN,
KY, OH, WI, NB, IN, MI, MS
Bob Denmark (312) 751-3740
McGraw-Hill Publications
Blair Building
645 North Michigan Ave.
Chicago, IL 60611

**SOUTHWEST,
ROCKY MOUNTAIN**
CO, WY, OK, TX, AR, LA
Karl Heinrich (713) 462-0757
McGraw-Hill Publications
7600 W. Tidwell Rd.—Suite 500
Houston, TX 77040

SOUTH PACIFIC
SOUTHERN CA, AZ, NM,
LAS VEGAS
Jack Anderson (714) 557-6292
McGraw-Hill Publications
3001 Red Hill Ave.
Building #1—Suite 222
Costa Mesa, CA 92626

Tom Harvey (213) 480-5243
McGraw-Hill Publications
3333 Wilshire Boulevard #407
Los Angeles, CA 90010

NORTH PACIFIC
HI, WA, OR, ID, MT,
NORTHERN CA,
NV (except LAS VEGAS), UT,
W. CANADA
Mike Kiseberth (415) 362-4600
McGraw-Hill Publications
425 Battery Street
San Francisco, CA 94111

Bill McAfee (415) 349-8100
McGraw-Hill Publications
951 Manner's Island Blvd.—
3rd Floor
San Mateo, CA 94404

BYTE BITS (2x3)
Dan Harper (603) 924-6830
BYTE Publications
One Phoenix Mill Lane
Peterborough, NH 03458

The Buyer's Mart (1x2)
Mark Stone (603) 924-3754
BYTE Publications
One Phoenix Mill Lane
Peterborough, NH 03458

Regional Advertising
(So. CA, Mid-Atlantic, Southeast,
New York/New England)
Elisa Lister (603) 924-6830
BYTE Publications
One Phoenix Mill Lane
Peterborough, NH 03458

Regional Advertising
(Pacific NW, Midwest, Southwest,
New York/New England)
Scott Gagnon (603) 924-9281
BYTE Publications
One Phoenix Mill Lane
Peterborough, NH 03458

BYTE Deck Mailings
National
Ed Ware (603) 924-6166
BYTE Publications
One Phoenix Mill Lane
Peterborough, NH 03458

A/E/C Computing Deck
Computing for Engineers
Mary Ann Gauding
(603) 924-9281
BYTE Publications
One Phoenix Mill Lane
Peterborough, NH 03458

International Advertising Sales Staff:

Mr. Hans Csokur
Publishmedia
Reichenstrasse 61
A-1037 Vienna, Austria
1 22 75 76 84

Mrs. Gurit Gopner
McGraw-Hill Publishing Co.
PO Box 2126
Bai Yam 39121 Israel
1 866 561 321 39

Mr. Fritz Krusebecker
McGraw-Hill Publishing Co.
Lichtrasse 19
D 6800 Frankfurt/Main 1
West Germany
69 72 01 81

Mrs. Maria Sarmiento
Pedro Teixeira B. Off. 320
Iberia Mart 1
Madrid 4, Spain
1 45 52 891

Mr. Gert Moberg
Andrew Kacung & Associates
Finnbodavagen
S-171 31 Nacka Sweden
8-44 0005

Mr. Alain Faure
McGraw-Hill Publishing Co.
128 Faubourg Saint Honoré
75008 Paris
France
(1) 42-89-03-81

Karen Lennie
McGraw-Hill Publishing Co.
34 Dover St
London W1X 3RA
England 01 493 1451

Manuela Capasso
McGraw-Hill Publishing Co.
Via Flavio Baracchini 1
20123 Milan, Italy
(2) 89010103

Seavex Ltd.
400 Orchard Road, #10-01
Singapore 0223
Republic of Singapore
Tel 734-9790
Telex: RS35539 SEAVEX

Seavex Ltd.
503 Wilson House
19-27 Wyndham St
Central, Hong Kong
Tel 5-260149
Telex: 60904 SEVEX HX

Hiro Morita
McGraw-Hill Publishing Co.
Overseas Corp.
Room 1528
Kasumigaseki Bldg.
3-2-4 Kasumigaseki
Chiyoda-Ku
Tokyo 100, Japan
3 581 9811

Mr. Ernest McCrazy
Empresa Internacional de
Comunicacoes Ltda
Rua da Consolacao, 222
Conjunto 103
01302 Sao Paulo, S.P., Brasil
Tel: (11) 259-3811
Telex: (100) 32122 EMBN

READER SERVICE

To get further information on the products advertised in BYTE, fill out the reader service card by circling the numbers on the card that correspond to the inquiry number listed with the advertiser. This index is provided as an additional service by the publisher, who assumes no liability for errors or omissions.

* Correspond directly with company

Index to Advertisers by Product Category

Inquiry No.	Page No.	Inquiry No.	Page No.	Inquiry No.	Page No.	Inquiry No.	Page No.
HARDWARE							
515	ADD IN9						
10 ALPHA PRODUCTS	303	33 B&C MICRO	299	235 SCR CORP	299	526	SYSTEMS
* AMER ADVANTECH CORP	298	44 BP MICROSYSTEMS	304	276 VOYETRA	295	6 ADV LOGIC RESEARCH	152,153
19 AMER ADVANTECH CORP	298	46 BYTEK CORP	200	521	MODEMS/MULTIPLEXORS	7 ADV LOGIC RESEARCH	152,153
25 ATI TECHNOLOGIES, INC	62	47 B&C MICRO SYSTEMS	236	* AT&T INFORMATION SYS.	184,185	* AMPRO	174
26 ATI TECHNOLOGIES, INC	63	111 GTEK	267	* CLEO SOFTWARE	126	* AT&T INFO. SYS.	184,185
27 ATRON	86	112 GTEK	267	261 TEAM TECH	259	* BINARY TECH	310
48 CAPITAL EQUIPMENT	214	142 LINK COMP GRAPHICS	292	267 TOUCHBASE	183	52 CLUB AMER TECHNOLOGY	56,57
77 DIGIBOARD	38	143 LOGICAL DEVICES	297	271 UNIVERSAL DATA SYSTEMS	55	58 COMPAQ	48,49
93 EVEREX	20,21	144 LOGICAL DEVICES	297	522	MONITORS	92 ENGINEERS COLLABORATIVE	310
94 EVEREX	20,21	145 LOGICAL DEVICES	297	69 CPT CORP	30	155 MAY COMPUTER	212
103 GALACTICOMM INC	118	146 LOGICAL DEVICES	297	85 DIVERSIFIED COMP	312	156 MAY COMPUTER	212
104 GENOA	85	164 MICROCIRCUIT DESIGNERS	312	176 MITSUBISHI	166,167	159 MEGATEL	94
105 GENOA	87	207 PROGRAMMABLE LOGIC TECH310		177 MITSUBISHI	166,167	195 PC PRIME	294
111 GTEK	267	289 XELTEK	314	205 PRINCETON GRAPHIC SYS	10	295 PROTEUS TECHNOLOGY CORP	177
112 GTEK	267	518	INSTRUMENTATION	206 PRINCETON GRAPHIC SYS	254	222 QUANTUS MICROSYSTEMS	272
122 INTEL CORP	100,101	131 JDR INSTRUMENTS	173	307 TATUNG CO. OF AMERICA	97	223 RADIO SHACK	45
124 IO TECH	216	141 LAWSON LABS	305	308 TATUNG CO. OF AMERICA	97	248 SORD COMPUTER	44
125 IO TECH	292	181 MOJAVE SCADA	312	290 ZENITH DATA SYSTEMS	263	256 SWEET ELECTRONICS	130
* MICROMINT	306	191 ORION	120	523	NETWORK HARDWARE	270 TYSTAR MANUFACTURING	299
174 MICROWAY	95	226 REAL TIME DEVICES	312	32 B&B ELECTRONICS	312	312 WELLS AMERICAN	216
* MICROWAY	237	519	MASS STORAGE	56 COGITATE	292	287 WYSE TECHNOLOGY	29
184 NATIONAL INSTRUMENTS	138	8 AK SYSTEMS	292	118 HI TECH EQUIPMENT	305	302 ZEOS INTERNATIONAL	308
198 PERSTOR	258	57 COMPACT DISC PRODUCTS, INC	40	185 NATURAL MICROSYSTEMS	226	527	TERMINALS
199 PERSTOR	258	67 CONTECH	295	301 THORMUD TECHNOLOGIES	314	136 KEA SYSTEMS	46
212 OUA TECH	296	313 FLAGSTAFF	91	280 WESTERN TELEMATIC	268	262 TELEVIDEO	119
213 OUA TECH	296	314 FLAGSTAFF	91	281 WESTERN TELEMATIC	268	SOFTWARE	
214 OUA TECH	296	315 FLAGSTAFF	91	524	PRINTERS/PLOTTERS	528	APPLE 2/MAC APPLICATIONS—
215 OUA TECH	296	316 FLAGSTAFF	91	12 ALPS AMERICA	8,9		Business/Office
216 OUA TECH	296	135 KAO CORP	93	13 ALPS AMERICA	8,9	3 ACIUS	150
217 OUA TECH	296	* MAXELL DATA PRODUCTS	7	70 CTX	107	529	APPLE 2/MAC APPLICATIONS—
218 OUA TECH	296	298 MOUNTAIN COMPUTER	274,275	71 CTX	107		Scientific/Technical
219 OUA TECH	296	221 QUALSTAR	305	311 DICONIX	239	252 SPSS, INC.	47
220 OUA TECH	296	237 SEAGATE	27	101 FUJITSU AMERICA	233	530	APPLE 2/MAC LANGUAGES
236 SEALEVEL SYSTEMS, INC	312	238 SEAGATE	27	102 FUJITSU AMERICA	233	244 SOFTWARE DEV SYS	189
268 TRUEVISION	32,33	MISCELLANEOUS		113 HEWLETT-PACKARD	111	531	IBM/MS-DOS APPLICATIONS—
292 Z-WORLD	299	36 BAY TECHNICAL ASSOCIATES	201	114 HEWLETT-PACKARD	113		Business/Office
516	DRIVES	49 CHUNG YU	214	115 HEWLETT-PACKARD	161	45 BRODERBUND	99
78 DIGITAL ELECTRONIC SYSTEMS	222	* COMPUTER CONTINUUM	298	116 HEWLETT-PACKARD	163	55 COGITATE	297
242 SILICON VALLEY COMPUTER	84	74 DATA TRANSLATION	17	117 HEWLETT-PACKARD	165	75 DB FAST	52
* SYSGEN, INC.	114	86 DRESSSELHAUS	24	* INECTRA	305	98 FOX SOFTWARE	37
305 TANDON	270,271	87 DRESSSELHAUS	24	186 NEC INFO SYSTEMS	CHI	99 FTG	305
306 TANDON	270,271	90 EMERSON ELECTRIC	181	187 OASYS	154	<i>Continued</i>	
264 TIGERTRONICS	60	91 EMERSON ELECTRIC	181	188 OASYS	154		
517	HARDWARE PROGRAMMERS	303 HOOLEON COMPANY	277	189 OLYMPIA U.S.A.	61		
23 APROTEK	295	304 HOOLEON COMPANY	277	291 ZERICON	314		
* A/OCET	298	* INECTRA	310	525	SCANNERS/DIGITIZERS		
34 B&C MICRO	295	121 INTEGRAND	180	106 GLORIOUS UNION	92		
		154 MAXTECH	297				
		225 RAINBOW TECHNOLOGIES	148				
		226 RAINBOW TECHNOLOGIES	148				
		229 ROSE ELECTRONICS	298				

FREE Information Retrieval Service

To assist you in making your evaluations, purchasing decisions, or recommendations, you can request further information directly from the manufacturer or service company on products and services advertised in this issue. There is no charge, no obligation. Just complete and mail the attached post-paid, self-addressed reply card, and we'll do the rest.

- 1** Circle numbers on reply card which correspond to numbers assigned to items of interest to you.
- 2** Check all the appropriate answers to questions "A" through "F".
- 3** Print your name and address and mail.

Fill out this coupon carefully. PLEASE PRINT. Requests cannot be honored unless the zip code is included. This card is valid for 6 months from cover date.

A. What is your primary job function? (Check one only)

- 1 Business Owner, General Management, Administrative
- 2 MIS/DP, Programming
- 3 Engineering/Scientific, R&D
- 4 Professional (law, medicine, accounting)
- 5 Other

B. How many people does your company employ?

- 1 25 or fewer
- 2 26-99
- 3 100-499
- 4 500-999
- 5 1000 or more

C. Reason for request: (Check all that apply).

- 1 Business use for yourself
- 2 Business use for your company
- 3 Personal use

D. Your next step after information is received:

- 1 Purchase order
- 2 Evaluation
- 3 Specification/Recommendation

E. Please indicate the product categories for which you influence the selection or purchase at your (or your client's) company or organization. (Check all that apply).

- 1 Microcomputers
- 2 Peripherals
- 3 Software
- 4 Accessories and supplies

F. For how many microcomputers do you influence the purchase of products at your (or your client's) company or organization?

- 1 1
- 2 2-4
- 3 5-9
- 4 10 or more

Name _____
 Title _____
 Company _____
 Address _____
 City _____ State _____
 Zip _____ Telephone _____

CIRCLE FOR FREE INFORMATION MARCH 483RSU

1	2	3	4	5	6	7	8	9	10	11	12	13	14	15	16	17	18	19	20	21	22	23	24	25	26	27
28	29	30	31	32	33	34	35	36	37	38	39	40	41	42	43	44	45	46	47	48	49	50	51	52	53	54
55	56	57	58	59	60	61	62	63	64	65	66	67	68	69	70	71	72	73	74	75	76	77	78	79	80	81
82	83	84	85	86	87	88	89	90	91	92	93	94	95	96	97	98	99	100	101	102	103	104	105	106	107	108
109	110	111	112	113	114	115	116	117	118	119	120	121	122	123	124	125	126	127	128	129	130	131	132	133	134	135
136	137	138	139	140	141	142	143	144	145	146	147	148	149	150	151	152	153	154	155	156	157	158	159	160	161	162
163	164	165	166	167	168	169	170	171	172	173	174	175	176	177	178	179	180	181	182	183	184	185	186	187	188	189
190	191	192	193	194	195	196	197	198	199	200	201	202	203	204	205	206	207	208	209	210	211	212	213	214	215	216
217	218	219	220	221	222	223	224	225	226	227	228	229	230	231	232	233	234	235	236	237	238	239	240	241	242	243
244	245	246	247	248	249	250	251	252	253	254	255	256	257	258	259	260	261	262	263	264	265	266	267	268	269	270
271	272	273	274	275	276	277	278	279	280	281	282	283	284	285	286	287	288	289	290	291	292	293	294	295	296	297
298	299	300	301	302	303	304	305	306	307	308	309	310	311	312	313	314	315	316	317	318	319	320	321	322	323	324
325	326	327	328	329	330	331	332	333	334	335	336	337	338	339	340	341	342	343	344	345	346	347	348	349	350	351
352	353	354	355	356	357	358	359	360	361	362	363	364	365	366	367	368	369	370	371	372	373	374	375	376	377	378
379	380	381	382	383	384	385	386	387	388	389	390	391	392	393	394	395	396	397	398	399	400	401	402	403	404	405
406	407	408	409	410	411	412	413	414	415	416	417	418	419	420	421	422	423	424	425	426	427	428	429	430	431	432
433	434	435	436	437	438	439	440	441	442	443	444	445	446	447	448	449	450	451	452	453	454	455	456	457	458	459
460	461	462	463	464	465	466	467	468	469	470	471	472	473	474	475	476	477	478	479	480	481	482	483	484	485	486
487	488	489	490	491	492	493	494	495	496	497	498	499	500	501	502	503	504	505	506	507	508	509	510	511	512	513
514	515	516	517	518	519	520	521	522	523	524	525	526	527	528	529	530	531	532	533	534	535	536	537	538	539	540
541	542	543	544	545	546	547	548	549	550	551	552	553	554	555	556	557	558	559	560	561	562	563	564	565	566	567
568	569	570	571	572	573	574	575	576	577	578	579	580	581	582	583	584	585	586	587	588	589	590	591	592	593	594
595	596	597	598	599	600	601	602	603	604	605	606	607	608	609	610	611	612	613	614	615	616	617	618	619	620	621
622	623	624	625	626	627	628	629	630	631	632	633	634	635	636	637	638	639	640	641	642	643	644	645	646	647	648
649	650	651	652	653	654	655	656	657	658	659	660	661	662	663	664	665	666	667	668	669	670	671	672	673	674	675
676	677	678	679	680	681	682	683	684	685	686	687	688	689	690	691	692	693	694	695	696	697	698	699	700	701	702
703	704	705	706	707	708	709	710	711	712	713	714	715	716	717	718	719	720	721	722	723	724	725	726	727	728	729
730	731	732	733	734	735	736	737	738	739	740	741	742	743	744	745	746	747	748	749	750	751	752	753	754	755	756
757	758	759	760	761	762	763	764	765	766	767	768	769	770	771	772	773	774	775	776	777	778	779	780	781	782	783
784	785	786	787	788	789	790	791	792	793	794	795	796	797	798	799	800	801	802	803	804	805	806	807	808	809	810
811	812	813	814	815	816	817	818	819	820	821	822	823	824	825	826	827	828	829	830	831	832	833	834	835	836	837
838	839	840	841	842	843	844	845	846	847	848	849	850	851	852	853	854	855	856	857	858	859	860	861	862	863	864
865	866	867	868	869	870	871	872	873	874	875	876	877	878	879	880	881	882	883	884	885	886	887	888	889	890	891
892	893	894	895	896	897	898	899	900	901	902	903	904	905	906	907	908	909	910	911	912	913	914	915	916	917	918
919	920	921	922	923	924	925	926	927	928	929	930	931	932	933	934	935	936	937	938	939	940	941	942	943	944	945
946	947	948	949	950	951	952	953	954	955	956	957	958	959	960	961	962	963	964	965	966	967	968	969	970	971	972
973	974	975	976	977	978	979	980	981	982	983	984	985	986	987	988	989	990	991	992	993	994	995	996	997	998	999

Fill out this coupon carefully. PLEASE PRINT. Requests cannot be honored unless the zip code is included. This card is valid for 6 months from cover date.

A. What is your primary job function? (Check one only)

- 1 Business Owner, General Management, Administrative
- 2 MIS/DP, Programming
- 3 Engineering/Scientific, R&D
- 4 Professional (law, medicine, accounting)
- 5 Other

B. How many people does your company employ?

- 1 25 or fewer
- 2 26-99
- 3 100-499
- 4 500-999
- 5 1000 or more

C. Reason for request: (Check all that apply).

- 1 Business use for yourself
- 2 Business use for your company
- 3 Personal use

D. Your next step after information is received:

- 1 Purchase order
- 2 Evaluation
- 3 Specification/Recommendation

E. Please indicate the product categories for which you influence the selection or purchase at your (or your client's) company or organization. (Check all that apply).

- 1 Microcomputers
- 2 Peripherals
- 3 Software
- 4 Accessories and supplies

F. For how many microcomputers do you influence the purchase of products at your (or your client's) company or organization?

- 1 1
- 2 2-4
- 3 5-9
- 4 10 or more

Name _____
 Title _____
 Company _____
 Address _____
 City _____ State _____
 Zip _____ Telephone _____

CIRCLE FOR FREE INFORMATION MARCH 483RSU

1	2	3	4	5	6	7	8	9	10	11	12	13	14	15	16	17	18	19	20	21	22	23	24	25	26	27
28	29	30	31	32	33	34	35	36	37	38	39	40	41	42	43	44	45	46	47	48	49	50	51	52	53	54
55	56	57	58	59	60	61	62	63	64	65	66	67	68	69	70	71	72	73	74	75	76	77	78	79	80	81
82	83	84	85	86	87	88	89	90	91	92	93	94	95	96	97	98	99	100	101	102	103	104	105	106	107	108
109	110	111	112	113	114	115	116	117	118	119	120	121	122	123	124	125	126	127	128	129	130	131	132	133	134	135
136	137	138	139	140	141	142	143	144	145	146	147	148	149	150	151	152	153	154	155	156	157	158	159	160	161	162
163	164	165	166	167	168	169	170	171	172	173	174	175	176	177	178	179	180	181	182	183	184	185	186	187	188	189
190	191	192	193	194	195																					



NO POSTAGE
NECESSARY
IF MAILED
IN THE
UNITED STATES

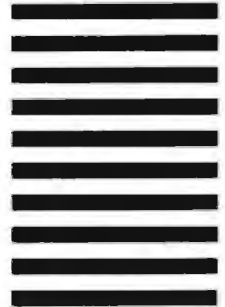

BUSINESS REPLY MAIL
FIRST CLASS MAIL PERMIT NO. 176 DALTON, MA

POSTAGE WILL BE PAID BY ADDRESSEE

BYTE

READER SERVICE
PO Box 298
Dalton, MA 01227-0298
USA



NO POSTAGE
NECESSARY
IF MAILED
IN THE
UNITED STATES

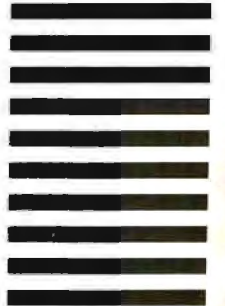

BUSINESS REPLY MAIL
FIRST CLASS MAIL PERMIT NO. 176 DALTON, MA

POSTAGE WILL BE PAID BY ADDRESSEE

BYTE

READER SERVICE
PO Box 298
Dalton, MA 01227-0298
USA

OUR SILENTWRITER IS CREATING HEADLINES ON SEVERAL FRONTS.



Our Silentwriter™ LC890 is the first desktop publishing printer that gives you both popular standards for creating graphics and type: true Adobe PostScript® and LaserJet Plus emulation.

That alone would be enough to cause headlines. But we also added many more features to simplify desktop publishing. Like both Apple and IBM compatibility. *PC Week* stated, "the LC890 is actually better than having both an Apple LaserWriter Plus and an HP LaserJet Plus on your desk." Equally impressed, *PC Magazine* awarded it an "Editor's Choice." And cited it in their "Best of 1987" issue.

And because the Silentwriter has a simple, trouble-free printing mechanism, it will be creating headlines for years to come. In fact, it's twice as reliable as ordinary lasers, with an average life of 600,000 pages.

If you don't require the power of our LC890, consider the rest of the family. The LC850 for text applications and the LC860 Plus for text and less complex graphics.

To start producing your own headlines, call 1-800-343-4418 (in MA 617-264-8635). We'll send you reprints of all the great reviews and the name of the NECIS dealer nearest you.



NEC PRINTERS. THEY ONLY STOP WHEN YOU WANT THEM TO.

NEC
NEC Information Systems, Inc.

Circle 186 on Reader Service Card

**Tandy Computers:
Because there is
no better value.**TM

TandyLinkTM and Professional DeskMateTM put your PCs on speaking terms.

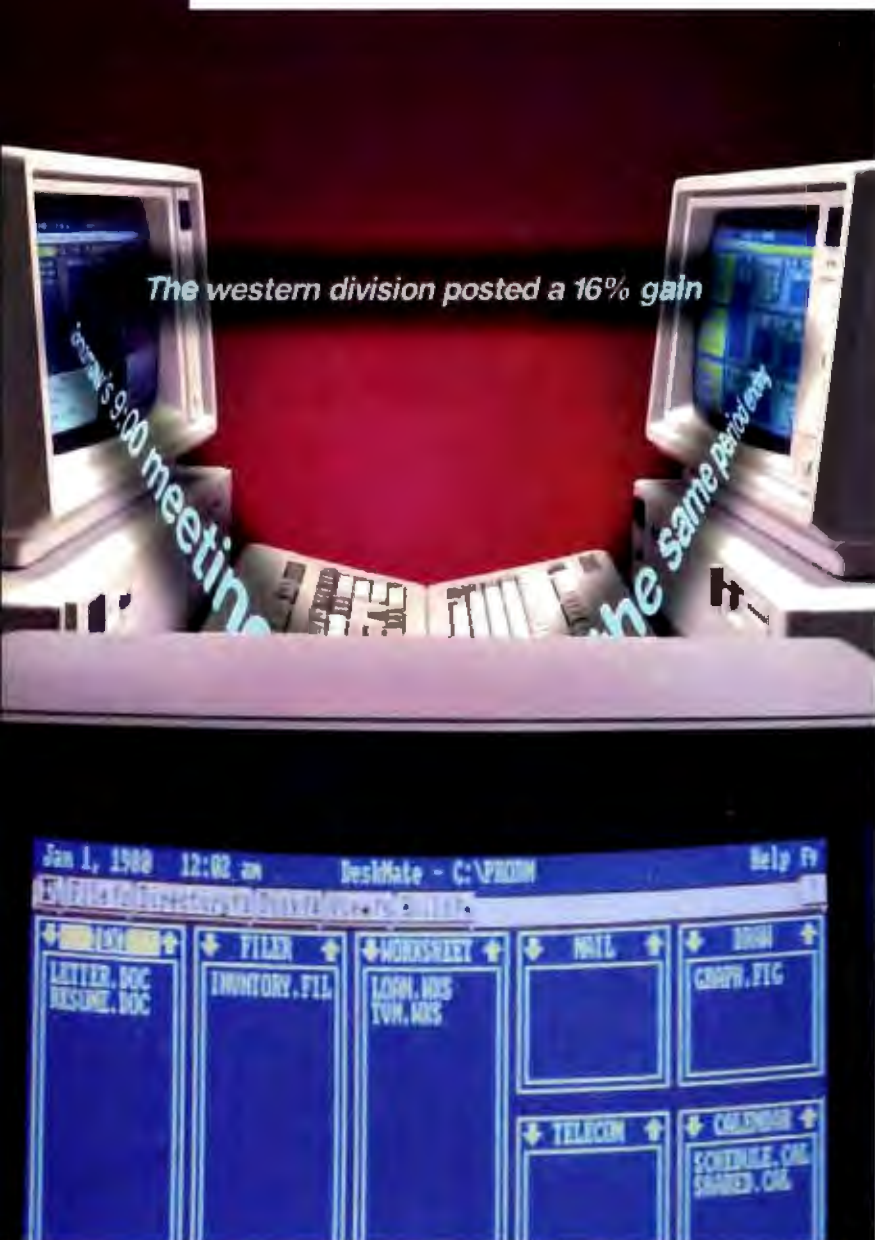

**Now there's a simple,
affordable approach
to PC communications.**

Introducing a workgroup designed specifically for small offices. Professional DeskMate software and TandyLink will give your department an enormous boost in production and efficiency—without a heavy investment.

Professional DeskMate combines the most valuable office applications in an easy-to-use integrated format. You get text processing, spreadsheet analysis, filing, telecommunications and business graphics.



And when you use this program in the TandyLink workgroup, every employee can share information and work together.

Each user can transmit Professional DeskMate files to or from other PCs in the workgroup. Exchange messages. Keep a department phone list. Share appointment calendars and even a printer.

No dedicated file server is needed. A TandyLink workgroup is user installable and operates easily on Tandy and other IBM® PC compatibles. For two stations, all you need is a simple RS-232 connection. For larger workgroups, just add an inexpensive TandyLink card to each computer.

The Professional DeskMate-TandyLink connection turns individual productivity into real teamwork power. Come to a Radio Shack Computer Center today for a demonstration.

Radio Shack[®]
COMPUTER CENTERS

A DIVISION OF TANDY CORPORATION

Circle 224 on Reader Service Card