

# BYTE

SEPTEMBER 1988

A MCGRAW-HILL PUBLICATION

## *New Top-of-the-Line* **Micro Channel Systems** First Impressions of IBM Model 70 and Tandy 5000 MC

### IN DEPTH

## Display Technology

CRT, Gas-Plasma, LCD, EL, and  
TI's New 34020 Chip

### PLUS

Mac 25-MHz Accelerators

Turbo Prolog 2.0

SOTA MotherCard

Choice Words

Konan Disk Controller

### REVIEWS

386s from  
GRID, Toshiba, AST  
PC Fax Boards  
ADA for Mac  
Soft-ICE  
DataPlex  
Total Word

### PRODUCT FOCUS



10 Great  
PostScript Printers



\$3.50 U.S.A./\$4.50 IN CANADA  
0360-5280



# The Critics Agree: Borland's

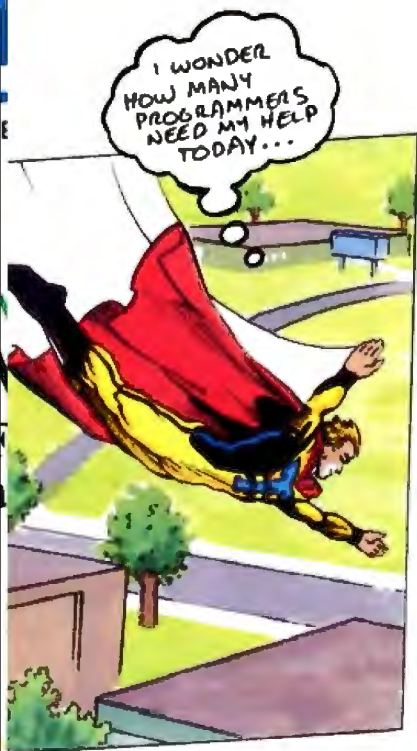

“Turbo C ... will stun you with in-RAM compilations that operate at warp speed.”

—Richard Hale Shaw, *PC Magazine*



Turbo C's\* sleek compiler is so fast and powerful, we used it to write our equation solver, Eureka.™ Even better, all that muscle is wrapped in a smooth,

integrated environment with everything you need to make writing, editing and compiling your programs a snap:

- Compiles 10,000 lines per minute\*
- Online, context-sensitive help
- ANSI compatible
- Six memory models—tiny to huge
- 450 library functions
- Utilities: Librarian, Make, GREP
- Source code for MicroCalc spreadsheet
- Command-line version of the compiler
- Inline assembly that lets you mix C and assembler

- Professional-quality graphics library supporting VGA, CGA, EGA, Hercules, and IBM 8514
  - Interfaces with Turbo Pascal 4.0 and Turbo Prolog
- Just \$99.95**

“A lightning fast, fully featured C compiler suitable for almost everything ... Borland's Turbo C compiler is flexible, fast and friendly.

—Peter Feldman, *PC Week*”

## Heap Sort

	<i>Turbo C 1.5</i>	Microsoft C 5.0
Compile time	4.7 sec.	16.3 sec.
Compile & link time	7.4 sec.	19.5 sec.
Execute time	10.5 sec.	15.5 sec.
Object code size	1119	1313
Execution size	6382	7891

Sort benchmark run on an 8 MHz IBM AT using Turbo C version 1.5 and the Turbo Linker version 1.1, Microsoft C version 5.0 and the MS overlay linker version 3.61

“Turbo Pascal 4.0 flies 4.0 is ballistic!” —Tom Swann



Almost from its introduction, Turbo Pascal\* has been the worldwide Pascal standard. It's fast. It's flexible. It's affordable. And it

gives you full control.

Compile more than 27,000 lines of code per minute\*. And work in a complete, integrated programming environment with pull-down menus and a full-featured editor.

You don't have to swap code in and out to beat the 64K barrier; it's designed for large programs. Break your code into convenient modules and work with them swiftly and separately. If there's an error in one, you can see it and fix it.

**System Requirements** For the IBM PS/2™ and the IBM® family of personal computers and all 100% compatibles. PC-DOS (MS-DOS) 2.0 or later. 384K RAM.

\* Customer satisfaction is our main concern. If within 60 days of purchase this product does not perform in accordance with our claims, call our customer service department, and we will arrange a refund.

**System Requirements** For the IBM PS/2™ and the IBM® family of personal computers and all 100% compatibles. PC-DOS (MS-DOS) 2.0 or later. 384K RAM.

All Borland products are trademarks or registered trademarks of Borland International, Inc. Other brand and product names are trademarks of their respective holders. Copyright © 1989 Borland International, Inc. BI 1230A



# Turbo Languages are Super!



like a rocket ...

"Turbo Basic compiles faster than anything I have seen." —Ethan Winer, PC Magazine

1987 Programmer's Journal

Powerful features include:

- Producing EXE files
- Separate compilation
- Built-in project management
- Graph unit including support for IBM CGA, EGA, VGA, and 3270, Hercules and ATT 6300
- Online, context-sensitive help

\*Run on an 8 MHz IBM PC AT.

Add expertise:

The Turbo Pascal Toolboxes

Start with Turbo Pascal Tutor for just \$69.95 and add the others as your interests and expertise grow:

- Database Toolbox
- Editor Toolbox
- Graphics Toolbox
- Numerical Methods Toolbox
- GameWorks

Toolboxes require Turbo Pascal 4.0

Just \$99.95 each

Each new Turbo Pascal 4.0 Toolbox is a virtual treasure of programming methods and tips.

—Giovanni Perrone, PC Week



Turbo Basic® is the lightning-fast Basic compiler with a total development environment that puts you in full control. Even novices can

write professional programs with Turbo Basic's full-screen windowed editor, pull-down menus, and trace debugging system. You also get a long list of innovative Borland features like binary disk files, true recursion, and increased compilation control. Plus the ability to create programs as large as your system's memory can hold—not just a cramped 64K.

The choice is basic: Turbo Basic!

Just \$99.95!

Turbo Basic, simply put, is an incredibly good product ... Not only is this the most advanced BASIC ever, but Borland has lived up to its Turbo tradition.

—William Zachmann, *Computersworld*

Add another Basic advantage:  
The Turbo Basic Toolboxes

- The Database Toolbox
- The Editor Toolbox

Toolboxes require Turbo Basic 1.1

Just \$99.95 each.

System Requirements for the IBM PS/2™ and the IBM® family of personal computers and all 100% compatibles. PC-DOS (MS-DOS) 2.0 or later. 384K RAM. 640K to compile toolboxes.

## Compare the BASIC differences

	Turbo Basic 1.1	QuickBASIC 4.0 Compiler	QuickBASIC 4.0 Interpreter
Compile & Link to stand-alone EXE	3 sec.	7 sec.	---
Size of .EXE	28387	25980	---
Execution time w/80287	0.16 sec.	16.5 sec.	21.5 sec.
Execution time w/o 80287	0.16 sec.	286.3 sec.	292.3 sec.

The Etkins Optimization Benchmark program from March 1988 issue of Computer Language was used. The Program was run on an IBM PS/2 Model 60 with 80287. The benchmark tests compiler's ability to optimize loop-invariant code, unused code, expression and conditional evaluation.

Circle 30 on Reader Service Card  
(DEALERS: 31)



BORLAND PRESENTS

# THE ADVENTURES OF TURBOMAN

**“Fastest and most approachable  
implementation of that language”**

*—Darryl Rubin, AI Expert, on Turbo Prolog*

**“Most powerful  
version of Basic ever”**

*—Ethan Winer, PC Magazine, on Turbo Basic*

**And able to leap  
onto “new ground in the  
price/performance arena”**

*—John H. Mayer, Computer Design,  
on Turbo C*

See the technological  
excellence of Turbo C,  
Turbo Pascal and  
Turbo Basic!

Meet Turbo Prolog 2.0:  
Artificial Intelligence like  
you've never seen it!



TURBOMAN VISITS SILICON MOTORS, SILICON CITY'S LARGEST MANUFACTURING PLANT...



HELP US TURBOMAN! WE'RE TRYING TO DESIGN A MAPPING SYSTEM INTO OUR NEW CARS, AND WE'RE STUCK!

A PERFECT JOB FOR NEW TURBO PROLOG 2.0 - ITS ARTIFICIAL INTELLIGENCE WILL DO ALL THE HARD WORK FOR YOU!



ANOTHER DAY IN THE LIFE OF TURBO MAN... AND ANOTHER VICTORY FOR TECHNICAL EXCELLENCE AND THE BORLAND WAY!



# Turbo Prolog 2.0: Powerful Artificial Intelligence for your real-world applications!



New Turbo Prolog® 2.0 lets you harness powerful AI techniques. And you don't have to be an expert programmer or artificial intelligence genius!

You get an all-new Prolog compiler that's been optimized to produce smaller and more efficient programs than ever before. An improved full-screen, completely customizable editor with easy pull-down menus. All-new documentation, including a tutorial rich with examples and instructions to take you all the way from basic programming to advanced techniques. Even online help!

System Requirements For the IBM PS/2™ and the IBM® family of personal computers and all 100% compatibles. PC-DOS (MS-DOS) 2.0 or later. 384K RAM

- More new features!**
- An external database system for developing large databases. Supports B+ trees and EMS
  - Source code for a fully-featured Prolog interpreter written entirely in Turbo Prolog. Plus step-by-step instructions to adapt it or include it as is in your own applications!
  - Support for the Borland Graphics Interface, the same professional-quality graphics in Turbo Pascal, Turbo C, and Quattro
  - Improved windowing
  - Powerful exception handling and error trapping features
  - Full compatibility with Turbo C so the two languages can call each other freely
  - Supports multiple internal databases
  - High-resolution video support

**Just \$149.95!**

60-Day Money-back Guarantee †

For the dealer nearest you  
Call (800) 543-7543

Turbo Prolog Toolbox is 6 toolboxes in one!

More than 80 tools and 8,000 lines of source code help you build your own Turbo Prolog applications. Includes toolboxes for menus, screen and report layouts, business graphics, communications, file-transfer capabilities, parser generators, and more!

Toolbox requires Turbo Prolog 2.0  
**Just \$99.95**

“ If I had to pick one single recommendation for people who want to try to keep up with the computer revolution. I'd say, 'Get and learn Turbo Prolog.'

—Jerry Pournelle, *Byte* 1/88

An affordable, fast, and easy-to-use language.

—Darryl Rubin, *AI Expert* 99





# BYTE

SEPTEMBER 1988

VOL. 13/NO. 9

## PRODUCTS IN PERSPECTIVE

- 67 **What's New**
- 89 **Short Takes**  
TSI-020MX and Radius Accelerator 25, two 25-MHz Mac SE accelerator boards  
Turbo Prolog 2.0, adding a number of features  
SOTA MotherCard 5.0 and Microsoft Mach 20, running OS/2 on an IBM PC  
Choice Words, Webster's dictionary on a hard disk drive  
Tentime, Konan's new hard disk drive controller

## FIRST IMPRESSIONS

- 154 **Cover Story:**  
**IBM and Tandy—**  
**Same Channel, Same Plan for Growth**  
by Rich Malloy and Tom Thompson  
IBM's PS/2 Model 70-A21 and Tandy's 5000 MC provide extra computing power in an open design.

## REVIEWS

- 164 **Product Focus:**  
**PostScript Printers Come of Age**  
by Steve Apiki and Stan Diehl  
New printers that are tops in quality and versatility.
- 183 **Two for the Road**  
by Mark L. Van Name  
The Toshiba T5100 and GRiDCase 1530 prove that portable computers have come a long way.
- 195 **An 80386 with a Twist**  
by Jeff Holtzman  
The AST Premium/386 approaches the Compaq 386/20 in power—but not in price.



Cover Story/154



Face to Face/243



Between Man and Machine/288

- 203 **Fax Board Faire**  
by Brock N. Meeks  
A look at the strengths and weaknesses of 10 microcomputer fax cards.
- 213 **Ada Comes to the Mac**  
by Namir Clement Shammass  
Does the Mac make a reasonable development system?
- 219 **Software for Hardware-Style Debugging**  
by Namir Clement Shammass  
Soft-ICE extends breakpoint capabilities and protects against reentrancy.
- 225 **Total Word**  
by Lamont Wood  
Does it offer the total solution for word processing and desktop publishing?
- 231 **Data Entry Goes High-Tech**  
by Lamont Wood  
DataPlex provides data conversion and a "universal front end" for data entry.
- 237 **Review Update**

## IN DEPTH

- 240 **Introduction: Display Technology**
- 243 **Face to Face**  
by Gene Smarte and Nicholas M. Baran  
A look at the four major display technologies—where they are now and where they're going.



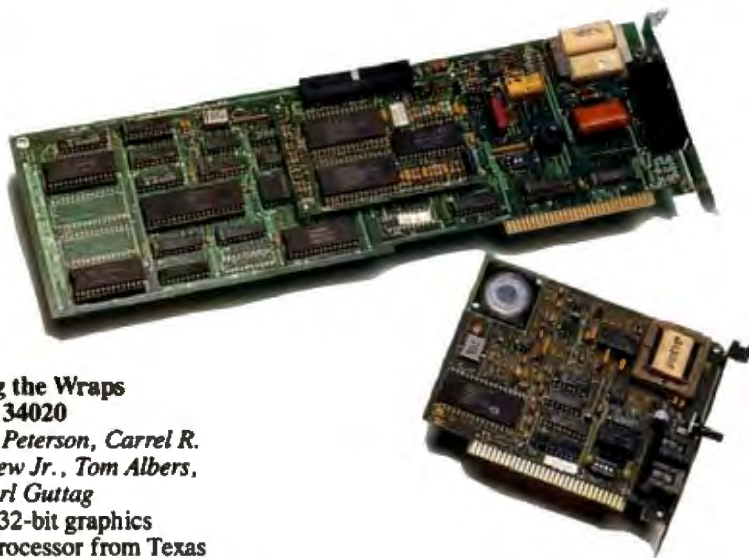

Fax Board Faire/203

**257 Taking the Wraps off the 34020**  
*by Ron Peterson, Carrel R. Killebrew Jr., Tom Albers, and Karl Guttag*  
 A new 32-bit graphics microprocessor from Texas Instruments lets you build a powerful workstation on a small board.

**275 Lighting the Way**  
*by Rolland Von Stroh and Brian Dolinar*  
 Electroluminescence is becoming a heavyweight contender among display technologies.

**282 Monitor Makers**  
 A guide to manufacturers

## FEATURES

**288 Between Man and Machine**  
*by Ernest R. Tello*  
 New advances in user-interface technology could change the way we interact with our computers.

**295 The BASIC Revival**  
*by Namir Clement Shammas*  
 The "beginner's" language has significant new features and a structured approach.

## HANDS ON

**303 Ciarcia's Circuit Cellar: Why Microcontrollers?, Part 2**  
*by Steve Ciarcia*  
 The DDT-51 is a low-cost software development system with many features of more expensive systems.

**313 Some Assembly Required: Floating-Point without a Coprocessor**  
*by Rick Grehan*  
 High-precision floating-point emulation for your personal computer.

## EXPERT ADVICE

**103 Computing at Chaos Manor: The Edge of the Envelope**  
*by Jerry Pournelle*  
 Jerry combines his right stuff with the right hardware and the right software.

**123 Applications Plus: A Wolf and a Killer Shark**  
*by Ezra Shapiro*  
 The wolf is Word 3.01; the killer shark is FullWrite Professional.

**129 Down to Business: Is More Always Better?**  
*by Wayne Rash Jr.*  
 Too often, companies make installations on the basis of comfort rather than functionality.

**135 Macinations: Comebacks, Backups, and Updates**  
*by Don Crabb*  
 Some Mac software is born great, some is made great, and some is merely updated.

**143 OS/2 Notebook: All Together Now**  
*by Mark Minasi*  
 Under OS/2, your programs don't step all over each other.

**147 COM1: Computer Conferencing Homecoming**  
*by Brock N. Meeks*  
 Although computer conferencing is still in its infancy, it's locked into a niche market.

## DEPARTMENTS

- 6 Editorial: Mac Clones and OS/2 Trends
- 11 Microbytes
- 24 Letters
- 33 Chaos Manor Mail
- 38 Ask BYTE
- 51 Book Reviews
- 359 Coming Up in BYTE

## READER SERVICE

- 358 Editorial Index by Company
- 360 Alphabetical Index to Advertisers
- 362 Index to Advertisers by Product Category
- Inquiry Reply Cards: after 364

## PROGRAM LISTINGS

From BIX: see 286  
 From BYTEnet:  
 call (617) 861-9764  
 On disk or in print:  
 see card after 320

BYTE (ISSN 0360-5200) is published monthly with an additional issue in October by McGraw-Hill Inc. Founder: James H. McGraw (1860-1948). Executive, editorial, circulation, and advertising offices: One Phoenix Hill Lane, Pennington, NJ 03458, phone (603) 924-9211. Office hours: Monday through Thursday 8:30 AM-4:30 PM, Friday 8:30 AM-1:00 PM, Eastern Time. Address subscriptions to BYTE Subscriptions, P.O. Box 7643, Teaneck, NJ 07666-9866. Postmaster: Send address changes, USPS Form 3579, undeliverable copies, and fulfillment questions to BYTE Subscriptions, P.O. Box 7643, Teaneck, NJ 07666-9866. Second-class postage paid at Pennington, NJ 03458 and additional mailing offices. Postage paid at Winnipeg, Manitoba. Registration number 9321. Subscriptions are \$22.95 for one year, \$39.95 for two years, and \$55.95 for three years in the U.S. and its possessions. In Canada and Mexico, \$25.95 for one year, \$45.95 for two years, \$64.95 for three years. \$75 for one-year air delivery to Europe. ¥28,800 for one-year air delivery to Japan, ¥14,400 for one-year surface delivery to Japan, \$40 surface delivery elsewhere. Air delivery to selected areas at additional rates upon request. Single copy price is \$3.50 in the U.S. and its possessions, \$3.95 in Canada, \$4.50 in Europe, and \$5 elsewhere. Foreign subscriptions and sales should be remitted in U.S. funds drawn on a U.S. bank. Please allow six to eight weeks for delivery of first issue. Printed in the United States of America.

Address editorial correspondence to: Editor, BYTE, One Phoenix Hill Lane, Pennington, NJ 03458. Unacceptable manuscripts will be returned if accompanied by sufficient postage. Not responsible for lost manuscripts or photos. Opinions expressed by the authors are not necessarily those of BYTE.

Copyright © 1988 by McGraw-Hill Inc. All rights reserved. Trademark registered in the United States Patent and Trademark Office. Where necessary, permission is granted by the copyright owner for libraries and others registered with the Copyright Clearance Center (CCC) to photocopy any article herein for the flat fee of \$1.50 per copy of the article or any part thereof. Correspondence and payments should be sent directly to the CCC, 29 Congress St., Salem, MA 01970. Specify ISSN 0360-5200/88, \$1.50. Copying done for other than personal or internal reference use without the permission of McGraw-Hill Inc. is prohibited. Requests for special permission or bulk orders should be addressed to the publisher. BYTE is available in microform from University Microfilms International, 300 North Zeeb Rd., Dept. FR, Ann Arbor, MI 48106 or 18 Bedford Row, Dept. FR, London WC1R 4EJ, England.

Subscription questions or problems should be addressed to: BYTE Subscriber Service, P.O. Box 7643, Teaneck, NJ 07666-9866.





# BYTE

**EDITOR IN CHIEF**  
Frederic S. Langa

**PUBLISHER/GROUP VICE PRESIDENT**  
J. Burt Totaro

**OPERATIONS**  
Glenn Hartwig Associate Managing Editor

**REVIEWS (Hardware, Software, Product Focus)**  
Cathryn Baskin Associate Managing Editor, Dennis Allen Senior Technical Editor, Software, Curtis Franklin Jr. Senior Testing Editor, BYTE Lab, Stephen Apiki Testing Editor, BYTE Lab, Stanford Delti Testing Editor, BYTE Lab

**NEWS AND TECHNOLOGY (Microbytes, What's New, Short Takes)**  
Rich Malloy Associate Managing Editor, D. Barker Senior Editor, News and Technology, Anne Fischer Lert Senior Editor, News Products

**Peterborough:** Roger Adams Associate News Editor, David Andrews Associate News Editor, Martha Hicks Associate News Editor  
**West Coast:** Gene Smarte Bureau Chief, Costa Mesa, Nicholas Baran Technical Editor, San Francisco, Frank Hayee, Associate News Editor, Jeffrey Bertolucci Editorial Assistant, San Francisco

**SENIOR TECHNICAL EDITORS**  
Ken Sheldon Features, Jane Morrill Tazelaar In Depth, Richard Grehan At Large, Tom Thompson At Large

**TECHNICAL EDITORS**  
Janet J. Barron, Janet Fiderio, Jon Udell, Stanley Wozola

**ASSOCIATE TECHNICAL EDITOR**  
Robert Mitchell

**CONSULTING EDITORS**  
Steve Garcia, Jerry Pournelle, Ezra Shapiro, Don Crabb, Brock N. Meeks, Mark Minasi, Wayne Rash Jr.

**CONTRIBUTING EDITORS**  
Jonathan Amsterdam Programming Projects, Mark Dahms Video, Operating Systems, Mark Hase At Large, Rik Jadnick CAD, Graphics, Spreadsheets, Robert T. Kurotska Mathematical Recreations, Alastair J. W. Mayer Software, Stan Miaszkowski New Technology, Alan R. Miller Languages and Engineering, Dick Pountain Algorithms, Roger Powell Computers and Music, Phillip Robinson Semiconductors, Jon Shiell High-Performance Systems, Ernest Tello Artificial Intelligence

**COPY EDITORS**  
Lauren Sticker Chief, Susan Colwell, Judy Connors-Tenney, Jeff Edmonds, Nancy Hayee, Cadry Kingery, Margaret A. Richard, Warren Williamson

**EDITORIAL ASSISTANTS**  
Peggy Dunham Office Manager, Linda C. Ryan, June N. Sheldon, Lynn Susan Valley

**ART**  
Nancy Rice Director, Joseph A. Gallagher Assistant Director, Jan Muller Assistant, Alan Easton Technical Artist

**PRODUCTION**  
David R. Anderson Director, Virginia Reardon Senior Editorial Production Coordinator, Denise Chartrand Editorial Production Coordinator, Michael J. Lonaky Editorial Production Coordinator

**TYPOGRAPHY**  
Sherry Fleete Systems Manager, Donna Sweeney Applications Manager, Christa Patterson

**ADVERTISING/PRODUCTION (603) 924-8448**  
Lisa Wozniak Director, Lyde Clark Senior Account Coordinator, Karen Cillay, Linda Fluhr, Jeanne Gatoombe, Brian Higgins, Rod Holden, Wai Chiu Li Quality Control Manager, Julie Murphree Advertising/Production Coordinator

**MARKETING COMMUNICATIONS**  
Horace T. Howland Director, Pamela Petrakos-Wilson Promotion Manager, Wilbur S. Watson Marketing Services Manager, Dawn Matthews Marketing Events Coordinator, Lisa Jo Steiner Marketing Assistant, Stephanie Wameaky Marketing Art Director, Sharon Price Associate Art Director, Julie Perron Market Research Analyst

**PLANNING AND RESEARCH**  
Michele Perron Director  
Faith Kluntz Copyrights Coordinator, Cynthia Damato Senda Reader Service Coordinator

**FINANCIAL SERVICES**  
Philip L. Penny Director of Finance and Services, Kenneth A. King Business Manager, Christine Monkton Assistant, Marilyn Halgh, Diane Henry, JoAnn Walter, Jaime Huber

**CIRCULATION**  
Dan McLaughlin Director  
James Bingham Newsstand Sales Manager, Vicki Weston Assistant Manager, Karen Desroches Distribution Coordinator, Donna Healy, Direct Accounts Coordinator, Louise Menegus Back Issues

**PERSONNEL**  
Patricia Burke Personnel Coordinator, Beverly Goss Receptionist

**BUILDING SERVICES**  
Tony Barnett Manager, Cliff Monkton, Mark Monkton, Agnes Perry

## **BIX** BYTE INFORMATION EXCHANGE

**DIRECTOR**  
Stephen M. Laliberte

**EXECUTIVE EDITOR**  
George Bond

**ASSOCIATE EDITOR**  
Tony Lockwood

**MICROBYTES DAILY**  
D. Barker Coordinator, Peterborough, Rich Malloy New York, Gene Smarte Costa Mesa, Nicholas Baran San Francisco, Rick Cook Phoenix, Frank Hayee San Francisco, Jason Levitt Austin, TX, Larry Loeb Wallingford, CT, Brock N. Meeks La Mesa, CA, Stan Miaszkowski Peterborough, Wayne Rash Jr., Sue Rosenberg Washington, DC, David Reed Lexington, KY

**GROUP MODERATORS**  
David Allen Applications, Frank Boosman Artificial Intelligence, Larry Casterline Other, Marc Greenfield Programming Languages, Jim Howard Graphics, Gary Kendall Operating Systems, Steve Krenak Computers, Brock N. Meeks Telecommunications, Barry Nance New Technology, Donald Osgood Computers, Sue Rosenberg Other, Jon Swanson Chips

**BUSINESS AND MARKETING**  
Doug Webster Director (603) 924-9027, Patricia Baumann Secretary, Denise A. Greene Customer Service, Brian Wernock Customer Service, Timmy Burgess Customer Credit and Billing

**TECHNOLOGY**  
Clayton Lisle Director, Business Systems Technology, MHIS, Bill Garrison Senior Business Systems Analyst, Jack Reilly Senior Business Systems Analyst, Bob Dornbia Business Systems Analyst, Fred Strauss Senior Business Systems Analyst

**ADVERTISING SALES**  
Dennis J. Riley Director, (603) 924-8281  
Sandra Foster Administrative Assistant

**NEW ENGLAND**  
ME, NH, VT, MA, RI, ONTARIO, CANADA & EASTERN CANADA  
John C. Moon (617) 262-1180

**ATLANTIC**  
NY, NJ, CT, NJ (NORTH)  
Leah G. Rabinowitz (212) 612-2000  
(203) 968-7111

**EAST**  
PA, KY, NJ (SOUTH), MD, VA, W. VA, DE, DC  
(215) 484-3833

**SOUTHEAST**  
NC, SC, GA, FL, AL, TN  
(404) 282-9828

Jennifer L. Barne West Coast Sales Manager, (214) 844-1111

**MIDWEST**  
IL, MO, KS, IA, ND, SD, MN, WI, NE, IN, MI, MS, OH  
Bob Denmead (313) 751-3740

**SOUTHWEST, ROCKY MOUNTAIN**  
CO, WY, OK, TX, AR, LA  
Karl Heinrich (713) 482-0787

**SOUTH PACIFIC**  
SOUTHERN CA, AZ, NM, LAS VEGAS  
Jack Anderson (714) 687-8292  
Tom Harvey (213) 486-8243

**NORTH PACIFIC**  
HI, WA, OR, ID, MT, NORTHERN CA, NV (except LAS VEGAS), UT, WESTERN CANADA  
Mike Kiseberth (415) 382-8808  
Bill McAfee (415) 340-4188

**TELEMARKETING**  
L. Bradley Browne Director  
Susan Boyd Administrative Assistant

**BYTE BITS (2x3)**  
Dan Harper (603) 924-8838

**THE BUYER'S MART (1x2)**  
Mark Stone (603) 924-3754

**REGIONAL ADVERTISING SECTIONS**  
MID-ATLANTIC, METRO NY & NEW ENGLAND, SOUTHERN CALIFORNIA  
Elisa Lister (603) 924-8838

**MIDWEST, PACIFIC NORTHWEST, METRO NY & NEW ENGLAND**  
Scott Gagnon (603) 924-8838

**SOUTHEAST, SOUTHWEST**  
Denise Verrier (603) 924-8281

**BYTE DECK MAILINGS**  
National  
Ed Ware (603) 924-4188

**A/E/C COMPUTING DECK**  
COMPUTING FOR ENGINEERS DECK  
Mary Ann Goulding (603) 924-8281

**INTERNATIONAL ADVERTISING SALES STAFF**  
See listing on page 381.

**EDITORIAL AND BUSINESS OFFICE:**  
One Phoenix Mill Lane, Peterborough, NH 03458, (603) 924-9281.  
West Coast Branch Office: 425 Battery St., San Francisco, CA 94111, (415) 954-9718; 3001 Red Hill Ave., Building #1, Suite 222, Costa Mesa, CA 92626, (714) 567-8292.  
New York Branch Editorial Office: 1221 Avenue of the Americas, New York, NY 10020, (212) 512-3175.  
BYTEline: (617) 981-9764 (not modern at 9-11-N or 7-1-E; 300 or 1200 baud). Fax: (603) 924-7507. Telex: (603) 924-7861.  
SUBSCRIPTION CUSTOMER SERVICE: Non-U.S. (201) 837-1315; inside U.S. (outside NJ) 1-800-423-8272; (inside NJ) 1-800-367-0218.

Officers of McGraw-Hill Information Services Company: President: Walter D. Serwatski, Executive Vice Presidents: Kenneth E. Gazzola, Aerospace and Defense; Its Herenstein, Computers and Communications; Russell C. White, Construction; Robert F. McGraw, Healthcare; Brian H. Hall, Legal; Senior Vice Presidents-Publishers: Laurence Altman, Data Communications; David J. McGrath, Engineering News-Record; Senior Vice Presidents: Robert D. Daleo, Finance; Michael J. Koeller, Human Resources; Group Vice Presidents: J. Burt Totaro, BYTE, Norbert Schumacher, Energy/Process Industries; Vice Presidents: George Blinger, Circulation; Julie Leonard, Systems Planning and Technology.

Officers of McGraw-Hill Inc.: Joseph L. Donno, Chairman and Chief Executive Officer; Robert N. Landes, Executive Vice President, General Counsel, and Secretary; Robert J. Behash, Executive Vice President and Chief Financial Officer; Shel F. Aasn, Senior Vice President, Manufacturing; Frank D. Pongrace, Senior Vice President, Treasury Operations; Ralph R. Schutz, Senior Vice President, Editorial.

BYTE and BITE are registered trademarks of McGraw-Hill Inc.



# smARTWORK® Keeps Getting Smarter

**NEW**

**Autorouter Included  
Still \$895**

## Smarter Artwork

Three years ago, Wintek engineers created smARTWORK to reduce the time and tedium of laying out their own printed-circuit boards. Thousands of engineers have since discovered the ease of use and sophistication that makes smARTWORK the most popular PCB CAD software available. And thanks to them, smARTWORK keeps getting better.



smARTWORK transforms your IBM PC into a PCB CAD system

Interactive routing, continual design-rule checking, pad shaving, and production-quality 2X artwork have always been a part of smARTWORK. And now that many customer suggestions have become a part of the software, smARTWORK is an even better value. *That's why we offer it with a thirty-day money-back no-nonsense guarantee.*

Using an Epson or IBM dot-matrix printer, you can create 2X artwork and 1X or 2X checkplots in a fraction of the time hand-taping requires

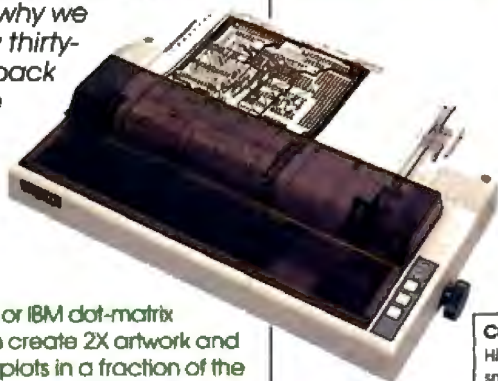

## New smARTWORK Features

- Silkscreen layer for component placement and identification
- Text capabilities for all three layers
- Selectable trace widths and pad shapes and sizes
- User-definable library
- Ground planes created with a single command
- Solder-mask and padmaster plots generated automatically
- Quick printer 2X checkplots
- Additional drivers for printers and plotters
  - Optional drill-tape and Gerber photoplotter utilities
  - AutoCAD® .DXF file output
  - Completely updated manual
  - 800 number for free technical assistance

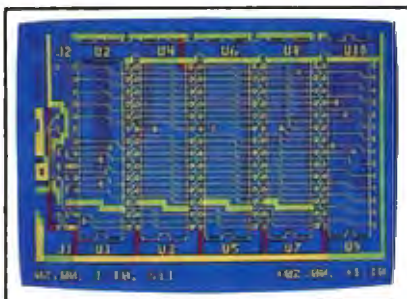

2" by 4" section of a 10" by 16" double-sided board with silkscreen layer

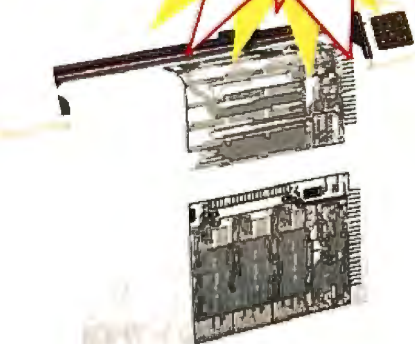

Camera-ready 2X artwork from an HI or HP pen plotter

## The Smart Buy. Guaranteed.

Still priced at \$895, smARTWORK is proven, convenient, and fast. Our money-back guarantee lets you try smARTWORK for 30 days at absolutely no risk. Call toll free (800) 742-6809 today and put smARTWORK to work for you tomorrow. That's smart work.

## System Requirements

- IBM PC, PC XT, or PC AT with 384K RAM, and DOS V2.0 or later
- IBM Color/Graphics Adapter with RGB color or B&W monitor
- IBM Graphics Printer or Epson FX/MX/RX-series printer, and/or
- Houston Instrument DMP-40, 41, 42, 51, 52, or Hewlett-Packard 7470, 7475, 7550, 7580, 7585, 7586 pen plotter
- Optional Microsoft Mouse

Wintek Corporation  
1801 South St.  
Lafayette, IN 47904  
Telephone: (800) 742-6809  
In Indiana: (317) 742-8428  
Telex: 70-9079 WINTEK CORP UD



smARTWORK®, Wintek®, and the Wintek logo are registered trademarks of Wintek Corporation. AutoCAD® is a registered trademark of Autodesk, Inc.

Current Versions	
HWIRE	V1 1r1
smARTWORK	V1 3r5



# MAC CLONES AND OS/2 TRENDS

The "Happy Joiner" Mac is up and running; and some early OS/2 users voice surprising opinions

**A**t this year's Hannover Faire in Europe (the world's largest computer show), we got a sneak peek at a Taiwanese Macintosh clone. This summer, at Taiwan's Computex show, the clone was openly displayed, and it attracted crowds.

The clone is not for sale—yet. In fact, the prototype Mac knockoff was built primarily as a demonstration device for Mac-compatible gate-array chip sets—chips built in the U.S. by an unnamed manufacturer.

The story gets murky here. According to the generally reliable *AsiaTrends* newsletter, the company displaying the clone—its name translates as Happy Joiner Co., Ltd.—did as its name implies by acting as an intermediary between an offshore chip-design house and the U.S. manufacturer.

"Our gate array doesn't violate any existing copyrights," said a company spokesperson. "In fact, there is no copyright on gate arrays."

By themselves, the chips are at most only the foundation of a complete Mac clone; for example, you'd still need a legal ROM (a major stumbling block, considering Apple's recent litigiousness). *AsiaTrends* quotes the spokesperson as saying, "We met many people at the show who were very interested, including major Australian and Taiwanese software houses. The people we talked to

said they were very interested in writing a functionally compatible legal [ROM] BIOS."

Although the gate arrays are made in the U.S., Happy Joiner has no plans to sell them here. Instead, it plans to work with clone makers in Hong Kong, South Korea, and Singapore to produce finished machines that *would* be sold in North America and elsewhere.

While I am sympathetic to Apple's desire to maintain control of its market, I'd also welcome a legitimate, inexpensive Macintosh—one that would do for the Apple side of the market what the low-cost IBM PC clones did for Intel-family machines: expand the user base, and spur vigorous growth in third-party hardware and software development.

The best kind of low-cost Mac would be one with an authentic Apple logo on it. Apple surely could produce such a machine: I've seen estimates that place Apple's manufacturing costs for a hard disk drive-equipped Mac SE as low as about \$500. (The list price for such a machine is about \$3600.) Yes, Apple has a healthy R&D budget, and both Apple and its dealers deserve fair profits, but surely these prices could come down some.

If it chose to, Apple could employ the strategy once used successfully by General Motors in offering a family of products ranging from Chevys to Cadillacs—from some kind of a true entry-level, lowball Mac up to Mac IIs, and beyond.

If Mac prices stay high, we may see a strange new kind of machine: a Mac-like box with American chips, an Australian ROM, a Hong Kong motherboard, and a brand name that's something like Happy Joiner.

## OS/2 Trends

Datapro, one of BYTE's computer-oriented siblings within McGraw-Hill, recently completed a survey of early purchasers of the OS/2 Software Developer's Kit (SDK). The survey results make for fascinating reading.

The survey culled out software developers and hardware companies in order to target the heavy-hitting end users—nondevelopers who were interested enough in OS/2 to shell out the \$3000 for the SDK.

One surprise was the glacial pace these earliest adopters predicted OS/2 would take in becoming the operating system of choice for Intel-based machines. Many believe it will be well into 1989 or even 1990 before significant OS/2 applications are available: Unlike some industry gurus, these end users don't believe there will be an end-of-the-year blitz of OS/2 software this year.

A full third of the respondents see Unix as a serious alternative to OS/2. But Unix has its own perception problems. One participant said, "If Unix gets onto a commodity hardware platform so the end user can go down to the corner store or mail-order house and get [Unix] software, then Unix may make it in the end-user environment... But if that doesn't happen, then OS/2 is going to wipe it out..."

OS/2's major strengths were seen to be its screen-handling ability (assuming Presentation Manager lives up to its claims) and—strangely—its DOS compatibility. Vaunted features like Dynamic Data Exchange and the LAN Manager were cited far less frequently. The respondents saw OS/2's major weaknesses as stemming not so much from OS/2 itself, but from its timing: Lack of applications and delays in release were the two most-cited negatives.

All in all, the report is an eye-opening glimpse into the real world of OS/2 users. (Individual copies of "An Inside View of OS/2" at \$695 can be ordered through Datapro, 1805 Underwood Blvd., Delran, NJ 08075.)

—Fred Langa  
Editor in Chief  
(BIX name "flanga")



And then...  
Maxell created  
the RD Series.



The  
Evolution  
of the  
Floppy Disk

Maxell Corporation of America, 22-08 Route 208, Fair Lawn, NJ 07410

Never before has this level of Reliability  
and Durability been available in floppy disks.  
Introducing the new RD Series from Maxell.  
Twice the durability of the disks you're now using.  
Twice the resistance to dust and dirt.  
And the RD Series is ten times more reliable  
than conventional floppy disks.  
The Gold Standard has always meant maximum  
safety for your data. Now it means even more.



**maxell**  
THE GOLD STANDARD



“The ALR  
20MHz  
FlexCache 20386  
proves  
that you don't have  
to be based in  
Texas to build the  
world's fastest  
PCs.”

**PCWEEK**

March 29,  
1988

400%  
annual  
growth  
since  
1984

**PC**  
MAGAZINE

“ALR has come out of  
nowhere over the last two years to  
earn a spot in the sun among  
important PC-compatible makers.”  
- Jim Seymour January 12, 1988



Welcome to  
California, the  
zero wait  
state.

In July of '86 Advanced  
Logic Research was the world's  
first manufacturer to release an  
80386 based PC, adding to a long  
list of California firsts.

Today at ALR, we manufacture the  
world's fastest PCs. Industry peers  
have recognized the FlexCache 386  
series as the ultimate  
tool for the most  
demanding business  
applications in net-  
work, multi-user and  
CAD/CAM environments.



“The ALR FlexCache 20386 will  
make a name for itself as a heavy-duty  
file server. ...the FlexCache is  
destined for success.”

**PC**  
MAGAZINE

excerpts from  
Editors Choice  
June 28, 1988

The ALR FlexCache 20386 Model  
150 achieved a rating of 19.7 in  
Byte Lab. “Tops in price and  
performance”



Byte June, 1988

“The performance they achieve sets a  
new standard for PCs.”

**PCResource** June, 1988

“Well, for once the answer isn't to  
run right out and get your hands on a  
Compaq Deskpro 386/20.~ Rather,  
it's to get your hands on an ALR  
FlexCache 20386.”

First Looks  
March 15, 1988



“... the FlexCache 20386 yields the  
highest number of MIPS (million  
instructions per second) per dollar.”

**TECH** JOURNAL June, 1988

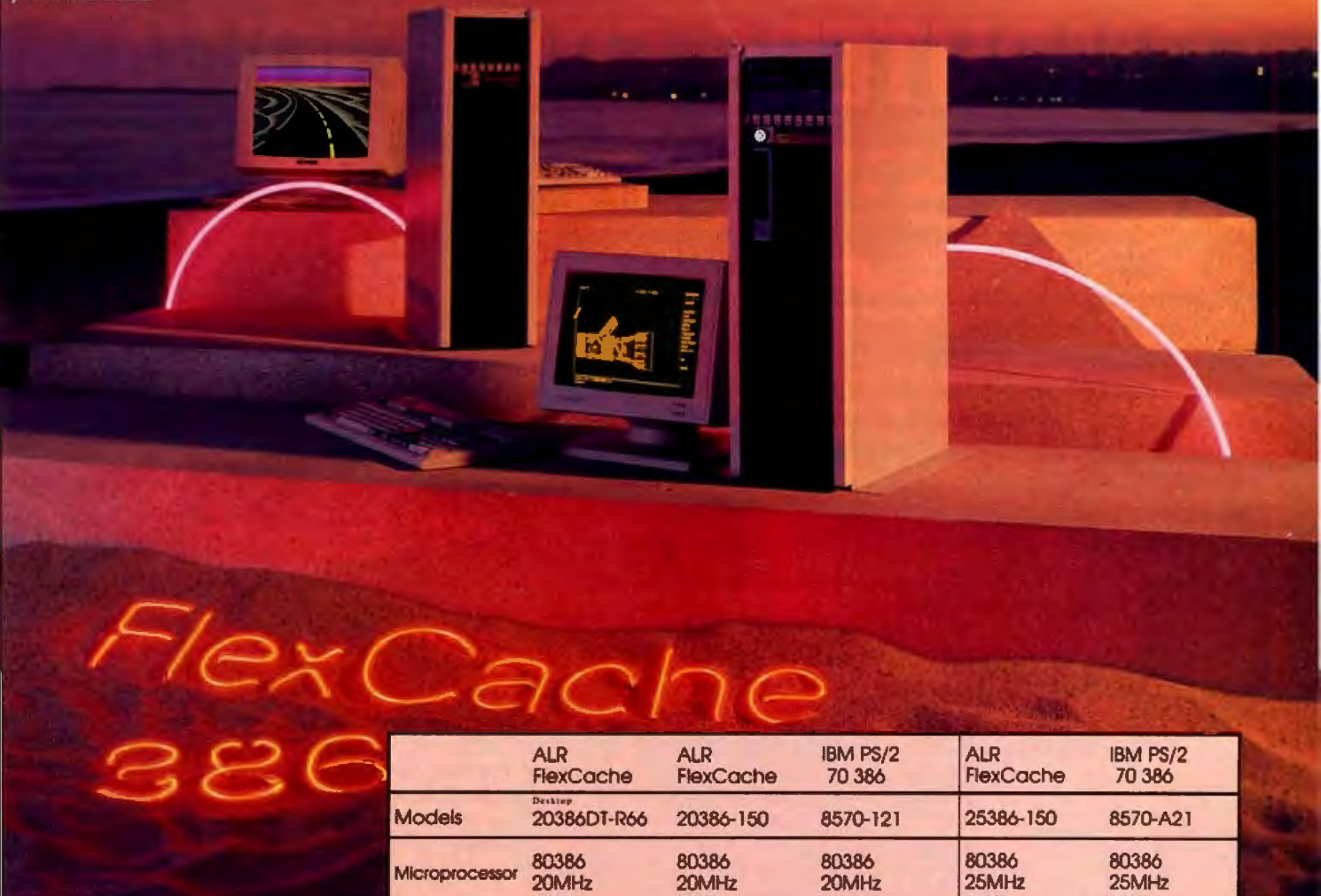

# FlexCache 386

## Redefining PC Speed

Although we can't go any further west, ALR is claiming new frontiers in PC performance and processing speeds. Now, fast is even faster. The ALR FlexCache 25386 breaks every current speed record. Our proprietary 64Kbyte *Extended Emulation* 82385 is the key to 25386 Cache speed.

**25 MHz**

PC performance is redefined.

	ALR FlexCache	ALR FlexCache	IBM PS/2 70 386	ALR FlexCache	IBM PS/2 70 386
Models	20386DT-R66	20386-150	8570-121	25386-150	8570-A21
Microprocessor	80386 20MHz 32KB, 82385 Memory Cache (35ns)	80386 20MHz 32KB, 82385 Memory Cache (35ns)	80386 20MHz 0-2 wait-	80386 25MHz 64KB Extended Emulation 82385 Memory Cache (25ns)	80386 25MHz 64KB Memory Cache (30ns)
Bench Mark <small>Data Base Power Meter Ver. 1.2</small>	<b>4.71 Mips</b>	<b>4.71 Mips</b>	<b>3.53 Mips</b>	<b>6.09 Mips</b>	<b>5.74 Mips</b>
Optional Math CoProcessor	80387 20MHz	80387 20MHz	80387 20MHz	80387 25MHz	80387 25MHz
Memory (RAM)	1MB (80ns)	2MB (80ns)	2MB (85ns)	2MB (60ns)	2MB (80ns)
Storage	1.2MB, 5 1/4" FD 1.44MB, 3 1/2" FD	1 Optional (\$225.00)	Not Available 1	1 Optional (\$225.00)	Not Available 1
Fixed Disk std. Opt. Internal Full Height Fixed Disk	66MB (28ms) 66MB or 100MB	150MB (18ms) 150MB or 300MB	120MB (23ms) No Support	150MB (18ms) 150MB or 300MB	120MB (23ms) No Support
Video	Optional 16 bit VGA (\$339.00)	Optional 16 bit VGA (\$339.00)	VGA	16 bit VGA	VGA
Price	\$4590.00*	\$7490.00*	\$7995.00*	\$9499.00*	\$11,295.00*

\* Prices and configurations as of June 1988 and subject to change.

Now that things are get'n kind'a slow in Texas...

...go West young man.

Call ALR for the world's fastest PCs, under the California Sun.

**1-800-444-4ALR**



**Advanced Logic Research, Inc.**  
9401 Jeronimo, Irvine, CA 92718  
Phone: 714-581-6770 FAX: 714-581-9240  
Telex: 510-601-4525  
Answer back Advanced Logic

Circle 9 on Reader Service Card  
(DEALERS: 10)



# COMPUTERS FROM IOWA?

Gateway 2000 is centrally located in order to efficiently serve the entire country. We are honest, hard working, well educated people, committed to succeeding and growing in the highly competitive micro-computer market.

Gateway 2000 is a full-service and support organization that realizes the key to our success lies in a satisfied customer base.

One look at the configuration we have listed below and you will see that we have high quality equipment at an incredible price. We have many different configurations available, so call one of our knowledgeable sales people, if you have any questions.

We look forward to doing business with you, and establishing a long term business relationship.



## 16 Mhz 286 EGA SYSTEM

80286-16 Processor  
1 Meg 80NS Ram  
1.2 Meg Floppy  
1.44 Meg Diskette Drive  
40 Meg Seagate ST251  
Samsung EGA Monitor w/Card  
2-Parallel/2-Serial Ports  
101 Key Enhanced Keyboard  
DOS 3.3 w/GWBasic  
1 Year Warranty  
30 Day Money Back Guarantee

**\$2295.00**

## 20 Mhz 386 VGA SYSTEM

80386 Processor Running at 20MHZ  
1 Meg 60 NS Ram (Expandable to 8 Megs)  
1.2 Meg Floppy Drive  
1.44 Meg Diskette Drive  
80 Meg Seagate ST4096 (28MS)  
WD 1006 Controller (1 to 1 Interleave)  
Samsung Multisynch Monitor w/VGA Board  
VGA/EGA/CGA/MDA/Hercules and 800x600 Modes  
2-Parallel/2-Serial Ports  
101 Key Enhanced Keyboard  
Tower Case w/275 Watt Power Supply  
80287 and 80387 Sockets  
DOS 3.3 w/GWBasic  
1 Year Warranty  
30 Day Money Back Guarantee

**\$3995.00**



Gateway 2000 • P.O. Box 2414 • Sioux City, IA 51107

**800-233-8472/712-255-7899**

Due to the volatility in the DRAM market, all prices are subject to change.



# MICROBYTES

*Staff-written highlights of developments  
in technology and the microcomputer industry*

## Study of Coordination Leads to New Groupware

Coordination is one of those things that you don't notice until it's not there. But Anatol Holt has noticed it; in fact, he's developed a new technology around it. Holt, who has worked at places such as Remington Rand and Boston University, developed a science called coordination mechanics. And next year, Holt's company, Coordination Technology, Inc. (Trumbull, CT), will release a computer implementation of coordination mechanics. The company claims that the new product will help groups of people on networked personal computers work together more effectively. And many routine tasks that have steadfastly resisted being computerized will soon be more efficiently done on a PC, CTI officials say.

The CTI product works

by assigning each person to a number of groups. Each person then interacts with the other people in the group according to pairs of coordination patterns. For example, one person might be a requester, the other a responder. Other possible pairs are submitter/approver and provider/consumer. Any personal relationship can be represented by combining coordination-pattern pairs.

Once the relationships have been established, the program can guide and monitor the electronic mail communication between the members of the group. If you request a piece of information from someone else, the product will continue to remind that person to provide the information and will remind you that it has not been provided. Or if you submit an E-mail proposal to your

boss, and your boss in turn submits it to his or her boss, the CTI product will keep you up to date on the status of the proposal.

The product, which does not yet have a name or a price, will not be available until August of next year, a CTI spokesperson said. It will run under IBM's OS/2 Extended Edition or Microsoft's OS/2 and LAN Manager. According to CTI, the product will function as an environment and will be compatible with application software such as Lotus 1-2-3. A prototype version of CTI's program currently runs under DOS, but the company says it wants to wait until OS/2's Presentation Manager is available. CTI also says that OS/2's memory management techniques will considerably speed up the product, which currently is somewhat slow.

## Ansa Develops Cooperative Processing Model with Paradox

One of the promising features of local-area networks (LANs) is the possibility of cooperative processing, with CPUs on the network sharing the processing tasks and "balancing the load" on the system. This is particularly useful in networked database applications that require compute-intensive tasks such as sorts, queries, and preparation of reports. Ideally, if a single workstation on the network is overloaded with tasks, it should be able to send some of its tasks to nodes that are less utilized.

Borland's Ansa Software division (Belmont, CA) has written an application in the

Paradox PAL programming language, running under OS/2, that allows cooperative processing in Paradox. In a demonstration for BYTE, Paradox OS/2 was running on a beta version of 3Com's 3+ network. The PAL application controlling the cooperative processing uses a standard Paradox table that tracks the sessions running on each workstation of the network. As more sessions are activated (another report or sort operation, for example), the PAL application uses an algorithm to decide which workstation should execute the session, depending on current workloads. The PAL application is

made possible by the new SESSION command in the OS/2 version of Paradox, which performs the function of the OS/2 task selector in PAL scripts.

The cooperative processing application represents an "architectural concept" that software developers can use in their Paradox applications, said Borland's Richard Schwartz. Borland will make the application available to Paradox developers, he said. The application is a good example of the potential of multitasking capabilities combined with LANs for increasing the efficiency of CPUs on the system.

*continued*

### NANOBYTES

- We'd like to see more of this modesty in our industry. At a Sony Microsystems (Palo Alto, CA) press conference announcing a twin-68030 Unix-running workstation, company president Mas Morimoto said it would be inappropriate for Sony to take sides in the current AT&T/Open Software Foundation fight over control of Unix standardization. "In this market, Sony cannot create a standard—we follow the standard. Sony is not that big an influence," he said.

- At the same press conference, Murray Goldman of Motorola confirmed that Motorola will be producing a 68040 processor, but he refused to comment on a time frame or specific features of the chip.

- Matsushita (Secaucus, NJ) says it has developed a digital optical disk recording system that can put 2.6 gigabytes of information on each side of a 12-inch write-once optical platter. The system has a read and write speed of 18 megabits per second, a spokesperson said. In an audiovisual application, for example, all that storage space could hold 500 still pictures and an hour of stereo sound, according to Matsushita specs.

- MicroPro International (San Rafael, CA) plans to ship its WordStar for the Macintosh this month. The \$495 Mac WordStar is a completely new product

*continued*



## NANOBYTES

rather than a port from the MS-DOS version. President Leon Williams said the program will provide virtually every feature of WordStar Professional, WordStar 2000, and Microsoft Word, and much of what's in Aldus's PageMaker. Among the advanced features are ability to wrap text around graphics, text rotation, text routing, and grammar-checking. All the new WordStars are pushing hard into the low end of the desktop publishing market and will help push high-end desktop publishing "back into the art department," said product manager Dave Cannon. Versions for Unix and OS/2 are in the works, he said.

- Toshiba (Irvine, CA) is offering a new display and a new storage device for its T1200 laptop computer. For \$475, you can get a backlit supertwist display swapped in. For \$1200, you can have one of the T1200's two 3½-inch floppy disk drives replaced with a 20-megabyte hard disk drive.

- NCR Microelectronics (Dayton, OH) has a new SCSI host adapter chip that can interface the IBM PC series, PS/2 Model 30, and compatibles to any small-computer-system-interface (SCSI) peripheral. NCR claims that the chip has a higher level of integration and greater versatility than its competitors. Product marketing engineer Prasan Pai declined comment regarding which companies would be the first to use the new chip. The CMOS 53C400 uses two rotating 128-byte buffers and a Move Block instruction to pro-

*continued*

## Chip Set Will Yield 80-MFLOPS PC Cards, Company Says

**H**ow about an 80-million-floating-point-operations-per-second (MFLOPS) coprocessor card for about \$3000? Sound too good to be true? Interstate Electronics (Anaheim, CA) says it will introduce a wavefront array processor chip set by the end of next year that will pack performance of 80 MFLOPS onto a PC-size card. Cost of the cards will probably be around \$3000 each, and the company claims that you'll be able to hook four of them together to produce 320 MFLOPS of computing power for less than \$20,000.

Those will be rather specialized MFLOPS. A wavefront array processor is designed to work on problems best solved by highly parallel methods. This means applications such as CAD, imaging, engineering and scientific simulation, computational fluid dynamics, and signal processing—the classes of problems often worked on by supercomputers.

The Interstate chip set will be based on the QUEN architecture, developed at Johns Hopkins University. QUEN uses an array of processors, with each pair of ad-

jacent processors sharing a dual-port memory. Information is passed via the memories, and the memory units also handle memory-address generation and control data flow. The design produces a fast parallel processing system with minimum computational overhead.

The first QUEN-based processors are being built using Analog Devices' 32-bit digital signal processing (DSP) chip sets. Like many DSP chips, the Analog Devices sets are limited to fixed-point arithmetic, but like DSP chips in general, they are extremely fast.

## Falling Prices, Changing Techniques Could Put GaAs in Your Next Personal Computer

**G**allium arsenide (GaAs) chips have been considered an exotic but expensive technology. Microprocessor experts have agreed that until costs come down and yields go up, the chips will not find their way into personal computers. Costs have been coming down slightly, and several chip makers now say they're able to raise reliable output.

"Most of the groups working on it wanted to build the fastest devices they could," said David MacMillan, one of the founders of Gazelle Microcircuits (Santa Clara, CA). "They tended to have low yields, and since the fabrication plants were not heavily utilized, costs were high. GaAs chips were also historically difficult to use; they required multiple power supplies, had nonstandard logic switching levels, and required unique ceramic circuit boards to handle the microwave switching levels," he said. "We wanted to take GaAs's high speed and make it available."

Gazelle is one of the chip designers trying to solve

some of the problems and lower the costs of putting GaAs in personal computers. The company recently announced its GA22V10, a GaAs version of the 22V10 programmable logic device. The 22V10 isn't a household name with most computer users, but according to MacMillan it's commonly used in memory caching systems for high-performance systems based on the 80386, 68020, and newer reduced-instruction-set-computer (RISC) chips. The PLD is used for custom logic that interfaces the fast processor to slower dynamic RAM and a fast RAM cache.

The GA22V10 uses standard TTL logic levels for all inputs and outputs and runs from a 5-volt power supply. But inside, the gates are all GaAs. As a result, the propagation delay is 10 nanoseconds or less; that means the GA22V10 can run at speeds of 90 MHz or faster. The fastest silicon 22V10 runs at a top speed of around 50 MHz.

MacMillan explained that because Gazelle engineers chose a high-volume

standard part for its first chip, they were able to design it conservatively. "We traded off a little speed for reliability," he said. The result is that Gazelle is already getting good chip yields, MacMillan claimed. The company uses outside foundries to manufacture the chips.

The GA22V10 is more than three times as expensive (\$55 each in 100 quantities) as silicon chips with about half the performance (around \$16 in 100 quantities), which makes it too expensive for most PC-type applications. The advantages of GaAs—high speed and steady performance across a wide range of temperatures and voltages—make such chips worth the price for some designers. But MacMillan said that with improving yields and volume, within 3 or 4 years GaAs chips should fall to around \$10. The company will be introducing several products by the end of this year—more PLDs, as well as "other standard parts," MacMillan said.

*continued*





Natural selection provides unique passive protection for the porcupine.

# The Block -- Natural Selection For Software Protection



*Inventor and entrepreneur Dick Erett explains how "The Activator" provides sane protection for your intellectual property.*

**I**n any industry, just as in nature, the process of natural selection raises one solution above another. Natural selection is the most elegant of engineers.

In the area of software protection The Block has been selected by the marketplace as the solution that works. Over 500,000 packages are protected by our device.

For the past 4 years our philosophy has been: *'You have the right and obligation to protect your intellectual property.'*

## A New Ethic For Software Protection

In allowing end-users unlimited copies of a software package and uninhibited hard disk and LAN operation, The Block has created a new ethic for software protection.



By removing protection from the magnetic media we remove the constraints that have plagued legitimate users.

They simply attach our key to the parallel port and forget it. It is totally transparent, but the software will not run without it.

## A New Technology For Software Protection

Our newest model, The Activator, builds on our current patented design, and establishes an unprecedented class of software protection.

We have migrated and enhanced the circuitry of The Block to an ASIC (Application-Specific Integrated Circuit) imbedded in The Activator.

This greatly improves speed and performance, while reducing overall size. Data protection can also be provided.

## Programmable Option

The Activator allows the software developer the option to program serial numbers, versions, or other pertinent data known only to the developer, into the circuit, and access it from the program.

Once you program your part of the chip, even we have no way to access your information.

The ASIC makes emulation of the device

virtually impossible. It also presents an astronomical number of access combinations.

## Full 100% Disclosure

Since The Activator is protected by our patent we fully disclose how it works. Once you understand it, endless methods of protection become evident.

Just as no two snowflakes are the same, no two implementations of The Activator are identical. And like the snowflake the simplicity of The Activator is its greatest beauty.



We never cramp your programming style or ingenuity. Make it as simple or complicated as you desire.

Let us help safeguard what's rightfully yours. Please call today for additional information or a demo unit. *It's only natural to protect your software.*

1-800-333-0407  
In Connecticut 203-329-8870  
Fax 203-329-7428



870 High Ridge Road  
Stamford, CT 06905

Unlimited Copies • Programmable • Small Size • Fast • Patented • Data Protection



# Introducing Mic for OS/2

## Microsoft Pascal 4.0

Computer

```
File Edit Search Run Help
9) i : 9
1) notprime : -10
14: writeln('
15: prime := 5;
16: repeat
17:   rprime := prime;
18:   sqrt := trunc(sqrt(rprime));
19:   i := 1;
20:   notprime := false;
21:   while (i < sqrt)
22:     begin
23:       i := i + 2;
24:       notprime := (p
25:     end;
26:   if (not notprime)
27:     prime := prime + 2;
28:   until (prime > 1000000);
```

## Microsoft BASIC 6.0

Computer

```
File Edit Search Run Help
Child$ : "dirsortifind " BS"
FileNumber = 5 : 0.000000
' The child process does: B
Child$ = "dirsortifind " +
DIR Directory$(100) ' Stri
FileNumber = FREEFILE ' Me
OPEN "PIPE:" * Child$ FOR B
WHILE NOT EOF(1) ' Loop un
LINE INPUT #FileNumber,
NumEntries = NumEntries
VEND
ChildDone: ' T
CLOSE FileNumber
FOR i = 1 TO NumEntries
```

## Microsoft C 5.1

Computer

```
File Edit Search Run Help
9) i : 217
1) p : 23383:5936
025: int i
026:
027: set_curs
028: p = scrbu
029:
030: /* Draw top of box
031:
032: *p = 218;
033: p += 2;
034: for (l = 0;
035: *p
036: *p = 191;
037: p += 2;
038:
039: /* Draw side of box
```

The people who co-developed the industry's most powerful personal computer operating system are now proud to announce programming languages to match.

Introducing Microsoft® Macro Assembler 5.1, C 5.1, Pascal 4.0, FORTRAN 4.1 and BASIC Compiler 6.0.

Five industrial-strength, stand-alone languages that combine the implementation flexibility you've enjoyed under MS-DOS® (which, of course, they still support) with the advanced capabilities you've anticipated from OS/2.

Capabilities such as the ability to develop

large, sophisticated applications which go beyond the 640K barrier, taking advantage of up to 16MB of RAM, and utilizing the potential of today's microprocessors.

Just like their MS-DOS predecessors, these five new languages are equipped with powerful, professional features you work with, not around:

Support of direct calls to the operating system, and inter-language calling for mixing multiple languages on the same project.

Access to OS/2 system calls and a full complement of utilities, including an incredibly fast incremental linker and the

# Microsoft Languages systems.

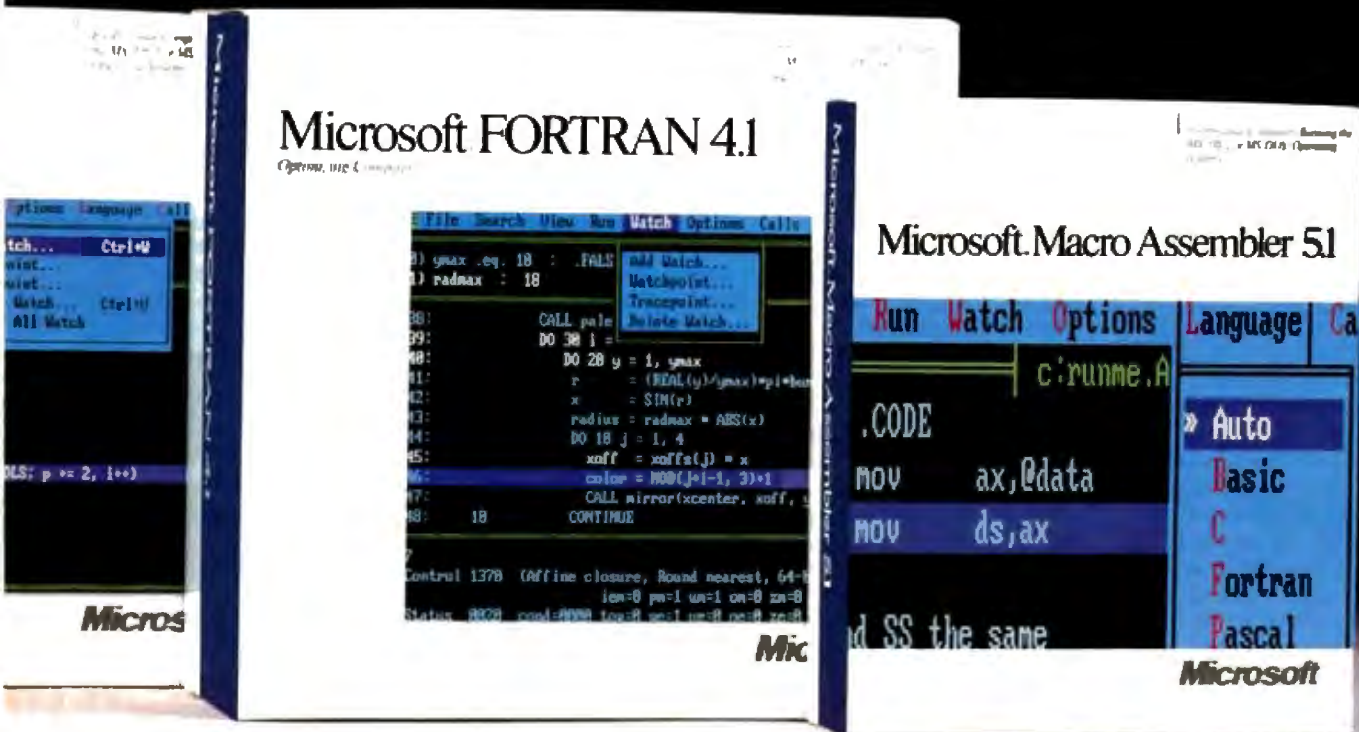

first protected mode programmer's editor that works equally well in real mode.

Microsoft CodeView<sup>®</sup>, our popular, advanced debugger that lets you untangle program logic at the source code level, no matter what code you're using.

(It even lets you debug protected mode programs up to 128MB of virtual memory, and larger programs than ever before in real mode.)

As the perfect complement to our new languages, we're also offering the Microsoft OS/2 Programmer's Toolkit.

It contains a parameter-by-parameter

breakdown of all OS/2 system calls and samples to get you started.

All the tools you need for turning out larger, more powerful, more complex OS/2 applications.

(And, incidentally, all the tools we rely on for creating our own commercial software.)

For the name of your nearest Microsoft professional languages dealer, simply call 800-541-1261, Dept. B96.

Ask him for some more information on our OS/2 family.

He'll show you some languages you can really swear by.



## NANOBYTES

vide data burst rates of up to 1 megabyte per second, NCR says. Control over data burst rates permits matching speeds between a host bus and a SCSI peripheral.

- Researchers at Stanford University (with support from the U.S. Air Force) have developed a device called a "nano-indenter" for testing the strength and frictional resistance of thin films with thicknesses of less than 1 micron. The results from submicron materials testing can help engineers determine the wear resistance and corrosion characteristics of ICs and other applications using thin films.

- National Instruments (Austin, TX), which makes a variety of IEEE-488 test and analysis devices, is now running seminars on data acquisition and analysis using personal computers, like IBM PCs and Mac IIs. Besides how to choose and use a data acquisition system, the lessons will include training sessions on hooking up sensors; capturing and graphing points; and formatting, filtering, compressing, and displaying waveforms. The seminars run until November in locations throughout the U.S. For more information, phone (800) 531-4742; in Texas, dial (800) 433-3488.

- For everyone who's waiting for a new desktop presentation program for the Macintosh, Software Publishing Corp. (Mountain View, CA) plans to release one next year sometime. The company is developing the program in conjunction with Three D Graphics (Pacific Palisades, CA),

*continued*

Currently, the company can put about 10,000 gates on a chip, and the number of gates per chip is roughly doubling every year, he said. MacMillan would not comment on the prospect of GaAs CPUs except to say that

in 2 to 3 years, the number of gates on a chip will be high enough to support such a processor.

Engineers at chip giant Texas Instruments have fashioned ICs containing GaAs and silicon transistors, com-

binning the former's high speed with the latter's high density and low power use. With an innovator like TI behind such a project, desktop PCs powered by GaAs are likely within the next couple years.

## DRI Hopes to Out-DOS MS-DOS with DR DOS

**D**igital Research, Inc. (Monterey, CA), is hoping a new operating system will help it regain some of the ground it lost to Microsoft. DRI says its MS-DOS work-alike, called DR DOS, is a better operating system than Microsoft's. The new operating system is ROMable, offers 512-megabyte disk partitions and password protection, and costs up to 50 percent less than its competition. But though DRI says DR DOS can run all MS-DOS software, the system's commands aren't exactly the same—and, at least initially, it will be sold only to OEMs.

The new operating system wasn't his company's idea, according to DRI's Michael Malloy. OEM customers asked for an "entry-point" operating system that would ease the migration to DRI's Concurrent DOS. "It

wasn't designed as a clone [of MS-DOS]. What we've done is used our own commands and command structure to create a wholly proprietary, unique product."

DR DOS can be put into ROM and executed from ROM. "These days, RAM chips are a precious commodity," Malloy said. "A ROMable operating system is valuable for laptops, because it gives you 'instant on' capability, and another use is in diskless PCs that function as nodes to a network." At 64K bytes, DR DOS is also slightly smaller than current versions of MS-DOS. DRI will also offer version 3 of its GEM mouse-and-menu graphical interface as an option for DR DOS; like the operating system, GEM can run entirely from ROM.

Malloy said some of the commands in DR DOS will

be familiar to MS-DOS users. "Some commands are generic; for example, FORMAT and COPY. And others date back to CP/M or earlier, such as DIR," he said.

Though DRI claims DR DOS can run all MS-DOS-compatible software, DR DOS isn't being presented as an inexpensive MS-DOS copy. Malloy emphasized DR DOS's extensions beyond MS-DOS: large hard disk partitions (up to 512 megabytes, compared to MS-DOS's 32 megabytes); password protection for all files and subdirectories; and a built-in help system behind each utility. "You can bring up help at any time with a single key combination," said Malloy.

Although DRI will initially sell DR DOS only to OEMs, the company is looking at the end-user market.

## Company Claims to Cut Cost and Time of Prototyping Custom Chips

**O**ne of the fastest-growing areas in the computer business is the application-specific integrated circuit (ASIC). ASICs are custom-designed chips for specific applications. However, ASICs typically are expensive to produce; chip makers need high volumes to justify the investment.

United Silicon Structures (US2), a San Jose, CA-based subsidiary of a European-based ASIC manufacturer, hopes to change all that with an ASIC manufacturing

method that allows "short-term prototyping" and low-volume production of ASIC designs. The company uses "E-beam" technology to write circuits directly onto the silicon wafer rather than using traditional photomasking techniques. With E-beam technology (variable-width electron beams), multiple ASIC designs can be produced on a single wafer. US2 claims that as many as 21 designs have been prototyped on a single wafer. In contrast, traditional photo-

masking allows only a single design per wafer. With the E-beam method, a customer can get 10 guaranteed prototypes in about 8 weeks for a cost of around \$20,000, US2 says.

As the cost of prototyping ASIC designs comes down, ASICs will be used more frequently in production computers. According to US2's Jacques Castaillac, "until now the main use of ASICs has been for logic replacement. The new trend

*continued*



# Take the \$67.95 PROFESSIONAL TOOLS SET for only \$495

as your introduction to the  
**Library of Computer and Information Sciences.**

You simply agree to buy three more books—at handsome discounts—within the next 12 months.

Be a consultant in your spare time. Write effective user manuals. Manage projects successfully. It's easy if you know the tricks of the trade. The step-by-step approach in

these three softcover books—over 650 idea-filled pages in all—helps you apply proven techniques and methods so you can refine your professional skills.



## **The Secrets Of Consulting** A Guide to Giving and Getting Advice Successfully *Gerald M. Weinberg*

An experienced consultant shows you how to avoid common consulting pitfalls, establish trust, market your services, and more. Also explores the art of effectively hiring and managing a consultant.

Publisher's price: \$2500

## **How to Write a Usable User Manual**

## **How To Write A Usable User Manual** *Edmond H. Weiss*

This expert guide shows you how to write a manual using a five-step structured approach that parallels the methodology you use in developing a computer program: analysis, design, assembly, editing, and maintenance.

Publisher's price: \$1495

## **PRACTICAL PROJECT MANAGEMENT**

## **Practical Project Management** Restoring Quality to DP Projects and Systems *Meilir Page-Jones*

This idea-filled guide walks you through effective project management. Covers estimating resources, costs, and benefits; reporting, as well as deadlining, project methodologies; project review, and more.

Publisher's price: \$28.00

**MEMBERSHIP BENEFITS** • In addition to getting The Professional Tools Set for only \$4.95 when you join, you keep saving substantially on the books you buy. • Also, you will immediately become eligible to participate in our Bonus Book Plan, with savings of 65% off the publishers' prices. • At 3-4 week intervals (16 times per year), you will receive the Library of Computer and Information Sciences News, describing the coming Main Selection and Alternate Selections, together with a dated reply card. • If you want the Main Selection, do nothing, and it will be sent to you automatically. • If you prefer another selection, or no book at all, simply indicate your choice on the card and return it by the date specified. • You will have at least 10 days to decide. If, because of late mail delivery of the News, you should receive a book you do not want, we guarantee return postage.

**The Library of Computer and Information Sciences** is the oldest, largest book club especially designed for computer professionals. In the incredibly fast-moving world of data processing, where up-to-the-moment knowledge is essential, we make it easy to keep totally informed on all areas of the information sciences. What's more, our selections offer you discounts of up to 30% or more off publishers' prices.

If reply card is missing, please write to The Library of Computer and Information Sciences, Dept. 7-ER9-00882, Riverside, NJ, 08075 for membership information and an application.  
BYTE 9/88



## NANOBYTES

which brought us Boeing Graph, aka Perspective.

- **3Com** (Santa Clara, CA) has trimmed the prices of its adapters for connecting PCs to Ethernet and token-ring networks. EtherLink II will now sell for \$445 instead of \$495, and TokenLink will sell for \$595 instead of \$650.

- **CMS Enhancements** (Tustin, CA) will soon start selling an external 30-megabyte SCSI hard disk drive for the Apple IIe and IIGS and a similar-size unit for the Mac Plus, SE, and II. The half-height 3½-inch units have an access time of 30 milliseconds, a spokesperson said. The IIe/IIGS model will have

*continued*

is to put entire systems on silicon."

Castillac predicts that by 1990, the volume of ASIC production will match that

of printed circuit boards. By the end of 1989, US2 will be offering 1-micron CMOS ASICs (current designs are 1.5 microns).

US2 also offers ASIC design software that runs on Sun Microsystems workstations, Apollo workstations, and IBM PC AT computers.

## Weitek Says New Math Chip Cures "Anemic" 386ers

Calling 80386 machines "anemic number crunchers," Weitek has designed a single-chip floating-point coprocessor for machines based on the Intel 80386. The new Weitek Abacus 3167 coprocessor is object code-compatible with the Weitek 1167 coprocessor chip set and is available in 20- and 25-MHz versions.

In sustained performance at 25 MHz, the Abacus measures 0.7 MFLOPS double-precision LINPACK and 1.0 MFLOPS single-precision LINPACK, the company

claims. These figures represent floating-point performance comparable to that of a VAX 8560 and about triple that of the 80387 math coprocessor, according to Weitek official John Rizzo. In a demonstration, a three-dimensional image screen refresh appeared significantly faster with the Abacus than with an Intel 80387—1.4 seconds versus 4 seconds, according to Weitek.

Weitek president Art Collmeyer said that present 80386 systems, even with 80387 coprocessors, "fall well short of the perfor-

mance standards for engineering platforms. PCs make up less than 20 percent of the CAD/CAM market." Weitek hopes to raise that percentage with Abacus.

The chip plugs into the 121-pin Extended Math Coprocessor (EMC) socket supported on many 80386 system boards, including those from Compaq, AT&T, Dell, NCR, Sun, and Hewlett-Packard. An optional daughterboard allows installation of both the Abacus and the 80387 coprocessor, for maximum flexibility.

*continued*

# With MapInfo, More Ways Than Ever To Map Your Data



**Pin Map.** Automatically use your existing database (from dBASE III or others) with street maps that we can supply. Maps from over 300 U.S. cities and towns contain all addresses, accurate to the correct block and side of the street. Type any address and MapInfo will find it for you. Call to the screen your complete record.



**Thematic.** Use our boundaries (state or county) or draw your own (sales regions, election districts, etc.). Create a database for the region (population, average income, etc.) Color code boundaries or entire regions based on parameters you define.

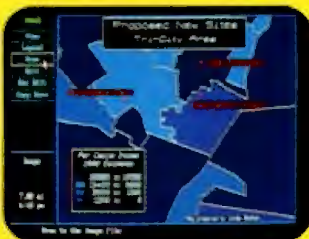

**Presentation.** Use powerful graphics commands to add your own titles, legends and text. Create arrows, windows or callouts. Turn on or off labels of points, streets, bridges, regions, etc.

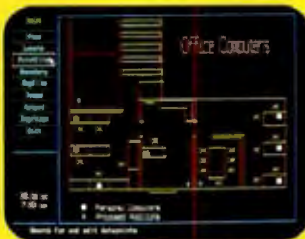

**Visual Database.** Draw anything from a floor plan to aircraft design. Store data on any point or region. Create multiple layers to add flexibility to your display.

And that's just a sample. If you need to map your data, MapInfo can do it for as little as \$750. IBM PC or 100% compatibles, with 640K memory, a hard disk drive, and graphics capability.

To order, call 1-800-FASTMAP. In New York State, call 1-518-274-8673 (Telex 371-5584). MapInfo Corp., 200 Broadway, Troy, NY 12180

dBASE III is a trademark of Ashton-Tate. IBM and IBM PC are trademarks of International Business Machines Corp.

## MapInfo



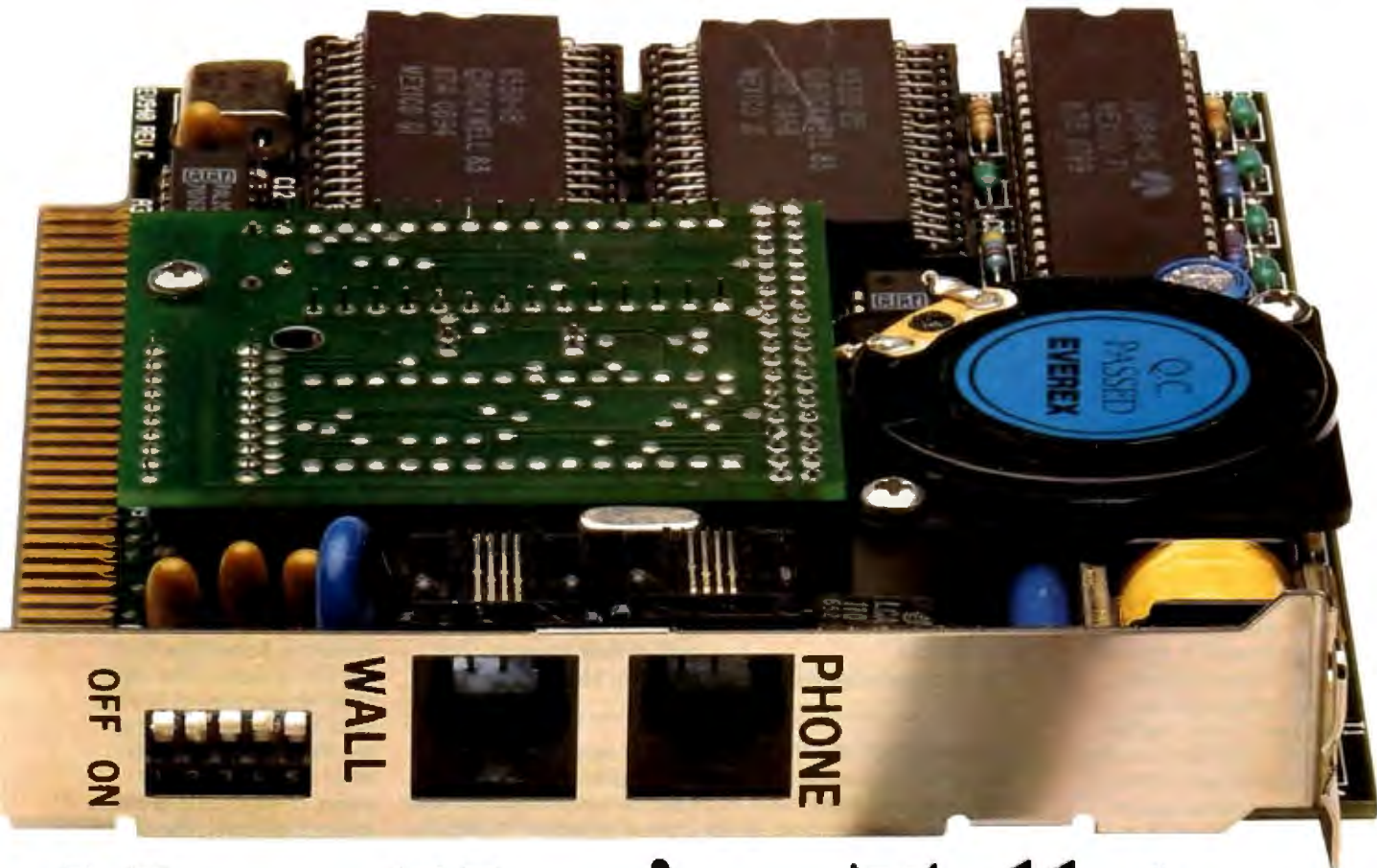

# Now You're Talking

Communicate with anyone anywhere in the world. Whether you use E-Mail or bulletin boards, information services like The Source and CompuServe,<sup>®</sup> or data file transfer, Everex modems meet all your communications needs.

Working at your desk or on the road, Everex offers you a complete range of modem solutions. We have 1200 or 2400 bps internal and external modems, modems that send and receive FAX communications, modems with MNP error correction, and a miniature modem that fits in your shirt pocket.

All Everex modems offer worldwide compatibility with Bell, CCITT or Hayes<sup>®</sup> standards. And, our modems are compatible with IBM<sup>®</sup> PC<sup>™</sup>/XT<sup>™</sup>/ATs<sup>®</sup> and compatibles, PS/2s,<sup>®</sup> Apple<sup>®</sup> II and Macintosh<sup>™</sup> computers.

Features like automatic data-to-voice switching, tone or pulse dialing, built-in diagnostics, helpscreens, adaptive dialing, software-adjustable volume control, and auto-dialing all

combine to increase the flexibility and ease-of-use of Everex modems. The powerful communications package BitCom<sup>™</sup> is included with every modem. Complete hardware and software manuals make setting up and using Everex modems quick and simple.

You can rely on Everex modems to deliver superb performance at an affordable price. So, when you need a modem for your PC/XT/AT or compatible, PS/2, or Apple II and Macintosh computers, Everex has the Answer.



EVER for Excellence is a registered trademark and EVEREX is a trademark of Everex Systems, Inc. IBM, AT and PS/2 are registered trademarks and PC and XT are trademarks of International Business Machines Corp. Hayes is a registered trademark of Hayes Microcomputer Products, Inc. BitCom is a trademark of Bit Software, Inc. Apple is a registered trademark and Macintosh is a trademark licensed to Apple Computer, Inc. CompuServe is a registered trademark of CompuServe Information Services. The Source is a trademark of Source Telecomputing Corporation. © Copyright 1988 Everex Systems, Inc. All rights reserved.

Circle 95 on Reader Service Card (DEALERS: 96)

For more information or the name of your nearest Everex dealer please call:  
in Calif. **1-800-821-0807**  
in U.S.A. **1-800-821-0806**

**EVEREX**  
EVER for Excellence

(415) 498-1111 48431 Milmont Drive, Fremont CA 94538  
SEPTEMBER 1988 • BYTE 19



**NANOBYTES**

a list price of \$955. The Mac model will list for \$895.

• **The Thing That Would Not Die, Part II:** "Home business" was again the magic phrase of computer makers and other equipment manufacturers at the Summer Consumer Electronics Show in Chicago. Nearly every manufacturer who sells a combination of desktop PCs, typewriters, personal copiers, one- or two-line telephones, or low-cost facsimile machines is trying to peddle them for the home business market. There are about 13 million home businesses in the country, says the American Home Business Association.

The Abacus or 1167 chips do not support the 80387 instruction set, however. Applications written for the 80387 must be recompiled to run on Weitek's chips.

IBM does not currently support the EMC socket in its 80386 systems, but Far Point Engineering (Atlanta, GA) has announced a Micro Channel expansion board that uses the Abacus chip. Rizzo said Weitek hopes IBM will support the EMC socket but declined to comment further.

Several major engineer-

ing software and compiler vendors said they'll support the Abacus coprocessor. These companies include CadKey, MCS, MacNeal-Schwendler, Swanson Analysis, Lahey Computer Systems, MetaWare, and other developers of engineering, statistical, and CAD/CAM software. However, the Abacus chip poses difficult problems for companies that have traditionally relied on mainframe and minicomputer customers for the bulk of their revenues. For example, MacNeal-

Schwendler is porting its lower-priced PAL2 finite-element software but is reluctant to port its high-priced NASTRAN software, since that would undercut the company's minicomputer business, where prices and profit margins are higher than in the microcomputer industry.

The Abacus chip can be sampled now but won't be widely available until the end of the year. The chip is being manufactured for Weitek by Matsushita Electric Co. of Japan. The OEM price in quantities of 5000 is \$445 for the 20-MHz chip and \$882 for the 25-MHz chip; the daughterboard with a 20-MHz chip is \$595. At the retail level, these prices translate into \$1200 to \$2500 added to the cost of an 80386 system, or at least three times the cost added by an 80387.

**TECHNOLOGY NEWS WANTED.** *The news staff at BYTE is interested in hearing about new technological and scientific developments that might have an impact on microcomputers and the people who use them. If you know of advances or projects relevant to microcomputing, please contact the Microbytes staff at (603) 924-9281, send mail on BIX to Microbytes, or write to us at One Phoenix Mill Lane, Peterborough, NH 03458. An electronic version of Microbytes, which offers a wider variety of computer-related news on a daily basis, is available on BIX.*

**LOOK!**  
**It's Flow Charting™ II+!**

The ultimate fast track tool—for internal auditors, public auditors, secretaries, engineers, managers and line leads. Performance power WITH A PLUS, for even faster and easier construction, editing and printing of flowcharts and org charts.

- Text auto centering
- Smart line mode
- Internal mouse driver
- 10 text fonts
- Ega support
- Comprehensive, friendly manual

Give your charts the PLUS for only \$229\* Contact your local software dealer—or call us.

**PATTON & PATTON**  
Software Corporation

81 Great Oaks Blvd., San Jose, CA 95119  
1-800-525-0082, Outside California  
408-629-5376, California/International  
\*plus shipping. In California add tax.

*Excellence in charting the flow of ideas*





**Our Competitors Say We Overengineer  
Our Products.**

*Circle 108 on Reader Service Card*





©1988 GENICOM CORP.



# Precisely.

When our engineers design a Genicom printer, they start with the obvious: functionality. Building in all the features a printer user needs. And making sure that the printer will perform up to its expectations with unerring precision and rock-solid dependability.

But we go beyond that. Because we know that you also need versatile machines that offer a high degree of compatibility. As well as printers that you can upgrade or adapt to your future applications.

It all adds up to the fact that Genicom offers you exceptional value for the dollar: superior performance on a long-term basis.

So the next time you're considering a new printer, think of Genicom first. We offer a full line of hardworking printers: everything from daisy wheels to lasers, plus dot matrix, line matrix and band printers.

Actually, we enjoy our reputation for overengineering because people depend on Genicom printers—over and over again.

## GENICOM

**Ideas that work as hard as you do.**

Genicom Drive, Waynesboro, Virginia 22980

1-800-4-GENICOM

*Circle 108 on Reader Service Card*





# OUTSTANDING SOFTWARE

For IBM PC's and Compatibles

\$3.50 PER DISK

\$3.00 PER DISK

Small Quantities

For Ten or More

SHIPPED WITHIN 24 HOURS!  
Satisfaction Guaranteed or Money Back!

- BUSINESS 1—EZ-FORMS business form generation, completion and printing program.
- CAD 3—The PC-Flow 1.0 computer aided flow-chart generation program. Color graphics required.
- COMM 4a,b,c,d,e—(5 disks) Join the world of sysops with RBBS Bulletin Board System 14.1D.
- DATABASE 1a,b—(2 disks) File Express 3.8 menu driven general purpose database manager
- EDUCATION 1—Interactive DOS tutorial for new PC users. Makes learning DOS painless.
- FINANCE 1a,b—(2 disks) PC Accountant 2.0 personal bookkeeping and finance management.
- GAMES 1—3-D Pacman, Kong, Spacewar, Jarit-Joe, futuristic Flightmare and more. Color required.
- GAMES 2—Oubart, Pango, Centipede, dungeons and dragons style Zoare, etc. Color req.
- GAMES 3—Blackjack with customizable rules, Armchair Quarterback (you call plays), and more.
- GAMES 4—Star Trek, the Castle adventure game, and the original Colossal Caves Adventure.
- GAMES 5—The Hack adventure game from the universities. Like Rogue, only much richer.
- GAMES 6—Pinball, Othello, Dragons, Sopwith (fly a Sopwith Camel) and more. Color required.
- INFO 1a,b—(2 disks) Cooking recipes database with keyword/ingredient retrieval. Add your own.
- MUSIC 2a,b—(2 disks) PianoMan 3.0 polyphonic music recording and playback program.
- ORGANIZER 1—DeskTeam, a Sidekick clone, and the Judy personal calendar program.
- PRINTER 1—Resident print control and font utility, intelligent spooler, banner maker, and more.
- SIMULATION 1—Maze making program, MIT's Life simulation, starfields, etc. Color graphics req.
- UTILITIES 1—A collection of invaluable general purpose DOS utilities. An absolute must for all.
- UTILITIES 2—More invaluable DOS utilities including screen burnout, ram disk, and more.
- UTILITIES 3—A comprehensive set of debugging and diagnostic utilities for monitoring your computer.

BY 988

## NEW RELEASES UPDATES

- BUSINESS 2—Expressgraph business graphics. Chart your data and find trends. Color graphics req.
- CAD 1a,b—(2 disks) Fingerprint 1.2 advanced painting and Altamira object oriented design. Color.
- CAD 2a,b—(2 disks) DanCad3d, an advanced 2D/3D drafting program w/animation. 640K, color.
- COMM 2a,b—(2 disks) Procomm 2.42, an excellent modem program with terminal emulation.
- EDUCATION 3—PC-Fastype 1.20 typing tutor, ideal for beginners and advanced students alike.
- FINANCES 3a,b—(2 disks) Express Calc 3.12, a powerful and user friendly spreadsheet program.
- GAMES 8—Stinker helicopter attack and Risk, the game of world domination. Color required.
- GAMES 12—Backgammon (play the computer) and Wheel of Fortune based on the gameshow.
- GRAPHICS 1—Record and play back screen images! Excellent for demo, etc. Color required.
- GRAPHICS 2a,b,c—(3 disks) An excellent 3-D surface modelling and shading program. Color.
- INFO 2a,b—(2 disks) Zip-Phone, national areacode/prefix to zip-code cross reference.
- LANGUAGE 3a,b—(2 disks) The A86 3.09 macro assembler and debugger for 8088/86/286s.
- SHELL 4a,b—(2 disks) Automenu and HDM II 4.04 hard disk prog. for custom full-screen menus.
- UTILITIES 5—Hard disk utilities for verifying, formatting, parking and optimizing your disk drives.
- UTILITIES 6—Advanced utilities including Mark/Release (remove resident progs w/o reboot!)
- UTILITIES 7—More advanced utilities including Masterkey (undeletes files from hard disks).
- WORD 1a,b—(2 disks) PC Write 2.71, a powerful word processing system w/spell checker, laser supt.

Most software listed is shareware or user-supported

3.5" format, add \$1 disk, 125 page directory, add \$2.

MicroCom Systems Cost of items \_\_\_\_\_  
3673 Enochs Street Shipping \$3.00  
Santa Clara, CA CA res tax \_\_\_\_\_  
95051 Total encl. \_\_\_\_\_

(408) 737-9000



Mon-Fri 7am-9pm, Sat-Sun 8am-5pm



# LETTERS

## Recursion vs. Iteration

In "Problems and Pitfalls" (June), Alfred A. Aburto Jr. compares the usual Fibonacci benchmark to a "nonrecursive form" and says that "the performance differs by a factor of over 4500. Apparently, recursive function calls are highly inefficient" (page 224). This is incorrect. In the Fibonacci benchmark, when fib(24) is called once, it turns out that fib(23) is called once, fib(22) twice, fib(21) three times, fib(20) five times, fib(19) eight times, and so on, down to 28,657 procedure calls to fib(2). This redundancy causes the efficiency loss.

This and similarly inefficient recursive procedures often lead to the conclusion that recursion is necessarily bad compared to iteration. (That is the real comparison here, not recursion versus "nonrecursive" procedure calls.) However, any recursive routine can be written iteratively, and vice versa; it's easy to write a recursive fib() with no redundancy. The only reason recursion is usually singled out as worse is that it's easier to overlook redundancy in procedure calls than in a FOR...NEXT loop.

The benchmark tests procedure calls and addition. (It would be nice to remove the addition, but then there would be no answer to test.) It's difficult to compare recursive procedure calls to nonrecursive procedure calls, because it's difficult to write a program with one that does exactly the same as a program with the other, but the Fibonacci benchmark does a good job of comparing procedure calls under one compiler on one machine to those under another.

Daniel J. Bernstein  
Bellport, NY

## Rounding Calculations

In "Error-Free Fractions" (June), Peter Wayner discusses a weakness in digital computing. His proposed solution, factorial-base fractions, is more open-ended than some alternative schemes of fractional representation. However, regardless of the storage method, the results of most calculations need to be rounded.

Seldom do we consider that between

any two of the exactly representable digital values, there are infinitely many rational numbers.

In general, after multiplying two fractions, as many bits are required to exactly represent the result as are required to represent the two fractions. I call this "doubling the denominator." Adding terms with denominators that are mutual primes also doubles the denominator. Recursive operations, such as those used in modeling or in producing fractal approximations, soon overflow any scheme of representation.

For example, using factorial arithmetic, the Mandelbrot Set recursion  $z = z^2 + c$ , with  $c = 0.25 (.012f)$ , requires 5, then 9, then 17, then 33 factorial terms, for the first four iterations. If you were to use a 256-byte array for the factorial fractions, the result of the seventh iteration of this series would not be representable. In spite of the fact that 256 factorial terms can exactly represent an enormous quantity of values (about  $10^{507}$ ), seven or eight multiplications are sufficient to find a number outside the scope of the method.

I think we'll be living with rounding errors for some time to come.

Larry Van Stone  
Stillwater, OK

## Rave Review

I am not a subscriber to any personal computer magazine, although I pick one up occasionally. I want you to know that from the few BYTES I've picked up, I have been impressed with your articles

*continued*

WE WANT TO HEAR FROM YOU. Please double-space your letter on one side of the paper and include your name and address. We can print listings and tables along with a letter if they are short and legible. Address correspondence to Letters Editor, BYTE, One Phoenix Mill Lane, Peterborough, NH 03458.

Because of space limitations, we reserve the right to edit letters. Generally, it takes four months from the time we receive a letter until we publish it.



# Who Says FoxBASE+ is Better than dBASE®?



*The Best Just Got Better—Now Shipping New FoxBASE+ Version 2.10!*

**Nicholas Petreley, *InfoWorld* Review Board:**

"FoxBASE+ has outdone itself. Once again, FoxBASE+ earns an "excellent" in performance, with kudos for responding to user suggestions. For sheer productivity, there is no other choice." *InfoWorld* "Editor's Choice" for 1987 and 1988!

**P.L. Olympia, Founder & President, National Dbase Users Group / Government Computer News:**

"FoxBASE+ is a supercharged dBASE, with all the features Ashton-Tate forgot. If you're into serious dBASE development and have not tried FoxBASE+, you are living in the dark ages and wasting your company's money."

**George F. Goley IV, Cont. Editor, *Data Based Advisor*:**

"The product is fast, very compatible, fast, easy to use, fast, relatively inexpensive, and very fast. In every test, FoxBASE+ outperformed the other products. And people who answer the phone at Fox know what they are talking about."

**David Irwin, Former President/CEO, *Data Based Advisor*:**

"From the dBASE compatibility standpoint, FoxBASE+ is flawless. From the speed standpoint, FoxBASE+ is unbelievable. From the "lazy factor" standpoint, FoxBASE+ is perfect."

**Glenn Hart, Contributing Editor, *PC Magazine*:**

"Initial tests of FoxBASE+ were simply stunning. In many ways, FoxBASE+ gives you the best of both worlds: all the benefits of interactive development and debugging, plus the speed and code protection of a compiler."

**Adam Green, Contributing Editor, *Data Based Advisor*,  
*dBASE* Author:**

"For the PC, FoxBASE+ has consistently set the performance standard for dBASE compatible languages. For the Macintosh, FoxBASE+/Mac will set standards for innovation and leadership in a new dBASE implementation."

**Don Crabb, Contributing Editor, *InfoWorld*:**

"You can expect blazing speed on the Mac. FoxBASE+/Mac breezes past tests that have proven stumbling blocks for Macintosh databases in the past. FoxBASE+/Mac combines complete dBASE compatibility with a genuine Macintosh user interface."

**This is what they said about Version 2.00 of FoxBASE+.**

**Imagine what The Experts will say about New Version 2.10 with these added features: Menu-Driven Interface, Program Documentor, Screen Painter and Template-Based Application Generator . . . and Version 2.10 is even faster than 2.00!**

**Join The Experts. Get your copy of the New FoxBASE+ Version 2.10 today! Now available at your nearest, quality software retailer, or directly from us by calling (419) 874-0162 Ext. 320.**

**Because, when it comes to speed, compatibility and value, nothing runs like the New FOX—Version 2.10!**

## Fox Software

**Nothing Runs Like a Fox.**

Fox Software  
118 W. South Boundary  
Perrysburg, OH 43551

(419) 874-0162 Ext. 320.  
FAX: (419) 874-8678  
TELEX: 6503040827 FOX

Circle 103 on Reader Service Card

FoxBASE and FoxBASE+ are trademarks of Fox Software.  
dBASE and dBASE III PLUS are trademarks of Ashton-Tate.  
Macintosh is a trademark of Apple Computers, Inc.



**Give your software maximum protection but eliminate customer's complaints**

**HASP-II is a hardware device that connects externally into the printer port of the IBM-PC/XT/AT and PS/2 families.**

**Special electronic circuits form a unique code allowing only your customers to operate the protected software.**

**Hardware for Software Protection**

HASP-II is "transparent" to the user. It does not interfere with the operation of other programs nor does it require actual connection of the printer to the computer.

Your customer can create backup copies of his programs but these copies cannot be used on another "HASPless" computer.

Implementation is easy. You won't need the source program in order to protect your software, and yet if you have the source, we offer you the option to check for the HASP-II from within the program at any time. Software drivers are supplied.

No automatic copying program or device will be able to crack the HASP-II, since no such tools can duplicate the plug. The HASP-II software is sophisticated and encrypted. The code returned from the HASP-II is algorithm dependent.

**For further information contact us at**

<b>ALADDIN KNOWLEDGE SYSTEMS LTD.</b>	<b>P.O.B. 11141 Tel-Aviv, 61110, Israel Tlx. 35770/1 COIN IL Ext. JBL Tel: 972-3-226286 Fax: 972-3-299170/1 Ext. JBL</b>	<b>In USA: M-Systems Inc. 920 Grand Blvd. Deer Park NY 11729 Tel: (800) 2228887 (516) 242 3344/5</b>
---------------------------------------	--	--

© 1987/88 by Aladdin Knowledge Systems Ltd. Israel.

on numeric methods and calculations methods.

I just read "Error-Free Fractions" by Peter Wayner (June). This was something completely new to me, even though I have taken a course on numeric analysis and my occupation as an engineer requires me to deal with numerically intensive applications.

BYTE seems to be unique among personal computing magazines in carrying such articles, and the articles that I have read intensively seem to reflect the state of the art. I hope you continue to carry such articles and continue the same high quality. It makes your magazine a stand-out among personal computer magazines.

James Larson  
Minneapolis, MN

**Don't Reorder the Alphabet**

As a programmer and student of computer science, I must comment on Billy R. Pogue's letter ("Reordering the Alphabet," June). Pogue claims that "a few moments' thought shows that if our alphabet were arranged in descending order of frequency of occurrence of the letters, any search based on alphabetic order should go much faster, whether done by humans or computers."

In fact, computer search and sort algorithms are completely insensitive to the coding of the information that they operate on. That is, if you changed the order of the alphabet and therefore its representation as numbers inside the computer, the search or sort would produce the same results in the same time. The only change you would be able to see would be the order of sorted information, which always follows the order in which characters occur in the alphabet.

The reason for this behavior is simple. With very few exceptions, character data in a computer is represented as 8 bits per character. Therefore, the search or sort algorithms operate on the same amount of data, regardless of the coding of the characters. It is the number of bits of data rather than the coding of characters that dictates the amount of time an algorithm takes to run.

For a more rigorous proof of this principle, refer to "Sorting and Searching" by Donald Knuth (*The Art of Computer Programming*, Volume 3, Addison-Wesley, 1973), in which run times of various algorithms are derived. In each case, the run times are dependent on the length of the information being searched or sorted and are independent of the encoding of the information.

continued

**What is a Best Western?**



**"My home office wherever I travel."**



**The right place at the right price.**

Make reservations at any Best Western, see your travel agent, or call toll-free  
**1-800-528-1234**

*"World's largest chain of independently owned and operated hotels, motor inns and resorts"*



# THERE ARE FOUR WAYS TO MEASURE THE SPEED OF A LAN.



## Ours only wins in three of them.

### 1. How fast does it install.

We have no competition in this category. LANLink 5X installs in about fifteen minutes, and it doesn't take a technician to do it. Since LANLink 5X uses standard parallel or RS-232 serial ports, installing a network means little more than connecting the cable and loading the software.

With hardware LANs, installation can easily take two days—one to set it up and one to tweak it. And it also takes someone who really knows what he's doing. That is, someone expensive.

### 2. How fast does it transmit.

Okay, this is the category we don't win; the hardware LANs are generally a little quicker. At least, they are under optimal conditions, which is how they rate themselves.

But LANLink 5X is pretty quick, too. At half a megabit per second, it's way out ahead of any other software LAN, and right at the heels of the hardware types. Which, of course, are far more expensive.

### 3. How fast does it maintain.

The real cost of a network is not so much the initial price as it is the continuing outlay for maintenance—adapting it to changing needs. That's something LANLink 5X does practically on its own.

Running under PC-MOS/386® or PC-DOS, it turns your server PC into a multi-tasking controller, driving a truly expandable LAN that is easily and quickly upgradable.

A hardware LAN, on the other hand, becomes obsolete as new technology is introduced. And, to keep the network up and running as applications change, you need the attentions of a technician, on a continuing basis. A very well-paid technician.

### 4. How fast can you pay for it.

Now we've arrived at the bottom line, where LANLink 5X is toughest to beat. You can install a five-user LANLink network for about the same cost as the LAN board in a board-driven network. On top of that, factor in what you save on installation and maintenance time, and the difference is pretty dramatic.

LANLink 5X is available immediately, and it comes with a money-back guarantee. Its price of \$995 includes a server and a satellite module plus the network operating system. Additional satellites are available for \$125.

For complete details on the fastest software-driven network available, call 800-451-LINK.

LANLink 5X. Because three out of four ain't bad.  
3377 Parkway Lane, Norcross, GA 30092 (404) 448-5465 FAX (404) 263-6474

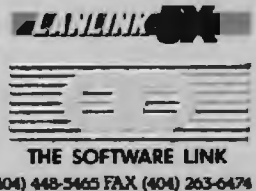





From left to right trademarks of Lotus Systems, Inc. All other product names are registered trademarks of their respective owners.

**EVEREX**



AST Premium 386/20		3.04 MIPS
IBM PS/2 Model 80 (20 MHz)		3.52 MIPS
Compaq DeskPro 386/20		4.59 MIPS
Everex Step 386/20		4.91 MIPS

Power Meter MIPS Version 1.2. The Database Group.



**"We're coming to get you."**

Raymond Li, Kam Chow,  
Anne Russell, Wesley Wong  
Everex Project Engineers



"If you're afraid of monsters, please turn the page."

What makes our new computer unnervingly fast can be explained in three words: write back cache.

Simply put, it means less work: you don't write to the main memory every time you write to the cache.

It's an approach to memory management found only on mainframes and on Everex Step computers.

And in a world where a 32k cache is the norm, ours expands to 256k.

The Step 386. It's a monster of a machine.

Find out more about Step 386 and Step 286 computers. Call 1-800-356-4283.

Everex  
Computer Systems  
Division,  
48431 Milmont  
Drive, Fremont,  
CA 94538.

Circle 97 on Reader Service Card (DEALERS: 98)





A simple experiment proves the point: Write a program that codes a file, giving each character its order in the "new" alphabet. Then use the DOS SORT command to sort some large text file, once for the uncoded version and once for the coded one. I tried it and found no difference in the run time.

Search and sort algorithms are complex and easily misleading. A few moments' thought about how computers work, however, should convince readers

that there is no benefit to reordering our arbitrarily ordered alphabet.

Brad Brown  
Toronto, Ontario, Canada

### Minds vs. Programs

I read with interest the comments made by Shawn Corey (May, page 24) in response to my original letter (January, page 30). I would like the chance to address the issues Mr. Corey raised.

To begin with, he seems to be under

the impression that I am against all research in the field of artificial intelligence (AI). I regret that I may not have made myself clear on this matter, since nothing could be further from the truth. AI research has made significant progress in many areas and added considerably to the body of human knowledge. We have also realized a number of tangible benefits from this research, which in some cases has been in the form of commercial products.

The point I was originally attempting to make was that there are some inherent limits to what AI is capable of realizing, and that these limitations are not technical but philosophical. Researchers in AI need to take a step back from the technical aspects and examine the enormous body of philosophical work pertaining to the nature of conceptual thought and how it relates to physical substance.

That this is necessary is demonstrated by Mr. Corey himself in that he appeals to a philosophical argument drawn from the school of thought known as materialism. Materialism contends that we are essentially "meat machines," and if this were true, his assumption that one day we will invent a "nonmeat machine" capable of conceptual thought would be entirely reasonable.

However, there is an opposing school of thought called, appropriately enough, immaterialism, which is further divided into dualism (the idea that we are "meat puppets") and hylomorphism (the idea that we have a nonmaterial component necessary for conceptual thought but that cannot be separated from the material component; there is no convenient and clever analogy for this one).

The immaterialist school has been held by such philosophical giants as Aristotle, the Stoics, Aquinas, Descartes, Pascal, Locke, Rousseau, Kant, and Hegel. If these thinkers are correct—and one would be obstinate to totally disregard the work of such an august body—then there cannot be a purely mechanical explanation for conceptual thought.

Even without appealing to ancients who are frequently believed to have nothing important to say to our age, I suggest that a number of modern scholars have demonstrated the value of philosophy to AI research. A persuasive argument was put forth by John Searle. This argument is briefly stated as follows:

1. Programs are purely formal (i.e., syntactical).
2. Syntax is neither equivalent to nor sufficient by itself for semantics.

continued

# If you think you can buy a better C compiler, don't. We'll buy it for you.

Buy Let's C<sup>®</sup> with *csd*<sup>™</sup> for just \$75. If you're not satisfied, get Turbo C or QuickC. Free.\*



Why are we making this incredible offer? Because we're absolutely certain Let's C and *csd* C Source Debugger are the best C programming tools you can own.

Rest assured that, like its competition, Let's C features incredibly fast in-memory compilation and produces extremely tight, high quality code. The differences lie in how much faster you can perform other programming chores.

Our debugger, for example, can cut development time in half. But that's not all:

*"csd is close to the ideal debugging environment... a definite aid to learning C and an indispensable tool for program development."*

—William G. Wong, BYTE

And comparatively speaking: *"No debugger is included in the Turbo C package... a serious shortcoming."*

—Michael Abrash, Programmer's Journal

Unlike our competition, Let's C includes its own full-featured assembler, features documentation with complete examples and technical support with complete answers—the first time you call.

#### LET'S C:

- Now compiles twice as fast
- Integrated edit-compile cycle editor automatically points to errors
- Includes both small and large memory model
- Integrated environment or command line interface
- 8087 sensing and support

#### LET'S C AND *csd* FEATURES

- Full UNIX compatibility and complete libraries
- Many powerful utilities including make assembler, archiver
- MicroMACS full screen editor with source code included
- Supported by dozens of third party libraries

#### *csd*:

- Debug in C source code, not assembler
- Provides separate source, evaluation program and history windows
- Ability to set trace points and monitor variables
- Can interactively evaluate any C expression
- Can create any C function in your program
- Trace back function

So if you're thinking about buying any other C compiler, think again. But this offer is only available for a limited time. So think fast. And see your software dealer or call 1-800-MWC-1700 soon. (1-312-689-2300 in Illinois.)

To exchange Let's C and *csd* for Turbo C or QuickC, return registration card within 15 days of purchase date, notify Mark Williams Company that you are returning products and receive a return authorization number. Products must be returned within 30 days of purchase date or within 30 days of shipping date on telephone orders.

 Mark Williams Company

601 North Skokie Highway, Lake Bluff, Illinois 60044, 312-689-2300

## An Ounce of Innovation is Worth a Pound of Code.

As well as being an expert system tool, Intelligence/Compiler is a very high level language. Programs written in it are 20 to 50 times shorter than typical database or programming languages, and a lot more intelligent.

## Expert Systems as High Level Programming Tools.

Intelligence/Compiler gives you unprecedented power, flexibility and ease of use for building intelligent applications.

It is the first and only intelligent database system to uniformly combine logic programming, object oriented programming and intelligent interfaces.

**“Intelligence/Compiler is an excellent product. Its unique and advanced features have proven extremely effective in our financial applications.”**  
Dr. Barry Glasglow, Vice President and Ms Elizabeth Graham, Knowledge Engineer, Shearson Lehman Hutton.

**“After comparing many shells for the US Department of Transportation, we chose the Intelligence/Compiler. It was clearly the best choice.”**  
Dr. Jeffrey Dillingham, Vice President, Off-Shore Technology Corporation.

**“The Intelligence/Compiler’s combination of rule-based programming and frame-based representation makes it a powerful state-of-the-art system for advanced real-world applications. Its intelligent editing and debugging facilities are a bonus.”**  
Review in AI Expert Magazine, February 1988.

**“The Intelligence/Compiler tutorial is so well done that it should be released as a separate product. The development environment can save huge amounts of time otherwise spent on debugging.”**  
Review in Computer Language Magazine, March 1987.

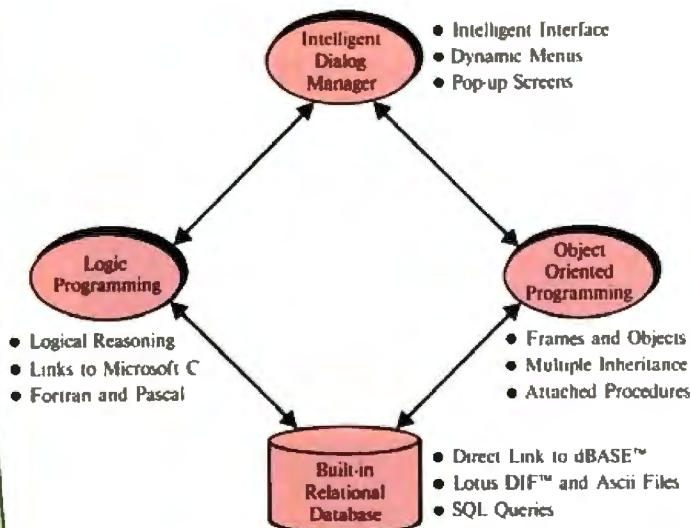

## An Open Architecture for Open Minds

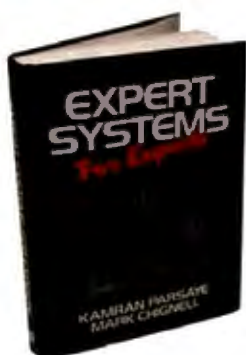

The underlying technology of Intelligence/Compiler is so outstanding, we have written a book about it. It is being used in many leading universities as the standard text book. Ask for the book "Expert Systems for Experts" by K. Parsaye and M. Chignell, published by John Wiley, at your local book store.

## Painless Application Development

Don't look any further. Intelligence/Compiler is the tool you need to build royalty free applications. Find out how easy and painless it is to build intelligent applications, now!

# IntelligenceWare, Inc.

Leading in Artificial Intelligence Applications™

Circle 129 on Reader Service Card

### YES! I WANT TO DEVELOP INTELLIGENT APPLICATIONS FAST.

Rush me \_\_\_ copies of Intelligence/Compiler at \$490 each.

Name: \_\_\_\_\_

Company: \_\_\_\_\_

Address: \_\_\_\_\_

Telephone: \_\_\_\_\_

Check or Money order is enclosed.

Visa  Mastercard  AMX

Number: \_\_\_\_\_

Expiration Date: \_\_\_\_\_

Shipping and handling: US: \$9.00, Canada/Hawaii Air: \$20.00, Overseas Air: \$50.00. California residents please add 6.5% tax.

System Requirements: IBM PC, PC/XT, PC/AT or PS2 with 640K memory.

Please send coupon to:  
IntelligenceWare, Inc.  
9800 S. Sepulveda Blvd. Suite 730,  
Los Angeles, CA 90045.  
FAX: (213) 417-8897.  
Telephone: (213) 417-8896.

POSITIVE INTELLIGENCE



3. Minds have mental contents (i.e., semantic contents).

**Conclusion:** Having a program—a program by itself—is neither sufficient for nor equivalent to having a mind.

Mr. Searle is, I believe, a materialist, and therefore he's likely to contend that some kind of machine can—in principle—be built that is capable of conceptual thought. However, his argument with respect to computers is difficult to refute. I

would again suggest that those involved in AI research make every effort to examine the body of philosophical work pertaining to their subject in order to discover what the most fruitful avenues of their research will be.

Marin David Condic  
Parsippany, NJ

**Nonrecurrent Steps**

I am writing to correct an error in Gary Bricault's article ("Juggling Multiple

Processes," May). The article introduces five operations in a code fragment:

- (S1)  $x := y + z;$
- (S2)  $a := (b + 3) * c;$
- (S3)  $d := e * a;$
- (S4)  $w := d - x;$
- (S5)  $\text{writeln}(d, w);$

Clearly, S4 cannot execute until S3 has completed, since S4 requires a value for d, which is calculated by S3. Bernstein's second requirement— $0(S_i) \cap 1(S_j) = \{\}$ —leads to the same conclusion. The output of S3 = {d}; the input of S4 = {d,x}, and the intersection of these sets is not null.

Thus, S3 and S4 cannot be concurrent. However, Mr. Bricault's precedence diagram (figure 3, page 317) for this code fragment incorrectly shows S4 as concurrent with S3. The correct diagram is as follows:

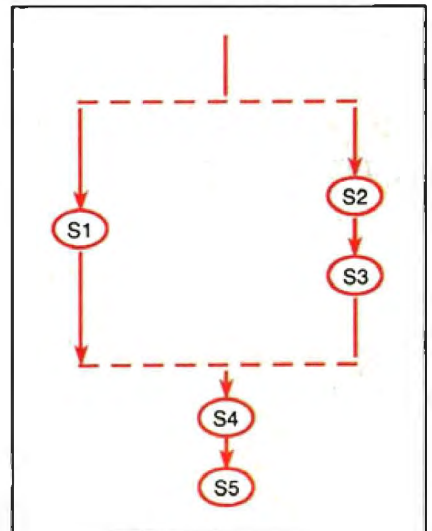

Charles E. M. Dunlop  
Yellow Springs, OH

**FIXES**

• Megahertz Corp. alerted us to some incorrect information that we published in our July 1988 Short Take of the Easy-Talk board.

The list price of the board is \$999.95. It runs on the Toshiba T3100 in addition to the T1100 Plus and the T1200.

After our July issue went to press, the company moved to 4505 South Wasatch Blvd., Salt Lake City, UT 84124, (801) 272-6000.

• The price of Spot from Flagstaff Engineering (Computing at Chaos Manor, August, page 108) should be \$995.

**WHY SETTLE FOR THIS?...**

$$\int_{-\infty}^{\infty} \frac{y \cdot z}{x - tY} dt = \sum_{i=1}^n \frac{(x^4 - i)^3}{\sqrt{z^3 + y^{10}}} \frac{5}{z - x^5 Y}$$

**...WHEN WHAT YOU REALLY WANT IS THIS.**

$$\int_{-\infty}^{\infty} \frac{Xy \cdot Z}{X - tY} dt = \sum_{i=1}^n \left( \frac{(x^4 - i)^3}{\sqrt{z^3 + y^{10}}} \frac{5}{z - x^5 Y} \right)$$

**TRY THIS:**



Quality work should look high-quality. What better reason to try **pcTEX**—the full implementation of Prof. D. Knuth's revolutionary **TEX** formatting/typesetting program.

**pcTEX** offers professional typesetting capabilities & advantages to PC users. It gives you control—of format, type, symbols, quality—for complex mathematical &

To order or for information, call: **415/388-8853** or write: Personal **TEX**, Inc. 12 Madrona Avenue Mill Valley, CA 94941 USA

pcTEX is a registered TM of Personal TEX, Inc. TEX is an American Mathematical Society TM. Manufacturer's product names are those TM's.

engineering material, statistical tables or straight matter.

So whether you're writing the next starshot manual or a thesis on relativity, you get camera/publisher-ready manuscripts to be proud of, quick & simple. Don't settle for less.

From Personal **TEX**, Inc., starting at \$249; VISA/MC welcome. Satisfaction guaranteed.

**pcTEX FORMATTING/TYPESSETTING SYSTEM** • FINE TYPESET QUALITY from dot matrix or laser printers, or phototypesetters • A COMPLETE PRODUCT. Includes • our specially written **pcTEX** Manual that lets you use **TEX** immediately • custom 'macro package' formats for letters, manuals, technical documents, etc • the **LaTEX** document preparation system (with user's manual) macro package for article, book, report preparation • **AMS-TEX**, developed by the American Mathematical Society for professional mathematical typesetting • **OUTPUT DEVICE DRIVERS** available for Epson FX, LG • Toshiba • HP LaserJet Series • Apple LaserWriter • Screen preview, with EGA, VGA or Hercules card

• **REQUIRES:** IBM PC/XT, AT or compatible, DOS 2.0 or higher & 512K RAM, hard disk for printer drivers & fonts

This ad is typeset & composed using **pcTEX**, **Bitstream** fonts & laser printer. Logos and black backgrounds done photographically.

# Accelerate.





# Now there's room for everyone on the fast track.

Compaq introduces the best  
of 80386 technology  
for every computer user.

*The new 16-MHz  
COMPAQ  
DESKPRO 386S*



*The 16-MHz  
COMPAQ  
DESKPRO 386*



When Compaq pioneered high-performance personal computing and introduced the industry's first 32-bit PC's based on the Intel® 386\* chip, we gave performance-hungry business users, engineers, analysts and software developers the tools they needed to run complex applications faster and better.



The 20-MHz  
COMPAQ  
DESKPRO 386/20

The new 25-MHz  
COMPAQ  
DESKPRO 386/25

Now, we're introducing the new COMPAQ DESKPRO 386S and COMPAQ DESKPRO 386/25. And extending our high-performance 80386 line in both directions. To meet the increasing demands of today's general business users *and* to provide our power users with more power than ever. So *everyone* can enjoy the speed and future capabilities of 80386 computing.

In each COMPAQ 80386 PC, our exclusive design lets every component operate at optimum speed. Giving COMPAQ personal computers a considerable edge in system performance, ensuring compatibility with industry-standard software and hardware, and providing what may well be the ultimate in connectivity for

high-performance,  
network environments.

The new COMPAQ DESKPRO 386S is the first personal computer designed specifically to let general business PC users head straight for the performance and potential of 80386 personal computing.

For more advanced applications, the original COMPAQ DESKPRO 386 and the COMPAQ DESKPRO 386/20 deliver even higher levels of performance.

And now at the top of our line is the COMPAQ DESKPRO 386/25. The most powerful personal computer available.

With our two newest machines, we're not just pushing 80386 technology forward; we're *widening* it. To let every personal computer user take advantage of everything COMPAQ 80386 power has to offer.

**COMPAQ**

It simply works better.



Now, breakthrough technology from Compaq brings the power and potential of 80386-based personal computing to millions of business PC users. The first personal computer powered by the new Intel 386SX\* microprocessor, the new COMPAQ DESKPRO 386S is designed specifically as an affordable, high-performance alternative to 80286-based PC's.

Surrounding its revolutionary microprocessor are high-performance components and a 32-bit architecture that run your current software up to *60% faster* than most 10-MHz 80286 PC's. Plus give you the power to run 32-bit software that 80286 PC's won't run at all. And exciting new multi-tasking software such as

Microsoft® Operating System/2 from Compaq and Microsoft Windows/386.

With its sleek, "small footprint" design, the COMPAQ DESKPRO 386S takes up far less room than its competition.

But it gives you room for four internal storage devices.





So you can easily tailor it to your exact needs. Choose from fast 20-, 40-, and 110-Megabyte Fixed Disk Drive options; 5¼-inch and 3½-inch diskette drives; even tape backup options.

We give you one full megabyte of high-speed memory standard. And you can expand to 13 megabytes *without* using an expansion slot. This will

come in handy when you're ready to thoroughly exploit the MS® OS/2 operating system and advanced 80386 business software.

We even built features like advanced VGA graphics and standard interfaces for a mouse, printers and other peripherals into the system. This saves your slots for modems, network boards and much more.

You'll also find two more standard features: the same sophisticated engineering and uncompromising quality that set all COMPAQ 80386 computers apart. So head for the performance you really need for today's applications. And the 80386 potential you'll need for tomorrow's. With the new COMPAQ DESKPRO 386s.



# Get into the passing lane.

Introducing the COMPAQ DESKPRO 386s.  
New technology delivers affordable 80386 performance  
for anyone considering 80286 PC's.

**COMPAQ**

---

It simply works better.





Once again, Compaq introduces a personal computer that leaves every other PC in the dust. With its unsurpassed Intel 25-MHz 386\* microprocessor, exclusive COMPAQ Flexible Advanced Systems Architecture, and up to 1.2 gigabytes of storage, the new COMPAQ DESKPRO 386/25 is the ultimate expression of 80386 technology.

Its FLEX Architecture uses separate memory and peripheral buses operating in concert to reach maximum system performance, while maintaining compatibility with industry-standard hardware and software. By splitting

the work, they also prevent information bottlenecks in the system. The 25-MHz cache memory controller keeps data instantly accessible, and that lets the processor tear through applications with 0 wait states 95% of the time.

All this translates into performance that's up to 60% faster than most 20-MHz 80386-based PC's.

And, with the optional Intel 387\* or Weitek™ coprocessor, you'll even be able to match the numeric processing power of a dedicated engineering workstation at a fraction of the cost.





# Now, fasten your seat belt.

Introducing the 25-MHz COMPAQ DESKPRO 386/25.  
The most powerful personal computer available.

You can go from one megabyte of standard, high-speed memory all the way to 16 megabytes. And for storage-hungry applications, such as networks using disk fault tolerance and multi-user systems, the COMPAQ DESKPRO 386/25, with two optional COMPAQ 300-/600-Megabyte Fixed Disk Drive Expansion Units, is able to provide up to a massive 1.2 gigabytes of high-performance storage. With an average access time as low as 20 milliseconds.

Of course, we give you a choice of 5<sup>1</sup>/<sub>4</sub>" or 3<sup>1</sup>/<sub>2</sub>" diskette drives and high-capacity tape backup options.

For sophisticated PC users who require the ultimate in power, compatibility, connectivity and overall system performance, no other personal computer comes close to the new COMPAQ DESKPRO 386/25.

It's simply the most powerful personal computer available. But then, that's what Compaq users have come to expect. Again and again and again.

**COMPAQ**

---

It simply works better.



# Full speed ahead

Next to high performance, the advantage of COMPAQ 80386 computing is compatibility with both today's and tomorrow's software. From MS-DOS® to the exciting new MS OS/2 operating system. And beyond.

Thanks to a close and longstanding working relationship between Compaq and the industry's independent software developers, the COMPAQ line of 80386 personal computers is especially capable of letting you tap the full potential of all the new multitasking software.

You'll run MS-DOS 3.3, plus MS OS/2, Microsoft Windows/386, XENIX®, UNIX® and the thousands of applications written for them. And with any computer from the COMPAQ 80386 line, you'll run them all *faster*.

Take one for a quick spin and you'll see why COMPAQ computers earn unsurpassed satisfaction ratings from users and industry experts. For the location of the nearest Authorized COMPAQ Computer Dealer or for more details, call 1-800-231-0900. Ask for Operator 63. In Canada, call 1-800-263-5868, Operator 63.

COMPAQ® and COMPAQ DESKPRO 386® are trademarks of Compaq Computer Corporation. Microsoft®, MS-DOS®, XENIX® and MS® are trademarks of Microsoft Corporation. MS® OS/2 and MS® Windows/386 are products of Microsoft Corporation. Product names mentioned herein may be trademarks and/or registered trademarks of their respective companies. \*Registered U.S. Patent and Trademark Office. COMPAQ DESKPRO 386/25 graphics ©1988 Access Software, Inc. ©1988 Compaq Computer Corporation. All rights reserved.

\*Hereafter referred to as 80386SX, 80386 and 80387 respectively.

**COMPAQ**

It simply works better.

# CHAOS MANOR MAIL

*Jerry Pournelle answers questions about his column  
and related computer topics*

## **BASIC Pilgrimage**

Dear Jerry,

I was amused by your comments concerning Turbo Basic from Borland International. When some things didn't work as you expected, you patiently read the manual and went on to declare the product a "success." In contrast, however, you couldn't be bothered with reading the manual when doing a previous review of True BASIC and went on to declare the product a failure, referring to it as "True Madness."

Now that Microsoft has just released QuickBASIC 4.0, I expect you'll soon be raving about its separately compiled program modules, calling them an "exciting development in BASIC programming." Of course, the program modules available in version 2.0 of True BASIC for the past 12 months "just don't seem like BASIC and will never be accepted by users of GWBASIC."

Have you noticed that each new version of QuickBASIC looks more and more like True BASIC and less and less like GWBASIC? The very features you condemn in True BASIC are being copied into QuickBASIC and Turbo Basic—the ANSI BASIC standards. (Thomas Kurtz of True BASIC and Dartmouth College served as chairman of the standards committee.) Whether you like it or not, Kemeny and Kurtz are dramatically changing the language. You detest their influence while unwittingly praising Turbo Basic and QuickBASIC for copying most of the ANSI standards.

In 1985, Apple Computer came very close to releasing MacBASIC, which included many features similar to True BASIC. The language was developed by Apple's own software engineers. However, according to the *Wall Street Journal* (September 25, 1987), Apple president John Sculley killed MacBASIC and signed over the rights to the MacBASIC name when Microsoft's Bill Gates demanded the product be withdrawn and threatened to cut off Apple's license to use Microsoft's program for the company's best-selling Apple II machine. Several of Apple's key software engi-

neers resigned in disgust. The *Journal* quoted an Apple employee as saying, "He insisted that Apple withdraw what was an exceptional product. He held the gun to our head."

Sybex Publishing actually released a book on the MacBASIC language—a book that suddenly had no market. Tell me, is Mr. Gates a man we should all admire and hero-worship?

Alan F. Tomala  
St. Clair Shores, MI

*Well, to begin with, True BASIC had all the defects of a compiled language without the speed and convenience; it "compiled" into p-code and interpreted that. Why would anyone want to do that? Turbo and QuickBASIC compile into stand-alone code that you can give your friends or sell for jujubes.*

*I will also admit that the name True BASIC and the arrogant letters denouncing "street BASIC" that accompanied it had a good bit to do with the attitude with which I approached True BASIC.*

*And whether you like it or not, the marketplace seems to have accepted Turbo Basic and QuickBASIC.*

*I hadn't heard the story about Apple and Bill Gates. I must have missed that issue of the Journal.—Jerry*

## **Proof Positive**

Dear Jerry,

Once again, I take keyboard in hand to perpetrate correspondence. You often wonder if you have any effect on the computer industry. You do. I offer the following as proof.

Some months ago, you reviewed the NEC MultiSync monitor. Your main complaint was that the adjustments were completely automated. (I'll pass over

*continued*

*Jerry Pournelle holds a doctorate in psychology and is a science fiction writer who also earns a comfortable living writing about computers present and future. He can be reached c/o BYTE, One Phoenix Mill Lane, Peterborough, NH 03458, or on BIX as "jerryip."*

Circle 29 on Reader Service Card  
**Three ways to build  
better Turbo Pascal  
programs...**

**NEW! POWER  
SCREEN  
\$129**

Screen I/O manager.

Features: • screen painter • virtual screens  
• data validation • context sensitive help  
• unlimited screens • definable keys  
• & much more!

**POWER TOOLS  
PLUS  
\$129**

Full featured function library.

Features: • TSR support • direct video  
access • VGA and EGA support • windows  
and menus • DOS memory allocation  
• interrupt service routines  
• & much more!

**ASYNCH  
PLUS  
\$129**

Asynchronous communication manager.

Features: • speeds to 19.2K baud  
• XON/XOFF protocol • hardware  
handshaking • XModem file transfer • I/O  
buffers up to 64K • & much more!

We're Blaise Computing, manufacturers of high quality function libraries designed to reduce the time and technical expertise required for serious applications development.

All of these packages include Peter Norton's On-line Instant Access Program, a comprehensive user reference manual with extensive examples, and full sample programs.

Satisfaction guaranteed or return within 30 days for a full refund.

We have a full line of products for C and Pascal. For a free brochure or to order call

**800-333-8087!**

**BLAISE COMPUTING INC.**

2560 Ninth Street, Suite 316 Berkeley, CA 94710 (415) 540-5441  
SEPTEMBER 1988 • B Y T E 33



# db\_VISTA III™

## Database Development System



### The db\_VISTA III Difference

Continuous High Performance

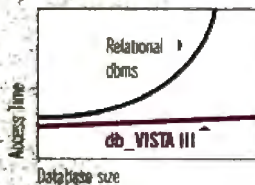

Consistent Development Schedules

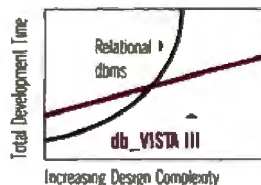

# db\_VISTA III takes your C programs as far as you dare to go.

Powerful applications require powerful tools. That's the idea behind db\_VISTA III from Raima. db\_VISTA III gives you powerful, high performance DBMS capabilities in any environment—VMS, ULTRIX, UNIX, XENIX, OS/2, DOS and Macintosh.

Our combination of a network model database, B-tree indexing, and SQL-based relational query, provide a superior system for data organization, manipulation and access.

db\_VISTA III comes from a proven mainframe DBMS design. Because db\_VISTA III is written in C for portability, we deliver this same power to minis and PCs.

**The best of both worlds... network performance and relational flexibility.**

db\_VISTA III is a network model database. SQL-based db\_QUERY is a rela-

tional interface. You can redesign existing databases with db\_REWISE. An interface to Lotus 1-2-3 worksheets is also available.

For more information or to order call **800-327-2462** or **(206)828-4636**. Find out how you can go as far as you dare.

## The Raima db\_VISTA III Database Development System Technical Information:

All components feature royalty-free run-time distribution, full source code availability and our commitment to customer service. That's why corporations like ARCO, AT&T, Hewlett-Packard, IBM, Northwestern Mutual Life, UNISYS and others use db\_VISTA III.

### 1. db\_VISTA: The High Performance DBMS

- ▶ Multi-user support
- ▶ Multiple database access
- ▶ Record and file locking
- ▶ Automatic database recovery
- ▶ Transaction processing/logging
- ▶ Timestamping
- ▶ Database consistency check
- ▶ Fast database access
  - network model database
  - B-tree indexing
  - Virtual memory disk caching
- ▶ An easy-to-use interactive database access program
- ▶ File transfer program for importing/exporting ASCII
- ▶ A Database Definition Language patterned after C

### 2. db\_QUERY: The SQL-based Query.

- ▶ Relational interface to db\_VISTA databases
- ▶ C linkable or stand-alone usage.
- ▶ Embed queries or run ad-hoc queries

### 3. db\_REVERSE: The Database Restructure Program.

- ▶ Redesign your database easily
- ▶ Converts all existing data to reversed design
- ▶ Send customized db\_REVERSE to end user locations for easy upgrades

### 4. WKS Library for Lotus 1-2-3.

- ▶ C-linkable interface to Lotus files
- ▶ Reads and writes WKS, WK1 Work sheets and dbf files
- ▶ Control 1-2-3 from inside your C program
- ▶ Use 1-2-3 as data entry and report screens

### Operating Systems:

- ▶ VMS, ULTRIX, UNIX, XENIX, OS/2, DOS and Macintosh

### C Compilers:

- ▶ VAX, UNIX, XENIX, Microsoft, Lattice, Turbo C, MPW, and LightspeedC

### LAN systems:

- ▶ Lattice, NetWare, PC Network, 3Com, and other NET-BIOS compatible networks

## 1-800-db-RAIMA (1-800-327-2462)

In Washington State call: (206) 828-4636  
 In Texas call: (214) 239-3267  
 In the U.K. call: (0992) 500919  
 In Germany call: 07127/5244  
 In Switzerland call: 01 725 04 10  
 In France call: (1) 46 09 28 28  
 In Belgium call: (02) 720.96.57  
 In Benelux Countries call: +31(2159)46 814

3055 112th Ave. N.E. #100, Bellevue, WA 98004 USA  
 Telex: 6503018237 MCI UW FAX: (206) 828-3131



# RAIMA™

© 1988 Raima Corporation

BY98

your gripe about the size of the screen. Maybe you should consider hooking your current word processor to a projection TV set.) The new MultiSync II has a full set of manual controls. Except for the mode selectors, everything is handily located under a door in front.

Also, I would like to enter a comment on your taste in text editors. You prefer WordPerfect because it is "transparent." I would call it "invisible." Admittedly, I cut my teeth on WordStar 3.31. Further, I actually like WordStar. Maybe that implies something about my sanity, but at least my old faithful has a useful help facility. WordPerfect does not. If you ever lose that blasted keyboard template, you may as well buy a supply of goose quills.

WordPerfect's on-screen "help" comes in two flavors; you either specify the key with which you want help or give the initial letter of the function you want. This assumes you know what the various keys do and at what level of shift they do it. The "organization" of the function keys might best be described as anti-mnemonic. (WordStar, at least, groups similar operations under the same Control-key menu.) Finding the letter that will call up help for a specific operation is mostly luck. It took me two tries before I could find the command to exit a file. Even DisplayWrite, a program widely regarded as the joke of the industry, has an index of help screens. If WordPerfect has such a feature, it is well hidden.

Finally, how can anyone with your notoriously poor vision even use that blasted template? My optometrist whistles in awe whenever I bring him my new lens prescription, but I don't need an oversize monitor. What I do need is a blowup of the template.

If you insist on a transparent editor with automatic paragraph reformat, try PC-Write 2.71. It is faster, much more helpful, and does windows. Its worst feature is its documentation, which tends toward the dense side of understandable. If I could find a book on PC-Write that's half as good as Arthur Naiman's book on WordStar, I would switch in a minute.

Bryan Edenfield  
 Allendale, SC

*One thing that isn't generally known: when Art Naiman wrote his excellent book on WordStar, he used WRITE, the text editor I used for so many years.*

—Jerry

### BRIEFly Speaking

Dear Jerry,

Last year, you casually mentioned that you have problems running BRIEF with

SideKick and SuperKey ("In the Chips," September 1987).

We recently started using BRIEF here in the office, and we had similar problems. We tried to run BRIEF with SuperKey and our own memory-resident software and found that the machine locked up just as you described. We were using an IBM PC AT with 3 megabytes of memory.

Our solution was to set two switches when starting BRIEF. We set -k (lower-case, no numbers) and the -p (lower-case). The first is a keyboard-compatibility switch. It's odd to have to set this when using a true IBM machine, but it seems that these memory-resident programs hang off the keyboard interrupt and can affect timings.

The second switch is a video-page-compatibility toggle. Apparently, BRIEF uses the second video page to display text, and if some software doesn't support multiple video pages (such as SideKick or SuperKey), this can cause problems.

After setting these switches, we have experienced no problems in running BRIEF.

Terence J. Griffin  
 Washington, DC

*I find I don't need the power of BRIEF, and I've gone over to the Logitech Point editor for most of my programming. If I worked at programming full-time, I'd reconsider, but BRIEF had just enough commands that I'd keep forgetting them, while Point is totally intuitive.*—Jerry

### Avoiding Custom Programming

Dear Jerry,

At my law office, we had a very large relational database written in dBASE III. But we had to change it all the time because the attorneys and the judges would always be asking for new reports that had not been set up previously. We ran into custom programming costs because dBASE III is too difficult for ad hoc queries and custom reports to be designed by the secretaries and the data entry-level people.

So, we rewrote the entire system in Paradox. Now data entry and secretarial personnel can create ad hoc queries and custom reports with minimal time from our high-priced computing consultant. This saved us money. I thought you'd like to know.

Daniel J. Ashley  
 Chicago, IL

*I did want to know, and thank you for telling me.*—Jerry ■



# National Design

## CAN THIS BE DONE?

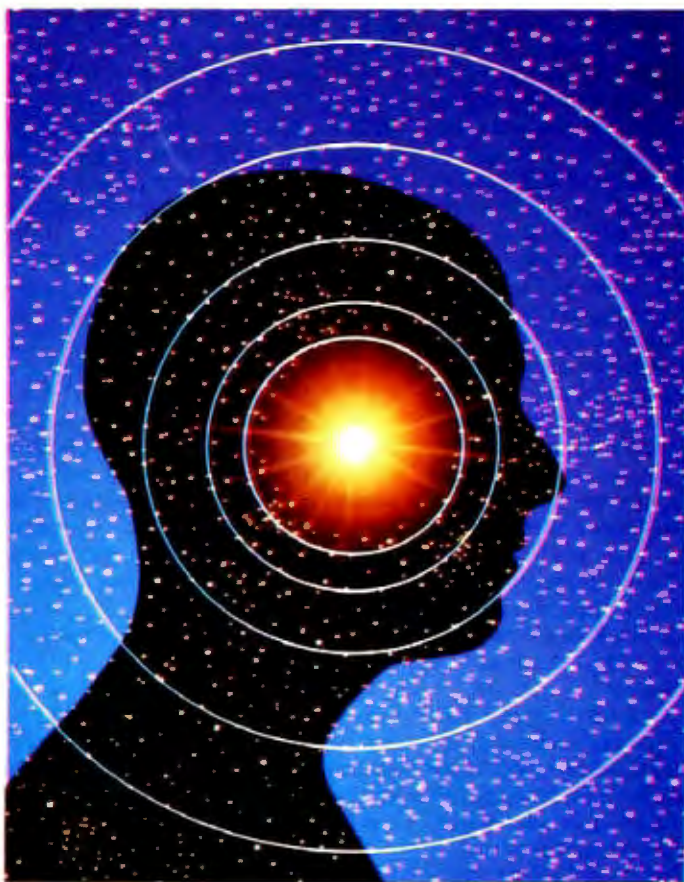

A COMMUNICATION  
DEVICE FOR THE  
SPEECH - DEAF

EXECUTIVE AUDIAL  
REHABILITATION  
SOCIETY....

the EARS design competition

FIRST PRIZE - \$100,000  
PLUS A % OF ROYALTY

SECOND PRIZE - \$50,000  
PLUS A % OF ROYALTY

THIRD PRIZE - \$25,000  
PLUS A % OF ROYALTY

## EXECUTIVE AUDIAL REHABILITATION SOCIETY

500 AMERICAN BANK TOWER P. O. Box 2703 CORPUS CHRISTI, TEXAS 78475  
(512)882-6557

### JUDGES COMMITTEE

JACK S. KILBY, Dallas, Texas, Electronics Engineer  
HOWARD H. ARNOLD, Lewisville, North Carolina, Electronics Engineer  
JAMES S. NEWCOMB, St. Paul, Minnesota, Electronics Engineer  
HUBERT W. UPTON, Arlington, Texas, Electronics Engineer — Alternate  
PROFESSOR HUGH TOMLINSON, Corpus Christi, Texas — Coordinator

### WINNERS 1986 SUGGESTION CONTEST

MILDRED CRUICKSHANK, Telephone connection  
ED POTTHARST, Multichannel memory



# Competition

## WE THINK YOU CAN!

**T**HERE ARE 17,000,000 speech-deaf persons, i.e. do not understand speech, in the U.S. The objective is to provide a communication device that will allow one-on-one communication. The final EARS design, incorporating all possible operational advantages and economies of production, may be the composite of the prize winners' designs and may also incorporate features of the designs submitted by non-prize winners. Winners will be accorded cash and royalties. **All royalties negotiated by EARS will be passed through to the contestants.** The royalties will be apportioned by the Judges on the basis of their evaluation of the importance of each element submitted by any contestant which is included in the Final Production Design.

Those desiring to participate should apply (by mail or phone) for a registered entry blank to the Executive Audial Rehabilitation Society shown. Each entry shall include design, programming instruction and an operating "bread board" model which need not conform to the size goals. EARS will compensate those contestants (whose entries are adjudged to be operationally feasible) for the current cost of the components used to build the bread board operational model. The entries will be evaluated by the Judges on the basis of merit, i.e. operationally effective that can be produced at a reasonable cost.

**Detailed conditions of the competition will be set out on the entry form. DEADLINES: Entry forms must be procured and returned to EARS not later than October 31, 1988. Designs and bread board models must be received by 5 P.M. on May 1, 1989.**

All designs submitted and accepted by the Judges shall be the property of EARS. No essential conceptual element of a design shall constitute a conflict with an existing patent. Conceptual protection of the device has been established as of date of origin. Formal application for patents on pertinent features will be applied for by EARS. A firm of patent attorneys specializing in electronics is retained. All decisions by the Judges as to the award or non-award of prizes or royalty shall be final and shall not be subject to change, review or amendment by EARS., its Officers, Executive Committee or the design contestants.

### DESIGN GOALS

**1** The goal is a design for a hand-held, lightweight real time communication device capable of being produced at economical cost. The design should allow a speaking person to communicate on a one-on-one real time basis with the hearing-impaired person in any situation where normal conversation occurs and will provide for filtration of extraneous noise. The goal is a device contained in approximately 6" x 8" x 1½". A 5" x 7" screen will be on one side. The speech-deaf person can place it on a desk or hold it in hand. The speaker will first read a text identifying his phonetic alphabet in the memory. A multi-position switch would allow storage of the phonetic alphabets of different persons. For telephone calls, the speech of a person (whose phonetic alphabet is in one of the memory channels or who reads the text into a new channel) will enter the communication device through a standard telephone plug. The device will be battery-powered with rechargeable batteries but provide for alternative operation with a voltage converter. Intensive electronic speech analysis combined with the personal phonetic alphabet of the speaker will result in the "real-time" production of the spoken words on the screen. The speech of the hearing-impaired person not fitting the phonetic alphabet of the memory should be filtered out automatically if possible, otherwise manually.

**2** Equally important is a design for this device that can be manufactured economically so that the cost is within the means of this group of people, many of whom may be economically disadvantaged.



# ASK BYTE

*Circuit Cellar's Steve Ciarcia answers your questions on microcomputing*

## Clipped by Clipper

Dear Steve,

I have a problem with my Clipper application, but perhaps it's a general problem. I can't find any way to access more than 15 files in my application because of the restrictions of MS-DOS. I think the only way I can solve this problem is to open another process, but maybe you could suggest something else.

Michael Stöckel  
Berlin, Germany

*Your problem is not so much a restriction of MS-DOS as it is a configuration problem.*

*Examine the contents of your CONFIG.SYS file if you have one. It should be in the root directory of whatever disk you boot the computer from (if not, add this file with the following). See if there is a FILES=?? statement, where ?? is a number that indicates the maximum number of files any application can have open at one time. You can increase this number to whatever you like, but each open file takes some memory, so the sky is not the limit. You should also add a BUFFERS=?? statement to speed processing if you have lots of open files. However, remember that all this takes memory, and if Clipper takes too much to allow more open files, then you're stuck because of Clipper, not MS-DOS.*

*Set the number of files and buffers to the smallest value that accommodates your requirements. Typically, 20 is a good number. All this is listed in the MS-DOS manual in greater detail.—Steve*

## Seeing Digital

Dear Steve,

Since June of 1987 I have been considering purchasing a digitizer/transmitter and receiver system for several small systems that I deal with on a regular basis. The unfortunate part of the whole thing is that all I know of how the system works is what I could catch up to in the June 1987 Circuit Cellar.

What I'm looking for is a total run-down on the system, including both its good points and bad points. I plan on set-

ting up a series of these in external cases and using my own telecommunications network. Would you be willing to give me some information on this system and your own thoughts on how it can be applied?

Jason S. Beam  
Saco, ME

*The definitive works on the ImageWise video digitizing system are in "Build a Gray-Scale Video Digitizer," Parts 1 and 2 (May and June 1987). The two subsequent articles ("Using the ImageWise Video Digitizer," Parts 1 and 2, July and August 1987) went into some depth on applications for the hardware, featuring some image processing and colorization*

*IN ASK BYTE, Steve Ciarcia, a computer consultant and electronics engineer, answers questions on any area of microcomputing and his Circuit Cellar projects. The most representative questions will be answered and published. Send your inquiry to*

Ask BYTE  
One Phoenix Mill Lane  
Peterborough, NH 03458

*Due to the high volume of inquiries, we cannot guarantee a personal reply. All letters and photographs become the property of Steve Ciarcia and cannot be returned.*

*The Ask BYTE staff includes manager Harv Weiner and researchers Eric Albert, Tom Cantrell, Bill Curlew, Ken Davidson, Jeannette Dojan, Jon Elson, Frank Kuechmann, Tim McDonough, Edward Nisley, Dick Sawyer, Robert Stek, and Mark Voorhees.*

*programs that demonstrated how to write a software interface to the boards.*

*For your telecommunications applications, you'll need to think about transmission time and hardware control problems. The transmitter uses run-length encoding to reduce the volume of data, but you'll still have about 30K to 40K bytes for each image. Transmitting an uncompressed 62K-byte image at 1200 bits per second can take up to 9 minutes.*

*The transmitter and receiver will work*

*when connected together, either directly or through modems, but you'll probably need to use a computer at each end to handle dialing, selecting options, and so forth. We've used BCC-52s and BCC-180s, as well as ordinary PCs and ATs, with success. Teaming a BCC-180 with a 9600-bps modem gives you quite a bit of power. This is exactly what I have done in a subsequent ImageWise project in the fifth issue of Circuit Cellar Ink magazine. There are some sample programs and images on the Circuit Cellar bulletin board system (BBS) that may be of some use. Give it a call at (203) 871-1988 and see what we've got for you.—Steve*

## Teaching an Old Board New Tricks

Dear Steve,

Upgrading to a new system (from an IBM PC to an AT, or from an AT to an 80386 system) costs not only the purchase price of the new system, but also the replacement cost for the boards. Could you design an adapter so that old PC boards would fit into an AT bus or so that PC or AT boards fit into a Micro Channel bus? Are such adapters already being marketed?

James P. Eshleman Jr.  
Philadelphia, PA

*Using your old PC 8-bit expansion boards in the AT bus is just a matter of plugging them into any available expansion slot. Actually, ATs and all the clones I know of provide 8-bit slots for video cards, serial ports, parallel ports, and so on, but 8-bit cards will work in any AT expansion slot. Of course, 8-bit memory-expansion cards won't be of much use, and while it would be possible to design an adapter, the result would be slot performance at a high price. You could also use the PC XT 8-bit hard disk drive controllers in an AT, but the 16-bit controllers are considerably faster and worth the extra money for most people.*

*Adapting PC or AT cards to the Micro Channel is another story, however. There are system requirements built into the Micro Channel architecture that*

*continued*

# DECLARATION of INDEPENDENCE

**in'de-pen'dent** (in'di-pen'dent) *adj.* 1. not influenced by others in opinion, conduct, etc. 2. not affiliated; sovereign in authority. *-n.* (in'de-pen-dence) someone or something independent.

**FACT:**  
Many major dealers specializing in programming tools for personal computers are legal affiliates of companies who also publish development software.

**FACT:**  
Programmer's Connection is *not* a publisher and is *not* affiliated to any company that has ever been in the business of publishing software.

When you come to Programmer's Connection, you'll find our knowledgeable, non-commissioned salespeople and technical consultants will give you an unbiased look at the products we carry.

Please join us in our Declaration of Independence. Call Programmer's Connection today and be sure to ask for your FREE subscription to the Connection, our 120 page comprehensive buyer's guide. It contains descriptions for over 750 products by more than 250 manufacturers, and informative articles by leaders in the programming industry.

CALL for Products Not Listed Here  
**USA..... 800-336-1166**

Canada..... 800-225-1166  
Ohio & Alaska (Collect)..... 216-494-3781  
International ..... 216-494-3781  
FAX ..... 216-494-5260  
TELEX ..... 9102406879

Business Hours: 8:30 AM to 8:00 PM EST Monday through Friday  
Prices, Availability, Terms and Conditions are subject to change  
©Copyright 1988 Programmer's Connection Incorporated

## PROGRAMMER'S CONNECTION

	List	Ours
<b>386 products</b>		
386 ASM/386 LINK by Phar Lap Software	495	389
386 DEBUGGER by Phar Lap Software	195	145
NDP C-386 by MicroWay	595	529
NDP ForTran-386 by MicroWay	595	529
PC-MOS/386 Single-User by The Software Link	195	179
PC-MOS/386 5-User by The Software Link	595	539
PC-MOS/386 25-User by The Software Link	995	869
VM/386 by IGC	245	219

	List	Ours
<b>blaise products</b>		
ASYNCH MANAGER Specify C or Pascal	175	135
C TOOLS PLUS/5.0	129	99
PASCAL TOOLS/TOOLS 2	175	135
POWER SCREEN Supports C and Pascal	129	99
Turbo ASYNCH PLUS/4.0	129	99
Turbo C TOOLS	129	99
Turbo POWER TOOLS PLUS/4.0	129	99

	List	Ours
<b>borland products</b>		
EUREKA Equation Solver	167	115
Paradox 2.0 by Ansa/Borland	725	525
Paradox 386 by Ansa/Borland	695	639
Paradox Network Pack by Ansa/Borland	995	725
Quattro: The Professional Spreadsheet	247	179
Sidickick Plus	200	125
Turbo Basic Compiler	100	68
Turbo Basic Support Products All Varieties	100	68
Turbo C Compiler	100	68
Turbo Pascal Compiler	100	68
Turbo Pascal Database Toolbox	100	68
Turbo Pascal Developer's Toolkit	395	285
Turbo Pascal Editor Toolbox	100	68
Turbo Pascal Gameworks Toolbox	100	68
Turbo Pascal Graphix Toolbox	100	68
Turbo Pascal Numerical Methods Toolbox	100	68
Turbo Pascal Tutor	70	49
Turbo Prolog Compiler	150	115
Turbo Prolog Toolbox	100	68
Other Borland products	CALL	CALL

	List	Ours
<b>c language</b>		
C talk by CNS	150	129
Eco-C86 Modeling Compiler by Ecosoft	100	69
Lattice C Compiler from Lattice	450	289
Mark Williams Let's C with FREE csd	75	54
WATCOM C6.5 by WATCOM Group	295	269

	List	Ours
<b>database management</b>		
Clarion Development System by Clarion	695	639
Clipper by Nantucket	695	519
dBASE III Plus by Ashton-Tate	695	439
dBFAST dBASE III Plus Comp by dBFAST	99	89
FoxBASE+ by Fox Software	395	249
FoxBASE+/386 by Fox Software	500	359
FrontRunner by Ashton-Tate	195	175
Genifyer by byte	395	249

	List	Ours
<b>digitalk products</b>		
Smalltalk/V	100	84
Smalltalk/V 286	200	175
Smalltalk/V Support Utilities All Varieties	CALL	CALL

	List	Ours
<b>golden bow products</b>		
Vcache	60	55
Vcache Hard Disk Utility	80	74
Vcache Deluxe Hard Disk Utility	120	111
Vopt Hard Disk Optimization Utility	60	55

	List	Ours
<b>lahey computer products</b>		
F77L-EM/16	695	639
F77L-EM/32	895	799
F77L-FORTRAN Compiler	477	429
Lahey Personal Fortran 77	95	85
with Toolkit	119	99

	List	Ours
<b>logitech products</b>		
Logitech HI REZ Mouse	149	119
Logitech Mouse with Plus Software	119	98
With LOGICADD	189	153
With LOGICADD and LOGIPANT	219	179
With LOGIPANT	149	119
Logitech Series 2 Mouse with Plus Software	99	79
Other Logitech Products	CALL	CALL

	List	Ours
<b>microsoft products</b>		
Microsoft BASIC Compiler	295	219
Microsoft C Compiler 5 w/CodeView	450	299
Microsoft COBOL Compiler w/Tools	900	659
Microsoft FORTRAN Optimizing Comp	450	299
Microsoft Macro Assembler	150	105
Microsoft Mouse All Varieties	CALL	CALL
Microsoft OS/2 Programmer's Toolkit	350	239
Microsoft Pascal Compiler	300	199
Microsoft QuickBASIC 4	99	69
Microsoft QuickC	99	69
Microsoft Windows	99	69
Microsoft Windows 386	195	129
Microsoft Windows Development Kit	500	329
Other Microsoft products	CALL	CALL

	List	Ours
<b>persoft products</b>		
SmartMOVE	149	135
SmartTERM 220	195	179
SmartTERM 240	345	309

	List	Ours
<b>periscope products</b>		
Periscope I with Board	455	369
Periscope II with NMI Breakout Switch	175	139
Periscope II-X Software only	145	105
Periscope III 10 MHz version	1395	1119

	List	Ours
<b>peter norton products</b>		
Advanced Norton Utilities	150	89
Norton Commander	75	55
Norton Editor	75	59
Norton Guides Specify Language	100	65
For OS/2	150	109
Norton Utilities	100	59

## ORDERING INFORMATION

**FREE SHIPPING.** Orders within the USA (lower 48 states only) are shipped FREE via UPS Ground. Call for APO, FPO, PAL, and express shipping rates.

**NO CREDIT CARD CHARGE.** VISA, MasterCard and Discover Card are accepted at no extra cost. Your card is charged when your order is shipped. Mail orders please include expiration date and authorized signature.

**NO COD OR PO FEE.** CODs and Purchase Orders are accepted at no extra cost. No personal checks are accepted on COD orders. POs with net 30-day terms (with initial minimum order of \$100) are available to qualified US accounts only.

**NO SALES TAX.** Orders outside of Ohio are not charged sales tax. Ohio customers please add 5% Ohio tax or provide proof of tax-exemption.

**30-DAY GUARANTEE.** Most of our products come with a 30-day documentation evaluation period or a 30-day return guarantee. Please note that some manufacturers restrict us from offering guarantees on their products. Call for more information.

**SOUND ADVICE.** Our knowledgeable technical staff can answer technical questions, assist in comparing products and send you detailed product information tailored to your needs.

**INTERNATIONAL ORDERS.** Shipping charges for International and Canadian orders are based on product weight. The standard rates used are published in the Fall 1988 issue of our Buyer's Guide. If you do not have a copy, please call or write for the exact cost. All payments must be made with US funds drawn on a US bank. Please include your telephone number when ordering by mail. Due to government regulations, we cannot ship to all countries.

**MAIL ORDERS.** Please include your telephone number and complete street address on all mail orders. Be sure to specify computer, operating system, diskette size, and any applicable compiler or hardware interface(s). Send mail orders to:

Programmer's Connection  
Order Processing Department  
7249 Whipple Ave NW  
North Canton, OH 44720

	List	Ours
<b>other products</b>		
1st-CLASS by 1st-CLASS Expert System	495	399
Actor by The Whitewater Group	495	439
APL *PLUS PC by STSC	695	529
Brief by Solobon Systems	195	CALL
Carbon Copy Plus by Mendan Technology	195	135
Desqview from Quarterdeck	130	115
Desqview API Products All Varieties	CALL	CALL
Epsilon EMACS-type Text Editor by Lugatu	195	149
Flow Charting II+ by Patton & Patton	229	189
HALO 88 by Media Cybernetics	325	CALL
Instant Replay III by Nostradamus	150	129
TopSpeed Modula-2 by Jensen & Partners	99	89
Macro Utilities by Paul Mace Software	99	85
MathCAD by MathSoft	349	319
Microport Products All Varieties	CALL	CALL
MICROSTAT-II Statistics Pack by Ecosoft	395	359
Opt-Tech Sort by Opt-Tech Data Proc	149	129
PC Tools Deluxe by Central Point Soft	79	69
STATGRAPHICS by STSC	895	699
TLIB Version Control by Burton Systems Software	100	89
5 Station LAN	300	269
Turbo Plus by Nostradamus	100	89
Turbo Programmer for Turbo Pascal by ASCII	389	309
Turbo Programmer/C by ASCII	499	399
XENIX System V All Varieties by SCO	CALL	CALL



Established 1984  
SEPTEMBER 1988 • BYTE 39



# Use it or lose it!



## Use DataSaver

standby uninterruptible power supply, and protect your microcomputer against costly data loss and hardware damage.

- Constant AC line protection against power disturbances and interruptions.
- Built-in spike/transient suppression and EMI noise filtering.
- Powerful sizes to protect any system from the earliest Apples to the latest PS/2's. International models, also.

For more information, call:  
**TOLL-FREE 800/332-3440.**  
 In California, call 805/541-4160.  
 Or write to us at the address below.  
**GSA No. GS 00K-87-AGS5393 PS01**  
 Dealer/VAR inquiries invited



**Cuesta Systems Corporation**  
 3440 Roberto Court  
 San Luis Obispo, CA 93401

would make adapting these cards difficult and expensive. In addition to all the electrical problems, AT and XT cards are too big to fit into the PS/2 boxes. All in all, adapters to fit PC and AT cards into the PS/2 probably won't happen.—Steve

### Translation, Please

Dear Steve,

I ran across some long FORTRAN source code recently that has what the author refers to as Warnier-Orr diagrams in place of the more generic English comment lines. As near as I can fathom, these diagrams appear to be a sort of condensed truth table outlining the program logic flow.

I'd like to know more about these diagrams so I can make some sense out of the cryptic symbols they contain. Could you or your knowledgeable readership offer any references?

James T. Himer  
 Calgary, Alberta, Canada

*Your question seemed easy until I started looking for an answer. Apparently, programmers must have stopped using Warnier-Orr diagrams. Searching through back issues, I found two articles in BYTE: "Structured Programming with Warnier-Orr Diagrams" by David A. Higgins (December 1977) and "Warnier-Orr Diagrams: Some Further Thoughts" by G. T. Wedemyer (May 1978).*

*The only recent reference I found was the book Diagramming Techniques for Analysts and Programmers by James Martin and Carma McClure (Prentice-Hall, 1985).—Steve*

### Hebrew Word Processing

Dear Steve,

What can you recommend as a current data book for information about software? I once had a copy of *The Whole Earth Software Catalog*, and *The Data-Pro Report* was highly recommended to me, but apparently neither is up to date.

I'm hoping to get specific information about word-processing programs in Hebrew and a shopping guide to word-processing systems with scientific notation and plotting capability.

Ellen Dean  
 Cambridge, U.K.

*I can readily understand your desire to have a truly current software directory. I'd like to know where to find one myself.*

*Unfortunately, in a business that grows and changes as rapidly as the microcomputer trade, any compendiums are dated before they're published.*

*The most current information sources*

*are magazines such as BYTE, PC Tech Journal, and PC Magazine. These magazines contain the most current software/hardware reviews, as well as manufacturers' advertisements, product notices, and other useful information. The manufacturers themselves are frequently the most useful information sources, although one must be wary of hype. Of the directory-type publications, the one published annually by PC Tech Journal is frequently the most useful.*

*Although I can't provide all the information you need, I can offer some sources for information on Hebrew word-processing software for IBM-type PCs. Two companies advertising PC software with multilingual text capabilities, including Hebrew, are Gamma Productions, Inc. (710 Wilshire Blvd., Suite 609, Santa Monica, CA 90401) and MegaChomp Co. (3524 Cottman Ave., Philadelphia, PA 19149).—Steve*

### Pictures, Hexes, and the Weather

Dear Steve,

I have three unrelated questions.

For a long time, I've been seeing ASCII characters used to make some very good printer pictures. These pictures are found on BBSes all over the country. I was wondering how these pictures are made—some cannot even be listed to the screen and viewed. It takes an 80-column printer set to condensed mode and a small line spacing to make any sense out of the image data. Is there a software or hardware package available that can produce these picture files?

I have access to an EPROM programmer. It has its own card that goes into one of the slots in an IBM PC (it's not a serial-type programmer; it's like the \$179 ones that many of the clone suppliers sell), and it programs up to four EPROMs at once. I've seen ads for EPROM data on a disk that is in the Intel Hex format. I am not sure if my programmer will accept this Intel Hex format. Can you describe the Intel Hex format so I can determine whether or not it is compatible with my programmer?

Now for the hard question. A long time ago, you wrote an article entitled "Build a Computerized Weather Station" (February 1982). You used a Heathkit anemometer and a temperature sensor connected to a computer to tell you of the changes in weather conditions. I'm also interested in predicting the weather. In fact, I purchased a program that, when supplied with a few readings (data such as date, location, average temperature, and current atmospheric pressure), will

*continued*

# *New diskdoubler™ doubles the storage capacity doubles the storage capacity of your hard disk*



## *for \$189*

### **Upgrade the disk drive in your PC the easy way!**

Datran's new DiskDoubler dd2000 is a short card that simply fits into any available slot on an IBM, PC, XT, AT, 386 or compatible, DOS 2.0 or greater.

**Upgrade a 20 MB disk into a 40 MB.** The DiskDoubler lets you double the storage capacity of any hard disk *without loss of performance*. No matter what size hard disk you have, the DiskDoubler will double it.

**Works With All Data.** The DiskDoubler compresses data stored on a hard disk, including application programs, program files, COM and EXE files. You will appreciate the doubling of capacity for word processing, spreadsheets, and database files.

**Powerful dBASE Capacity.** The DiskDoubler is especially powerful when handling dBASE II, III and III Plus files, storing on the average *three times* as much data on your hard disk, i.e., your 20 MB hard disk will perform like a 60 MB disk . . . an 80 MB disk will act like a 240 MB model. It works equally well for any size hard disk . . . and for only \$189.00.

**Principle of Operation.** At the heart of the DiskDoubler is a new, powerful high-speed data compression micro-processor that incorporates Datran's state-of-the-art data compression technology, which represents years of research and development.

**Totally Transparent Operation.** Datran's high speed data compression technology coupled with our extensive operating software allows the DiskDoubler to process data at speeds compatible with disk operating speeds. It looks as though you've added a disk drive of double the capacity to your PC.

**Breaks the 32 MB DOS Barrier.** Because the DiskDoubler doubles the amount of data your disk drive stores, it effectively increases the 32 MB DOS barrier to 64 MB without any special software.

**Simple Installation.** Once the simple, fast installation is complete, the DiskDoubler operates in the background and is completely user transparent. The dd2000 works with yours existing hard disk controller.

**No Formatting Required** as is necessary with RLL controllers. DiskDoubler will even double the capacity of a drive already using RLL technology.

**Low Power Consumption.** The 1/2 watt DiskDoubler eliminates the need for upgrading your power supply, as would be needed if an additional disk drive were added pulling 15 to 30 watts.

**Long Life Performance.** With a long three-year limited warranty, DiskDoubler is a simple, inexpensive and reliable way to double your disk storage.

**Satisfaction Guaranteed.** Datran backs the DiskDoubler with a 30-day no questions asked money back guarantee.



FOR THE DEALER NEAREST YOU OR  
TO ORDER DIRECT BY PHONE:

**1-800-332-0456**



**DATRAN**

*Leadership in Data Compression Technology*



The most affordable way  
to build a skyscraper.



*MultiSync Plus*  
*For superior business*  
*graphics, desktop*  
*publishing and CAD*

Or construct a bridge. Or design a circuit. Or even create a pie chart. With the MultiSync® Plus, high resolution graphics are well within reach. When used with the graphics board that was designed for it—the MVA 1024 from NEC—it may well be the ultimate value for all your CAD and business graphics applications.

MultiSync Plus has a 15" diagonal flattened CRT and a tilt-swivel base to make you more comfortable. It works with boards for a variety of systems, from PC/XT/AT/386 (or 100% compatibles) to MAC II and PS/2. It automatically adjusts its scanning frequency from EGA to VGA, and on up to even higher standards with our MVA 1024 in AT/386 based systems.

Whether your plans are as big as a skyscraper or as small as a memory chip, MultiSync Plus makes the world of high resolution graphics more accessible. For literature or a dealer call

IBM, PC, XT, AT and PS/2 are registered trademarks of the International Business Machines Corporation.

1-800-447-4700. For technical details call NEC Home Electronics

Apple and Mac II are registered trademarks of Apple Computer, Inc.

(USA) Inc. 1-800-826-2255.

NEC is a registered trademark of NEC Corporation.

**C&C**  
Computers and Communications

**NEC®**



forecast the next three days' weather and even draw a local weather map. I was going to rely on the local weather radio and the cable TV weather channel for the data, but when they said for three straight days that the high was 9°F (in summer), I knew I needed my own source for this data. I remembered your old article and decided that it should provide some guidance for putting together a computer-controlled system to take readings every hour or so.

I'm not a programmer, but I figure that with trial and error I can make a program that will do what I want. The actual instruments and the interface to the computer is a bigger problem. Can you give me any clues on this? Also, is there a better or cheaper way for measuring wind speed and direction?

Donald P. Bolton  
Richland, WA

The "printer pictures" you mention are reminiscent of pictures I used to create when I was in school (before personal computers). The technique used involved creating the drawing (on graph paper), determining the shading or gray scale, and assigning characters to represent the shading or gray-scale levels.

The character assignments followed the concept of using the density of a character that is essentially centered in the character space. You can easily see that a + symbol has a lesser density than a # or a @. It would then be a simple matter to code in the lines of character (even using backspacing to increase density). I haven't experimented in this area in quite some time, but since you can create the rules necessary to code the character lines, you should be able to create a program to automate the process. This should be fairly easy, given that paint and video capture programs are available to get the image into the computer. I don't know of a commercial program, however, that creates these pictures.

As to your question about the Intel Hex format for files, this format differs from the normal Hex file in that the data is transmitted in record blocks, with necessary control and checksum codes. There are two types of records. The data record is formatted as

```
:BCAAAA00HH<data>...
CC<cr><lf>
```

where : is the start character, BC is the byte count of the record data (inclusive of control info), AAAA is the starting address of this record, 00 indicates that this is a data record, and CC is the two's comple-

ment checksum of the binary summation of all the previous bytes.

The end-of-file record is formatted as

```
:BCAAAA01CC
```

where : is the start character, BC is the byte count of the record's data, AAAA is the starting address of this record, 01 indicates that this is an end-of-file record, and CC is the two's complement checksum of the binary summation of all the previous bytes.

As you can see, it would be a simple process either to append or delete the control information. A short BASIC program would do the trick.

Regarding your third question, the methods for data collection of weather information have improved dramatically in recent years. Several devices are available to aid construction of these tools. Among them are the following:

- Temperature measurement: National Semiconductor's LM135-series precision temperature transducers
- Barometric pressure: National Semiconductor's LX05xxA series Monolithic Pressure transducers
- Wind directions: Hall-effect sensors and magnets

You'll need to use the transducers in an analog environment, then convert the signals to digital information with an A/D circuit (National's ADC0802 is a fairly easy device to use). You can use the Hall-effect sensors digitally for count or direction. National Semiconductor can provide information on these and other devices in its linear and digital families (including sample application data). Contact National Semiconductor Corp., 2900 Semiconductor Dr., Santa Clara, CA 95051.

You might consider buying a new instrument system that Heath is marketing. The Digital Weather Master is portable and has the ability to monitor temperature, barometric pressure, wind speed and direction, and rainfall. It also has some "history" functions built in. Perhaps you could investigate adapting this type of unit to your needs (it might be easier to start with a functional and calibrated unit, then create the interface).

Concerning weather forecasting programs: I have investigated some programs (in fact, one of my associates went to great lengths to determine the reliability of one package). Unfortunately, most of them use NOAA-derived formulas that are so generic in nature that their reliability is highest in the midwest area of

the country. Extreme northern, southern, and coastal users will find that they need to fine-tune the algorithms to their native area. Consequently, it's always best for a new user to determine if the program can be modified (source code is provided) or allows for some form of area-dependent offsets.—Steve

### Have ROM Will Travel

Dear Steve,

I have received conflicting information as to the possibility of removing the ROM BIOS chip from a Western Digital hard disk controller card and inserting it into an empty ROM socket on a PC XT-clone motherboard. Removing the W3 jumper on the controller card would then tell the board that it should look to the motherboard for its BIOS. The purpose of these modifications is to remap the memory address of the hard disk BIOS from its normal C800 address in memory segment C into a location in memory segment F, along with the regular system BIOS. If the hard disk BIOS were in segment F, I could set up 128K bytes of my HiCard board (similar to the Max-It board advertised in BYTE) memory in segments C and D and put my 64K-byte Lotus/Intel/Microsoft Expanded Memory Specification (LIM/EMS) window in segment E.

This chip-transfer scheme was suggested to me by someone in technical support at RYBS Electronics (which supplies the HiCard board); he claimed to have done this himself. However, someone at Western Digital technical support said that he had never heard of this and did not believe it could be done.

My computer is an XT clone assembled from parts primarily from JDR Microdevices. The turbo motherboard has seven sockets for 64K-byte ROMs. Only one of these sockets is currently used by the ROM BIOS chip. Can the suggested modification be done? I especially have a problem figuring out how two 64K-byte ROMs on the motherboard map into the 64K-byte space of segment F. If this modification is possible, would I have any problems with application or utility programs such as Norton Utilities, Fastback, or Coretest?

Franklin Chase  
Boston, MA

Maybe I don't quite understand what you're trying to do, but it seems to me that if you're using EMS 3.2 or EMS 4.0 with the small frame option, you only need 64K bytes of space somewhere in the first megabyte of memory in which to put the

continued

# "An exceptional value."

Tom Badgett. *PC Clones*

"I was impressed.  
It wins the cost-effective award."

John Dvorak. *PC Magazine*

"This program has all the features and capabilities of money management programs costing 10 times as much."

Leonard Hyre, *PCM Magazine*

We appreciated those kind words. They helped make **MONEYCOUNTS® 4.0** one of today's most popular accounting/money management programs for home and business. But we couldn't leave well enough alone. So we're introducing new

## **MONEYCOUNTS® 5.0** ...an unbelievable buy at just \$29!

**MONEYCOUNTS® 5.0** balances your checkbook... prepares your budget... manages your cash, checking, savings, credit cards... prints 5 types of financial statements including net worth...3 types of inquiry reports... general ledger, accountant's trial balance, and graphics. Its fast financial data base handles up to 999 accounts and 100,000 transactions a year.

**MONEYCOUNTS® 5.0** is a CPA-designed money management/accounting system you can use for home or business. It's easy to use, requires no accounting knowledge, is menu-driven with on-line help, has a fast financial calculator, works with monochrome or color monitors, comes with a **printed manual** and is **not copy protected**.

**SAME DAY SHIPPING.** Order today and own **MONEYCOUNTS® 5.0** for only \$29! Add \$5 shipping/handling (outside North America, add \$10). Iowa residents please add 4% sales tax.



375 Collins Road NE  
Cedar Rapids, IA 52402

## **MONEYCOUNTS® 5.0** now also...

- prints any type of pin-feed check and updates your records automatically
- estimates your 1988 income tax
- analyzes financing options, savings programs...computes interest rates, loan payments...prints amortization schedules
- manages mail lists—zip and alpha sorts—and prints labels and index cards
- provides password protection, fiscal year support, and pop-up notepad.



VISA, MASTERCARD & COD ORDERS CALL

# 1-800-223-6925

(In Canada, call 319/395-7300)



Dept. B  
375 Collins Road NE  
Cedar Rapids, IA 52402

## **MONEY COUNTS®**

VERSION 5.0  
\$29 + \$5 shipping

NAME \_\_\_\_\_

ADDRESS \_\_\_\_\_

CITY \_\_\_\_\_

STATE/ZIP \_\_\_\_\_ PHONE \_\_\_\_\_

CHECK  MONEY ORDER  VISA  MASTERCARD

CARD # \_\_\_\_\_ EXP. DATE \_\_\_\_\_

No. of Copies	Product	Price Each	Total
	<b>MONEYCOUNTS® 5.0</b> (Needs IBM or compatible computer, at least 256k memory, DOS 2.0 or more, two disk drives or hard disk)	\$ 29.00	
	Shipping & Handling	\$ 5.00	\$ 5.00
<b>TOTAL AMOUNT</b>			\$ _____



# QuickBASIC Supercharged!



Want even more power, speed, and creativity out of your QuickBASIC programs? Here's THE MICROSOFT® QUICKBASIC PROGRAMMER'S TOOLBOX—an essential library of more than 250 subprograms, functions, and utilities designed to supercharge your QuickBASIC programs. The subprograms and functions created by author John Clark Craig address: ANSISYS screen control ■ mouse support ■ pop-up windows ■ graphics ■ string manipulations ■ bit manipulation ■ editing routines ■ engineering, mathematical, and statistical functions ■ game programming ■ interlanguage calling ■ and more. Each is practical and inventive, not gimmicky. And each takes maximum advantage of QuickBASIC's capabilities. If you're new to QuickBASIC or a QuickBASIC pro, you're guaranteed to turn to this superb collection again and again. \$22.95

## Microsoft Press Hardcore Computer Books

Available wherever books and software are sold.

Or call in your credit card order. 800-638-3030 (In MD 824-7300). Refer to ad BM78.

Book Code 86-96403.

### ASK BYTE

page frame. The expanded memory does not go into this space.

Moving the hard disk BIOS might work, but I think you might then have to boot with a floppy disk. The BIOS is programmed to scan for ROM programs in the memory range from C800:0000 to F400:0000, so if you address it at F800:, the hard disk routines won't be found during system start-up. If it turns out that the 800 part of the segment address isn't sacred, you might be able to locate it at F000: and boot without trouble. If the ROM is relocated to F800:, you may be able to boot from a floppy disk and reset the interrupt vector to point to F800 and operate the hard disk, but I don't know for sure.

The empty ROM sockets on the motherboard are for ROM BASIC (cassette BASIC), and inserting the hard disk BIOS into that area shouldn't interfere with the normal BIOS, which is only 8K bytes (the chip is 8K bytes by 8 bits).

Would this cause any problems with utility programs that do special things with the hard disk? Probably. I haven't done this, and it is impossible to predict how various programs will react to a change of this type. If you really want to do this, I think you should call RYBS Electronics again and see if you can get the full scoop. Maybe someone there can tell you exactly how to set it up. —Steve

### Fishing for IIGS Info

Dear Steve,

I'm looking for information on the Apple IIGS. It's pretty hard finding anything. Can you help?

Todd Daugherty  
Chicago, IL

Your shortage of information on the IIGS isn't unusual or unexpected, although the people at Apple Computer aren't as open with information as they used to be 10 years ago.

The best source I'm aware of for information is the A.P.D.A. (Apple Programmers' and Developers' Association), which has membership dues of \$20 per year and can supply development software, as well as hard-to-find manuals and such, all at reasonable cost. You can contact A.P.D.A. at 290 Southwest 43rd St., Renton, WA 98055.

Another good source of Apple information is Don Lancaster. See his columns in Computer Shopper magazine and Radio Electronics magazine for specifics on his hotline and mailing address. His hotline number is (602) 428-4703 (business hours, weekdays, Mountain Standard time). —Steve ■



# TALLGRASS BACKS YOU ALL THE WAY.



*Tallgrass makes  
internal and external  
tape backup systems  
for the IBM PC/XT/AT,  
PS/2 or compatibles,  
and an external  
unit for your Mac  
Plus, SE or II.*

## We've got a whole new family of tape backup systems.

Whether you've got an IBM, a compatible, or a Macintosh, you can count on Tallgrass. We back you with all the storage capacity you could ask for, plus all the features, all the support, and all the speed you'll ever need. And we make it easy to protect your valuable data. Since all operations are automatic

and unattended, you can just set it, and forget it.

## Best of all, we stand behind our products with the industry's only 3-year warranty.

But there's one other reason why so many more people are asking for Tallgrass. It's because the competition is asking so much more for their products.

Let Tallgrass start backing you up.  
Call 1-800-TAL-GRAS. Or write to:  
Tallgrass Technologies, Inc.  
11100 West 82nd St.  
Overland Park, KS 66214

 **TALLGRASS  
TECHNOLOGIES**

When it's worth saving, it's worth Tallgrass

SEPTEMBER 1988 • B Y T E 47

© 1988 Tallgrass Technologies, Inc. "IBM" is a registered trademark of International Business Machines, Inc. "Macintosh" and "Mac Plus" are trademarks of Apple Computer, Inc.

Circle 269 on Reader Service Card (DEALERS: 270)



To some  
people, the  
difference  
is obvious.







“For sheer power, ease of use, speed, and flexibility, you would be hard-pressed to find a more capable product, especially if you need advanced features. It works just as well with a half-dozen spreadsheets simultaneously as it does with one.”

—InfoWorld

**PC**  
**MAGAZINE**  
**EDITOR'S**  
**CHOICE**

“Integrated systems have come a long way, and Smart has...the widest array of powerful features...strong points include intelligent data sharing and good file security, intuitive ease of use, a powerful programming language, and consistently good performance...Smart can fill the bill for a total, integrated software system.”

—PC Magazine

Whether you're just getting started as a lone computer user, or you're the Manager of Information Systems supporting thousands of PC users, discover easy-to-use applications your office won't outgrow. Single user and Multi-user software for DOS, LANs, UNIX or XENIX systems: Word Processing, Spreadsheet & Graphics, Database Management and Communications. For additional information, including a Free Smart Demo, simply return the reply card or call toll-free (800) 331-1763. In Kansas or Alaska call (913) 492-3800, in Canada call (800) 233-6905.

SmartWare





# \$299 For 3-D CAD you can't beat by spending thousands more.



You can spend thousands of dollars for three dimensional CAD software and still not get the power and capability that DesignCAD 3-D offers for a remarkable \$299! DesignCAD 3-D is proof positive that you don't have to spend a fortune for quality.

## DESIGNCAD 3-D

DesignCAD 3-D allows you to develop and advance any design in 3 dimensional space, while providing you with features such as shading, hidden line removal, printer and plotter support. DesignCAD 3-D's extensive file transfer utilities allow you to: transfer documents to and from IGES, DXF HPGL, transfer to GEM and Post Script and to read ASCII text files and X, Y, Z coordinate files. It allows up to 4 simultaneous views (any angle or perspective) on the screen. Complex extrusions, extensive 3-D text capabilities, auto dimensioning and a host of other features are all included with DesignCAD 3-D, all at no extra charge.

The compatibility that DesignCAD 3-D offers you means that it can be used with almost any PC compatible system. It supports

more than 200 dot matrix printers, more than 80 plotters and most digitizers and graphic adapters. DesignCAD 3-D can read drawings from most other CAD systems.

The best reason to buy DesignCAD 3-D is not the low price, the performance or the compatibility. The best reason is the amazing ease of use. DesignCAD 3-D's powerful commands mean that you can produce professional 3-D drawings in less time than you thought possible. In fact, we think you'll agree that DesignCAD 3-D is easier to learn and easier to use than any 3-D CAD system for IBM PC, at any price!

See your local computer dealer for DesignCAD 3-D, or contact:

PC Resource Magazine  
has listed DesignCAD 3-D  
as one of the six  
new computer products  
worth watching in 1988.

**American**  
Small Business Computers, Inc.

327 S. Mill St., Pryor, OK 74361  
(918) 825-4844 FAX 918-825-6359  
Telex 9102400302



# BOOK REVIEWS

## The First Electronic Computer: The Atanasoff Story

by Alice R. Burks  
and Arthur W. Burks

University of Michigan Press,  
Ann Arbor, MI: 1988,  
387 pages, \$30

Reviewed by G. Michael Vose

History books tell us that the ENIAC machine was the first true electronic computer. Its principal inventors, John W. Mauchly and J. Presper Eckert, rightfully occupy a niche as pioneers in the annals of computing. But a successful 1973 court challenge to the ENIAC's patents showed that Mauchly developed much of the ENIAC's theory from information obtained from another man: John V. Atanasoff.

The trial in 1973 set the record straight about Atanasoff's contributions to digital computing theory. But the passage of time has obscured Atanasoff's seminal ideas. Mauchly and Eckert's work stays memorialized in dozens of history texts, while the pioneering efforts of Atanasoff are mostly forgotten.

Like the early work of the brilliant English mathematician Alan Turing, John Atanasoff's innovations were swallowed up by the turmoil of a world war. Unlike Turing, though, Atanasoff never returned to research in computing after his wartime stint as a researcher for the United States Naval Ordnance Laboratory in Washington, DC. Both Turing's and Atanasoff's contributions to the science of computing needed a chronicler to secure them their rightful place in history.

Turing's story became a major biography in 1984 (*Alan*



*Turing: The Enigma* by Andrew Hodges). Atanasoff's story unfolds in *The First Electronic Computer: The Atanasoff Story*, written by a member of the ENIAC design team, Arthur Burks, and his wife Alice, a longtime techni-

cal writer. Their book sets the record straight about Atanasoff's contribution to computing theory.

**The ABC Computer**  
Atanasoff did not set out to invent a general-purpose com-

puter. His original purpose was to automate the calculation of problems in physics, a subject he taught and researched at Iowa State College. Specifically, he sought to mechanize the solving of large sets of simultaneous linear equations. To build such a device, he first had to develop a method for solving these algebraic equations that would lend itself to mechanization. He decided that he needed to solve sets of up to 29 equations with 29 unknowns at an accuracy of 15 decimal places.

Then, the task became one of putting together the pieces that would allow the execution of the algorithm. Atanasoff modified the standard Gaussian algorithm for solving simultaneous linear equations. His modified Elimination Algorithm required only addition and subtraction operations, avoiding the more complex multiplications and subtractions used in standard Gaussian calculation.

This simplified algorithm lent itself nicely to a digital calculation mode like that found in desk calculators used widely in the late 1930s. The Burkses' description of Atanasoff's algorithm makes it easy to understand how it led naturally to many of the decisions that resulted in Atanasoff's computer.

Atanasoff's assistant during the creation of the machine was Clifford Berry, a graduate student. When the patent issued in 1964 to Mauchly and Eckert came under challenge in the 1970s, Atanasoff began referring to his early computer as the ABC, for Atanasoff-Berry Computer.

Once Atanasoff created his elimination algorithm, he and Berry proceeded to build a specialized computing device to execute his algorithm. One

*continued*

### ALSO REVIEWED

*UNIX System Readings and Applications, Volumes I and II*

*Programming Windows: The Microsoft Guide to Programming for the MS-DOS Presentation Manager*

*Software Engineering: A Beginner's Guide*

*Expert Systems for Experts*

*Artificial Intelligence Programming with Turbo Prolog*



## FULL POWER AT YOUR FINGERTIPS.

Discover two Worlds with the advanced screen generating Facility for "C" Programming Environments, **STAGEHAND**, and its comprehensive demo facility **PLAYWRITE**.

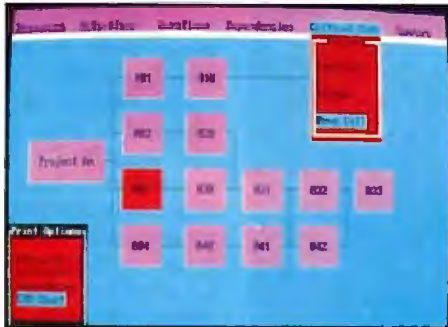

### Create your screens with **STAGEHAND**:

- Full screen editor.
- User definable edit function keys.
- Set multiple color text & prompts.
- Define window borders, size and position.
- Create full screen & context sensitive help.
- Extensive printouts for documentation.
- Define valid function keys, pageup/ pagedown.
- Define internal/external help screens.
- Idle and active input sequence.
- Define default prompt values.
- Full input field definitions including:

Protected	Auto Clear	Cursor Type
Must Fill	Keystroke Edit	Cursor Positioning
Transparent	Upper Case	Data Types
No View	Lower Case	Sequencing
Required	Yes/No	Auto Move

### Full runtime support with **STAGEMANAGER**:

- Full library support routines w/source code.
- Multiple overlapping windows.
- Scrollable regions.
- Auto scrolling windows.
- User idle time routine support.
- User prompt routine support.
- User keystroke routine support.
- User function key routine support.
- User pageup/pagedown routine support.
- Hot key to user printer handler.
- Auto screen timeout.

### Powerful demo generating **PLAYWRITE**:

- Create quick display demos.
- Create quick interface demos.
- Create powerful full featured intensive demos.

### Total product support for:

- Microsoft 4.x, 5.x, Quick C, Turbo C.
- No royalties or runtime fees.
- FREE updates to registered users.
- FREE telephone support.
- FREE **STAGEMANAGER** source code.
- Comprehensive manual including library routine definitions and examples.

**SPECIAL PACKAGE PRICE \$ 199.00!**  
Call for FREE Demo Disk.

TO ORDER CALL 1 800 - DATACODE OR (516) 331-7848  
C.O.D. or AMERICAN EXPRESS.

**DEALER INQUIRES WELCOME!**

LOOK FOR MS/062, UNIX AND VAX VERSIONS THIS SUMMER!

**DATACODE INCORPORATED**

1065 ROUTE 112, FORT JEFFERSON STATION, N.Y. 11776

of the research team's primary constraints was money. They had only a little more than \$5000 to work with at a time when electronic components were scarce and expensive. Since capacitors, resistors, and wire were cheaper than vacuum tubes, Atanasoff invented a memory system using capacitors mounted on a drum; that mechanism further led to the invention of an electronic switching add-subtract circuit.

Along the way, Atanasoff developed several other important ideas: a way to regenerate or refresh the charge to the memory capacitors; calculating in binary rather than decimal; and performing arithmetic with logic functions instead of counting.

The Burkses describe the development of these ideas in the context of Atanasoff's attempt to build a machine to execute his algorithm. This motivation is contrasted with the early work of Mauchly, who was building machines to perform meteorological calculations. Mauchly's machine, called a harmonic analyzer, was an analog device. The kind of problem to be automated dictated the kind of machine needed.

Today, we live in an era of 1-megabit dynamic RAM memory chips in computers with circuitry to refresh memory on a regular basis. But in 1939, refreshing an electrical charge to a capacitor was a breakthrough idea. John Atanasoff intended to apply for a patent on this and the other ideas that went into the ABC machine. But wartime duty called, and that administrative task fell through the cracks.

### Bones of Contention

The Burkses' book not only recounts the early work of Atanasoff, Mauchly, and Eckert and describes the machines they built but examines these efforts in the context of the 1973 trial of *Honeywell v. Sperry Rand*. In this trial, Honeywell challenged the pat-

ent granted in 1964 to Mauchly and Eckert and Sperry Rand for the ENIAC in hopes of avoiding the high royalties being charged by Sperry Rand.

The court case provides a dramatic backdrop for the Burkses' narrative. The authors pored over the trial transcripts and examined every document submitted as evidence. They quote the trial transcript on many occasions to reveal how the Honeywell attorneys extracted from Mauchly testimony revealing that much of his ENIAC knowledge had come from letters exchanged with Atanasoff and from a 1941 visit to Iowa to see the ABC machine.

Mauchly did not intentionally steal Atanasoff's ideas. In the manner of many scientists, he attempted to make himself aware of all the research on a given subject and to synthesize his own inventions given the current state of the art. Borrowing and using ideas developed elsewhere is not uncommon. Later, the absence of patent applications from Atanasoff no doubt made Mauchly and his employers think that the ideas they wanted to patent were available for claim. The social turmoil of an ongoing war only served to add to the confusion.

But the trial finally established who invented what. The authors' use of the trial as a device to frame the historical narrative makes an otherwise dry read much more exciting.

### An Ax to Grind

It seems a truism to say that the people best qualified to record events are those who were involved—unless, of course, they lack objectivity. Co-author Arthur Burks helped to build the ENIAC and well knew the other people involved with it. Only someone so intimately involved could care enough to want to make sure that the historical record was accurate.

But Burks' intimate involvement in the events raises some questions. While he

*continued*

# New Release—New Performance New Price

## KNOWLEDGE man/2<sup>®</sup>

THE UNIVERSAL KNOWLEDGE MANAGEMENT SYSTEM



**NEW IN VERSION 2.5<sup>®</sup>**

**KMAN/2<sup>®</sup> AND ALL OF ITS SEAMLESSLY INTEGRATED DECISION SUPPORT CAPABILITIES ARE AVAILABLE IN ONE PACKAGE FOR \$695.\* THIS UNBELIEVABLE CONSOLIDATION OF COMPONENTS PREVIOUSLY RETAILED FOR \$2,240.**

Featured in Version 2.5 are improved debugging aids, screen management capabilities, SQL compliant Data Dictionary, an on-line tutorial, as well as, many new functions and environmental controls. (For a complete list of 2.5 enhancements, return the coupon in the bottom right corner).

#### Plus

- Relational DBMS
- 4GL Programming Language
- C Language Routines
- Forms Management
- Graphics
- Forms Painting
- Text Processing
- Convenient Data Import/Export
- SQL Inquiry
- Extensive Environmental Controls
- Full Featured Spreadsheet
- Custom Report Generation

- Remote Communications
- Natural Language Interface
- Context Sensitive Help
- PC, LAN, VAX\*\*

Call today for update information.

\*PC Single user version only.

\*\*Your applications will port trouble free to our new VAX release. Prices start as low as \$3,995



#### Trademark:

KnowledgeMan/2<sup>®</sup>, Guru<sup>®</sup> and MDBS III<sup>®</sup> are registered trademarks of mdba, Inc. Other trademarks are proprietary of their respective manufactures.

Sales offices in: Chicago, Dallas, New York, Los Angeles, Canada, Australia, Denmark, Finland, France, Germany, Japan, Netherlands, Norway, Sweden, Switzerland, and United Kingdom.

800-344-5832 317-463-2581

FAX 317-448-6428

TELEX 5106017487 (MDBS LAF UQ)

For more information attach your business card and mail to:

**mdbs, Inc.**  
P.O. Box 248  
Lafayette, IN 47902

Please send information on the following:

- Kman/2 update
- Information Seminars
- Professional Services
- Training
- I am enclosing \$695 + \$10 shipping in payment for one PC single user KMan/2 version 2.5 (in IN, IL, CA, TX, NY and Toronto Canada add appropriate sales tax)
- Please charge my
- MasterCard  VISA
- American Exp.

Card #:

Phone #:

Expiration date:

Signature:



For Diskless Systems—Intelligent Terminals  
Industrial Control Systems  
Manufacturing Test  
Point of Sale

# ROMDISK™

For the IBM  
PC, XT, AT and Compatibles  
180K, 360K, 786K and 1.2MB models  
With PC DOS\* or MS DOS\* Operating Systems

## Disk & Disk Drive Emulators / New Models & Reduced Prices

- Emulates a diskette, adapter and disk drive—SSDD (180K), DSDD (360K), or High Capacity (1.2MB or 786K).
- Standard and Cassette models for both EPROM and SRAM technology. Interchangeable EPROM and SRAM cassettes.
- Two Autoboot modes, file mode and EPROM programming mode.
- Up to four units may be used in one computer by switch selection.
- No special software required—simply copy a Master Diskette to program the EPROMs or copy data to SRAMs.
- Operation at memory speeds on a DMA channel.
- 1/2 high disk drive escutcheon for loading cassettes from front of computer.
- List prices with memory ICs from \$349 to \$1095. Models available OEM without EPROMs.

### EPROM MODELS

- On-board programmable and Read Only models
- Single board models—180K, 360K, 786K and 1.2MB
- Cassette models—180K, 360K and 786K

### SRAM MODELS

- Battery backed up
- Read and write with DOS commands
- Single board and Cassette models—180K, 360K and 786K

**CURTIS, INC.**

10 Anemone Circle • St. Paul, MN 55127-6242  
612/484-5064



\* IBM PC, XT, AT and PC DOS are trademarks of IBM. MS DOS is a trademark of Microsoft.

## NEW! SafeSkin Keyboard Protector



### Finally! A Keyboard Protector That:

- **PROTECTS CONTINUOUSLY - 24 HOURS A DAY** - Against computer downtime due to liquid spills, dust, ashes, staples, paper clips and other environmental hazards.
- **REMAINS IN PLACE** during the operation of your keyboard. SafeSkin is precision molded to fit each key - like a "second skin."
- **EXCELLENT FEEL** - The unique design eliminates any interference between adjacent keys, allowing smooth natural operation of your keyboard.
- **SafeSkin IS VIRTUALLY TRANSPARENT** - Keytops and side markings are clearly visible. In fact, SafeSkin is so clear, sometimes you may not know it's there!
- **DURABLE - LONG LASTING** - SafeSkin is not a "throw-away" item. Many of our protectors have lasted over 3 years under continuous daily use, without failure.

SafeSkin is available for most popular PC's and portables including: IBM, APPLE, AT&T, COMPAQ, DEC, EPSON, KEYTRONICS, NEC, TANDY, TOSHIBA, WANG, WYSE, ZENITH. Specify computer make and model. Send \$29.95. Check or M.O., VISA & MC include exp. date. Dealer inquiries invited. Free brochure available.

**Merritt Computer Products, Inc.**

4561 S. Westmoreland / Dallas, Texas 75237 / 214/339-0753

worked with Mauchly and Eckert to build the ENIAC, he had no qualms about encouraging his later employer, Honeywell, to challenge his old comrade's patent claims. Setting the historical record straight is an admirable ideal, so long as that is the only motivation. The fact that there was a strong economic motivation taints ever so slightly Burks's role in telling the story.

Maybe Burks's 1988 book is intended to leave the world with the impression that his motives in 1973 were pure. Whatever the motivation, the resulting volume is another fascinating glimpse of the genesis of one of this century's major scientific accomplishments.

## BRIEFLY NOTED

**UNIX System Readings and Applications, Volumes I and II** by AT&T Bell Laboratories, Prentice-Hall, Englewood Cliffs, NJ: 1987, 416 pages (Volume I), 336 pages (Volume II), \$19 each. From Aho to Weinberger, these volumes are the who's who of Unix research.

Unix originated at Bell Laboratories, and these books, originally published as Bell System Technical Journals in 1978 and 1984, contain about 20 insightful research papers each. Nearly everyone associated with the initial design and development of the Unix operating system contributes.

Volume I covers the early to mid-1970s, a time when Unix was already firmly entrenched in government and university installations. The papers discuss topics that are now commercial realities: "Unix on a Microprocessor," "The C Programming Language," and "Document Preparation."

Volume II introduces research from the late 1970s and early 1980s that relies heavily on ideas presented in Volume I. The original paper on C++, an extension to the C programming language that is

rapidly gaining favor, is here, as are papers describing the historical development of Unix: "The Evolution of the Unix Time-Sharing System"; "The Evolution of C—Past and Future"; and "The Evolution of Unix System Performance."

There's little here for the programmer that isn't covered well in recent books, but for someone interested in the design philosophies and original applications of Unix, there's no better resource.

Most of the papers require a general knowledge of computer operating systems and hardware to be fully appreciated; however, the writing style is so uniformly accessible that anyone with even a cursory interest in Unix and its origins and design will find addictive reading in each volume. —Jason Levitt

**Programming Windows: The Microsoft Guide to Programming for the MS-DOS Presentation Manager** by Charles Petzold, Microsoft Press, Redmond, WA: 1988, 852 pages, \$24.95. Three years after Microsoft introduced Windows, Charles Petzold has produced the official guide to Windows programming. Written for Windows developers, prospective Windows developers, or the just plain curious, this book offers a solid foundation in Windows program development. Covering a wide topic with very few omissions, *Programming Windows* teaches the whys as well as the hows of programming for Windows.

The book's major strength is its examples. The author assumes that you are fluent in the lingua franca of Windows—the C language—so he prepared for all examples to be written in C. Petzold starts with simple examples and adds detail until functional programs have been created.

Unless you have a good foundation in the basics of window procedures, painting, event loops, and other con-

*continued*

# Ultimate Power. Ultimate Confidence. Ultimate Freedom.



## Experience 20 MHz 386 Power, AST Style

The sky's the limit. That's how you might describe the power-packed capabilities of the AST Premium™/386...and how far we'll go to provide outstanding products, service and support.

Only the 20 MHz, Premium/386, with its advanced bus technology (SMARTslot™) and uncompromising compatibility, eliminates the traditional restrictions placed on an AT's performance and speed while providing future upgradeability.

You also get the comfort that comes from choosing a company with a solid worldwide reputation for reliable,

high-quality technology.

So while others are caught up in compatibility and support problems, you're completely free to enjoy the highest AT-compatible '386 system performance available today...and take advantage of performance-oriented upgrades in the future using SMARTslot architecture.

And because of our many years of working with key leaders in the industry, we're able to maximize the capabilities of the most advanced operating systems and application software available, including MS® OS/2 from AST, IBM®'s OS/2™, UNIX™, Windows™ 386 and MS-DOS®.

For more information call (714) 863-0181 and ask for operator AA 15, or fill out the coupon below.

- Please send me more information.  
 Please have an AST representative call me.

Name \_\_\_\_\_

Title \_\_\_\_\_

Company \_\_\_\_\_

Address \_\_\_\_\_

City \_\_\_\_\_ State \_\_\_\_\_ Zip \_\_\_\_\_

Phone \_\_\_\_\_

AST Research, Inc., 2121 Alton Ave., Irvine, CA 92714-4992 Attn. M.C. BYTE 9/88

AST markets products worldwide—in Europe and the Middle East call 44 1 968 4399; in the Far East call 852 3 77223; in Canada call 416 836 7344. AST and AST logo registered and AST Premium and SMARTslot trademarks AST Research, Inc. IBM and AT registered and OS/2 trademark International Business Machines Corp. MS-DOS and MS registered and Windows trademark Microsoft Corp. UNIX trademark AT&T Bell Laboratories. Copyright © 1988 AST Research, Inc. All rights reserved. Screen display courtesy VerisCAD.

**AST**  
RESEARCH INC.

Times Have Changed.



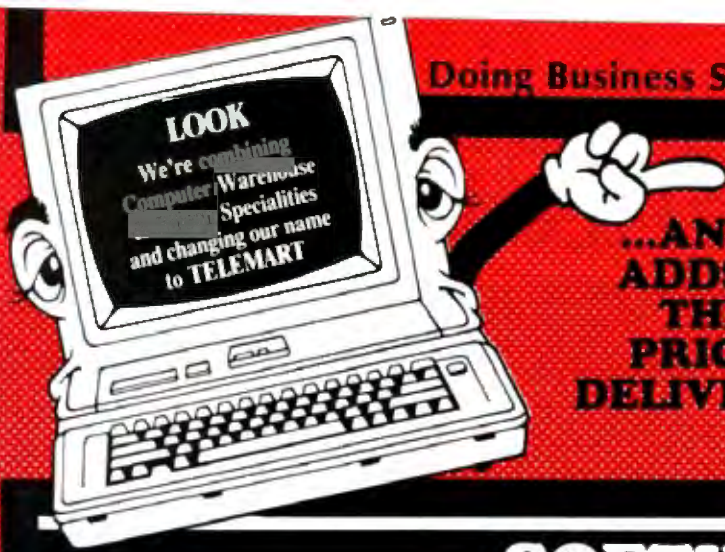

...AND IT ALL  
ADDS—UP TO  
THE BEST  
PRICES AND  
DELIVERY EVER!



# SOFTWARE

## DATA BASE MANAGEMENT

Clipper	\$ 368
dBase III Plus	369
dBase III LAN	599
DB-XL Diamond	105
Eureka	88
Genifer	188
Nutshell	72
Paradox 2.0	415
PFS: Professional File	119
Q & A	185
Quickcode Plus	119
Rapid File	179
Revelation	459
Revelation Bump Disk	239
R:Base Clout (New Ver.)	175
R:Base For DOS	425
Reflex	88
VP Expert	Call
VP Info	56

## PROJECT MANAGEMENT

Harvard Total Project Mgr. II	\$ 309
Microsoft Project 4.0	287
Timeline 2.0	259

## WORD PROCESSORS

Easy Extra	\$ 52
Word (Microsoft)	185
Multimate Advantage II	249
PFS: Professional Wmte	102
Volkswriter 3	132
Volkswriter Deluxe Plus	57
Webster New World Writer	53
Webster Spell Checker	32
Webster Thesaurus	37
Word Perfect	Call
Word Perfect Executive	Call
Word Perfect Library	Call
Wordstar Pro Pack 4.0	Call
Wordstar 2000 Plus Personal	205

## DESKTOP PUBLISHING

Newsmaster II	\$ 39
Pagemaker	Call
PFS: First Publisher	65
Ventura Publishing	475

## GRAPHICS

Energraphics	\$186
Freelance Plus	309
Generic CAD w/Dot Plot 3.0	72
Harvard Graphics 2.1	239
In-A-Vision	259
Microsoft Chart 3.0	229
News Room	30
News Room Professional	42
Printmaster Plus	29
PrintShop	32
Turbo Graphix Tool Box	58
VP Graphix	56
Windows Draw!! w/Clip Art	159

## MICE

PC Mouse w/Paint (Buss or Serial)	85
PC Mouse w/Autosketch (Buss or Serial)	98
Microsoft Buss Mouse 1.0	92
Microsoft Serial Mouse 1.0	92
MS Buss Mouse w/CADD	107
MS Senal Mouse w/CADD	107
MS Buss Mouse w/Windows	122
MS Senal Mouse w/Windows	122
Optimouse (PC Mouse) w/Dr. Halo III	78

## INTEGRATIVE SOFTWARE

Ability Plus	\$ 137
Enable 2.0	352
Framework II	399
MS Works	113
PFS: 1st Choice	76
Smart Software System	Best Price
Symphony	435

## ACCOUNTING

ACCPAC	Call
Computer Associates	Call
DAC Easy Accounting	52
DAC Easy Payroll	38
In-House Accountant	105
One Write Plus 2.0	117
One Write A/R, A/P, Payroll	117
Time Slips III	105

## UTILITIES

1 DIR Plus	\$ 46
Bookmark	56
Brooklyn Bridge	69
Carousel 2.0	43
Copy II PC	18
Copywrite	39
Corefast	89
Cruise Control	29
Cubit	Call
Disk Optimizer 2.0	Call
Disk Technician	56
Double DOS 4.0	Call
DS Back-Up Plus	46
Fastback	75
Fastback Plus	86
Keyworks	53
Mace Utilities	47
Microsoft Windows 2.03	57
Norton Commander	35
Norton Editor	35
Norton Utilities 4.0	46
Note It Plus	45
PC Tools Deluxe	36
Printworks for Lasers	67
Referee	38
Sidelock Plus	Call
Sideways	37
Smart Notes	43
SQZ Plus	53
Superkey	58
Take Two MGR	66
Turbo Editor Tool Box	58
Unlock D Plus	49
XTree Professional	61

## ACCESSORIES

Copy II Option Board Deluxe	\$ 99
Masterpiece	79
Masterpiece Plus	92
Masterpiece Remote	107
MousePad by Mousetrac	9
Summasketch 12x12 Plus	359

## LANGUAGES

Basic Compiler (Microsoft)	\$ 175
C Compiler (Microsoft)	259
Cobol Compiler (Microsoft)	415
Fortran Compiler (Microsoft) 4.0	259
Lattice C Compiler	209
Macro Assembler (Microsoft)	86
Pascal Compiler (Microsoft)	175
Quick Basic 4.0	57
Quick C	57
Ryan McFarlan Fortran	379
Ryan McFarlan Cobol	609
Turbo Basic	58
Turbo C	58
Turbo Pascal 4.0	58
Turbo Prolog	58
Turbo Prolog Toolbox	58

## TRAINING

Chuck Yeager Adv. Flight Simulator	\$ 25
Lets C	38
Mastertype	23
Mavis Beacon Typing	29
MS Learning DOS	29
MS Flight Simulator	29
PC Logo	79
Turbo Tutor 4.0	42
Typing Instructor II	27
Typing Tutor IV	27

## SPREADSHEETS

Cambridge Analyst	\$ 79
4 Word	55
HAL	89
Lotus 1-2-3 Ver. 2.01	295
Lotus Manuscript	309
Lotus Report Writer	67
MS Excel	285
Multipan 3.0 (Microsoft)	109
PFS Professional Plan	52
Quattro	116
Supercalc 4	269
Twin Classic	32
VP Planner	47
VP Planner Plus	Call



MEMBER  
**MMC**  
MICROCOMPUTER  
MARKETING COUNCIL  
of the  
Direct Marketing Association Inc.

- No Charge for VISA and Mastercard
- We Do Not Charge Your Card Until Your Order is Shipped
- You Pay the Ground Shipping \$6.00 (except Alaska and Hawaii)
- We Pay the Air Difference
- Free Air applies ONLY to orders up to 10 lbs. & Over \$50
- Add 5% for C.O.D. Orders
- We Do Not Guarantee Machine Compatibility

- All products carry only manufacturer's warranties. We do not honor guarantees, rebates, final period privileges or promotional programs offered by manufacturers.
- No APO, FPO, or international orders, please.
- Call before submitting P.O.'s Ask for National Accounts
- Personal and Company Checks Will Delay Shipping 3 weeks
- Prices, Terms & Availability Subject to Change Without Notice



Silicon Specialties

# telemart

## HARDWARE

### PRINTERS

Alps All models	Call
Allegro	339
ALQ218	409
ALQ224	479
ALQ318	610
ALQ324	679
2418	885
2424	955
Other Models	Call
AST Turbo Lazer	4310
<b>Citizen Printers</b>	
120D	145
190D	159
MSP 40	319
MSP 45	465
MSP 50	399
MSP 55	530
Premier 35	449
Tribute 124	Call
<b>Diconix 150</b>	309
300	385
<b>Epson Printers</b>	Call
<b>Hewlett-Packard</b>	
Desk Jet	779
Lazer Jet Series II	1775
Paint Jet	1105
<b>NEC</b>	
P2200	329
850 Silent Writer	1539
P5200	520
P5300	685
Other Models	Call
<b>Okidata</b>	Call
292	355
294	715
Lazerline 6	1325
<b>Panasonic</b>	
1080 I M2	159
1091 I M2	199
3131	305
3151	475
Lazer 4450	1635
<b>Star Micronics</b>	Call
<b>Toshiba</b>	
321 SL	489
341 SL	655
351 SX	945
Page Lazer	2415

### DISK DRIVES

<b>Bernoulli Box</b>	
10 Meg	\$ 889
20 Meg	1255
40 Meg	1559
Beta Ext	1019
Beta Int	775
<b>Seagate</b>	
20 MG w/WD Controller	275
251-1	469
AT 40 MEG Full Height	550
Other Models	Call
<b>Teac</b>	
1.2 MEG AT	89
Floppy F55 BR	79
<b>Toshiba</b>	
3.5 Dr 720K	95
3.5 Dr 1.4MB	125

### HARD CARDS

Plus 20 MG	\$ 525
Plus 40 MG	659

### KEYBOARDS

<b>Keytronics</b>	
KB5151	\$ 119
KB5153	149
KB101	79

### MONITORS

<b>Amdtek 410</b>	\$ 130
432	149
V210A	85
<b>NEC</b>	
Multisync II	\$ 589
Multisync Plus	899
Multisync XL	2069
Monographic System	1259
Other Models	Call
Princeton Ultrasync	485
Samsung	Call
Sony Multiscan (1303)	545
<b>Mitsubishi</b>	
Diamond Scan	499
<b>Zenith</b>	
1490	609

### BOARDS

<b>AST</b>	
Hot Shot	\$ 345
Six Pack Plus	115
Xformer	545
3G+	225
Other Models	Call
<b>ATI</b>	
EGA Wonder	175
VIP Plus	265
<b>Hercules</b>	
Color Card	145
Graphics Card Plus	175
Incolor	209
<b>Intel</b>	
Inboard 386 PC	719
Inboard 386 w/cable	979
4020	375
80287-6	175
80287-16	555
<b>Orchid</b>	
Designer EGA	265
Tiny Turbo	359
Twin Turbo	359
VGA	220
<b>Paradise</b>	
Autoswitch 350	130
VGA +	239
VGA Professional	355
<b>Video-7</b>	
VGA	269
Vega Deluxe	180
V-RAM	475

### TERMINALS

<b>Wyse</b>	
30	285
50	355
85	425



### COMPUTERS

<b>AST</b>	
Model 80	\$1695
Model 140	2815
Model 340	4205
Model 390	5839
Other Models	Call
<b>NEC</b>	
Multispeed EL II	1495
Powermate	Call
<b>Toshiba</b>	
T-1000	749
T-1200F	1565
T-1200H	2285
1200FB	2415
T-3120	3068
T-3200	3789
T-5100	4899
<b>Wyse</b>	
386	2480
<b>Zenith Supersport/2</b>	1655
Supersport 20 MG	24798
Supersport 286/Model 2	3445

### MODEMS

<b>Hayes</b>	
1200	\$ 280
1200B	245
2400B	385
<b>Prometheus</b>	
1200B w/Software	75
2400B w/Software	119
Other Models	Call
<b>US Robotics</b>	
Password 1200	149
Courier 2400	299
Courier 2400E	335
HST 9600	635

To Place an Order 1-800-528-1054      Order Processing (602) 944-1037  
 To Follow Up on an Order (602) 944-2552      10:00 a.m.-3:00 p.m. Mon.-Fri.  
 Order Line Hours: Monday-Friday 7:00 a.m.-6:00 p.m.  
 Saturday 9:00 a.m.-1:00 p.m.

**Mailing Address:**  
 8804 N. 23rd Avenue / Phoenix, Arizona 85021

**telemart ORDER LINE**  
**1-800-528-1054**





**KADAK's engineers bring years of practical real-time experience to this mature**

## MULTI-TASKING SYSTEM (version 2.0)

for the IBM® PC, PC/XT and PC/AT

- No royalties
- IBM PC DOS® support
- C language support
- Preemptive scheduler
- Time slicing available
- Source code of the C interface and device drivers is included
- Intertask message passing
- Dynamic operations:
  - task create/delete
  - task priorities
  - memory allocation
- Event Manager
- Semaphore Manager

AMX86™ operates on any 8086/88, 80186/88, 80286 system.

Demo package	\$25 US	<b>KADAK Products Ltd.</b> 206-1847 W Broadway Vancouver, B.C., Canada V6J 1Y5 Telephone: (604) 734-2796 Telex: 04-55670
Manual only	\$75 US	
AMX 86 system (shipping/handling extra)	\$2195 US	

Also available for 8080, Z80, 68000

cepts, understanding Windows is impossible. Fortunately, the book's development of these topics is excellent. Once the basics are presented, the pace and level of treatment accelerates into high gear.

Windows provides a rich graphical environment, and *Programming Windows* contains many fine examples for graphics programming. Mastering the many service routines provided by Windows is just as important, and these topics are presented carefully and thoroughly.

As witness to the richness of Windows, 852 pages still doesn't provide space to cover several important advanced topics, like dynamic data exchange and rich text format.

*Programming Windows* is filled with details and inside information that make it worthwhile reading. The layout integrates charts, tables, and source code in a way that does not interrupt the flow of the text. Broad in scope and omitting little, this book is a must for anyone who is serious about Windows.

—Philip Taylor

**Software Engineering: A Beginner's Guide** by Roger S. Pressman, McGraw-Hill, New York: 1988, 294 pages, \$49.95. This book is a sweeping but measured overview of modern software design principles for students and entry-level professionals. Roger S. Pressman uses the requisite buzzwords: "prototyping," "data design/flow," "transform/transaction mapping," "abstraction," "program description language," and "white-box testing," and he provides supporting technical details and brief examples.

The author never loses sight of the real applications his theory will be put to, ending each chapter with a section entitled "What This Means to You." The text flows relentlessly but easily from analyzing the problem to designing the solution, coding the program, and testing and making

changes. The book's noteworthy conclusion is an exhaustive software engineering checklist and comprehensive example.

—Darrow Kirkpatrick

**Expert Systems for Experts** by Kamran Parsaye and Mark Chignell, John Wiley & Sons, New York: 1988, 462 pages, \$29.95. The role played by domain experts in the development of expert systems has expanded as the tools for building such systems have become higher-level and easier to use. Parsaye and Chignell's book is aimed at domain experts who might be thinking of implementing an expert system (with or without the help of a knowledge engineer), yet who are unfamiliar with artificial intelligence (AI) terms and concepts.

The authors provide a good, solid discussion of a broad range of technologies and methodologies currently in use in the development of expert systems. Chapters are devoted to logic and logic programming, knowledge and knowledge representation, uncertainty, the inference process, building expert systems, and knowledge acquisition and validation. The discussions are uniformly good and sufficiently detailed. The chapter on uncertainty, for example, covers traditional probability theory, fuzzy logic, certainty theory, exact and semiexact inference, and quantification of uncertain knowledge. I found the chapter on knowledge acquisition and validation to be valuable.

Detailed as the discussion may be, it is nevertheless fairly high level: There is no consideration of hardware, nor of specific expert-system building tools (despite an offer to refund the book's price upon purchase of one of several products from IntelligenceWare, of which Parsaye is chairman). Although this book would be a valuable resource for anyone developing an expert system on his or her

continued



# Computerfone™

## Interactive Voice Response System

TouchTone In/Voice In/Text In  
Voice Out

### Excellence in Voice Quality

- Text-to-Speech
- Digitized Speech
- Synthesized Speech
- Auto Answer/Auto Dial
- Host Independent

Call to hear our demo:  
**1-904-476-5742**

© 1986 Suncoast Systems, Inc. 24 Hrs./7 Days/Wk.



NEW

# Ecosoft Announces Microstat-II™

**E**cosoft developed the original version of Microstat in 1978 and it has grown to become the most widely-used statistics package ever written for a personal computer. **Microstat-II** has been redesigned from the ground up to reflect almost 10 years of user feedback. The result of this synergism is a statistics package that is easy to use, fast, accurate.

**Microstat-II** has everything for your statistical needs:

- Descriptive statistics: mean, sample-population standard deviation and variance, moments about the mean, sums, min-max, kurtosis, skewness coefficient of variation, standard error, sums of squares, deviation sums of squares
- Probability Distributions: Binomial, Hypergeometric, Poisson, Normal, Exponential, F, Student t, Chi-square
- Frequency Distributions: value or range, cumulative, percents with bar graph
- Scatterplots: With overlapping points

- Hypothesis testing: mean or proportion, large and small sample
- ANOVA: Oneway, Twoway, Twoway with replication
- Nonparametrics: Wald-Wolfowitz, Cox-Stuart, Kruskal-Wallis, Wilcoxon Rank Sum, Friedman Twoway ANOVA, Kolmogorov-Smirnov (one-two sample), Kendall's Coefficient of Concordance, Spearmans-Rank Correlation, Signs Test, Normal Scores, Mann-Whitney U
- Correlation Analysis: matrix and cross products table
- Regression Analysis: Multiple and Stepwise, forward and backward
- Time Series: moving average, centered moving average, deseasonalization, exponential smoothing
- Permutations, Combinations, Factorials, Contingency Tables and Chi-square

## SAMPLE OUTPUT

```

Regression Analysis
LONGLEY.MII: Longley test data from JASA vol.62, pp. 819-41.

Forwards Regression
Proportion:          0 Tolerance:          0 F enter:          0
F remove:           0

Step:      6      Dependent Variable: Total      Degrees of Freedom:  9

Ind Var  Coefficient  Std Error  Beta Coeff  F Statistic  Probability
-----
Index    15.06187227    84.91492577  .046282023  .03146      .863140833
GNP      -.035819179     .033491008  -1.013746349  1.14387     .312681061
Unemploy -2.020229804    .488399682  -.537542578  17.11003    .002535092
Military -1.033226867    .214274161  -.204740692  23.25154    .000944367
Poplton  -.051104106     .226073200  -.101221114  .05110     .826211796
Year     1829.151465    455.4784991  2.479664383  16.12737    .003036803

Intercept: -3482258.635      F-Statistic: 330.2853392
Standard Error: 304.8540736      Proportion Reduced: .000015805
Std Error (d.f.): 373.3684631      Cumulative Reduced: .995479005

----- Analysis of Variance -----
Regression  Sum of Squares  D.F.  Mean Squares  F Ratio  Probability
Residual    836424.0555    9      92936.00617  330.2853392  4.9840e-10
Total      185008826.0    15

----- Durbin-Watson: 2.559487689 -----
Case  Observed  Expected  Residual  -2s  -1s  0  +1s  +2s
-----
1     60323.00  60055.66  267.34  .  .  .  .  .
2     61122.00  61216.01  -94.01  .  .  .  .  .
3     60171.00  60124.71  46.29  .  .  .  .  .
4     61187.00  61597.11  -410.11  .  .  .  .  .
5     63221.00  62911.29  309.71  .  .  .  .  .
6     63619.00  63888.31  -249.31  .  .  .  .  .
7     64989.00  65153.05  -164.05  .  .  .  .  .
8     63761.00  61774.18  217.82  .  .  .  .  .
9     66019.00  66004.70  14.30  .  .  .  .  .
10    67857.00  67401.61  455.39  .  .  .  .  .
11    68169.00  68186.27  -17.27  .  .  .  .  .
12    66513.00  66552.06  -39.06  .  .  .  .  .
13    68655.00  68810.55  -155.55  .  .  .  .  .
14    69564.00  69649.67  -85.67  .  .  .  .  .
15    69331.00  68989.07  341.93  .  .  .  .  .
16    70551.00  70757.76  -206.76  .  .  .  .  .

```

## Exclusive Features

We have also added features that make Microstat-II the easiest, most flexible statistics package you've ever used:

- Up to 8 times faster than older versions of Microstat without any loss in accuracy—up to twice as fast as the competition
- 8087 support
- Online help with a single keystroke and moveable help screens
- No complex command language to learn
- Interactive or batch modes of operation
- Import-export data files
- Keyboard or mouse input
- Scrollable output—review results without rerunning the test
- Configurable—change colors, file types, even set the mouse speed
- Variables may have missing data, aliased values, and unequal sizes
- New data administration: full screen editor for the ultimate in ease of data entry, new transforms (with conditionals) for creating new variables from existing data, range checking, and external file processing
- Expanded user's manual

**\$395.00.**

**Ecosoft, Inc.**  
6413 N. College Ave.  
Indianapolis, IN 46220  
orders: 1-800-952-0472  
info: 1-(317) 255-6476



# ECOSOFT



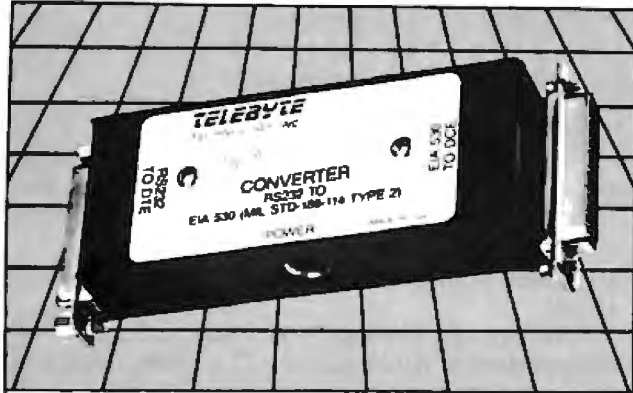

# EIA - 530 TO RS - 232 CONVERTER

- Supports 10 Category 1 & 3 Category II circuits
- Full EIA - 530 compliance
- DTE & DCE models
- Meets Mil-Std-188-114 Type 2
- Up to 1 MBS data rate
- Doubles as RS-422 converter

**1-800-835-3298**

(516) 423-3232

TWX 510-226-0449

**TELEBYTE**  
TECHNOLOGY, INC.

270 E. Pulaski Road Greenlawn, NY 11740 A Public Company

## IBM PC® COMPATIBLE SINGLE BOARD COMPUTER

**Quark/PC+**

4" x 6"



From **\$325.**  
quantity one

- Low Power — Less than 3 Watts
- Optional on-board Video LCD Driver
- Ideal for any PC compatible OEM product which is not a personal computer

**Includes:** 1. Powerful V40® CPU (Faster than a PC) 2. Math Co-Processor Socket 3. 5 Volt Only Operation (3 watts) 4. Speaker Port 5. Keyboard Port 6. Parallel Printer Port 7. PC Bus 8. PC Compatible BIOS ROM 9. 1 Serial Port

**On board Options include:** 1. 5 Mode Video Controller Option (Monochrome, Hercules® Graphics, CGA, High Res CGA, LCD Driver) 2. Floppy Disk Controller (3.5" 5.25", 360K/720K/1.2 MB) 3. SCSI Bus Interface (Hard Disk etc.) 4. Up to 768K RAM 5. Battery-Backed-up Real-Time-Clock 6. 2 Additional RS232C Serial Ports

To order or enquire call us today.  
**Megatec Computer Corporation**  
(416) 745-7214 FAX (416) 745-8792  
174 Turbine Drive, Weston, Ontario M9L 2S2  
U.S. Address: 1051 Clinton St., Buffalo, N.Y. 14206

**Distributors:**  
Germany: V&C Computers (06071) 25666  
Italy and Southern Europe:  
NCS Computers (0331) 256-524 FAX (0331) 256-018  
UK: Densitron (0959) 76331 FAX (0959) 71017  
Australia: Asp Microcomputers (02) 500-0628

Quark is a registered trademark of F&K Manufacturing Company. Hercules is a registered trademark of Hercules Corporation. V40 is a registered trademark of NEC Corp. IBM PC is a registered trademark of IBM Corporation.

**megatec**

## BOOK REVIEWS

own, it could not serve as the only resource.

The authors present the material logically, with good use of accompanying figures and summaries at the end of each chapter. The appendixes expand on selected topics introduced in the main text, including search, general-purpose reasoning, propositional logic, and relational databases. A 33-page bibliography and index complete the end material.

*Expert Systems for Experts* has a broader audience than its title implies. I recommend it for students of AI and novice knowledge engineers, and as a valuable reference for more advanced AI practitioners.

—Alex Lane

*Artificial Intelligence Programming with Turbo Prolog* by Keith Weiskamp and Terry Hengl, John Wiley & Sons, New York: 1988, 262 pages, \$22.95. Turbo Prolog books with the term "artificial intelligence" on the cover have gotten a bad reputation. A number of them merely rehash the user's manual or provide lengthy tutorials on fundamental Turbo Prolog concepts, paying only lip service to AI applications. Happily, this book bucks that trend, providing useful code and ideas for the beginning-to-intermediate AI or Turbo Prolog programmer.

Authors Weiskamp and Hengl try to teach fundamental AI programming concepts and to show how to write useful programs in Turbo Prolog. After providing the reader with the obligatory opening chapters on the fundamentals of the language and its Turbo implementation, they progress from general-purpose AI applications.

The chapter on building an AI toolbox is deceptively easy to overlook in a first reading if you're all familiar with Prolog and looking only at the code, or if you're a beginner looking only for Prolog programs to run. The chapter,

however, contains many interesting ideas on how to write portable Prolog predicates.

The discussion of inference engines is ambitious, beginning with a discussion of formal reasoning and predicate logic, continuing with a description of forward- and backward-chaining control strategies, and ending with the development of a simple inference engine.

Despite a whirlwind introduction, I found the discussion of natural-language processing quite meaty. Code is developed to implement recursive transition network (RTN) and augmented transition network (ATN) natural-language parsers. The final sections of the book attempt to deal with knowledge representation and expert systems; however, there just isn't enough room to give either subject sufficient coverage.

Although the scope of the book is too broad for its medium size, the authors go about their business in a clear fashion with examples that stick in your mind, such as a robot riding a bicycle downstairs to illustrate commonsense reasoning. The code, which is easy to read, is available on disk for \$24.95. The book includes a glossary and an index.

While advanced AI or Prolog practitioners will find this book a bit light, others will find it a good way to learn more about AI and Turbo Prolog. —Alex Lane ■

### CONTRIBUTORS

G. Michael Vose is coeditor of *OS Report: News and Views on OS/2* (P.O. Box 3160, Peterborough, NH 03458). Jason Levitt is a Unix consultant living in Austin, Texas. Phillip Taylor is a Windows consultant and freelance writer in the Washington, DC area. Darrow Kirkpatrick is a freelance writer and computer consultant living in New Paltz, New York. Alex Lane is a knowledge engineer for Technology Applications, Inc., in Jacksonville, Florida.

# MINUTEMAN<sup>®</sup>

## UNINTERRUPTIBLE POWER SUPPLIES

- Fully Automatic Operation
- Order — Ship Same Day
- Full One Year Warranty
- 250 Watt to 1600 Watt Models



### TOTAL POWER PROTECTION

- **Blackouts** — Enables user to operate during complete loss of power.
- **Brownouts** — User is protected from low AC voltage below 102 volts.
- **Overload Protection** — Automatic shutdown in overload situation to protect UPS from inverter burnout.
- **Overvoltage Protection** — UPS runs on inverter (117 volts) when AC voltage exceeds 132 volts.
- **Surges/Spikes** — Clamps transients above 200 volts with an energy rating of 100 joules or less.
- **EMI/RFI** — Three stage filtering for clean AC power.
- **Synchronized Sinewave™** — Eliminates voltage reversal to input of your equipment.
- **1 Millisecond Transfer Time\*** — This includes detection and transfer so your machine never notices loss of electrical power.
- **Two Audible Alarm Levels** — Notifies user of battery usage and two (2) minute warning.
- **LED Display** — Informs user of operation mode, power utilized on AC, plus "On Battery" and battery power status.
- **Alarm Silencer** — Enables user to silence alarm for quiet continued operation during battery operation.
- **Optional Signal Port** — Enables UPS to notify computer of loss of AC power to allow computer to backup or shut down.

\* 250 watt and 500 watt units offer 4 msec transfer time. PWM wave form

### Suggested Retail

250 WATT	120 Volt	\$ 359.00
300 WATT	120 Volt	\$ 549.00
500 WATT	120 Volt	\$ 699.00
600 WATT	120 Volt	\$ 899.00
1200 WATT	120 Volt	\$1499.00
1600 WATT	120 Volt	\$1999.00

230 Volt Units Also Available



1455 LeMay Drive  
Carrollton, Texas 75007

Telephone:  
(214) 446-7363

**1-800-238-7272**

FAX: (214) 446-9011

TELEX: 140275 OMEGA



# PRICES YOU CAN FIND ONLY IN

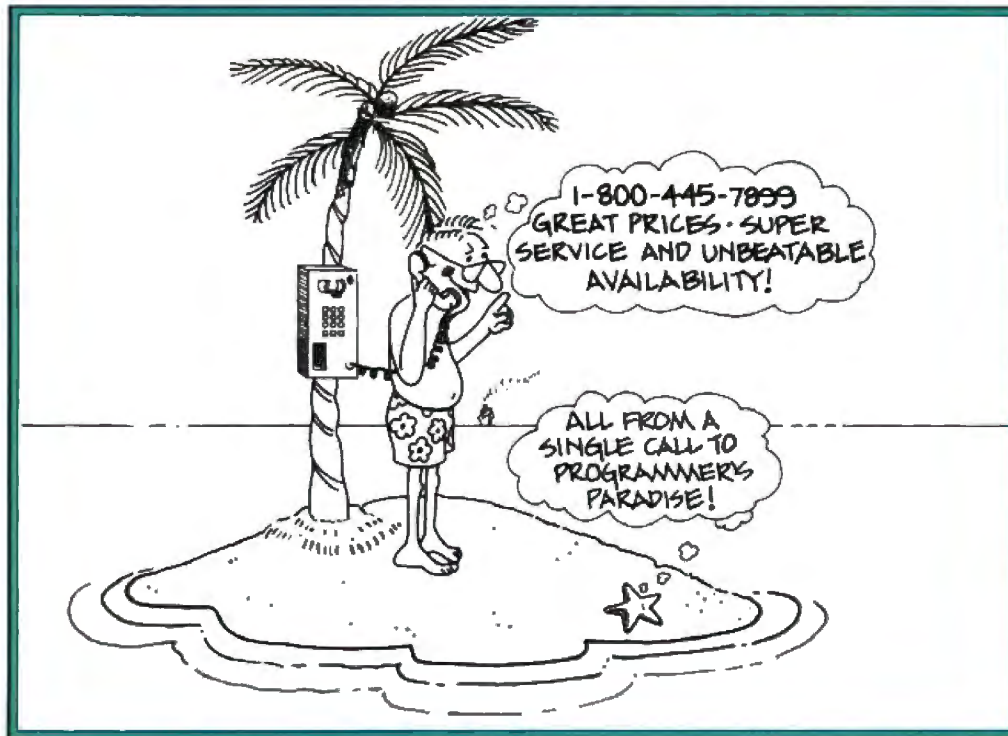

**CALL PROGRAMMERS PARADISE TODAY** and discover our commitment to bringing you the best software at the best prices. You'll also find software pros to help you select the product that you need plus immediate shipment on our stock of 1000 products and a 30-day money back guarantee. Paradise is ready and waiting for you.

## 386 SOFTWARE

386-to-the-Max	66
DESeqview	115
FoxBase +/386	459
High C-386	839
Microport	
System V/386 (complete)	759
Runtime System	209
MS Windows/386	130
NDP-C or Fortran-386	529
PC-MOS 386	CALL
Pharlap 386/ASMLink	409
SCO Xenix	
System V 386 (complete)	1279
Operating System	589
VM/386	182

## ASSEMBLERS/LINKERS

Advantage Disassembler	279
MS Macro Assembler	99
Optasm	109
Plink86plus	279
Visible Computer 80286	90

## BASIC

db/Lib	121
Finally!	90
Flash-Up	80
MS Basic Compiler 6.0	189
MS QuickBASIC	69
QBase	90
QuickPak	60
QuickPak Professional	105
QuickWindows w/Source	90
Screen Sculptor	96
Turbo Basic	69
Turbo Basic Toolboxes	69

## C COMPIERS/INTERPRETERS

C-Terp	232
Lattice C	272
Microsoft C	289
Quick C	69
Run/C Professional	159
Turbo C	69

## C LIBRARIES/UTILITIES

C Asynch Manager	137
C Tools Plus/5.0	101

C Utility Library	125
Essential Comm Library	125
Greenleaf Comm Library	169
Greenleaf Functions	155
Greenleaf TurboFunctions	109
FlorCe	215
PC-Lint	101
Pre-C	159
Resident C w/Source	169
Timeslicer	279
w/Source	899
Turbo C Tools	101

## COBOL

Micro Focus	733
COBOL/2	733
COBOL/2 Toolset	452
Microsoft COBOL	105
Opt-Tech Sort	794
Realia COBOL	999
RM/COBOL-85	382
SCREENIO	



## DATABASE COMPILERS/TOOLS

Clear	90
Clipper	399
DbFast	75
FoxBASE +	269
Hi-Screen XL	129
Integrated Development Lib.	135
Quicksilver	369
R & R	139
Say What!	45
Silvercomm Library	139

## DEBUGGERS

Periscope I	373
Periscope II	141
Periscope III-X	106
Periscope III 10 MHZ	1143
Plix 86 Plus	215
T-Debug Plus V. 4.0	39
w/Source	80

## DISK/DOS/UTILITIES

Advanced Norton Utilities	101
Command Plus V. 2.0	70
Disk Optimizer	56
Fastback Plus	142
Mace Utilities	90
Norton Commander	56
Norton Utilities	61
PC Tools Deluxe	70
Vieature	75
Vieature Deluxe	111
X-Tree Pro	111

## EDITORS

Brief	CALL
w/dbrief	CALL
EDIX	169
Epsilon	151
KEDIT	120
MKS Vi	66
Multi-Edit	90
Norton Editor	70
PC/EDIT +	269
PI Editor	165
SPF/PC	185
Vedit Plus	131

## FILE MANAGEMENT

Btrieve	185
Xtrieve	189
Report Option	109
Btrieve/N	455
Cbtree	141
c-tree	318
r-tree	241
d-tree	CALL
dBc III	172
dBc III Plus	599
dB_Vista or dB.Query	CALL
Informix ESQ/LC	539

Informix 4GL	899
Informix SQL	719
XQL	599

## FORTTRAN COMPILERS

Lahey FORTRAN	439
Lahey Personal FORTRAN 77	86
MS FORTRAN	289
RM/FORTRAN	479

## GRAPHICS

Advantage Graphics (C)	229
Essential Graphics	229
w/Source	509
GraphiC	322
GSS Graphic Dev. Toolkit	409
HALO '88	229
HALO '88 (5 Microsoft Lang.)	399
MetaWINDOW	162
MetaWINDOW Plus	232

1000 BRAND NAME PRODUCTS IN STOCK

## OBJECT-ORIENTED PROGRAMMING

Actor	423
Advantage C + +	479
C-Talk	137
PforCe + +	215
Smalltalk/V	85
Communication Applic. Pack	45
EGA/VGA Color Ext. Pack	45
Goodies #1, 2 or 3 Applic. Packs	45
Smalltalk/V286	169

## OPERATING SYSTEMS

Microport:	
286 DOS Merge	129
System V/AT	469
Runtime Package	169
Software Dev. Package	209
Text Preparation Package	169
Unlimited License Kit	209
SCO:	
Xenix System V (complete)	999
Development System	479
Operating System	479
Text Preprocessing Package	149
Xenix for PS/2 50, 60, 80	CALL
Wendin Operating Sys. Toolkits	80

## TROPICAL TREATS

Greenleaf has added several new products to its outstanding line of development tools including a 200 functions mathematics library and a new interactive screen generator/editor for Greenleaf DataWindows. Call us to order any of these or other Greenleaf Software Products.

Greenleaf Functions	155
Greenleaf Comm. Library	169
Greenleaf DataWindows	209
DataWindows for OS/2	279
TurboFunctions	109
Business Mathlib NEW	239
SuperFunctions NEW	265
Makeform NEW	125



# PARADISE 1-800-445-7899

## PASCAL COMPILERS

Microsoft Pascal	189
Professional Pascal	549
Turbo Pascal	69
Turbo Pascal Dev. Lib.	289

## TURBO PASCAL ADD-ONS

Flash-Up	80
Flash-Up Toolbox	46
Mach 2	66
Screen Sculptor	96
T-Debug Plus V. 4.0	39
w/Source	80
Turbo Asynch Plus	101
Turbo Halo	80
Turbo Magic	90
Turbo Power Tools Plus	101
Turbo Power Utilities	79
Turbo Professional 4.0	80
Turbo WINDOW/Pascal	80

## SCREENS/WINDOWS

C-Scene	282
Greenleaf DataWindows	209
Panel Plus	395
Panel/QC or /TC	99
Vitamin C	162
VC Screen	119
Windows for C	149
Windows for Data	259
w/Source	519

## ADDITIONAL PRODUCTS

APL+ Plus PC	499
Dan Bricklin's Demo Prog. II	179
FLOW CHARTING II	205
PC Scheme	86
Pfinish	215
PolyMake	131
PVCS Corporate	333
Source Print	80
Tree Diagrammer	70

## BORLAND

Eureka	119
Paradox 1.1	369
Paradox 2.0	529
Quattro	169
Sidekick	59
Turbo Basic Compiler	69
Database Toolbox	69
Editor Toolbox	69
Telecom Toolbox	69
Turbo C Compiler	69
Turbo Pascal	69
Turbo Pascal Dev. Lib	289
Turbo Tutor	45
Numerical Methods TB	69
Database Toolbox	69
Editor Toolbox	69
Gameworks Toolbox	69
Graphics Toolbox	69
Turbo Prolog Compiler	105
Turbo Prolog Toolbox	69

## MICROSOFT

MS Basic Compiler 6.0	189
MS Basic Compiler (XENIX)	449
MS Basic Interpreter (XENIX)	229
MS C Compiler	289
MS COBOL Compiler	452
for XENIX	649
MS Excel	329
MS FORTRAN	289
for Xenix	449
MS Learning DOS	39
MS Macro ASM	99
MS Mouse Serial or Bus	99
w/Easy Cad	119
w/MS Windows	139
MS OS/2 Programmer's Toolkit	229
MS Pascal Compiler	189
for XENIX	449
MS Quick BASIC	69
MS Quick C	69
MS Sort	130
MS Windows	69
MS Windows Development Kit	319
MS Windows/386	130
MS Word	285
MS Works	129

## PROGRAMMER'S PARADISE: Your source for Microsoft Products

### Microsoft® EXCEL

The soul of the new machines. Takes full advantage of the power of 286 and 386 based computers. Its unprecedented power helps you excel in three important areas: analyzing and working with your data, presenting your data, and customizing the way you work. Money back guarantee thru January 1990.

Ours: \$329.00



### Microsoft® WORD 4.0

Designed for IBM Personal Computers and compatibles and the IBM Personal System/2 series. Gives you the power and speed to create professional output quickly. For example, use function keys to bypass menus, style sheets for the ultimate in formatting flexibility, a document management system to locate files, and macros to automate any operation. Free Pageview Bistream Fontware

Ours: \$285.00



### Microsoft® WINDOWS/386

Lets you run several programs on your Intel 80386 based computer. Each can run in its own window or full screen. Switch from program to program, transfer information between them, and run programs in the background while you work on something else.

Ours: \$130.00



### Microsoft® QUICK C

Gives you the features that you need to learn C quickly. It's best for easy compilation and prototyping, compiling programs at 10,000 lines per minute. Features a built-in-editor with selectable insert or over-type mode, automatic MAKE file creation, context-sensitive help for easy learning and an integrated debugger.

Ours: \$69.00 CALL for Extra Savings on Mouse Bundle



## HOW WE WORK

### PHONE ORDERS

Hours 9 AM-7 PM EST. We accept MasterCard, Visa, American Express. Include \$3.95 per item for shipping and handling. All shipments by UPS ground. Rush service available, ask for rates when you order.

### MAIL ORDERS

POs by mail or fax are welcome. Please include phone number.

### RETURN POLICY

Our "No Hassle" policy means if you're not satisfied with a product from Programmer's, simply return it within 30 days for a refund. Some manufacturer's products cannot be returned once disk seals are broken, so check before you buy.

TECHNICAL  
SUPPORT FROM  
SOFTWARE  
PROS

## INTERNATIONAL SERVICE

Take advantage of our international business number for details on export charges and exchange rates. Payments should be made in U.S. dollars.

## DEALERS AND CORPORATE ACCOUNTS

Call and ask for our catalog and special volume discounts.

## UNBEATABLE PRICES

We'll match lower nationally advertised prices.

In NY: 914-332-4548

Customer Service:

914-332-0869

International Orders:

914-332-4548

Telex: 510-601-7602

Fax: 914-332-4021

Call or Write for  
Latest Free Catalog!

# 1-800-445-7899

## Programmer's

# Paradise™

A Division of Magellan Software Corp  
55 South Broadway, Tarrytown, NY 10591





# 0 to 60 in 5 seconds



## with new UniLab Microprocessor Development Tools

- 64Kbytes from hard disk to emulation memory in 5 seconds. That's moving. But today you've got to be fast just to stay in the race for better microprocessor designs.
- The secret is a new, high-speed parallel interface: the Orion bus. Which zips data between your PC/AT and the 8620 analyzer-emulator, breaking the RS-232 bottleneck.
- The 8620 with O-bus gives you complete program diagnosis — and solutions — in real time. For more than 150 different microprocessors. Using the same command set environment.
- A generous 2730 trace-cycle buffer with selective filtering lets you cut through the clutter and display just the traces you wish. And you get 1μsec resolution in program time measurement. Plus continuous InSight monitoring of your program's key functions as they are performed.

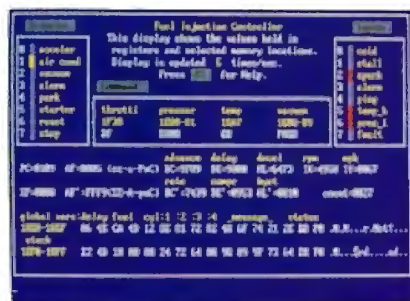

**InSight Display.** InSight blends analyzer-emulator techniques to give you continuous, real time monitoring of key processor functions. And still services user interrupts. It displays changing register contents, I/O lines, ports, user-defined memory windows. With your own labels.

- On top of that, you get UniLab's trademark ability to debug by symptom, not just by breakpoint and single step. And, to help you complete the job on time, on the spot, a stimulus generator and EPROM programmer are included.
- Ease of use, another Orion trademark, is also built in. So you have all the familiar features and formats you're used to working with. It doesn't matter if your project is a single chip controller or complex 16-bit

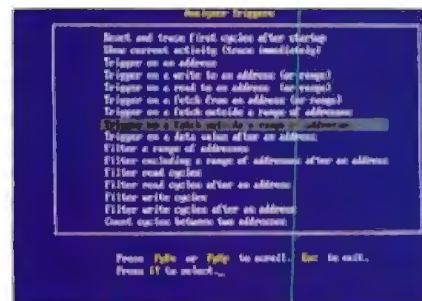

**Analyzer Triggers.** Commonly used triggers can be selected quickly from a list of standard and user-defined triggers.

microprocessor, the 8620 is the top price/performance analyzer-emulator that does it all. At just \$4380. With processor Personality Paks typically \$550 each.

- UniLab 8620. Fast-lane debugging that gets you to market quicker.

Call toll-free: 800/245-8500.  
In CA: 415/361-8883

**ORION**  
INSTRUMENTS

702 Marshall St., Redwood City, CA 94063  
TLX 530942 FAX 415/361-8970  
Computer Integrated Instrumentation

Circle 196 on Reader Service Card

# PRODUCTS IN PERSPECTIVE

- 67 **What's New**
- 89 **Short Takes**  
 TSI-020MX and Radius Accelerator 25  
 Turbo Prolog 2.0  
 SOTA MotherCard 5.0 and Microsoft Mach 20  
 Choice Words  
 Tentime
- Expert Advice:**
- 103 **Computing at Chaos Manor**  
*by Jerry Pournelle*
- 123 **Applications Plus**  
*by Ezra Shapiro*
- 129 **Down to Business**  
*by Wayne Rash Jr.*
- 135 **Macinations**  
*by Don Crabb*
- 143 **OS/2 Notebook**  
*by Mark Minasi*
- 147 **COM1:**  
*by Brock N. Meeks*
- First Impressions**
- 154 **IBM PS/2 Model 70-A21 and Tandy 5000 MC**
- Reviews**
- 164 **PostScript printers**
- 183 **Toshiba T5100 and GRiDcase 1530**
- 195 **AST Premium/386**
- 203 **Microcomputer fax cards**
- 213 **Ada on the Mac**
- 219 **Soft-ICE**
- 225 **Total Word**
- 231 **DataPlex**
- 237 **Review Update**





# IT'S TIME TO DO SOME SERIOUS 386 BUGBUSTING!

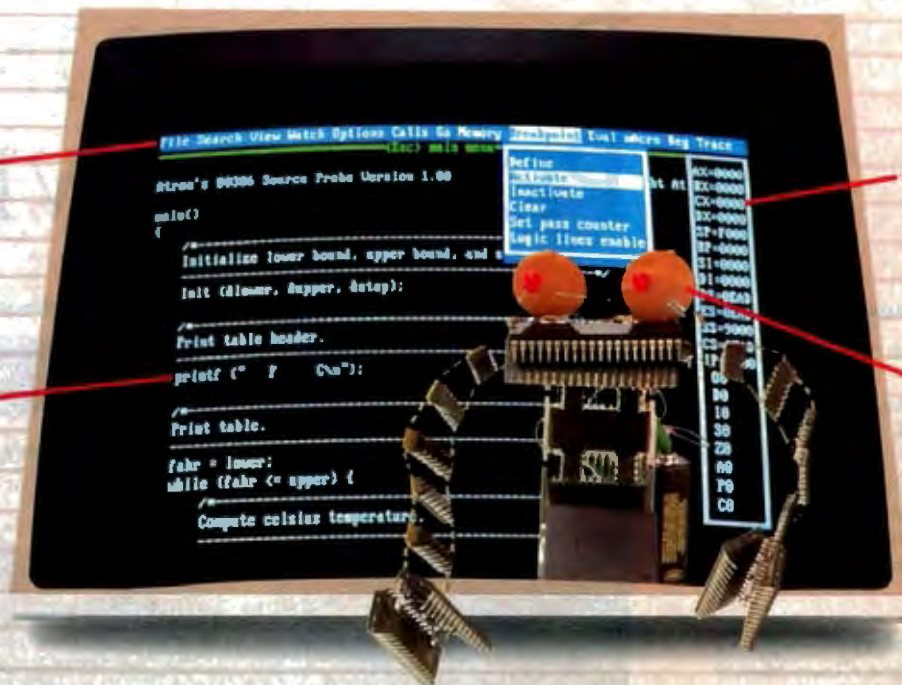

PROBE's menu bar and pull-down menus set a new standard for debugger interfaces.

POP registers up and down with a single key.

PROBE has source-level debugging to let you "C" your program.

This is an out-of-range memory-overwrite bug. Since it is interrupt related, it only appears in real time.

Welcome to your nightmare. Your company has bet the farm on your product. Your demonstration wowed the operating committee, and beta shipments were out on time. Then wham!

All your beta customers seemed to call on the same day. "Your software is doing some really bizarre things," they say. Your credibility is at stake. Your profits are at stake. Your sanity is at stake.

## THIS BUG'S FOR YOU

You rack your brain, trying to figure something out. Is it a random memory overwrite? Or worse, an overwrite to a stack-based local variable? Is it sequence dependent? Or worse, randomly caused by interrupts? Overwritten code? Undocumented "features" in the software you're linking to? And to top it off, your program is too big. The software debugger, your program and its symbol table can't fit into memory at the same time. Opening a bicycle shop suddenly isn't such a bad idea.

## THIS DEBUGGER'S FOR YOU

Announcing the 386 PROBE™ Bugbuster,\* from Atron. Nine of the top-ten software developers sleep better at night because of Atron hardware-assisted debuggers. Because they can set real-time breakpoints which instantly detect memory reads and writes.

Now, with the 386 PROBE, you have the capability to set a *qualified breakpoint*, so the breakpoint triggers only if the events are coming from the wrong procedures. So you don't have to be halted by breakpoints from legitimate areas. You can even detect obscure, sequence-dependent problems by stopping a breakpoint only after a specific chain of events has occurred in a specific order.

Then, so you can look at the cause of the problem, the 386 PROBE automatically stores the last 2K cycles of program execution. Although other debuggers may try to do the same thing, Atron is the only company in the world to dequeue the pipelined trace data so you can easily understand it.

Finally, 386 PROBE's megabyte of hidden, write-protected memory stores your symbol table and debugger. So your bug can't roach the debugger. And so you have room enough to debug a really big program.



## COULD A GOOD NIGHT'S SLEEP PUT YOU IN THE TOP TEN?

Look at it this way. Nine of the top-ten software products in any given category were created by Atron customers. Maybe their *edge* is — a good night's sleep.

Call and get your free, 56-page bugbusting bible today. And if you're in the middle of a nightmare right now, give us a purchase order number. We'll FEDEX you a sweet dream.



**BUGBUSTERS**

A division of Northwest Instrument Systems, Inc.  
Saratoga Office Center • 12950 Saratoga Avenue  
Saratoga, CA 95070 • Call 408/253-5933 today.

\*Versions for COMPAQ, PS/2-80s and compatibles. Copyright © 1987 by Atron. 386 PROBE is a trademark of Atron. Call 44-3-855-888 in the UK and 49-8-985-8020 in West Germany.



# WHAT'S NEW

## SYSTEMS

### From MS-DOS to Apple and Back

**T**wo microprocessors inside the IBM XT-compatible WPC Bridge allow it to run (without rebooting) MS-DOS as well as "proprietary Apple-booting software," according to the company. The boards connect to the IBM floppy disk drive controller and then to the monitor and serial and parallel ports. You can also load FP BASIC from Apple DOS 3.3 for better compatibility.

Inside the machine, there's a 16-bit 8088 microprocessor that runs at 4.77 MHz for normal operation or at 8 MHz for faster operations, and a 65C02 microprocessor for 1-MHz Apple DOS operation. All you do is hit Alt-Esc to go back and forth between MS-DOS and Apple software programs. The system BIOS is from Up To Date Technology.

Memory in DOS mode is 512K bytes, expandable to 768K bytes, while memory in the Apple mode is 128K bytes for the main and auxiliary banks and 16K bytes for the Apple language card. Resolution in the DOS mode is 640 by 400 pixels; Apple-mode resolution is 720 by 360 pixels.

Two internal 360K-byte 5¼-inch half-height floppy disk drives come standard and operate off the two motherboards for Apple and IBM PC compatibility. On the IBM side, there are three full-length expansion slots and a clock/calendar. Both sides support an RS-232C serial port, a parallel printer port, and CGA capabilities.

An option on the IBM PC side is a 20-megabyte 3½-inch



*WPC Bridges offer a choice of MS-DOS and Apple DOS.*

hard disk drive that requires one of the full-length expansion slots. There's a slot on the Apple side for an optional Apple drive; there's also an optional 8087 math coprocessor. An AT-compatible keyboard and a built-in 12-inch

monochrome monitor come standard.

**Price:** \$1695.

**Contact:** Cordata Technologies, Inc., 1055 West Victoria St., Compton, CA 90220, (213) 603-2901.

**Inquiry 751.**

### 25-MHz Machines with Zip!

**W**ith company ratings of 27 percent better performance than Compaq's Deskpro 386/20, Advanced Logic Research introduced the FlexCache 25386, a 25-MHz, zero-wait-state machine. It's based on a proprietary extended-emulation 82385 cache system, which the company claims is an enhancement of the Intel 82385 form of caching.

This proprietary caching system is enhanced by a 64K-byte, 25-nanosecond RAM-

caching memory between the central processor and the main memory; direct memory access (DMA) caching of RAM I/O; byte, word, or doubleword caching; posted write-through on all accesses, including bytes; and background refresh cycles. Such a caching system makes the main memory 80 percent faster than the Compaq Deskpro, the company claims.

The Model 150 comes standard with 80387 support, 1 megabyte of main memory, one 1.2-megabyte 5¼-inch floppy disk drive, one 150-megabyte enhanced-small-

device-interface (ESDI) hard disk drive, one serial port, and one parallel port. The Model 300 has a 300-megabyte ESDI hard disk drive with a controller.

**Price:** \$9499 for Model 150; \$12,499 for Model 300.

**Contact:** Advanced Logic Research, Inc., 10 Chrysler, Irvine, CA 92718, (714) 581-6770.

**Inquiry 752.**

**L**ittle features that promote using Hertz Computer's new 25-MHz machine as a file server include two cooling fans and possible hookup without floppy disk drives, keyboards, or monitors, according to the company.

Three standard versions include the big features as well. System 25/70 has a zero-wait-state 64K-byte cache with 2 megabytes of 32-bit RAM that's expandable to 24 megabytes. There's a 1.2-megabyte floppy disk drive, a 72-megabyte hard disk drive, and support for all types of 5¼- and 3½-inch drives. A VGA controller is standard.

Eight expansion slots include two 32-bit, five 16-bit, and one 8-bit. There are two serial ports and one parallel port, and the system can run anything from MS-DOS to OS/2 to Unix/Xenix.

Enhanced systems have 150- (System 25/150) and 320- (System 25/320) megabyte hard disk drives.

**Price:** \$11,995 for System 25/70; \$13,995 for System 25/150; \$15,995 for System 25/320.

**Contact:** Hertz Computer Corp., 325 Fifth Ave., New York, NY 10016, (212) 684-4141.

**Inquiry 753.**

*continued*

### SEND US YOUR NEW PRODUCT RELEASE

*We'd like to consider your product for publication. Send us full information, including its price, ship date, and an address and telephone number where readers can get further information. Send to New Products Editor, BYTE, One Phoenix Mill Lane, Peterborough, NH 03458. Information contained in these items is based on manufacturers' written statements and/or telephone interviews with BYTE reporters. BYTE has not formally reviewed each product mentioned. These items, along with additional new product announcements, are posted regularly on BIX in the microbytes.sw and microbytes.hw conferences.*



## Tallgrass Drives into the PS/2

Changing one module in the 40-megabyte tape backup system from Tallgrass Technologies upgrades the AT- and XT-compatible TG-1140 floppy disk drive to work at the faster AT and PS/2 floppy controller speed of 2.4 megabytes per minute.

You can also buy that tiny replacement module that's compatible with the 1.2-megabyte-per-minute XT-controller speed and put it into the PS/2 floppy disk drive and have a PC-compatible drive. Replacing either module takes about a minute, and you won't need any special tools.

There's also an economical 2-megabyte-per-minute tape backup subsystem in this QIC series of products that comes in Macintosh and higher storage models.

A special feature allows you to locate individual files on the tape in 20 seconds or less. Other features include automatic backup, Novell/3Com and Unix/Xenix compatibilities, and data sharing with other QIC-40 systems. Finally, tapes with 60-megabyte capacities, which will be available soon, will be compatible with the TG-1140.

**Price:** \$495 for an internal PC, PS/2, or compatible; external cabinetry, \$179; replacement module, \$79 each.

**Contact:** Tallgrass Technologies Corp., 11100 West 82nd St., Lenexa, KS 66214, (913) 492-6002.

**Inquiry 756.**

## Clearer Than Night and Day

Beyond all-black and all-white picture elements is the gray-scale level of graph-



Tallgrass PS/2, AT, or XT tape backup drives.

ic-quality that Cornerstone Technology achieves with its DualPage display.

The company's newest monitor system, which includes a custom controller, features 4 or 16 levels of gray scale. You can also view two pages simultaneously; with a 19-inch screen, the two split pages come out about 30 percent smaller than actual paper size.

The board fits into a single expansion slot on an IBM XT, AT, PS/2 Model 30, or compatible. When you couple it with Cornerstone Technology's proprietary fonts, the package is compatible with PostScript. Times Roman, Helvetica, Courier, and Symbol fonts are available.

With a standard Hercules graphics adapter in the monochrome graphics mode, you

get a resolution of 720 by 348 pixels. With the enhanced, 16-gray-level adapter (which piggybacks the standard card), resolution is enhanced to 1600 by 1280 pixels.

Refresh rate is 67-Hz non-interlaced, video bandwidth is 200 MHz, and a script-driven diagnostic program is included. Microsystems' NeWS and Microsoft's Xenix are supported. Optional drivers for desktop publishing include Ventura Publisher, AutoCAD, AutoShade, Publisher's Paintbrush, and PageMaker.

Also available is a single-page display system, which features 768-by-1008-pixel resolution with a 15-inch portrait screen.

**Price:** \$2395 for 4-gray-level system; \$2795 for 16-level system; \$999 for single-page system.

## Moniterm Conquers with the Viking

An on-board coprocessor allows the 24-inch Viking 2400 monitor to speed up certain functions and simply skip others, like slope adjustments, according to the manufacturer, Moniterm.

It's the Hitachi HD63484 ACRTC that does the work for this giant AT- and PS/2-compatible monitor with a resolution of 1280 by 960 pixels, refreshed at 66 Hz. The 24-inch display and the

coprocessor are specifically designed to accelerate AutoCAD and VersaCAD. Several operating platforms are supported, including Microsoft Windows, DRI's GEM, GSS, Media Cybernetics' Dr. HALO, and Lotus 1-2-3.

**Price:** \$2995.

**Contact:** Moniterm Corp., 5740 Green Circle Dr., Minnetonka, MN 55343, (612) 935-4151.

**Inquiry 761.**

**Contact:** Cornerstone Technology, 1883 Ringwood Ave., San Jose, CA 95131, (408) 279-1600.

**Inquiry 757.**

## Printer Races at 600 cps

A dot-matrix color printer that prints in draft mode at 600 characters per second was introduced by Honeywell Bull Italia. That's faster than most laser printers.

The new 4/68 color printer can also print up to 150 cps in letter-quality mode. The reason for such speed, the company says, is a special 18-pin print head with two 9-pin vertical arrays. During draft printing, the two arrays are lined up and allow each character to be printed in half the time. In letter-quality mode, one of the arrays is staggered with respect to the other to produce a higher-quality character.

The paper-feed mechanism allows you to print both single-sheet and fanfold paper interchangeably. If you press a front-panel button, the 4/68 automatically retracts the fanfold paper and allows you to insert a single sheet of paper through a slot in the front of the printer. Pressing another button resets the fanfold paper.

Paper-handling features allow the 4/68 to handle formats from 4¼ to 17 inches wide, from 4 to 24 inches long, and up to C-size portraits. It can accommodate up to five carbon copies and has a parking feature and bottom feed.

**Price:** \$2450.

**Contact:** Honeywell Bull Italia, 120 Howard St., Suite 800, San Francisco, CA 94105, (415) 974-4340.

**Inquiry 762.**

*continued*



**FREE**  
Advanced Math  
Applications Pack

when you buy MathCAD 2.0  
between August 1 and  
October 15, 1988.

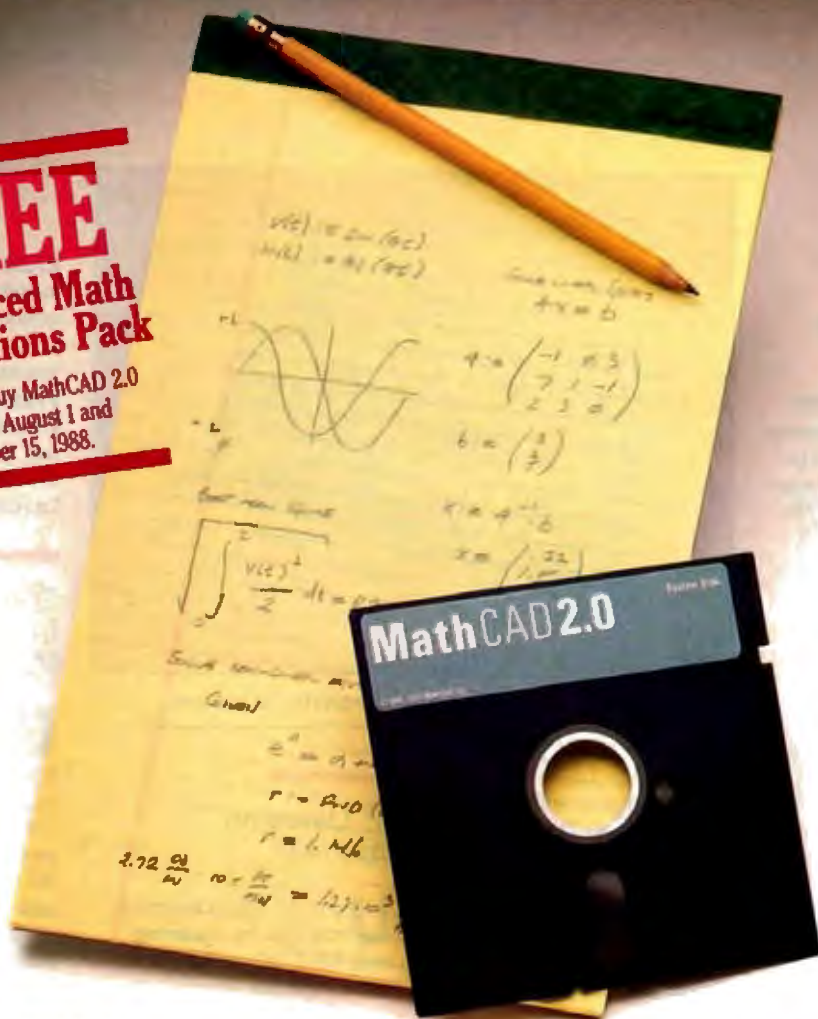

# Your pad or ours?

If you perform calculations, the answer is obvious.

MathCAD 2.0.

It's everything you appreciate about working on a scratchpad—simple, free-form math—and more. More speed. More accuracy. More flexibility.

Just define your variables and enter your formulas anywhere on the screen. MathCAD formats your equations as they're typed. Instantly calculates the results. And displays them exactly as you're used to seeing them—in real math notation, as numbers, tables or graphs.

MathCAD is more than an equation solver. Like a scratchpad, it allows you to add

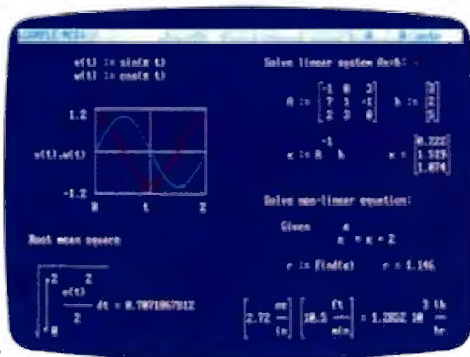

text anywhere to support your work, and see and record every step. You can try an unlimited number of what-ifs. And print your entire calculation as an integrated document that anyone can understand.

Plus, MathCAD is loaded with powerful

built-in features. In addition to the usual trigonometric and exponential functions, it includes built-in statistical functions, cubic splines, Fourier transforms, and more. It also handles complex numbers and unit conversions in a completely transparent way.

Yet, MathCAD is so easy to learn, you'll be using its full power an hour after you begin.

What more could you ask for? How about the new **Advanced Math Applications Pack**? A \$55 value, it's yours *free* when you purchase MathCAD between August 1 and October 15, 1988. The Advanced Math Pack includes a custom binder, software and documentation for 16 advanced applications such as:

- Runge-Kutta Solution of First Order Differential Equation
- Solution of Second-Order Differential Equation
- Eigenvalues and Eigenvectors of a Symmetric Matrix
- Convolution and Correlation of Sequences
- Convolutions using FFT's
- And many more!

If you're tired of doing calculations by hand or writing and debugging programs, come on over to MathCAD.

For more information contact your local dealer or call **1-800-MATHCAD, ext. 2775** (In MA: 617-577-1017 ext. 2775).

Requires IBM PC<sup>®</sup> or compatible, 512KB RAM, graphics card.  
IBM PC<sup>®</sup> International Business Machines Corporation  
MathCAD<sup>®</sup> MathSoft, Inc.

# MathCAD<sup>®</sup>

MathSoft, Inc., One Kendall Sq., Cambridge, MA 02139

SEPTEMBER 1988 • BYTE 69



## MFLOPS for Less

**A** floating-point array processor card for IBM PC XT-compatible computers promises to deliver from 8 to 25 million floating-point operations per second (MFLOPS) for under \$100 per MFLOP. That means it speeds up some (but not all) computationally intensive applications, like scientific computing, from hours to minutes, according to the company.

The half-length card is based on AT&T's DSP32 for the XT, a single processing chip with a floating-point digital signal processor. The DSP32-PC has 32K bytes of zero-wait-state static RAM. There's an upgrade available to 128K bytes of static RAM. Also available is a development system, including the board, an assembler, a window-based emulator, a math library, and demonstration programs.

In company benchmarks, a 1024-point complex fast Fourier transform was executed in 3.25 microseconds ( $\mu$ s). A finite impulse response was executed in 80 nanoseconds per TAP, and a 3 by 3 matrix multiplication was



*The DSP32-PC reduces scientific computing to minutes.*

completed in 2.2 $\mu$ s.

A C compiler will include a math library. The DSP32C, an AT board with upgrade and development system, may be available as soon as October, when AT&T ships the AT version of the chip.

**Price:** \$745 for XT board; \$50 for upgrade; \$995 for development system (including the board); the DSP32C version of the board will be under \$1500.

**Contact:** Communications Automation & Control, 1642 Union Blvd., Suite O, Allentown, PA 18103, (215) 776-6669.

**Inquiry 763.**

## 31 Users on Your AT

**U**p to 31 ASCII terminals can now be connected with RS-232C cabling to AT and compatible boards from UltraTek for distributed computing, based on Alloy Computer's NTNX operating system.

RS-232C cabling means 19.2K-bps transmission, and Alloy Computer's operating system means one Multi-Master board per terminal. Each board has an 8088 microprocessor and 512K bytes of

RAM (upgradable to 1.2 megabytes). You'll need an expansion chassis if you want to use more terminals than you have slots in your AT.

**Price:** \$695.

**Contact:** UltraTek, 400 Walnut, Suite 335, Redwood City, CA 94063, (415) 364-1060. **Inquiry 765.**

## Transform Your AT into a Multiuser Master

**O**ne full-length AT-compatible card, an interface box, a monitor, and a keyboard are now all you need to compute as far as 200 feet away from your host AT. The AT needs only full-length slots and a hard disk drive.

Add eight more cards, interface boxes, monitors, and keyboards, and you'll have the maximum number of processing stations—each with a serial and parallel port for modems and printers that can be shared by all the other stations on the network.

Each card has its own 80286, and 512K bytes of RAM running on ODOS, a DOS-compatible multiuser operating system.

Two cards are offered: The O-286H gives the stations Hercules graphics capabilities and monitor resolution up to 720 by 348 pixels; the O-286E has CGA, MGA, and EGA graphics capabilities for monitor resolutions of 640 by 200, 720 by 348, or 640 by 400 pixels, respectively.

**Price:** \$1295 for O-286H; \$1495 for O-286E.

**Contact:** Our Business Machines, Inc., 12901 Ramona Blvd., Suite J, Irwindale, CA 91706, (800) 433-1435; in California, (818) 337-9614.

**Inquiry 764.**

## Putting on the Bits

**A**n on-board BIOS supporting more than 60 hard disk drive types is standard with high-end floppy and hard disk controllers from Perstor Systems. Designed for use in 16-bit expansion slots of 80286 or 80386 AT-compatible computers, the controllers operate at 9 and 10 megabits per second.

Unlike standard Macintosh File System (MFM) and run-length-limited (RLL) controllers that support 17 and 26 sectors per track, the Perstor controllers use a pro-

prietary disk interface to increase the number of sectors per track to 31. So models PS180-16F and PS180-16FHP, which are MFM- and RLL-compatible, are rated to increase hard disk capacity by 90 percent. Model PS200-16F (only RLL-compatible) is rated to increase hard disk capacity by 100 percent. Each controller can manage two hard disks and two floppy disks, in any combination from 360K-byte to 1.44-megabyte capacities in either 3½- or 5¼-inch formats.

The PS180-16FHP's advantage over the PS180-16F is its resident BIOS cache, which runs in any combination of normal internal memory, Lotus/Intel/Microsoft Expanded Memory Specification (LIM/EMS) memory, or AT extended memory.

**Price:** \$345 for the PS180-16F; \$375 for the PS180-16FHP; \$365 for the PS200-16F.

**Contact:** Perstor Systems, Inc., 7631 East Greenway Rd., Scottsdale, AZ 85260, (602) 991-5451.

**Inquiry 766.**

*continued*

# Get Sprint and you'll never be afraid of the dark!



Nothing holds a candle to Sprint!

Features	Sprint 1.0	WordPerfect 4.2	MS Word 4.0	WordStar 4.0	MultiMate Adv. 1.0
● = Yes ○ = No					
Maximum file size	Disk	Disk	Disk	4MB	128K
Thesaurus (integrated)	●	●	●	●	●
Windows Open (maximum)	6	2	8	1	1
Files Open (maximum)	24	2	8	1	1
Cross-Reference (dynamic)	●	○	○	○	○
Indexing Options	7	1	3	3	○
Columns: Parallel	●	●	●	●	●
Snaking (chg. # same page)	●	●	Not same pg.	○	●
H-P LaserJet Support	Full	Partial	Full	Partial	Full
PostScript Support	Full	Text	Full	○	Text
Mouse Support (integrated)	●	○	●	○	○
Dynamic Shortcuts	●	○	○	○	○
Alternative User Interfaces	●	○	○	○	○
Verify Spelling as you type	●	○	○	○	○
Programmable Macro lang.	●	○	○	○	○
Save File <sup>1</sup>	5.9	41.1	9.7	4.4	1.0
Top to Bottom <sup>2</sup>	7.5	7.5	49.4	8.1	21.0
Search and Replace <sup>3</sup>	1.6	6.6	4.6	17.1	13.4
Find Unique Word	3.3	6.2	7.0	13.8	20.6
<b>Suggested List Price</b>	<b>\$199.95</b>	<b>\$495.00</b>	<b>\$450.00</b>	<b>\$495.00</b>	<b>\$565.00</b>

Time tests were performed on an Acer 286 (8 MHz), 640K RAM. <sup>1</sup>File size: 103K. <sup>2</sup>1636 lines. <sup>3</sup>14 occurrences. Times shown are in seconds. (Benchmark details available upon request.)

Prices and specifications subject to change without notice.

\*Customer satisfaction is our main concern; if within 60 days of purchase this product does not perform in accordance with our claims, call our customer service department, and we will arrange a refund.

All Borland products are trademarks or registered trademarks of Borland International, Inc. Other brand and product names are trademarks of their respective holders. Copyright ©1988 Borland International, Inc. BI 1237

Circle 34 on Reader Service Card (DEALERS: 35)

Forgetting to "Save" is a fact of life as are power outages, and it used to be that a power outage could wipe out everything you've done. Not any more. Your work is always safe when you Sprint.\*

Sprint's "Auto-Save" automatically saves your words as you type, so if the lights do go out, you may be in deep darkness but not deep trouble.

Sprint's Auto-Save is more than "insurance," it's also invisible. You know it's there, but it does its job without interrupting yours.

**Sprint: It's the word processor with everything!**

You name it, Sprint's got it. Incredible speed, Auto-Save, a customizable user interface, and professional output. Sprint even includes a bonus pack of alternative user interfaces that make it act like WordStar,\* MultiMate,\* WordPerfect,\* Microsoft\* Word, or other familiar word processors—a \$99 value free!

Sprint has all this and does all this for only \$199.95 instead of the up to \$600 that some companies demand. Sprint automatically saves your words; it also automatically saves your money. Sprint—The fast track to performance word processing.

60-Day Money-back Guarantee\*  
For the dealer nearest you  
Call (800) 543-7543



SEPTEMBER 1988 • BYTE 71



## Ethernet Meets Mac with SCSI

**B**esides becoming the floppy and hard disk controller interface of choice for both Apple and PS/2 systems, the SCSI has now become a possible local-area-networking port for industry-standard 10-megabit-per-second Ethernet connectivity.

Adaptec has introduced the Nodem, which uses the SCSI port of Apple computers this way. That means the Nodem, in the form of a 5-by-8-by-2-inch peripheral, can automatically enhance the transmission rate between Apple machines 40-fold over what was previously possible with the 230K-bit-per-second LocalTalk cabling system,



SCSI Nodem enhances AppleTalk.

while retaining Apple's connectivity operating software, AppleTalk.

Another advantage is that the Nodem doesn't use any internal slots, so you can share information more easily among the Mac Plus (which has no slots), the Mac SE (which has

one slot), and the Mac II (which has five slots).

Up to eight different devices can daisy chain on the SCSI bus for connectivity with the three most popular Ethernet transmission media—coaxial, thin coaxial (Cheapernet), and twisted-

pair copper. The Nodem architecture is based on Adaptec's I/O controller ICs, rather than traditional Ethernet chip sets. And while Macintosh system disks are available now, the company says IBM-compatible system disks should be available next year.

**Price:** \$545 for coaxial; \$595 for Cheapernet or twisted pair.

**Contact:** Adaptec, Inc., 691 South Milpitas Blvd., Milpitas, CA 95035, (408) 945-2520.

**Inquiry 768.**

## Hook up Your Network Through the AC Lines

**P**owerLink is a networking system that links any two IBM PCs or Apple Macintoshes and their printers through your building's existing power lines. And, according to its maker, you'll soon be able to expand it to interconnect up to eight systems.

The system transfers data through your computer's serial port at 19.2K bits per second. You simply plug the network device into the nearest wall outlet and you're connected to the Link network. The only limitation is that devices must be on the same side of a power transformer, but this is usually no problem if they're in the same building.

The Link hardware is provided either as an add-in card for the IBM PC and compatibles or as an external 10-inch box for serial port connections.

**Price:** \$495 for the external unit; \$395 for the add-in card; ManyLink software for two PCs, \$165; ManyLink for up to eight PCs, \$395.

**Contact:** Netline, Inc., 85 West Center St., P.O. Box 3000, Provo, UT 84603, (801) 373-6000.

**Inquiry 769.**

## Voice and Data Travel Together on the Twisted Pair

**T**wo machines compatible with AT&T and Siemens Integrated Services Digital Network (ISDN) interfaces are now available from International Computers Ltd. (ICL), a subsidiary of Standard Telephones and Cables PLC Group.

Both of the AT-compatible machines allow transmission on two 64K-bit-per-second ISDN B channels and one 16K-bit-per-second ISDN D channel (but only if you're one of the small but growing number of telephone company customers served by an ISDN central office switch).

The machines could be looked at as two luxury telephone/computer hybrids. The telephone includes more bells and whistles than the average business executive's telephone, and the manufacturer claims the 80386 version is faster than Compaq's 386/20.

The Model PWS 20 is an

8-MHz, zero-wait-state machine based on Intel's 80286 microprocessor. It comes with a 40-megabyte hard disk drive, a 720K-byte 5 1/4-inch floppy disk drive, and six 16-bit and two 8-bit expansion slots. Peripherals include an ISDN telephone, an EGA color monitor, and an AT-style keyboard. The Model PWS 386 has the same features, plus an Intel 80386 that runs at 20 MHz with no wait states.

Both models include MS-DOS 4.1, a multitasking Microsoft-designed DOS with a 640K-byte RAM limit per task. MS-DOS 4.1, which was designed earlier this year for ICL and to date has been sold only in the U.K., includes multitasking that ICL has used to provide telephone status on the computer screen's bottom four lines.

A single-slot add-in board with a proprietary S/T interface is used to connect the

computer and telephone to your local central office over standard telephone wiring. That connection, with standard RJ-45 connectors, will handle the three channels totaling the 144K-bit-per-second transmission rate.

Several ISDN features include auto-answering; directory-, speed-, and recent-call dialing; and a status display of incoming and outgoing call information. The system includes several non-ISDN connectivity features as well, including V.120 rate adaptation software and X.25 packet assembler/disassembler support over one clear 64K-bit-per-second B channel.

**Price:** \$8000 for PWS 20; \$10,000 for PWS 386.

**Contact:** International Computers Ltd., Inc., Network Systems—ISDN Group, 777 Long Ridge Rd., Stamford, CT 06902, (203) 968-7222.

**Inquiry 767.**

*continued*



# BRIDGES



## The *easy* way to move files between the 5 1/4" world of PCs, and the 3 1/2" world of PS/2s, Laptops, and 386s: Sysgen's Bridge family.

Because your PCs, PS/2s, 386s and laptops all talk to different floppy disk sizes and formats, they can become frustrating *islands* of information.

For the simplest way to get files back and forth, just install Sysgen's Bridge products. Presto: Your different computers can talk to common diskettes.

Sysgen pioneered bridges. Now here are three ways to simplify your life in a multi-computer office.

### **Solution 1: Our Bridge-File 5.25 floppy disk drive.**



A best seller, with over 50,000 installed. Attach it to your PS/2, and you can read and write files from PCs. Critics and users alike have raved

about its small footprint, ease of use, and dual density capacity of 360Kb and 1.2Mb. (IBM's drive is twice the size, yet stores only one-fourth the data.)

Every PS/2 user deserves this easy connection to the world of PCs.

### **Solution 2: Our Bridge-File 3.5 floppy disk drive.**

You get 720Kb and 1.44Mb capacities. Connect it to any PC, and you can read and write files from PS/2s, 386s, laptops, and other 3 1/2" machines.

Now all your PCs can share files with your newer systems.



### **And here's the ideal controller: The Omni-Bridge Controller.**



Controls up to four drives, so you can mix and match 5 1/4", 3 1/2", and floppy tape drives as you need. This hot card gives you big storage, plus twice the floppy disk and floppy tape transfer performance rates! At only \$95, this is a winner.

**Get your computers talking. Call the Sysgen Hotline for the name of your nearest dealer. 1-800-821-2151.**

# **SYSGEN**

INCORPORATED

556 Gibraltar Drive, Milpitas, CA 95035

SEPTEMBER 1988 • BYTE 73

Trademarks: Sysgen, Bridge-File, Omni-Bridge—Sysgen Inc.; PS/2—International Business Machines Corporation. Registered Trademark: IBM—International Business Machines Corporation.

Circle 266 on Reader Service Card



ONCE IN A BLUE MOON.....

### SCANMAN™

Pop any image up to 4" x 11" straight into your IBM PC, XT, AT, PS/2 or 100% compatible system. Clip it, crop it, resize and rotate it, color it. Merge it. Save it. Store it. Choose between high contrast or high detail. Import images into any best-selling DTP application (PageMaker, Ventura, etc.). Use it in any major publishing program. All you need is \$299, a spare card slot, and five minutes to set up.

Choice of  
← editing  
colors

### HOW ON EARTH IS THIS POSSIBLE FOR \$299?

Be comforted. ScanMan carries Logitech's Customer Satisfaction Guarantee, and includes all you need to be up and running in minutes.



Scanning window  
is over 4" wide  
(vs. 2.5" for most  
others)



# ... COMES A STROKE OF GENIUS

*Scan directly into a graphics editor where a full range of paint utilities and tools are available. ↴*



*200 dots per inch resolution*

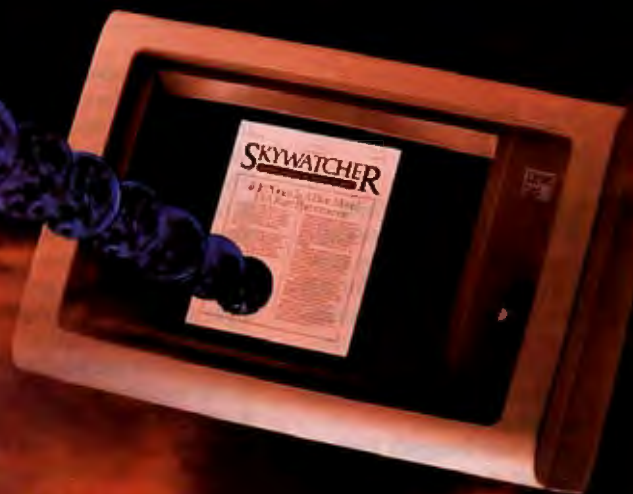

**CALL TOLL FREE: (800) 231-7717 OR (800) 552-8885 IN CALIFORNIA**  
 Please send me my ScanMan: BY988

- ScanMan for IBM PC, XT, AT, PS/2 models 25 and 30, and 100% compatibles \$299.00
- ScanMan for IBM PS/2 model 50 and above and 100% compatibles \$349.00
- Shipping and Handling (per item): \$ 6.50
- CA Residents add applicable sales tax: \$ \_\_\_\_\_
- Total: \$ \_\_\_\_\_**

Check or Money Order Enclosed     Visa     MasterCard

Card Number \_\_\_\_\_ Exp. Date \_\_\_\_\_

Cardholder Name \_\_\_\_\_ (Please print)

Authorized Signature \_\_\_\_\_

Ship to: Name \_\_\_\_\_ Phone \_\_\_\_\_

Address \_\_\_\_\_

City/State/Zip \_\_\_\_\_

Offer valid in the U.S. only. Allow 2-3 weeks for delivery. 30-day Money Back Guarantee. DEALER INQUIRIES WELCOME. Send to: LOGITECH, Inc., attn: Coupon Redemption Program, 6505 Kaiser Drive, Fremont, CA 94555

**ScanMan**

Hand-Held Scanner from



Personal Peripherals Worldwide

PageMaker is a trademark of Aldus and Ventura Publisher is a trademark of Ventura Software Inc.



## Micro Channel on a Chip

If you're designing add-in cards for the Micro Channel, One Chip Plus can make your job easier. It's a full-fledged design system that's built around a chip.

One Chip Plus contains the decoding and logic functions to simplify the design of memory, I/O, and multifunction adapter cards for PS/2 machines. It includes programmable decoding for extended memory, expanded memory, multiple I/O ports, and ROM. It also supports Micro Channel DMA arbitration and burst-mode DMA. Programmable memory and I/O timing match slow and fast devices and can connect directly to single- and dual-in-line memory modules.

A software kit includes a LIM/EMS 4.0 memory driver. A proprietary design lets you program the Micro Channel ID number rather than designing it into the hardware after being designated the number by IBM—a process that has been known to hold up the design phase.

The company's Acquisition Engine, which provides high-level programming commands for background and foreground data acquisition and I/O control in the form of a 5¼-inch floppy disk, eliminates the need for additional programming and hardware, the company says. The acquisition engine subsequently accepts software modules that interface to any I/O function. **Price:** \$34 for One Chip Plus; \$995 for a combined I/O and memory package; \$349 for the Acquisition Engine; \$95 for the Application Guide. **Contact:** Capital Equipment Corp., 99 South Bedford St., Burlington, MA 01803, (800) 234-4232; in Massachusetts, (617) 273-1818. **Inquiry 770.**



Capital Equipment's MCA design system.

## Disk Duplicators Multiply

While the floppy and hard disk duplicating companies have thus far concentrated on hardware for software developers, one duplicator company is offering less-expensive products for companies with volatile, voluminous databases.

The new Datapath Technologies' Copy Manager can copy up to four 3½-inch or 5¼-inch disks—or any combination—all at once.

The Copy Manager requires one full-length PC slot per four disks and acts as a peripheral. There's also a duplicator expansion unit that allows another four disks to be copied at one time, bringing the total to eight disks that you can copy at once, in any configuration. The Copy Manager copies 480 copies per hour in its fastest configuration.

The Model 1042 Copy Manager comes in a low-end configuration to copy four 360K-byte 5¼-inch disks. On the high end, the Model 1040 copies up to four of any combination of 3½- or 5¼-inch

disks. The Model 1052 expands any of the six Datapath four-copy versions by four 360K-byte 5¼-inch drives. The Model 1050 expands any of the four-copy versions by four drives of any configuration—both expansions increase total copying ability to eight disks simultaneously. **Price:** \$1995 for Model 1042; \$2250 for Model 1040; \$1395 for Model 1052; \$1650 for Model 1050. **Contact:** Datapath Technologies, Inc., 46710 Fremont Blvd., Fremont, CA 94538, (415) 651-5580. **Inquiry 771.**

## Throw Your Typing Skills into the Trash

A peripheral on which to write and store handwritten information allows those who haven't mastered the art of typing to have the same computer literacy as others, according to the manufacturer.

PenWriter can translate printed handwriting and hand drawings into ASCII and works with all IBM compatibles.

The peripheral is a 640- by 400-pixel backlit liquid crystal

or plasma display. Accuracy with the stylus is rated at better than 0.015 inches. Four operating modes are available: stream, switched stream, point, and incremental. **Price:** \$1895 with LCD; \$2895 with plasma display. **Contact:** Scriptel Corp., 4145 Arlingate Plaza, Columbus, OH 43228, (614) 276-8402. **Inquiry 772.**

## Storage Betters Board Testing

Digital EGA storage of sine waves gleaned from IC boards allows technicians and engineers to more quickly test board components and circuitry, thanks to the analog signature analysis tool from Huntron Instruments.

The 5100DS allows you to send a current-limited sine-wave voltage signal across two points of an add-in board, store the sine-wave traces, and then go through other boards to verify components and circuitry with an EGA graphics display of the produced sine waves. A trained eye can notice leakage and backflow problems, the company says, allowing troubleshooting of all but gate-control devices.

You need an 80286 or 80386 machine, DOS version 3.0 or higher, 640K bytes of RAM, a 3½- or 5¼-inch floppy disk drive, a 10-megabyte hard disk drive, an EGA card, an EGA monitor, and a parallel printer port. **Price:** \$9500 without controller or computer; \$14,000 for an entire system. **Contact:** Huntron Instruments Inc., 15720 Mill Creek Blvd., Mill Creek, WA 98012, (800) 426-9265; in Washington, (206) 743-3171. **Inquiry 773.**

*continued*





# JAIL

Wait for Ashton-Tate to get their SQL act together. In the meantime, just sit here and watch the ORACLE players pass you by. Or order Professional ORACLE today. The \$199 price expires on September 30th.



# ORACLE® Gives Your PC a Monopoly

- “ORACLE's top guns make dBASE look like a peasooter.”  
Data Based Advisor, June 1988
- “If it isn't in ORACLE, it probably isn't in anything else, either... For readers who want it all, this is the product to buy.”  
Software Digest, September 1987
- “A robust, full-blown mainframe database that will run on a micro ORACLE will crunch data until your eyes roll back in your head.”  
Infoworld, April 1988
- “Well constructed and powerful, Professional ORACLE is an excellent choice for... application developers.”  
Winner, Editor's Choice, PC Magazine, May 1988
- “Professional ORACLE is the program of choice for those who want sophisticated forms, reports, and SQL capabilities without having to program extensively.”  
Software Digest Ratings Report Advanced Relational Database Programs, September 1987
- “...provide(s) applications developers with unlimited power... Security provided by [ORACLE] on the single-user PC is as extensive as it is on the largest mainframe.”  
PC Tech Journal, December 1987

**The experts agree** When you buy the ORACLE database for your PC, you acquire several important ORACLE monopolies.

**COMPATIBILITY:** ORACLE is SQL, compatible with IBMs DB2 and SQL/DS.

**PORTABILITY:** It's the only RDBMS that runs on mainframes, minis and PCs.

**CONNECTABILITY:** It's network ready with the unrivalled ability to make different databases on different machines — mainframes, minis and micros — appear to be one database on one machine. Finally, **PRICE:** Tens of thousands of copies of ORACLE for the PC have sold for \$1295. But until September 30th, 1988 you can see what made Oracle Corporation the world's largest database company, and what has the experts so excited.

Pass GO and collect Professional ORACLE for only \$199.\* Or go to JAIL with some really old technology.



Call 1-800-ORACLE1, ext. 149 or an ORACLE MasterVAR today.



# GO TO JAIL



## GO ORACLE

PC ORACLE OFFER • Oracle Corporation  
20 Davis Drive • Belmont, California 94002

Enclosed is my business card or letterhead.  
(no PO boxes, please) with a  check or  VISA  
 MC  AmEX credit card authorization. I want to pass GO and collect \_\_\_\_\_ copies of Professional ORACLE, licensed for developers, for only \$199\* each

\$ \_\_\_\_\_ for Professional ORACLE  
\$ \_\_\_\_\_ Please add appropriate sales tax  
\$ \_\_\_\_\_ TOTAL enclosed or authorized

Credit Card # \_\_\_\_\_ Exp. Date \_\_\_\_\_  
Phone \_\_\_\_\_  
Signature \_\_\_\_\_

\*PRICES VARY IN THE U.S. & CANADA ONLY. REQUIRES AN 80286/80386 PC WITH 640KB MAIN MEMORY, 1MB EXTENDED MEMORY AND DOS 3.0. © 1988 BY ORACLE CORPORATION. ORACLE IS A REGISTERED TRADEMARK OF ORACLE CORPORATION. MONOPOLY IS A REGISTERED TRADEMARK OF PARKER BROTHERS. dBASE IS A REGISTERED TRADEMARK OF Ashton-Tate. COVERS OF THE MAGAZINES SHOWN ARE COPYRIGHTED BY THEIR RESPECTIVE PUBLISHERS.



## Testing Embedded Software

Archimedes calls it the first microcontroller simulator with a C source-level debugger. SimCASE is a window-based program that allows you to create software prototypes without any target hardware. It debugs C programs at the source level and locates bottlenecks in your code. The simulator consists of the Simulator Engine, the C & A Assembler Source Debugger, the Performance Analysis Tool, and the Input Stimulus Generator.

The Simulator Engine simulates the microcontroller on the computer, including the instruction set, the interrupt handling system, and all I/O ports. The Source Debugger gives you the option of symbolic and source debugging on the C or assembly level. It includes tools like trace, code and data examinations, step, and breakpoints.

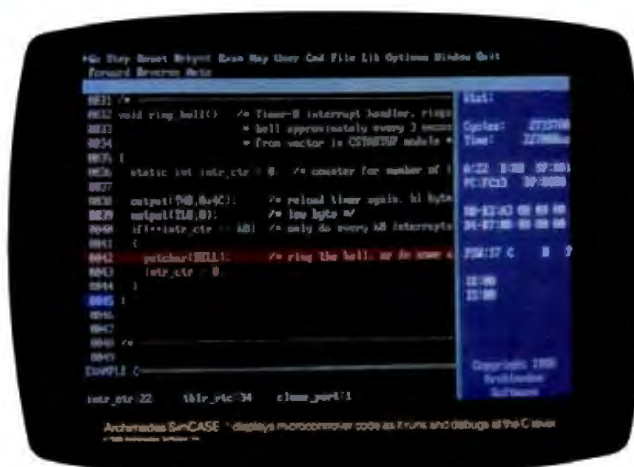

SimCASE displays and debugs microcontroller code.

The Performance Analysis Tool tests your design ideas by giving you the execution times of every block and line of code and helps you identify bottlenecks in the design.

You can graphically display the execution profile of a program with the Performance Analysis Tool. The Input Stimulus Generator takes a disk file you've created that contains a stream of input signals and tests the program for response to external stimuli. Once your code is tested

with SimCASE, you can download it to EPROM or to an emulator for final testing.

The kit is available for the 8-bit Intel 8051 family. It runs on the IBM PC, XT, AT, and compatibles with at least 640K bytes of RAM and DOS 2.1 or higher. It also requires an Archimedes C cross-compiler kit. Price: \$895.

Contact: Archimedes Software, Inc., 2159 Union St., San Francisco, CA 94123, (415) 567-4010. Inquiry 779.

## Develop AI Applications Under OS/2

Production Systems Technologies reports that OPS83 was the first language to integrate procedural and rule-based programming. Now the company has introduced OPS83 for OS/2, enabling you to develop larger artificial-intelligence applications in protected mode. Applications under OS/2 can have at least 32 times as many rules or data items as applications under MS-DOS, according to Production Systems Technologies.

OPS83 has a Pascal-like syntax. It supports separate compilation for program development efficiency and stan-

dard subroutine linkages that allow you to interface with other languages. The development environment is coded in C and assembly language. It requires the Microsoft C Compiler and an IBM PC or

compatible running OS/2. Price: \$2950.

Contact: Production Systems Technologies, 5001 Baum Blvd., Pittsburgh, PA 15213, (412) 683-4000. Inquiry 776.

## Programming from a Menu

With the introduction of EngLan, computer programming is simplified to the point of choosing functions from a menu. Gentry Software reports that debugging is limited to removing logic errors, because the code you choose is already written. Each time you choose a new command, it is displayed at the bottom of the screen, and you can make changes using the

view/change submenu.

The program is designed for small-business and general-application programs. It runs on the IBM PC and compatibles with 256K bytes of RAM. Price: \$49.95.

Contact: Gentry Software, P.O. Box 4485, Springfield, MO 65808, (800) 346-9475; in Missouri, (800) 634-8439. Inquiry 775.

## C Is for Database Management

Code Base is a C library that uses the same naming conventions as dBASE and is compatible with dBASE III Plus. You can operate Code Base as a multiuser program on a network file server, with record and file locking.

According to Sequiter Software, there are 93 external Code Base routines organized into 9 modules. The program indexes three times faster than dBASE III Plus, Skip 100 is 100 times faster, and it executes Do While loops 1000 times faster, Sequiter reports.

To run Code Base you need Turbo C, Quick C, or Microsoft C 5.0 or 5.1. Price: \$149 (includes source code). Contact: Sequiter Software, Inc., P.O. Box 5659, Station L, Edmonton, Alberta, Canada T6C 4G1, (403) 439-8171. Inquiry 774.

## Modula-2 for OS/2

Operating in what Logitech calls "dual mode," its OS/2 version of Modula-2 lets you port applications between DOS and OS/2, as well as develop applications that run under real and protected mode.

Included in Modula-OS/2 is Logitech's text editor. It features multiple windows and menus along with a customizable user interface. The OS/2 version of the editor lets you use it with or without a mouse and compile in the background or foreground. Price: \$349. Contact: Logitech, Inc., 6505 Kaiser Dr., Fremont, CA 94555, (415) 795-8500. Inquiry 778.

continued



# Will The Real VGA Please Stand Up

It's easy to identify the leader in VGA resolution—just look to the company that brought you the *first* 800 x 600 EGA card.

## 800 x 600 VGA with 256 Colors

1024 x 768, too. Either way, Genoa's SuperVGA HiRes™ is the best way to see VGA. And your spreadsheets will look great, with 132 columns and 60 rows for your viewing pleasure.

## Crash-free Windows

Yes, we do Windows—no problem. And SuperVGA HiRes is compatible with both the VGA PS/2 monitors and the EGA Multisync monitors, in VGA and EGA modes.

So don't settle for inadequate imitations. Get the highest VGA performance at the best price, in true Genoa tradition.

For the dealer nearest you, contact: Genoa Systems Corporation, 73 E. Trimble Road, San Jose, CA 95131  
FAX: 408-434-0997 Telex: 172319  
Telephone: 408-432-9090



Genoa Systems Limited (U.K.) Tel: 01-720-5064

© 1987 Genoa Systems Corporation. SuperVGA HiRes is a trademark of Genoa Systems Corporation. Windows is a trademark of Microsoft, Inc. Multisync is a trademark of NEC Home Electronics.



## CAD on the Mac

**G**eneric CADD, previously running only on the PC, now runs on the Mac. The Mac program offers the same computer-aided drafting and design capabilities, according to Generic Software.

You can create drawings from a set of simple objects, including points, lines, circles, arcs, ellipses, and B-spline curves. You can draw objects in up to 256 colors, layers, and line types; and you can move, copy, erase, or break objects, rotate them at any angle, and scale them.

The Macintosh version lets you edit multiple drawings in separate windows simultaneously. You can cut and paste objects between different windows within the program and with other programs using the PICT format.

Generic CADD Level 1 for the Mac is also compatible with MultiFinder. It runs on the Mac II, SE, and Plus.

**Price:** \$99.50.

**Contact:** Generic Software, Inc., 8763 148th Ave. NE, Redmond, WA 98052, (206) 885-5307.

**Inquiry 784.**

## High-Speed Simulation

**D**SIM, an event-driven, interactive, mixed-level simulator that supports switch- and gate-level simulation, now runs under OS/2. You can use the program for digital simulation, and it has special features for MOS (metal-oxide semiconductor) circuits.

The OS/2 version of DSIM can simulate a maximum of 7000 gates using 1 megabyte of memory. Under DOS, using 640K bytes, it could simulate a maximum of 2500 gates. The OS/2 version supports all the



*Generic CADD makes its Macintosh debut.*

features available in the DOS version, including switch-level simulation, interactive waveform display, and tabular display functions.

**Price:** \$1250 for the OS/2 version; \$495 for the DOS version.

**Contact:** Roche Systems Corp., 1705 North Rankin St., Appleton, WI 54911, (414) 733-6077.

**Inquiry 782.**

## Another CAM?

**C**AM. This time, it stands for computer-aided mathematics. CompMath 1.02 is a menu-driven advanced mathematics program that contains general, complex, matrix, engineering,

and statistical mathematics.

Under the general math option, you can calculate factorials, angular units, log-to-any-base conversion, and rectangular/polar conversion with graphs. You can also calculate  $n$ th roots. The complex math option lets you perform addition, subtraction, multiplication, and division of complex numbers raised to real powers. You can calculate complex roots and exponents and plot complex graphs.

The matrix math option offers matrix inversion, add/subtract math, multiplication, and transposition operations.

The engineering selection is an introduction to engineering math, with polynomial, quadratic, and simultaneous equation calculations, and derivative and integration.

The statistical option on the menu lets you choose to load numerical data from a

keyboard or disk file and store to disk. It lets you perform basic statistical mathematics and plot bar graphs or scatter graphs with regression line plotting.

The program's graphics capabilities let you plot graphs in polar/Cartesian coordinates and a variety of other functions.

CompMath 1.02 runs on the IBM PC and compatibles with at least 256K bytes of RAM, DOS 2.0 or higher, and a CGA, EGA, or Hercules monochrome graphics card.

**Price:** \$49.  
**Contact:** Bsoft Software, 444 Colton Rd., Columbus, OH 43207, (614) 491-0832.  
**Inquiry 786.**

## Statistical Software

**A** program that performs multiple regression analyses on data sets of up to 50 independent variables and any number of observations was announced by YakiSoft of Canada.

YREG reads data from ASCII files and can be used interactively or in batch mode. It produces the usual regression output, as well as predicted values, residuals, influence diagnostics, and a plot of residuals versus predicted values. Univariate statistics, including mean, variance, minimum, and maximum, are produced for each variable.

The program runs on the IBM PC and compatibles with 256K bytes of RAM. You'll need a CGA display for residual plots.

**Price:** \$33.  
**Contact:** YakiSoft, P.O. Box 4151, Station C, Ottawa, Ontario, Canada K1Y 4P3, (613) 733-4563.  
**Inquiry 783.**

*continued*





# Now that the best name in CAD is this affordable, why settle for a generic brand?

What's in a name? When it comes to the Autodesk name, a lot. In fact, it's the best-selling, most well-respected name in the CAD business. There simply is not another company with the credentials to make that claim.

That's why you shouldn't settle for anything less than AutoSketch,<sup>®</sup> the best way to get started in CAD. AutoSketch is the precision drawing tool from the Autodesk family of products. Not only is AutoSketch priced at just \$79.95,\* but unlike some entry-level CAD products, you don't have to keep spending more to add the features AutoSketch already has. Standard features like boxes, circles, stretching, mirroring and rotating—to mathematical precision. And advanced CAD capabilities like dynamic PAN and ZOOM and automatic dimensioning and scaling, in up to 10 working layers.

Of course, if you do want to move up from AutoSketch at some point, your files can easily be uploaded into AutoCAD.<sup>®</sup>

AutoSketch runs on IBM<sup>®</sup> PC/XT™/AT<sup>®</sup> and 100% compatible computers, and supports IBM's PS/2.<sup>™</sup>

So if you're ready for CAD, why not go with the name that rates highest among both critics and users? Anything else is, well, second-rate.

To order AutoSketch call 1-800-223-2521. For the name of your nearest AutoSketch Dealer or for more information, call 1-800-445-5415 Ext. 1 or write to AutoSketch, 2320 Marinship Way, Sausalito, CA 94965.

**AUTODESK, INC.**



*Circle 23 on Reader Service Card*

\*A speed-enhanced version (8 times faster), requiring a math coprocessor, is available for \$99.95.

AutoSketch and AutoCAD are registered in the U.S. Patent and Trademark Office by Autodesk, Inc. IBM and Personal Computer AT are registered trademarks of International Business Machines Corporation. Personal Computer XT and PS/2 are trademarks of International Business Machines Corporation.





## UserSoft/C is the Business C

UserSoft Business C is the financial C compiler that makes sense to both clients and programmers. It is not just another C compiler.

### Compare the functions:

UserSoft Business C is a superset of Power C, Microsoft C and Turbo C. It has over 1,000 standard and business development functions. The SuperIOR component of UserSoft Business C has the input/output features of COBOL, PL/1, FORTRAN and BASIC and yet can read financially formatted data (eg. \$2,109.87 CR). UserSoft Business C has 36 easy-to-use matrix functions for management science (operational research), business statistics, finite element and circuit analysis.

### Compare the Portability:

UserSoft Business C supports the latest features of standard ANSI C. If you already have a C compiler (MS-DOS, UNIX, VS, VMS, MVS, etc.) our Business Development Tool package will commercialize your compiler for only \$199.95 for PCs. This package is suitable for IBM, Wang, Sun, VAX and other systems.

### Compare the Documentation:

The UserSoft Business C manual provides actual programming examples for every function — over 1,000 of them.

### Compare the Product:

UserSoft Business C is the capability union of C + COBOL + BASIC + PL/1 + FORTRAN + Make + SCREEN:PC version of UNIX's curses + database tools + graphic tools + IBM mainframe's VSAM + a multiple window graphic debugger and more.

### Compare the Price:

It's a fraction of what you might expect — the complete UserSoft Business C package is available at the introductory price of \$249.95 while the Business Development Tool Package is available for \$199.95.

*"In our testing, none of your claims have failed. It is to our advantage to use SUPERIOR, SAM and SCREEN for our research. I strongly recommend that all professional program developers use SUPERIOR, SAM and SCREEN for artificial intelligence, scientific, engineering, industrial, financial and especially business related applications."*

Dr Paul R Schroeder, PhD (MIT)  
President of Maximum Storage, Inc.  
Co-Founder of INMOS US  
Sole Designer of Mostek 4116  
Co-Designer of Mostek 4027

## UserSoft Business C: The ultimate C language for business & financial applications

UserSoft Business C is a new ANSI compatible compiler that runs faster and easier than Microsoft C and has more functions than Turbo C®. It cuts coding for business and financial applications by at least 50% - 90%.

**If You're Just Beginning,**  
UserSoft Business C makes learning C a pleasure.

**If You're Programming In  
COBOL, BASIC or FORTRAN,**  
switching to UserSoft Business C will be easier than you expect. UserSoft Business C retains the best of these languages while simplifying C without loss of any standard C features.

**If You're Programming in C,**  
you may switch to UserSoft Business C or enhance your current compiler with our Business Development Tool package. This will give you UserSoft Business C capabilities on most popular systems such as Microsoft C, Power C, Turbo C, UNIX C, and Wong VS C.

## UserSoft Business C: With a new state-of- the art C debugger

UserSoft Business C debugger will reduce the time you spend debugging your C programs by at least a factor of 10. It allows you to debug graphics programs on a single monitor.

## UserSoft Business C: The World's most versatile Data Manager and Database Tool

Our Structured/Access Method (S/AM) allows:

- unlimited types of key (including graphics)
- unlimited numbers of key parts
- unlimited numbers of data fields
- mixing of fixed and variable lengths for data fields or key parts
- data encryption from file level down to byte level
- unlimited devices for storing a key part or a data field
- unlimited size for any key part
- unlimited number of tables
- unlimited concurrently open files
- maximum protection on data security

S/AM is well suited for applications to finance, banking, business, imaging, artificial intelligence, knowledge-based information, science, engineering, simulation and industrial control.

### Business Development Tool Package

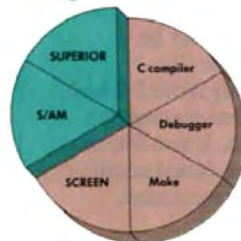

UserSoft Systems Limited  
Suite 1512, 409 Granville St  
Vancouver, BC, Canada V6C 1T2  
Telephone 604/681.8872

Power C is a trademark of Mic Software  
MS-DOS, Microsoft C is a registered  
trademark of Microsoft Corporation  
Turbo C is a registered trademark of  
Borland International  
IBM, MVS and VSAM are trademarks  
of International Business Machine  
Sun is a trademark of Sun Microsystems  
DEC, VMS and VAX are trademarks of  
Digital Equipment Corporation  
UNIX is a trademark of Bell Laboratory  
VS is a trademark of WANG Laboratory

To order Call: 1-800/663-0322  
60 Day Money Back Guarantee  
Not Copy Protected

See us at Comdex 88 at the  
Tropicana Booth — T617



# USERSOFT

If within 60 days of purchase, this product does not perform in accordance with our claims, call our customer service department and we will arrange a refund.

All UserSoft products are trademarks or registered trademarks of UserSoft Systems Limited. Other brand and product names are trademarks or registered trademarks of their respective holders. Copyright © 1988 UserSoft Systems Limited.



## Professional Write Adds Features

If you're already a Professional Write user, you'll find that, with version 2.0, you can now read and write to files from other programs, you have a choice of many preset fonts, there's a new file-finder capability, and you have enhanced table-editing features.

Version 2.0 lets you integrate database management and spreadsheet data into your word-processing documents without converting from one format to another. You can even import Lotus 1-2-3 named ranges and coordinate ranges, and you can merge data from dBASE III, ASCII, or Professional Write's own address book into form letters without any conversion.

When it comes time to choose a font, you call up a menu of preset fonts, including those for Hewlett-Packard LaserJet and DeskJet printers, Apple LaserWriters, and other PostScript printers.

The file-finder capability lets you sort DOS directory listings by filename, extension, date, or size. If you forget the name of a file, you can search for it with a string of characters that may be contained in the file.

Professional Write 2.0 lets you manipulate rectangular blocks of text. It also features a built-in five-function calculator that can recalculate rows of numbers.

Version 2.0 runs on the IBM PC, XT, AT, and compatibles with at least 512K bytes of RAM and DOS 2.0 or higher.

**Price:** \$199.

**Contact:** Software Publishing Corp., 1901 Landings Dr., P.O. Box 7210, Mountain View, CA 94039, (415) 962-8910.

**Inquiry** 791.



*Professional Write 2.0: a word processor for managers.*

## Wordbench: Tools for Writing

Addison-Wesley's Wordbench word processor runs on the IBM PC and the Apple IIc, IIc, and IIGS.

The program is made up of an outliner, notetaker, add-in manager, writer, print manager, and folder manager. The

outliner and notetaker are integrated so you can assign or reassign notes to any point in the outline. If you move headings, the program automatically moves the corresponding notes. You can then merge all the notes and the outline into a first draft.

Notetaker can also work as your information manager, allowing you to search notes by subject, key words, or priority

markings. You can also edit and print notes.

The add-in manager lets you integrate future applications and features. Brainstormer is the first add-in included with Wordbench, and it includes freewriting, invisible writing, nut shelling, and goal setting. Freewriting lets you write in a continuous stream, but not edit. Invisible writing conceals words as you enter them. Nut shelling limits the amount of space in which you can write, and goal setting asks for subject, point of view, audience, and purpose of writing.

The writer facility in Wordbench manages the writing, editing, and formatting tasks and also serves as the merging point between the outliner and the notetaker. You can also use the writer to import and export information from other programs in ASCII format.

Some of the desktop tools in Wordbench include the viewer, a window that lets you see and work with two documents at once, a spelling checker, a thesaurus, word search, and a format tool.

The folder manager maintains files; it gives you access to macros and keeps track of all the documents in a folder.

Finally, the print manager contains all the commands and functions that enable you to print a document.

Wordbench runs on the IBM PC, XT, AT, and compatibles with 256K bytes of RAM and DOS 2.0 or higher. The Apple version requires 128K bytes of RAM and ProDOS 8.

**Price:** IBM version, \$189;

Apple version, \$149.

**Contact:** Addison-Wesley, One Jacob Way, Reading, MA 01867, (617) 944-3700.

**Inquiry** 788.

*continued*

## From Integration to Decision Support

The upgraded Framework III represents a new strategy for Ashton-Tate, which no longer views Framework as an integrated package, but as a decision-support program.

Enhancements to Framework include the ability to import and export files with WordPerfect or Lotus 1-2-3 version 2.01, and the ability to run other applications without leaving Framework. It also has support for memory beyond the 640K-byte limit, mouse support, a thesaurus, and electronic mail.

Better performance shows up in the more powerful outliner, easier file management, better dBASE compatibility, a spreadsheet that recalculates 50 to 100 percent faster, and verb tokenization to speed up per-

formance of programs written with Framework's applications language.

The new telecommunications and network support in Framework III uses Action Computing's MHS (Message Handling System) message format.

A local-area-network (LAN) version of Framework III is scheduled to be released soon, according to Ashton-Tate.

Framework III runs on the IBM PC, XT, AT, and compatibles with 640K bytes of RAM and DOS 2.0 or higher.

**Price:** \$695; LAN version, \$995.

**Contact:** Ashton-Tate, 20101 Hamilton Ave., Torrance, CA 90502, (213) 329-8000.

**Inquiry** 787.





# Emulate The Best With The Brightest.

There's no denying the availability of some outstanding dedicated terminals to access Digital®, Hewlett-Packard, and Data General® host systems. Which makes the task of precisely emulating the performance of those dedicated terminals on an IBM® PC or compatible a rather significant challenge.

Based on the feedback we've received from SmarTerm® users, our family of terminal emulation software has met the challenge, passed every test, and surpassed, in the opinion of a host of enthusiastic users, the performance of the host system terminals being emulated.

The reasons why we shine are fundamental.

Every SmarTerm emulation is precise. So precise, in fact, that a dedicated terminal's SmarTerm counterpart fully emulates not only advanced performance features but also unique terminal quirks and bugs.

Every SmarTerm emulation is easy to use. It's one thing to make software do what hardware does. It's another challenge to minimize software's human wear. The people designing our products understand the nature of the people using them.

Every SmarTerm emulation is easy to learn. These days, training costs are a hot topic. Software intended to boost overall system efficiency must recognize the value of learning speed. We have.

It's also easy to learn more about how SmarTerm emulations can help you shine. Your software dealer can supply all the details. Or you can contact us at (608) 273-6000 to request complete specifications and a demonstration disk of the SmarTerm emulation that precisely matches your requirements.

**persoft®**

© 1988 Persoft, Inc. 465 Science Drive, Madison, Wisconsin 53711 U.S.A. Persoft and SmarTerm are registered trademarks of Persoft, Inc. All Rights Reserved. IBM is a registered trademark of International Business Machines Corporation. Digital is a registered trademark of Digital Equipment Corporation. Data General is a registered trademark of Data General Corporation.



## Have a Blast with Your Mac

With MacBlast at each end of a data transfer, you can send data to other vendors' systems from a Mac Plus, SE, or II. MacBlast uses pull-down menus that give you access to DEC VT-52, VT-100/200, and other terminal emulations. The communications program also supports MultiFinder and lets you switch back and forth between other applications.

MacBlast retains many of the features found in other products in the Blast family, including auto-dialing; auto-log-in to remote systems; automated modem operations; and BlastScript, a programming language that lets you set up repetitive tasks or scripts.

MacBlast supports the MacBinary standard and uses a proprietary full-duplex protocol to send data in both directions at once. It operates through RS-232C ports with a hard-wired link or phone line and modem, or over asynchronous links over Ethernet or AppleTalk networks. It can send and receive binary files, text, and console commands. **Price: \$195.**

**Contact:** Communications Research Group, 5615 Corporate Blvd., Baton Rouge, LA 70808, (504) 923-0888. **Inquiry 794.**

## Share and Share Alike

You can share hard disks and printers with one to four other users with Connect-PC. The utility gives you access to the servers' disks on a file-by-file basis. And you can use it in multiuser applications, as it supports DOS file and record locking.

The utility also supports up to three serial or parallel

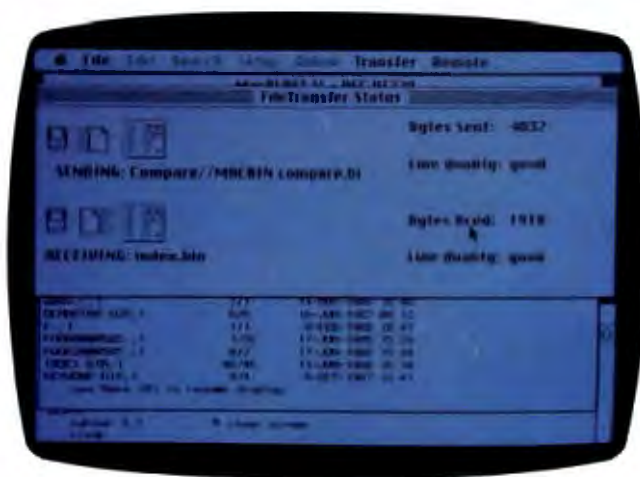

MacBlast performs simultaneous sends and receives.

printers at the server. It can send up to 1000 characters per second to each printer, according to Micro Advice. Using the advanced print options, your printer output is saved on disk, allowing you to generate output whenever you need it.

Micro Advice reports file transfer speeds of up to 115,000 bps for Turbo XTs, ATs, and 80386s, and 56,000 bps for XTs.

Connect-PC comes in two

varieties. The first is the software server, which has no hardware other than the COM ports. The second type is the hardware server, which includes software and a board. **Price: \$199 for two PCs; \$299 for three; \$649 for four (includes board); \$749 for five (includes board).**

**Contact:** Micro Advice Corp., 400 Phillip St., Unit 9, Waterloo, Ontario, Canada N2L 5R9, (519) 884-4231. **Inquiry 793.**

## Fast File Transfers

Fastwire II lets you exchange data between 5¼-inch and 3½-inch floppy disk drives or hard disk drives on different machines. When running in parallel mode it transfers at a rate of 500K bits per second, Rupp Brothers reports.

In what the company calls Turbo Serial mode, it transfers at 200K bps using seven-wire serial cable. Fastwire II features error-checking and three user interfaces.

With the basic version of Fastwire II, you have a choice of one 6-foot serial or parallel cable, both with thumbscrews that fit IBM PCs, laptops, and PS/2s. A 4-head serial cable comes with 25-pin and 9-pin AT-

style connectors. To use Fastwire II, you connect the cable to your system and load the software onto each computer. No changes to the config.sys file are necessary, and the program automatically connects the machines and selects the proper serial or parallel ports.

The three levels of user interfaces include the split-screen mode, which displays current directory files on both computers; macro/script form mode, which lets you write and record customized scripts for daily or routine transfers; and advanced command mode, which provides you with a command-line interface that allows you to enter complex transfer commands with just

## Track Action Across a Network

Track action of work-groups with ActionTracker, a project-management program from Information Research. The network version of ActionTracker integrates the activity of each member of a network so everyone knows who's responsible for what and when.

The network version runs on Novell's Advanced Netware 286 and any DOS 3.1 NETBIOS network, according to the company. It includes Project Query Language (PQL), ActionTracker's relational report writer. **Price: \$1498.**

**Contact:** Information Research Corp., 2421 Ivy Rd., Charlottesville, VA 22901, (800) 368-3542; in Virginia, (804) 979-8191. **Inquiry 795.**

*continued*

a few keystrokes.

You can also use Fastwire II to back up and manage files on a hard disk. You can back up only the most recent files or those that have been altered since a specified date. You also have options to view, rename, or delete files on either system.

Fastwire II runs on the IBM PC and compatibles with at least 170K bytes of free memory and DOS 2.0 or higher.

**Price: \$129.95 for basic version; \$159.95 for deluxe version with both serial and parallel cables.**

**Contact:** Rupp Brothers, P.O. Drawer J, Lenox Hill Station, New York, NY 10021, (212) 517-7775. **Inquiry 792.**



# FACT:

## MORE AND MORE PEOPLE ARE SWITCHING TO TOPSPEED MODULA-2

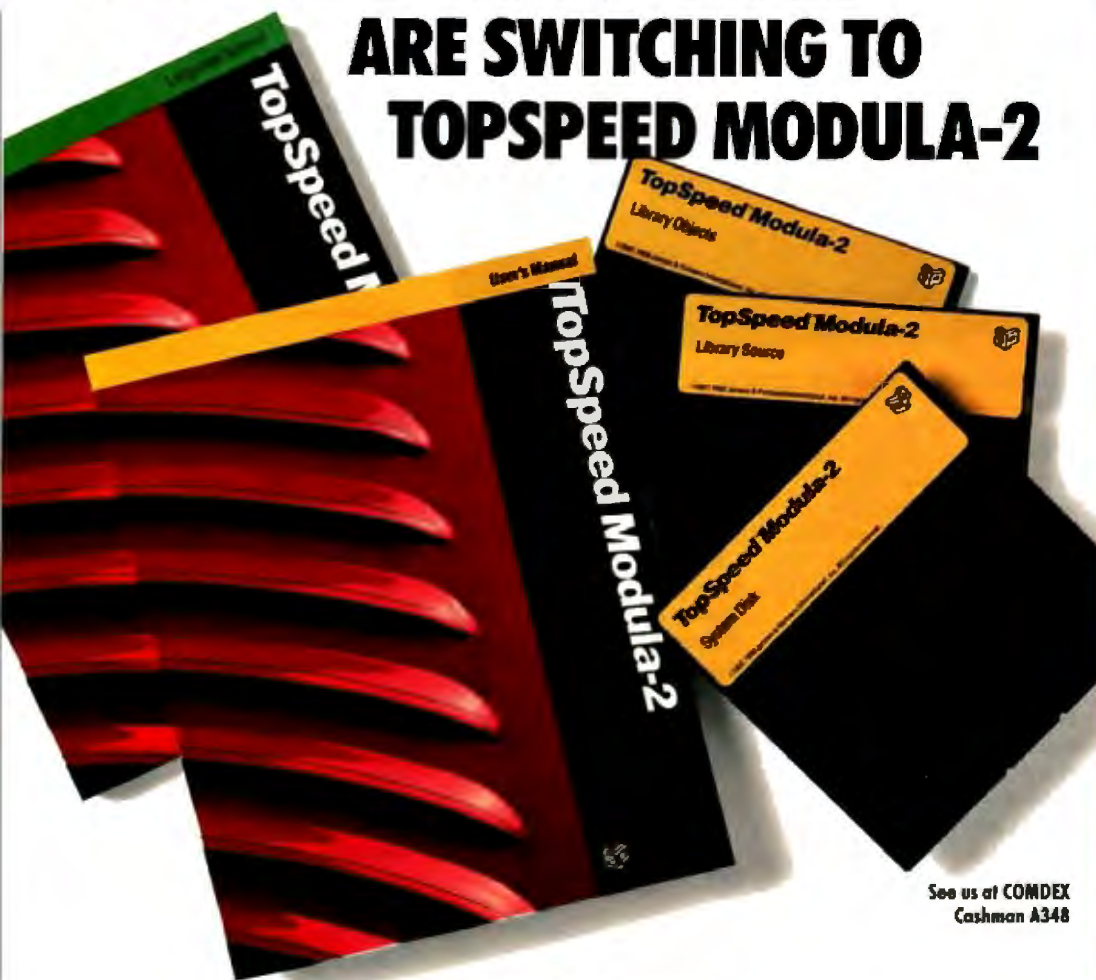

"JPI Modula-2 looks like another classic in the making. It generates code as good as or better than leading C compilers and the programming environment is a genuine pleasure to use."

Dick Pountain  
BYTE Magazine

"After months of frustration with Logitech Modula-2/186, I bought TopSpeed Modula-2...I am delighted with it. Not only did it perfectly compile my 10,000 lines of existing source, it's just more fun as well!"

Hans U. Gerber  
ETH, Switzerland

"I liked all of the hard-disk space that was recovered after I deleted my BORLAND, MICROSOFT, and LOGITECH compilers, because with TopSpeed Modula-2 all the rest are obsolete."

Robert D. Randall  
Donnelley Marketing

**The successor of Pascal:** JPI TopSpeed Modula-2 produces better code than Microsoft C, Turbo C, Logitech Modula-2, and Turbo Pascal 4.0.

JPI TopSpeed Modula-2 is a professional Modula-2 development system with full support of memory models, multi-tasking, long data types, structured constants, long and short pointers, 80x87 inline code and emulator, separate compilation, direct BIOS/DOS calls, etc. The comprehensive library includes CGA, EGA and VGA graphics support, math functions, sorting, file handling, window management, a time-sliced process scheduler and more.

**The Compiler Kit includes:** High-speed optimizing compiler (3,000-5,000 lines/min. on a PC AT 8MHz), integrated menu-driven environment with multi-window/multi-file editor, automatic *make*, fast smart linker. All Modula-2 sources to libraries included. **BONUS:** Complete high-speed window management module included with source. 258-page User's Manual and 190-page Language Tutorial.

**The TechKit includes:** Assembler source for start-up code and run-time library, JPI TopSpeed Assembler (30,000 lines/min), TSR module, communications driver, PROM locator, dynamic overlays, and technical information. 72-page manual.

**System Requirements:** IBM PC or compatible, 384K RAM, two floppy drives (hard disk recommended).

See us at COMDEX  
Cashman A348

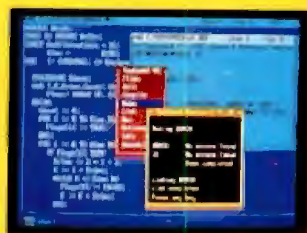

TopSpeed's seamlessly integrated environment.

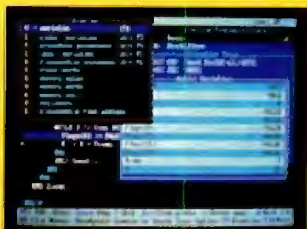

VID, the Visual Interactive Debugger, coming soon.

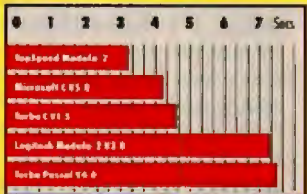

Sieve benchmark measured by the British Standards Institution (BSI)—25 iterations on an 8MHz AT.

**Compiler Kit \$99.95**  
**TechKit \$59.95**

### To Order:

In the US & Canada, call:  
**1-800-443-0100**  
Ext 255, 24 Hours.

Or mail us your order with a check, money order, or VISA/MC information. 30-day unconditional money-back guarantee.

Shipping & handling charges: In North America: Add \$5.00 shipping & handling, plus \$2.00 for each additional product. Overseas: Add \$20.00 shipping & handling, plus \$8.00 for each additional product.



Jensen &  
Partners  
International

1101 San Antonio Rd, Suite 301  
Mountain View CA 94043  
Phone: (415) 967-3200

**In England and Europe contact:**  
Jensen & Partners UK Ltd., 63 Clerkenwell Rd., London EC1M 5NP. Phone: (01) 253-4333.  
Compiler Kit £59.95, (add £4.69 for VAT & handling in the UK; £4.00 handling in Europe). TechKit £34.95 (add £4.03 for VAT & handling in the UK; £4.00 handling in Europe).

TopSpeed is a trademark of Jensen & Partners International. Other brand and product names are trademarks or registered trademarks of their respective holders.







# 3,000,000<sup>PCS</sup>

## MEANS QUALITY



Quality, others promise, we deliver. The fact we've already delivered over 3,000,000 color monitors is the best proof. Tatung also makes a full line of computers and peripherals. Our reputation for superb quality is well known around the world. And we deliver complete after sales service to you.

### TCS 8000

16 MHZ, 0 WAIT - STATE  
32 BIT, EXPANDABLE 16MB

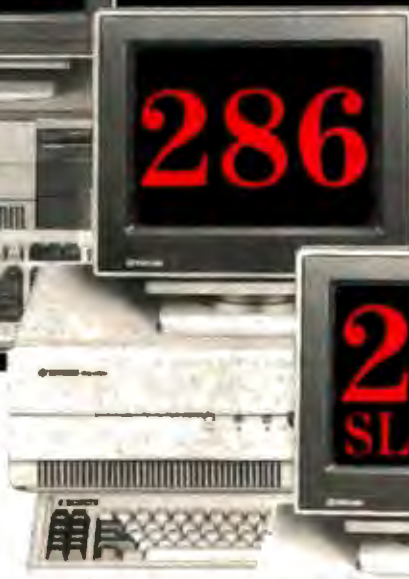

### TCS 7000

6, 8, 10, 12MHZ



### TCS 4000 (6/10MHZ)

EQUIVALENT OF 5 EXPANSION SLOTS

OMNISCAN

---

**COMPATIBILITY:**  
 IBM VGA™, MCGA™  
 PGA, EGA, CGA  
 AT&T™ PCs  
 APPLE IIGS™  
 MACINTOSH II™

**14" Color Monitor**  
 RES: 800 x 560  
 4 MULTI-COLOR MODE

**12" Mono Monitor**  
 RES: 800 x 560

\* ALL TRADEMARKS ARE PROPERTY OF  
 THEIR RESPECTIVE MANUFACTURERS

### COLOR MONITOR

### MONO MONITOR

### TERMINAL

MODEL	RES.
• CM 1322N	640 X 200
• CM 1370A	720 X 400
• CM 1380F	640 X 350
• CM 1495	800 X 560

MODEL	RES.
MM 1222	800 X 350
MM 1422	800 X 350
MM 1295	800 X 560

ET - 10 SERIES
14" DARK - TINTED ANTI-GLARE FLAT CRT H10 (AMBER) H17 (PAPER/WHITE)

Circle 526 on Reader Service Card



# TATUNG

TATUNG SCIENCE & TECHNOLOGY INC.

## 408-435-0140

2060 RINGWOOD AVE., SAN JOSE CA, 95131

VAR. DISTRIBUTORS, OEM  
INQUIRIES ARE WELCOME



# WHAT'S NEW

PACIFIC

## CD-ROM Drive for the Mac

**T**oshiba claims its XM-2100A-MAC is the fastest CD-ROM disk drive system for Macintosh computers. It provides 680 megabytes of storage with a 400-millisecond average access time.

Included with the kit is a SCSI cable for connecting it to your Mac, driver software, and a sample setup and demonstration disk. The disk drive features an audio output port.

The system supports the Mac SE, Plus, and II.  
Price: \$995.

Contact: Toshiba America, Inc., Disk Products Division, 9740 Irvine Blvd., Irvine, CA 92718, (714) 583-3108. Inquiry 837.



*Toshiba's XM-2100A-MAC: the fastest kid on the block?*

## Now, What Was in That File?

**I**f you're tired of looking at filenames in a directory and not having the faintest idea what the file contains, RememDir can help. A mem-

ory-resident program, RememDir lets you add a description of up to 50 characters for each file.

You can also use RememDir to supply a filename when you give commands to run programs. The command and filename are sent automatically with parameters that you

specify to your application program: The program acts in this way like a batch file, only you can run it from inside the application program.

You can load the program manually or from your AUTO-EXEC.BAT file. According to Elliam, you can put RememDir anywhere in your chain of memory-resident programs.

The program runs on IBM PCs, XTs, ATs, or compatibles with DOS 2.0 or higher, 60K bytes of RAM, and a standard or enhanced keyboard. It can work with a CGA, EGA, and IBM or Hercules monochrome card. RememDir reverts to normal CGA color when running under extended EGA and won't work with Hercules in the graphics mode. Elliam recommends you use the program with a hard disk

*continued*

## Important TIPS\* for BYTE Subscribers: Receive Product Information 10 Days Earlier!

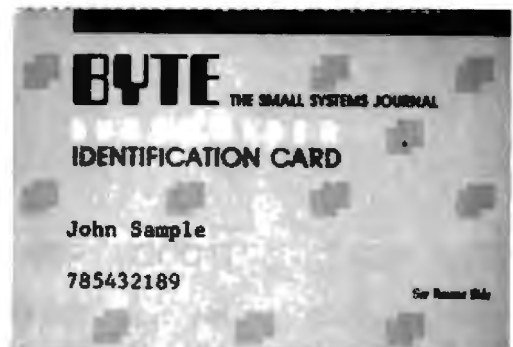

All you need is a touch-tone telephone and your subscriber I.D. number. See instructions facing the Reader Service Index in the back of this issue for outrageous time-saving opportunities!

\*BYTE's Telephone Inquiry Processing Service

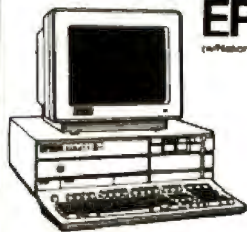

**EPSON**  
(with Reasonable Protection Plan)

**EQUITY I+**

- 360K Floppy
- 20 Meg Hard Disk
- 640K Ram
- Serial/Parallel Port
- Monochrome Card
- Monochrome Monitor
- MS DOS
- GW Basic

**\$1295**

**EQUITY III+**

- 80286 CPU 6-8 12 MHz
- 1.2 MEG Floppy
- 40 MEG Hard Disk
- DOS 3.2 Mono Monitor & Graphic Card

**\$2195**

**EQUITY I! PLUS**

- 1.2 Meg Floppy
- 40 Meg Hard Disk
- 640K Ram
- Serial/Parallel/C/C
- 80286 CPU
- Monochrome Monitor
- Graphic Card
- MS DOS
- GW Basic

In order to provide the best service, EPSON EQUITY is exclusively sold on location.

**LOW  
PRICE  
LEADER**

**Everex**

80286  
10 or 12 or 16 MHz - 0 wait state  
512K Memory Expandable to 1 MB  
Set up utility in ROM  
Enhanced keyboard  
Serial & Parallel  
1.2 floppy drive  
Hard dr. & floppy dr. controller

**10MHz  
\$1195**

**Everex**

80386 - 20 MHz 0 wait state  
20, 10 & 6.7 MHz  
64-256K cache of very high speed RAM  
2 or 8 MB of 32-bit memory expandable to  
16 MB using optional 32-bit memory  
exp. board  
Serial & Parallel Port  
Enhanced keyboard

**Call  
for  
Custom  
Configuration**

**COMPAQ**

386 130 meg/20 MHz	<b>6495</b>
286 40 meg	<b>2395</b>
386 40 meg/16 MHz	<b>4195</b>
386 60 meg/20 MHz	<b>5650</b>
Portable III 40 meg/12 MHz	<b>4195</b>

CARD & MONITOR EXTRA

**IBM**

PS/2 model 30/20 meg	<b>1775</b>
PS/2 model 50/20 meg	<b>2595</b>
PS/2 model 60/40 meg	<b>3395</b>
PS/2 model 60/71 meg	<b>4100</b>
PS/2 model 80/40 meg	<b>4595</b>

MONITOR EXTRA

**LAP-TOP**

Toshiba 3200-40	<b>3695</b>
Toshiba 3100-20	<b>Call</b>
Toshiba 1000	<b>Call</b>
NEC Multispeed	<b>1395</b>
NEC Multispeed EL	<b>1595</b>
EPSON LT	<b>Call</b>

**WE STOCK**

CITIZEN  
OKIDATA  
EVEREX

TOSHIBA  
NEC  
WYSE  
HITACHI

PRINCETON GRAPHICS  
SONY  
ACER  
HOUSTON INSTRUMENTS

AMDEK  
HAYES  
SAMSUNG  
CALCOMP

PC MOUSE  
MICROSOFT MICE  
LOGITECH  
MITSUBISHI

IRWIN & ARCHIVE  
TAPE BACK  
TAXAN

**Macintosh**

Mac-SE/20 Meg	<b>2595</b>
Mac-II/40 Meg	<b>3795</b>

**ARCHE RIVAL 386**

10/20 MHz, 1.2 floppy, 2 MB RAM  
Monochrome **\$2995**

**SOFTWARE**

Microsoft Word	<b>239</b>
Word Perfect 5.0	<b>249</b>
Lotus 1-2-3	<b>297</b>
dBase III+	<b>385</b>

AND MANY, MANY MORE!

**SPECIALS  
of the Month**

Microsoft Mouse	<b>\$109</b>
Microsoft Excel	<b>\$309</b>
Aldus Pagemaker	<b>\$479</b>

**AST**

AST 386 model 340	<b>4395</b>
AST 286 model 80	<b>1695</b>
AST 286 model 120	<b>Call</b>
AST 286 model 140	<b>2695</b>

CARD & MONITOR EXTRA

**EPSON®  
PRINTERS**

Epson FX850/1050	<b>\$379/535</b>
Epson LQ850/1050	<b>\$559/785</b>
Epson LQ500/2500	<b>\$359/895</b>
Epson LX800/EX800	<b>\$199/445</b>

**CITIZEN  
PRINTER**

180D/15E	<b>\$179/385</b>
MSP40/45	<b>\$299/439</b>
MSP50/55	<b>\$399/509</b>
Tribute 124/224	<b>\$529/679</b>
Overture Lazer	<b>\$1459</b>
HP LASER Jet II	<b>.\$1750</b>

WE ACCEPT LC, CASHIER CHECKS, MONEY ORDERS, VISA, MC, AmEx  
3% charge on VISA, MC & 5% on American Express

**COMPUTER LANE**

HOURS:  
M-S 9-6

**1-800-526-3482 (Outside CA)**  
**(818) 884-8644 (In CA)**  
**(818) 884-8253 (FAX)**

22107 ROSCOE BLVD.  
CANOGA PARK  
1/2 BLOCK W. OF TOPANGA  
CA 91304

CORPORATE ACCOUNTS WELCOME  
CALL FOR VOLUME DISCOUNTS  
CONSULTANTS CALL FOR PRICING

Prices subject to change without notice

Compaq is a Registered Trademark of Compaq  
IBM is a Registered Trademark of International Business Machines



drive, but it will work on one floppy disk drive.

**Price:** \$29.95.

**Contact:** Elliam Associates, P.O. Box 6922, Los Osos, CA 93412, (805) 528-5871.

**Inquiry** 835.

## PageMaker 3.0 for the PC

**P**ageMaker 3.0 includes support for long documents, image controls for scanned and bit-map images, and import filters for Lotus 1-2-3, Symphony, and dBASE. With the new filters, you can put worksheet and database files directly into PageMaker documents without intermediate file conversion. You can also import files from Freelance and

Harvard Graphics.

It includes 20 templates for reports, newsletters, slides, flyers, proposals, and other documents. You can modify the templates to suit your needs or create your own.

New capabilities include automatic word wrap around rectangular graphics and customized wraps for irregular shapes. You can make spot-color overlays for commercial printing and color documents with selected color printers. Image controls for scanned and bit-map images work with PostScript and non-PostScript language printers.

PageMaker 3.0 works with IBM ATs, PS/2s, or other Windows-compatible computers. It requires 640K bytes of RAM, a 20-megabyte hard disk drive, an EGA, VGA, or Hercules graphics card, DOS

3.0 or higher, Microsoft Windows 2.03, and a mouse.

**Price:** \$795.

**Contact:** Aldus Corp., 411 First Ave. S, Suite 200, Seattle, WA 98104, (206) 622-5500.

**Inquiry** 832.

## Making Music on the Atari

**M**idisoft Studio Advanced Edition includes the same features of the original version plus added editing, programming, and other capabilities. The previous version's features included 32 polyphonic, independently controlled tracks; real-time tempo changes and track mixes; and full-track editing and flexible region editing.

The music program lets you record in real time, play back, overdub, and rewind on 64 polyphonic, independently controlled tracks. On an Atari 520ST, the limit is 30,000 notes per song; on a 1040ST, the limit is 70,000.

The advanced edition offers MIDI event editing, which gives you control over entering, changing, and removing all aspects of the music. It lets you program tempo changes, supports up to 16 MIDI channels per track, offers real-time MIDI volume control and real-time octave transpose for each track, and displays MIDI-thru controls on the main screen.

**Price:** \$149.

**Contact:** Midisoft Corp., P.O. Box 1000, Bellevue, WA 98009, (206) 827-0750.

**Inquiry** 836.

# It's the Dawn of the Information Age...

The new modem\$ with built-in data compression are all the rage. Trouble is\$, they use the Lempel-Ziv algorithm—something le\$\$ than optimal!

The centerpiece of the **FlySpeed Collection** is **st/exp**, the first commercial implementation of Fly Coding. **st/exp** compresses text files typically to 30% or less of their original size, at rates of over 1000 words per *second*, allowing you not only to communicate faster, but also save valuable disk space.

But now that you can communicate and store information so much more efficiently, you need a more efficient way of creating it. So we created **Typing Demon**, a spin-off of our work on communication aids for the handicapped. Typing Demon partially automates typing, speeding word-processing by 25% or more. Nothing revolutionary—just the difference between finishing the afternoon's word-processing at 4:45, versus 6:00 p.m.

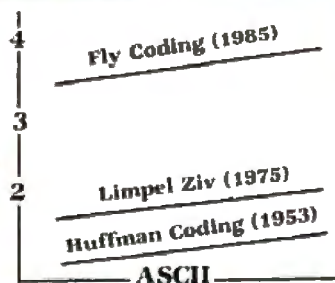

**Do you know where your Optimal Representation of Language is?**



**MicroComputer Square**

126 Hancock Avenue  
Spartanburg, S.C. 29302  
(803) 583-9655

■ With "**d**," FlySpeed's user-friendly directory program, you'll be able to look at your files sorted by file name, file date, etc. And you'll be able to page back and forth through long directories to your heart's content. (Say goodbye to directories scrolling off-screen.)

■ And when **Merlin**, the text-retrieval member of FlySpeed, debuts in January, you'll not only be able to create, communicate, and store information more quickly and efficiently, but you'll actually be able to find it later! *Instantly*, based upon any word or combination of words in a document. Because Fly Coding is inherently indexed.

You wouldn't expect computers of the 21st century to store and communicate information in the same inefficient format used in the 1950s. Now, for just 75 bucks, neither will yours.



UPS SYSTEMS HEADQUARTERS  
800-541-8126

**KNAPCO**

RELIABLE COMPUTER  
BACKUP FOR 40 YEARS

**DATA TRANSFER SWITCHES**



- AB SERIAL \$27.50
- AB PARALLEL \$28.50
- ABCD SERIAL \$39.50
- ABCD PARALLEL \$42.50
- AB CROSSOVER \$39.50
- ABCD DB9 TYPE \$43.50

**ISOLATING LINE STRIPS**  
SURGE & RF NOISE  
SUPPRESSION BAR 6-1 \$19.95  
6 OUTLETS  
W/ 6' FT. CORD  
12 @ 14.50 24 @ 12.25

THE PERFECT UPS by **ITT**  
\$999. RETAIL  
**\$666. DEALER**  
VIP EXECUTIVE 400

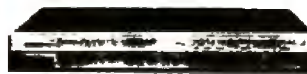

SUPPORTS 2 AT or 3 XT SYSTEMS  
True On-Line UPS designed for micro and mini power supplies. SINEWAVE output. Fits between CPU and CRT Only 20 Lbs. Size 1.9"H.x 15.8"Wx15"

**NEW KNAPCO UPS SYSTEMS**  
*Es UPS THIN-LINE---*



2.2" HIGH 24-28 LBS. RS-232 PORT FOR NOVELL  
200% IN-RUSH CAPACITY - SURGE, RFI, EMI  
PROTECTION. TRUE ON-LINE SINE WAVE +1%  
525 Va. LIST DEALER  
UPSC 525 \$995. \$495.

**Knapco UPS Systems**



FACTORY DIRECT  
LOWEST PRICES ON  
UPS SYSTEMS IN USA

UNINTERRUPTIBLE  
POWER SOURCE

IT WORKS...

- UPSC 200 + 200 WATT \$249.  
RETAIL \$499.
- UPSC 350 350 WATT \$279.  
RETAIL \$799.
- UPSC 550 550 WATT \$379.  
RETAIL \$899.
- UPSC 800 800 WATT \$599.  
RETAIL \$999.
- UPSC 1000 WATT \$699.  
RETAIL \$1250. \*\* EUROPEAN DESIGNED UPS \*\*  
Made in USA

Modified Wave Form \*\*OPTION 220v, 50Hz UPSE 200 \$359.  
2 Ms. Transfer Time OUTPUT 220v, 50Hz UPSE 350 \$399.  
OR 115v, 60Hz UPSE 550 \$499.  
UPSE 1000 \$799.  
RFI And Spike Protection  
All Models w/ Internal Gell Cells, Unconditional 1 Year  
Warranty 4 Outlets, Brown-Out, Black-Out Protection

**PERMA POWER  
STANDBY POWER SYSTEM**

for computers  
and  
peripherals

- UPS equivalent protection at a fraction of the cost
- Guard data and equipment from errors and damage caused by power line problems
- Responds in under 1 millisecond to blackout, over-voltages, under-voltages, power fluctuations. It provides stable 120V power
- Built-in surge suppressor easily handles the abuse of repetitive surges
- Filters out RFI/EMI noise - UL listed
- Automatic overload sensor
- Phase-synchronized transfer and automatic reset



SPS-500 LIST \$799 DEALER \$519.

**SHAPE  
LINE TAMER**



**FERRO POWER CONDITIONER**

Surge suppressors  
IEEE Standard 587  
Rejection 120/60dB.  
4 Outlets, 6ft. Cord  
Regulation ±3%

	Retail	Dealer
150 Va.	\$139.	\$ 99.
300 Va.	\$199.	\$149.
450 Va.	\$259.	\$197.
600 Va.	\$299.	\$225.
1000Va.	\$489.	\$349.
1200 Va.	\$549.	\$439.

**IMPORT  
VOLTAGE REGULATORS**

TVR500	\$129.
TVR1000	\$199.
TVR2000	\$295.
TVR3000	\$395.



INPUT RANGE 85-135V.  
EMI/RFI - SURGE

**EURO-TRANSFORMERS  
STEP UP/DOWN 110v.-220v.**

300 WATT	\$ 39
500 WATT	\$ 59
1300 WATT	\$ 85
*2000 WATT	\$125
*3000 WATT	\$215
*Select Voltage 100/110/120v. Up/Down 200/220/240v	

**MODEM SPIKE PROTECTORS**

MSP-1 \$12.25  
12 @ \$10.95  
24 @ \$ 9.95

QUANTITY PRICING AVAILABLE  
UPS SYSTEMS ADD \$15. MINIMUM  
FOR PACKING & SHIPPING



**TOSHIBA**

TOSNIC TRUE  
MICRO-1100 ON-LINE  
UPS SYSTEMS  
SELF CONTAINED  
GELL-CELL  
BATTERIES

NEW SMALL PROFILE  
LIST DEALER

500 VA.	\$1499.	\$1199.
750 VA.	\$1899.	\$1425.
1 K VA.	\$2299.	\$1724.
2 K VA.	\$3999.	\$3199.
3 K VA.	\$6599.	\$5279.
5 K VA.	\$9379.	\$7499.

AND LARGER MODELS



**AMERICAN POWER CONVERSION**

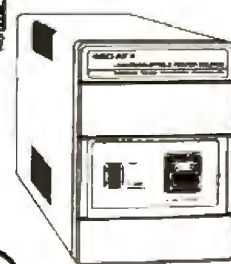

	RETAIL	DEALER
330 XT	\$399.	\$259.
450 AT	\$599.	\$389.
520 ES	\$699.	\$449.
800 RT	\$1099.	\$709.
1200 VX	\$1399.	\$905.



LAN's Best friend FOR MULTIPLE PC'S OR VERY LONG BACKUP TIME  
1to2 Ms. transfer time, compact, quality engineered,  
runs diagnostics, RS232 port, prevents surges, sags, spikes, noise & interference

CALL TOLL FREE  
1-800-541-8126  
OR 813-449-0019  
FAX 813-449-0701



**H.J. KNAPP of FLORIDA, INC.**  
1201 HAMLET AVE. CLEARWATER, FLORIDA 34616



Buy with

# Confidence

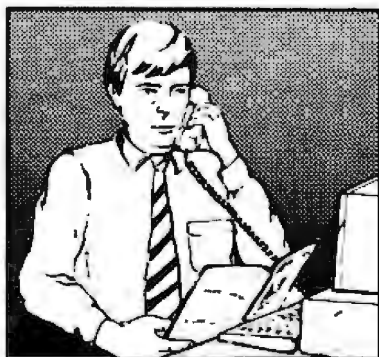

In an effort to make your telephone purchasing a more successful and pleasurable activity, The Microcomputer Marketing Council of the Direct Marketing Association, Inc. offers this advice, "A knowledgeable buyer will be a successful buyer." These are specific facts you should know about the prospective seller before placing an order:

## Ask These Important Questions

- How long has the company been in business?
- Does the company offer technical assistance?
- Is there a service facility?
- Are manufacturer's warranties handled through the company?
- Does the seller have formal return and refund policies?
- Is there an additional charge for use of credit cards?
- Are credit card charges held until time of shipment?
- What are shipping costs for items ordered?

Reputable computer dealers will answer all these questions to your satisfaction. Don't settle for less when buying your computer hardware, software, peripherals and supplies.

## Purchasing Guidelines

- State as completely and accurately as you can what merchandise you want including brand name, model number, catalog number.
- Establish that the item is in stock and confirm shipping date.
- Confirm that the price is as advertised.
- Obtain an order number and identification of the sales representative.
- Make a record of your order, noting exact price including shipping, date of order, promised shipping date and order number.

If you ever have a problem, remember to deal first with the seller. If you cannot resolve the problem, write to MAIL ORDER ACTION LINE, c/o DMA, 6 E. 43rd St., New York, NY 10017.

This message is brought to you by:

the MICROCOMPUTER  
MARKETING COUNCIL  
of the Direct Marketing  
Association, Inc.  
6 E. 43rd St.,  
New York, NY 10017

# MMCG

MICROCOMPUTER  
MARKETING COUNCIL  
of the Direct Marketing Association, Inc.

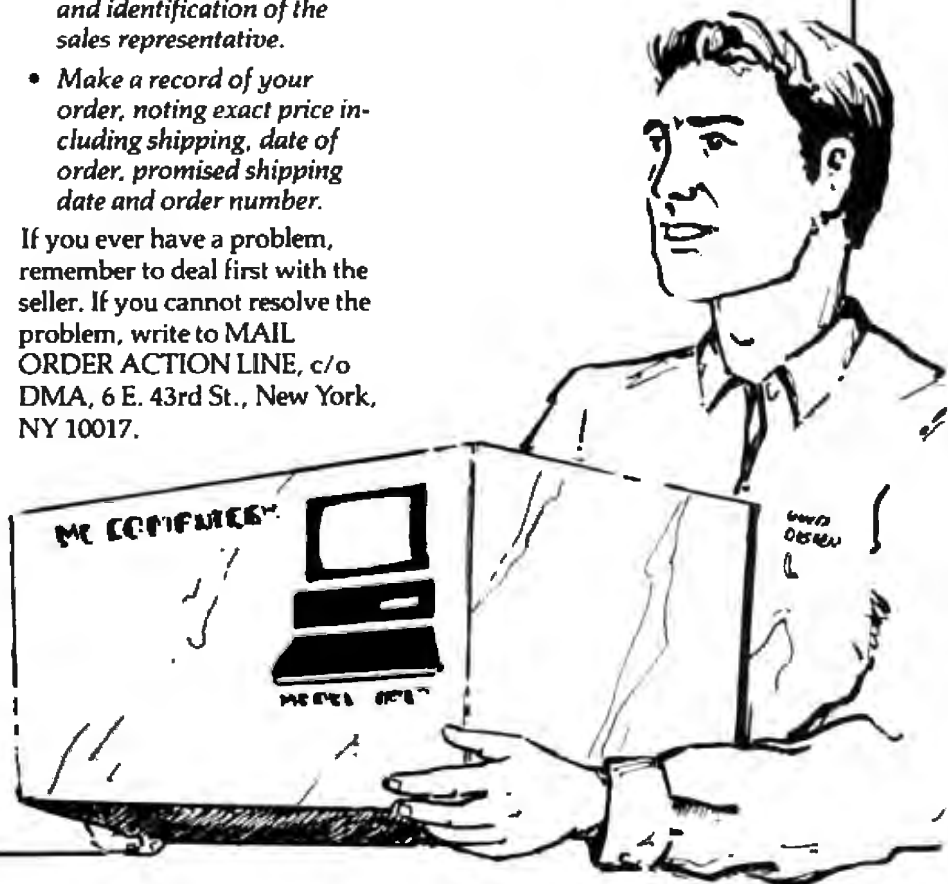

**D**ATA ACQUISITION: Get system capability at a board-level price. The System 570 is a personal computer based Data Acquisition Workstation with the extensive signal capacity you need: 32 analog inputs (or 16 differential), 2 analog outputs, 16 digital inputs, 16 digital outputs, 16 power control lines. The price is only \$1425, complete with our powerful **Soft500 software**, an extension of advanced BASIC that provides foreground/background architecture, array and memory management, disk access and storage, and over 45 additional commands.

**A**n expansion slot lets you extend your System 570's capabilities by selecting from an extensive library of optional input/output modules. And you can use the 570 with other data acquisition software such as DADiSP, ASYST™, and Labtech Notebook.

For complete information, a demonstration, or applications assistance, call toll free:

**1-800-552-1115**

(In Ohio call 216-248-0400.)

32  
2  
16  
16  
+ 16  

---

\$1425

**KEITHLEY**





## VIRUS PROTECTION

**G**ive your PC complete virus protection. Our products provide the most powerful and effective cures for computer viruses - and are simple to use.

Our Products will diagnose and attack viruses, as well as shield your system from harm - and remain transparent.

In addition, we attempt to search out and destroy those really tough viruses that are mailed to us. (This helps us maintain our software products so they are ready for any-

thing). This service is free of charge to our software customers.

Our products offer superior virus protection at low prices. Call today and we will ship your order immediately.

Villarreal Consulting  
4633 Capitola Avenue  
San Jose, CA 95111-2624  
(408) 972-0179

### VC-IMMUNE

Continually diagnoses your disks and files and alerts the user whenever an infection occurs. Not copy protected.....\$49

### VC-SHIELD

Protects your system from harmful virus actions and looks out for suspicious virul activities. Not copy protected.....\$49

### Disk Examination Service

Mail your disks suspected of infection to us. We will attempt to isolate and destroy the virus. There is no charge for unsuccessful attempts.....\$19

## Computers For The Blind

Talking computers give blind and visually impaired people access to electronic information. The question is how and how much?

The answers can be found in "The Second Beginner's Guide to Personal Computers for the Blind and Visually Impaired" published by the National Braille Press. This comprehensive book contains a Buyer's Guide to talking microcomputers and large print display processors. More importantly it includes reviews, written by blind users, of software that works with speech.

This invaluable resource book offers details on training programs in computer applications for the blind, and other useful information on how to buy and use special equipment.

Send orders to:  
National Braille Press Inc.  
88 St. Stephen Street  
Boston, MA 02115  
(617) 266-6160

\$12.95 for braille or cassette, \$14.95 for print. (\$3 extra for UPS shipping)  
NBP is a nonprofit braille printing and publishing house.

# Summer Savings!\*



SF-286	8MHz	10MHz	10MHz (0 WS)	12MHz (0 WS)	16MHz (386)
<b>Mono System</b>	<b>\$995</b>	<b>\$1169</b>	<b>\$1399</b>	<b>\$1574</b>	<b>\$2050</b>
<b>EGA System</b>	<b>\$1419</b>	<b>\$1619</b>	<b>\$1770</b>	<b>\$1945</b>	<b>\$2415</b>

## Basic System Features:

80286-16 bit CPU, 80287 socket, 512K RAM expandable to 1MB, fully compatible AMI BIOS, 1.2Mb Floppy Disk Drive, combined floppy/hard disk controller, Keytronics 101 enhanced keyboard, clock/calendar with battery backup, 195 watt power supply, 48 hour burn-in testing, operations manual, one year limited warranty and optional on-site maintenance agreement.

### SF-286-8MHz

**20Mb Mono Special.....\$1249**  
Basic System features plus: Monographics board with printer port, Samsung 12" amber mono monitor and Seagate 20Mb hard drive.

### SF-286-8MHz

**20Mb EGA Special.....\$1619**  
Basic System features plus: Everex EGA graphics board, Mitsubishi 1410-C or Eversion EGA color monitor and Seagate 20Mb hard drive.

### SF-286-8MHz

**20Mb VGA Special.....\$1899**  
Basic System features plus: Everex EVGA graphics board ( 640 x 480, 800 x 600, up to 256 colors ), Mitsubishi Diamond Scan multisync color monitor and Seagate 20Mb hard drive.

### SF-286-12MHz

**20Mb EGA Special.....\$1774**  
Basic System features plus: Monographics board with printer port, Eversion 14" flat screen amber mono monitor and Seagate 20Mb hard drive.  
Upgrade to 40Mb Seagate hard drive, Add \$160  
Upgrade to 80Mb Seagate hard drive, Add \$500

## EGA Bundle.....\$459

Everex EGA autoswitch graphics board and Eversion EGA color monitor.

## Super EGA Bundle.....\$629

Everex EGA Deluxe autoswitch graphics board ( 640x480, 752x410 ), and Mitsubishi 1371-A Diamond Scan multisync color monitor.

## Super VGA Bundle.....\$769

Everex EVGA graphics board ( 640x480, 800x600, up to 256 colors ) and Mitsubishi 1371-A Diamond Scan multisync color monitor

## Hard Disk Specials ( for PC )

Seagate ST225 20Mb + Controller.....\$265  
Seagate ST125 20Mb + Controller.....\$329  
Seagate ST238 30Mb + Controller.....\$289  
Seagate ST251 40Mb + Controller.....\$449

## Hard Disk Specials ( for AT )

Seagate ST125 20Mb ( 40ms ).....\$269  
Seagate ST138 30Mb ( 40ms ).....\$339  
Seagate ST251 40Mb ( 40ms ).....\$369  
Seagate ST251-1 40Mb ( 28ms ).....\$429  
Seagate 4098 80Mb ( 28ms ).....\$729  
Micropolis 1335 71Mb ( 28ms ).....\$599

## Everex Modems

Everex Evercom external and internal half-card modems ( fully Hayes compatible ) with Bitcom Communications software.

Internal 1200 Baud Modem.....\$CALL  
External 1200 Baud Pocket Modem.....\$139  
Internal 2400 Baud Modem.....\$149  
External 2400 Baud with Mini I/O.....\$229

## Misc. Specials

Mini I/O ( PAR, SER, CLK, CAL ).....\$49  
Mini I/O with Game Port.....\$55  
Mini I/O + Logitech C7 serial mouse.....\$119  
Mitsubishi 3.5" 720K floppy drive.....\$99  
Mitsubishi 3.5" 1.4Mb floppy drive.....\$129  
150 Watt Power Supply.....\$49  
200 Watt Power Supply.....\$79  
2Mb EMS memory board with OK.....\$80  
3Mb EMS memory board with OK.....\$99

\* Special Prices valid only through 9/30/88

Seagate, Samsung, Miniscribe, Everex, Mitsubishi, Hayes, Microball, Bitcom, Logitech, are trademarks or registered trademarks of their respective companies.  
© Micro 2 881 422



1825 Lombard Street  
San Francisco, CA 94123

California Orders, Information  
**(415) 929-1505**

National Order Desk (800) 237-5631  
Technical Support (415) 929-1607

University P.O.'s and Dealers Inquiries  
are Welcome

TERMS: We accept MasterCard, VISA (no surcharge), American Express, COD's (Certified Funds) and approved company P.O.'s. California residents please add sales tax. 10% fee for unauthorized returns (call for RMA number). Returns must be shipped freight prepaid by customer. Prices are subject to change without notice. We reserve the right to substitute equivalent items.





**ALTEC ZIP-386**  
**\$1,995**

- ★ Intel 80386 microprocessor
- ★ 1M high speed memory installed
- ★ Expandable to 10 MB
- ★ Phoenix 386 BIOS or Award 386 BIOS
- ★ 4 speed (4.776/8/16 MHz)
- ★ 200W power supply
- ★ Case with re-est button
- ★ Enhanced keyboard
- ★ Hard disk/floppy disk controller card
- ★ 1.2M floppy disk drive
- ★ Monochrome/Graphics card with printer port
- ★ Hi-RES Monochrome Monitor
- ★ User's manual
- ★ 1 year warranty



**ALTEC-286 Enhanced System**  
**\$995**

- ★ Intel 80286-10 microprocessor
- ★ 512K RAM
- ★ Dual speed 8/10 MHz
- ★ 200W power supply
- ★ AT style case
- ★ Enhanced keyboard
- ★ Hard disk/floppy disk controller card
- ★ 1.2 M floppy disk drive
- ★ Monochrome/Graphics card with printer port
- ★ Hi-RES Monochrome Monitor
- ★ Phoenix BIOS
- ★ User's manual
- ★ 1 year warranty



**ALTEC-XT Turbo System**  
**\$675**

- ★ 8088-1 microprocessor
- ★ 4.7710 MHz
- ★ 640K RAM
- ★ 150W power supply
- ★ AT style keyboard
- ★ Floppy controller card
- ★ 360K floppy disk drive
- ★ Monochrome/Graphics card with printer port
- ★ Hi-RES Monochrome Monitor
- ★ Phoenix BIOS
- ★ User's manual
- ★ 1 year warranty



**ALTEC-286jr System**  
**\$975**

- ★ Intel 80286-10 microprocessor
- ★ 512K RAM
- ★ 200W power supply
- ★ ATj style case
- ★ AT style keyboard
- ★ Hard disk/floppy disk controller card
- ★ 1.2M floppy disk drive
- ★ Monochrome/Graphics card with printer port
- ★ Hi-RES Monochrome Monitor
- ★ User's manual
- ★ 1 year warranty

ADDITIONAL FEATURES	ADD		
Cator System	\$208.00		
EGA System	\$400.00		
256K hard disk	\$205.00 (386 & 286)	\$285.00 (XT)	
486K hard disk	\$355.00 (386 & 286)	\$425.00 (XT)	
360K floppy disk drive	\$80.00		
720K 3 1/2" floppy disk drive	\$80.00		
1.44M 3 1/2" floppy disk drive	\$125.00		



**ALTEC Technology Corporation**  
5751 Rickenbacker Road, Los Angeles, CA 90040  
Tel: 1-213-888-9100  
**Order Desk: 1-800-255-9971**

★ Intel is a registered trademark of Intel Corporation  
★ Phoenix is registered trademark of Phoenix Technologies Ltd  
★ Award is registered trademark of Award Software Inc.  
★ AT is registered trademark of IBM Corporation



# VUTEK SYSTEMS ANNOUNCES FREEZFRAME II

- ▶ The Frame Grabber that runs with any software, anytime.
- ▶ Text/Graphics overlay on live video
- ▶ EGA/CGA text/graphics overlay on captured still-frame video
- ▶ TV. quality images

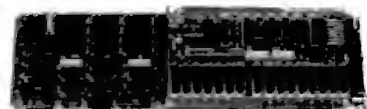

**Software included:**

- ▶ Video Editor - cut/paste, paint program
- ▶ Universal Interface Driver
- ▶ Printer Drivers

**FOR MORE INFORMATION  
CALL (619) 587-2800**

VUTEK SYSTEMS, INC.  
10855 Sorrento Valley Road  
San Diego, CA 92121



# SERIOUS DEBUGGING *at a* REASONABLE PRICE

All the speed and power of a hardware-assisted debugger at a software price



## Hardware-level break points

REAL-TIME break points on memory locations, memory ranges, execution, I/O ports, hardware and software interrupts. More powerful break points than ANY software-only debugger on the market. Soft-ICE gives you the power of an in-circuit emulator on your desk.

## Break out of hung programs

With a keystroke - no external switch necessary. Even with interrupts disabled.

## Breaks the 640K barrier

Soft-ICE uses ZERO bytes of memory in the first 1MB of address space. This is especially useful for those subtle bugs that change when the starting address of your code changes. With Soft-ICE your code executes at the same address whether the debugger is loaded or not.

## Works with your favorite debugger

Soft-ICE can be used as a stand-alone debugger or it can add its powerful break points to the software debugger you already use. You can continue to use your favorite debugger until you require Soft-ICE. Simply pop up the Soft-ICE window to set powerful real-time break points. When a break point is reached, your debugger will be activated.

## Solve tough systems problems too

Soft-ICE is ideal for debugging TSRs, interrupt handlers, self booting programs, DOS loadable device drivers, non-DOS operating systems, and debugging within DOS & BIOS. Soft-ICE is also great for firmware development because Soft-ICE's break points work in ROM.

## How Soft-ICE Works

Soft-ICE uses the power of the 80386 to surround your program in a virtual machine. This gives you complete control of the DOS environment, while Soft-ICE runs safely in protected mode. Soft-ICE uses 80386 protected mode features, such as paging, I/O privilege level, and break point registers, to provide real-time hardware-level break points.

**"Soft-ICE is a product any MS-DOS developer serious enough to own a 386 machine should have."**

*Dr. Dobb's Journal — May 1988*

Both require 80386 AT compatible or IBM PS/2 Model 80. MagicCV requires at least 384K of extended memory. CodeView is a trademark of Microsoft Corporation.

## RUN CODEVIEW IN ONLY 8K!



CodeView is a great integrated debugger, but it uses over 200K of conventional memory. MagicCV uses advanced features of the 80386 microprocessor to load CodeView and symbols in extended memory. This allows MagicCV to run CodeView using less than 8K of conventional memory on your 80386 PC.

## Don't let 640K be your limit!

If you are closing in on the 640K limit and would like the power of CodeView, MagicCV is for you.

## Don't let the debugger hide the bug!

Even if you're not closing in on the 640K limit, running CodeView with MagicCV makes your debugging environment much closer to the end user's program environment. You can use CodeView to locate subtle bugs that only occur when there is plenty of free memory, or those difficult bugs that only occur when your program is running with a couple of TSRs loaded.

## How MagicCV works

MagicCV uses the 80386 to create a separate virtual machine for CodeView. MagicCV uses between 4K & 8K of conventional memory as a bridge between the DOS environment and CodeView.

## MagicCV is easy to use

If you are a CodeView user, you already know how to use MagicCV too. Just type MCV instead of CV; everything else is automatic.

**Save \$86**

MagicCV \$199  
Soft-ICE \$386

**Buy Both and Save \$86!**

**CALL TODAY**  
(603) 888 - 2386  
or FAX (603) 888 - 2465

30 day money-back guarantee  
Visa, Master Card and AmEx accepted

**NU-MEGA TECHNOLOGIES**

P.O. BOX 7607 • NASHUA, NH 03060-7607

## MagicCV with Soft-ICE

Using Soft-ICE with CodeView gives you the features necessary for professional level systems debugging. MagicCV and Soft-ICE can work in concert with CodeView to provide the most powerful debugging platform you will find anywhere.







# MAKE COMPLEX DEC COMPUTING DECISIONS EASY

More Digital Equipment users will make more DEC computing decisions at DEXPO West than at any other event in the world. You'll do more to achieve maximum productivity from your DEC system in just three days than you'll do in the other 362 days of the year.

Compare 15,000 products, side by side. Save time and money when you evaluate all of your options, firsthand. Talk to hundreds of product specialists. They've all got solutions—find out who's got the best.

- More VAX, MicroVAX, and PDP-11 enhancements than any other show—ever!
- "Apple-DEC Connection" features 50 Mac-to-VAX exhibits.
- Hands-on instruction & expert advice—direct from 350 leading product developers.
- Communication products to integrate multi-vendor systems.

#### DECUS<sup>®</sup> Attendees: DEXPO West is Free and Easy

DECUS Symposia attendees are admitted **FREE** to DEXPO West. (DECUS is not affiliated with DEXPO and requires separate registration).

#### Call Today for Free Show Preview & VIP Tickets

Call 800-628-8185 right away, and you'll receive special money-saving show tickets. Plus, get a preview of 100 products on exhibit at DEXPO West 88—a small sample of all you'll see when you attend.

## DEXPO<sup>®</sup> West 88

The World's Largest DEC<sup>®</sup> Computing Exposition  
Disneyland Hotel  
Anaheim, CA  
October 18-20, 1988

**800-628-8185.**

Call between 8:30 a.m. and  
5:30 p.m., Eastern Time (in New  
Jersey, call (609) 987-9400)

Organized by:  
Expoconsul International, Inc.,  
3 Independence Way,  
Princeton, NJ 08540

Registered trademark of Digital Equipment Corporation.  
DECUS is not sponsored by or affiliated with DEXPO





# SUPER FAST 12 MHz

High quality American-designed, engineered and American-built, powerful 80286-12 MHz super performance computer systems for CAD/CAM workstations, scientific engineering, industrial, medical, local area networking, desktop publishing systems and more applications.



## MSE 286-12 MHz

- The newest VLSI Chip set
- 80286 microprocessor, 6/12 MHz
- 512K RAM, expands to 1 MB
- 1.2 MB Teac floppy drive
- W.D. hard disk/floppy disk controller
- Clock/calendar with battery backup
- Keyboard
- 200 W power supply
- 8 expansion slots
- True Read/Write "0" wait state
- 72 hours burn-in test
- 16 MHz performance

**OUR PRICE  
\$895**

☆ Special Offer ☆  
EGA Portable 386  
Vertical 386-20 Mhz  
\$Call

Same as above system with 16 MHz speed Our Price \$995 1.44 MB Micro Floppy Drive \$159

PC Week  
Editor's Choice

## 80386 20 MHz MODEL 40

- 80386 32-bit CPU, 20/8 MHz
- 1 MB high speed static column RAM
- 32-bit memory, expands to 10 MB
- W.D. hard disk/floppy disk controller (ESDI controller also available)
- Teac 1.2 MB floppy drive
- 42 MB fast hard drive (28ms)
- 200 W low noise power supply
- 101-key enhanced keyboard
- Clock/calendar with battery backup
- Serial and parallel port
- Support 80287 & 80387
- Xenix System V, OS/2, PC MOS 386
- Read/Write "0" wait state
- 25 MHz performance

**COMPLETE \$2495      30 MHz PERFORMANCE \$2895**

### EXPANSION OPTIONS

Mono Monitor & Graphic Card	\$129	Seagate ST-138 30 MB (28ms)	\$399	WYSE 700 & Monitor (1280 x 800)	\$649
Color Monitor & Graphic Card	\$329	Seagate ST-4053 44 MB (28ms)	\$499	NEC Multisync II Monitor (800 x 600)	\$599
EGA Monitor & Graphic Card	\$529	Micropolis 1333 44 MB (28ms)	\$599	NEC Multisync Plus Monitor 15"	\$899
Seagate ST-225 20 MB (65ms)	\$269	Micropolis 1335 72 MB (28ms)	\$699	NEC Multisync XL Monitor 19"	\$1999
Seagate ST-125 20 MB (28ms)	\$299	Seagate ST-4096 80 MB (28ms)	\$699	Paradise VGA Plus Card (800 x 600)	\$279
Seagate ST-251 42 MB (38ms)	\$379	1.2 MB Floppy Disk Drive	\$109	Vega VGA Card (800 x 600)	\$279
Seagate ST-251-1 42 MB (28ms)	\$399	360 KB Floppy Disk Drive	\$89	Everex VGA Card (800 x 600)	\$279
Fujitsu ESDI 147 MB (23ms)	\$1399	1.44 MB 3.5" Micro Floppy Drive	\$159	Genoa Hi-Res EGA Card (800 x 600)	\$199
Maxtor ESDI 320 MB (16ms)	\$3499	720 K 3.5" Micro Floppy Drive	\$119	ATI Professional Image Board	\$799

# MS ENGINEERING, INC.

10601 S. De Anza Blvd., Suite 214  
Cupertino, CA 95014

**(408) 257-4249**

Prices subject to change  
without prior notice.  
Sale prices apply to C.O.D. only.



# ARCHITECTURE FOR THE 90'S

## SHAPE OF THE FUTURE

### THE ~~EVEREX~~ SYSTEM 386/20

#### Features

- Fully compatible with the IBM® PC/AT™
- Intel® 80386 microprocessor, running at speeds of 20, 10, & 7 MHz with zero wait states (16 and 8 MHz on the 386/16)
- Speed selectable by keyboard, software or front-panel switch
- The bus operates at 10 or 6.7 MHz
- The machine uses write-back cache memory (64K, 128K or 256K of 25 ns static RAM)
- Socket for an 80387 math coprocessor option, running synchronously at 20, 10 or 6.7 MHz. (16 and 8 MHz on the 386/16)
- 1 Megabyte DRAM expandable to 8 Megabytes on the system board (120 ns DRAMs, 256 Kb or 1 Mb)
- Front panel LEDs for power-on, disk access and speed indication
- Alpha-numeric (software diagnostic display (8-digits)
- 1.2 MB floppy diskette drive
- Six 16-bit and two 8-bit bus expansion slots
- One 32-bit memory expansion slot
- Special Everex very high performance (1:1 interleave) hard disk/floppy combination controller
- Front access to up to 8 half-height mass storage devices
- Enhanced 101 key keyboard
- System clock/calender/composition data in CMOS RAM with battery backup
- Everex enhanced BIOS
- Easy-to-use SETUP utility in ROM, supports over 45 drive types
- BIOS supports 3 5" 720K diskette drives
- Front panel lockout to disable keyboard
- Front access reset switch
- Speaker enable/disable switch
- Complete, easy-to-follow user manual
- UL listed power supply, switchable 120/240 VAC
- 13 months on-site warranty
- 1 serial and 1 parallel port

#### COMPLIANCE TESTING RESULTS

The Everex System 386 has been evaluated by XECAL, an independent third party testing house. The test objectives, as stated in XECAL's report of February 16, 1988, was "to review any problems or discrepancies relative to a selected group of off-the-shelf commercial software, network, and peripheral products" the Everex System 386. XECAL's technicians "installed each application per documentation. [They] tested all functions, commands, and options directly related to a successful and thorough test of the product."



MADE IN USA

Model	CPU	Cache	RAM	Price
Everex Sys 386/20	6.7	38.5	25.1	
Everex Sys 386/16	1.58	37.2	18.1	
Everex Sys 386/10	1.27	31.4	18.1	
Everex Sys 386/7	1.14	15.8	13.7	



With a 3F 286 or 386 computer, you can do desktop publishing, word processing, process control, networking, database applications, accounting spreadsheets, inventory control, circuit design, computer aided design engineering and manufacturing, and architectural design—the list goes on!

These computers will also run with OS/2, MS OS/2, Lotus 123, Dbase III, Unix, Xenix, Informix, AutoCAD, Smarttalk, Q&A, Sidekick, Gem, Turbo Pascal, Multimate, Word, Wordperfect, Wordstar, Ventura, Novell Network 286, IRMA board, Modems, Bernoulli boxes, Network Cards

### OTHER EVEREX COMPUTERS

#### 3F 286 System

- 80286 CPU
- 1.2MB Floppy
- 512K Memory
- 101 Keyboard
- FL/HD Controller
- 6/8/10 Keyboard Selectable
- 195 Watt Power Supply
- Optional 80287 Socket
- FCC UL Approved

8MHz V Wait State 80286 Mono System	\$390
10MHz T Wait State 80286 Mono System	\$1239
10MHz V Wait State 80286 Mono System	\$1339
12MHz V Wait State 80286 Mono System	\$1575
For an EGA System	add \$350

#### 3F 386 System

- 80386 CPU
- 1.2MB Floppy
- 1MB Memory
- 101 Keyboard
- FL/HD Controller
- 64K Cache
- 16MHz CPU V Wait State
- 195 Watt Power Supply

16MHz V Wait State 80386 Mono System	\$1975
For an EGA System	\$2299

#### Hard Disk add on for above Systems:

20MB 85mm	\$249
40MB 36mm	\$399
80MB 28mm	\$710
144MB 16.5mm	\$1955

PRICES AND AVAILABILITY SUBJECT TO CHANGE WITHOUT NOTICE

Call Us For Full Line of EVEREX Peripheral Products.

We Also Carry Hard/Floppy Drives, Monitors, Printers, Motherboards and All Major Software.

# 3F

3F Associates, Inc.  
44100 Old Warm Springs  
Fremont, CA 94538

(415) 659-0403

FAX (415) 651-9190

# SHORT TAKES

*BYTE editors offer hands-on views of new products*

Novy TSI-020MX

Radius Accelerator 25

Turbo Prolog 2.0

SOTA MotherCard 5.0

Microsoft Mach 20

Choice Words

Tentime

## Two 25-MHz Accelerator Boards for the Mac SE

The computer industry is engaged in an interesting war: The Pace Race. Not long after IBM PC-compatible manufacturers had unleashed their 25-MHz 80386 machines upon the market, third-party Mac vendors countered with 25-MHz 68020 accelerator boards for the Mac SE. That single slot in the Mac SE has proven its worth, because this newest generation of accelerator boards boosts the SE's computing performance well past that of a Mac II.

I looked at the **TSI-020MX** by Novy Systems (marketed by TSI) and the **Radius Accelerator 25** by Radius. Both boards use the same basic 16-MHz accelerator design, but with 25-MHz components. The TSI-020MX is equipped with a 25-MHz 68020 CPU, a 68881 floating-point unit (FPU), and 1 megabyte of 32-bit RAM that's expandable to 4 megabytes. The Radius Accelerator 25 board has a 25-MHz 68020 CPU, an optional 68881 FPU, and a 32K-byte



### THE FACTS

TSI-020MX  
\$5000

*Requirements:*  
Mac SE running System  
4.3/finder 6.0 or higher

TSI  
99 West 10th Ave.  
Suite 333  
Eugene, OR 97401  
(800) 874-2288  
**Inquiry 855.**

### THE FACTS

Radius Accelerator 25  
\$1695 without 68881  
coprocessor; \$2195 with  
68881

*Requirements:*  
Mac SE running System  
4.3/finder 6.0 or higher

Radius, Inc.  
404 East Plumeria Dr.  
San Jose, CA 95134  
(408) 434-1010  
**Inquiry 856.**

RAM cache composed of 32-bit static RAM. Both boards come with a disk of installation software.

Installation requires that you open the Mac SE's case, remove the motherboard, and plug the board into the slot. This operation shouldn't be attempted by a novice. That's because of the shock hazard from high-voltage circuits inside the Mac, or the possibility of damaging electronic components due to electrostatic discharge.

You also need to check the position of jumpers on both ac-

celerator boards during installation. For the TSI-020MX, these jumpers set the board's memory size (1 or 4 megabytes) and number of wait states for a memory access (1 or 2 at 25 MHz). For the Radius board, one jumper is used to indicate the presence of an optional 68881, and another jumper sets the clock rate of the 68881 (16 or 25 MHz).

Support software for the TSI-020MX consists of three files: *NovyInit*, *NovyStartup*, and the *MAC20 Control DA*. *NovyInit* and *NovyStartup* install certain re-

sources that determine the board's mode of operation. *Control DA* lets you adjust certain parameters (i.e., use the 68020 instruction cache, intercept *MacWrite* traps, route *SANE* traps to the 68881, copy and use the Mac ROMs in 32-bit fast RAM, indicate whether or not to use the SE's native 16-bit memory, and install a RAM disk) while the SE is running or when you restart the machine. For the Radius Accelerator 25, a *Radius SANE INIT* patches the Apple *SANE* traps to use the 68881 (if present), and an *Accelerator CDEV* lets you toggle on or off a code cache (the 68020 instruction cache) and a data cache (the accelerator board's 32K-byte cache).

I put both boards into a Mac SE and ran some of the *BYTE* Small-C benchmarks. For an accurate comparison to the Mac SE's native CPU, the benchmarks used 68000 code. For the TSI-020MX, the times (in seconds) were *Matrix*, 12.3; *Sieve*, 23.8; and *Sort*, 24.8. For the Radius Accelerator 25 board: *Matrix*, 10.5; *Sieve*, 20.1; and *Sort*, 19.6. The timings for a conventional SE are *Matrix*, 67.1; *Sieve*, 170.2; and *Sort*, 154.2. *Mac II* timings are *Matrix*, 21.2; *Sieve*, 40.2; and *Sort*, 44.2.

The results indicate that a Mac SE equipped with one of these boards runs five to seven times faster than a conventional SE, and twice as fast as a Mac II. But keep in mind that these tests evaluated only CPU throughput. Applications that make extensive use of a hard disk drive or work with more memory than can fit in the cache won't perform as well. However, if you need the power of a Mac II but have a limited budget, these boards deserve a serious look.

—Tom Thompson  
*continued*



## Borland's New Prolog: Even Better

**T**urbo Prolog 2.0 is a significant step forward for this popular version of the language. It has the same high speed and nicely integrated environment of the previous versions, and it presents a number of new features, like an external database and a user interface that is more consistent with that of other Borland products.

For those who are not familiar with it, Prolog is an ideal language for developing applications that are highly recursive or that involve complicated IF...THEN control structures. Prolog can be used, for example, to build expert systems and sentence parsers, or to solve the traveling salesman problem. It can also be used for prosaic tasks like figuring your expense account.

In the past, Turbo Prolog has been faulted for not conforming to the standard Edinburgh dialect. In this new release, Borland addresses this problem in an interesting way: It provides an Edinburgh-style Prolog interpreter that is written in Turbo Prolog itself. Of course, like any interpreter, the Prolog Inference Engine, as it is called, is slow and does not claim to be completely compatible with the Edinburgh or Clocksin and Mellish dialects. But over time, users may be able to turn it into an interesting Prolog system in its own right.

Perhaps the most significant addition is the capability for external databases. In the older version, your database was limited by the size of your RAM. The new version lets you store information either in RAM, as in the past, or externally, on a disk file. For fast sorts and data retrieval, these databases can be indexed with a B+ tree.

There are also a number of



### THE FACTS

**Turbo Prolog 2.0**  
\$149.95

Borland International  
4585 Scotts Valley Dr.  
Scotts Valley, CA 95066  
(800) 543-7543  
Inquiry 852.

**Requirements:**  
IBM PC or equivalent  
with 384K bytes of RAM.  
A hard disk drive is  
recommended.

**Options:**  
Turbo Prolog Toolbox,  
\$99.95

niche features. For example, Turbo Prolog predicates can now have more than one arity (i.e., the same predicate can mean different things depending on how many arguments it has). One-line comments can

be indicated by simply placing a % at the front of a line. When you compile a program, you can control how much memory it will take up, which suggests that we will soon see memory-resident Prolog ap-

plications. And it is now possible for other languages to call Turbo Prolog routines. Of course, all these additions take up code space; the program has grown to the point where you pretty much have to have a hard disk drive.

There is almost no change in performance: The new version was about 1 percent slower in running my traveling salesman program than the previous version. But the executable file of the program was 2 percent smaller and 3 percent faster than that on the older version.

As for documentation, the new Turbo Prolog comes in a two-volume package similar to that of Turbo C. The new version has roughly four times the amount of documentation provided by the old version's single 200-page manual. Much of this is used to describe the new features added, but the extra space also lets the documentation writers go into more detail on elementary aspects of the language.

If you're interested in Prolog and you haven't tried Turbo, you're in for a treat. A warning, though: Once you get the hang of it, Turbo Prolog can be very addicting.

—Rich Malloy

## Running OS/2 on an IBM PC

**Y**es, you can run OS/2 on an IBM PC, but it's expensive. I took a look at the SOTA MotherCard 5.0 and the Microsoft Mach 20, 80286 accelerator cards that can run OS/2. But before looking at the products, let's consider what you need to run OS/2 on a PC.

First, you need an accelerator board that can run the 80286 instruction set (either an 80286 or 80386). You also need at least 2 megabytes of extended memory. It pays to have 3 megabytes, since many OS/2 programs require that much memory (Paradox OS/2, for example). Finally, you need a high-capacity 5¼-

inch or 1.44-megabyte 3½-inch floppy disk drive to load OS/2 software.

Adding these features to your PC is a formidable investment. With SOTA's MotherCard 5.0, it will cost you around \$2000. At first glance, Microsoft's Mach 20 seems cheaper, but if you want 3 megabytes of memory and a high-capacity drive, the Mach 20 system will cost as much as, if not more than, the MotherCard 5.0 setup. In addition to the hardware, you'll have to buy OS/2. If you're using the Mach 20, you'll have to upgrade to DOS 3.2 if you want to use high-capacity or 3½-inch drives.

SOTA's MotherCard 5.0 comes in 10-MHz and 12-MHz configurations with 1 megabyte of RAM (\$895 and \$995, respectively). An additional DaughterCard, which installs on the MotherCard, is available with 1 or 2 megabytes of RAM (the 10-MHz DaughterCard with 2 megabytes costs \$895, and the 12-MHz version costs \$995). The MotherCard 5.0 is essentially an IBM PC AT on an expansion board. It has its own real-time clock and an 80287 socket, and it supports monochrome, CGA, and EGA. The DaughterCard uses 256K-bit single in-line memory mod-

continued



© Eastman Kodak Company, 1988

**New.**  
**KODAK DATASHOW HR System**  
**puts IBM PC images on the big screen.**

Kodak introduced the revolutionary idea of an LCD to project PC images on a big screen with an overhead projector. Now the revolution continues with the next generation of Kodak's ultra twist LCD crystals. They project clearly superior images with a high-resolution 640 x 400 pixel display and exclusive 20:1 contrast ratio. System compatibility has also been extended to PCs with EGA as well as CGA, the colors automatically defined in true shades of gray. You won't have to fiddle with fluctuating contrast, either. The new cooling system eliminates heat buildup causing this problem in other systems. An IR remote control is included along with software

for presentation management and remote control of application programs. This system can be used with IBM PCs and 100% compatibles. For product and dealer information, call 1 800 44KODAK (1 800 445-6325), Ext 842U.



# THE BEST IMAGE FOR YOUR PC IS FROM KODAK

*The new vision of Kodak*





# C\_talk™ Object-oriented Extensions For C

**C\_talk, A SERIOUS TOOL FOR SERIOUS SOFTWARE ENGINEERS:**

- Adds encapsulation, inheritance and dynamic messaging to your C compiler.
- Smalltalk-like **Browser** for building objects.
- Semi-automatic **Make** for building applications.
- Preprocessor** for converting objects to standard C source code.
- Foundation classes to help you get started.
- Professional telephone support from our engineering staff.

**STILL  
\$149.95**

Start building software components into your next application. Join the leading edge today.

**Order Now:**

CNS, Inc.  
Software Products Dept.  
7090 Shady Oak Road  
Eden Prairie, MN 55344  
Tel: (612) 944-0170  
Fax: (612) 944-0923  
30 day money back guarantee  
MasterCard, Visa  
Shipping \$ 5 - U.S.  
\$ 25 - Int'l

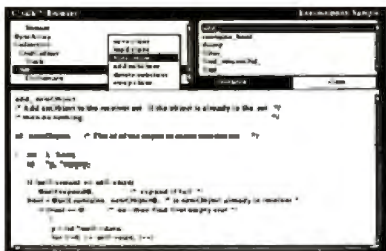

C\_talk is designed for an IBM® PC (or compatible) with Microsoft® C, Lattice C, Turbo C, or C86. A system with a hard drive and mouse is highly recommended.

IBM is a registered trademark of IBM Corp. MICROSOFT is a registered trademark of MICROSOFT CORP. C\_talk is a trademark of CNS, Inc.



## MATHPAK 87 High Performance 80x87 Software

**MATHPAK 87** is a set of over 130 assembler coded numerical routines for use with 80x87 math coprocessors. These routines are highly optimized and run up to 10 times faster than equivalent high-level language routines. A detailed and easy-to-read manual (180 pages) gets you started using **MATHPAK 87** in minutes. **MATHPAK 87** routines are fast, convenient and reliable.

### MATHPAK 87 Timings (IBM XT)

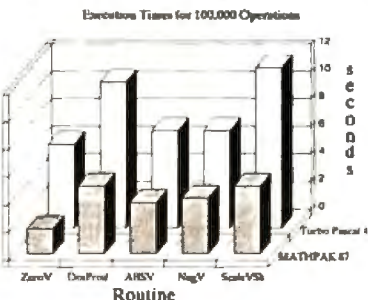

**MATHPAK 87 includes:** 65 vector/scalar routines (vector add, subtract, ...); 24 complex vector/scalar routines; 11 matrix routines (add, subtract, multiply, transpose, etc.); LU decomposition/back-solving routines for real and complex systems; Gaussian elimination; matrix inversion; tridiagonal equation solver routines; EISPACK eigenvalue/vector routines; statistical routines; FFT routines (1-D, 2-D, complex, real, convolution); spectral analysis routines (windows: Parzen, Hamming, ...); routines for numerical integration and solution of differential equations; and missing functions for Modula-2 and Pascal: tan, log10, alog10, power, sinh, cosh and tanh.

**MATHPAK 87 routines are the fastest available!** On an IBM XT, a 1K complex FFT takes 1.85s (real 1.0s); dot product (length 10,000) takes 0.494s.

**\$99 US for Turbo Pascal 4.0 version.** \$119 US for MS Fortran, IBM Pro Fortran, Lahey F77L, MS C, Lattice C, Logitech Modula-2 or ITC Modula-2 versions. Please specify version. Add \$5 shipping/handling.

**Precision Plus Software,** 1239 Sir David Drive, Oakville, Ontario, Canada L6J 6Y9. Telephone: (416) 829-1511, FAX: (416) 829-1742.

**International Dealers:** U.K.: Grey Matter Ltd., Tel: (0364) 53499; West Germany: SOS Software Service GmbH, Aker Postweg 101, 8900 Augsburg, Tel: 0821/57 1081.

### THE FACTS

**SOTA MotherCard 5.0:** \$995 for 12-MHz version; \$895 for 10-MHz version

**SOTA DaughterCard:** \$995 for 12-MHz version with 2 megabytes of RAM; \$895 for 10-MHz version with 2 megabytes of RAM  
**Floppy I/O Plus multimedia controller:** \$149

#### Requirements:

IBM PC or compatible with 64K bytes of RAM and DOS 3.1

**SOTA Technology, Inc.**  
657 North Pastoria Ave.  
Sunnyvale, CA 94086  
(408) 245-3366  
Inquiry 853.

I/O Plus controller is straightforward. You remove the 8088 processor from its socket, install it on the MotherCard, and plug the supplied cable into the 8088 socket. Next, remove the existing floppy disk drive controller and install the Floppy I/O Plus controller and the new disk drives, if necessary. After installation, you boot up in 80286 mode and run the company's Setup and software installation programs to install the OS/2 patches. You can use your existing system board memory as a RAM disk or for disk caching, using SOTA's supplied Expanded Memory Specification (EMS) and disk-caching drivers.

I ran OS/2 on the MotherCard with no problems. I tried Paradox OS/2 and ran multiple tasks and the DOS-compatibility window. The 12-MHz version of the MotherCard offered faster performance than our MicroServe 10-MHz AT clone. I ran BYTE's 80286 benchmarks, and they all ran faster than on the AT clone.

The SOTA MotherCard 5.0 is a well-engineered and elegant solution for running OS/2 on a PC. Although the MotherCard is very easy to install, one weakness of the package is SOTA's user manual, which doesn't clearly explain how to run the software installation. An important step is running the Setup program to determine the memory configuration and the types of floppy disk drives you're using. Unfortunately, this step is not mentioned in the user manual. But aside from the large expense, I would recommend installing the MotherCard 5.0 in a PC.

The Mach 20 setup for OS/2 consists of three components: the Mach 20 board, which is an 8-MHz half-length 80286 accelerator card; the Memory Plus option; and the Disk Plus floppy disk controller card. These three components connect together and require only a single slot. Note that these three components alone cost

ules (SIMMs) and supports 1-megabit SIMMs for expansion up to 8 megabytes.

My test unit was a 12-MHz version with the 2-megabyte DaughterCard. In addition, SOTA provided its Floppy I/O Plus controller and two 1.2-megabyte 5¼-inch floppy disk drives, which you would have to purchase separately. The Floppy I/O Plus controller also supports 3½-inch floppy disk drives or a combination of drive types and runs under DOS 3.1 or higher.

The SOTA MotherCard 5.0 runs only IBM OS/2. At the time of this writing, it does not support the Microsoft SDK (Software Developer's Kit) version of OS/2. The MotherCard 5.0 uses a unique reconfigurable BIOS, which lets you install a "patch" to the BIOS to run OS/2. You must also install a special SOTA driver on the IBM OS/2 installation disk. Be forewarned that the 5¼-inch version of OS/2 is not easy to come by. Most dealers don't stock it, so you'll most likely have to special-order it. The alternative is to get a 1.44-megabyte 3½-inch floppy drive for your PC.

Installation of the SOTA MotherCard and the Floppy

*continued*



# Aztec C

*Power to go the distance...  
Whatever that distance might be*



From real time embedded applications to comprehensive commercial applications on Macintosh, IBM PC, Amiga, Atari, and others, Aztec C has earned a well-deserved reputation as an innovative, tough to beat, rock-solid C development system.

But don't just take our word for it—try it yourself. We know that the best way to understand what puts you ahead with Aztec C is to use it. That's why Aztec C

systems purchased directly from Manx come with a 30-day, no questions asked, satisfaction guarantee. Call for yours today.

We can also send you information that details the special features and options of Aztec C. Plus information on support software, extended technical support options, and all of the services and specialized support that you may need when you're pushing your software to the limits and ... beyond.

## **MS-DOS Hosted ROM Development Systems**

Host + Target: \$750 Additional Targets: \$500

### **Targets:**

- 6502 family
- 8080-8085-Z80-Z180-64180
- 8088-8086-80186-80286/8087-80287
- 68000-68010-68020/68881

### **Components:**

- C compiler for host and target
- Assembler for host and target
- linker and librarian
- Unix utilities make, diff, grep
- Unix vi editor
- debugger
- download support

### **Features:**

- Complete development system
- Fast development times
- Prototype and debug non-specific code under MS-DOS
- Compilers produce modifiable assembler output, support inline assembly, and will link with assembly modules
- Support for INTEL hex, S record, and other formats
- source for UNIX run time library
- processor dependent features
- source for startup

## **Aztec C Micro Systems**

Aztec C is available for most micro-computers in three configurations: The Professional; The Developer; and The Commercial system. All systems are upgradable.

**Aztec C68k/Am .... Amiga**  
source debugger—optional

**Aztec C68k/Mac ... Macintosh**  
MPW and MAC II support

**Aztec C86 .....** MS-DOS  
source debugger • CP/M libraries

The following have special pricing and configurations Call for details.

**Aztec C68k/At .....** Atari ST

**Aztec C80 .....** CP/M-80

**Aztec C65 .....** Apple II & II GS

**Standard System .....** \$199

- C compiler
- Macro Assembler
- overlay linker with librarian
- debugger
- UNIX and other libraries
- utilities

**Developer System .....** \$299

- all Standard System features
- UNIX utilities make, diff, grep
- UNIX vi editor

**Commercial System .....** \$499

- all Developer features
- source for run time libraries
- one year of updates

C.O.D., VISA, MasterCard, American Express, wire (domestic and international), and terms are available. One and two day delivery available for all domestic and most international destinations

**Manx Software Systems**  
One Industrial Way  
Eatontown, NJ 07724

*Aztec C is available on a thirty-day money back guarantee. Call now and find out why over 50,000 users give Aztec C one of the highest user-satisfaction ratings in the industry.*

## **Call 1-800-221-0440**

**In NJ or outside the USA,  
call 201-542-2121**

**Telex: 4995812 Fax 201-542-8386**



# A MESSAGE TO OUR SUBSCRIBERS

FROM TIME TO TIME WE make the BYTE subscriber list available to other companies who wish to send our subscribers material about their products. We take great care to screen these companies, choosing only those who are reputable, and whose products, services, or information we feel would be of interest to you. Direct mail is an efficient medium for presenting the latest personal computer goods and services to our subscribers.

Many BYTE subscribers appreciate this controlled use of our mailing list, and look forward to finding information of interest to them in the mail. Used are our subscribers' names and addresses only (no other information we may have is ever given).

While we believe the distribution of this information is of benefit to our subscribers, we firmly respect the wishes of any subscriber who does not want to receive such promotional literature. Should you wish to restrict the use of your name, simply send your request to the following address.

**BYTE MAGAZINE**

ATTN: SUBSCRIBER SERVICE  
P.O. BOX 7643  
TEANECK, NJ 07666-9866



## SHORT TAKES

### THE FACTS

Mach 20  
\$495

#### Requirements:

IBM PC or compatible with 64K bytes of RAM and DOS 3.2 if you want to use high-capacity or 3½-inch drives

#### Options:

Memory Plus card with 512K bytes, \$395; Disk Plus multimedia controller, \$99

Microsoft Corp.  
16011 Northeast 36th  
Way  
P.O. Box 97017  
Redmond, WA 98073  
(206) 882-8080  
Inquiry 854.

almost \$1000—and that doesn't include the additional 2 megabytes of RAM and the high-capacity disk drive you'll need. And with 256K-bit chips, you can install only 1.5 megabytes of RAM on the Memory Plus board. You'll need to find, buy, and use more expensive 1-megabit chips to install 3 megabytes of memory in your system.

Installing the Mach 20 is not a trivial matter. To start off, you have to plug the three pieces together, which is a simple operation. Then you have to go through a lengthy installation program, which explains how to set the myriad jumpers on the Mach 20. You may also have to modify the switch settings on the system board of your PC. The installation program writes a series of drivers to your boot disk. I made the mistake of trying to use a floppy disk as a boot disk. Problems arise if you later want to change your drives and have to modify the settings for the floppy disk controller. Therefore, it is best to install the drivers on the hard disk drive.

Nevertheless, I got the system running. However, the floppy disk drives behaved

very strangely under the supervision of the Disk Plus controller. They made groans and grinding noises I had never heard when they were connected to the original controller. In addition, drive A's light would go on immediately when I booted the computer and would stay on throughout the normal POST memory test. These quirks didn't hinder the operation of the Mach 20, but they certainly made me nervous.

I ran the BYTE 80286 benchmarks on the Mach 20, which has an 8-MHz clock speed, and it was about 25 percent slower than our 10-MHz MicroServe AT clone and about 40 percent slower than the SOTA MotherCard. While the system seemed to be working at this point, I was getting periodic boot errors (301 system board) and was becoming increasingly disturbed by the odd noises that the floppy disk drives continued to make.

The next step was to install OS/2. Microsoft provided a beta copy of its special Mach 20 OS/2 version. The package came with a menu-driven installation program, and you can use 360K-byte 5¼-inch drives to install OS/2. However, OS/2 won't do you much good without a high-capacity drive, because no software is available in 360K-byte format. Unfortunately, I was unable to get OS/2 to run. I installed it on the hard disk drive, but then the hard disk drive wouldn't boot. In fact, the light on drive A stayed on continuously, and I had to turn the machine off.

It's hard to recommend the Mach 20 at this time. Even in spite of its quirks (and I'm sure Microsoft will get OS/2 running eventually), it's not a cost-effective way to run OS/2. You would be better off saving your money for an AT clone. The SOTA MotherCard 5.0 is also an expensive solution, but at least it works reliably and seems to be a solid product.

—Nick Baran  
continued

# Digitizers

## 18" x 24" thru 9' x 9' x 9'

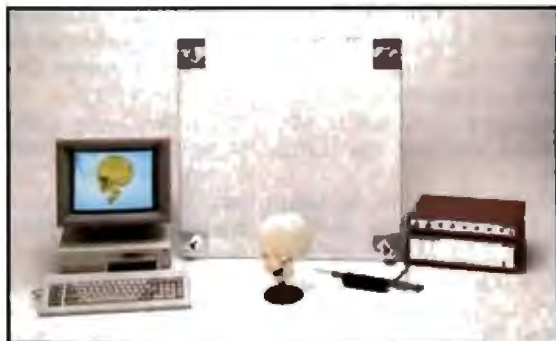

We'll cover your digitizer needs with twelve different active areas to choose from. From the GP-7 Grafbar Mark II, ("Flexible, Precise, and Elegant . . .", PC Magazine), all the way through the 60" x 72" GP-8, and of course the user adjustable active volume, (up to 9 ft. cube), of the GP-8-3D. And you can digitize on any work surface.

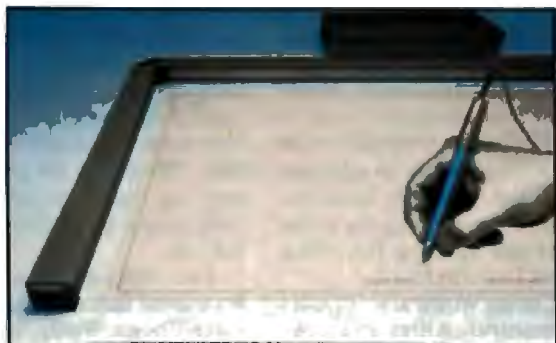

All our digitizers come complete with RS-232 output format, power supply, two-way communications, a stylus, optional one button and four button cursors, a five function menu, and are IBM-PC compatible. So no matter what your size requirements are, we've got you covered; (at low cost too!).



OEM versions available. Directly supported by AutoCAD, ProDesign II, Generic CADD, CADVANCE, CADKEY, Easy Digit, etc. Also, compatible with Lotus Measure.

For more information contact:  
Skip Cleveland (203) 255-1526

## We've got your size.

**SAC**<sup>®</sup> SCIENCE  
ACCESSORIES  
CORPORATION

970 Kings Highway West, P.O. Box 550    Southport, CT 06490    (203) 255-1526 • Telex 964300    FAX (203) 254-7271



Want to save Time, Money,  
& Headaches?



GET SUPERSOFT'S  
SERVICE DIAGNOSTICS

All the software, alignment diskettes, parallel/serial wrap-around plugs, ROM POSTs and extensive, professional documentation to provide the most comprehensive testing available for IBM PCs, XTs, ATs and all compatibles under DOS or Stand Alone. No other diagnostics offers such in-depth testing on as many different types of equipment by isolating problems to the board and chip level.

**NEW:** SuperSoft's ROM POST performs the most advanced Power-on-Self-Test available for system boards that are compatible with the IBM ROM BIOS. It works even in circumstances when the Service Diagnostics diskette cannot be loaded.

**NEW:** 386 diagnostics for hybrids and PS/2s!

For over nine years, major manufacturers have been relying on SuperSoft's diagnostics software to help them and their customers repair microcomputers. End users have been relying on SuperSoft's Diagnostics II for the most thorough hardware error isolation available. Now versions of Service Diagnostics are available to save everyone (including every serious repair technician) time, money, and headaches in fixing their computers, even non-IBM equipment.

All CPUs & Numenc Co-processors	All Color Graphics & Monochrome
System Expansion & Extended Memory	Monitors
Floppy, Fixed & Non-standard Disk Drives	Parallel & Serial Ports
Standard & Non-standard Printers	Mono, CGA, Hercules & EGA
System Board: DMA, Timers, Interrupt,	Adapters
Real-time Clock & CMOS config. RAM	All Keyboards & the 8042 Controller

Join the ranks of XEROX, NCR, CDC, SONY, PRIME, ... who have bundled SuperSoft's diagnostics with their microcomputers at no risk because of our 30 day money back guarantee.

Service Diagnostics for PC, PC/XT, and compatibles only .....	\$169
Alignment Diskette for PC, PC/XT and compatibles (48 tpi drives) .....	\$ 50
Wrap-around Plug for PC, PC/XT and compatibles (parallel and serial) .....	\$ 30
Service Diagnostics for AT and compatibles only .....	\$169
Alignment Diskette for AT and compatibles (96 tpi drives) .....	\$ 50
Wrap-around Plug for AT (serial) .....	\$ 15
ROM POST for PC, PC/XT, and compatibles only .....	\$245
ROM POST for AT and compatibles only .....	\$245
Service Diagnostics: The KIT (includes all of the above—save \$502) .....	\$495
Service Diagnostics for all other CPUs (386, V20, V30, Harris, etc.) .....	\$195
Diagnostics II is the solution to the service problems of users of all CPM-80, CP/M 86 and MS-DOS computers .....	\$125
ROM POST for PS/2 and compatibles only .....	\$245
Alignment Diskette for PS/2 and compatibles (3 5 inch) .....	\$ 50

To order, call 800-678-3600 or 217-359-2112,  
FAX 217-359-7225, or write SuperSoft.

your microcomputer repair solution

# SuperSoft

FIRST IN SOFTWARE TECHNOLOGY P O Box 1628 Champaign, IL 61820 (217) 359-2112 Telex 270365

SUPERSOFT is a registered trademark of SuperSoft, Inc., CDC of Control Data Corp., IBM PC, AT & XT of International Business Machines Corp., MS-DOS of MicroSoft Corp., NEC of NEC Information Systems, Inc., PRIME of PRIME INC., Sony of Sony Corp.

## A Dictionary on a Hard Disk Drive

When it comes to writing, I believe in the 3-foot rule. That is, you ought to keep a dictionary no more than 3 feet away from the spot where you're working. That's where Proximity's Choice Words comes in. Choice Words is an 80,000-word, hard disk drive version of a Merriam-Webster dictionary. And we're not talking spelling checking here.

Choice Words is, in fact, the first electronic dictionary—complete with definitions—that works on an MS-DOS computer without an optical disk or some other exotic storage device that costs enough to make many users decide to stick with a printed dictionary. Specifically, it takes up less than 2 megabytes of hard disk drive space. Because it's RAM-resident, it also needs about 100K bytes of RAM.

Best of all, it works within almost any word processor. Just place the cursor on a word, hit the hot key, and you've got the definition of that word. Just hit the hot key, and you can type in any word you wish. If Choice Words can't find a matching word in its dictionary, it displays a list of its best guesses of alternate spellings. I usually found the word I was looking for in the alternate spelling list—even when I tried to fool it.

Choice Words also includes a thesaurus. Although a number of good word processors already have a thesaurus, this one is a little different. Instead of just providing a list of syn-

onyms, Choice Words first forces you to choose the appropriate definition for the word you want to replace, and then it gives you only the synonyms for that definition. This way, you don't mistakenly use a replacement word that connotes the wrong message. Or at least that's the theory.

But the theory didn't work so well with some words. For "continual" and "continuous," for example, the thesaurus provides you with only one definition.

Both the dictionary and the thesaurus let you replace the word at the cursor position in your word processor with any word you select from the Choice Words display. You can also toggle to and from the thesaurus and the dictionary.

Installed on the 20-megabyte hard disk drive in my 10-MHz IBM PC AT clone, Choice Words usually responded in about 2 seconds (when the spelling was correct) to about 5 seconds (when the spelling was wrong). Although that's probably faster than anyone can find a word in a printed dictionary, there is a trade-off: The definitions are roughly equivalent to an abbreviated "pocket" dictionary. Given that the program uses less than 2 megabytes of drive space, that trade-off is a fair one.

Aside from the thesaurus's occasional lack of definitions, I like Choice Words, and at a cost of only \$99, I recommend the program.

—Dennis Allen  
continued

### THE FACTS

Choice Words  
\$99

Proximity Software  
3511 Northeast 22nd Ave.  
Fort Lauderdale, FL 33308  
(800) 543-3511  
(305) 566-3511  
Inquiry 851.

Requirements:  
IBM PC or compatible with  
256K bytes of RAM, DOS  
2.0 or higher (a PC AT  
requires DOS 3.0 or  
higher), and either a hard  
disk drive or a 1.2-megabyte  
floppy disk drive.

# SELECT 5 BOOKS for only \$3.95

(values to \$125.75)



2929P \$15.95

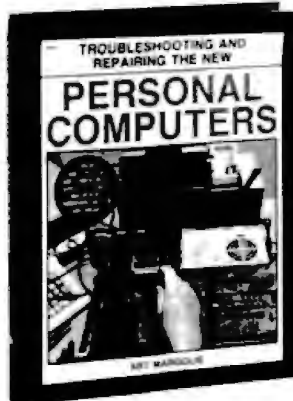

2809 \$26.95  
Counts as 2



2800P \$19.95

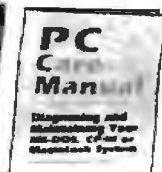

2901 \$24.95



2803P \$19.95



2848 \$26.95  
Counts as 2



2601 \$23.95



2870P \$22.95



2700 \$46.95  
Counts as 3



2687 \$26.95



2627P \$17.95



1939P \$19.95



2656P \$19.95

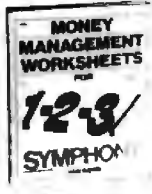

1968P \$14.95



2777P \$17.95



2870 \$24.95

When it's new and important in business or personal computing, The Computer Book Club has the information you need . . . at savings of up to 50% off publishers' prices!



2677P \$16.95

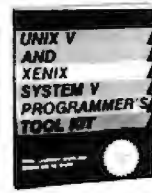

2781P \$19.95



2890 \$32.95  
Counts as 2

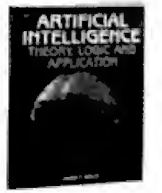

2971P \$12.95



2859P \$19.95



2831 \$22.95



2748P \$14.95



2655P \$16.95



2983 \$26.95  
Counts as 2



2977P \$17.95



2907P \$19.95



3024P \$19.95



2852P \$17.95



2833 \$21.95



2650 \$25.95



The Computer Book Club®

**Membership Benefits • Big Savings.** In addition to this introductory offer, you keep saving substantially with members' prices of up to 50% off the publishers' prices. • **Bonus Books.** Starting immediately, you will be eligible for our Bonus Book Plan, with savings of up to 60% off publishers' prices. • **Club News Bulletins.** 14 times per year you will receive the Book Club News, describing all the current selections—mains, alternates, extras—plus bonus offers and special sales, with hundreds of titles to choose from. • **Automatic Order.** If you want the Main Selection, do nothing and it will be sent to you automatically. If you prefer another selection, or no book at all, simply indicate your choice on the reply form provided. As a member, you agree to purchase at least 3 books within the next 12 months and may resign at any time thereafter. • **Ironclad No-Risk Guarantee.** If not satisfied with your books, return them within 10 days without obligation! • **Exceptional Quality.** All books are quality publishers' editions especially selected by our Editorial Board. BY-988



2545 \$29.95  
Counts as 2



2951P \$17.95



1848P \$15.95



2620 \$25.95



2937 \$29.95  
Counts as 2



2880P \$16.95

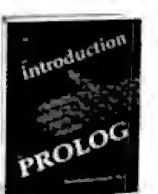

2682P \$16.95

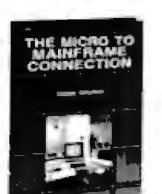

2637 \$22.95

If card is missing, use this address to join: THE COMPUTER BOOK CLUB®, Blue Ridge Summit, PA 17294-0820

Circle 52 on Reader Service Card



# Compact Disk Products, Inc.

## CD-ROM/WORM

ALL PRODUCTS, LOWEST PRICES, EXPERT ADVICE

### INTRODUCTORY OFFERS

- Hitachi 5035 or 3500S CD-ROM Drive with your choice of:
- McGraw Hill Science and Technical Reference Set . . . \$895
  - Grolier Electronic Encyclopedia . . . \$895
  - Microsoft Bookshelf . . . \$895
  - PG&G Library (Disks 1 - 1000) . . . \$895

### CD-ROM SOFTWARE

- Oxford English Dictionary . . . **NEW** \$846
- Comstock Stock Photography On CD . . . **NEW** \$445
- Grolier or McGraw Hill or Bookshelf or PG&G . . . \$269
- The Bible Library . . . \$495
- Kirk-Othmer Encyclopedia of Chemical Technology . . . \$845
- Registry of Mass Spectral Data . . . \$2655
- Geovision U.S. Atlas and Mapmaker . . . \$795

TOLL FREE ORDER LINE - 800-MEGABYTE (634-2298)

### CD-ROM and WORM DRIVES

- Hitachi 5035 External CD-ROM Drive with Audio . . . \$729
- 5035 with Digital Audio Output . . . \$1229
- Hitachi 3500S Internal 42 Height CD-ROM Drive w/Audio . . . \$719
- Maxtor 800 MB WORM Drive . . . \$3799
- Optocore Laserbank 400 MB WORM Drive . . . \$2799
- Portable 286 with CD-ROM Drive . . . \$3795

- CD-Capture (\$85)** Capture Digital Audio information from any CD to RAM or Disk. Also allows playback of music from RAM.
- CD-Play (\$89)** Pop-up utility that permits user to play all audio CDs on Hitachi and compatible drives. Output to headphones or amplifier.
- CD-PlaySampler (\$149)** Same features as CD-Play plus the ability to name two copies on an audio CD and loop between them.
- CD-AudioFile (\$149)** Automatically creates database records of all your audio CDs. Allows you to store a preferred play sequence for each disk. Automatic recognition of CDs. Creates Database compatible records.

### CDP

217 E. 85th St.  
Suite 216  
New York, NY 10029  
Tel: 212-998-6999  
Fax: 212-439-8109  
CompuServe: 75530214

Free 3 Month  
Subscription to  
CD-ROM Review  
with orders over  
\$300

### INTERNATIONAL ORDERS A SPECIALTY

Australian Agent: KEWTEL  
145 Colham Rd.  
Kew, Victoria 3101  
Tel. (03) 817-9833

# NEC TAKES CARE OF ITS OWN.



Owning an NEC computer or printer makes you part of the NEC family. And nobody takes more pride in offering you quality service than the family of NEC Customer Engineering and its authorized dealers.

We offer a full range of service options, quality parts, and comprehensive maintenance contracts. Call us, and find out about the many ways NEC Information Systems takes care of its own.

Service Excellence Through People, Pride and Professionalism™

**1-800-325-5500**

C&C

**NEC**

## Konan the Controller

**K**onan's new Tentime is an IBM PC AT-compatible "intelligent caching" disk drive controller with an impressive resume.

It boasts 128K bytes of on-board RAM with a 4-year lithium-battery backup. It needs the battery because the cache is not "write-through." That is, when your system issues a write command to the controller, the Tentime doesn't send the data immediately to disk. Instead, the Tentime puts the data in its cache, and when it must perform a write operation, it sorts the data prior to writing to the disk. In this way, head movement is reduced (e.g., if you issued writes to tracks 12, 90, 8, and 66, the Tentime would actually write them in this order: 8, 12, 66, 90). Since the battery is there, even if you shut the system off before the controller flushes its cache, your data is retained for the next time you power your system up.

Next, you get an optional on-board floppy disk drive controller, so you can use the Tentime to completely replace your AT's current hard/floppy disk drive controller. (The Tentime with a floppy disk controller can handle up to two ST-506/412 hard disk drives and two 3½-inch or 5¼-inch floppy disk drives—360K bytes, 1.2 megabytes, or 1.44 megabytes.) I already had a hard/floppy disk controller card in the machine on which I tested the board, so I disabled the Tentime's floppy section and ran two hard disk drives on the system. I was more interested in the board's performance as a hard disk drive controller, anyway.

The manufacturer claims that this controller has an 80 percent to 95 percent hit rate on the cache. The controller's name says it all: You should expect the Tentime to operate 10 times faster than other controllers. Does it?

I ran the Tentime through a number of tests and got mixed

results. I used a 10-MHz AT clone with two hard disk drives. One, a Seagate ST-225, hooked to the Tentime; the other, an ST-4038, connected to an AT-clone hard disk drive controller. The BYTE low-level benchmark FILEIO test (which creates, reads, and writes a series of arbitrarily complex files) and 1-megabyte File Read and Write tests showed the Tentime turning in performances anywhere between 2 and 11 times that of the other controller (Read operations did much better). However, when I ran the Coretest on both drives, the drive in the Tentime simply left the other drive in the dust. The access times reported for the Tentime were down around 0.7 millisecond—between 12 and 30 times better than those shown for the other drive.

The price for the Tentime, however, is steep. It says something when you pay \$595 for a controller board and you can get a 20-megabyte hard disk drive for half that much. (I've seen ads for a 20-megabyte hard disk drive and controller for \$250.) I'd say this is definitely a product for the power user. If you need lots of megabytes and you need them fast, the Tentime probably deserves a slot in your AT.

—Rick Grehan

### THE FACTS

Tentime  
TNT-1050 (with floppy disk controller), \$695;  
TNT-1000 (without floppy controller), \$595

Requirements:  
IBM PC AT or compatible. No specific operating-system or memory requirements.

Konan Corp.  
4720 South Ash Ave.  
Tempe, AZ 85282  
(602) 345-1300  
Inquiry 857.



# ROAD WARRIORS.



## INTRODUCING ZENITH'S NEW BATTERY-POWERED PORTABLES.

ZENITH INNOVATES AGAIN—with a state of the art family of battery-powered portables led by the single most revolutionary portable ever created. TurbosPort 386™.

TurbosPort 386 is breakthrough inside and out. Outside, Zenith's exclusive Page White™ display virtually duplicates printed page clarity. Its sharp black images are refreshed quickly on a fluorescent backlit screen. Plus a fully detachable keyboard (unheard of on any other battery-powered portable).

Inside the compact TurbosPort 386, the breakthroughs continue with a powerful 80386 microprocessor harnessed to a fast access 40MB hard disk. And zero wait state technology for up to 50% greater speed than other 12MHz systems.

Next comes the lightweight SupersPort 286™, the highest performance 286 class machine among all laptops... or

desktops. With a choice of fast access 20 or 40MB hard disk.

The third member of the pack is the SupersPort™ with 20MB hard disk or dual floppy systems and detachable battery packs for optimum flexibility.

All three machines ride on Zenith's Intelligent Power Management System™ for maximum battery life.

Three new portables—three more reasons why Zenith is the battery-powered leader. For the name of your nearest Zenith Data Systems Dealer, call: 1-800-842-9000, ext. 1.

**ZENITH**

**data  
systems**

THE QUALITY GOES IN BEFORE THE NAME GOES ON®



Our newest soft  
like the software



# ware works just you're using now.

We've always thought that one of the biggest problems with personal computing is that a computer doesn't process information the same way that a person processes information.

And in the struggle between the two, the computer usually wins.

Enter the Lotus® Agenda® personal information manager.

Agenda's flexible design lets you dump facts and ideas into your PC without structuring them in advance.

You can arrange the information any way you want. So you can gain insight,

formulate new ideas, and find answers you need. And as a result, manage

projects, people and information better.

How does Agenda work? First, enter items of information into Agenda.

Then create categories where you want all the information to be filed.

## Introducing Lotus Agenda

Voilà. Agenda will do all your filing automatically. And if an item is relevant in more than one place, Agenda will put it in several categories at once.

What's more, if you change an item

anywhere in your file, all other categories that have the same item will also change automatically.

FILED AGENDA - FILES - ISSUES		08/21/88 11:00	
Joel Issues by Priority			
Issues	Joel	Priority	When
• Research	• Decision needed on research budget by end of this week— discuss options with Jim and Joan	• High	• 08/25/88
• Competitive Pricing	• Forward product competitive analysis to Joan	• Low	• 07/27/88
Bob Issues by Priority			
Issues	Bob	Priority	When
• Distribution	• Do Tom and Bob think we need to adjust distribution mix?	• High	• 08/22/88
• Bonus Dollars	• Bob will present ten-point incentive program at sales conference	• Medium	• 08/29/88

Agenda automatically files items in all relevant categories. Then you can view information from different perspectives.

This makes it easy to view evolving data in different ways so you can discover new relationships and pinpoint information that's important to you.

For \$15, we'll send you an Agenda demo kit or videotape. Just call 1-800-345-1043 and ask for demo kit AGT-3058 for the 3.5" version or AGT-3053 for the 5.25" version, or you can ask for AGT-3063 for the videotape version.

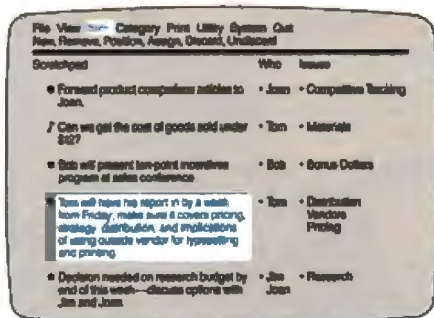

Enter items of information manually, import them electronically, or use the pop-up capability while in another program.



# Train Your PC to Read...

...the Same Things You Read!

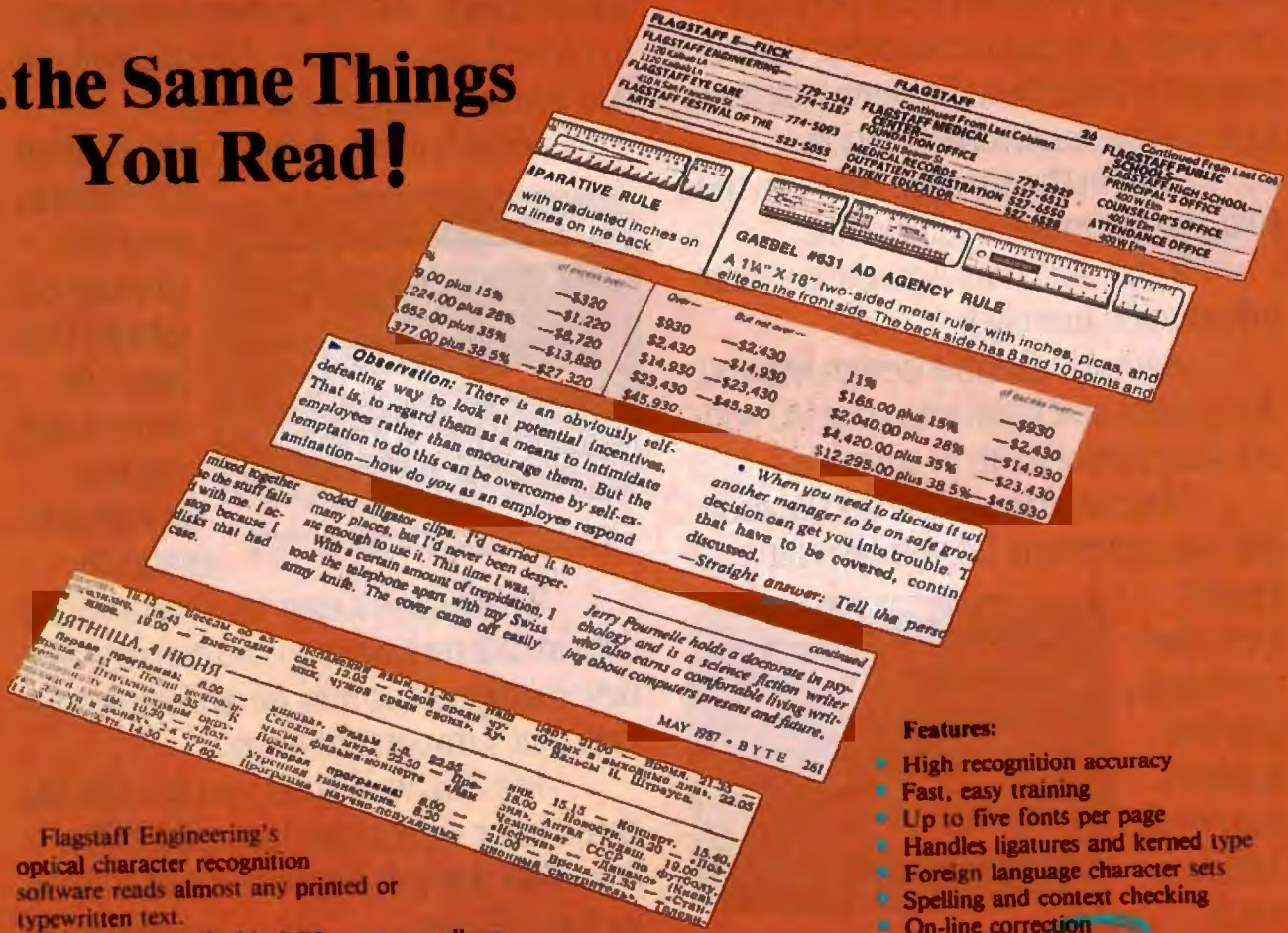

- Features:**
- High recognition accuracy
  - Fast, easy training
  - Up to five fonts per page
  - Handles ligatures and kerned type
  - Foreign language character sets
  - Spelling and context checking
  - On-line correction
  - Affordable at \$995.00

Flagstaff Engineering's optical character recognition software reads almost any printed or typewritten text.

SPOT,\* our trainable OCR program, allows you to compile information from books, magazines, typewritten records, genealogical data, directories, catalogs, and public documents, including foreign-language material. The data captured by SPOT can be used by database, word processing, desktop publishing and typesetting applications.

SPOT's flexible output options allow you to preserve the original page format, including columns and margins. Reformatting options include the choice of DCA or ASCII output files, with options to generate single-column output from multiple-column text.

Flagstaff Engineering leads the PC industry in desktop conversion systems for 9-track tape and 8-inch diskette data files. We have already supplied thousands of customers worldwide with our OCR systems. Call for the best prices on Panasonic, Hewlett-Packard, and Canon scanners. Dealer and volume discounts are available.

Flagstaff Engineering can modify the software code to meet your custom applications. For details, call us at (602)779-3341.

\*Syntactic Pattern Optical Translator



1120 Kaibab Lane • Flagstaff, AZ 86001  
 (602)779-3341 • Telex 705609 • FAX (602)779-5998  
 Circle 101 on Reader Service Card (DEALERS: 102)





# THE EDGE OF THE ENVELOPE

This month, Jerry combines his right stuff with the right hardware and the right software

**A**lthough these columns are a major activity at Chaos Manor, the real work here is writing novels, as for example *Prince of Mercenaries*, which went out the door to Jim Baen this afternoon. For that matter, there are two parts to writing the columns: the writing itself, which usually doesn't take long, and puttering around with new hardware and software so that there's something to write about, which can be quick or take forever, depending on what we're puttering with. There's a lot of stuff people want us to examine.

On that score: if you have programs you want me to look at, send them to BYTE with *my name* in the address. Include a *cover letter* that tells precisely what your program does, and why you do it better than anyone else. You'd be amazed at how much stuff we get that looks wonderful but no one can figure out what it's supposed to do. We also get a lot of what I call "yet another" programs: programs that seem to do the same things I'm already doing with something else. Sometimes the "yet another" programs turn out to be real improvements, and, of course, we're always interested in those; but often their advantages aren't at all obvious.

Given my hectic schedule, there's no way we can look at everything that comes in no matter how good it sounds; sometimes what I get to is just a matter of luck. Still, I do work at this, and a surprising amount of software does get run at least once. Realistically, I don't suppose we

can take a close look at more than about 10 percent of what comes in, but that's still quite a lot of software, and the activity consumes a lot of time.

In addition to all that, Mrs. Pournelle is writing two books while overseeing the development of her reading program. The Atari ST version of that has just finished beta testing in both public and private schools, with amazing results. All the participating kids learned to read, and the teachers are enthusiastic, since the program allows teaching assistants, volunteer parents, or even older students to act as instructors. One thing we found was that the "rewards"—pictures and music—built into the program are useful in getting the kids started; once they begin learning, the reading experience itself is enough to keep them going.

Anyway, the result of all these activities is that I always have at least three Main Machines here: the one I write on, the one Mrs. Pournelle writes on, and the experimental machine to be used for puttering around.

In fact, there are usually several more, since I like to write about stuff other than PCs. A Mac II has as prominent a place in the system as my main PC's, while an Atari Mega ST is only one step away, and there's an Amiga 2000 set up in the next room. Still, most of what we do is done on PCompatibles, if for no other reason than they're what most of the readers have, and they're far and away what most of the software I get is written for.

For the moment, the "conservative" main machine is the Zenith Z-386. At least, it was supposed to be. Alas, I got talked into using the Zenith as a testbed for Unix with the result that, of the 80 megabytes on Zanna Lee's hard disk, there's only about 30 megabytes available for DOS programs; and that's just not enough, given what I generally keep on my machines.

Of course, the notion was that I'd run DOS programs under Unix. That turned out to be a mistake. There may be a good

"DOS under Unix" system somewhere out there, but I guarantee you I don't have one, or if I do have it, the instructions on installation are beyond my ken. What I've got is a Unix that can—sometimes—run some DOS programs, provided that the DOS programs are very well behaved and I hold my mouth just right.

Of course, I can also run standard Unix programs, but why bother? All the Unix programs that do the things I want to do have been pretty small potatoes compared to what's available on DOS. Sure, Unix has unique features. If you have a real need for multiuser access to a very large database, Unix is fine. If you've simply got to have a bunch of users working off one central system, it's wonderful. There are things Unix can do that DOS wouldn't dream of. On the other hand, most Unix application programs are very vanilla in features (for example, almost no Unix program knows about color), they are overpriced, and hard to use. I've looked at a dozen or more Unix application programs, and for the kind of work I do, there aren't any that I'd prefer to what I have on DOS (and for that matter, I had better word processors and accounting programs on CP/M than the stuff Unix users put up with). Most PC users will not care to give up what they have on DOS for what they can get from Unix.

This whole situation puzzles me. I've had a dozen people try to explain why you can't simply fire up Unix and use it as the master operating system to run multiple DOS programs, and the usual answer is "You can, but nobody's done it." None of them can answer the next question.

Anyway, the result is that there wasn't enough space on the Zenith Z-386 to fit all the files from the Kaypro and still have room for everything else; so for the moment, the Zenith has become the experimental system, and the big 20-MHz

*continued*



Cheetah 386 has been put next to my chair.

### Moving the Files

The first thing we needed to do was transfer all the files from the Kaypro 386. Since I was sending them to the Cheetah, which has the Priam 330-megabyte hard disk drive, the idea was that I'd duplicate the Kaypro's C drive onto the Cheetah's E, and the Kaypro's D drive onto the Cheetah's F. That way,

I wouldn't lose any files, and I would still have my files on the Cheetah's C drive.

I had several file-transfer programs. The obvious one was Traveling Software's DeskLink, which I knew would work reliably between the Cheetah 386 and the Zenith, because I'd used it before on both machines. Unfortunately, I had trouble getting DeskLink to work with the Kaypro 386, and when I called Traveling Software, I was told that I'd probably be better off using LapLink (which

comes in the package with DeskLink anyway). If all you want to do is send files from one system to another (as opposed to running programs on one machine when they're resident on another), LapLink is faster and more convenient. Besides, they said, there's a new version of DeskLink coming out (it's now available), so I might as well wait for it.

I had a bit of trouble with LapLink, but it wasn't the program's fault. For some reason, the Kaypro 386's COM1 port didn't want to work faster than 56,000 bits per second. It's easy enough to set LapLink for the slower speed—I've yet to open the LapLink manual—and after that, things went fine. The Options command in LapLink will let you slow things to a real crawl (300 bps) if that's what it takes. Incidentally, I can remember in CP/M days when we thought 1200-bps serial-port file transfers were *fast*.

LapLink is a perfectly symmetrical program; that is, you can do all your transfers from either computer console. No need to designate one a "master" and the other a "slave." LapLink also has an option to "transfer subdirectories." This seemed wonderful, since there were a lot of subdirectories on the Kaypro. Alas, when I used the option, I found that LapLink transfers the files all right, but it doesn't create new subdirectories; what you get is one enormous directory with everything stuffed into it. This wasn't precisely what I wanted.

Next thing, then, was to do LD > LPT1:, which as most of you know tells the Norton Utilities to list directories and send that directory list out the printer port. That gave me a paper list of all the directories and subdirectories. From there, it was an easy (if tedious) job to create the Kaypro's C directory structure on the Cheetah's E drive, then go back into LapLink and fire away again.

That worked fine. Later, I found that LapLink does know how to create subdirectories; I don't know what I did wrong before. If you go into options and set the Subdirectories toggle properly—it's obvious how to do that—and get it to stay on (apparently, I hadn't), then LapLink will in fact do the whole job. Incidentally, when the Subdirectories toggle is properly set, you'll see a big S down near where it gives you the COM port and data transfer rate. Once that's done, it really will create subdirectories, unless you do whatever it was I did wrong. Traveling Software says that while LapLink works fine in conjunction with most memory-resident software, some terminate-and-stay-resident programs (TSRs)

*continued*

## Write Better Turbo 4.0 Programs... Or Your Money Back

You'll write better Turbo Pascal 4.0 programs easier and faster using the powerful analytical tools of **Turbo Analyst 4.0**.

You get • Pascal Formatter • Cross Referencer • Program Indexer • Program Lister • Execution Profiler, and more. Includes complete source code.

**Turbo Analyst 4.0** is the successor to the acclaimed TurboPower Utilities:

*"If you own Turbo Pascal you should own the Turbo Power Programmers Utilities, that's all there is to it."*

Bruce Webster, BYTE Magazine, Feb. 1986

**Turbo Analyst 4.0 is only \$75.**



## A Library of Essential Routines

**Turbo Professional 4.0** is a library of more than 400 state-of-the-art routines optimized for Turbo Pascal 4.0. It includes complete source code, comprehensive documentation, and demo

programs that are powerful and useful. Includes • TSR management • Menu, window, and data entry routines • BCD • Large arrays, and more.

**Turbo Professional 4.0 is only \$99.**

Call toll-free for credit card orders.

**1-800-538-8157 ext. 830 (1-800-672-3470 ext. 830 in CA)**

Satisfaction guaranteed or your money back within 30 days.



### Fast Response Series:

- T-DebugPLUS 4.0—Symbolic run-time debugger for Turbo 4.0, only \$45. (\$90 with source code)
- Overlay Manager 4.0—Use overlays and chain in Turbo 4.0, only \$45. Call for upgrade information.

Turbo Pascal 4.0 is required. Owners of TurboPower Utilities w/o source may upgrade for \$40, w/source, \$25. Include your serial number. For other information call 408-438-8608. Shipping & taxes prepaid in U.S. & Canada. Elsewhere add \$12 per item.

## TURBO

TurboPower Software  
P. O. Box 66747  
Scotts Valley, CA 95066-0747

# THE PROGRAMMER'S SHOP

helps save time, money, and cut frustrations. Compare, evaluate, and find products.

## Your Source for Debuggers

Embedded code, C, Asm. Whatever you write, chances are it doesn't run right the first time.

For clear windows on your code, consider these professional tools. Recover from even frozen machines, debug at high level, and keep interactivity in the debugging process.

Call one of our Tech Reps for help choosing TODAY.

Order before 9/30/88 and mention "BY988" for these Special Prices:

	List	Normal	SPECIAL
C Sprite by Latice	\$ 175	\$ 119	\$ 99
DBug III - for dBASE	\$ 196	\$ 179	\$ 159
Periscope I-incl board	\$ 455	\$ 365	\$ 355
Periscope II-incl switch	\$ 175	\$ 139	\$ 119
Periscope III-10 MHz version	\$1395	\$1159	\$1099
SoftProbe I/ITX-Rom	\$ 395	\$ 345	\$ 299
TURBOsmith-Turbo Pas	\$ 99	\$ 79	\$ 59

## 386 Development Tools

386 Assembler Linker	PC	\$ 389
386 Debug - by Phar Lap	PC	\$ 129
386-DOS Extender	PC	\$ 919
DESQview PS 2	PC	\$ 109
F77L-EM - by Lahey	MS	Call
FOXBASE+ 386	PC	\$ 419
High C - by MetaWare	PC	Call
MS Windows 386	PC	\$ 129
OS/286 & 386 by AI Architects	PC	Call
Paradox 386	MS	\$ 649
VM/386 multitasker - by IGC	PC	\$ 229

## C Language-Compilers

AZTEC C86 - Commercial	PC	\$ 499
C86 PLUS - by CI	MS	\$ 359
High C Optimizing Compiler	PC	Call
Instant C 16M	PC	Call
Latice C - V3.3	MS	\$ 259
Microsoft C 5.1 - with Codeview	MS	\$ 299
Microsoft Quick C	MS	\$ 69
NDP C 386 by MicroWay	MS	\$ 529
Turbo C by Borland	PC	\$ 67
Watcom C6.0	MS	\$ 259

## C Language-Interpreters

C-terp by Gimpel - full K & R	MS	\$ 219
C Trainer - by Catalyx	PC	\$ 89
Interactive C by IMPACC Associates	PC	\$ 189
Run/C Professional	MS	\$ 145
Run/C	MS	\$ 79
Turbo C-terp	PC	\$ 119

## C Libraries-Files

BTree ISAM - Single user	MS	\$ 99
CBTREE - Source, no royalties	MS	\$ 129
c-tree by Faircom - no royalties	MS	\$ 329
r-tree - report generation	PC	\$ 239
dB2C Files	MS	\$ 189
db_VISTA - Source	MS	Call

## C Libraries-General

Blackstar C Function Library	PC	\$ 99
C Tools Plus - V5.0	PC	\$ 99
C Utilities by Essential	PC	\$ 119
Greenleaf C Sampler	PC	\$ 69
Greenleaf C Functions	PC	\$ 129
LIGHT TOOLS by Blaise	PC	\$ 69
Turbo C Tools by Blaise	PC	\$ 99

## C-Screens, Windows, Graphics

C Display Manager by Sydtech	PC	\$ 109
C-Worthy Interface Library	PC	\$ 249
dBASE Graphics for C	PC	\$ 69
ESSENTIAL GRAPHICS - fast	PC	\$ 235
GraphiC - new color version	PC	\$ 279
Greenleaf Data Windows - incl source	PC	\$ 229
Quick Window/C	PC	\$ 75
Terminal Mapping System	PC	\$ 279
TurboWINDOW/C - for Turbo C	PC	\$ 75
VC Screen	PC	\$ 119
View Manager by Blaise	PC	\$ 199
Vitamin C source, menus	PC	\$ 159
Windows for C - fast	PC	Call
Windows for Data - validation	PC	Call

## RECENT DISCOVERY

**Turbo Power Screen** by Blaise Computing. Interactive menu-driven screen field design, keyboard reconfiguration. Intervention routines, virtual screens, range checking. Unlimited windows. Source: Turbo Pascal, MS C. QuickBASIC 4.0 PC \$ 99

## DataBase & File Management

Advanced Revelation	PC	\$ 779
CLARION - complete environment	PC	Call
DataFlex by Data Access	PC	\$ 595
Magic PC - visual database	PC	\$ 169
Paradox V2.0 List \$725	PC	\$ 499
Paradox Network Pack	PC	\$ 719
R Base for DOS	PC	\$ 549
XDB-SQL Database	MS	\$ 449

## Dbase Language

Clipper compiler	PC	\$ 389
dBASE III Plus	PC	\$ 399
dBASE III LANPack	PC	\$ 649
DBXL Interpreter by Word Tech	PC	\$ 99
FoxBASE + V2.0	MS	\$ 259
McMax by Nantucket	MAC	\$ 235
Quicksilver Diamond	PC	\$ 369

## Dbase Support

dBRIEF with BRIEF	PC	Call
DBC III by Latice	MS	\$ 169
Documentor - dFlow superset	MS	\$ 229
Genier by Bvtel code generator	MS	\$ 249
Integrated Development Library	PC	\$ 129
Networker Plus	MS	\$ 229
QuickCode III Plus	MS	\$ 189
R&R Report Writer	MS	\$ 139
Seek-It Query-by-example	PC	\$ 79
Silver Comm Library	MS	\$ 139
Tom Rettig's Library	PC	\$ 79
UI Programmer - user interfaces	PC	\$ 249

## Other Products

Back-It by Gazelle	MS	\$ 119
Baler	PC	\$ 459
CO-SESSION - remote access	PC	\$ 229
Dan Brcklin's Demo II	PC	\$ 169
Disk Technician - smart upkeep	PC	\$ 89
Fast Back Plus	PC	\$ 149
Easy Flow V5.0	PC	\$ 125
Link & Locate	MS	\$ 309
Mace Utilities	MS	\$ 85
MathCad	PC	\$ 279
MKS RCS	MS	\$ 155
PC Tools Deluxe-by Custom	PC	\$ 69
Plink 86 PLUS - overlays	MS	\$ 275
PVCS Corporate - by Polytron	PC	\$ 339
PVCS Personal	PC	\$ 135
R-DOC-X	MS	\$ 135
Seidl Version Manager	MS	\$ 269
Source Print - V3.0	PC	\$ 75
Synergy Layout	PC	\$ 139
Tree Diagrammer	PC	\$ 65
Visible Computer: 8088	PC	\$ 65
WKS Library by Raima	PC	\$ 179

## Latest dBASE Release

**dBASE IV** - features new user interface "Control Center." Multuser file record locking. "ANSI + " SQL. Query By Example. 255 field records, 99 files open. Parent-child file relations. DOS shell. PC \$ 499

**BRIEF Users:**  
**Now** you can have fast compilation AND an integrated, productive environment.

Over 5,000 of you were forced to make sacrifices to use BRIEF. The Programmer's Editor. Advanced compilers and new programming environments, like Turbo C and QuickBASIC, took up so much RAM that BRIEF could not fit in the same 640k.

If you wanted to retain BRIEF's uniquely powerful features<sup>1</sup> while working with larger programs, you had to sacrifice speed and continuity. Instead of a tight Edit-Compile-Edit loop, you had to slog through an obsolete Edit-Exit-Compile-Exit-Edit loop.

**Now you no longer have to make that sacrifice.**

You can enjoy the features<sup>1</sup> that have made BRIEF the best-selling and the best regarded<sup>2</sup> programmer's editor without sacrificing environment integration.

*Version 2.1 of BRIEF can be swapped in and out with a single keystroke — allowing immediate compilation with even the largest compilers: Microsoft C5.0, QuickC, Turbo C, Latice C, dBXL, FoxBASE+ v2.0, Clipper, etc.*

<sup>1</sup> For example: real multi-level Undo (not simply Undo/redo), flexible windowing, unlimited file size, unlimited number of simultaneous files, automatic language sensitive indentation.

<sup>2</sup> For example:

"The quintessential programmer's editor" — *Dr. Dobbs's Journal* "Right out of the box, it's a versatile, extremely powerful editor that handles most any programming task with aplomb." — *Computer Language* "Simple to learn and use and extremely sophisticated. Strongly recommended." — *PC Magazine* "Not only the best programmer's text editor I've ever seen, but it is also a *tour de force* in the way it was conceived and implemented" — *Computerworld* "So far surpasses users' expectations that it is revolutionary." — *MicroTimes Magazine* "BRIEF is truly outstanding." — *Microsoft Systems Journal*

## Current BRIEF Users:

Call Ann for details on 4 other important enhancements. Registered users of versions 2.0 or 2.01 update for only \$35.

## Haven't tried BRIEF yet?

BRIEF retails for \$195. Call Ann today for a no-risk, 60-day trial with a full, money-back guarantee.

Call toll-free today  
**800-821-2492**

**Solution  
Systems**

641 Main Street, Suite 410  
South Weymouth, MA 02190  
617-337-6963

## THE PROGRAMMER'S SHOP

Your complete source for software, services, and answers.

5-B Pond Park Road, Hingham, MA 02043  
Mass: 800-442-8070 or 617-740-2510 7 88

Call for a catalog, literature, and solid value

**800-421-8006**



# BEST BUY IN THE MARKET!

## 80286 EGA SYS w/ 20 MB HDD

- 80286-10 (10/6 MHz) ■ 640K RAM
- 1.2MB FDD ■ 200W POWER SUPPLY
- 101 KEYBOARD ■ 808287 MATH SOCKET
- W.D. CONTROLLER (2 HDD, 2 FDD)
- TURBO-SPEED BUTTON  
W/LED INDICATOR
- KEYBOARD LOCK & RESET BUTTON
- PHOENIX BIOS ■ 20 MB HDD (ST-225)
- SERIAL, PARALLEL, GAME PORT
- EGA G CARD (AUTO S/W)
- EGA MONITOR (640 x 350)
- COMPUTER CABINET DIMENSIONS  
21" L x 16.5" W x 6" H



MDL-286 DESKTOP SYS MDL-286 TOWER SYS

## TURBO-XT MONO SYS w/20MB HDD

- 8088-2 8 MHz TURBO CPU
- 640K RAM ■ 1-360K FLOPPY DISK DRIVE
- 1-20 MB HARD DISK W/CONTROLLER
- CLOCK CALENDAR W/BATTERY BACKUP
- SERIAL, PARALLEL, GAME PORT
- MONO GRAPHIC CARD
- 12" TTL AMBER MONITOR
- FRONT RESET & TURBO SWITCH
- POWER & TURBO LED INDICATOR
- 101 FULL FUNCTION ENHANCED  
KEYBOARD
- 150W POWER SUPPLY

**\$1595.**

- OPTION: ■ 12MHZ 0 WAIT STATE  
OPTION: ■ NEW COMPACT SIZE CABINET  
(DIMENSION - 14.5"W x 16"L x 7"H)

## 80386 COMPUTER SYSTEM w/40MB HDD

- 32 bit 80386-16 MHz CPU ■ 40 MB HARD DISK (ST-251 40ms)
- 1 MEG RAM (80ns) ■ 1.2 MB FLOPPY DISK DRIVE
- 200W POWER W/DESKTOP CASE
- SERIAL, PARALLEL, GAME PORT ■ 101 ENHANCED KEYBOARD
- MONO GRAPHIC CARD ■ 14" TTL AMBER MONITOR

**\$895.**

**\$2785.**



**1800-545-9777**

000 requires cash

**SUNTRONICS, INC.**  
Since 1978

HEAD OFFICE  
37803 S. CRENSHAW BLVD  
HAWTHORNE, CA 90230 M-F 9:30-5:30  
(213) 644-1140  
ORANGE CO. STORE  
100 W. BATELLA AVE. M-F 10-6  
ORANGE, CA 92667 SAT 10-5  
(714) 538-0929  
CUSTOMER SERVICE (213) 644-1100

**1 YEAR WARRANTY PARTS & LABOR ALL ITEMS IN STOCK!**

PRICES SUBJECT TO CHANGE WITHOUT NOTICE  
CALL FOR OTHER CONFIGURATIONS:

- 32 BIT 100% BULK SHIPMENTS
- FREE CREDIT 11 DAY FACTOR & BUY TOP PRODUCT AND CONTINUE SYSTEM MAY BE  
RETURNED WITHIN 30 DAYS FROM DATE OF PURCHASE FOR FULL REFUND (LESS SHIPPING CHARGE)

\*\*ITEMS RETURNED MUST BE AS-NEW WITHOUT MODIFICATION OR DAMAGE. ALL MANUALS  
AND PACKAGING MUST BE INCLUDED. RETURN SHIPPING MUST BE PREPAID AND INSURED.  
BEARING A RMA (RETURN MATERIAL AUTHORIZATION) ON THE SHIPPING LABEL.

Circle 262 on Reader Service Card

## CHAOS MANOR

can interfere with subdirectory copying. If you have a glitch, check that.

Incidentally, LapLink isn't the only program that sometimes has TSR interference with subdirectories. DOS's XCopy can also get confused.

### Alternatives

If it ain't broke don't fix it, but in the past few weeks I've received a lot of file-transfer programs, and this seemed like a good time to test them.

First I tried PC-Hooker. This is a nice little serial transfer program that works about the same as LapLink. It also has a feature that lets you create directories from within the program. There's another provision to let you see how much space is available on the target disk. There's a little text editor, and it can use the XMODEM protocols to send files out through a modem.

This is the kind of program that gives me problems: if I'd got it before I got LapLink, I'd probably have adopted it. Now I've no reason to. True, I like the Add Directory feature, but in fact LapLink loads and drops so fast that it's just about as convenient to go out and use

DOS when I need to do things like that.

Second, there's Fastwire II. This claims to be "The World's Fastest, Most Reliable Way to Exchange Information Back and Forth Between All IBM-Compatible Desktop, Laptop, and PS/2 Computers." It seemed worth a look.

Setting up Fastwire is simple. It comes with a four-headed serial cable so you can connect to either AT (9-pin) or XT (25-pin) serial ports; I wouldn't even look at a program and hardware that didn't. Fastwire also says you can use the parallel port.

My first objection to Fastwire is that, unlike LapLink and PC-Hooker, Fastwire isn't symmetrical. You run a master program on one machine, and a slave program on the other; and the only way to reverse which is which is to start over. You can't change on the fly.

Fastwire's documents claim it will automatically create subdirectories on the target machine. This sounds like a wonderful idea. When I tried Fastwire in subdirectory mode, it did, in fact, do the job; but it only created one subdirectory at a time, so I had to tell it to do it again for each one. It may be I wasn't doing

something right, because the documents clearly imply that it can make a complete backup copy from one machine to the other.

As to speed, Fastwire may be faster than LapLink; I didn't time the two programs. However, Fastwire isn't a lot faster than LapLink; not so much so that I'd give up LapLink to have it. In other words, this is another of those programs that's good enough, and had I got it first, I'd probably continue using it rather than change to something else; but it doesn't have quite enough going for it to get me to switch.

The nice thing is that there are a lot of "good enough" transfer programs. I can remember when there weren't any at all.

Incidentally, all these programs will transfer data using the parallel ports of the two machines; it's said to be marginally faster than serial. I haven't tried it, since serial ports have always worked fine for me.

### Training the Cheetah

Once we had all the files over, the next step was to configure the Cheetah. I

*continued*







wanted to use the Zenith Flat Technology Monitor (FTM), so Mrs. Pournelle could borrow the big 19-inch Electrohome monitor. When I installed the Zenith 448 video board in the Cheetah, though, the board wouldn't work. Apparently 20 MHz is too much for it.

I was in a hurry, so I put the Award EGA/VGA video board back in the Cheetah and set up the Electrohome; Mrs. Pournelle had to be satisfied with the Logitech Autosync monitor. That's no real hardship, of course; the Logitech is one of the best of the smaller EGA/VGA systems. The Zenith 448 board and FTM went back on the Zenith 16-MHz Z-386 where they'd always been. Later, I found that if I plug the Zenith FTM into the 15-pin VGA outlet on the Award video board, it works fine. Now all I have to do is carry this 70-pound, 19-inch monitor back downstairs. . . .

One thing I did find in fooling around with monitors: it's pretty easy to get them all "gaussed up." That is, if there are stray magnetic fields around, they can affect the monitor. The result looks almost as if someone had stained the monitor's glass front. There's a wild

color patch that stays in place when you scroll the display.

Most expensive monitors—such as my Electrohome—have a degaussing button; press it, and the display swims around a bit while the monitor's hardware gets rid of the unwanted magnetism that has invaded the screen. Unfortunately, neither the Zenith nor the Logitech monitors have degaussing buttons, and both of them caught bad cases of "the gaussess" while we were moving things around. (If you have a bunch of computers running outside their cases, you can expect this.)

In the past, I've always been able to remedy this problem by turning the monitor off for a minute or so, but this time it didn't seem to work. The color patches just stayed there. They weren't *that* bad; you could still make out what was supposed to be on the monitor screen. Still, it was ugly, and I wanted something done. I have no doubt that with a bit more patience, the problems would have gone away by themselves, but I was running out of time.

The remedy was the bulk eraser. This is a standard item (we got ours at Radio Shack) used to erase magnetic tapes. It

also works fine on floppy disks, which is what it's mostly used for here. The trick to using one with a disk is to turn on the eraser, move it in a spiral pattern up close to the disk (leave the disk in its protective jacket), then with the eraser still on, spiral it away again. This gets all the little magnetic molecules into a random pattern. It seemed to me that if that would work on a magnetic disk, it ought to work on a monitor screen; and in fact it did fine, although it looks a little weird while you're doing it. I was a bit astonished at just how far away you could hold the eraser and still see the effects on the screen.

The next thing was to get the Maximum Storage WORM (write once, read many times) drive and the Amdek Laserdek 2000 CD-ROM reader working together. This turned out to be simple: when you get these two machines, they are both by default addressed to ports beginning at 300 hexadecimal. You have to change the address for one of them.

The easiest to change is Maximum Storage's WORM, because the exact procedure for readdressing the WORM

*continued*

## Featuring

## Coming Soon

### MODEL 9000 (E)EPROM PROGRAMMER



- Super Fast Programming Speed!
- Quick And Intelligent Programming Algorithms.
- Programs Largest Variety Of

Chips Including Prom Replacements, Eproms, EEproms and MPUs.

Look For Valuable 1/2 Price Coupon For The Model 7228 With The Purchase Of The Model 9000.

### MODEL 9800 GANG PROGRAMMER

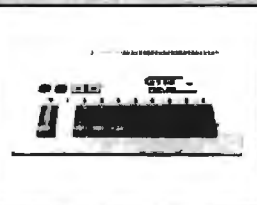

- Fastest Programmer On The Market Today!
- Quick And Intelligent Programming Algorithms.

• Supports Megabit Eproms, Prom Replacements, Eproms, EEproms And MPUs.

• Software Included FREE!

### TWO NEW PRODUCTS FROM GTEK®!

Now the PCSS-8X has intelligence with 32K to 128K Buffering. These cards are so smart they can actually be run stand alone. The PCSS-8I is for PC/XT/AT/30's and the MCSS-8I is for Model 50, 60 and 80's.

Now available is the ROMX-2XL Eprom Emulator. Emulates 2716 through 27010 (megabit) eproms.

### MODEL PCSS-8X MULTIPOINT SERIAL BOARD

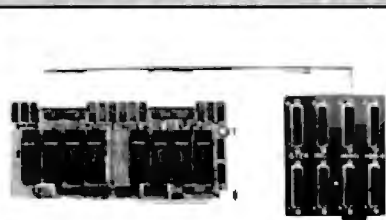

- Eight RS232 Ports Per Card (Optional 4 Port).
- All Eight Ports Capable Of Simultaneous Operation.
- Enhanced INT 14H Bios Device Driver With Interrupt Driven Receive Queues And Automatic Handshaking.
- Used In Real Time Event Driven Applications.

# GTEK®

DEVELOPMENT HARDWARE & SOFTWARE  
P. O. BOX 2310  
BAY ST. LOUIS, MS 39521-2310  
ORDER TOLL FREE 1-800-255-GTEK (4835)  
FAX: 1-801-487-0936 TELEEX 315814 (GTEK UD)  
MS & TECHNICAL SUPPORT 1-801-487-8048

PC/XT/AT is a Registered Trademark of IBM Corp.



# This is the year of the dragon. Harness its power and reap its good fortune.

It's a year that begins with a powerful array of computer systems designed, engineered, and manufactured exclusively by us...business/professional systems that proudly carry our name.

Leading the way is our new TCS 8000. Designed to harness advanced 80386 microprocessor technology, it is remarkably powerful, extremely fast and extraordinarily versatile. The TCS 8000 gives you all the strength of the MS-DOS™ concurrent DOS 386™ PC MOS 386™ and the incredible capabilities of OS/2™

The TCS 8000 is equipped with 1MB of memory, but it will easily accommodate up to 16MB on the motherboard by utilizing memory modules...standard modules that dramatically reduce the cost of expanding memory and increasing memory access speed.

As part of a network, in multi-user system, or as a stand-alone system the TCS 8000's performance proves that every detail has met Tatung's uncompromised quality controls.

Like the ancient dragon, the TCS 8000 is a symbol of power and good fortune. It will provide your customers with tremendous value, and you with superior profitability. Indeed, the exciting new TCS 8000 is destined to be a genuine "fire breather."

For complete details and specifications, call toll-free: 1-800-421-2929 Ext. 256.

The remarkable TCS 7000 AT compatible.



The TCS 4000... AT compatibility in a very small footprint.



## TATUNG

Advanced thinking is an ancient art.

Circle 275 on Reader Service Card (DEALERS: 276)



All trademarks are the property of their respective manufacturers.

Tatung Company of America, 2850 El Presidio Street, Long Beach, California 90810 (213) 979-7055



drive is clearly described in the manual. I decided to address the WORM to 200 hexadecimal; I flipped the little DIP switches as the manual told me to, and put "200" in place of "300" in the Maxsys driver instructions in the CONFIG.SYS file. I used the default installation for the Laserdek 2000. The whole thing took about 5 minutes, and now I have both CD-ROM and WORM drives.

Alas, while those will work together, by the time I've got a mouse and the CD-

ROM and WORM memory-resident drivers and DOS extensions installed to use them, I'm down to 360K bytes of system RAM. Add SideKick, and it's even smaller.

I did some experimenting with Quarterdeck's Expanded Memory Manager (QEMM); this is a program for the 80386 that, among other things, lets you get at some of the unused memory that sits between 640K bytes and 1 megabyte. You can use the QEMM LOADHI com-

mand to put the mouse software up there. Sometimes other stuff can be put there as well. If I sound vague, I intend to: it turns out that using that memory is a bit tricky. For example, if you install part of the Microsoft Bookshelf software up there and then use Procomm Plus, the communications program will lock up the machine so thoroughly that you can't even reset. Thus, I don't recommend QEMM LOADHI for the squeamish. If you do use it, test thoroughly before entrusting anything critical to your system.

# A HOLMES IN EVERY PORT



## ARRIVING AT COMM. PORT 2 The Best Laptop Modem

(John C. Dvorak — P.C. Magazine)

...At an Affordable Price. (P.C. World)

All Holmes Correspondent™ Modems are fully Hayes™ compatible. They include auto answer, auto dial, and use very little power. These features, along with a two year warranty and a complete software package make Holmes the best value available.

**HOLMES**  
MICROSYSTEMS, INC.

1-800-443-3034

**WE'VE GOT THE MODEM FOR YOUR LAPTOP!**



### Procomm Plus

Crosstalk used to drive me nuts sometimes, but I did learn to use it, and it served me pretty well on machines from an early PC XT up through the Kaypro AT, Zenith Z-248, and Zenith 386; but when I transferred it to the 20-MHz Cheetah, it wouldn't work at all.

The problem isn't the computer or the modem. The modem is the USRobotics' Courier HST, and that works fine. It's Crosstalk itself, which just seems unable to keep up with the Cheetah's speed. I'd tell Crosstalk to dial, and it would act as if it had; but the modem never got the message. Crosstalk would then tell me there was "No Connection" and offer to try again. Retries got the same result.

That left me with a problem, since I really need communications.

"Try Procomm Plus," Alex told me. It seemed like a good idea; I'd heard about Procomm for a long time. The original is shareware; now there's a Procomm Plus that's for commercial sale. We had both, or at least I thought we did. It turned out that I had at one time copied my review copy of Procomm Plus onto my hard disk, but then the manual got lost in the general swim here. I'm sure it's no more than 8 feet away from me, but for the life of me I can't find it.

That turns out not to matter. Procomm Plus has context-sensitive Help screens that do about as well as the manuals can. It takes a bit of deciphering to figure out precisely what some of the instructions mean, but in fact it took only about a half hour to get the program all set up and running.

That's when we made several discoveries. I had always run Crosstalk at no parity, 8 data bits, 1 stop bit, and that worked fine; but when we tried that with Procomm Plus, Tymnet had a fit. We could connect all right, but all we got was garbage. Eventually we changed to even parity, 7 data bits, 1 stop bit. I forget precisely what caused us to try that combination, but it works fine.

*continued*

# Mendelson Electronics Inc.

1-800-422-3525

## CONTROL YOUR HOME OR BUSINESS FROM YOUR IBM\*PC OR PC/AT COMPATIBLE

This card is what you need to TURN ON & OFF lights, machinery, and other electrical or electronic equipment.

IBM PC\* DATA ACQUISITION AND CONTROL ADAPTER & DISTRIBUTION PANEL provides the capability to control and monitor processes within a sensor base system.

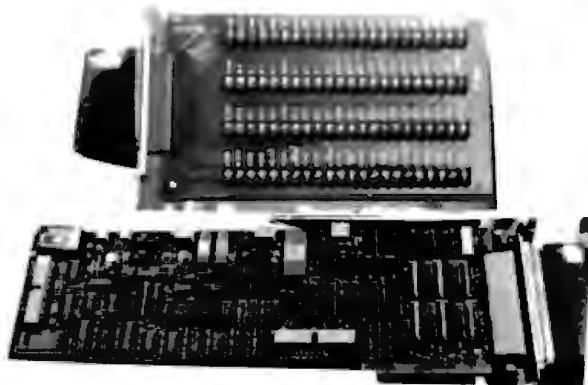

IBM PC\*DATA ACQUISITION AND CONTROL ADAPTER provides an easy to use interface for accessing the ANALOG and DIGITAL I/O. Integrates analog, binary and time/counter devices on a single adapter card.

THIS IS AN ORIGINAL IBM\* PRODUCT !!!

**Up to four IBM DATA ACQUISITION AND CONTROL ADAPTERS can be attached to an individual PC or AT Computer.**

- The Adapter has:
  - Four analog input channels (12 bit resolution)
  - Two analog output channels (12-bit resolution)
  - 16-channel digital input port
  - 16-channel digital output port
  - Programmable sampling rates provided by a 32-bit timer
  - Event counter programmable rate generator or programmable time delay provided by a 16-bit user timer counter

- The Distribution Panel has:
  - Seven terminals provided to attach devices to the distribution panel
  - Multiple grounds for twisted pair terminations
  - Shielded construction to minimize radio interference

- USES:
  - Chromatography, Electrochemistry, Energy management, Electronic testing, Process control, Data logging, Robotics
  - Some parameters commonly monitored or controlled include: Pressure, Flow, Displacement, Voltage, Light intensity, Resistance, speed

- Some instruments or devices that may utilize the Adapter are: Chromatographs, Spectrophotometers, Pressure gauges, Rate control Thermocouples, Gas analyzers, Humidity sensors, Valve actuators, Level gauges, Load cells, Conductivity cells, pH Meters

**TECHNICAL DATA**

**ANALOG INPUT** The analog input functions of the adapter operate in either programmed or interrupting mode. The analog input functions provide 12-bit relative accuracy.

RESOLUTION: 12 bits  
INPUT CHANNELS: four differential

**INPUT MODES**

unipolar or bipolar user-selectable  
**INPUT RANGES**  
unipolar 0 TO  $\pm 10$  volts user-selectable  
bipolar  $\pm 5$  and  $\pm 10$  volts user-selectable

**OUTPUT MODE**  
unipolar 0 to high binary  
bipolar offset binary  
**INPUT IMPEDANCE**  $> 100$  megohms with 100 picofarads

**INPUT CURRENT** limited to less than  $\pm 1$  mA  
**INPUT VOLTAGE**  
Normal mode  $\pm 30$  volts maximum without damage power on or power off  
Common mode  $\pm 11$  volts maximum

**COMMON MODE** Rejection ratio  
Integration linearity error  $\pm 11.5\%$  maximum

**DIFFERENTIAL Linearity**  
Error  $\pm 1.5\%$  maximum  
Stability  $\pm 5$  ppm/degrees C of FSR (max)  
**GAIN**  
Error  $\pm 0.1\%$  resolution ranges (max) any range adjustable to 0  
Stability  $\pm 32$  ppm/degrees C of FSR (max)

**OFFSET** adjustable to 0  
Unipolar stability  $\pm 24$  ppm/degrees C of FSR (max)  
Bipolar stability  $\pm 24$  ppm/degrees C of FSR (max)  
**MONOTONICITY** 0 to 50 degrees C  
**THROUGHPUT** to memory 15 000 conversions/second min

The analog output functions of the adapter operate in programmed I/O mode. The analog output functions provide 12-bit relative accuracy.

**RESOLUTION** 12 bits  
**NUMBER OF OUTPUT CHANNELS** 2  
**OUTPUT MODES** unipolar or bipolar user-selectable

**OUTPUT RANGES**  
Unipolar 0 to  $\pm 10$  volts user-selectable  
Bipolar  $\pm 5$  and  $\pm 10$  volts user-selectable  
**OUTPUT CODE**  
Unipolar straight binary  
Bipolar offset binary

**OUTPUT CURRENT**  $\pm 5$  mA typical, min with normal loading and protection from damage with the output shorted to common  
2 ppm max  
0.5 microfarads max

**OUTPUT Impedance:** CARACITIVE loading  
**GAIN**  
Error 0.1 between ranges (max) any range adjustable to 0  
Stability  $\pm 32$  ppm/degrees C of FSR (max)

**OFFSET**  
Error unipolar  $\pm 1.25$  mV offset adjustable to 0  
Error bipolar  $\pm 6$  ppm/degrees C of FSR (max)  
Unipolar stability  $\pm 24$  ppm/degrees C of FSR (max)  
Bipolar stability 0 to 50 degrees C  
**MONOTONICITY** 10 microseconds max to within 0.1% FSR for a 10 volt step with 1000 of load  
**SETTLING TIME** Preprogrammed for short to common  $\pm 1\%$  of FSR max

**PROTECTION** OVERSHOOT THROUGHPUT 25 000 conversions/second  
8 ppm memory

OUR LOW! LOW! PRICE FOR BOTH UNITS



# \$195

INCLUDES TURBO PASCAL DEMO SOFTWARE W/SOURCE CODES, ADDRESSES, ANALOG & BINARY INPUT & OUTPUT MODULES

PER SET

Shipping & Handling \$6.50

IBM\* DATA ACQUISITION AND CONTROL ADAPTER #6451502 ORIGINAL COST \$1275  
IBM\* ADAPTER DISTRIBUTION PANEL #6451504 ORIGINAL COST \$245

MENDELSON'S ADVANCED DEMO IN TURBO PASCAL AVAILABLE FOR \$25

Part No. #200-108 Demo Turbo



STORE HOURS 8:30 - 5:00 Monday thru Saturday.  
\*IBM PC/XT is a registered trademark of IBM corp.  
TERMS: MasterCard/Visa/Discover Card, Check or Money order (checks allow two weeks for clearance), C.O.D. add additional \$3.00.  
Ohio residents add 6% State Tax.  
Above shipping/handling are rates for UPS ground in Continental U.S. only  
340 East First Street Dayton, Ohio 45402  
1-800-422-3525



513/461-3525  
FAX 513/461-3391

20% Restocking Fee on Non-Defective Returns



UTAH

**COBOL™**

**NEW  
VERSION 5.0**

**\$69.95**



For IBM® PC's, XT's, AT's and other DOS machines. Needs only 1 disk drive and 128K memory. This is the one you've heard so much about - with fast compile times, small object code modules, not copy protected, no royalties, and clear error messages. Version 5.0 is based upon ANSI-74 standards with new dynamite features including:

- Nested IF's and nested conditions.
- Indexed files (ISAM) with up to 24 keys (includes START verb). This advanced feature requires the software package Btrieve® which is optionally available.
- ACCEPT (line, column) numerics with decimal point alignment, numeric

checking, AUTO-SKIP, SECURITY, LENGTH-CHECK, EMPTY-CHECK, ATTRIBUTE (color), FROM ESCAPE KEY, DAY, DATE, TIME, DAY-OF-WEEK.

• Fast memory mapped DISPLAY's (line, column) ERASE, BEEP, ATTRIBUTE (color). Can display entire screen with one DISPLAY statement

• Windowing, pop-ups, color and overlays. This advanced feature requires the software package Saywhat?™ which is optionally available.

• An easy to use, COBOL source code EDITOR with auto line numbering, A-margin, B-margin tabing with full screen cursor control.

Also available: Utah SuperSort®, a fast sort program callable from Utah COBOL; Utah FORTRAN, Utah BASIC; Utah PASCAL; Utah PILOT Used by 50,000 professionals, students and teachers in 40 countries. 30-day money back guarantee. Discover the ease and simplicity of COBOL, today!

Phone order rushed  
by UPS 2nd Day Air:  
**(702) 827-3030**



Since 1977

**Ellis Computing, Inc.**

5655 Riggins Court, Suite 10  
Reno, Nevada 89502

IBM is a registered trademark of International Business Machines, Inc. Btrieve is a registered trademark of Novell Inc. Saywhat?™ is a trademark of The Research Group. SuperSort is a registered trademark of Micropro International Corporation. Utah COBOL is a trademark of Ellis Computing, Inc. © 1987 Ellis Computing, Inc.



**Do you have PCs and a VAX?  
Then you need**

## ZSTEM TERMINAL EMULATION

The ZSTEM series includes high performance DEC, Tektronix, and DG terminal emulators featuring ZSTEM 240, ZSTEM 220, ZSTEM 100, ZSTEM 4014, and ZSTEM D400.

Take advantage of advanced features including VT340 color and resolution, file transfer, softkeys, network support and much, much more . . . all with a 30 day money-back guarantee!

Call today for details. **(800) 663-8702**

**KEA Systems Ltd.**

#412 - 2150 West Broadway

Vancouver, B.C. CANADA, V6K 4L9

Tel: 604-732-7411 Telex: 04-352848 VCR

FAX: 604-732-0715



I have since discovered what's happening. Tymnet does in fact use even parity. If you don't, and thus look at all 8 bits, that can have the effect of converting much of what's sent to you to non-ASCII characters. Crosstalk has a filter system that takes care of the situation. So does Procomm Plus, but unlike Crosstalk, Procomm Plus doesn't automatically do it; you have to go work on a conversion table.

It turns out that it's easier simply to use E-7-1 for Tymnet communications. I was a bit worried that this would prevent me from downloading binary files, but that's not true: when you go into a file-transfer protocol such as Kermit (or XMODEM, which is what I use), the system automatically switches to 8-bit transfers.

We tested that by entering BIX listings and pulling out a small COM file; it works perfectly. I've since used Procomm Plus to upload my columns. Works like a charm. I'm fast becoming attached to it, and it looks as if the change is permanent.

Incidentally, Wayne Rash reports that he's been using Procomm Plus for months now and likes it a lot. It even works from overseas.

Procomm and Procomm Plus are fundamentally alike, except that Procomm Plus is niftier. The Plus version has shadowed windows and other pretty displays. It has a nice menu system. It's also supported, whereas the older Procomm is shareware.

The best feature about Plus is the context-sensitive help, which, as I said, is good enough that I've not really needed the manuals. There are also terminal emulations, and the setup is nicer. On the other hand, the old shareware version is good enough for a lot of people. Probably the thing to do is try the shareware—it's available on BIX and elsewhere—and if you like it, go ahead and buy the Plus.

Alex swears by it. He says, "If you use a lot of different machines, this is the right program because it's portable among just about all PCompatibles." I haven't used it as long as he has, but I've seen no reason to disagree. It certainly works when you're stretching the envelope.

Recommended.

### Printer Optimizer II

A few months ago, you may remember, I had a problem with the power supply for my Applied Creative Technology Printer Optimizer. It wasn't a big problem, but the people at ACT read about it, and they

*continued*

Order Status,  
Technical & Other  
Info. (602) 246-2222  
FAX # (602) 246-7805  
Call for programs not listed



MICROSOFT PC Excel  
SPECIAL \$273

# TOLL-FREE ORDER LINE 1-800-421-3135

**NOW AVAILABLE**  
**MICROSOFT MACH 20 . . . . . \$309**  
**MICROSOFT WINDOWS 386 . . . . . \$110**  
**FREE SOFTWARE!**  
 Purchase over \$100 and receive one of these disks absolutely FREE! Purchases over \$250 get two free disks, over \$400 get three, or get all four disks when your purchase is over \$500! 1) MIXED BAG. 2) PC-WRITE. 3) FONT-SET. 4) ABC-LIST.

**- HARDWARE -**  
**Accessories**  
 Copy II PC Deluxe \$101  
 Curtis Ruby 59  
 Logical Connection 379  
 Mach III Joystick 36  
 Masterpiece 65  
 Masterpiece - 95  
 150 Watt Power Supply 69

**Hard Cards**  
 Plus 20 MB \$529  
 Plus 40 MB 659

**Hard Drives**  
 Seagate 20 MB w/cont \$265  
 Seagate 30 MB w/cont 295  
 Seagate 40 MB AT 251-2 399  
 Seagate 80 MB AT 659  
 Seagate ST-125 w/cont 329  
 Seagate ST-138 w/cont 399

**- SOFTWARE -**  
**Accounting**  
 Dac Easy Acct 3.0 Low Price  
 Dac Easy Light \$39  
 Dac Easy Payroll 39  
 Dollars & Sense 94  
 In House Acct 112  
 Managing Your Money 4.0 117

**Languages**  
 Microsoft Pascal \$176  
 Microsoft Quick Basic 4.0 59  
 Microsoft Quick C 55  
 Ryan McFarlan Fortran 390  
 Ryan McFarlan Cobol 612  
 Turbo Basic 59  
 Turbo C 1.5 59  
 Turbo Pascal 59  
 Turbo Prolog 59

**Boards**  
 AST Advantage Premium \$319  
 Rampage 286 379  
 Sxspac Plus w/64K 129  
**EVEREX**  
 2MB Above PC/XT w/o Mem 79  
 3MB Above AT w/o Mem 89  
**HERCULES**  
 Graphics Plus 179  
**INTEL**  
 Above 286 w/512K 379  
 Orchid Tiny Turbo 289

**Modems**  
 AZ 300 1200 w/o Soft \$69  
 Everax 300 1200 w/ Soft 69  
 Everax 2400 INT 199  
 Hayes 1200 EXT w/o soft 299  
 Hayes 1200B INT w/ Soft 289  
 Hayes 2400 EXT w/o Soft 435  
 Novation Parrot 1200 w/Soft 99  
 U.S. Robotics 2400 w/o Soft 335

**Communication Programs**  
 Brooklyn Bridge Universal \$75  
 Carbon Copy Plus 108  
 Crosstalk XVI 89  
 Crosstalk MK4 110  
 Flying Dutchman 64  
 PC Anywhere III 95

**Multi-User Software**  
 Fox Base v \$299  
 Microsoft Word 469  
 Word Perfect 310  
 Word Perfect Modules ea 75

**COMPUTERS**  
**EVEREX**  
 Model 1700  
 80286-10 Micro Processor  
 640K Ram, 1.2 MB disk drive,  
 101 Type Keyboard \$999  
 Model 1800  
 80286-12 Micro Processor  
 640K Ram, 1.2 MB disk drive  
 101 Type Keyboard 1349

**Mice**  
 Genus \$49  
 Logitech 68  
 Microsoft Bus w/ Paintbrush 92  
 Microsoft Serial 89  
 Optimouse w/ Dr Halo 92  
 Opti-mouse w/ DPE 185

**Data Base Managers**  
 Clipper \$370  
 Condor 3 325  
 DataPerfect Low Price 375  
 DBase III Plus 115  
 DB/XL Diamond Low Price 189  
 Fox Base Plus 2.1 435  
 Genzer 189  
 Paradox 2.0 Premium 435  
 PFS Pro File Low Price 169  
 Powerbase 169  
 Q&A 3.0 189  
 Quicksilver Diamond 329  
 Revelation Advanced 485  
 R Base For DOS 425  
 Reflex 90  
 R&R Report Writer 112  
 vP info 65

**Project Manager**  
 Microsoft Project \$305  
 Super Project Plus 255  
 Timeline 3.0 323  
 Total Harvard Man 2 355

**AT&T**  
 All Models Low Price

**Monitors**  
 AMDEK 410 Amber \$145  
 MAGNAVOX RGB 255  
 NEC GS Amber 190  
 SAMSUNG Flat Amber 82  
 TTL Amber w/tilt 76  
 Color w/tilt 249

**Desktop Publishing**  
 Pagemaker Ver 3.0 \$549  
 Page Perfect Low Price 55  
 PFS First Publisher 493  
 Ventura Publisher

**Spreadsheet**  
 Lotus 1-2-3 \$295  
 Microsoft PC Excel 273  
 Quattro 143  
 Surpass 329  
 Twin 35  
 VP Planner Plus 85

**AST 286 Premium or 386 Premium Computers**  
 RT enhanced style keyboard  
 parallel, serial and clock,  
 1.2MB floppy disk drive,  
 7 expansion slots, DOS 3.3 & Basic.  
 Available Now Best Price

**Printers**  
 CITIZEN MSP 40 \$285  
 120 D 145  
 MSP 50 385  
 EPSON LO 500 349  
 LO 850 559  
 NEC PSXLP 869  
 PS200 539  
 P2200 339  
**LASERS**  
 NEC 890 3200  
 AST TURBO PS 3199  
 OKIDATA LASERLINE 6 1299  
 OKIDATA OKI 390 499  
 OKI 391 679  
 TOSHIBA . . . . . Low Price  
 STAR MICRONICS NX 1000 180  
 NX 1000 Color 238  
 PANASONIC . . . . . Low Price

**Graphics**  
 Boeing Graphics \$200  
 Chamaster 199  
 Design Cad 2D & 3D 148  
 Diagram Master 199  
 Easy Cad 109  
 Generic Cad 49  
 In-A-Vison 270  
 Microsoft Chart 3.0 225  
 Newsroom Pro 65  
 Printshop 33

**Utilities**  
 Core Fast Low Price \$19  
 Copy II PC 38  
 Copywrite 38  
 Cubit 72  
 Deskview 2.01 49  
 Direct Access 99  
 Eureka 89  
 Fastback Plus 56  
 Formtools 55  
 Graph in the Box 2 55  
 Mace 58  
 Microsoft Windows 2.03 75  
 Norton Advanced 48  
 Norton Utilities 37  
 PC Tools Deluxe 70  
 Prokey 4.0 49  
 Q DOS II 75  
 Rightwriter 115  
 Sidelock Plus 39  
 Sideways 55  
 SQZ Plus 55  
 Superkey 79  
 Lightening 35  
 XTree

**VGA & EGA Boards**  
 ATI Ega Wonder \$175  
 Super EGA Hi Res Plus 186  
 Orchid Designer VGA 259  
 Paradise Auto 480 148  
 Paradise VGA Plus 269  
 Paradise VGA Proff 399  
 Vega VGA 275

**Integrated**  
 Ability Plus \$145  
 Enable 352  
 Microsoft Works 116  
 PFS 1st Choice 79  
 Smart System 429  
 Symphony 465

**Word Processing**  
 Microsoft Word 4.0 \$185  
 Multimate Advantage II 259  
 Q and A Write 110  
 Webster Spellcheck 37  
 Word Perfect Ver 5.0 Low Price 106  
 Word Perfect Executive 106  
 Word Perfect Library 2.0 Low Price 233  
 Wordstar Pro 194  
 Wordstar 2000 - Personal Ed

**EGA Monitors**  
 Casper \$410  
 Princeton Ultra Scan 539  
 Mitsubishi Diamond Scan 499  
 NEC - Multisync II 609  
 Zenith 14" Flat Screen 650

**TERMS:** Shipping minimum is \$5.00. AZ orders + 6.7% sales tax. Personal check, company check - allow fourteen (14) days to clear. We accept purchase orders from authorized institutions for 3-5% more than cash price. All returns are subject to our approval. There will be a 20% restock fee. All prices are subject to change. Due to copyright laws we cannot take back any open software.

TOLL-FREE ORDER LINE 1-800-421-3135  
**WAREHOUSE DATA PRODUCTS**  
 2727 West Glendale Ave. - Phoenix, AZ 85051  
 We do not guarantee compatibility

Servicing our PC buyers with low pricing and technical experience since 1979.  
 Phone Hours:  
 Monday thru Friday 8:30 a.m.-9:00 p.m. MST.  
 Saturday 9:00 a.m.-5:00 p.m. MST.



decided this would be a good time to update my Optimizer, which, after all, I've had for about 6 years now. (I've never had a problem with it, either, except for stepping on the power supply cord and breaking it.)

The Optimizer is a small computer with a lot of memory—up to a megabyte—that sits on top of the printer. It accepts inputs from any computer I have—at the moment, the Concurrent CP/M Golem, and the Cheetah, but I'm always stringing other cables over to it—and squirts the output into the HP LaserJet or the NEC Spinwriter. On the way, it can perform all kinds of transformations, such as substituting one control character for another, or initializing the LaserJet before sending it text. It can also put print jobs in a queue, and you can even interrupt the current job to send something else directly over to the printer.

The computer thinks the Optimizer is a very fast printer; now that it has a full megabyte, the Optimizer can accept a whole novel. *Prince of Mercenaries* was sent from computer to Optimizer in less than half an hour. Meanwhile, the Optimizer is pouring the text into the Laser-

Jet. The upshot was that I had my computer back in service in half an hour, and the whole novel printed in less than an hour and a half.

The Optimizer is one of those gizmos that make life easier; you can't know how much you'll like it until you get one. Highly recommended.

**Multitasking**

Once I had the Cheetah working with all his essentials—CD-ROM reader, Logitech mouse, modem and communications, WORM, 300-megabyte hard disk drive—it was time to set up my operating environment.

As I noted above, it's very easy to fill a machine with memory-resident software. The WORM and CD-ROM readers alone can darned near do it. Add SideKick and you're finished—and this in an 80386 with nearly 8 megabytes of memory! It just doesn't seem fair.

Of course, OS/2 is supposed to fix that problem, but we don't have it yet. Well, that's not quite true. We have OS/2, but since we don't have much software to run under it, it hardly matters. Incidentally, I do have Paradox for OS/2, and that

works fine. The problem is that I don't have anything else, so even though Paradox is an excellent relational database manager, I've little temptation to go to OS/2 yet.

What I do have is DESQview. That, it turns out, works very well with the 20-MHz Cheetah except for one thing: the mark-and-transfer program doesn't always work. Sometimes when I try to move a few paragraphs from one DESQview window to another, I get horrible squeals from the computer, and only part of each line is copied. I haven't the foggiest notion why. Machine's too fast for the software, I suppose.

I set up everything with DESQview, and it works; I'm writing this now in Q&A Write running under DESQview with half a dozen open windows including SideKick, SideKick Plus, Ready!, and Norton Commander. While all those were open, I went to Procomm Plus and logged in on BIX. That worked, too.

DESQview on an 80386, when coupled with Quarterdeck's QEMM, is pretty good stuff. I suppose I ought to be satisfied with it, but of course I'm not.

*continued*

# WE'VE BUILT A BETTER BROOKLYN BRIDGE WITH VERSION 2.0!



Why Is Our Bridge Better? Because The Brooklyn Bridge<sup>®</sup> that John Dvorak, *PC Magazine*, chose as "The Best of the Best Utilities,"\* now gives you more choices!

The Brooklyn Bridge Version 2.0 is more flexible than ever! We've always been the leading file transfer and access utility between IBM compatible microcomputers with any size floppy or hard disks. Now we give your customers a choice between our file manager for the novice user or DOS commands for the more experienced user.

Our new file manager lets you view both local and remote files at one time using a full-screen, dual-directory display with 1-2-3<sup>®</sup> style menus. Or, you can still transfer files and access peripherals using DOS commands at the command line, within an application, or within your current menu system.

**One Printer Can Now Work For Two People!**

In addition to our menu system, The Brooklyn Bridge lets you share printers and gives them access to other peripheral devices like tape back-up systems.

**Don't Tie Up Your Computer Sorting A Database! RUN Gives You Twice The Power!**



Our exclusive Brooklyn Bridge feature, RUN, provides for dual independent processing which lets you use both the remote and slave computers at one time.

**Our DOS Utilities Guarantee Easier DOS Processing!**

BACKUP, MOVE, REMOVE and COPY save time by allowing you to work with multiple files at one time.

BACKUP saves time by updating your disks quickly and backing up only files that have been changed or created since the last time your

disk was backed up.

MOVE lets you work twice as fast by automatically deleting the original once a file has been moved.

If confidentiality is crucial, REMOVE has a security option to insure that deleted files are unrecoverable.

Now you know we have built a better Brooklyn Bridge, while still using the fastest attainable serial transfer rate at 115,200 baud, and still saving your customers money by eliminating the expense of an additional external drive.

The Brooklyn Bridge is available through your local dealer or directly from White Crane Systems, Inc. For more information please contact White Crane at (404) 394-3119.



Just \$139.95!

WHITE CRANE SYSTEMS  
Suite 151  
6800 Peachtree Industrial Boulevard  
Norcross Georgia 30092



THE BROOKLYN BRIDGE, the White Crane Systems, Inc. logo, and WHITE CRANE SYSTEMS are trademarks of White Crane Systems, Inc. Norcross, Georgia, U.S.A. IBM is a registered trademark and PS/2 is a trademark of IBM Corporation. 1-2-3 is a registered trademark of Lotus Development Corp. Reprinted from PC Magazine, Issue 21. 1987. Copyright 1987 Ziff Communications Company.

# TRY THE NEW GENERATION FOR \$30



## KNOWLEDGEPRO

KnowledgePro uses Topics to store "chunks of knowledge." Topics can contain data, **hypertext**, procedures, calculations, rules, lists and pictures. Using a dozen simple commands, non-programmers can use topics to explain complex procedures, rules or recommendations. Using the other 100 plus commands, professional programmers can create sophisticated expert system tools and applications quickly and easily.

## HYPertext

Hypertext can be a powerful tool for organizing text, graphics and data, but without an underlying structure the user becomes lost in a maze of information. KnowledgePro adds structure, control and intelligence to create an exciting new teaching medium.

Once you've used **KnowledgePro** you'll never go back to your shell!

### Q. Who's using it?

A. Engineers, Educators, Lawyers, Scientists, Managers, Authors, Bankers, Software Developers, Expert System Developers, Computer VARs and VADs, Trainers, Consultants, Experts in Agriculture, Manufacturing, Insurance, Petroleum, Government and many many more.

### Q. What are they doing with it?

A. Intelligent tutorials, smart manuals, procedure guides, rule books, computer aided instruction, sales and promotion, data analysis, non-linear documents, text analysis, diagnostics, software front-ends, expert systems, training and education, hypertext authoring, case studies, insurance claim determination, investment analysis, intelligent forms - there seems to be no limit to the diversity of applications.

### Q. What can I do with the demo system?

A. The KnowledgePro demonstration system comes with a 100 page manual and lots of examples to get you started. You can create and save small working knowledge bases. The only commands that you can't use are those for handling external files or chaining knowledge bases. We even credit your \$30 toward the cost of the full system.

### Q. How much is the full development system?

A. KnowledgePro costs \$495 and there are no run-time charges, so you don't have to pay more when you distribute your applications. The Database Toolkit (for access to dBASE and Lotus 123 files) costs \$49 and the Graphics Toolkit (for access to PC Paintbrush pictures) costs \$89. Our KnowledgeMaker induction system (for creating rules from data) costs \$99. KnowledgePro runs on IBM PC, AT and PS/2 compatible machines with 640K memory.

**TO ORDER Call 518-766-3000** (Amex, Visa, M/C accepted) or send \$30 + \$5 shipping & handling for the demo (\$38 total foreign) or \$495 + \$8 shipping & handling for the full system (\$553 total foreign) to Knowledge Garden, Inc., 473A Malden Bridge Road, Nassau, NY 12123. In NY State please add 7% sales tax.

## KnowledgePro<sup>®</sup>

By Bev & Bill Thompson  
The first Knowledge Processor.

published  
by



In  
association  
with



KnowledgePro is a registered trademark of Knowledge Garden, Inc., Lotus 123 is a registered trademark of Lotus Development Corp., dBASE is a trademark of Ashton Tate, IBM is a registered trademark of International Business Machines Inc., KnowledgeMaker is a trademark of Knowledge Garden Inc. Photo Tcherevkoff ©

Circle 143 on Reader Service Card

SEPTEMBER 1988 • BYTE 115



The problem is window size. DESQview allows 80386 machines to make use of all that high memory by fooling DOS into thinking that each DESQview window is down there below the 640K-byte boundary; but the price is that you can't have a DESQview window much larger than 500K bytes. Actually it's worse: if I want to load all the device drivers for my Priam hard disk drive, Maximum Storage WORM, and Amdek Laserdek 2000, DESQview gets really choked up. As a practical matter, I can run the Priam all right, but if I want my other devices I have to dump DESQview and reboot.

That's hardly what I want, so I've been looking for alternatives.

The most obvious alternative is the VM/386. This is a system that allows you to run two virtual machines at the same time, each potentially as large as 640K bytes, and each with its own CONFIG.SYS file. In theory, I could attach the WORM and CD-ROM drives to one of those virtual machines, SideKick Plus in another, the CD-ROM reader (but no WORM) in yet another, and so forth. Not only would each virtual machine have 640K bytes of main memory, but I could

also assign more memory to act as enhanced expanded memory for programs that can make use of that.

In practice, I don't know: VM/386 won't work with any machine I have. The people at IGC swear this is sheer bad luck: VM/386 will work with a Zenith Z-386, even with the Z-448 video card, but it won't work with the FTM monitor. It will work with the Cheetah at 20 MHz, but it won't work with the Award video board, and for that matter, if I use VM/386, I won't have but one logical drive on my Priam hard disk drive; VM/386 doesn't know how to find the others. It will work with the Kaypro 386, but not with the Orchid EGA/PGA video board. And so forth.

All I have to do is use a plain vanilla 80386 with a standard EGA board and monitor, and I can use VM/386; or so they tell me. I suppose I'll have to try that sometime. Meanwhile, I'm still looking for a good multitasking system that works with what I have.

#### Candy Cable

The Cheetah is in a "tower" configuration, meaning that it's designed to stand

on end on the floor with the floppy disk drives at the top. This works fine in that it keeps the machine out of the way, and the airflow is better than in the standard lay-down PC.

There are some drawbacks. First, it's a little harder to get the case open. In practice, you end up sitting on the floor when working on a tower. The second problem is cables. They're almost never long enough.

The mouse cable, for example, won't reach back behind the table, up over its top, and then forward far enough for me to use the mouse. Even with the most direct route there's not enough slack. The solution is an extension cable, a regular 9-pin male-to-female.

The modem cable, which is 9-pin to 25-pin, is usually long enough, but the video cable probably won't be; for that you need another 9-pin extension, male-to-female.

The real kicker is the Amdek Laserdek 2000 cable, 37-pin male-to-male. The one that comes with the system is far too short for a tower.

When I was setting up the system, I naively assumed that all I had to do was go

# OOPS LITE. LESS FILLING. GREAT TASTE.

Object Oriented Programming (OOPS) is the most refreshing development ever to hit PC computing because it makes programming natural and easy. And if you've got a thirst for the world's best selling OOPS, get your hands on OOPS Lite, Smalltalk/V.

Thousands of scientists, engineers, programmers and educators have chosen Smalltalk/V because it's less filling. Unlike other OOPS which require deep-pocket workstations and a zillion bytes of RAM, Smalltalk/V runs on box-stock PC/XTs and clones with 512K and still has room to develop full-bodied applications.

Thousands more have chosen Smalltalk/V because it's the fastest, easiest way to get a great taste of OOPS. And that taste has led to satisfying results in everything from finance to medicine to space.

These people found that the real value of

personal computing isn't just manipulating a word processor, a spreadsheet or a modern user interface. It is using their PC as a sculptor uses clay. And Smalltalk/V with its unique design clarity, natural parallel between problem and solution, and forgiving nature gets you there with gusto.

Smalltalk/V is only \$99.95 and comes with the best object oriented programming tutorial money can buy. And when you're ready for something even more potent, move up to new Industrial Strength OOPS, Smalltalk/V 286 for just \$199.95. Both come with our 60 day money-back guarantee.

Check out Smalltalk/V at your dealer. If he doesn't have it, order toll free: 1-800-922-8255. Or write to: Digitalk, Inc., 9841 Airport Blvd., Los Angeles, CA 90045. OOPS Lite. Everything you've ever wanted in a great OOPS. For less.

## Smalltalk/V

to a local ComputerLand and get the cables I'd need. I blithely hopped into the Bronco and headed down the avenue where I'd seen, every day for a year, a ComputerLand sign at a mini-mall where there used to be a grocery store.

When I got there, I found they had a parking attendant collecting money to let you into the mini-mall. I muttered some curses and voiced the intention of never visiting *that* mall again—as indeed why would anyone when there are better shops with free parking nearby? Worse, though, when I got into the mall, I discovered that ComputerLand had been closed for weeks; they'd just never bothered to change the signs since no one seems to want to rent space in a mall that charges parking fees. (Talk about ways to discourage impulse buying!)

I went back home in a stew, and Mrs. Pournelle quite reasonably pointed out that I ought to have called first. This time I tried it: and found that in all of Los Angeles there was about one EGA video extension cable, one modem cable, and no 37-pin cables at all. Now what?

However, one ComputerLand told me that although they were out of cables, I

ought to try Candy Cable of San Diego.

It was good advice. I called and described what I needed, was given some advice about alternatives, and shortly after, I was through. They make up cables within 24 hours of the order; mine, including the unobtainable 37-pin, came by UPS two days after I phoned.

### Mapping the Future

My new novel *Prince of Mercenaries* will be published with maps. I'd intended to draw those maps on the Atari ST, but there's been some odd delay in getting an Atari laser printer. I waited as long as I could, then drew them on the Mac II.

But that's nothing new. Everyone knows you can draw maps on a Mac II.

I used MacPaint. The first map came out quite well, especially considering that the printed version will be smaller (and thus higher-resolution) than what I printed on the LaserWriter.

I could have gotten higher quality, of course, by using MacDraw. MacDraw is harder to use, since what you're doing is manipulating symbols rather than just freehand drawing, but the result is a drawing that can be output to printers

with far better resolution than the LaserWriter's 300 dots per inch. There are several commercial outfits that will take your MacDraw files and print them for you at resolutions between 1200 and 2500 dpi.

### Grammatik III

Mrs. Pournelle has been working hard on a nonfiction book. She says it's too early to say what it's about.

For most of her life she has been a teacher. For the last 15 years she was the teacher of last resort in the Los Angeles juvenile justice system: she got the kids that no one had been able to teach to read. They ranged in age from 12 to 17. Some were quite bright, too, although no one would ever suspect that of an illiterate.

During that time she didn't have to do much writing, and what little she did was short. Now she's doing a lot more: not only her book, but magazine articles on education technology. The problem is that it's hard for me to edit her work, and doubly hard for her to try it herself. Over the past year the writing has improved a lot, but it was slow progress all the same.

*continued*





No longer. She recently started using Grammatik II (and now we have a beta-test copy of Grammatik III). The program comes with Ron Bauer's "World's Shortest Writing Course."

When I first tried Grammatik, I wasn't impressed. The program tended to natter at me about things I already knew. Some of the natterings were interesting, but it didn't seem worth the effort to run everything I wrote through the program. Of course I've been writing about a million words a year for the past 20 years, too; maybe it's not surprising that a program won't do me much good.

Mrs. Pournelle, on the other hand, loved it from the first moment. Here was a program that really went through and tore up her text—worse than I'd ever done—but did it impartially and impassively. No one would ever have to see all

those comments, or even know that the machine found so many mistakes.

She's been using Grammatik III for nearly a month, and I can already see great improvement in her writing. Her book always was interesting because of the subject matter; now it has a much improved style going for it. It's been enough to make a believer out of me.

The previous version of Grammatik wasn't all that easy to use, because you had to save an ASCII copy of your file, let Grammatik play with it, then read that back into the system to edit. Grammatik III works directly with files created by most word-processing programs.

I've decided to let Grammatik have a look at my text once in a while. It can't hurt to be reminded when I overuse passive voice.

Highly recommended.

### Norton Commander Revisited

I'm not very big on straight DOS shells, those things that are supposed to make DOS easier to use. Most of them are as hard to learn as DOS, and when you're done, you don't have anything, since the next computer you encounter isn't likely to have the utility you just learned.

On the other hand, DOS is limited and can be awkward to use. This is especially true when you're trying to get a job done and run out of disk space. (That can even happen to me with my 330-mega-byte hard disk drive: I haven't filled the disk, of course, but I have overfilled the C drive partition.) When you are in a hurry, it can take forever to go through and locate expendable files to be sacrificed for more disk space.

I've generally used a shareware program called Sweep—you can get it off BIX—but the program interface is a bit sticky, and it has its limits, as I found when I had the massive job of reorganizing all the files on the Cheetah's hard disk drive. Then I remembered we had a new version of Norton Commander, and I put that up to see if it would help.

It did. Norton Commander has a lot of features, and nearly all of them are easy to learn. You can use it to cruise through disk directories—transferring and eliminating some files, looking at others, and generally getting things organized. Commander knows about hidden files and makes it easy to find and erase them if you want to. It also makes it simple to deal with read-only files. I was surprised at how quickly the work went.

Norton Commander is intended to be a sort of resident DOS shell, which you invoke on power-up and leave in place the whole time you're using your computer. I suppose you could do it that way. What I've done is set things up so that DESQview allocates 400K bytes to the Norton Commander window. That's enough memory to run nearly every DOS utility I need, including Golden Bow's Vopt (if you don't have Vopt, you ought to), and thus the Commander's window serves as an easy-to-use DOS shell. So far, I haven't had any problems with that at all, even on the fast Cheetah.

Norton Commander is one of those programs that no one really *needs*, but it is nice to have and it can save some time.

### Sprint

I'm about out of space, and I haven't had a chance to talk about Sprint, which is Borland's new editor/word processor. Sprint is loosely based on Mark of the Unicorn's Final Word, which is in turn

*continued*

## Items Discussed

### Cable ..... Prices vary

Candy Cable  
310 Via Vera Cruz, Suite 103  
San Marcos, CA 92069  
(619) 744-2291  
Inquiry 936.

### Fastwire II version 2.0

with serial or parallel cable..\$129.95  
with both cables .....\$159.95

Rupp Brothers  
P.O. Drawer J  
Lenox Hill Station  
New York, NY 10021  
(212) 517-7775  
Inquiry 937.

### Grammatik III.....\$99

Reference Software  
330 Townsend St., Suite 123  
San Francisco, CA 94107  
(415) 541-0222  
Inquiry 938.

### Norton Commander

version 1.0 .....\$75  
version 2.0 .....\$89

Peter Norton Computing, Inc.  
2210 Wilshire Blvd.  
Santa Monica, CA 90403  
(213) 453-2361  
Inquiry 939.

### PC-Hooker ..... \$59.95

Amica  
102 South Main St.  
Park Ridge, IL 60068  
(800) 888-8455  
(312) 825-0110  
Inquiry 940.

### Printer Optimizer.....\$349

Applied Creative Technology  
10529 Olympic Dr., Suite 101  
Dallas, TX 75220  
(214) 358-4800  
Inquiry 941.

### Procomm Plus.....\$75

Datastorm Technologies, Inc.  
P.O. Box 1471  
Columbia, MO 65205  
(314) 474-8461  
Inquiry 942.

### Sprint .....\$199.95

Borland International, Inc.  
1700 Greenhills Rd.  
Scotts Valley, CA 95066  
(408) 439-1060  
Inquiry 943.

### VM/386 .....\$245

IGC  
4800 Great America Pkwy.  
Santa Clara, CA 95054  
(408) 986-8373  
Inquiry 944.



CELEBRATING  
OUR  
20TH  
YEAR  
1968-1988

# MONTGOMERY GRANT

BYTE  
9 88

Retail Outlet: Penn Station, Main Concourse  
(Beneath Madison Square Garden) NYC, N.Y. 10001  
Store Hours: Mon-Fri 8:30-8/Sat-Sun 9:30-7

OUTSIDE USA---CALL  
**(718)692-0071**

FOR CUSTOMER SERVICE  
Call Mon-Fri: 9:30am-4:30pm  
(718) 692-1148

FOR ORDERS & INFORMATION CALL TOLL FREE

**1-800-759-6565**

OR WRITE TO:  
Montgomery Grant Mail Order Dept.  
P.O. Box 58 Brooklyn, NY 11230

FAX NO. 7186923372  
TELEX 422132MGRANT

OPEN 7 DAYS A WEEK FOR ORDERS: Monday-Friday 9am-7:30pm/Saturday & Sunday 9:30am-6pm (EDT)

NO SURCHARGE FOR CREDIT CARD ORDERS / WE INVITE CORPORATE & EDUCATIONAL CUSTOMERS  
CORPORATE LEASING AVAILABLE

## The LAPTOP BOX

**TOSHIBA 1000**  
• 512K RAM - 720K Floppy Drive  
4.7MHz - Super Twist LCD  
Screen



**\$729**

NEC MULTISPEED.....\$979  
NEC MULTISPEED EL.....\$1299  
NEC MULTISPEED EL II.....\$1449  
NEC MULTISPEED HD.....\$2149

TOSHIBA 1200.....\$2149  
TOSHIBA 3100/20.....\$2929  
TOSHIBA 3200.....\$3695  
TOSHIBA 5100.....\$4995

ZENITH 184 SUPERSPORTS  
W/ 2 FLOPPYS.....\$1469  
ZENITH 184-2 SUPERSPORTS  
W/ 20MB.....\$2299

SPARK by DATAVUE  
640K w/2 720K DRIVES.....\$969  
SPARK EL.....\$1149

MODEMS, EXTERNAL DRIVES &  
ACCESSORIES available for all laptops

## EPSON EPSON EQUITY 1+ Package

IBM PC/XT COMPATIBLE  
• 640K RAM w/ Clock, Calendar  
• 360K Drive - Keyboard - Serial &  
Parallel Ports - 12" High Resolu-  
tion Monitor - Box of 10 Diskettes



**\$769**

Same Pkg. w/ One Floppy  
& 20 MB Hard Drive \$1029  
Same Pkg. w/ Two 360K  
Floppy Drives \$849

## EPSON EQUITY III+ 40 MB Hard Drive Package

IBM AT Compatible  
• Keyboard - 80286 Processor  
• 640K RAM - 6.8/10 MHz - 1.2 MB  
Floppy Drive - 40 MB Hard Drive  
12" Monitor - 6 Expansion Slots  
Serial and Parallel Ports



**\$1899**

## EPSON EQUITY II- IBM AT Compatible Hard Drive Package

Keyboard - 640K RAM - 80286  
Microprocessor - 1.2 MB Floppy  
Drive - 20 MB Hard Drive - Mono  
Monitor



**\$1399**

LOGITECH MOUSE M-7 \$59.95

## IBM XT CLEARANCE



### Hard Drive Package

• IBM XT Computer - IBM Keyboard - 256K  
RAM Expandable to 640K - 360K Disk Drive  
• 20MB Hard Drive - Package of 10 Diskettes  
(Monitor Optional)

**\$1299**

IBM XT Package with  
2 360K Floppy Drives **\$1079**

## PACKARD-BELL 386 40 MB Hard Drive System

IBM AT Compatible  
• 1 MB RAM - 80386 16 MHz  
Microprocessor - 1.2 MB  
Floppy Drive - 40 MB Hard Drive  
6 Expansion Slots - Enhanced  
Keyboard - Serial & Parallel  
Ports - 12" Monitor



**\$2699**

We Can Reconfigure Any Of Our Computer Packages To Your  
Specifications. Call For Info. We Carry Modems, Drives, Cards & All Other  
Accessories For Your Computer.

## IBM PERSONAL SYSTEM 2

MODEL 30 Package  
• IBM Computer - Two 720K  
Drives - 640 K RAM - Built-In  
Graphics - Serial and Parallel  
Ports - Optional 12" Monitor



**\$1199**

PS/2 MODEL 30 with 720K  
Floppy Drive & 20MB IBM  
Hard Drive

**\$1599**

MODEL 50  
640 K RAM - 1.44MB Floppy  
Drive - 20 MB Hard Drive

**\$2599**



PS/1 Model 25.....\$1040  
PS/1 Model 25 w/ Color Monitor.....\$1290  
PS/1 Model 60 w/ 44 MB & 1.44MB Floppy.....\$2390  
PS/1 Model 60 w/ 70 MB & 1.44MB Floppy.....\$2610  
PS/1 Model 60 w/ 44 MB & 1.44MB Floppy.....\$4295  
PS/1 Model 60 w/ 70 MB & 1.44MB Floppy.....\$4695  
5.25 External Drive for PS/1.....\$29

### IBM PERSONAL SYSTEM II MONITORS

8503 Monochrome Monitor.....\$100  
8512 Color Monitor.....\$440  
8513 Color Monitor.....\$510  
IBM Printer I.....\$300

## NEC PowerMate 1

IBM PC/XT/AT COMPATIBLE  
PACKAGE  
• 800286 10 MHz Processor  
• 640K RAM - 1.2 MB Floppy Drive  
12" Monitor



**\$1249**

Same Package with NEC  
20 MB Hard Drive

Powermate II  
with Monitor

**\$1479**

**\$1679**

## COMPAQ DESKPRO 386 MODEL 40 Hard Drive Package

Keyboard - 80386 16 MHz  
Microprocessor - 1 MB RAM - 40  
MB Hard Drive - 1.2 MB Floppy  
Drive (monitor optional)



**\$4295**

## APPLE PACKAGES

APPLE IIc w/ 12"  
MONITOR.....\$529  
APPLE IIe w/ 5.25 DISK DRIVE  
& 12" MONITOR.....\$749

Apple II GS Computer - 3.5" Disk  
Drive - Apple RGB Color Monitor  
Package of 10 Diskettes - All  
Cables & Adaptors - Package of  
10 Diskettes - Apple Software

MAC PLUS Computer Package.....\$1270  
IMAGEWRITER II Printer.....\$440  
IMAGEWRITER LO.....\$1040  
MAC SE Computer w/ Dual Drive.....\$1040  
MAC SE Computer w/ 20MB APPLE  
Hard Drive.....\$2500  
APPLE MAC II.....\$2640



**\$1379**

## LEADING EDGE MODEL D Package

IBM PC/XT Compatible

512K RAM Keyboard  
4.7-7.16 MHz - 360K  
Floppy Drive 12"  
Monitor 8088-2  
Processor

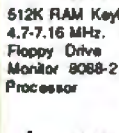

**\$629**

Same Package with  
20 MB Hard Drive **\$889**

## LEADING EDGE D2 IBM AT COMPATIBLE 20MB HARD DRIVE PKG

Keyboard 1.2MB  
Floppy 20MB Hard  
Drive 80286 Processor  
12" Mono Monitor

**\$1499**



## AMSTRAD PC1640

Keyboard 640K RAM  
Turbo Speed 1.360K Drive  
Mono Monitor Free Mouse &  
Software

**\$649**



w/ 20MB.....**\$899**

## HARD DRIVES

BEAGATE  
20MB 1/2H. w/ Controller.....IN STOCK  
30MB 1/2H. w/ Controller.....IN STOCK  
40MB 1/2H. w/ Controller.....IN STOCK

MINISCRIBE  
40MB 1/2H. w/ Controller.....\$369  
CMS 20MB Card.....\$339  
CMS 30MB Card.....\$379

## PRINTERS

EPSON  
FX-1050 \$499.95  
FX-850 \$349.95  
LO-500 \$319.95  
LO-800 \$329.95  
LO-850 \$509.95  
LO-1050 \$709.95  
LO-2500 \$849.95  
EX-800 \$419.95  
LX-800 \$199.95

PANASONIC  
1080-II \$158.95  
1092 \$299.95  
1091-II \$169.95  
KXP-1524 \$499.95

TOSHIBA  
321 5L \$449.95  
341 5L \$629.95  
351 5L \$929.95

## PRINTERS

OKIDATA  
STAR  
OXJ-120 \$189.95  
Okidata 20 \$139.95  
Okidata 160 \$219.95  
Okidata 183 \$289.95  
Dioxonx 150 \$299.95

NEC  
P-2200 \$339.95  
P-7 \$399.95

## MONITORS

THOMSON 14" CGA Monitor.....\$299  
THOMSON 17" Amber 12".....\$400  
MAGNVOX 15" RGB Color  
Monitor.....\$100  
MAGNVOX EGA Monitor.....\$130  
w/ EGA Card.....\$450  
MAGNVOX VGA Monitor - As  
w/ VGA Card.....\$480

Lasernet  
Series II **\$1629**



1 MB Expander \$340 HP DESKJET PRINTER \$710

## commodore

128 PACKAGE  
Commodore 128 Computer - Commodore 1571 Disk  
Drive - Commodore 1802 Color RGB Monitor  
• Commodore 1515 Colozin Printer **\$699**

64c PACKAGE  
Commodore 64c Computer - Commodore 1541 Disk  
Drive - Computer Printer  
• 12" Computer Monitor **\$399**

## commodore AMIGA

AMIGA 500 Computer w/  
1084 RGB Monitor **\$779**  
AMIGA 500 Computer w/ 1084  
Monitor & 1010 3.5" Floppy Drive **\$979**

ALL PERIPHERALS IN STOCK  
AMIGA 2000 IN STOCK



## VENDEX HEADSTART

10 MHz Dual Floppy Drives  
7 Expansion Slots - 512K Expandable  
to 768K - Parallel & Serial Ports  
Mouse Available in Color or Mono  
System Over \$1000 Worth of  
Software NO CHARGE!  
Mono System **\$849** Color System **\$999**



## BLUE CHIP Monitor Package

IBM PC/XT Compatible



• 512K Expandable to 640K - 360K Floppy  
Drive - 12" Monitor - Box of 10 Diskettes -  
Game Disk **\$449**  
Same Package with  
20 MB Hard Drive **\$699**

## commodore

PC10-1  
IBM PC/XT Compatible  
PACKAGE



• PC10-1 Computer - 512K RAM Ex-  
pandable to 640K - 360K Disk Drive  
Enhanced Keyboard - Serial & Parallel  
Ports - 12" Monitor - AC Adaptors - As  
Hook-up Cables - Pkg of 10 Diskettes  
**\$499**  
Same Package with  
20 MB Hard Drive **\$749**

NO ADDITIONAL SURCHARGE FOR CREDIT CARD ORDERS WE WELCOME CORPORATE & EDUCATIONAL ACCOUNTS



derived from Richard M. Stallman's EMACS, but that's all of historical interest only. Sprint isn't like any of those.

Sprint's strong point is that you can reconfigure the commands to suit yourself. The command system is contained in a table. You enter the table and find a whole series of commands: commands you might want to be able to use. Some, like Delete Line, are already bound to a command (Control-Y in this case). Others, like Delete to End of Line, are

just floating free; you can invoke them, but only by using multiple menus until you get down to where they are. Suppose, now, that you want Control-Y to mean Delete to End of Line, and Control-U to Delete Entire Line. No problem: you merely enter Control-U and Control-Y in the proper places in the table. Once you're through making changes in the table, you can tell Sprint to print out a sheet listing all the commands it currently understands.

There's a lot more to Sprint; in fact, it looks like it's got more features than the next two editors put together. Fair warning: my major experience with Sprint was at Philippe Kahn's home, and he's very enthusiastic about the program. He also uses it himself, and the entire Sprint manual—three volumes—was produced with Sprint. I was duly impressed.

When Philippe first mentioned Sprint, I told him I'd heard that it was slow. He laughed. We used LapLink to move Sprint from his Compaq to my Zenith Z-183 laptop, after which Philippe built a file about a megabyte long and I played with jumping from, say, line 120 to line 12,435. The Z-183 is a good machine, but it's not particularly fast, even for an XT. I guarantee you, Sprint isn't slow.

More when I've had more time with it, but I predict it will be a huge success.

#### Winding Down

Now I'm really out of space. The book of the month is Tom Clancy's *Cardinal of the Kremlin* from Putnam. Like all of Tom's books, you won't put this down after you start it.

The computer book of the month is Richard Maran's *HyperCard Quickstart* from Que Books. If you have any interest at all in trying to make HyperCard programs for the Macintosh, this is the book to start with; it makes clear what the HyperCard manuals make obscure.

The program of the month is Memory-Mate from Broderbund Software. All those good things my colleagues have said about this program are true. The only problem is that it's yet another memory-resident program, a new way to eat computer memory. I now have enough memory-resident programs to fill my computer five times. Maybe by next month I'll have figured out VM/386 and have five computers filled with memory-resident programs.

The game of the month is still *Dungeon Master* on the Atari ST. I've got the firestaff—now if I can just corner the evil dark lord. . . . ■

*Jerry Pournelle holds a doctorate in psychology and is a science fiction writer who also earns a comfortable living writing about computers present and future. Jerry welcomes readers' comments and opinions. Send a self-addressed, stamped envelope to Jerry Pournelle, c/o BYTE, One Phoenix Mill Lane, Peterborough, NH 03458. Please put your address on the letter as well as on the envelope. Due to the high volume of letters, Jerry cannot guarantee a personal reply. You can also contact him on BIX as "jerryip."*

# Wow! STOP

## and Compare Our Quality and Prices

### 100% IBM Compatible

#### IEEE

#### 12 MHz 286 EGA Color System

### \$1895

- Samsung 14" EGA Color Monitor
- 12 MHz PC-AT Computer, 0/1 Wait State Selectable
- AT Case with Key Lock, Turbo, Power and Hard Drive LEDs
- Enhanced Auto Switch EGA Card • Intel 80286 CPU
- Multi-speed 6/8/10/12 MHz
- Keytronics 101 Enhanced Keyboard
- 640k Memory Expandable to 1 Meg • 200 Watt Power Supply
- Seagate Model ST251 42+ Meg Hard Disk Drive
- 5 1/4" 1.2 Meg Floppy Drive
- Western Digital 2 Hard Disk & 2 Floppy Controller with Cables
- Serial / Parallel & Game Port • Complete Operations Manual
- One Year Warranty • 80287 Math Co-Processor Slot

With Monochrome / MGA + 40 Meg ..... **\$1550**

With Monochrome / MGA + 20 Meg ..... **\$1395**



#### IEEE

#### 20 MHz 386 EGA Color System

- Samsung 14" EGA Color Monitor
- 20 MHz 0 Wait State Computer
- Enhanced Auto Switch EGA Card
- AT Case with Key Lock, Turbo, Power and Hard Drive LEDs
- Intel 80386 CPU • Multi-speed 9.6/21.0/26.7 Landmark
- Keytronics 101 Enhanced Keyboard
- 1 Meg, 100ns Memory • 200 Watt Power Supply
- Seagate Model ST251 42+ Meg Hard Disk Drive
- 5 1/4" 1.2 Meg Floppy Drive
- Western Digital 2 Hard Disk and 2 Floppy Controller with Cables • Serial / Parallel & Game Ports
- Complete Operations Manual • One Year Warranty
- Math Co-Processor Socket

### \$3095

With Monochrome / MGA 12" ..... **\$2750**

#### IEEE

#### Super Turbo XT — 10 MHz

- 10 MHz PC-XT Computer
- AT Style Case with Key Lock, Turbo, Power and Hard Drive LEDs • 4.77 / 10 MHz Motherboard
- Keytronics 101 Enhanced Keyboard
- 256K Ram Snd. Expandable to 640K
- Serial / Parallel & Game Port • 150 Watt Power Supply
- 360 Floppy • Floppy Controller & Cable
- Hercules Comparable Graphics Card
- One Year Warranty • Complete Operations Manual

With 12" High Resolution Monochrome Monitor ..... **Only \$625**

With Seagate ST-225 20 Meg ..... **\$935**

To Order, Call:

# 1-214-931-3777

ieee, inc. 17120 Dallas Parkway  
Suite 212 • Dallas, Texas 75248

Terms: One year warranty (12 mo. parts / 6 mo. labor) 30 day money-back guarantee (excluding shipping charges) Visa, MasterCard, Discover (add 3% for credit cards) cash on check, money order, wire transfer, personal checks (personal checks allow 10 working days to clear) accepted. Shipping & insurance extra. Prices & availability subject to change without notice. IEEE reserves the right to substitute equivalent or better products. No COD's. 15% restocking fee on unauthorized returns. IBM XT/AT are trademarks of IBM Corp. HOURS: (Central Time) 9 a.m.-7 p.m. Mon.-Fri., 9 a.m.-5 p.m. Sat.

# An inside look at the best 386 value around.



The more you look into 386 compatibles, the more you realize that well thought-out design innovations (that really work) are few and far between.

That's why our engineers set out to design the GV-386. They realized they could unlock more of the chip's potential, if only they could speed up data retrieval, without affecting system reliability.

## INNER POWER

Here's how they did it: a high-speed RAM cache circuit—a full 64K of superfast memory—that puts your most frequently accessed data right at your fingertips. If you're ever involved in processing complex databases, long spreadsheets, or detailed engineering drawings, you'll see the value of this innovation in a second...literally.

Best of all, the cache circuit actually makes the GV-386 more reliable than other high-speed machines, by sparing integrated circuits from harsh overloading.

Our BBS is on-line 24 hours  
Call The Soft Stop at 918-252-9137

Prices subject to change

Circle 198 on Reader Service Card

## QUALITY THROUGHOUT

Of course, our most important criterion when designing our super compatible wasn't speed—it was quality. Take a look inside the GV-386 and you'll see it everywhere: from the highest quality components available to the intelligent use of special CMOS RAM to store system set-up information. On the outside, the fit and finish of the GV-386 would make Big Blue green. Even the user's manual has impressed users and reviewers alike.

We'd like to tell you more about what went into the GV-386. Give us a call and we'll give you the whole story. We'll also tell you about our exclusive 30-Day Compatibility Guarantee, our full One-Year Warranty and our toll-free support service.

The GV-386 from PC Designs. With design innovations this advanced, at this price, it's an open and shut case.

## PC Designs

Call us now at 1-800-32-BIT PC  
1 8 0 0 - 3 2 2 - 4 8 7 2 1

2500 N. Hemlock Circle, Broken Arrow, OK 74012  
• 918-251-5550 (Fax 918-251-7057)  
19 Rector Street Suite 2705 New York, NY 10006  
• 212-514-7280 (Fax 212-797-3973)

### GV-386 Specifications

- Available with 16MHz or 20MHz CPU
- Zero Wait States
- 64K Cache (keyboard enabled)
- 1MB RAM on-board, expandable to 4MB
- Socketed for 80287 or 80387
- I/O Bus runs at 8MHz for hardware compatibility
- Six 16-bit slots; Two 8-bit slots
- Price: 20MHz systems start at \$2,750; 16MHz systems as low as \$2,375



# COMPUTER DISCOUNT WAREHOUSE™



## NEC

NEC Multispeed	\$1348.84
NEC Multispeed EL	1499.76
NEC Multispeed HD w/20 Meg	2365.77
NEC Powermate 2, 40 Meg	NEW
NEC Powermate 2, 66 Meg	LOWER
NEC Powermate 386, 66 Meg	NEC
NEC Powermate 386, 130 Meg	PRICES

## LASER TURBO

XT Turbo, 512K, 1 Floppy, P/S/G, Enhanced keyboard, EMS mem.	\$889.10
XT Turbo, 1 Floppy, 20 Meg	\$989.24
XT Turbo, 1 Floppy, 40 Meg	1194.22
XT Turbo, 1 Floppy, 70 Meg	1345.75



# WHY PAY RETAIL? Nobody Sells For Less

CALL FOR LOWEST CUSTOM QUOTES

## TOSHIBA

3100 w/20 Meg	\$2998.50
1000	779.41
1200	2237.55
1200, 2 Floppy	1612.35
3200	SPECIAL BUY
5100	NEW MODEL



## SAMSUNG



S-300 4/8 MHz, 512K, 6 Slots S/P/C, Monographics board, DOS, Keyboard	\$749.50
S-300, 1 Floppy	989.95
S-300, 20 Meg	1117.82
S-300, 40 Meg	
S-500 AT Compatible 8/10 MHz, 8 Slots, S/P/C, Monographics Board, DOS, Keyboard	\$1095.45
S-500, 1.2M Floppy	1469.80
S-500, 20 Meg	1624.45

## HARDWARE, SOFTWARE & PERIPHERALS AT DISCOUNT PRICES

### COMPUTERS

MDL 70	\$1335.20	MDL 170	\$2998.36
MDL 80	1639.70	MDL 300	3498.40
MDL 90	1936.15	MDL 340	3945.65
MDL 120	2280.95	MDL 390	5589.48
MDL 140	2689.55		

IBM PS2			
MDL 30, 2 dr	\$1272.20	MDL 502, 30 Meg	\$2943.60
MDL 30, 20 Meg	1725.17	MDL 502, 60 Meg	NEW
MDL 60, 40 Meg	3349.15	MDL 70, All Models	PS2s
MDL 60, 70 Meg	3488.60	MDL 80, 40 Meg	4487.67
MDL 80, 111 Meg	5995.89	MDL 80, 70 Meg	5336.39

286, Model 1	\$1995.55	386, Model 300	\$8995.20
286, 40 Meg	2495.20	Port II, MdI 2	1896.10
286, 70 Meg	2798.20	Part II, MdI 4	2797.00
386, Model 60	5485.30	Part III, MdI 20	3495.85
386, Model 130	6845.92	Part III, MdI 40	4095.35

6300 WGS	\$1099.42
6312 WGS	1692.12
6386 WGS	3187.78

T3000, 28 Meg	\$2798.50	T1200	\$2237.98
T3200	SPECIAL BUY	T1200, 2 Floppy	1812.35
T1000	779.41	T5100	NEW MODEL

P988 (XT Turbo)	\$646.84
P988 w/1 Floppy, 20 Meg	954.80
V1200	1279.20
V1286, 12 MHz	1391.36
V1286 w/20 Meg	1573.58
V1286 w/40 Meg	1724.10
V1386	NEW MODEL

MDL 2108	\$1716.20	MDL 2214	\$1888.30
MDL 2112	1578.28	MDL 3216	2688.05

Supersport Model 2	ALL ZENITH
Supersport Model 20	MODELS
Supersport 286 Model 20	IN STOCK

Other Computers Available Upon Request

### DRIVES, TAPES & HARDWARES

1/2 height floppy drive	\$99.80
MINISCRIBE 20 Meg 1/2 height w/cont.	329.14
MINISCRIBE 30 Meg 1/2 height w/RLL	345.95
SEAGATE 20 Meg 1/2 height hard drive	243.65
SEAGATE 30 Meg 1/2 height w/RLL	308.72
SEAGATE 40 Meg 1/2 height	399.50
GENOA 60 Meg int tape	794.00/808.10
GENOA 125 Meg int tape	996.85
OMEGA 20 + 20 External 5 1/4	1795.73
IRWIN 20 MB 40 Int. External tape	398.10/538.20
MINISCRIBE 40 Meg 28ms	609.40
MINISCRIBE 80 Meg 28ms	795.45
MOUNTAIN 4440 int. ext.	378.80/557.75
PRIAM 40 Meg	669.55/777.95
PRIAM 130 Meg hard disk	1987.68
SEAGATE 30 Meg	479.80/558.90
SEAGATE 4096 80 Meg hard disk	645.10

HARDCARDS	
PLUS DEVELOPMENT 20 Meg	\$388.85
PLUS DEVELOPMENT 40 Meg	749.80
WESTERN DIGITAL 30 Meg	418.30

**MOST ORDERS SHIPPED WITHIN 48 HOURS.**

### PRINTERS

EPSON			
EX300	CALL	EX300	ALL
FX850	CDW™	FX850	EPSON
FX2864	FOR	LD850	MODELS
FX850	BEST	LD1050	IN
FX1050	PRICE	LD2400	STOCK

160P/300	DICOMINIX by Kodak	\$319.17/479.17
----------	--------------------	-----------------

IBM			
Pro Printer II	\$429.95	Quietwriter III	\$1295.82

NEC			
P560XL	\$914.75	5200	\$532.25
P2200	389.85	5300	696.47
3550	744.12	8850	1080.75
P960XL	1067.70	CALL FOR ACCESSORIES	

OKidata			
ML 1825	\$279.78	ML 320	\$346.63
ML 182P	232.50	ML 321	478.28
LASELINE 6	1288.69	ML 390	475.98
ML 282 Plus	377.11	ML 391	648.48
ML 293 Plus	516.56	ML 393	549.35
ML 294	737.18	ML 393 Color	1057.60

1000i	\$170.50	1091i	\$219.85
1092i	334.28	1592	433.44
1595	459.45	3131	274.32
3151	409.52	1524	579.10

CITIZEN			
1200	\$169.55	MSP55	\$489.66
MSP50	385.64	Premiere 36	477.17

TOSHIBA			
P321SL	\$494.85	P351-2 Color	\$1199.95
P341SL	\$347.17	P351X	1079.45

### LASER PRINTERS

H-P Laser Jet Model 2	\$1699.40
AST Turbolaser P/S	IN STOCK
H-P Desktop	689.80

NEC LC860/LC890	1982.44/3256.00
PANASONIC Laser	1695.35
TOSHIBA PageLaser	2530.20

### CHIPS

8087-2/8087-3	\$159.33/122.50
80287-6	174.30/298.50/339.25
80387-16/80387-20	497.80/777.44

### PLOTTERS, DIGITIZERS & SCANNERS

1023	\$3836.38	1043	\$6535.15
1042	7539.95	1044	10,505.06

ROLAND			
DXY-885	\$1149.79	DPX-2000	\$3464.12
DXY-990	1457.82	DPX-3300	4689.52

SUMMASCHECH			
12x12	\$376.30	12x18	\$632.50

HEWLETT PACKARD	
HP7440A	\$968.30
HP7475A	1417.44
HP7550	2926.56
HP7570	LOWEST PRICE
HP SCANJET	SAVE

FAX MACHINES & PAPER SHREDDERS			
SHARP FO-300	\$1220.10	TOSHIBA 3010	\$1314.44
SHARP FO-420	1399.95	GBC-1656	1459.80
SHARP FO-500	1599.95	GBC-1236S	915.44

### NOVELL NETWORKING

SANTA CLARA Deskless Workstation	\$648.48
----------------------------------	----------

### SOFTWARE & STARTER KITS

WESTERN DIGITAL 3 Node LAN kit w/Western Digital software	\$720.34
Entry-level 286 Starter Kit, 4 Users	489.90
Entry-level 286 Starter Kit, 8 Users	SAVE
NOVELL 286 Software w/Keycard	1569.09
NOVELL 286 Software V. 2.11	1676.34
NOVELL SFT Network Level I	2148.66
NOVELL SFT Network Level II V2.1	2757.80
Non dedicated Network Software 286 w/Keycard	1495.09

### INTERFACE CARDS

ARCNET PC110 LANboard PS2	\$539.40
ARCNET PC110 LANBoard	199.27
ARCNET PC210 LANBoard	249.50
ETHERNET Interface Connector	329.80
ETHERNET Plus Board (for 286)	709.74
G-NET Interface Card w/cable	299.52
WESTERN DIGITAL Ethernet Cards	299.10

### ACCESSORIES

ARCNET Passive Hub	\$85.00
ARCNET Active Hub	475.96
Ethernet Terminators	37.50

Novell trained and authorized sales and support. Call CDW for all new Software versions.

### MODEMS & COMMUNICATIONS

AST 5251-11 Plus	\$619.04
EVEREX 1200B/2400B	189.90/199.90
MIMA 3278/79	696.17
PACKARD BELL 2400 Int/2400 Ext	169.95/199.22

Hayes			
HAYES 1200	\$289.80	2400	\$424.68
1200B	269.20	2400B	379.65

I-Robotics			
1200B	\$108.45	2400B	\$199.70
1200 External	129.10	9600 HST	665.20

Meri-Tel			
1200 Int	\$194.50	2400 Int.	\$299.10
1200 Plus	228.88	2400 Ext.	389.44

### BATTERY BACKUP & SURGE

PERMA POWER 6 Outlet Surge Supp	\$29.40
---------------------------------	---------

TRIPPLITE			
BC-450	\$419.78	4 outlet	\$ 44.25
BC-1200	765.55	LC-1200	149.85
BC-2000	1179.80	LC-1800	173.85

### DATASHIELD

500 Watt	\$560.85	1200 Watt	\$994.75
800 Watt	638.50	6 Outlet Surge	27.85

### MISC. & ACCESSORIES

A-B Switching Box (psu or serial)	\$30.95
BASF 5 Pack of 10 DS/DD w/facet	49.00
KENNINGTON Masterpiece	99.99
KENNINGTON Masterpiece Plus	118.40
KEYTRONICS 5151 IBM or AT&T	149.95
KEYTRONICS 101	104.85
Printer Cable (IBM to Centronics) 6 ft	19.99
XT Power Supply 180 Watt	69.95

### MONITOR INTERFACE CARDS

CDW™ color card	\$ 99.00
CDW™ monographics card w/p	99.00
GENAX Spectrum (color monographic w/p)	188.75
HERCULES color card w/p	146.16
HERCULES monographics plus w/p	179.84
TAXAN MONOGRAPHIC w/p	99.88

### MONOCHROME MONITORS

AT&T Monochrome Monitor	\$189.40
AMDEK 310A/410A	119.99/149.99
AMDEK 1280	679.70
COMPAQ monochrome monitor	188.48
COMPAQ VGA Mono	193.10
IBM PS2 8503	199.95
NEC Multisync GS	184.52
NEC Monograph	1287.25
PGS MAX 12E	139.48
PACKARD BELL Green or Amber	86.95
TAXAN 123 Green/124 Amber	119.50/124.85

### COLOR GRAPHIC MONITORS

AMDEK color 600T/722	\$348.24/444.49
IBM PS2 8512 Color	438.40
IBM PS2 8513 Enhanced Color	458.20
SAMSUNG RGB Color	248.60
PGS HX-12 Plus	417.15
TAXAN 650T/720	489.90/299.80
MAGNAVOX 8762	259.95

### VGA & EGA PRODUCTS

VGA & EGA MONITORS	
COMPAQ VGA monitor	\$548.58
MAGNAVOX 943DEGA	387.40
MITSUBISHI Diamond Scan	522.20
NEC Multisync II PLUS	609.76/880.10
NEC Multisync XL 19 inch	1974.48
PACKARD BELL VGA Monitor	389.95
PGS Ultrasync	515.33
SONY Multiscan 1300/1302	599.45/849.25
TAXAN 770 PLUS	499.40
ZENITH Z-1490	750.31

### VGA DISPLAY CARDS

ATI VGA VIP	\$289.24
GENOVA VGA	289.70
PARADISE VGA	287.68
ORCHID VGA	278.14
VIDEO-7 VGA	299.15

### EGA DISPLAY CARDS

ATI Wonder Card	\$199.80
GENOVA Super EGA Hi-Res 600 x 800	234.40
NEC MVA 1024	968.50
NEC GB-1 640x480	238.43
PARADISE Auto Switch EGA 480	168.85
VIDEO 7 Vega Deluxe	249.74

### CAD MONITORS & CARDS

MITSUBISHI 6905, 19 inch	\$2295.95
MITSUBISHI 6922, 19 inch	1374.80
HITACHI 4119, 19 inch	2310.65
CONTROL SYSTEMS ARTIST 1016	1582.20
VERMONT Cobra	1077.75
METHEUS 1104	948.65

### MICE

LOGITECH HiRez	\$99.95
LOGITECH C7/Bus	89.96/109.96
LOGITECH Logimouse C7 w/publisher	124.85
MICROSOFT Mouse (Bus Version)	119.34
MICROSOFT Mouse (Serial Version)	131.28
MOUSE SYSTEMS (Serial Version)	99.55
MOUSE SYSTEMS (Bus Version)	108.77
MOUSE SYSTEMS Omnimouse	59.70

## WHY WAIT? CALL COMPUTER DISCOUNT WAREHOUSE™ NOW!

Open terms available to approved credit

# (800) 233-4426

In Illinois FAX (312) 498-1426 (312) 291-1737

2730 Anthony Trail, Northbrook, IL 60062 FAX-A-BID (3





# A WOLF AND A KILLER SHARK

After moving to Hollywood, our columnist pits Word against FullWrite Professional

A few months ago, I moved from San Francisco to the Greater Los Angeles Sprawl. Why? Well, I've always had a secret yearning to become a matinee idol, and I figured that if there was room in Hollywood for Howard the Duck and ALF—good-natured, odd-looking, tactless extraterrestrials to whom friends tell me I bear a striking resemblance—there was room for me.

The process of moving was a major nightmare; I'm still living in a landscape of unopened, mislabeled boxes. There were, of course, the usual computer headaches. Since I save the original cartons when I buy components (a practice I heartily recommend), packing was effortless and everything made the trip with no physical damage.

However, sometime during the process, the lithium battery in my Tandon IBM PC AT clone gave up the ghost. This is the little devil that keeps the parameter RAM alive; when it passed away, the Tandon forgot everything it had known about system configuration. To make things worse, the computer is equipped with some setup routines in ROM, one of which lets you select a hard disk drive option from among 32 choices. This meant that the machine knew there was some sort of fixed drive attached (I could hear it power up, and the little light flickered appropriately), but it didn't know enough to actually read the disk.

So I hauled out the Yellow Pages and began calling some computer stores that looked big enough to handle lithium bat-

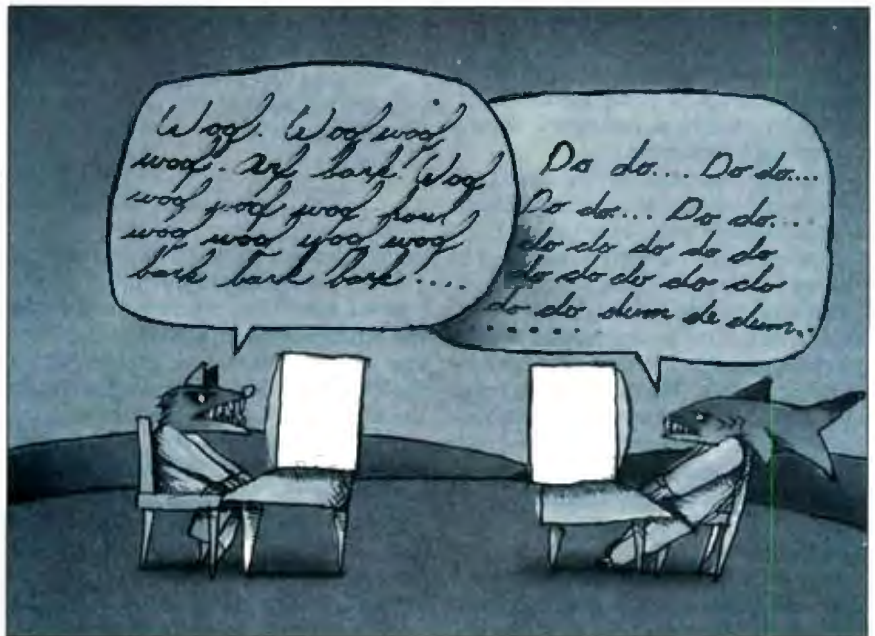

teries. I figured I was in for a rough time because the Tandon's battery was rated at 3.6 volts as opposed to the 6.8-V unit in IBM machines, but this turned out to be immaterial—nobody had any batteries of either sort.

Half a dozen places told me they didn't have anything like what I was describing. One technician dimly recalled some lithium batteries a long time ago, but he knew his store had stopped stocking them. Three outfits told me to call Radio Shack, which I did—to no avail. I called two computer supply firms, which sold paper, disks, cables, daisy wheels, and similar stuff; they had no batteries. Two more computer stores gave me the names of the largest electronics supply houses in the region, which carried batteries but not the one I needed. However, one of the electronics stores told me about a company called Battery Specialties in Long Beach. I called; they had the battery; victory was within my grasp.

The following afternoon, I drove out

to deepest Long Beach, near the border with Orange County, and picked up two batteries (to be safe). Round-trip mileage: 78 miles. Total elapsed time for the mission: 3½ hours. This is a big city.

Got home, plugged one in, and the Tandon came to life. Neither it nor I knew the specs for the hard disk drive, though. I spent several hours trying to figure out which option to select by trial and error. I knew the disk was a 40-megabyte job, but was it actually 40, 42, 44, or a fractional variation? How many heads did I have (on my hard disk drive, that is)? How many cylinders? No luck. The drive itself, of course, had no identifying label, and the documentation was written to cover all possibilities. Ouch.

The next morning, I called a friend with an identical machine and learned that I had a type 25 drive. I selected that option, and I was in business until I discovered that the drive had been wiped clean. I don't know how this happened,

*continued*



but I was able to reformat successfully and begin rebuilding my system. And to this day, I believe with all my heart that I will, someday, locate the packing box that contains my backup floppies.

Why am I telling you all this? Two reasons. First, I'd like to warn you to start building a collection of spare parts for your computer(s), and to make some notes on paper of little things like system configuration parameters. This can happen to you.

Second, I would like to express extreme annoyance to any representatives of the computer industry who read this column. I wasted three days on all this. The L.A. region is one of the nation's largest markets for computer equipment, and I came close to giving up and using mail order, which, in retrospect, should have been my first move.

The fact that none of the dealers I called could help me is appalling. Luckily, I'm the sort who doesn't mind poking around inside computers, but what if I weren't? I'm pretty sure I would have been forced to turn the Tandon over to a service shop, pay an outrageous hourly minimum, and lose the use of the machine for a week. That's just not acceptable. Until the industry as a whole figures out how to cope with situations like this, personal computers will continue to be seen by many users as a menace.

### Head to Head

Let me start off this comparison of Word 3.01 (Microsoft, \$395) and FullWrite Professional (Ashton-Tate, \$395) by declaring flatly that I probably wouldn't use either package on a regular basis. That's not to say they're bad programs, but they're not suited for what I do.

I grind out text, which I usually transmit electronically, either via BIX or MCI Mail. Sometimes I write letters. Occasionally, I need a fancier layout, so I pump my text into PageMaker. When I want to generate an outline, I use More or the variant of Acta that uses the More command set. I rarely need headers or footers, and when I do, they're simple one-line affairs. I do not have to generate tables of contents, indexes, bibliographies, footnotes, or end notes. I'm perfectly happy to be writing this column using Microsoft Works (with the addition of WorksPlus Spell and WorksPlus Command from Lundeen & Associates).

If those programs didn't exist, I'd be content to use WriteNow, the excellent word processor from T/Maker, or MacWrite 5.0 from Claris, an improved descendant of the original Mac editor. I suspect my habits parallel those of many,

## Items Discussed

FullWrite Professional .....\$395  
Ashton-Tate  
2101 Hamilton Ave.  
Torrance, CA 90502  
(213) 329-8000  
Inquiry 934.

Word 3.01 .....\$395  
Microsoft  
16011 Northeast 36th Way  
P.O. Box 97017  
Redmond, WA 98073  
(206) 882-8080  
(800) 426-9400  
Inquiry 935.

many computer users, but be warned that I don't fit the mythical mold of the "power user." For my own work, I take the utilitarian route, and I reject the notion of insurance buying, that is, getting the largest number of features possible on the off chance that I'll need one of them someday. When the blue moon rises, thank you, I'll invest in new software.

Further, the hardware and operating-system people tell us that multitasking is just about with us at last on popular microcomputers like the Mac and the IBM PC. If that is true, it would suggest another reason to go for simplicity. Surely, the model of multitasking we'll have in the next few years will let us bolt simple, effective tools into our systems only as we need them. Why burden yourself with ungainly software monsters?

This may seem like a digression, but understanding your text-handling needs is critical to determining whether you should even bother with Word or FullWrite Professional. In many ways, both programs represent the same kitchen-sink philosophy; it's up to you to determine if you need a word processor with running water and a garbage disposal. Both packages push the concept of word processing into the area of heavy-duty desktop publishing; you've got to decide if you'd rather purchase two separate programs, or take the reverse route instead and go for a layout program that incorporates word processing, like Quark XPress or Ready-Set-Go!. Some concentrated soul-searching and a long session of needs analysis are in order here.

On to the analysis. I burned myself badly with a column about Word 3.0 in

January 1987. I wrote an embarrassingly exuberant preview of the product, noting that I hoped the bugs I encountered in my beta-test edition would be squelched by the time the program was released for general consumption. When the product shipped with bugs intact, the only thing that saved me was that I had noted the unfinished nature of the software in the column. True, Microsoft fixed the flaws and sent its customers free updates, but the features that had impressed me became more and more cumbersome as I used the program. Sadder and much wiser, I retreated into Works, which has always been adequate and has never crashed on me.

As a result, I was edgy about evaluating FullWrite Professional. Rather than attempting to play with a prerelease version, I waited until Ashton-Tate shipped shrink-wrapped copies to its dealers. The first two copies I received, a month apart, had unreadable program disks. The support disks were fine, which led me to be suspicious of Ashton-Tate's quality control. And within the first week of testing, I had three ominous crashes (the cursor simply froze in place) for which I had no explanation.

Since then, I've been unable to duplicate the crashes, and I have not been able to pinpoint any specific problem areas. Maybe I have been witnessing an evil synergy between FullWrite Professional and my Radius accelerator card; that seems unlikely, but you never know.

The next warning sign was FullWrite Professional's appetite for memory. It is sold for 1-megabyte machines, but it really requires more. If you have a 1-megabyte Mac Plus or SE, be prepared to strip your system file to a bare minimum, heaving desk accessories and fonts willy-nilly, if you want to have enough memory to make the program do its thing. For this reason alone, I wouldn't recommend it to anyone with less than a 2-megabyte system, which cuts out a majority of Macintosh owners. Not good.

But let's assume you've got a loaded Mac with memory to spare, and that the crashes I've experienced are unique to my system and its idiosyncrasies. How do the two programs stack up?

FullWrite Professional has some decided advantages over Word. Editable display of multiple columns is much more convenient than the back-and-forth jumps to get into Word's page-preview mode; if you regularly produce short two- or three-column documents, FullWrite Professional is the winner. Selecting items to be flagged as index en-

*continued*

INTRODUCTORY PRICE

**\$99.95**

Regular price \$149.95.



WALTER BRIGHT – Programmer

“This is a revolutionary product which reflects the fact that Walter Bright is one of the world’s best programmers.”

*Andy Redfern, Personal Computer World*

“I find it amazing that Walter continues to find ways to improve his already excellent product.”

*Scott Robert Ladd, Micro Cornucopia*



# C is great! C++ is better!!

Performance benchmarks

Benchmark	Zortech C	Zortech C++	Turbo C 1.5	Quick C 1.0
Sieve	20.49	<b>20.54</b>	23.62	22.72
Rsieve	20.49	<b>20.54</b>	23.62	22.03
Integer	1.32	<b>1.38</b>	6.31	6.49
Float	0.17	<b>0.22</b>	52.29	51.03
*Float	32.73	<b>37.74</b>	52.39	51.63
Pointer	17.91	<b>17.96</b>	17.13	16.87
Rpointer	17.79	<b>17.91</b>	17.14	16.64
Loop	3.90	<b>3.90</b>	3.90	3.90
Optimize	0.49	<b>0.60</b>	8.46	8.79

Benchmarks were run on an 80286 based IBM compatible at 6MHz with no 8087.

\*The float benchmark was re-run without optimization.

Zortech C++ is the first native-code C++ compiler for MS-DOS compatible machines. This means you don't need to spend a lot of money on a C compiler. In fact, Zortech C++ comes with a C++ compiler, a C compiler, a linker, a librarian, a fully integrated editing environment, context sensitive help and the fastest graphics library you've ever seen!

With Zortech C++, you can mix and match code in C++, C and assembler and link them all together with a single command!

Zortech C++ comes with a complete C++ and C library, including compatibility with the ANSI C draft. Unique to Zortech C++ is support for mice, fast screen writes, re-entrant floating point and speaker support.

Now you can move your Microsoft and Turbo C code over to Zortech C++ – we've included compatible library functions! Also, we have made Zortech C++ compatible with Microsoft's Codeview debugger!

Enter the world of Object Oriented Programming (oops) with Zortech C++!

Sure, C is great – but C++ is better!

Circle 300 on Reader Service Card



YES!  
Rush me  
C++ as shown  
below:

Zortech C++  
\$99.95\*

C++ Book  
\$29.95\*

Intro C++ Book  
\$27.95\*

VISA/MC/COD CHECK ACCEPTED

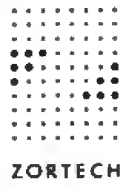

Name \_\_\_\_\_

Address \_\_\_\_\_

Phone \_\_\_\_\_

VISA or MC# \_\_\_\_\_

Exp. date \_\_\_\_\_

To: ZORTECH INC. 366 Massachusetts Ave., Arlington, MA 02174. Tel: 617-646-6703. Fax: 617-643-7969.

**CALL THE ORDER HOTLINE 1-800-848-8408**

\*Prices do not include shipping



# You'll never have to wait for a mainframe again.



Microsoft just eliminated a 3000-pound headache for mainframe programmers. With Microsoft® COBOL Optimizing Compiler 3.0.

Now instead of endlessly waiting for mainframe time, you can bring your COBOL programs right down to the PC on your desk. Suddenly you've got control unknown in other platforms, as well as serious speed and power.

You've got full MS® OS/2 support to let you break the 640K memory barrier.

You've got fast execution because Microsoft COBOL is now a native code compiler.

You've got a rich development environment thanks to the Microsoft COBOL Animator source level debugger, Microsoft Editor and other powerful utilities.

One final assurance. Because Microsoft COBOL 3.0 is now mainframe COBOL compatible, you'll enjoy a seamless flow of source code between mainframe and PC environments.

Feel free to also enjoy the highly technical information in the adjacent column. Then call us at 800-541-1261 for more information and the dealer nearest you.

The mainframe wait is over with Microsoft COBOL 3.0. Appearing soon on a PC near you.



**Microsoft®**

## Microsoft COBOL Optimizing Compiler Version 3.0 for MS OS/2 and MS-DOS\*

### Complete COBOL Solution for Application Maintenance and Development on the PC.

- Develop and port large mainframe applications on the PC
- Break the 640K barrier with OS/2 support including dynamic link libraries and multi-thread support. NEW!
- Develop programs that run in both MS-DOS and OS/2. NEW!
- Compatible with several different COBOL dialects. (IBM® VS COBOL II,™ IBM OS/VS™ COBOL, IBM SAA, Data General, and others.)
- Call Microsoft C and Macro Assembler routines. NEW!
- HUGE memory model allows data items to be greater than 64K. NEW!
- Full network support with record and file locking including Novell. NEW!

### Powerful COBOL Development Environment

- Animator source level debugger. NEW!  
Trace execution, backtracking, breakpoint DO statements, and periodic breakpoints.
- Microsoft Editor, the programmer's editor for both MS OS/2 and MS-DOS. NEW!  
Reconfigurable and extendable editor that even lets you run your programs from within it.
- Incremental linker for MS OS/2 performs partial links up to 20 times faster than a full link—only changed modules are relinked. NEW!

### ANSI 85 COBOL support. NEW!

- Certified HIGH by National Bureau of Standards.
- Structured language enhancements:  
Scope delimiters  
In-line PERFORM statement  
CALL BY CONTENT statement  
EVALUATE statement  
Negated conditions  
Global variables  
Reference modifications  
Nested programs

### Native Code compiler with fast execution. NEW!

- 10x faster computations than MS COBOL 2.2.
- 30% faster I/O than MS COBOL 2.2

tries, footnotes, end notes, and so on by clicking icons on an "icon bar" is much more reasonable than resorting to the arcane WordStar-like system of embedding control symbols that Word uses, although figuring out FullWrite Professional's icons takes some doing.

The addition of marginal notes (called "posted notes"—obviously a steal from 3M's trademarked Post-it Notes) is a plus when editing if you don't want to rip up the original; whether or not you call it "hypertext," it's handy. Likewise, editors will appreciate the visible "change bars" along the edge of your text that indicate revisions since the last version. And FullWrite Professional's system of dividing "documents" into "chapters" sucked into RAM is a nifty, easily understandable method of defining virtual memory techniques in word processing.

In day-to-day use, the two programs come up equal in spelling checking and glossary capability, although FullWrite Professional has a few more tricks than Word, including "variables," drop-in placeholders for text that is frequently redefined. The outlines are different, but neither of them approaches the ease of More, so I'd call it a dead heat. Ditto for file import/export, help screens, and many other features. Both come with excellent documentation.

FullWrite Professional will wrap text around an irregular graphic, but this is a novelty for anyone but the most passionate tinkerer. And you can't just slide a graphic as you can with Word; you have to create an independent sidebar in order to position it. FullWrite Professional is more precise, but Word is easier.

Style sheets can be defined and named with both programs, but Word lets you chain styles into a running format with a smoothness lacking in FullWrite Professional. Longer documents flow without conscious effort. More points for Word.

But to me, the most important area of distinction is that of "feel." Word takes great pains to mask its power; it's very easy to ignore those functions not germane to the task at hand. FullWrite Professional feels more like a big program; you always have the sense that there are menus and submenus and sub-submenus lurking beneath every operation. And FullWrite Professional's extensive use of sidebars, windows, and cryptic icons adds to the impression of complexity. Word can do fancy stuff, too, but it comes across as a wolf in sheep's clothing, while FullWrite Professional is a killer shark of a program.

Overall, I have to give the nod to Word as the better program for a larger number

of people, if only because of the memory required to run FullWrite Professional. I also like its feel. However, although FullWrite Professional at this stage in its development is alarmingly fragile and a memory hog, it's better designed for the person with tough word-processing needs. You pick which you prefer.

But returning to software philosophy for a moment, remember, these are both programs that seem best-suited to those who want to live their lives inside their word processors. Although the accompanying manuals make light of this, both take a lot of time to learn thoroughly. To tap the industrial-strength aspects, you'll have to plow through the documentation and devote hours to experimentation. I don't really like this approach. I find it much more comforting to have several programs, each good at specific functions, than one big program that claims total flexibility. The counterargument is that it's easier to have to learn only one environment. I leave it to you to declare which camp you're in.

### You Saw It Here First

Back in April 1984, BYTE ran a special What's New section that parodied high-technology product introductions, and I wrote a couple of items. The first heralded two new computer languages, ORTHFAY (which combined postfix notation and pig latin to produce code so elegant it was incomprehensible immediately after it was written) and LIMP (an artificial-intelligence language that forgot what it was doing and crashed if the word *Eratosthenes* was even mentioned in the room with it).

The other item was entitled "Looking for Mr. Dos." It detailed a nonexistent operating system from a company called Marginal Research, hence MR-DOS. All good clean silliness.

Now, Apple Computer has entered the picture by announcing that it's building a new operating system called "Multitasking Realtime DOS" or "MR-DOS." Sound familiar? You betcha.

At present, I'm wondering if I could sue Apple for "look and feel," or at least a bit of copyright infringement. After all, it seems the thing to do these days. ■

*Ezra Shapiro is a consulting editor for BYTE. You can contact him on BIX as "ezra." Because of the volume of mail he receives, Ezra, regretfully, cannot respond to each inquiry.*

*Your questions and comments are welcome. Write to: Editor, BYTE, One Phoenix Mill Lane, Peterborough, NH 03458.*



# Make your programs millions of times smarter.

More and more, programmers and workstation builders are using DESQview 2.0 as a development tool. The reason is simple. They can create powerful, multitasking solutions today for the millions of DOS PCs in use today. Solutions comparable to those promised for tomorrow by OS/2.

## The API Advantage

Programmers who take advantage of DESQview's API (Application Program Interface) get access to the powerful capabilities built into DESQview—multitasking, windowing, intertask communications, mailboxes, shared programs, memory management, mousing, data transfer, menu-building and context sensitive help.

## Bells and Whistles

A program taking advantage of the DESQview 2.0 API can spawn subtasks for performing background operations or new processes for loading and running other programs concurrently. It can schedule processing after an interval or at a certain time. It can use DESQview's intertask communications to rapidly exchange data between programs, share common code and data; or interrupt at critical events. It can use DESQview's menuing and mousing capabilities to create menus. And there's lots more it can do.

Some of the applications under development right now using DESQview 2.0 API Tools: CAD, Medical systems, insurance, 3270 mainframe communications, network management, real estate, typesetting, point of sale, education, commodity trading, stock trading and online voting.

## 80386 Power

80386 programmers can take advantage of the 80386's protected mode for large programs, yet run on DOS and multitask in DESQview—side by side with other 80386 and DOS programs. The breakthroughs that make this possible: DOS Extenders from PharLap Software and AI Architects and DESQview support of these DOS extenders.

## DESQview Developer Conference

So if you are a developer, looking to create programs with mainframe capabilities, but wanting to sell into the existing base of millions of DOS PCs, come to Quarterdeck's first DESQview API Developers Conference, August 16-18, 1988 at the Marina Beach Hotel, in Marina del Rey, California. For more information call or write us.

Come learn about the DESQview 2.0 API and 80386 DOS Extenders. Meet 80386 experts as well as those smart people who are creating DESQview 2.0 API workstations solutions.

And if you want to get a leg up before the conference, ask us about the DESQview API Tools for assembler or C programmers.

# Bringing New Power to DOS. DESQview 2.0 API Toolkit.

The logo for Quarterdeck, featuring the word "Quarterdeck" in a bold, red, sans-serif font. To the left of the text is a stylized graphic consisting of several parallel, slanted lines of varying lengths, creating a sense of motion or a deck of cards.

Quarterdeck Office Systems 150 Pico Blvd., Santa Monica, CA 90405  
(213) 392 9851





# IS MORE ALWAYS BETTER?

Too often we opt for the pricey solutions because they feel good, but they may not even solve the problem

**I**t was enough to bring visions of yuppies talking in acronyms, just like in those controversial Wang commercials on radio and TV. The Wang salesman explained to me just how he had convinced his customer to abandon the idea of a small, microcomputer-based local-area network (LAN) and instead buy a Wang VS minicomputer. I knew that the customer had only minimal office automation requirements and was planning to do a lot of database work using a LAN with a Structured Query Language (SQL) server. The Wang salesman was quite proud of the way he had overcome the customer's objections to the sale.

In effect, the Wang VS would replace an IBM PC AT-compatible machine at over 10 times the cost. To complicate matters, there was no indication the Wang-based network would work with the SQL database server.

The customer convinced himself to go with the Wang VS partly out of emotional reasons. His DP managers were comfortable with the brand and knew little about microcomputer-based LANs. What's more, the customer knew that a LAN looked good on paper, but since he knew little about LANs, he wasn't in a position to reassure his managers.

The result, of course, was a familiar scenario. The customer really needed a network and he got one, with the Wang VS acting as the file server. But because the work required of the file server was minimal, the VS spent most of its time idling. At last check, the SQL database

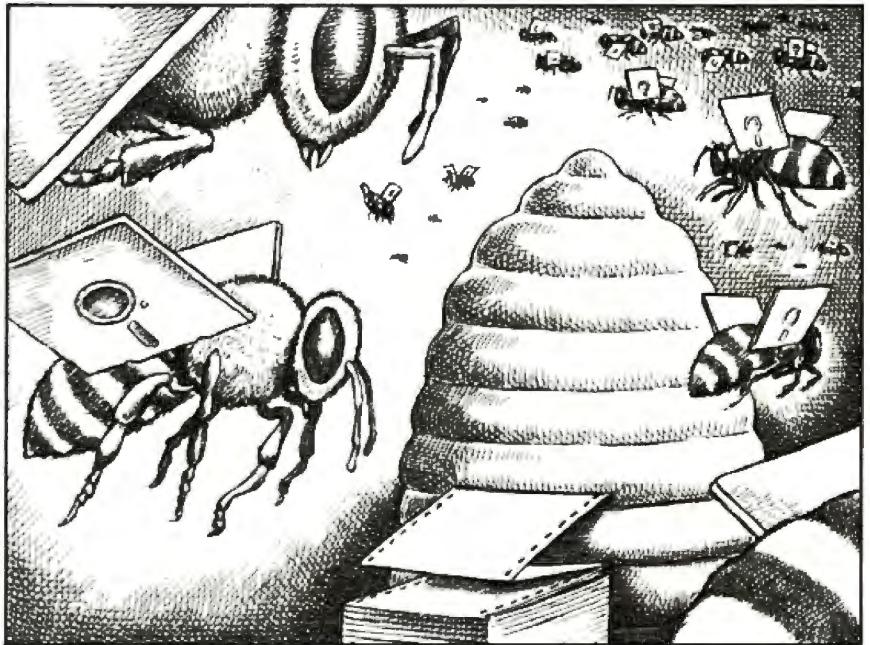

server still wouldn't work with that setup and the customer never got his database, even though the database was the primary reason he needed a network.

## Finding Another Way

Although it's a pricey substitute for a PC AT, the Wang VS is a nice departmental system. I'm really not picking on Wang or on Wang's hardware. The problem is that many installations are made on the basis of comfort rather than functionality. Choices made the easy way happen for a variety of reasons, some of which are impossible to solve.

Still, most companies really would rather not pay for solutions that feel good but don't solve the problem. The difficulty is finding the alternative. While emotional decisions played a part in the selection of the Wang system, there were other factors involved.

The customer planned to eventually install several similar networks in areas where he now used Wang word process-

ing on Wang Professional Computers. These computers connected to the current word-processing system with Wang's Local Interconnect Option (LIO) wiring. The DP managers didn't want to scrap the Wang computers or rewire their offices. Thus, the decision was more than just a question of comfort; to them, it made good technical sense.

Had more research been done, however, the customer would have discovered that there was another answer. For example, the network wiring is compatible with ARCnet hardware. If he had found a way to have the Wang computers use some industry-standard network software, he could have used most of his installation, as is, for a microcomputer-based LAN, at a fraction of the cost of buying one based on a Wang VS.

## Magna to the Rescue

The Wang Professional Computer, as it turns out, will support Novell NetWare

*continued*



# Spot the Top Dot.

Epson® LQ-2700

Toshiba P331SA

ACCEL-500

AMT Accel-500™

And we'll ship it to you FREE for 30 days.

The bad news is, this is a quiz. The good news is, we're going to make it easy.

All three of these 24-pin dot matrix printers are versatile, rugged office-quality printers. They all provide a variety of type styles and compatibility with most popular software. But there's only one Top Dot. And all the clues you need to find it are right here in this ad.

Top Dot's high performance features include combined letter-

quality text and graphics, color printing, and a sizzling 480 cps draft speed.



Select-Dial puts total printer control at your fingertips.

A unique Select-Dial™ feature gives Top Dot effortless, fingertip control. And plug-in Intelli-Cards™ provide instant software upgrades.

Top Dot's \$985\* price is a remarkable \$500 below comparable printers. Even more remarkably, it includes toll-free hotline support, a 2-year warranty, an unheard-of full year of on-site service, and a Quick-Start kit packed with \$150 worth of supplies, software, documentation and more.



And only Top Dot is available in your choice of finish: Executive Black or traditional Ivory.

You have to visit a dealer to buy two of the printers on this page. But you can get Top Dot delivered to your door by UPS.\*

Just call 1-800-637-7878, correctly identify the Top Dot, and

## COMPARISON CHART

	AMT Accel-500	Epson IQ-2500	Toshiba P351SX
Print speed (12cps)			
Draft Mode	480 cps	324 cps	300 cps
Memo Mode	200 cps	N/A	N/A
LQ Mode	80 cps	90 cps	100 cps
Plug-in fonts	card	card	cartridge
Color printing	standard	N/A	optional†
Warranty	24 mo	18 mo	18 mo
On-site service	1 yr	N/A	N/A
Price	\$985	\$1449††	\$1499††
Starter Kit	standard	N/A	N/A

†\$239 †† manufacturer's suggested list price

we'll ship it to you. FREE\*\* If after 30 days, the Top Dot hasn't become indispensable to your office, just send it back. Otherwise, do nothing. We'll charge \$985 to your credit card or bill you against your purchase order. That's all there is to it.

And if you're still not sure of the answer, don't worry. Our operators will give you three chances to get it right.



Quick-Start Kit contains supplies, cable, software, documentation—even transparency materials. A \$150 value FREE with Top Dot.

# ACCEL-500™

## 1-800-637-7878



Ventura Peripherals, 100 Rancho Road, Suite 27  
Thousand Oaks, California 91362

\*Special introductory price.

\*\* Offer subject to availability and credit approval.

just fine, if you add a small adapter card to the LIO network card in the machine. Wang's LIO is really ARCnet, so once you've installed this card, you can use your machine on a microcomputer-based network. Because most Wang Professional Computers come with IBM PC-compatibility options, they will run PC software.

The adapter card, from Magna Computer, is on the pricey side, but it's cheaper than buying a new computer and a network card, and you can use all that cable. Once you install Magna's adapter card, you can use the Wang Professional Computer on a Novell network just as if it were an IBM PC.

Once you eliminate the side issues, such as what to do with all your old workstations and old cable, then you get down to the real issues, such as the fact that many DP managers simply aren't used to the idea of microcomputers replacing minicomputer and mainframe systems. They'll waste a mainframe on microcomputer tasks, simply because they haven't seen a micro handle such an application before. There are a couple of ways you can overcome this problem.

The easiest way is to set up a prototype. It's pretty hard to argue with an operational system that is functioning well. In some cases, especially if the mainframe application was designed for a single user (and many were), you can simply move the source code over to the microcomputer and recompile it. Of course, you have to be prepared to handle non-standard extensions, and you'll find some really old COBOL systems quite bizarre due to the many patches that have been made over the years.

When you can't recompile—and sometimes you can't—you can design the same functions (and the same feel) into the microcomputer version. The results can be quite impressive, because if you design the prototype right, you can improve response time, a situation that will impress the users.

If you can't do a prototype, you can often find equivalent software for the microcomputer. Sometimes you can find the same software, since there is some cross-fertilization between computer types. Often, because each user has a dedicated CPU, equivalent software for a microcomputer or a microcomputer-based LAN is better and faster than what was being used on the mainframe.

### Sometimes More Is Better

Certainly using the Wang VS (or a VAX, or an IBM 9370, for that matter) as a file server is not always a bad idea. If you

## Items Discussed

**Lap-Link Mac**.....\$139.95  
Traveling Software, Inc.  
18702 North Creek Pkwy.  
Bothell, WA 98011  
(206) 483-8088  
**Inquiry 965.**

**LIO adapter card**.....\$595  
Magna Computer Co.  
24 Keewaydin Dr.  
Salem, NH 03079  
(603) 898-3555  
**Inquiry 966.**

**Z-1000**..... Price not yet announced  
Zenith Data Systems  
1000 Milwaukee Ave.  
Glenview, IL 60025  
(312) 699-4848  
**Inquiry 967.**

have a lot of users, and if you have the support staff to handle a minicomputer like the Wang, it might make sense.

A good example of this would be an office automation environment with a heavy word-processing load and the need to communicate with a couple of mainframes. Naturally, for success in an environment such as that, you need to select the right file servers and gateways. Microcomputer users may face a quandary in such a situation. As systems get bigger and harder to manage, the freedom and flexibility that come with the use of small computers begin to disappear because individual users can no longer manage them. Once again, the DP manager starts controlling the system.

You've probably seen the AT&T television ads about this trend. They feature two executives, one of whom is equipping his office with stand-alone microcomputers. He's being intimidated by another executive, who tells him in a very nasty scene, "Stop blowing your budget" on personal computers and hook all your users to a central system. This is one view of workgroup computing, although AT&T has the perverse idea that the intimidator is the forward thinker in the scene.

As is indicated by the growth of network installations, there are some good reasons to connect users. Sharing of

*continued*



scarce resources (such as laser printers) and communication with other users in the outside world are two of those reasons. The problem comes when department managers have to decide whether the users should control their own work, or the tasks should be handled centrally.

**The Zenith Z-1000**

One reason the workgroup issue often seems so fuzzy is that the line between microcomputers and minicomputers has

blurred and almost disappeared. Part of this is due to machines like Zenith's latest, the Z-1000.

The Z-1000 is aimed squarely at the workgroup market. It is a machine that starts at about \$20,000, contains as many as five 80386 microprocessors, has a dual bus, runs Unix, and supports as many as 64 users. Zenith says it's a microcomputer.

Clearly, the Z-1000 is based on microcomputer technology. One of its two

buses is a standard PC AT bus. You can plug standard PC cards into it. The other bus was designed at MIT by the same people who developed the NuBus used by some minicomputers and the Mac II. This bus is for the processors only, but it is similar to some proprietary minicomputer buses.

Whether you call it a mini, a micro, or something else, the Z-1000 is designed for user-supported workgroup computing. Zenith says it developed the machine for use in the average office. While it's too bulky to fit on a desk, it fits beside a desk very nicely. The machine supports users with terminals, or it works with a LAN as a node or as the file server.

*California*  
**FREWARE**



ONLY \$2.99 per disk ONLY \$2.99 per disk ONLY \$2.99 per disk

Public Domain and Shareware for IBM™ and Compatibles, DOS™ 2.1 or higher.  
Programs and utilities to meet all your computing needs.

**BUSINESS**

- **EZ-FORMS Rev. D15 (66)** - Menu driven forms generator.
- **PRO PC-ACCT V3.0 (326)** - Integrated G/L, A/R & A/P.
- **REAL ESTATE ANALYST (83)** - Menu driven.
- **EXPRESS CHECK V2.14 (861)** - Checkbook program.
- **BILLPOWER V3.0 (861)** - Time & billing. Hard drive req.
- **LANDLORD V2.01 (885)** - Fast & friendly rental property mgmt. Hard drive required.
- **FINANCE MANAGER V4.0 (77)** - Accounting package.
- **PDS QUOTE V3.14 (873)** - Prepare quotes for projects.
- **BOAR V1.92 (449 & 450)** - (2 disk set) A/R program.

**COMMUNICATIONS**

- **WILDCAT BBS V1.03 (371 & 372)** - (2 disk set) Bulletin board system. Best yet.
- **PROCOMM V2.42 (53 & 54)** - (2 disk set) Menu driven.
- **MODEM V3.1 (293 & 294)** - (2 disk set) Modem program.
- **PC-TALK III (466)** - Modem program. Buttonware.

**DATABASE**

- **FILE EXPRESS V4.14 (33 & 34)** - (2 disk set) Menu driven.
- **WAMPUM V3.1B (37 & 38)** - (2 disk set) dBase III clone.
- **PC-FILE + V2.0 (493 - 495)** - (3 disk set) Buttonware. Great

**EDUCATION**

- **COMPONER (3)** - Create, save, edit, play, & print.
- **LETTERFALL V1.1 (119)** - Improve your touch typing.
- **THE WORLD 3D (127)** - Display maps. CGA required.
- **FUNNELS & BUCKETS V2.0 (130)** - Great math game. 5-10.
- **ERTN'S ABC'S (131)** - Basic required. Ages 2 - 6.
- **ALGEBRA TUTOR V1.01 (377)** - Teaches various operations of algebra. Keeps score.

- **POLYGLOT V6.01 (139)** - Vocabulary. Grades 7 - college.

**GAMES**

- **ADVENTURE GAME TOOLKIT (505 & 506)** - (2 disk set) Create & play your own games.
- **BLACKJACK (95)** - Advanced blackjack game.
- **MONOPOLY V6.7 (108)** - Just like board game. CGA req.
- **DUNGEONS & DRAGONS V1.1 (208)** - Can you survive?
- **3D CHESS V1.01 (215)** - Excellent chess game.
- **SUPER PINBALL (212)** - 5 different games. CGA required.
- **WORDPLAY (367)** - Wheel of Fortune clone. CGA req.
- **DIG LEAGUE BASEBALL (344)** - Pick your team. CGA req.
- **MINIATURE GOLF (506)** - 18 hole golf course. CGA req.

**GRAPHICS**

- **FINGERPAINT V2.0 (282)** - Paint program; 6 font. 81 sizes.
- **CITY DESK V6.0 (197)** - Desktop publisher.
- **PRINTMASTER GRAPHICS/2 (548)** - Over 150 graphics. Requires Printmaster Plus.
- **PRINTSHOP GRAPHICS/2 (589)** - Over 150 graphics. Requires Printshop.
- **BARCODE V2.1 (593)** - Print barcodes from your data. Easy.

**NOVELTIES**

- **EDNA'S COOKBOOK V1.16 (566)** - Recipe mgr; 2 drives req.
- **VEHICLE RECORD SYSTEM (567)** - Track auto expenses.
- **WEIGHT CONTROL (586)** - Get rid of unwanted weight.
- **WISDOM OF THE AGES (544 - 547)** - (4 disk set) Almanac.

**PRINTER UTILITIES**

- **LQ V2.1 (509)** - Produces high quality text on dot matrix.
- **ONSIDE (560)** - Sideways printing program. Epson print.

**SPREADSHEET**

- **PC CALC + V 1.0 (537-539)** - (3 disk set) - Spreadsheet prog.
- **LOTUS LEARNING SYSTEM (456)** - Beginning tutor for Lotus.
- **AS EASY AS V3.0 (302)** - Lotus 123 clone.

**UTILITIES**

- **DOS HELP (255)** - Help screen for DOS. For DOS 3.XX.
- **DOS TUTORIAL V4.2 (256)** -
- **VACCINE (541)** - Fight against 'virus' & 'trojan horse's.
- **AUTOMENU V4.01 (290)** - Access programs, batch files.

**WORD PROCESSING**

- **WORDPERFECT MACROS (189)** - Over 80. WP v5.0 req.
- **PC-WRITE V2.71 (9 & 10)** - (2 disk set) Full featured.
- **PC TYPE + (373 - 375)** - (3 disk set) A word processor.
- **LEGAL FORMS & LETTERS (911)** - A must for all. Over 100 forms. WP needed to modify.

NAME \_\_\_\_\_  
ADDRESS \_\_\_\_\_  
CITY \_\_\_\_\_ ST \_\_\_\_\_ ZIP \_\_\_\_\_  
TELEPHONE (\_\_\_\_) \_\_\_\_\_

# of 5.25" disks \* @ \$2.99 = \_\_\_\_\_  
Calif. Res. Sales Tax (6.5%) = \_\_\_\_\_  
Shipping & Handling = 1.00  
Orders shipped UPS Ground  
TOTAL = \$ \_\_\_\_\_  
\*2 disk sets are 2 @ \$2.99 etc.  
International orders \$10.00 for shipping & handling. All payments in US dollars

Send order & check or money order to:

**California FREWARE**  
1468 Springline Dr. Dept A  
Palmdale, CA 93550  
(805) 273-0300

Call or write for free catalog containing over 600 disks of quality software.  
Hours: M-F 9am - 5pm PST  
3.5" media - \$3.99 ea.  
All COD orders placed before 1pm PST sent same day.  
Sorry, no Credit Card Orders.  
BYTE888

**Moving the Info**

The concept of workgroup computing implies that information can be shared among the group's users. For example, if you have a spreadsheet and a text file, you should be able to send them to another user for inclusion in a document. The concept of personal computing, on the other hand, implies that you have the computer that's best suited for your specific job.

The problem is, there are certain jobs you can do better with an IBM compatible and others that you can handle better with a Mac. These machines are not compatible. How do you fit them both into a workgroup? With difficulty. At least, until recently, that was the case.

Now, there are ways. Apple has announced an Ethernet card for the Mac II; there's the AppleTalk board for the IBM (which will help some); there's TOPS (Transparent Operating System), a LAN operating system that connects Macs, IBMs, and Sun workstations; and there's Lap-Link.

Lap-Link? You thought that was for moving stuff from your laptop to your personal computer, right? Well, it is, but there's also a version that does file transfers between PCs and Macs. For more detailed information, see the text box "Exchanging Data" in the *Macintosh Special Edition*, August BYTE, page 62. I'll report on Mac-to-PC networks as I get a chance to look at them. ■

*Wayne Rash Jr. is a member of the professional staff of American Management Systems, Inc. (Arlington, Virginia), where he consults with the federal government on microcomputers. You can reach him on BIX as "waynerash."*

*Your questions and comments are welcome. Write to: Editor, BYTE, One Phoenix Mill Lane, Peterborough, NH 03458.*

# We've Invented the Future of Instrumentation Software . . . Twice.

With Words

With Pictures

## Acquisition

Integrated libraries for GPIB, RS-232, A/D-D/A-DIO plug-in cards, and modular instruments.



Intuitive character-based function panels that automatically generate source code.

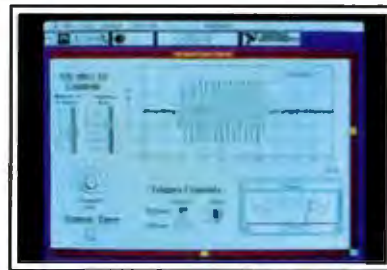

Front panel user interface with virtual instrument block diagram programming.

## Analysis

Extensive libraries for data reduction, digital signal processing, and statistical analysis.

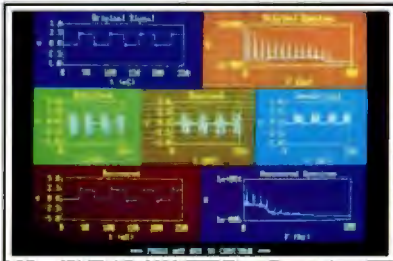

Over 100 analysis functions plus all the built-in functions of your language.



Over 250 icons for computation and analysis.

## Presentation

Flexible high-performance graphics and report generation.

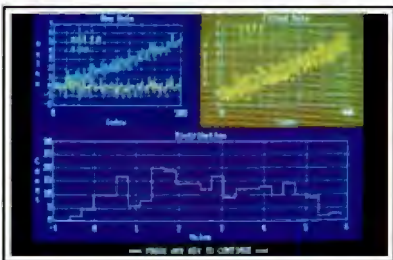

Extensive graphics support for CGA, EGA, MCGA, VGA, and Hercules.



Macintosh Desktop Publishing compatibility.

*The Software is the Instrument*

**LabWindows™**—  
for the DOS-based PC and PS/2,  
with Microsoft QuickBASIC or C.



12109 Technology Boulevard  
Austin, Texas 78727-6204  
800/531-4742 512/250-9119

**LabVIEW®**—  
for the Apple Macintosh





## Why build a printer that can print standing on its head when all you want is outstanding letter quality?

The answer is better quality printing.

We made our new 300 Series 24-pin printers more rugged than they have to be and more reliable than ever. We built in a patented optical sensor and linked it with a unique rack and pinion printhead drive.

So you get more accurate printhead positioning. And that means outstanding letter quality.

All in a printer so stable it works upside down.

**But even right side up, you get letter quality printing this good.**

Our engineers call this "championship specs." More than 3 million loyal users call it rugged reliability. And it shows in the quality and performance of every printer and modem we make.

Call 1-800-OKIDATA for the dealer nearest you.

Circle 193 on Reader Service Card

OKIDATA is a registered trademark of Oki America, Inc.  
Marque déposée de Oki America, Inc.

**OKIDATA**<sup>®</sup>  
an OKI AMERICA company

We put business on paper.



# COMEBACKS, BACKUPS, AND UPDATES

Some Macintosh software is born great, some is made great, and some is merely updated

If you're a savvy Macintosh user who has also fiddled with IBM PCs, you've probably come to respect the window/icon/mouse interface inherent in all Macintosh software. DESQview and Microsoft Windows notwithstanding, you simply can't navigate around the directories of a PC the way you can on a Mac.

Unfortunately, for a number of us, special applications are often available only on the PC. For example, the number of third-party applications that have been written using dBASE III Plus (and earlier variants) is staggering. Until recently, inveterate MacFolk like myself were locked out of that market.

About a year ago, Nantucket Software improved the situation by rescuing an obscure West German program called dMacIII from the waste bin of bad programs. The program could run dBASE III code on a Mac and read the dBASE database files that you had moved from a PC. But it didn't follow the Mac interface; its documentation had been badly translated from the original German; and its U.S. distributor was weak, to be charitable.

Nantucket bought the rights to dMac-III, cleaned it up, renamed it McMax, fixed the bad bugs, improved the documentation to mediocre, and put it on the market for \$295. Its two virtues were its speed and dBASE compatibility. But unless you happened to be a dBASE guru, it was pretty tough to figure out how to program McMax to create new applications.

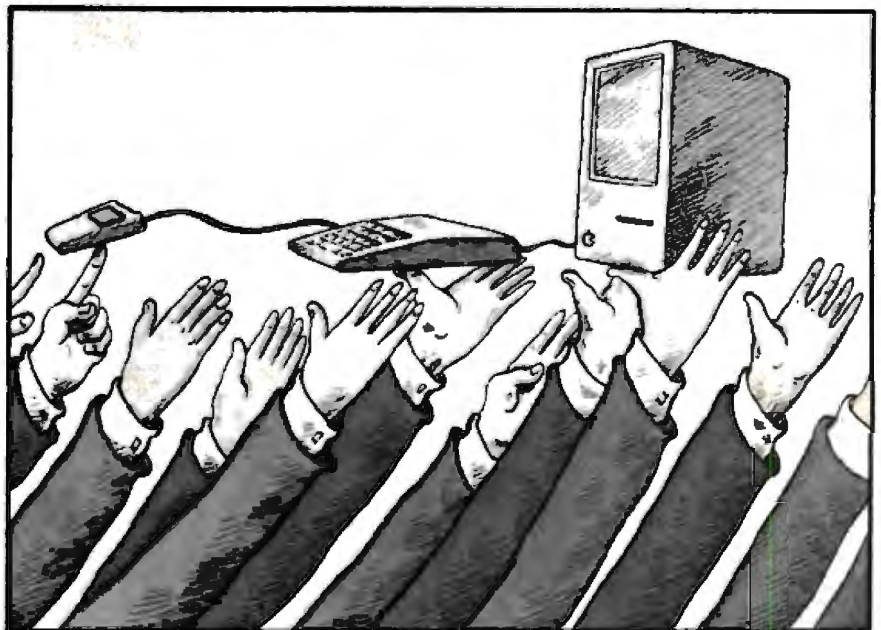

## Using FoxBASE +/Mac

Fox Software, the FoxBASE + people of PC and dBASE III Plus clone fame, have a much better idea, as I briefly reported last month: FoxBASE +/Mac. This program has all the dBASE compatibility of McMax and more, since it also handles report-definition and label-definition files, memory-variable files, and other file types created by dBASE III Plus.

I was a beta tester for FoxBASE +/Mac, and I've worked with the release version (1.0) since the end of April. I'm not a FoxBASE cheerleader, but the company did a lot of things right with the product.

FoxBASE +/Mac is not a quick port of the PC version. It combines its dBASE compatibility with a strong list of features and a work environment with which Mac users will feel comfortable. FoxBASE +/Mac provides multiple window support on any Mac.

The program supports a picture data type (PICT), so you can cut and paste

graphics into your applications. It also supports multiple typefaces, type sizes, and type styles in any combination you desire, so there's no limit on the aesthetics of your application. On a Mac II, FoxBASE +/Mac gives you color, and it will print reports in color on an Imagewriter II or an HP PaintJet.

You can build input forms for your application using all the Mac I/O tools you're used to: radio buttons, check boxes, pop-up menus, pull-down menus, and editable text fields. FoxBASE +/Mac also includes the standard dBASE I/O tools, such as input validation. Its method of setting up file relationships is similar to that of 4th Dimension and dBASE Mac. Novice database programmers will find it a cinch to use.

FoxBASE +/Mac lacks some of the features found in competing Macintosh relational databases, especially such a features giant as 4th Dimension. For example, FoxBASE +/Mac doesn't have

*continued*



the built-in business graphics or fancy graphics forms editor of 4th Dimension, and it also lacks 4th Dimension's host language interface, so you can't write external functions or procedures in Pascal or C and use them with your FoxBASE application. Multiuser and run-time versions are also not yet available. The program also lacks a full-blown report generator, à la 4th Dimension. For a version 1.0 release, though, FoxBASE+/Mac is surprisingly complete and well done. It's also remarkably fast, as in, "You mean it's finished indexing all those records already?"

The one fly in the FoxBASE+/Mac ointment is the demo version. The application includes two serial number validation keys that you use to install it. One key installs the complete version, and the other key creates a crippled demo that holds only 120 records. Unfortunately, the demo is not up to the standards set by the real application, and it lacks many of its features. If I had tried only the demo, I would have returned it to my dealer for a refund: It bombed with a variety of spectacular memory errors on an 8-

megabyte Mac II. It also simply hung when I tried some fancy record lookups.

**HyperCard 1.2: CD-ROM Support, But Still No Exponential Notation**  
Apple's HyperCard 1.2 includes a slew of improvements over version 1.1. The most important are as follows:

- Support for read-only media, like the Apple CD SC CD-ROM drive
- Multiuser access to individual HyperCard stacks through an AppleShare file server
- Improved search and retrieval capabilities, with speed increases of 4 to 6 times that of version 1.1
- Hiding and showing card and background pictures using script commands
- Write protection for stacks
- New keyboard shortcuts that make script editing much easier

Despite all the improvements in version 1.2, Apple still needs to improve the programming (scripting) capabilities that HyperCard/HyperTalk provides. One important omission is the lack of ex-

ponential notation in HyperTalk scripts. Engineers and other developers simply must have exponential notation for their scripts.

HyperCard 1.2 was developed primarily to support Apple's CD-ROM drive (which can "play" both CD-ROM data disks and music CDs). I've tested that aspect of version 1.2 over the last week using a borrowed Apple CD-ROM drive and a CD-ROM Educational Connections disk I was given at an Apple show in March. This disk is a sampler of several large and impressive HyperCard stacks. HyperCard 1.2 worked flawlessly with them, as did the CD-ROM drive (about which I'll have more to say in a future column).

**System Tools 6.0**

Last month I reported on the beta version of System Tools 6.0. I found it buggy and difficult to install and use. I'm happy to report that most of the bugs I found have been fixed in the released version, even though installation problems remain.

When I installed System 6.0 on an 8-megabyte Mac II using the supplied install script, I immediately ran into difficulties. Things seemed to work fine when I switch-launched to the new Finder, but then the mouse froze.

When I rebooted the machine, all my INITs were successfully installed (or so I thought), but the machine froze again after the desktop was displayed. Rebooting again, the Mac didn't make it all the way through the start-up sequence, with the screen breaking up before the desktop was displayed. Additional rebooting resulted in the same screen breakup. After fiddling with this problem for 3 hours, using a separate start-up floppy disk, I finally traced the problem: I had some incompatible INITs in my system folder that just wouldn't work with System 6.0. The biggest offender was the SavesDeletes INIT from Central Point Software, which lets you recover files you've deleted by mistake. I also had trouble with SCSI Tools, MF Keys, and MenuClock 1.0 and 1.01.

To play it safe, I copied my fonts, INITs, CDEVs, and desk accessories (DAs) to other folders and deleted these and my updated System 6.0 from my hard disk system folder. I copied the virgin System 6.0 from the System Tools 6.0 package of four disks and then reinstalled all my system goodies, fonts, and DAs. After I had completed this extended process, everything worked fine. The moral of the story: If you've customized your system with lots of goodies, up-

*continued*

**Items Discussed**

<b>Apple Macintosh System Tools 6.0</b> .....	\$49
Apple Computer, Inc. 20525 Mariani Ave. Cupertino, CA 95014 (408) 996-1010 <b>Inquiry 955.</b>	
<b>FoxBASE+/Mac 1.0</b> .....	\$395
Fox Software, Inc. 118 West South Boundary Perrysburg, OH 43551 (419) 874-0162 <b>Inquiry 956.</b>	
<b>4th Dimension 1.06</b> .....	\$695
ACTIUS, Inc. 20300 Stevens Creek Blvd., Suite 495 Cupertino, CA 95014 (408) 252-4444 <b>Inquiry 957.</b>	
<b>FullWrite Professional 1.0</b> .....	\$395
Ashton-Tate Corp. 20101 Hamilton Ave. Torrance, CA 90502 (213) 329-8000. <b>Inquiry 958.</b>	
<b>HyperCard 1.2</b> .....	\$49
Apple Computer, Inc. 20525 Mariani Ave. Cupertino, CA 95014 (408) 996-1010 <b>Inquiry 959.</b>	
<b>McMax Summer '87 version</b> .....	\$295
Nantucket Corp. 12555 West Jefferson Blvd. Suite 300 Los Angeles, CA 90066 (213) 390-7923 <b>Inquiry 960.</b>	
<b>MindWrite 1.1</b> .....	\$195
Access Technology, Inc. 200 G Heritage Harbor Monterey, CA 93940 (800) 367-4334 <b>Inquiry 961.</b>	
<b>QT-Mac40</b> .....	\$1395
Tecmar, Inc. 6225 Cochran Rd. Solon, OH 44139 (216) 349-0600 <b>Inquiry 962.</b>	



# CHEAP!



**ZENITH**

SUPERSPORT 2 Drive \$ 1498  
 SUPERSPORT 2048 HD \$ 2197  
 SUPERSPORT 204 10M \$ 3034  
 SUPERSPORT 204 40M \$ 3376



HEWLETT-PACKARD  
**LASERJET Series II \$1649**



HEWLETT-PACKARD  
**DESKJET \$699**



6300 WGB 1 Drive \$ 989  
 6300 WGB 30M \$ 1268  
 6304 WGB \$ 3326



**EPSON**

Equity I+ \$ 688  
 Equity II+ \$1039  
 Equity III+ \$1344  
 LT Laptop Dual Drive \$1189  
 LT Laptop 30M HardDisk \$1798

**NEC**  
 Powermate

1 200M \$ 1198  
 1 400M \$ 1527  
 2 1818  
 3 1527  
 2 20M \$ 1818  
 2 40M \$ 2097  
 386 \$ 2692  
 386 \$ 2585  
 386 40M \$ 3098  
 386 44M \$ 3755  
 386 130M \$ 4596



All Original NEC Components  
 All Models Include Keyboard

**NEC**



Powermate Portable 20M \$ 2358  
 Powermate Portable 40M \$ 2744  
 Multipoint EL II \$ 1419  
 Multipoint HD \$ 2248

**TOSHIBA**



T1000 \$ 777  
 T1100 PLUS \$ 1388  
 T1200 \$ 2284  
 T3100/20 \$ 2987  
 T3200 \$ 3744  
 T3100 \$ 4784

**HARD DRIVES**

SEAGATE  
 200M w/Cont \$ 267  
 300M w/Cont \$ 276  
 400M w/Cont \$ 444  
 600M \$ 448  
 800M \$ 659  
**MINISCRIBE**  
 600M w/Cont \$ 334  
 600M 3650 \$ 298  
 600M 2500 \$ 659  
 71M 2500 \$ 659  
**MICROPOLIS**  
 133M 2500 w/Cont \$ 1594  
 233M 1500 w/Cont \$ 2389

**DISK DRIVES**

FLUD  
 20M HardDisk \$ 498  
 40M HardDisk \$ 629  
**TOSHIBA**  
 3.5" 720K \$ 88  
 3.5" 1.44M \$ 126  
 5.25" 360K \$ 89  
 5.25" 1.2M \$ 89  
 AMR 5.25" for PC/XT \$ 239  
 ANDREW LaserDrive with HD Backup \$ 799

**MODEMS**

HAVER  
 1200B Internal \$ 229  
 2400B Internal \$ 368  
 1200 External \$ 268  
 2400 External \$ 397  
 2400P P&P \$ 359  
**US ROBOTICS**  
 1200 Internal \$ 88  
 2400 Internal \$ 164  
 1200 External \$ 99  
 2400 External \$ 166  
 Courier 2400 P&P \$ 277  
**VERTEL**  
 2400B for P&P \$ 348

**VIDEO CARDS**

Basic VGA \$ 144  
 Hercules Mono \$ 169  
 Hercules Color \$ 139  
 Hercules HiColor \$ 266  
 NEC GS-1 \$ 268  
 Nitro Monographic \$ 49  
 Nitro Color Card \$ 49  
 Paradise Auto 486 \$ 148  
 Paradise VGA Plus \$ 228  
 P&P Laserpage \$ 532  
 P&P PG-1400 \$ 532  
 Video-7 Vega VGA \$ 248

**MOUSE DEVICES**

MICROSOFT  
 Mouse \$ 97  
 With Windows 2.0 \$ 138  
**LOGITECH**  
 Mouse \$ 74  
 With LogiCADD \$ 118  
 Publish Mouse \$ 113  
 HiRes Mouse \$ 86

Note: Specify either Serial or Bus Version

CALL FOR BEST PRICES ON



PREMIUM PRODUCTS

PRINTERS

**NEC PRINTERS**

PS 16" wide \$ 463  
 CP6 16" Color \$ 549  
 P7 16" wide \$ 644  
 CP7 16" Color \$ 733  
 P200 16" wide \$ 359  
 P6XL 16" Color \$ 877  
 P6XL 16" Color \$ 1079  
 LC200 Miniwriter \$ 3433  
 BLF-300 17 cpm \$ 417  
 3000 25 cpm \$ 896  
 3000 34 cpm \$ 1166

**CITIZEN PRINTERS**

1800 \$ 184  
 1880 \$ 199  
 2600 \$ 268  
 2600-LIE \$ 369  
 2600-45 \$ 337  
 2600-45 \$ 488  
 2600-55 \$ 422  
 2600-55 \$ 551  
 2600-55 \$ 533  
 2600-55 \$ 498  
 2600-55 \$ 664

**EPSON PRINTERS**

LX-600 \$ 189  
 FX-850 \$ 339  
 FX-1050 \$ 488  
 FX-800C \$ 329  
 FX-204E \$ 469  
 LQ-500 \$ 328  
 LQ-600 \$ 519  
 LQ-1000 \$ 737  
 LQ-2000 \$ 788

**OKIDATA PRINTERS**

16E P&P \$ 224  
 19E P&P \$ 318  
 19E PLUS \$ 412  
 29E IBM Parallel \$ 416  
 29E IBM Parallel \$ 533  
 29E Color Parallel \$ 734  
 29E Color \$ 877  
 29E Color \$ 939  
 LAMBLINE 6 Pin \$ 1345

**PANASONIC PRINTERS**

KC-P1600 \$ 198  
 KC-P1091 \$ 218  
 KC-P1092 \$ 344  
 KC-P1192 \$ 436  
 KC-P1592 \$ 492  
 KC-P1124 \$ 555  
 KC-P6121 17 cpm \$ 327  
 KC-P6111 28 cpm \$ 519  
 Laser Partner \$ 1738

**PRINTERS**

AST TurboColor/PS \$ 3383  
 DICOMEX 160 \$ 332  
 DICOMEX 300M \$ 515  
**GENCOM**  
 6410 600 lpm \$ 4689  
 4460 600 lpm \$ 5979  
 HP P&P \$ 949  
 OTC 600XL \$ 1644  
 XEROX 4000 Color \$ 1088

PRINTERS

**SOFTWARE**

Almas PageMaker 3.0 \$ 458  
 Carbon Copy \$ 109  
 Clippy \$ 319  
 CrossMail 1.0 \$ 98  
 DEXL Diamond Red \$ 118  
 Dunder 2.0 \$ 77  
 Disk Optimizer \$ 44  
 Easus \$ 98  
 Feedback Plus \$ 94  
 Feedback Plus \$ 196  
 Feedback Plus 386 \$ 288  
 Generic CAD \$ 78  
 Ultra Quest \$ 34  
 Managing Money \$ 119  
 Microsoft C \$ 266  
 MS QuickBook \$ 64

**SOFTWARE**

Microsoft EXCEL \$ 296  
 Microsoft Word 4 \$ 209  
 Microsoft Works \$ 114  
 Microsoft Write \$ 119  
 MS Windows 2.03 \$ 68  
 MS Windows 3.0 \$ 123  
 MS Flight Simulator \$ 34  
 MS Mouse Area 5.1 \$ 98  
 Novation \$ 36  
 Paradise 1.1 \$ 282  
 Paradise 2.0 \$ 387  
 PFS: Pro Write \$ 139  
 PFS: First Choice \$ 88  
 Q & A \$ 189  
 Quaxes \$ 144

**SOFTWARE**

Xerox Ventura P&P \$ 474  
 QuickShare Disk Rel. \$ 337  
 Ruffin \$ 87  
 Shogun \$ 43  
 Smart Notes \$ 52  
 GOZ Plus \$ 62  
 Dependent 4 \$ 259  
 Turbo 4 \$ 59  
 Turbo C \$ 59  
 Turbo Lighting \$ 59  
 Turbo Pascal 6.0 \$ 59  
 Turbo Pascal \$ 59  
 V7 Planner \$ 58  
 Word Perfect 5.0 \$ 219  
 Wordstar Prolex \$ 218  
 Younger Adv Flight \$ 29

**SCANNERS**

HP ScanJet w/Kit \$ 1178  
 ART TurboScan \$ 1233  
 DEST Scan Plus \$ 1798  
 Panasonic OCR \$ 1798  
 P&P L6300 w/Kit \$ 698  
 P&P L3300 OCR \$ 939

**INTEL**

8087 4.77MHz \$ 99  
 8087 5 MHz \$ 142  
 8087 6.6 MHz \$ 179  
 80287 3 MHz \$ 243  
 80287 10 MHz \$ 289  
 80387 16 MHz \$ 448  
 80387 20 MHz \$ 689  
 Above 84 286 10M \$ 314  
 Above 84 P&P 10M \$ 249  
 Inboard 386/PC 1M \$ 726  
 Inboard 386/AT 1M \$ 988

**PLOTTERS**

HEWLETT-PACKARD  
 7440 COLORP&P \$ 877  
 7475A 6 Pin \$ 1259  
 7485A 9 Pin \$ 2489  
 7575A DraftPro \$ 2598

**MONITORS**

Amdah 110 \$ 138  
 433 VGA Mono \$ 156  
 782 VGA Color \$ 414  
 1280 8 video card \$ 638  
 NEC Monochrome \$ 129  
 AST VGA Color \$ 477  
 Epsilon Mono \$ 114  
 Epsilon Color \$ 288  
 Epsilon HiColor \$ 368  
 Gaudin Drop Sys \$ 1288  
 NEC Monographic \$ 1244  
 NEC Multitap XL \$ 1892

**MONITORS**

NEC Multitap II \$ 549  
 NEC Multitap OS \$ 179  
 NEC Multitap Plus \$ 858  
 P&P HG-12 \$ 436  
 P&P Mac-11 \$ 264  
 P&P LH-500 \$ 538  
 P&P LH-500 \$ 539  
 Texas Crystal View \$ 1434  
 WYSE WY-700 \$ 717  
 Zenith 14.0 \$ 109  
 Zenith 18.0 \$ 419  
 Zenith 14.0 \$ 584

**ACCESSORIES**

Printer Cable 6' \$ 9  
 Printer Cable 18' \$ 14  
 Parallel Adapter \$ 29  
 Serial Adapter \$ 29  
 Game Adapter \$ 19  
 101 Keyboard \$ 68  
 P&P Keyboard \$ 16  
 P&P Mouse Exam \$ 21  
 John D&D Disk \$ 7  
 John 1.2M Disk \$ 13  
 IBM 3.5" 1M Disk \$ 29  
 IBM 3.5" 2M Disk \$ 58

HOURS (E.S.T.)  
 9-9 Monday-Friday  
 1-6 Saturday



120 West Main Street - CARMEL, IN 46032

800-382-3888



Please add 3% for shipping & handling. NO SURCHARGE FOR CREDIT CARDS and we do not charge until we ship. All items subject to availability and price change. All standard orders are cost UPS.





date to 6.0 by installing a clean copy of it, installing your INITs, CDEVs, fonts, and DAs afterward.

**Tecmar QT-Mac40**

If you're like me, you preach to your colleagues on the importance of backing up their hard disks every day. This gospel is hard to accept, considering the slow and/or expensive backup alternatives for the Mac. I've been using a GCC Hyper-Tape DC-2000 tape drive for about a

year, and I've found it reliable when I use the MacUp backup program available from APDA. But it's slow. It takes as much as an hour to back up a single day's worth of work.

So when I got an opportunity to work with a new DC-2000 tape drive that was supposed to be the fastest on the market, I jumped at the chance. In a month's worth of abuse, the Tecmar QT-Mac40 proved its mettle and its speed. It connects to the Mac's SCSI port and has

worked reliably with the Mac Plus and Mac SE, as well as the Mac II. The QT-Mac40 transfers data at about 2.5 megabytes per minute. It backs up data faster than any DC-2000 drive I've tried, and I've tried them all.

You control the QT-Mac40 using the supplied backup/restore software, which is very good. Under MultiFinder, the Tecmar software lets you back up your data in the background while running any other foreground application. This is a handy feature that I haven't found with any other drive or backup software.

The Tecmar software supports file-by-file, incremental, and full-image backups, which pretty much covers the kinds of backups you might want to do. The Tecmar drive can mix file-by-file and image backups on the same tape—another feature many other drives lack.

In a month of testing, I haven't found anything to gripe about with the Tecmar QT-Mac40. It lists for \$1395, although I've seen it discounted for as little as \$999. At that price, I think I'll get two—one for my office Mac II and another for my home Mac II.

**FullWrite Professional—Redux**

Last month, I complained about the speed of FullWrite Professional on a 1-megabyte Mac Plus. With that hardware, the program is almost unusable. But now I'm using it exclusively on an 8-megabyte Mac II. The result is editing nirvana. On the fast, memory-rich Mac II, FullWrite moves along nicely. And all those features are really useful. I don't know how I got along without FullWrite's note and sidebar capabilities before.

The outliner is not as easy to use as MindWrite 1.1's, but it's far superior to Microsoft Word 3.02's. Add to that its document information tally (counts for characters, words, and lines, and a readability index), and you've got a great tool for writers. And that doesn't even touch on its built-in desktop publishing and graphics features. If I were Microsoft, I'd be worried. For my money, FullWrite Professional is everything that Word promised but has never delivered. As long as you have lots of RAM, that is. ■

*Don Crabb is the director of laboratories and a senior lecturer for the computer science department and the college at the University of Chicago. He is also a consulting editor for BYTE. He can be reached on BIX as "decrabb."*

*Your questions and comments are welcome. Write to: Editor, BYTE, One Phoenix Mill Lane, Peterborough, NH 03458.*

**SUNDAY 10-5** **PROMPT DELIVERY**

**COMPUTERS**  
 APPLE II 240K \$199.95  
 APPLE II 480K \$249.95  
 APPLE II 960K \$299.95  
 APPLE II 1920K \$349.95  
 APPLE II 3840K \$399.95  
 APPLE II 7680K \$449.95  
 APPLE II 15360K \$499.95  
 APPLE II 30720K \$549.95  
 APPLE II 61440K \$599.95  
 APPLE II 122880K \$649.95  
 APPLE II 245760K \$699.95  
 APPLE II 491520K \$749.95  
 APPLE II 983040K \$799.95  
 APPLE II 1966080K \$849.95  
 APPLE II 3932160K \$899.95  
 APPLE II 7864320K \$949.95  
 APPLE II 15728640K \$999.95  
 APPLE II 31457280K \$1049.95  
 APPLE II 62914560K \$1099.95  
 APPLE II 125829120K \$1149.95  
 APPLE II 251658240K \$1199.95  
 APPLE II 503316480K \$1249.95  
 APPLE II 1006632960K \$1299.95  
 APPLE II 2013265920K \$1349.95  
 APPLE II 4026531840K \$1399.95  
 APPLE II 8053063680K \$1449.95  
 APPLE II 16106127360K \$1499.95  
 APPLE II 32212254720K \$1549.95  
 APPLE II 64424509440K \$1599.95  
 APPLE II 128849018880K \$1649.95  
 APPLE II 257698037760K \$1699.95  
 APPLE II 515396075520K \$1749.95  
 APPLE II 1030792151040K \$1799.95  
 APPLE II 2061584302080K \$1849.95  
 APPLE II 4123168604160K \$1899.95  
 APPLE II 8246337208320K \$1949.95  
 APPLE II 16492674416640K \$1999.95  
 APPLE II 32985348833280K \$2049.95  
 APPLE II 65970697666560K \$2099.95  
 APPLE II 131941395333120K \$2149.95  
 APPLE II 263882790666240K \$2199.95  
 APPLE II 527765581332480K \$2249.95  
 APPLE II 1055531162664960K \$2299.95  
 APPLE II 2111062325329920K \$2349.95  
 APPLE II 4222124650659840K \$2399.95  
 APPLE II 8444249301319680K \$2449.95  
 APPLE II 1688849860639360K \$2499.95  
 APPLE II 3377699721278720K \$2549.95  
 APPLE II 6755399442557440K \$2599.95  
 APPLE II 13510798885114880K \$2649.95  
 APPLE II 27021597770229760K \$2699.95  
 APPLE II 54043195540459520K \$2749.95  
 APPLE II 10808639108091040K \$2799.95  
 APPLE II 21617278216182080K \$2849.95  
 APPLE II 43234556432364160K \$2899.95  
 APPLE II 86469112864728320K \$2949.95  
 APPLE II 17293825729544640K \$2999.95  
 APPLE II 34587651459089280K \$3049.95  
 APPLE II 69175302918178560K \$3099.95  
 APPLE II 138350605836357120K \$3149.95  
 APPLE II 276701211672714240K \$3199.95  
 APPLE II 553402423345428480K \$3249.95  
 APPLE II 110680484689085760K \$3299.95  
 APPLE II 221360969378171520K \$3349.95  
 APPLE II 442721938756343040K \$3399.95  
 APPLE II 885443877512686080K \$3449.95  
 APPLE II 1770887755025372160K \$3499.95  
 APPLE II 3541775510050744320K \$3549.95  
 APPLE II 7083551020101488640K \$3599.95  
 APPLE II 1416710244020297280K \$3649.95  
 APPLE II 2833420488040594560K \$3699.95  
 APPLE II 5666840976081189120K \$3749.95  
 APPLE II 11333681952136383680K \$3799.95  
 APPLE II 22667363904272767360K \$3849.95  
 APPLE II 45334727808545534720K \$3899.95  
 APPLE II 90669455617091069440K \$3949.95  
 APPLE II 181338911233818218880K \$3999.95  
 APPLE II 36267782246763637760K \$4049.95  
 APPLE II 72535564493527275520K \$4099.95  
 APPLE II 145071128987054551040K \$4149.95  
 APPLE II 290142257974109102080K \$4199.95  
 APPLE II 580284515948218204160K \$4249.95  
 APPLE II 1160569031976373608320K \$4299.95  
 APPLE II 2321138063952747216640K \$4349.95  
 APPLE II 4642276127905494433280K \$4399.95  
 APPLE II 9284552255810988866560K \$4449.95  
 APPLE II 18569104511617977733120K \$4499.95  
 APPLE II 37138209023235955466240K \$4549.95  
 APPLE II 74276418046471910932480K \$4599.95  
 APPLE II 148552836932943818864960K \$4649.95  
 APPLE II 297105673865887637729920K \$4699.95  
 APPLE II 594211347731775275559840K \$4749.95  
 APPLE II 1188422695463550511119680K \$4799.95  
 APPLE II 2376845390927101022339360K \$4849.95  
 APPLE II 4753690781854202044678720K \$4899.95  
 APPLE II 9507381563708404089356480K \$4949.95  
 APPLE II 190147631274168081787111040K \$4999.95  
 APPLE II 380295262548336163574222080K \$5049.95  
 APPLE II 760590525096672327148444160K \$5099.95  
 APPLE II 152118105019334445548888320K \$5149.95  
 APPLE II 304236210038668891097766640K \$5199.95  
 APPLE II 608472420077337782195533280K \$5249.95  
 APPLE II 1216944840154675544391066560K \$5299.95  
 APPLE II 2433889680309351088782133120K \$5349.95  
 APPLE II 4867779360618702177756426240K \$5399.95  
 APPLE II 9735558721237404355512852480K \$5449.95  
 APPLE II 1947111744246808711110564960K \$5499.95  
 APPLE II 389422348849361742222111110K \$5549.95  
 APPLE II 778844697698723484444222222K \$5599.95  
 APPLE II 1557689355397446888884444444K \$5649.95  
 APPLE II 311537871079489377777888888K \$5699.95  
 APPLE II 623075742158978755555777777K \$5749.95  
 APPLE II 1246151443117975711111555555K \$5799.95  
 APPLE II 249230288623595142222333333K \$5849.95  
 APPLE II 498460577247190284444666666K \$5899.95  
 APPLE II 996921154494380568889999999K \$5949.95  
 APPLE II 1993842289888641137779999999K \$5999.95  
 APPLE II 398768457977728227559999999K \$6049.95  
 APPLE II 797536915955556555559999999K \$6099.95  
 APPLE II 1595073831111111111111111111K \$6149.95  
 APPLE II 319014766222222222222222222K \$6199.95  
 APPLE II 638029532444444444444444444K \$6249.95  
 APPLE II 127605904888888888888888888K \$6299.95  
 APPLE II 255211809777777777777777777K \$6349.95  
 APPLE II 510423619555555555555555555K \$6399.95  
 APPLE II 1020847391111111111111111111K \$6449.95  
 APPLE II 204169478222222222222222222K \$6499.95  
 APPLE II 408338956444444444444444444K \$6549.95  
 APPLE II 816677912888888888888888888K \$6599.95  
 APPLE II 163335585777777777777777777K \$6649.95  
 APPLE II 326671171555555555555555555K \$6699.95  
 APPLE II 653342343111111111111111111K \$6749.95  
 APPLE II 130668466222222222222222222K \$6799.95  
 APPLE II 261336932444444444444444444K \$6849.95  
 APPLE II 522673864888888888888888888K \$6899.95  
 APPLE II 104534771777777777777777777K \$6949.95  
 APPLE II 209069543555555555555555555K \$6999.95  
 APPLE II 418139087111111111111111111K \$7049.95  
 APPLE II 836278174222222222222222222K \$7099.95  
 APPLE II 167255648444444444444444444K \$7149.95  
 APPLE II 334511296888888888888888888K \$7199.95  
 APPLE II 669022593777777777777777777K \$7249.95  
 APPLE II 133804587555555555555555555K \$7299.95  
 APPLE II 267609175111111111111111111K \$7349.95  
 APPLE II 535218350222222222222222222K \$7399.95  
 APPLE II 107043699444444444444444444K \$7449.95  
 APPLE II 214087398888888888888888888K \$7499.95  
 APPLE II 428174797777777777777777777K \$7549.95  
 APPLE II 856349595555555555555555555K \$7599.95  
 APPLE II 171269991111111111111111111K \$7649.95  
 APPLE II 342539982222222222222222222K \$7699.95  
 APPLE II 685079964444444444444444444K \$7749.95  
 APPLE II 137015938888888888888888888K \$7799.95  
 APPLE II 274031877777777777777777777K \$7849.95  
 APPLE II 548063755555555555555555555K \$7899.95  
 APPLE II 109612751111111111111111111K \$7949.95  
 APPLE II 219225502222222222222222222K \$7999.95  
 APPLE II 438451004444444444444444444K \$8049.95  
 APPLE II 876902008888888888888888888K \$8099.95  
 APPLE II 175380401777777777777777777K \$8149.95  
 APPLE II 350760803555555555555555555K \$8199.95  
 APPLE II 701521607111111111111111111K \$8249.95  
 APPLE II 140304321422222222222222222K \$8299.95  
 APPLE II 280608642844444444444444444K \$8349.95  
 APPLE II 561217285688888888888888888K \$8399.95  
 APPLE II 112243457377777777777777777K \$8449.95  
 APPLE II 224486914755555555555555555K \$8499.95  
 APPLE II 448973829511111111111111111K \$8549.95  
 APPLE II 897947659022222222222222222K \$8599.95  
 APPLE II 179589531804444444444444444K \$8649.95  
 APPLE II 359179063608888888888888888K \$8699.95  
 APPLE II 718358127201777777777777777K \$8749.95  
 APPLE II 143671654403555555555555555K \$8799.95  
 APPLE II 287343308807111111111111111K \$8849.95  
 APPLE II 574686617614222222222222222K \$8899.95  
 APPLE II 114937323228444444444444444K \$8949.95  
 APPLE II 229874646456888888888888888K \$8999.95  
 APPLE II 459749292913777777777777777K \$9049.95  
 APPLE II 919498585827555555555555555K \$9099.95  
 APPLE II 183899171655111111111111111K \$9149.95  
 APPLE II 367798343310222222222222222K \$9199.95  
 APPLE II 735596686620444444444444444K \$9249.95  
 APPLE II 147119373340888888888888888K \$9299.95  
 APPLE II 294238746681777777777777777K \$9349.95  
 APPLE II 588477493363555555555555555K \$9399.95  
 APPLE II 117695486726711111111111111K \$9449.95  
 APPLE II 235390973453422222222222222K \$9499.95  
 APPLE II 470781946906844444444444444K \$9549.95  
 APPLE II 941563893813688888888888888K \$9599.95  
 APPLE II 188312777762777777777777777K \$9649.95  
 APPLE II 376625555525555555555555555K \$9699.95  
 APPLE II 753251111151111111111111111K \$9749.95  
 APPLE II 150650222222222222222222222K \$9799.95  
 APPLE II 301300444444444444444444444K \$9849.95  
 APPLE II 602600888888888888888888888K \$9899.95  
 APPLE II 120520177777777777777777777K \$9949.95  
 APPLE II 241040355555555555555555555K \$9999.95  
 APPLE II 482080711111111111111111111K \$10049.95  
 APPLE II 964161422222222222222222222K \$10099.95  
 APPLE II 192832244444444444444444444K \$10149.95  
 APPLE II 385664488888888888888888888K \$10199.95  
 APPLE II 771328977777777777777777777K \$10249.95  
 APPLE II 154265755555555555555555555K \$10299.95  
 APPLE II 308531511111111111111111111K \$10349.95  
 APPLE II 617063022222222222222222222K \$10399.95  
 APPLE II 123412604444444444444444444K \$10449.95  
 APPLE II 246825208888888888888888888K \$10499.95  
 APPLE II 493650417777777777777777777K \$10549.95  
 APPLE II 987300835555555555555555555K \$10599.95  
 APPLE II 197460171111111111111111111K \$10649.95  
 APPLE II 394920342222222222222222222K \$10699.95  
 APPLE II 789840684444444444444444444K \$10749.95  
 APPLE II 157968168888888888888888888K \$10799.95  
 APPLE II 315936337777777777777777777K \$10849.95  
 APPLE II 631872675555555555555555555K \$10899.95  
 APPLE II 126374551111111111111111111K \$10949.95  
 APPLE II 252749102222222222222222222K \$10999.95  
 APPLE II 505498204444444444444444444K \$11049.95  
 APPLE II 101099608888888888888888888K \$11099.95  
 APPLE II 202199217777777777777777777K \$11149.95  
 APPLE II 404398435555555555555555555K \$11199.95  
 APPLE II 808796871111111111111111111K \$11249.95  
 APPLE II 161759342222222222222222222K \$11299.95  
 APPLE II 323518684444444444444444444K \$11349.95  
 APPLE II 647037368888888888888888888K \$11399.95  
 APPLE II 129407477777777777777777777K \$11449.95  
 APPLE II 258814955555555555555555555K \$11499.95  
 APPLE II 517629911111111111111111111K \$11549.95  
 APPLE II 103525982222222222222222222K \$11599.95  
 APPLE II 207051964444444444444444444K \$11649.95  
 APPLE II 414103928888888888888888888K \$11699.95  
 APPLE II 828207857777777777777777777K \$11749.95  
 APPLE II 165641575555555555555555555K \$11799.95  
 APPLE II 331283151111111111111111111K \$11849.95  
 APPLE II 662566302222222222222222222K \$11899.95  
 APPLE II 132513264444444444444444444K \$11949.95  
 APPLE II 265026528888888888888888888K \$11999.95  
 APPLE II 530053057777777777777777777K \$12049.95  
 APPLE II 106010615555555555555555555K \$12099.95  
 APPLE II 212021231111111111111111111K \$12149.95  
 APPLE II 424042462222222222222222222K \$12199.95  
 APPLE II 848084924444444444444444444K \$12249.95  
 APPLE II 169616948888888888888888888K \$12299.95  
 APPLE II 339233897777777777777777777K \$12349.95  
 APPLE II 678467795555555555555555555K \$12399.95  
 APPLE II 135693591111111111111111111K \$12449.95  
 APPLE II 271387182222222222222222222K \$12499.95  
 APPLE II 542774364444444444444444444K \$12549.95  
 APPLE II 108554878888888888888888888K \$12599.95  
 APPLE II 217109757777777777777777777K \$12649.95  
 APPLE II 434219515555555555555555555K \$12699.95  
 APPLE II 868439031111111111111111111K \$12749.95  
 APPLE II 173687862222222222222222222K \$12799.95  
 APPLE II 347375724444444444444444444K \$12849.95  
 APPLE II 694751448888888888888888888K \$12899.95  
 APPLE II 138950297777777777777777777K \$12949.95  
 APPLE II 277900595555555555555555555K \$12999.95  
 APPLE II 555801191111111111111111111K \$13049.95  
 APPLE II 111160238222222222222222222K \$13099.95  
 APPLE II 222320476444444444444444444K \$13149.95  
 APPLE II 444640952888888888888888888K \$13199.95  
 APPLE II 889281905777777777777777777K \$13249.95  
 APPLE II 177856381555555555555555555K \$13299.95  
 APPLE II 355712763111111111111111111K \$13349.95  
 APPLE II 711425526222222222222222222K \$13399.95  
 APPLE II 142285104444444444444444444K \$13449.95  
 APPLE II 284570208888888888888888888K \$13499.95  
 APPLE II 569140417777777777777777777K \$13549.95  
 APPLE II 113828835555555555555555555K \$13599.95  
 APPLE II 227657671111111111111111111K \$13649.95  
 APPLE II 455315342222222222222222222K \$13699.95  
 APPLE II 910630684444444444444444444K \$13749.95  
 APPLE II 182126136888888888888888888K \$13799.95  
 APPLE II 364252273777777777777777777K \$13849.95  
 APPLE II 728504547555555555555555555K \$13899.95  
 APPLE II 145700909111111111111111111K \$13949.95  
 APPLE II 291401818222222222222222222K \$13999.95  
 APPLE II 582803636444444444444444444K \$14049.95  
 APPLE II 11656072728888888888888





# Leprecard



Leprecards feature components utilizing the latest technology from Seagate & Western Digital. You get a 1 year warranty, & illustrated user's guide. Low power drives mean less strain on the power supply, lower operating temperatures, and longer component life. **FREE SOFTWARE** including **TakeTwo**, the backup utility, PC MAGAZINE Editor's Choice in 1986 & 1987, & **PC-KWIK** disk cache software from Multisoft.

21MB 85ms	30MB 85ms	30MB 40ms	40MB 70ms*	49MB 28ms*	65MB 16ms*
<b>\$299</b>	<b>\$339</b>	<b>\$389</b>	<b>\$449</b>	<b>\$549</b>	<b>\$649</b>

\*Average access speed per partition  
**TANDY 1000/A/SX/TX Leprecards add \$20**

# LepreFAX Modems New!

Internal **\$299**  
 External **\$359**

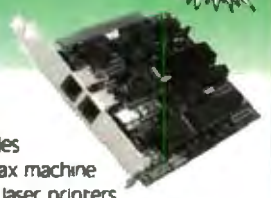

- Easy to use Pop-up Menus
- Sends ASCII or word processing files
- Send/Receive from any Group 3 fax machine
- Prints on standard dot-matrix or laser printers
- Automated sending during low phone rate periods
- Internal 4800bps, \$289 9600bps \$559
- Portable external plugs into PC serial port, \$359

## PC/XT Disk Kits

- Pretested & formatted
- Western Digital short controller
- 30 page installation guide & reference manual
- Cables, mounting screws, full & half-height face plates
- **TakeTwo** backup software, PC MAGAZINE "Editor's Choice"
- **PC-KWIK** disk cache software by Multisoft
- 1 year Warranty, 30 day Money Back Guarantee
- Optional 150 watt, UL/FCC approved power supply for IBM PCs **\$60**



**TANDY 1000 kits add \$20**

<b>20MB kit</b> Seagate ST225 21.4MB/65ms/Half-Height/14.8 watts	<b>\$289</b>
<b>30MB kit</b> Seagate ST238 32.7MB/65ms/Half-Height/14.8 watts	<b>\$309</b>
<b>40MB kit</b> Seagate ST251 42.8MB/Half-Height/11 watts pre-formatted into a pair of 21MB/28ms partitions	<b>\$459</b>
<b>65MB kit</b> Seagate ST277R 65.5MB/Half-Height/11 watts pre-formatted into a pair of 32MB/28ms partitions	<b>\$549</b>

## 286<sup>10</sup> Computer

80286 processor at running at 6/10 Mhz with 0 wait states provides a Norton SI rating of 11.5. 8 slots - Room for 1 full height and 3 half - height drives - 200 watt power supply - Clock calendar - Choice of 1.2 or 1.44MB floppy drive - Combination Hard Disk/Floppy drive controller - Maxiswitch 84 or 101 key Keyboard - 512K RAM standard expandable to 1 MB - Award BIOS - 1 year warranty - 30 day money back guarantee



**\$895**

### Complete Systems with Serial/Parallel/Game Ports:

Monographics Card & Monitor	<b>\$1095</b>	Orchid 512K VGA & Multisync II	<b>\$1995</b>
with 20MB/65ms Seagate	<b>\$1289</b>	with 20MB/65ms Seagate	<b>\$2189</b>
with 40MB/40ms Seagate	<b>\$1429</b>	with 40MB/40ms Seagate	<b>\$2329</b>
with 65MB/40ms Seagate	<b>\$1549</b>	with 65MB/40ms Seagate	<b>\$2449</b>

## 1.5 MB Laser Printer

"One of the laserjet's strongest competitors."  
 INFOWORLD October 5, 1987



512K RAM **\$1295**  
 1.5MB RAM **\$1595**

- 100% HP Laserjet, & Laserjet + compatible
- 1.5MB RAM Gives Full Page 300dpi graphics
- Vector graphics capability improves speed on programs like Autocad up to 93%
- 9 resident & 5 downloadable soft fonts standard
- Printer utility software
- Serial & Parallel interfaces
- 120 day TRW on site maintenance
- 1 year Warranty
- Options: All HP style font cartridges  
 Toner Cartridge **\$29**

## AT Hard Disk Kits

- Includes: BM AT rails & cables
- **SpeedStor** or **OnTrack** large drive software
- Formatted, Partitioned & Tested

Size	Model	Speed	Capacity	Price
HH	Seagate ST251	40ms	42.8MB	<b>\$359</b>
HH	Seagate ST251-1	30ms	42.8MB	<b>\$449</b>
FH	Seagate ST4096	28ms	80.2MB	<b>\$599</b>
FH	Maxtor 1140	27ms	117MB	<b>\$1669</b>
FH	Maxtor 2190	30ms	150MB	<b>\$1999</b>

## Orchid

Designer VGA  
 512K **\$299** 256K **\$269**  
 Tiny Turbo 286 **\$289**  
 Ramquest II 1MB **\$799**



25248 Townsgate Rd, Dept. B / Westlake Village, CA 91361

To order, or get our free catalog, call:

Toll Free  
**800-722-AT-XT**  
 California  
**805-373-7847**



- No extra for Visa/Mastercard (AMEX add 3%)
- Prices include UPS surface shipping.
- Federal Express shipping just \$1.50 per pound.
- 30 Day Money Back Guarantee.
- Corporate & Institutional PO's accepted.

## 3.5" Floppy Kits

Internal kits for PC/XT/AT computers include 5/4" mounting bracket, black & gray face plates, and AT rails. 1.44 MB for PC/XT includes high speed Western Digital controller. FREE TAKE TWO floppy backup software.

720 Kit	1.44MB for AT	1.44MB for PC/XT
<b>\$109</b>	<b>\$139</b>	<b>\$199</b>

## 2400 MNP Modems

- Hasv Compatible, 300/1200/2400
- MNP level 4 error correction
- **FREE MIRROR II** Software, a \$69 value
- Internal model \$229, fits in short slot

**Internal with MIRROR II (non MNP) \$109**



# HIGH TECH, F



# RENCH TOUCH.

One can appreciate the efficiency of the Normerel ATC 12 just by looking at its design.

Extra low profile, small foot print, latest technology, single board, and surface mounted technology, with everything you can think of built in for greater reliability.

Equipped with a new standard of VGA visualization containing a 256 color palette, its monitor displays "photo" quality images.

Built around a 12.5 MHz processor, its execution speed is from 1.5 to 2 times faster than that of its competitors and it is very user friendly.

Far from the superficial and over-populated world of clones, Normerel ATC 12 offers the well controlled quality, the sure and subtle touch of elegance of traditional french manufacturing. Dealers Wanted.

<b>Technical Specs.</b> 80286 - 12.5 / 8 Mhz soft switchable. DRAM - 640 KB expandable. ON BOARD - (Standard) Video - TTL: MDA, HDA, CGA, EGA, EGA plus - Analogues: VGA. I/O - 2 RS 232 - 1 Parallel Port - Mouse Port	<b>Controller</b> - Floppy - 3 1/2 - 5 1/4 all format - Rigid Disk - SCSI Drum Socket - 2 MB SIMM's Socket 3 Free Slots - 2 AT Format - 1 PC Format
---	--

## NORMEREL THE BRAIN IS BEAUTIFUL.

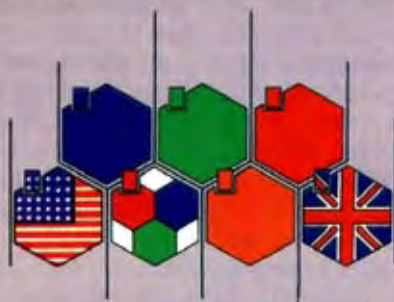

Circle 192 on Reader Service Card

NORMEREL U.S. Inc. P.O. Box 1309 - 44th Street - ORLANDO -  
FLORIDA 32809. Tel. U.S. (800) 327.9877

NORMEREL SYSTEMES - 50 rue Pottier 78150 LE CHESNAY - FRANCE  
Tel. 33 (1) 39.54.90.06 Telex NRLSYS 699424 F - Fax 33 (1) 39.55.38.13

NORMEREL U.S. - 16 Crow Canyon Court, Suite 225 - SAN RAMON  
CALIFORNIA 94583 - U.S.A. Tel. (415) 831 8792

NORMEREL UK - Pathtrace House - 91/99 High Street - BANSTEAD - SURREY SM7 2NL  
ENGLAND - Tel. (0737) 360482/83 Telex 267 597 JSUK Fax (0737) 362813





## Which would you like to see first? The world's fastest dBASE compiler or the most powerful database development language?

Surprise. Now you get both in the same package. New Clipper™ from Nantucket.\*

Our latest version — Summer '87 — is still the best-performing compiler ever. It lets users run dBASE® applications up to 20 times faster. But there's a lot more to it than raw speed.

Because new Clipper is one of the most powerful, full-featured development languages ever. And gives you more control over your applications than any release of dBASE ever will. Now or in the future.

Instead of designing Clipper as an add-on, we've structured it as an extended database language that uses dBASE as a subset. In addition to emulating the dBASE language, we've added commands for menus, screens, windows and extended functions. As a result, you get dBASE compatibility and an entirely new level of power and versatility.

And with Clipper's open architecture, you can write functions in Clipper, C, Assembler or other languages, and integrate them into one seamless application. Which helps you create more sophisti-

cated applications in less time. And by using our full-featured debugger, you'll be done even faster.

We also give you source code security that keeps users from damaging your application. And sophisticated record and file locking capabilities that make networking applications easier to create. But no matter what you create, you don't have to buy runtime modules or additional software. You don't even have to pay licensing fees.

If you haven't tried Clipper yet, just call (213) 390-7923 today. We'll send you full information and a free demo diskette. Or the complete program, if you'd rather.

But call today. And see how easy it is to find the best dBASE development language. Just get the fastest compiler. And open the box.

# Clipper™

Nantucket, 12555 W. Jefferson Boulevard  
Los Angeles, CA 90066 Telex: 650-2574125



© Nantucket Corporation, 1988. Nantucket is a registered trademark and Clipper is a trademark of Nantucket Corporation. dBASE is a registered trademark of Ashton-Tate.



# ALL TOGETHER NOW

From LAN Manager to device monitors, OS/2's features let programs and peripherals live and work in harmony

**L**ast month, I started looking at OS/2's new features. This month, I'll continue the discussion, but first I want to share some test results.

Recall that OS/2 offers virtual memory to applications. If an application requires more memory than the RAM available, OS/2 can use free disk space in place of RAM. I tested OS/2 1.0's virtual memory manager with the simple BASIC program shown in listing 1. This program allocates an integer array, fills it up, and then reports total execution time. Table 1 shows the test results for various array sizes. It shows the array size used (in number of elements and in K bytes), how long it took to allocate and fill the array, and then total time divided by bytes to yield a rough seconds-per-byte number.

Notice the large jump between 400 and 500 elements. Up to about 400, the array is kept entirely in memory, and the program requires about 0.02 second to process a byte. At 500 elements, virtual memory takes over. As the drive light was on continuously throughout the program's execution, it appears that *each* memory access becomes a disk access once virtual memory is activated.

Granted, virtual memory should be slower than RAM, but look at the difference: 0.02 second per byte versus roughly 13 seconds per byte. That's a factor of 650. At that speed, my 80386 is about 30 times slower than a Commodore 64.

Multitasking virtually (no pun intended) dies when this test program is

running. Pressing Ctrl-Esc to get to the Session Manager yields a Session Manager screen after 10 minutes' wait.

In case you are wondering what kind of underlying hardware I used to test this, I do much of my work on a PS/386, a 16-MHz Compaq Deskpro clone made by Trillian Computer. It uses 4 megabytes of 32-bit static column RAM. The hard disk uses the standard Western Digital AT-type controller and a 26-millisecond Priam disk drive. I use the Compaq VGA board (which I highly recommend for speed and compatibility).

## LAN Manager

A major difference between DOS and OS/2 is that OS/2 was designed with networking in mind. OS/2's LAN (local-area network) Manager is an add-on program that brings LAN capabilities to OS/2. LAN Manager brings many new features to Microsoft's networking software. In the process of writing LAN Manager, Microsoft also rewrote its DOS-based LAN software, MS-Networks.

LAN Manager and the accompanying rewrite of MS-Networks include many new Novell- and Banyan-type LAN operating-system features. Security locks are now user- and file-specific. The system can nag users to change their passwords periodically, as the LAN Manager keeps password age information. Attempts at unauthorized access can be logged.

OS/2 allows more comprehensive resource sharing. One OS/2 workstation can run a program entirely on another computer. The workstation just sees the output screens and supplies keystrokes. Other than that, the workstation essentially becomes a dumb terminal. This is intended so that programs like database servers can be constructed. Consider, for example, a SORT command under dBASE on a LAN. With dBASE known for its glacial sorting speed, and sorts being disk-intensive to begin with, add LAN overhead and the whole thing's out of the question. Remote execution would

let dBASE move itself to the server temporarily, just long enough to accomplish the sort.

Imagine other possibilities: One machine with expensive dedicated graphics hardware that computes screens for five CAD stations. Groupware that moves parts of a user's programs to and fro among workstations to provide load leveling. Or, for the nostalgic, one 80386 doing the processing for 15 users with 80286-based dumb terminals. (That sounds silly, but I've heard of a company trying to make OS/2 multiuser through this avenue. Some clients have even told me that IBM has told them, *sub rosa*, that a multiuser OS/2 is in the works.)

There are many other neat features, and I'll talk about them in a future column. In a few words, the OS/2 LAN Manager is a "fixed" version of MS-Networks, and a welcome one.

## Program Harmony

Under OS/2, programs don't step all over each other. SideKick doesn't mess up a Windows screen. One program's manipulation of the keyboard Num Lock/Scroll Lock/Caps Lock status byte doesn't lead to "surprise" uppercase when the next program runs. This makes OS/2's job of multitasking easier.

The reason DOS isn't multitasking has nothing to do with the 80286 or 80386. The main reason that DOS isn't multitasking is that it isn't an operating system (gasp). It's a program loader, a launching pad that starts applications going and then says, "Wake me up when you're finished." DOS is completely inactive when a program is running. The program is supposed to call DOS to do something like print a character or read a file, but many programs are designed to handle such system functions themselves and bypass DOS altogether.

DOS bypass is mainly due to DOS's slowness and incompleteness—for example, DOS doesn't support video graphics

*continued*



## Finally . . . a low cost, high speed copier for 5¼ and 3½ inch diskettes!

Attach a Victory V3000 Autoloader to your IBM/PC or Apple/Macintosh, enter one or more copy jobs, and walk away! The system automatically copies 5¼ or 3½ inch diskettes—up to 180 per hour. Switching the copy drive takes less than two minutes.

**Copy Formats Flawlessly.**  
Victory's Auto-Dup™ software copies different formats or you can

build your own format. Auto-Dup tests the quality of each copy, sorting diskettes into one of two output bins.

**Do-It-Yourself Servicing.**  
The Autoloader's simple component design and diagnostics for checking drive alignment and speed allow you to maintain the system without outside service.

Call (800) 421-0103. And ask about Victory's family of affordable Autoloaders that support

Hard Drive Back-Up, Serialization, and Custom Label Printing.



**VICTORY ENTERPRISES**

Technology, Inc.

Victory Plaza  
1011 E. 53½ Street  
Austin, TX 78751-1728  
(512) 450-0801

In Europe call BFL: Paris (33-1) 45330137, Frankfurt (49-6074) 27061, London (44-1) 941-4066, Milan (39-2) 33100535, Stockholm (46-8) 7547480, Madrid (34-1) 2558903.



# POWER TOOL.

Introducing 4x488™

You get intelligent IEEE-488 and RS232 ports to make instrument programming fast and easy.

You can have up to 4 Mbytes of memory on the same board for your largest programs, RAM disks, and data acquisition tasks.

Compatibility is built-in so you can run your favorite programs or create new ones with our advanced programming tools.



To get your FREE demo disk—call 617-273-1818.

Capital Equipment Corp.  
Burlington, MA 01803



The bottom line—IEEE-488, RS232, par. port, 4MB EEM LIM, runs DOS and OS/2.

## OS/2 NOTEBOOK

commands. (Unfortunately, neither does OS/2, unless you use the Presentation Manager.) If every program communicated with peripherals via DOS, most programs would have to wake DOS fairly regularly. Every screen write, keyboard read, and disk access would activate it. DOS could then take that opportunity to switch programs, and voila: multitasking. Microsoft Windows accomplishes limited multitasking in this way.

Using system requests to control task switching won't work if one of the programs doesn't need to make system requests (i.e., doesn't do any I/O). Consider a spreadsheet recalculation or a word processor repagination. Such a CPU-intensive program could grab the system and hold it. Solving the CPU-intensive problem is easy, though: Just add a hardware timer (already built into the IBM PC machines) to force an interrupt and allow the operating system to force a switch to another program.

Programs *don't* always use DOS system requests, however, so the job of switching DOS programs, each convinced that it owns the machine, is almost impossible. OS/2, built to run in the 80286 chip's protected mode, can enforce the rules. It can control I/O ports, memory areas, and access to system services. The silicon itself disallows any attempts to bypass the operating system. (Some readers may know that the 80386 chip contains a virtual 8086 mode that allows DOS multitasking. This is not exploited in OS/2 because OS/2 is designed for 80286 as well as 80386 machines.)

Once all programs are forced to interact with the system through OS/2, multitasking and more become possible. OS/2 creates separate virtual machines called *screen groups*. Each machine has an entire environment: current subdirectories, screen modes, and even keyboard status. One screen group can remember that the keyboard is in uppercase mode, while another remembers that it is not.

### Legalizing TSRs

We all love TSRs (terminate-and-stay-resident programs). They're handy. They extend PC capabilities. At the same time, we hate them because they gobble memory, they can't be easily removed from memory once loaded, and they don't get along well with other TSRs.

SideKick is a prime example of what we love and hate about TSRs. It insists on being the last TSR loaded. Every timer tick (18.2 times per second), SideKick checks to ensure that it is the last one loaded. If it finds another TSR after it, it tries to muscle it aside. This often means

that the keyboard no longer responds and the system crashes. SideKick tries to deal with the memory problem by removing itself from memory on request, but it doesn't always work, especially if SideKick isn't the last TSR loaded or if you're not at the DOS prompt.

What does OS/2 offer? OS/2 has a means to make TSRs legitimate. It's called a *device monitor*. It's like a TSR, and it can act as a filter on a keyboard. Device monitors improve on TSRs, however, in that they can request that OS/2 ensure that they are essentially the last (or first) device monitor loaded. OS/2 rejects an attempt to load two device monitors that insist on being first or last.

Also, device monitors can be unloaded from memory. A nice example of device monitors appeared in Ray Duncan's "TSRs Past and Future: MS-DOS and OS/2" in BYTE's *Inside the IBM PCs*, Fall 1987.

### A Platform for Peripherals

Recently, I bought a new printer, a Hewlett-Packard LaserJet II. The excitement faded a bit when I realized that I would have to reinstall several dozen programs, informing them all of the new printer type. OS/2 reduces this pain. A certain measure of device independence is afforded by version 1.0. A greater amount is provided by the Presentation Manager under 1.1. (The main difference between 1.0 and 1.1 is the graphical Presentation Manager.)

Microsoft Windows gives a preview of this device independence. The Windows installation program asks what kind of printers will be used. Drivers for the printers that you specify load in the Windows subdirectory. Then, at any point in the future, you can select a new printer in a few seconds via the Control Panel. From that point on, any Windows applications will talk to the new printer; you need not inform each application of the new printer. In this way, Windows is device-independent. The Presentation Manager—which is essentially Windows for OS/2—offers the same kind of device independence.

Of course, OS/2, like all operating systems, seeks to let programs built on one machine (e.g., an IBM AT) run on another machine (e.g., a Zenith Z-386). OS/2 1.0, without the Presentation Manager, acts like DOS: Applications will require special installation programs.

### Open System Interfaces

DOS has a number of useful programming features that Microsoft uses in its programs but won't own up to. This, un-

**Listing 1:** This simple program allocates an integer array, fills it up, and then reports total execution time. See table 1 for a comparison of results using different-size arrays running under OS/2.

```
rem examines virtual memory. Needs /ah compiler switch
defint a-z
rem $DYNAMIC
input "array dimension";ad
c$=time$
dim a(ad,ad)
for i = 1 to ad
  for j = 1 to ad
    a(i,j) = 100
  next
next
b$=time$
print "start: ";c$;" end: ";b$
```

**Table 1:** Results of the program in listing 1 running under OS/2 and using different-size arrays.

Array size (no. of elements)	Array size (K bytes)	Execution time (seconds)	Time to process each byte
100	20	0	0.00
200	80	1	0.01
300	180	4	0.02
400	320	7	0.02
500	500	5487	10.97
600	720	10467	14.54

derstandably, makes software vendors jittery, as Microsoft not only writes the platform that their wares run on but often writes the programs that are those vendors' main competition.

Microsoft claims that OS/2 puts an end to undocumented system interfaces. All the hooks that a system programmer would need (well, most of them) are available to developers with the Application Programmer Interface (API). Microsoft technical support claims that there are enough APIs to allow anyone to write his or her own Session Manager. Things that are difficult under DOS, like TSRs or interprogram communication (to name but a few), are directly supported with an OS/2 API call.

OS/2 will be a welcome step up for many DOS programmers, but it will require some getting used to. OS/2 programmers will have to think in an entirely new fashion when structuring code. For example, a word processor is composed of two programs—a text editor and a text formatter. An OS/2 word processor could be structured as a foreground program (the text editor) and a background program (the text formatter). A spreadsheet could be designed as a data-entry process running concurrently with a recalculating process.

### OS/2 Tip of the Month

If you're going to use a mouse, you need two device drivers—one for the whole idea of pointing, another for the specific mouse. If you're going to use the Presentation Manager, you need yet another mouse driver for it.

The drivers must be installed in a particular order, or they won't work—first the pointer, then the specific mouse driver, then the Presentation Manager driver. For example, with a serial mouse (the MOUSEA02 driver):

```
device=pointdd.sys
device=mousea02.sys
device=pmdd.sys
```

If you have a serial port, add its driver after all the above ports. Its driver name is COM01.SYS for non-PS/2 machines and COM02.SYS for PS/2s. ■

*Mark Minasi is a managing partner at Moulton, Minasi & Company, a Columbia, Maryland, firm specializing in technical seminars. He can be reached on BIX as "editors."*

*Your questions and comments are welcome. Write to: Editor, BYTE, One Phoenix Mill Lane, Peterborough, NH 03458.*





# Tomorrow's LAN Solutions – Today.

## EtherLAN Plus™/The Affordable Ethernet Solution

In today's LAN world, every new LAN manufacturer seems to have a new idea of what a network should be. Standards for the industry are few and far between, but are there if you want to pay for them. Wouldn't it be nice if for once you could buy a LAN system, at a price you can afford, and be fully compatible with the ethernet standard? Well now you can!

### Turn Key Ethernet

EtherLAN is here to give you everything you need to set up an ethernet LAN system. You'll receive the EtherLAN network adapter, 25 feet of thinwire ethernet coax cable, T connector and easy to understand Installation and User's Guides, all for one low price. In addition to this, you'll also receive complete software needed to get your new EtherLAN system up and running quickly. You'll get NETBIOS software and also a complete network operating system to make using your new EtherLAN system even easier.

### SimpleWARE™ Makes EtherLAN Unbeatable

The operating system you'll get works as a shell above DOS, so all your normal DOS programs will run on EtherLAN as well as locally.

146 BYTE • SEPTEMBER 1988

Even better yet, you can use standard DOS commands to control your network, so you are not stuck spending hours to learn a new set of commands. The operating system functions transparently, so you won't even know you're on a network.

### Features You Can Rely On.

- Fully ethernet and cheapernet compatible (IEEE 802.3).
- Fast — a full 10,000,000 bit per second.

- Low memory requirements.
- NETBIOS compatible.
- Everything you need is included at one low price.

### The best news of all is the price.

At only \$699.95 per node, you get all hardware, software, cabling and manuals needed.

### Introductory Offer

Four Node Kit for only \$2499.00. Save over \$300.00.

**With features like these, and an affordable price per node, how can you lose?**

### Call Toll Free

**1-800-262-8010**  
1-714-529-8850 (in CA)



VISA, M/C, COD, or Prepaid orders accepted.



### Simple Net Systems, Inc.

545 W. Lambert Rd., Suite A  
Brea, CA 92621  
FAX: (714) 529-2413

Requires IBM PC/XT/AT or compatible, running DOS 3.10 or higher. EtherLAN is a registered trademark of Simple Net Systems, Inc. Other brand and product names are trademarks of their respective holders.

Circle 248 on Reader Service Card (DEALERS: 249)

### EtherLAN 6 Node Comparison

500 Kbytes	Read and Write	Retail
EtherLAN	11 and 10 seconds	\$4199
3Com®	14 and 12 seconds	\$5670*
Novell SFT®	10 and 9 seconds	\$8265*

\*Figures from PC Magazine.

- NO dedicated servers are required.
- Transparent operation —operates as a shell above DOS.
- Easy to use DOS type commands or pop up menus.
- Share disks, subdirectories, printers and plotters.
- DOS file and record locking.
- Up to 5 printers per server.
- Time and Date sharing.
- Electronic Message System.



# COMPUTER CONFERENCING HOMECOMING

Although still in its infancy, computer conferencing is locked into a niche market

**I**nformation is the life blood of videotex, a catch-all technology that the Videotex Industry Association defines as "easy-to-use interactive electronic services." Admittedly, that covers a lot of ground: from audiotex, which is prerecorded information delivered across the telephone line, to computer conferencing, where information is stored and shared among a geographically distributed group of people.

Historically, computer conferencing is a descendant of electronic messaging networks—like the government's Advanced Research Projects Agency Network (ARPAnet), which began simply as a huge electronic mail (E-mail) network. The first true computer conferencing system came about as a result of President Nixon's wage/price freeze controls in 1970. Known as EMISARI, it was a computer conferencing system designed to handle the time-sensitive information needed by government officials trying to manage the revolutionary executive order.

EMISARI's success proved to be both a blessing and a curse: a time-saving blessing for harried government officials, and a curse for computer conferencing systems, which forever after were set up as applications to solve highly specialized needs, instead of becoming general-purpose tools.

Today, 18 years later, computer conferencing is still in its infancy. In advertising jargon, the technology is locked into a "niche market."

## My Niche or Yours?

The number of people using computer conferencing systems has grown steadily

over the past 5 years, according to the Stanford Research Institute (SRI) study I mentioned in last month's column. Despite this growth, however, the report's author, Tom Mandel, a senior technology analyst at SRI, says "Interest in and use of (public) computer conferencing has been restricted to a relatively small fraction of the consumer population."

That small fraction actually consists of only 12 percent to 15 percent of all home PC owners. Why? Primarily because of conferencing's niche status. Like special-interest magazines—*Car & Driver*, *Soldier of Fortune*, *Fangora*, and so on—computer conferencing caters to highly focused groups.

The need for specialized information is what keeps niche magazines in business. If one magazine could satisfy an entire community of interest, then we wouldn't need publications like *Golf Digest*; everyone would be happy with *Sports Illustrated*.

So, just as there is no one magazine that covers all the needs of the sporting community, likewise, there is no single computer conferencing system that satisfies the entire computer industry.

Even large on-line services, such as BIX, are only convenient clearinghouses for hundreds of electronic niche markets. On BIX, each conference is a kind of special-interest group, a narrowly defined niche.

Given the competition for our information dollar, not to mention our time, there doesn't seem to be much of a chance that computer conferencing will break out of its niche status any time soon. Even with the introduction of highly touted all-in-one information systems, like Prodigy and U.S. Videotel, computer conferencing systems will continue to be a niche market well into the 1990's.

SRI's Mandel sees computer conferencing growth into the next decade coming from two distinct areas:

- *The spread of computer literacy. Be-*

cause the use of technologies like E-mail across local- and wide-area networks is becoming more and more a part of corporate America's daily routine, people will be less resistant to computer conferencing technology. Just as the typewriter migrated from office to home, so too will electronic messaging technologies. From E-mail, it's a short step to computer conferencing.

- *Simpler systems.* Fierce competition will push developers to design mass-market-appeal videotex systems. This will be accomplished, in part, through low-cost access and turnkey software. Most services offer free trial subscriptions. Such a strategy figures to attract lots of new users because of the negligible monetary involvement. The only risk is that of a little time.

The niche market, however, is only partially responsible for the sluggish acceptance of computer conferencing. Another factor is the technology's potential: There's too much of it.

## Too Much of a Good Thing

Federal Judge Harold Greene, who presided over the breakup of the Bell Telephone monopoly and continues to guide the level of participation by the "baby Bells" into videotex services, wrote in a March court opinion: "If consumer-oriented videotex services were made available on a large scale, the economic and social welfare of the American people could be substantially advanced. It is difficult to overestimate the significance of this potential."

While computer conferencing's potential is certainly tempting, those seduced by it have grossly oversold its potential. For example, take the following comment found on the Whole Earth 'Electronic Link (WELL), a conferencing system based in Sausalito, California:

"There are several hundred ways [computer conferencing can be used as a]

*continued*



new political technology. We can use it to end war, starvation, homelessness, confiscatory taxation, and so on.

"With the technology that you are using even as we speak, we the people can make this primordial dream a reality . . . and use this technology for good instead of evil. All of you now reading these words have been granted with the power to spread this good use of technology all around the world."

This type of rhetoric is typical of the "techno-hedonist," a term coined by Peter Grunwald, a Washington, DC-based communications consultant for organizations seeking to incorporate new technologies, such as computer conferencing, into their day-to-day routines. Grunwald defines a techno-hedonist as "a person who thinks a technology, like computer conferencing, can solve all the world's problems and walk the dog—all in the same day. A techno-hedonist makes unreasonable claims about the potential of the technology. And when the technology fails to live up to the hype, it sours anyone involved—for good—on the future use of the technology."

Grunwald points out that claims about the potential of computer conferencing, like the ones made in the above comment from the WELL, are unfortunate because "there's a good amount of truth in there, but it gets lost in the hyperbole of a techno-hedonist's evangelistic rantings." (I should note that when the above comment was first entered, it was met with incredulity and reproach by the majority of WELL users.)

The "good amount of truth" that Grunwald refers to as a potential for computer conferencing hardly encompasses ending world hunger or the homeless problem. However, it is capable of creating what he calls "legitimate communities of interest." Such communities

encompass both the private sector (e.g., corporations and organizations) and the public sector (e.g., CompuServe and BIX).

"It's up to each community of interest to define how computer conferencing fits into their daily routine," says Grunwald. "Computer conferencing doesn't solve problems. However, it can help facilitate the process used to reach a solution. A hammer can't build a house, but used in combination with all the other appropriate tools, it works just fine."

Although computer conferencing won't solve the homeless problem, it's quite possible to gather several leading sociologists into a single computer conference where they could discuss the issues, such as homelessness, without the pressures of academia that are usually associated with their discipline. This is the kind of application that Grunwald sees as a correct use of the medium. He outlines four major advantages of computer conferencing:

- **Auto-documentation.** When a comment is entered into an electronic discussion, an automatic record exists, unlike comments tossed around a boardroom. This virtually eliminates the "but I thought you said" syndrome.

- **Time savings.** Conferences can be carried on with participants across the hall or across the world. Participants contribute within the confines of their personal schedules.

Grunwald points out that computer conferencing isn't intended to replace face-to-face discussions; rather, it eliminates many of the intermediary meetings that take place to simply disseminate information.

- **Multiple tasks.** In a computer conference, you can handle several different dialogues at one sitting and respond to each

in like manner. This is impossible when talking in person.

- **Better communication.** People who might never speak up in a heated face-to-face discussion can sit back and, with the freedom of time, contribute just as much to the discussion as a more gregarious personality.

Balancing these advantages are negatives, such as the following:

- **Lack of nonverbal communication.** A nod of the head, stiff body posture, and fingers tapping on the table are all clues we send out during a discussion, and they are missing from on-line conferences. Given the absence of these clues, it's much harder to read the intent (and acceptance) of the message.

- **Lack of verbal clues.** Sighs, a rising voice, shouting, and voice inflection are all difficult to convey on-line.

- **Humor.** An offhand joke, casually tossed across the ether, often suffers something in the translation from the spoken word to ASCII. Humor must be carefully distributed and often annotated with some equivalent of the phrase "Just kidding."

- **Flame now/apologize later.** An on-line syndrome known as "flaming" occurs when users think they can yell on-line without incurring the immediate negative feedback from a group of people. This usually leads to an on-line apology later. It's a cyclical syndrome, and one that never goes away.

### The Human Factor

The common thread woven through both the advantages and disadvantages of computer conferencing is the human factor. The critical link, and perhaps the most fragile, is you, the personality be-

*continued*

## Custom Imprinted Keys, Keytop Shells, Snap-on KeyCaps™, and Keytop™ Labels

Available in a rainbow of colors for IBM and most other keyboards. Produced to your exact specifications by our competent engineering staff and precision imprinted for wear-resistance and compatibility to your present keys. Hooleon keyboard enhancements also include keytop kits, keyboard protectors, individual key lockouts, vinyl templates, keytop expanders, plus much, much more. Call or write for our free 1988 Catalog today. (602) 634-7515

... FROM THE LEADER IN  
KEYTOP INNOVATIONS

**Hooleon**  
CORPORATION

P. O. BOX 201, DEPT. BYTE  
CORNVILLE, AZ 86325



# The International Preview Society

# 3 COMPACT DISCS, RECORDS OR CASSETTES

# \$1

## for just

plus shipping  
and handling with  
Club membership

## With No Obligation To Buy Anything...Ever!

**Vivaldi, The Four Seasons** The English Concert/Pinnock. Archv DIGITAL 115356

**Horowitz in Moscow** Scarlatti, Mozart, Rachmaninov, Liszt, Chopin, Scriabin, others. DG DIGITAL 125264

**Perlman: French Violin Showpieces** Havanaise, Carmen Fantasy, Tzigane, more. DG DIGITAL 115457

**Tchailkovsky, 1812 Overture; Romeo & Juliet; Nutcracker Suite** Chicago Symphony/Solti. London DIGITAL 125179

**By Request...The Best Of John Williams & The Boston Pope** Olympic Fanfare, Star Wars, more. Philips DIGITAL 125360

**Brahms, Cello Sonatas** Yo-Yo Ma, cello; Emanuel Ax, piano. Grammy Award Winner! RCA DIGITAL 154044

**Galway & Yameshita: Italian Serenade** Flute & guitar works by Paganini, Cimarosa, Giuliani, others. RCA DIGITAL 173824

**Gregorian Chant** Schola of the Hofburgkapelle, Vienna. Hauntingly serene. Philips DIGITAL 115434

**Slatkin Conducts Russian Showpieces** Pictures At An Exhibition, more. RCA DIGITAL 154358

**Debussy, La Mer; Nocturnes** Boston Symphony Orchestra/Davis. Philips DIGITAL 115068

**Beethoven, Symphonies Nos. 4 & 5** Academy of Ancient Music/Hogwood. L'Oiseau-Lyre DIGITAL 115009

**André Previn: Gershwin Rhapsody In Blue, Concerto, An American In Paris.** Philips DIGITAL 115437

**Mozart, The Piano Quartets** Beaux Arts Trio; Bruno Giuranna, viola. "Absolutely indispensable."—Stereophile Philips DIGITAL 115271

**Teresa Stratas Sings Kurt Weill** Surabaya-Johnny, Foolish Heart, 13 more. Nonesuch 124748

**Tchailkovsky, Symphony No. 4** Chicago Symphony Orchestra/Solti. London DIGITAL 125038

**Dvořák, Symphony No. 9 (New World)** Chicago Symphony/Solti London DIGITAL 115168

**Mendelssohn, A Midsummer Night's Dream** Neville Marriner, cond. Philips DIGITAL 115548

**Ravel, Daphnis et Chloé (Complete)** Montreal Symphony/Dutoit. London DIGITAL 115520

**Mozart, Requiem** Leipzig Radio Choir; Dresden State Orchestra/Schreier. Philips DIGITAL 115039

**Pavarotti: Volare** Titta song, Serenata, 14 more. With Henry Mancini. London DIGITAL 125102

**Handel, Water Music** Eng. Concert/Pinnock Archv DIGITAL 115306

**Rossini, Overtures** Barber Of Seville, Tancredi, 6 more. Orpheus Chamber Orch. DG DIGITAL 115527

**Horowitz Plays Mozart** Concerto No. 23 & Sonata No. 13. Giuliani conducts. DG DIGITAL 115536

**Eine kleine Nachtmusik** Plus Pachelbel Canon, more. Marriner conducts. Philips DIGITAL 115530

**The Canadian Brass: High, Bright, Light & Clear** Baroque gems. RCA DIGITAL 144529

**Bach, Goldberg Variations** Trevor Pinnock, harpsichord. "Definitive."—Stereophile Archv 105318

**Rachmaninov, Piano Concertos Nos. 2 & 4** Vladimir Ashkenazy. London DIGITAL 125074

**Holst, The Planets** Montreal Sym./Dutoit. London DIGITAL 115448

**Handel, Messiah (Highlights)** Musica Sacra/Westerburg. Hallelujah Chorus, more. RCA DIGITAL 153586



**This remarkable \$1 offer is being made to introduce you to an outstanding classical music membership—with never any obligation to buy.**

You'll find hundreds of outstanding albums in each issue of the Society's magazine, which will be sent to you approximately every 3 weeks. That gives you 19 convenient, shop-at-home opportunities a year. But there is no obligation to accept any offering at any time.

### You choose only the music you want!

If you'd like to accept the Main Selection, you need not do a thing. It will be sent automatically. If you'd prefer an alternate selection or none at all, just mail back the Notification Card by the specified date. You'll always have at least 10 days to decide.

### Substantial savings with our half-price bonus plan.

For every regular purchase you do make, you'll receive bonus certificates good for half-price discounts. A shipping/handling charge is added to each shipment.

### 3 Compact discs or records or cassettes for just \$1!

Begin your membership now by choosing any 3 albums shown here for just \$1 plus shipping and handling. Send no money now. We want you to judge for yourself before you decide to buy. If not delighted, return your 3 albums at the end of 10 days without obligation.

# SAVE 50%

## INSTANT HALF-PRICE BONUS PLAN

You'll receive bonus certificates for each album you order. Use them to get additional albums at half price!

The International Preview Society  
P.O. Box 91406 • Indianapolis, IN 46291

YES! Please accept my membership in The International Preview Society and send me, for 10 days' FREE examination, the 3 albums I have indicated below. I may return them after 10 days and owe nothing, or keep them and pay only \$1 plus shipping & handling. I understand that I'm not obligated to buy anything...ever!

Please send all selections on  Compact Disc  Cassette  Record

Write Selection Numbers Here:

--	--	--

Mr.  Mrs.  Miss \_\_\_\_\_  
First Name Initial Last Name (PLEASE PRINT)

Address \_\_\_\_\_ Apt. \_\_\_\_\_

City \_\_\_\_\_ State \_\_\_\_\_ Zip \_\_\_\_\_

Telephone ( \_\_\_\_\_ ) \_\_\_\_\_  
Area Code

**NOTE:** Members who select compact discs will be serviced by the Compact Disc Club. Full membership details will follow with the same 10-day, no-obligation, no-minimum purchase privilege.

Limited to new members, continental U.S.A. only. One membership per family. We reserve the right to request additional information or reject any application. Local taxes, if any, will be added.

PY7

BF

XJFY7

PJ



## ARABIAN AMERICAN OIL COMPANY

The Arabian American Oil Company continues the high standards of an industry leader. We are seeking highly qualified professionals to join us in Saudi Arabia.

If you're an upstream computer analyst in any of the following areas, and possess a related BS degree along with 5+ years' experience, you should consider us.

COMPUTER PROGRAMMING	EXPLORATION APPLICATION SYSTEMS
COMPUTER TRAINING	COMPUTER END USER
PETROLEUM ENGINEERING	COMPUTER OPERATIONS
SYSTEMS	COMPUTER HARDWARE

With the Arabian American Oil Company, you will discover large-scale technology that will challenge you professionally. For confidential consideration, please send your resume to: ASC, Employment, Dept. 06E-020-8, P.O. Box 4530, Houston, Texas 77210-4530.

## THE STANDARDS IN FORTRAN

**LAHEY PERSONAL FORTRAN 77 (Version 2.0)** **\$95**  
Full 77 Standard, Debugger, Fast Compilation, Math Emulation

**F77L FORTRAN LANGUAGE SYSTEM (Version 3.0)** **\$477**  
For porting or developing, this is the critics' choice.

"Editor's Choice" . . . . . *PC Magazine*  
". . . the most robust compiler tested." . . . . . *Micro/Systems*  
". . . the most efficient and productive FORTRAN  
development tool for the DOS environment!" . . . . . *BYTE*

**F77L-EM/16-BIT (Version 1.1)** **\$695**  
Break through the DOS 640K barrier. Programs up to 15MB on 80286s.

**F77L-EM/32-BIT (Version 1.0)** **\$895**  
The most powerful PC Fortran Compiler for downloading or writing large programs. Designed for maximum performance on 80386s.

### PRODUCTIVITY TOOLS

Profiler, ULI Mathematical Functions Library, Overlay Linker, Toolkit, Spindrift Libraries, Memory Boards, 80386 HummingBoard, DOS OS Extenders.

**IF YOU DEMAND THE VERY BEST, THEN YOU SHOULD BE USING LAHEY.  
CALL US TO DISCUSS YOUR PC FORTRAN NEEDS.**

**FOR INFORMATION OR TO ORDER:  
1-800-548-4778**

30 DAY MONEY-BACK GUARANTEE  
**Lahey Computer Systems, Inc.**  
P.O. Box 6091, Incline Village, NV 89450  
TEL: 702-831-2500 TLX: 9102401256  
FAX: 702-831-8123



hind the message. It is a factor too often overlooked.

The act of putting your thoughts on-line, in a semipermanent environment, might seem disconcerting. Indeed, a state senator I interviewed once told me that, although he sees great potential in computer conferencing, he would never use it himself. Why? "My every word and thought would be a matter of *printed* public record," he said, "and I'm not sure I'm willing to take that much risk."

To help along the human factor, Walter Orr Roberts, the founder of the National Center for Atmospheric Research and an unselfish pioneer in helping to establish computer conferencing links with the Soviet Union's scientific community, has developed several protocols for participants in his computer conferences. Among the most important of these are the following:

- Encourage people to practice using the system. The old adage "Practice makes perfect" is certainly applicable in the computer conferencing world.
- Develop a buddy system. This gives newcomers someone to go to when they have questions or need some moral support.
- Overcome the fear of typing. Typing speed is of little importance, yet lack of typing skills keeps people from contributing.
- Eliminate grammatical and typographical issues. Spelling and sentence structure are of only secondary concern; ideas and participation from all involved are the important factors.

### Next Up

Next month I'll look at Prodigy, one of the new videotex systems that have spared no expense to address the critical human factor. Such systems are out to appeal to the common denominator of success: you, the user.

From celebrity endorsements to free subscriptions, these systems are serious about bringing videotex (including computer conferencing) into your household. And perhaps, more important, the households of your neighbors. After 18 years, I think it's a homecoming long overdue. ■

*Brock N. Meeks is a San Diego-based freelance writer who specializes in high technology. You can reach him on BIX as "brock."*

*Your questions and comments are welcome. Write to: Editor, BYTE, One Phoenix Mill Lane, Peterborough, NH 03458.*

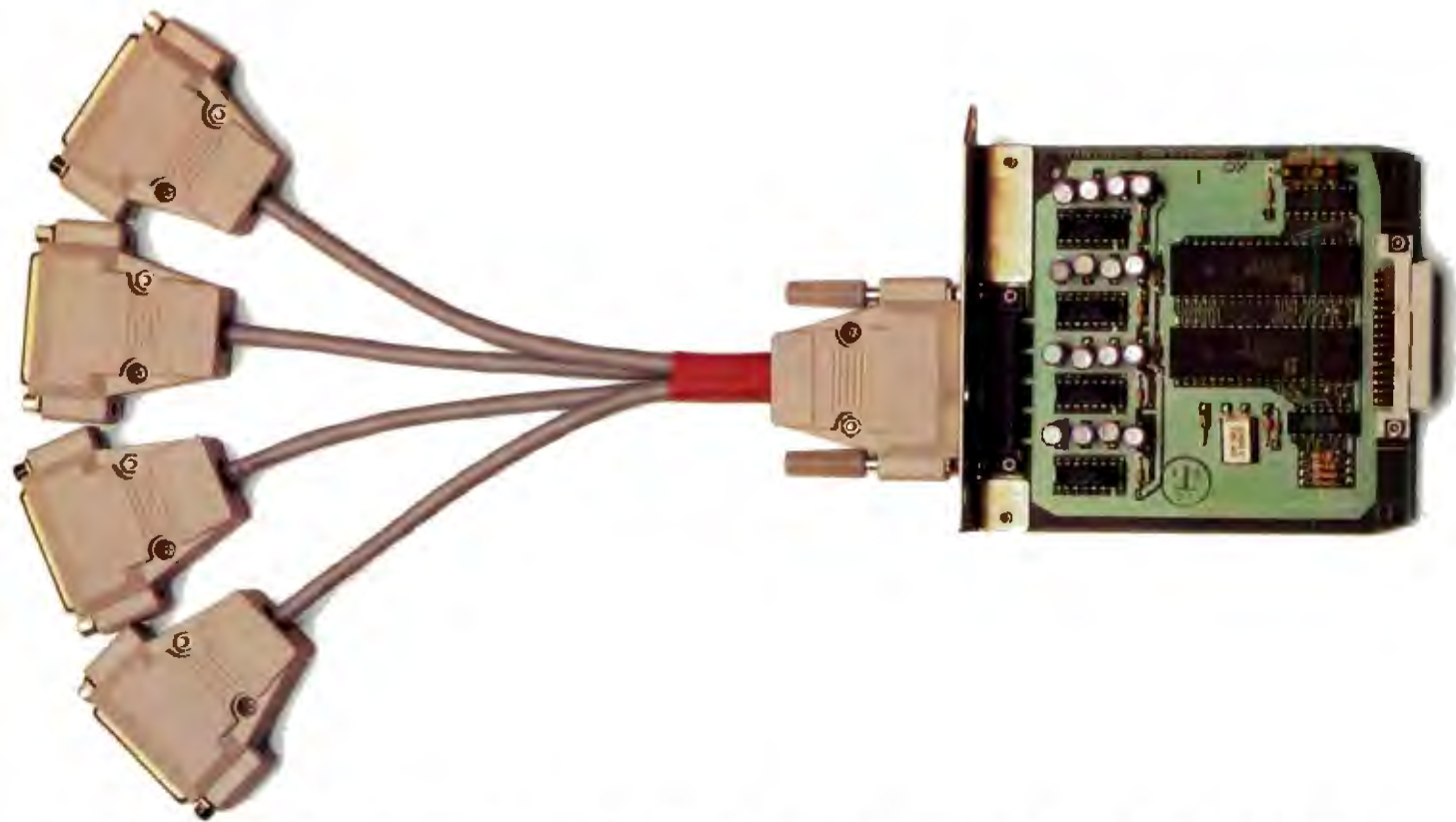

# NOW YOU CAN CONNECT FOUR USERS TO ONE LASER PRINTER.



With the Mannesmann Tally® MT910 Laser Printer and its Multiuser Interface option, you can connect four users for just \$1050 each.

Each of you will have your own I/O port, programmable for your own protocol and emulation. Laser-crisp text and graphics at 300 dpi. All the specs you see in the center. And with an optional 5-bin sorter, even your own output bin.

## THIS ONE.

- Speed: 10 pages-per-minute
- Dual paper cassettes standard, 250 sheets each.
- Dual output bins standard, 250 sheets each.
- Memory: 500K; 400K available to print graphics or download additional fonts.
- Manual feed handles single sheets, envelopes, transparencies, and labels.
- Emulations: Diablo® 630, Epson® FX, IBM® Proprinter,™ HP® LaserJet Plus,™ and Qume® Sprint II.
- Workload: 10,000 pages-per-month.
- Standard fonts:  Courier 10.  Prestige Elite 12  Letter Gothic 16.6  bold, italic, condensed, and expanded.
- Options:  4-user I/O  extensive library of optional fonts in cartridge or downloadable formats  1.5 Mg RAM upgrade  5-bin sorter.

So call the number below for more information or to connect with your nearest dealer.

And he'll connect you with the only out-of-the-box laser printer on the market today that gives you so much for just \$1050 per user.

A Mannesmann Tally.

**MANNESMANN  
TALLY**  
**1-800-843-1347** Ext. 148

In Washington state, call:  
206-251-5524 Ext. 148







# You Can Never Be Too Powerful Or Too Thin.

As portable PCs go, ours may look a bit on the skinny side. But they're by no means undernourished.

After all, each 286 and 386 powered Toshiba portable has an easy-to-read gas plasma screen. Each is IBM-compatible. And each gives you a wide range of features you'd expect only from a desktop PC.

The T3100/20, for example, weighs a scant 15 pounds, yet has an abundance of power. It comes with an 80286 microprocessor and 640KB of RAM that's extendable to 2.6MB. Plus, there's a built-in 20MB hard disk.

Our T3200 has the advantages of a 12MHz 80286 microprocessor, an EGA display system, a 40MB hard disk and 1MB of RAM expandable to 4MB. Also, its two IBM-compatible internal expansion slots let you connect your PC to mainframes, LANs and more. But what's even more impressive is how we managed to fit all this into a slim, 19-pound package.

Then there's our T5100. As amazing as it seems, we managed to squeeze a 16MHz 80386 microprocessor into a slim package that weighs less than 15 pounds. To that we added an EGA display system and a 29

msec 40MB hard disk. As your thirst for power grows, its 2MB RAM can be upgraded to 4MB. And for a limited time, your T5100 purchase entitles you to buy the powerful Paradox 386® database software for only \$299 (nearly \$600 off the retail price).

For more information on Toshiba computers and printers, call 1-800-457-7777. And rest assured that whichever Toshiba PC you choose, you'll be getting the kind of power once reserved for cumbersome desktop computers.

All of which proves you can maintain a position of great power without having to throw a lot of weight around.

Toshiba PCs are backed by the Exceptional Care program (no-cost enrollment required). See your dealer for details. IBM is a registered trademark of International Business Machines Corp. Paradox is a registered trademark of Borland Corp.



In Touch with Tomorrow  
**TOSHIBA**

Toshiba America Inc., Information Systems Division



# IBM and Tandy:

IBM's Model 70-A21 supplies 25-MHz performance in a Model 50 housing. Tandy's 5000 MC provides IBM Micro Channel-compatible slots. Both offer a unique design for future growth.

**I**f you have any doubt that 32-bit microprocessors have answered a real need in desktop microcomputing power, take a look at the trend: The first 80386-based microcomputers, introduced in 1986, ran at a clock speed of 16 MHz. Nearly a year later, such systems were operating at 20 MHz, and caching hardware, used to maximize the throughput of these faster processors, became common. This year, various computer manufacturers raised the ante for top-of-the-line performance to 25 MHz (see "25-MHz Computing Buzzsaws" by Rick Grehan, August).

But unless your budget has grown along with your processing needs, you've got a problem. If you already own a 16-MHz 80386-based system, you must sell it before you can hope to afford a higher-performance 20- or 25-MHz system. Worse yet, if your processing needs have grown so rapidly that they require a faster system already, where will they and the computer industry be in a year? Will you have to sell the faster system you're trying to obtain now for next year's model?

IBM and Tandy offer a unique solution to the problem of ballooning processing needs that outstrip the power of today's systems. In a remarkable coincidence of



design, both companies' latest systems—IBM's PS/2 Model 70-A21 and Tandy's 5000 MC—feature a removable "processor card." Simply put, the computer's CPU components are mounted on a plug-in board. Although neither company would talk about future plans, both admitted that the intent of this design is to enhance the performance of these systems at a later date by swapping the processor card.

The Tandy 5000 MC provides another significant feature: It's the first microcomputer that offers a bus whose signals and timing are 100 percent compatible with IBM's PS/2 Micro Channel bus.

## IBM's PS/2 Model 70-A21

When IBM announced its line of PS/2 systems last year, it was obvious that the series had at least one gaping hole: In the progression from a desktop 80286-based Model 50 to a floor-bound 80386-based Model 80, there was something missing: a desktop 80386-based system. This June, IBM lived up to everyone's expectations and plugged the hole with the PS/2 Model 70.

On the outside, the Model 70 looks exactly like its desktop cousin, the Model 50, with the same small footprint and

# Same Channel, Same Plan for Growth



light weight. Inside the machine, the resemblance to the Model 50 ends. The Model 70 uses an 80386 CPU (versus the 80286 for the Model 50) and a larger hard disk drive (your choice of a 60-megabyte drive with a 27-millisecond access time or a 120-megabyte drive with a 23-ms access time, versus the Model 50's 20-megabyte drive). The Model 70 has three Micro Channel slots: two 32-bit slots and one 16-bit slot. The Model 50 has four 16-bit slots, one of which is occupied by a hard disk controller card. The Model 70 gets away with three slots since the disk controller is integrated with the disk drive. This version of the

Model 70 comes with 1 megabyte of RAM that's expandable to 6 megabytes on-board, and, using Micro Channel memory boards, you can add RAM to a maximum of 16 megabytes. At the June announcement, you could get the PS/2 Model 70 with either 16-MHz components (the Model 70-E61, with a type-1 system board) or 20-MHz components (the Model 70-121, with a type-2 system board).

In September, the high-end version of the Model 70 became available: The Model 70-A21 features 25-MHz components (an 80386 CPU and an optional 80387 numeric data processor [NDP]) and a 64K-byte RAM cache based on the

Intel 82385 cache controller chip. The 120-megabyte hard disk drive is standard. The system board comes with 2 megabytes of on-board 80-nanosecond RAM and is expandable to 8 megabytes. Micro Channel memory cards still allow you to expand RAM to the 16-megabyte maximum. The most significant difference between the Model 70-A21 and the other Model 70 machines is its type-3 system board, which has an additional connector for on-board RAM (providing the 8 megabytes of on-board RAM versus the 6 megabytes of the other Model 70 systems) and the processor card.

With all this going for it, the Model 70-A21 ought to be the fastest of the PS/2 line of machines and possibly one of the fastest on the market. To verify this, we obtained an early preproduction unit of the Model 70-A21 and set it up for a complete round of tests in our BYTE Lab. It came equipped with 16 megabytes of RAM, an 80387 math coprocessor, and PC-DOS 3.30 installed on the hard disk.

Sure enough, with the exception of the color of the power switch (it's now white instead of red) and the marking on the nameplate, you would think the machine was a Model 50. As with the Model 50, you can easily remove the Model 70-A21's cover by loosening two easy-to-access thumbscrews at the rear of the machine. A quick glance through the support bracket (which holds the disk drives) reveals the 32-bit nature of the beast: an 80386 CPU.

IBM has done considerable chip integration, distilling most of the components that make up a Model 80 system board to fit a Model 50 system board and adding a caching system at the same time. Nevertheless, it seems to have been a tight fit: Several chips have been placed on tiny daughterboards that rise up vertically from the system board.

The PS/2 system design makes it easy to disassemble the computer to replace or get a good look at a particular compo-

*continued*



ment. It took only moments to unplug the disk drives, pop up seven snaps, and remove the support bracket to expose the system board and processor card (see photo 1). Located near the processor card are four memory modules that closely resemble single in-line memory modules (SIMMs). Each memory module clips into a socket on the system board and is packed with chips on both sides. For the Model 70-A21, each mod-

ule contains 2 megabytes of 80-ns parity-checked RAM. The preproduction system came stuffed with the maximum 8 megabytes, but it will ship with just one module, or 2 megabytes, of RAM. You can buy additional 2-megabyte memory modules for \$1495, a reasonable price considering today's memory market. The additional 8 megabytes of RAM on the preproduction unit were provided by a 32-bit Micro Channel memory card.

Four clips hold the processor card, which contains the 80386, an 80387 socket, an 82385 cache controller, and 64K bytes of 30-ns cache RAM. The 82385 implements a write-through cache (i.e., as the processor writes to RAM, the cache controller writes to both its cache and system memory to keep the two identical), and IBM used some special hardware to double the cache size from 32K to 64K bytes.

To remove the processor card, you simply unfasten the clips and gently unplug the card from its socket on the system board. One nice thing about this arrangement is that it makes the elevated 80387 socket easier to reach. You open the Model 70's hood, remove a disk drive from the support bracket, and plug the 80387 into its socket. IBM says that a 25-MHz math processor should be available by the time the Model 70-A21 ships. But be prepared for the hefty price: \$2395.

When we turned the system on, it was quite impressive to watch the memory-check display ripple through all 16 megabytes of memory. Naturally, under DOS 3.30, the system saw only 640K bytes of RAM, and the hard disk was divided into four 32-megabyte partitions. We didn't run any software compatibility tests; after all, this is the machine that sets the standard by which all software and hardware compatibility is measured. We did open the hood and try an assortment of Micro Channel cards in the slots: a Ventel 24/2 2400-bit-per-second modem card, a USRobotics Courier 2400/PS 2400-bps modem card, and an IBM high-resolution 8514/A display card. When the system was turned on, the Programable Option Select (POS) software on the reference floppy disk drive detected the new cards in the slots and went through its configuration sequence to integrate the cards into the system. This process went smoothly, and the cards worked reliably, as expected.

Handy tip: Copy the .ADF option files from the floppy disk supplied with an expansion card to your reference floppy disk before adding it to the system. This way, you'll only have to go through the configuration sequence once. Otherwise, you can only configure the cards that have option files on the reference floppy, reboot, copy the option files from each card's floppy to the reference floppy, reboot, and finally configure the remaining cards into the system. While POS is supposed to eliminate fiddling with jumpers to set a card's address space or interrupts, it can in some circumstances make getting the system started a major headache.



**Photo 1:** The inside of the IBM Model 70-A21. At the front, mounted on four white brackets, is the removable processor card. The 80386 CPU, 80387 NDP (if present), 82385 cache controller chip, and 64K bytes of cache RAM are located on this card. Immediately to the left of the processor card is 8 megabytes of SIMM-mounted system-board RAM.

**Table 1:** The performance of a preproduction IBM Model 70-A21 compared with other 25-MHz 80386-based microcomputers. While not as fast as the Everex system, the Model 70-A21 was faster than the Compaq Deskpro 386/25 in certain tests.

CPU	IBM PC AT	Everex Step 386/25	Compaq Deskpro 386/25	IBM Model 70-A21
<b>Matrix String Move</b>	11.69	2.44	2.47	2.49
Byte-wide:	80.41	16.02	25.01	18.92
Word-wide:				
Odd-bnd.	80.41	20.01	25.65	23.69
Even-bnd.	40.26	8.02	12.51	9.47
<b>Sieve</b>	73.65	15.25	15.25	15.24
<b>Sort</b>	84.39	11.44	11.45	11.48

Note: Version 1.1 Small-C benchmarks used. All times are in seconds.



Of course, the most important feature of the Model 70's class is its performance. We ran version 1.1 of the BYTE Small-C benchmarks on the Model 70-A21 to measure this capability. Since we were working with a preproduction model, we used only the CPU benchmarks. The results shown in table 1 indicate that the Model 70-A21 is indeed the fastest of the IBM line. Compared to the rest of the market, the Model 70-A21 wasn't the fastest 25-MHz system, and, in some instances, it was slower than certain 20-MHz systems, including those from Advanced Logic Research, Compaq, and Dell.

**Tandy's 5000 MC**

Like a brash Texas oilman at a New York society ball, Tandy chairman John Roach surprised everyone last year by announcing that Tandy could easily overcome any technical or legal obstacles to cloning IBM's new Micro Channel architecture (MCA). This year, with the introduction of its high-end performer, the Tandy 5000 MC, the company put its money on the line.

Why duplicate the IBM Micro Channel? Tandy gave the same reasons IBM did when it first introduced the bus: It has a higher bandwidth and can support multiple processors. Of course, most of the Micro Channel's potential has yet to be realized, but that should change as multitasking operating systems such as OS/2 begin to dominate the market. At any rate, Tandy is betting—like IBM—that at some point having this bus architecture in its machines will prove to be worthwhile.

Even on its specifications alone, the new Tandy system is quite a tempting machine. The system features a 20-MHz 80386 processor with a 32K-byte cache, a 1.44-megabyte 3½-inch floppy disk drive, VGA-compatible graphics, and five IBM MCA-compatible slots. It is, of course, the first IBM MCA-compatible system to become available on the market, and it is also the least expensive system of its type at a base price of \$4999. And for a brief time—until the IBM Model 70-A21 became available—it was also the fastest IBM MCA-compatible system on the market.

The Tandy 5000 MC comes in an enclosure that's slightly larger than an IBM PS/2 Model 50. But, unlike the Model 50, it has room for four user-accessible storage devices, including two half-height 5¼-inch-style devices. This allows you to add a 5¼-inch floppy disk drive and tape cartridge unit, as well as

3½-inch floppy and hard disk drives. You switch on the computer's power by pressing a green button on the front panel of the machine. A small hardware reset button, located on the left side of the front panel, makes recovery from particularly nasty system crashes (the type that won't respond to the Ctrl-Alt-Del key combination) painless. Why this handy feature has never appeared on many other systems is a mystery to us.

Of course, the most interesting part of the 5000 MC lies within the system cover. You'll need a Phillips-head screwdriver to remove the three screws that fasten the cover to the backplane; we miss the handy thumbscrews on the IBM PS/2 systems. Inside, you'll find a wide variety of slots (photo 2): a "CPU slot" for the processor card, five IBM Micro Channel-compatible slots (two 32-bit

*continued*

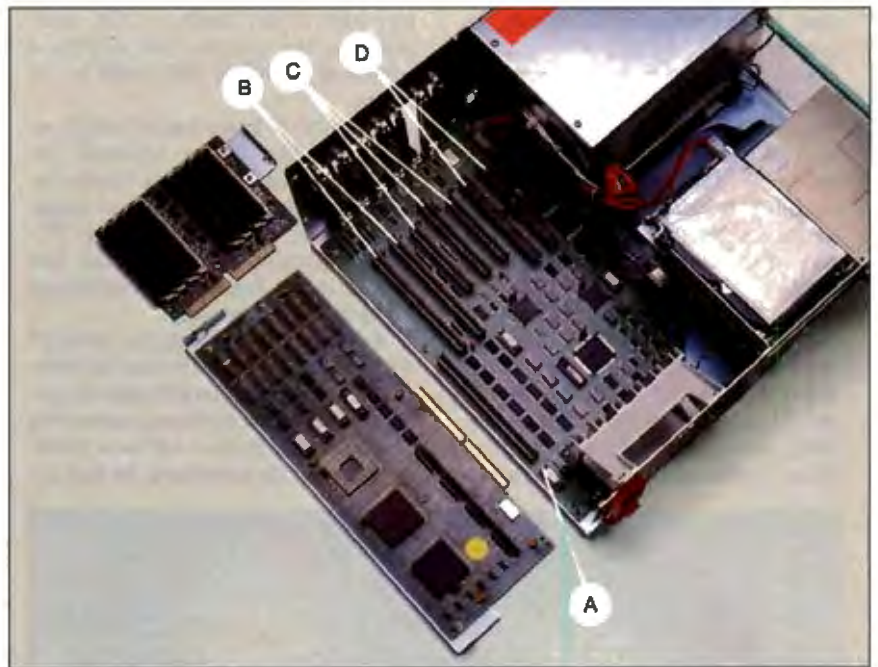

**Photo 2:** The inside of the Tandy 5000 MC. Upper left: a Tandy system memory board. The board holds 2 or 8 megabytes of RAM, depending on the density of the RAM SIMMs mounted on the board. Center: The processor card, with 80386 CPU, 82385 cache controller chip, math coprocessor socket, and 32K bytes of cache RAM. Right: the 5000 MC chassis and system board: (a) the "CPU slot" for the processor card; (b) 32-bit IBM MCA-compatible slots; (c) 16-bit IBM MCA-compatible slots; and (d) 32-bit system memory slots.

**Table 2:** The performance of a preproduction Tandy 5000 MC compared with other 20-MHz 80386-based microcomputers. The 5000 MC was the fastest 20-MHz system we've looked at.

CPU	IBM PC AT	IBM PS/2 Model 80-111	Compaq Deskpro 386/20	Tandy 5000 MC
<b>Matrix</b>	11.69	4.75	3.06	3.04
<b>String Move</b>				
Byte-wide	80.41	39.51	26.11	23.65
Word-wide:				
Odd-bnd.	80.41	39.09	31.01	29.62
Even-bnd.	40.26	19.66	13.07	11.85
<b>Sieve</b>	73.65	29.11	23.18	19.10
<b>Sort</b>	84.39	33.11	26.89	14.36

Note: Version 1.1 Small-C benchmarks used. All times are in seconds.



# Tandy's 1000 Learns to Speak and Listen

“Meet George Jetson. . .” Thus spake the newest Tandy systems. Or rather, thus sang the systems. A few weeks ago, Tandy introduced two new versions of its popular Tandy 1000 line. In addition to a number of other features, the new systems feature analog/digital circuitry that allows them to digitize and replay sounds and music. As in the above case of the theme song from the TV show “The Jetsons,” it can even play back music digitized on other hardware—on a Macintosh, for example.

Both systems are replacements for previous low-end systems from Tandy. The new Tandy 1000 SL replaces the 2-year-old 1000 SX, and the new 1000 TL replaces the Tandy 1000 TX. The sound capability is clearly the most notable feature that the new systems share, but there are a number of other interesting features as well.

Like Tandy's entry-level 1000 HX, the new systems have a ROM drive that includes DOS. But while the HX has only 128K bytes of ROM, the new SL and TL each have 512K bytes. The ROM is used to store a number of things, including DOS 3.3, a new ver-

sion of Tandy's DeskMate integrated software, and even a spelling dictionary. The advantage of having DOS on a ROM chip is that you can immediately boot up the system without worrying about finding a system disk and the time it takes to load the system from the disk.

Both systems also have better video interfaces. Like the Leading Edge Model D, the Tandy systems now support Hercules-style graphics when connected to a low-cost monochrome monitor. And if you attach a CGA color monitor, the systems will display a resolution of 640 by 200 pixels by 16 colors.

A number of lesser details include an AT-compatible 101-key keyboard. On the back panel, Tandy has finally included a serial port as standard equipment. Inside, each system has five PC-style expansion slots, but each slot follows in the Tandy 1000 tradition of being only 10 inches long.

As for software, Tandy has included with the system a new version of DeskMate. This version has a number of new capabilities and is more compatible with DeskMate application software developed by outside companies. In fact, for

low-cost systems, the DeskMate operating environment will almost undoubtedly be a very popular alternative to Microsoft Windows in the low-cost 8088/8086 market.

There are some differences between the systems. The \$899 SL features an 8-MHz 8086 and a 360K-byte 5¼-inch floppy disk drive, and it has only 384K bytes of memory, expandable to 640K bytes. In contrast, the \$1299 TL features an 8-MHz 80286, a 720K-byte 3½-inch floppy disk drive, a real-time clock, and 640K bytes of memory, expandable to 768K bytes.

But clearly the most interesting feature of the new systems is their sound capability. Both the SL and TL have an 8-bit A/D converter (ADC) as well as an 8-bit D/A converter (DAC). The converters are capable of sampling at rates of 5, 500, 11,000, and 22,000 samples per second, and they have direct memory access capabilities for transferring sound data quickly back and forth to disk. For sound input, both systems have a microphone jack. For output, there is an earphone jack with a volume control, as well as the system's standard loudspeaker.

To access these sound capabilities, Tandy has enhanced its DeskMate software with two additional applications. A program called Sound allows you to record a 30-second sound, display its waveform, play it back, and edit it. On the reproduction unit that Tandy showed us, the played-back sounds had the fidelity of sounds produced on a Macintosh. The second program, Music, lets you play music using voices sampled or created with the Sound program. One example we heard was a version of the omnipresent Pachelbel's “Canon.”

The new ADC and DAC circuitry appears to be one more step toward providing the popular features of non-IBM systems in a low-cost IBM-compatible environment. Tandy had already provided a Mac-style graphical user interface via its DeskMate software. Now it supplies sound capabilities similar to that of the Mac and the Amiga. It is probably no coincidence that this new feature has some of the same sampling rates as those used by the DAC on the Macintosh. For developers who are interested in these possibilities, Tandy will soon be providing a toolkit.

To be sure, the new sound capabilities will probably find little use in the average office, but they appear to be a perfect low-cost perk for home systems.



Two new low-end Tandy systems, the Tandy 1000 TL (left) and the 1000 SL (right). Both feature new sound capabilities. The TL is displaying a new application included with Tandy's DeskMate software, called Sound. The software lets you record, edit, and play back any captured audio sound. The SL is displaying a graphics application included with DeskMate.



slots and three 16-bit slots, one with the video bus connector), and two 32-bit memory slots for Tandy memory cards.

The most significant feature of the 5000 MC is that all its CPU-related parts have been moved to a separate card. This card incorporates a 20-MHz 80386, an 82385 cache controller chip, a math coprocessor socket, the 32K-byte 35-ns cache memory, and a 40-MHz system oscillator. The math coprocessor socket accepts either an 80387 NDP or a single-chip version of the Weitek WTL 1167. This card plugs into the CPU slot on the system board. The setup is remarkably similar to that used on the IBM Model 70-A21, and, as is the case with the IBM system, it immediately suggests that this processor card can be replaced with a faster one. Tandy said that by adding a faster 80386, oscillator, cache memory, and system memory, the company had easily run the system at 25 MHz.

The 5000 MC comes standard with 2 megabytes of 100-ns parity-checked RAM. All system memory resides on a memory card that mounts in one of two proprietary memory slots. This memory card can accommodate either 2 or 8 megabytes of RAM, depending on whether you use 256K-byte or 1-megabyte SIMMs. The RAM on these cards is accessed in paged mode. The memory card is almost identical to the one used in the Tandy 4000; only one minor change was made in the card so it can be used in the new Tandy 3000 NL 80286-based system (see the text box above). If you need more memory, you can add a second such card, providing a total RAM capacity of either 4 or 16 megabytes.

A hard disk drive does not come standard with the Tandy 5000 MC, as it does with IBM's Model 70. However, Tandy gives you a wide choice of hard disk sizes and controller options to pick from for your system. You can get hard disk drives ranging from 40 megabytes to 110 megabytes using an ST-506 controller, 80 to 344 megabytes using a small-computer-system-interface controller, and 120 to 140 megabytes with an enhanced-small-device-interface controller. The hard disk controller card occupies one of the IBM MCA-compatible slots.

One of the things that most interested us was the 5000 MC's IBM MCA compatibility. We used the same IBM MCA cards that we used in the PS/2 Model 70-A21: the Ven-Tel 24/2 2400-bps modem card, an IBM high-resolution 8514/A display card, and a USRobotics Courier 2400/PS 2400-bps modem card. Because of its five slots, we were able to easily pack all three cards into the system. The

## Meanwhile, in the Same Case ... The Tandy 3000

Whatever your feelings on the new Tandy 5000 MC, Tandy seems to favor the size and shape of its housing. In fact, the company revamped its mid-line 80286-based 3000 HL into the new 3000 NL, which uses standard PC AT-compatible expansion slots but now has the same case as the Tandy 5000 MC.

The new 3000 NL uses the same keyboard as the 5000 MC: a new 101-key keyboard with the industry-standard layout. The keyboard has both tactile and audible feedback, but it is not quite as loud as the standard IBM keyboards.

The 3000 NL also uses the same memory board as the 5000 MC.

But there the similarities to the 5000 MC end. The new 3000 NL has a 10-MHz 80286 CPU and seven PC AT-style slots (three 8-bit slots and four 16-bit slots). And at \$1699 for a system with a single 1.44-megabyte 3½-inch floppy disk drive, it is considerably less expensive. Indeed, the new 3000 NL could steal some customers away from Tandy's original PC AT clone, the 3000. At 12 MHz, the old 3000 is a little faster, but it costs \$300 more.

POS software functioned properly, identifying the new cards and configuring them into the system automatically. We were also able to use this software to manually configure the Ven-Tel modem card to serial port 1, and the USRobotics modem card to serial port 3.

Because we were unable to reach a phone line, we couldn't thoroughly check out the operation of the modem cards. Nevertheless, each card responded to Hayes AT commands as entered by a terminal program, indicating that the computer and software were communicating with the MCA cards on the bus. Connecting an IBM 8514 monitor to the high-resolution 8514/A display card, we got a steady and clear color display. These tests are not exhaustive, but they show that the 5000 MC bus and the IBM MCA bus are compatible.

We also looked at the performance of the 5000 MC. Once again, we used version 1.1 of the BYTE Small-C benchmarks. Since we were looking at a pre-production unit, we present only the CPU measurements in table 2. It's obvious that the Tandy 5000 MC is easily one of the fastest 20-MHz 80386-based systems: It outperformed both IBM's 20-MHz Model 80 and Compaq's Deskpro 386/20. We can't help but wonder how the 5000 MC would compare to the Model 70-A21 if Tandy placed a 25-MHz processor card in this system.

### Two Computers with Replaceable CPUs

IBM's new Model 70-A21 appears to be powerful, slick, and well designed. But at \$11,295, you'd expect nothing less. We especially like its small size, even though this limited the number of expansion slots in the system. If you add a high-resolution video board, a network card,

and a modem card to the Model 70-A21, you've used up all your slots. We also think the system is high-priced; you can get two 16-MHz Model 70s (which go for \$5995) for the price of one 25-MHz Model 70. However, the higher price may be justified if you eventually wind up swapping out the processor card for a higher-performance processor.

The 5000 MC has two things going for it when compared to the Model 70-A21: It has IBM MCA-compatible slots (and two extra at that) and a removable processor card. While the 5000 MC runs at only 20 MHz, it has excellent performance for its class, and there's always the possibility of swapping that processor card. The other thing going for it is price. A Tandy 5000 MC, equipped with an 80-megabyte hard disk drive with an ST-506 controller, costs \$6999.

Both IBM and Tandy have shown innovation in tackling the problem of how to supply the spiraling demand for more computing power without having the system become virtually obsolete in a year. It's interesting that both companies came up with the same solution: Make the CPU components and memory just more plug-in peripherals. The fastest CPU components and RAM are seldom cheap, but these components should cost considerably less than replacing the entire machine.

We'll have to wait and see if this open-design strategy pays off. Tandy should be commended for its efforts in duplicating the IBM MCA. Again, we'll just have to wait and see if the MCA itself pays off—for Tandy as well as for IBM. ■

*Rich Malloy, a BYTE associate managing editor, can be reached as "rmalloy" on BIX. Tom Thompson, a BYTE senior technical editor at large, can be reached as "tthompson" on BIX.*



# The Dell System 220. Once again the critics stole the words right out of our mouth.

*"The Dell System 220 runs most PC Labs system benchmark tests at speeds that would make you think you're running a 386."*

—PC MAGAZINE

*"...the Dell machine is renewed evidence that the price of 286-based desktop equipment continues to drop rapidly, making such machines very attractive for daily work under MS-DOS even as they hold out the promise of running OS/2 in the future."*

—WILL FASTIE, PC WEEK

*"...includes a year's on-site support...in the price of the computer. This is the sweetest support deal offered by any computer vendor in the industry."*

—ERIC KNORR, PC WORLD

*"The hot item from a technical point of view is the System 220. This machine runs a 286 processor at 20 MHz, which is its major claim to fame."*

—WILL FASTIE, PC WEEK

*"...the System 220 has more going for it than just speed."*

—PC WORLD



The reviews are beginning to pour in. And they read like a wish list for every power user looking to exceed the ordinary limitations of a 286 computer.

The computer everyone is praising in such glowing terms is the Dell System 220.

The first 286 computer with a clock speed of 20 MHz.

It's totally MS-DOS® and MS® OS/2 compatible. Yet it sells for much less than you may pay for a 386† computer.

Because you buy it direct from us.

Eliminating the mark-ups and margins of computer stores.

We design and build every Dell computer right here in Austin, Texas.

We put each and every one through a comprehensive burn-in and a battery of diagnostic tests before we ship it.

And after we ship, we give you the best technical support you'll find anywhere in the computer industry.

Our technicians are on the phone from 7AM to 7PM every business day.

Almost any question you may have about a Dell system can be answered over the phone.

And, in the rare case, that your question can't be answered by an on-line technician, we'll send a Honeywell Bull technician by the next business day.

A full year of on-site Honeywell Bull service is included within the purchase price of your Dell system.

Your Dell computer also comes with a thirty-day money back guarantee.

And we back every one of our computers with a one year limited warranty on materials or workmanship.

For more information about Dell computers, read the reviews in the trade press, turn the page, review our product offerings, and call us at (800) 426-5150.

You'll like what we have to say.

**DELL**  
COMPUTER  
CORPORATION

TO ORDER, CALL  
**800-426-5150**  
IN THE U.S. AND CANADA

SEPTEMBER 1988 • BYTE 161



# The Dell Computer Store.

Welcome to our store.

We believe you'll find this an extremely pleasant shopping experience.

Our sales staff is on hand to serve you from 7AM to 7PM (CST) from Monday thru Friday.

Just call (800) 426-5150 and we'll give you the technical assistance and information you need to make sure you're buying the system that's right for your needs.

Then you have the option of either a direct purchase or your company can take advantage of our Leasing Plan.

Once you've made your choice, our Total Satisfaction Guarantee gives you thirty days from the day you receive your system, to decide if you are absolutely, totally satisfied with the product.

If you're not, simply return the system and you'll receive a full refund. No questions asked.

Your Dell computer is supported by a team of technical experts that can be reached every business day, from 7AM to 7PM (CST), simply by calling (800) 624-9896.

In most cases, any question you may have about your Dell system can be answered by one of our technicians on the telephone.

Our technicians are also supported by Honeywell Bull service engineers who can be sent to your office by the next business day, should on-site service be required.

This optional service contract is available in over 95% of the United States, with over 1,000 engineers in 198 service locations.

We also offer a One Year Limited Warranty,\*\* which warrants each system we manufacture to be free of defects in materials and workmanship for one full year.

Feel free to call or write for the complete terms of our Honeywell Bull Service Contract, Guarantee and Warranty. Dell Computer Corporation, 9505 Arboretum Blvd., Austin, Texas 78759-7299.

## THE NEW 20 MHz 386† SYSTEM 310.

The top of the line. It's our highest performance computer available, faster than the IBM† PS/2† Model 80 and the Compaq† 386/20. It runs at 20 MHz with the latest 32-bit architecture. Since it also has Intel's Advanced 82385 Cache Memory Controller, and high performance disk drives, the System 310 is ideal for intensive database management, complex spreadsheet development, CAD/CAM, desktop publishing or performance as a network file server.

### Standard Features:

- Intel† 80386 microprocessor running at 20 MHz.
- 1 MB of RAM expandable to 16 MB without using an expansion slot.
- Advanced Intel 82385 Memory Controller with 32 KB of high speed static RAM.
- Socket for 20 MHz 80387 coprocessor.
- 5.25" 1.2 MB or 3.5" 1.44 MB diskette drive.
- Dual diskette and hard disk drive controller.
- Enhanced 101-key keyboard.
- 1 parallel and 2 serial ports.
- 200-watt power supply.
- 8 expansion slots (6 available).

### Options:

- 1 MB RAM upgrade kit.
- 20 MHz Intel 80387 and Weitek† math coprocessor.
- 2 MB or 8 MB memory expansion boards.

\*Lease for as low as \$148/Month.

System 310	With Monitor & Adapter	
	Hard Disk Drives	VGA Mono VGA Color Plus
40 MB - 28 ms	\$4,099	\$4,399
90 MB - 18 ms ESDI	\$4,899	\$5,199
150 MB - 18 ms ESDI	\$5,399	\$5,699
322 MB - 18 ms ESDI	\$7,399	\$7,699

## THE NEW 20 MHz 286 SYSTEM 220.

As fast as most 386 computers, at less than half the price—more power for the money than any other system. An 80286 system that runs at 20 MHz, with less than one wait state. Completely compatible for both MS-DOS® and MS® OS/2 applications (it runs faster than IBM PS/2 Model 80), and with a remarkably small footprint, the System 220 is the ideal executive workstation.

### Standard Features:

- 80286 microprocessor running at 20 MHz.
- 1 MB of RAM expandable to 16 MB (8 MB on system board).
- Page mode interleaved memory.
- Integrated diskette and VGA video controller on system board.
- One 3.5" 1.44 MB diskette drive.
- Integrated high performance hard disk interface on system board.
- Enhanced 101-key keyboard.
- 1 parallel and 2 serial ports.
- LIM 4.0 support for memory over 1 MB.
- Real-time clock.
- Three full-sized AT† compatible expansion slots.
- Socket for 80287 coprocessor.

### Options:

- External 5.25" 1.2 MB diskette drive.
- 3.5" 1.44 MB diskette drive.
- Intel 80287 coprocessor.
- 1 MB RAM upgrade kit.

\*Lease for as low as \$85/Month.

System 220	With Monitor		
	VGA Mono	VGA Color	VGA Color Plus
One Diskette Drive	\$2,299	\$2,499	\$2,599
40 MB - 29 ms Hard Disk	\$2,999	\$3,199	\$3,299
100 MB - 29 ms Hard Disk	\$3,799	\$3,999	\$4,099



# THE 12.5 MHz SYSTEM 200.

A great value in a full-featured AT compatible. An 80286 computer running at 12.5 MHz, this computer is completely MS-DOS and MS OS/2 compatible. The System 200 offers high speed drive options, industry standard compatible BIOS and on-site service. As Executive Computing said of this computer's predecessor, "If faster processing speed and low cost are two key issues affecting your purchase decision, this machine might be the ideal choice for your office."

#### Standard Features:

- Intel 80286 microprocessor running at 12.5 MHz.
- 640 KB of RAM expandable to 16 MB (4.6 MB on system board).
- 5.25" 1.2 MB or 3.5" 1.44 MB diskette drive.
- Dual diskette and hard disk drive controller.
- Enhanced 101-key keyboard.
- 1 parallel and 2 serial ports.
- 200 watt power supply.
- Real-time clock.
- 6 expansion slots. (4 available with hard disk drive controller and video adaptor installed).
- Socket for 8 MHz 80287 coprocessor.

#### Options:

- 512 KB RAM upgrade kit.
  - 8 MHz Intel 80287 coprocessor.
- \*Lease for as low as \$39/Month.*

System 200	With Monitor & Adapter	
Hard Disk Drive	VGA Mono	VGA Color Plus
40 MB - 28 ms	\$2,699	\$2,999
90 MB - 18 ms ESDI	\$3,499	\$3,799
150 MB - 18 ms ESDI	\$3,999	\$4,299
322 MB - 18 ms ESDI	\$5,999	\$6,299



## A Full Line Of Computers With A Full Line Of Configurations.

At Dell, we understand that different users have different needs. So we tailor each system to the user's individual requirements.

We offer monitors, graphics boards, tape backups, dot matrix and laser printers, hard disk and diskette drives, expanded memory boards, serial mice and more.

We also offer third party software applications for virtually

every business application including: accounting, communications, desktop publishing, graphics, word processing, integrated applications and user training.

So when your Dell System arrives, you can do productive work the minute you unpack the box.

We can build you the system you've been looking for.

### COMMON TO THE SYSTEM 310, SYSTEM 220 AND SYSTEM 200:

The Dell System Analyzer. MS-DOS and OS/2 compatible. Security lock with locking chassis. 12 month on-site service contract (Available on complete systems).

**PRINTERS/SOFTWARE.** We offer a full line of printers and popular software. All printers come with our 30-day money-back guarantee.

### LASER PRINTERS.

LASER SYSTEM 150; \$5,995.  
15 pages per minute, text and full-page graphics.  
Dual 250 sheet-input trays.

LASER SYSTEM 80; \$3,295.  
8 pages per minute, text and full-page graphics.

LASER SYSTEM 60; \$2,195.  
6 pages per minute, text and full-page graphics.

### DOT MATRIX PRINTERS.

PRINTER SYSTEM 800;  
\$699.95.  
Highest resolution text and graphics from a 24-wire dot matrix printer.  
Draft quality at 200 cps.  
Correspondence quality at 132 cps.  
Letter quality at 66 cps.  
Standard parallel and serial interfaces.  
Wide carriage.

PRINTER SYSTEM 600;  
\$499.95.  
9-wire dot matrix.  
Draft quality at 240 cps.  
Near-letter quality at 60 cps.  
Standard parallel interface.  
Wide carriage.

PRINTER SYSTEM 300;  
\$199.95.  
9-wire dot matrix.  
Draft quality at 144 cps.  
Near-letter quality at 36 cps.  
Four standard fonts.  
Paper parking.  
Standard parallel interface.

### SOFTWARE. Operating System Software.

Dell Enhanced MS-DOS 3.3 with disk cache and other utilities; \$119.95.  
Dell Enhanced MS OS/2 Standard Edition 1.0 \$324.95.

**DELL**  
COMPUTER  
CORPORATION

TO ORDER, CALL  
**800-426-5150**  
IN THE U.S. AND CANADA

All prices and specifications are subject to change without notice. Please inquire for current details. Dell cannot be responsible for errors in typography or photography. In Canada, leasing is not currently available and configurations and prices may vary. Microsoft® MS® and MS-DOS® are owned by Microsoft Corp. †Signifies registered or unregistered trademarks owned by entities other than Dell Computer Corporation. \*Payments based on a 36-month open-end lease. Please inquire for further details. \*\*During the one year warranty period we will repair or replace any defective products properly returned to our factory. © 1988 DELL COMPUTER CORPORATION.

AD CODE NO 11EB

Circle 79 on Reader Service Card





## BYTE looks at the latest PostScript printers, tops in quality and versatility

Steve Apiki and Stan Diehl

A few years ago, the phrases "made in Japan" and "computer-printed" suffered from the same low-quality image. Today, both phrases stand for a consistent quality that's hard to find anywhere else. The turnaround for computer printouts can be traced to a few important developments.

First, Canon and Hewlett-Packard provided personal computers with the high-quality output of laser printing. Later, Adobe supplied PostScript, which let users take greater advantage of their laser printers. From a beachhead of only one printer just 3 years ago, the PostScript-compatible laser printer has moved into a position as the standard against which other output devices are measured.

The BYTE Lab looked at 10 of the best PostScript printers. These printers are an ideal match for today's sophisticated, graphics-intensive software—especially desktop publishing and CAD packages—and the acute need for professional hard-copy output. We also tested four enhancement boards that bring PostScript compatibility to the Hewlett-Packard LaserJet Series II (including a glimpse of the first PostScript clone).

### The Making of a Standard

As is true with most computer innovations, the design philosophy of Post-

Script is a simple one. The language describes all aspects of the printed page—text, graphics, and sampled images—in the same way. PostScript graphics operators manipulate text as graphical shapes, therefore ensuring smooth integration of text and graphics on the page.

PostScript's imaging model, the heart of any page-description language (PDL), ensures versatility and total integration. PostScript does not view a page as a conglomeration of separate entities; it handles the page as a single unit. PostScript paints the page by filling in specified areas in color, black and white, or shades of gray.

The wide variety of possible graphics poses special problems for a PDL. PostScript defines operators according to the immediate application by dynamically combining graphics primitives as special needs arise. PostScript's control structure gives it great flexibility in combining graphics operators, thanks to the richness of the programming language.

Scalable fonts exemplify PostScript's versatility. Earlier PDLs called upon a set of physical fonts stored in memory. A PDL from this period could use only the typefaces and point sizes that were available to it. PostScript fonts, on the other hand, are mere geometric descriptions of a typeface's outline. Because the fonts are graphical descriptions rather than a rigid set of typefaces, they can be scaled to any size or rotated to any orientation while retaining their design integrity.

Ironically, the very features that make PostScript such an attractive PDL also conspire against it. The richness of the language makes for a complicated structure. Few programmers would tackle a PostScript program from scratch, and even editing the code can be confusing and tedious. Fortunately, an application program, like a desktop publishing system or a drawing program, usually generates the page description. Though this minimizes the problem of cumbersome code, it also inevitably limits the lan-

guage's power: Most applications stay within a set of basic commands, leaving many sophisticated features dormant.

The language structure also contributes to the most onerous PostScript problem: It is slow, painfully slow. PostScript code describes every aspect of the page with printable ASCII characters. The processor must interpret each piece of information—one piece at a time. Since PostScript works with high-level graphics primitives, a bottleneck occurs when converting high-level commands to actual printed graphics.

PostScript's most laudable feature, scalable fonts, also accounts for slow speed. It takes much more time to scale an outline font and generate the corresponding bit map than it would to simply load a typeface from font storage.

### The Brains Behind the Beauty

Microcomputer users are about as familiar with bottlenecks as glassblowers are. We're used to twiddling our thumbs waiting for files to be read from disks or for a few pages of text to make their way out of a dot-matrix printer. With PostScript printers, however, the bottleneck comes not from some clunky mechanical subsystem, but from the speed of instruction processing itself. Forget that your print engine is rated at 8 pages per minute (ppm); send a complex graphics document through the PostScript printer controller, and you'll be lucky if you get throughput of 8 minutes per page.

In a typical controller, the CPU is the only piece of intelligent hardware on the board. The CPU parses the commands and generates a bit-mapped page image of whatever was sent. If this includes graphics, all graphics manipulations (e.g., fills and rotations) must be conducted through the software that resides on the controller's EPROMs. A bit-mapped image requires the CPU to process the page pixel by pixel, and at 300 dots per inch—90,000 pixels per square

*continued*

# PostScript Printers

# Come of Age

Varityper VT600



- Apple LaserWriter IINT
- Apple LaserWriter IINTX
- Dataproducts LZR 2665
- Dataproducts LZR 1260
- General Computer Business Laser Printer
- IBM 4216 Personal Pageprinter
- PC Publisher Kit
- ITT Qume ScripTen
- QMS Color Script 100
- Laser Connection/QMS JetScript
- Laser Connection/QMS PS 800 II
- QMS PS 810
- Texas Instruments OmniLaser 2115
- Varityper VT600



QMS JetScript



QMS PS 810



Apple LaserWriter IINTX

*Pictured at right are four printers selected as best in quality or price.*



PRODUCT FOCUS  
POSTSCRIPT PRINTERS

**Table 1: The Varityper VT600 finished well in front in text quality, with the Apple LaserWriter IINTX coming in a surprising first in graphics quality. (Time measurements are in seconds; quality is rated on a scale of 1 [worst] to 5 [best].)**

Printer	IBM PC AT			Apple Macintosh			Graphics quality score	Text quality score	Warm-up time
	Large text file	Small text file	PostScript graphics file	Large text file	Small text file	PostScript graphics file			
Apple LaserWriter IINT	N/A	N/A	N/A	484	131	203	3.000	3.238	78
Apple LaserWriter IINTX	N/A	N/A	N/A	328	80	87	3.722	3.476	78
Dataproducts LZR 1260	230	57	92	318	77	54	3.389	2.905	69
Dataproducts LZR 2665	412	45	187	397	58	183	3.167	3.190	144
GCC Business Laser Printer	343	102	153	473	108	153	1.106	1.067	89
IBM 4216 Personal Pageprinter	368	82	149	N/A	N/A	N/A	2.833	2.714	32
QMS JetScript (with LaserJet)	258	65	121	N/A	N/A	N/A	3.111	3.238	141
PC Publisher Kit (with LaserJet)	965	71	124	N/A	N/A	N/A	3.167	3.619	25
QMS Color Script 100	1582	362	297	1561	323	108	3.467	3.000	148
QMS PS 800 II	307	64	105	310	144	140	3.056	3.095	66
QMS PS 810	304	85	101	372	95	139	3.667	3.619	66
ITT Qume ScripTen	228	90	168	523	143	112	2.889	3.095	72
TI OmniLaser 2115	334	54	108	439	93	108	3.389	3.429	111
Varityper VT600	268	73	152	336	142	156	3.667	4.200	251

**Table 2: A comparison of features shows similarities in interfaces and capabilities, and large differences in price, downloadable fonts, and storage.**

Printer	CPU/Speed (MHz)	RAM (meg.)	ROM	PostScript version	Hard disk drive	Interfaces	Resident fonts	Emulation
Apple LaserWriter IINT	68000/11.5	2	1M	47.0	No	a, s, d	35	No
Apple LaserWriter IINTX	68020/16.7	2-12	1M	47.0	Port	a, s, d	35	No
Dataproducts LZR 1260	68020/16.7	4	1M	47.0	No	a, s, p	35	HP Plus, D630,
Dataproducts LZR 2665	68000/10	3	512K	46.2	Option	a, s, p	13	D630,
GCC Business Laser Printer	68000/12.5	2-3	1M	49.2	Port	a, s, p	39	No
IBM 4216 Personal Pageprinter	68000/10	2.5	No	47.0	No	AT, PS/2 card	13	IBM 4202
QMS JetScript	68000/16	3	No	47.2	No	PC, PS/2 card	35	No
PC Publisher Kit	68000/10	2	No	N/A	No	PC card	22	D630, IBM, NEC, HP, Qume, Epson
QMS Color Script 100	68020/16.7	8	1M	49.4	20M	a, s, p	35	No
QMS PS 800 II	68000/16	2-3	1M	47.0A	No	a, s, p	35	D630, HP Plus, HPGL
QMS PS 810	68000/16	2-3	1M	47.0A	No	a, s, p	35	D630, HP Plus, HPGL
ITT Qume ScripTen	68000/12	3	1M	47.0	No	a, s, p	35	HP Plus
TI OmniLaser 2115	68000/10	9	576K	47.0	No	a, s, p	13	D630, HP Plus, HPGL, TI 855
Varityper VT600	68020/16	6	628K	48.0.4	20M	a, s, p	13	No

For interfaces, a is AppleTalk, s is serial, p is Centronix parallel, and d is ADB.  
<sup>1</sup> Adapter cards were tested on a Hewlett-Packard LaserJet Series II, rated at 8 ppm.

<sup>2</sup> Size and weight include both engine and controller unit.  
<sup>3</sup> Price for minimum operating configuration.



inch—that's a hefty amount of information. Compare this to screen graphics, which can limit the speed of an application, where screen resolution is a mere 74 dpi on the Macintosh.

Unfortunately, the slowdown is unavoidable using current technology and architecture. The manufacturers of all these controllers have put real processing horsepower into their systems. All but four of these controllers feature a 68000 CPU: The Apple LaserWriter IINTX, the Dataproducts LZR 1260, the QMS Color Script 100, and the Varityper VT600 are built around a 68020. One would expect these four systems, with the advantage of a 32-bit data bus, to come out on top in our print timings. The IINTX and the LZR 1260 demonstrated excellent throughput on our PostScript graphics benchmark, the best single measure of controller speed. For the complete benchmark results, see table 1.

The VT600 and the Color Script 100 can be considered specialty PostScript printers, and they cannot be fairly compared with the rest of the field in terms of raw printing speed. The VT600, with its 600-dpi resolution (see figure 1), must

process 4 times as much information as the 300-dpi printer in generating its bit map. The Color Script 100, which turned in a very good time on the graphics test, has a four-color thermal print engine that is much slower than the typical Canon engine and slows every page sent through it (see figure 2).

The most telling demonstration of the difference a processor can make is seen when comparing the two Apple personal-ity boards, which use the same printer and whose primary difference is in the CPU. The IINT, which has an 11.5-MHz 68000, is less than half as fast as the 16.7-MHz 68020-based IINTX on the critical graphics test.

Most manufacturers have chosen to live with the performance decrease in exchange for the considerable cost savings afforded by the 68000. If the ultimate in speed is not one of your requirements, you can choose from a wealth of quality PostScript printers built around the less powerful CPU. Within this group, Texas Instruments' OmniLaser 2115, the QMS JetScript controller card, and the two QMS 800 series printers have the best processing speeds. QMS arms every one

of its controllers with a 16-MHz 68000, rather than the typical 12-MHz version, and the performance difference is obvious.

Next to the CPU, the most important features of a controller are the interfaces it supports and how well it supports them. With the notable exception of the IBM 4216 Personal Pageprinter, all the printers we reviewed can communicate through an RS-232C serial port or on an AppleTalk network; all but the Apple printers support Centronix parallel. The Personal Pageprinter and the LaserJet add-on cards (JetScript and PC Publisher Kit) have their own connections between the printer and the adapter and require an IBM PC AT slot. A Personal Pageprinter controller for Micro Channel-based machines is available. A list of the interfaces that each printer supports, as well as other features, is found in table 2.

Interfaces extend beyond the physical cable connection, and they play an important role in both compatibility and performance. While our Macintosh and DOS benchmark results are not directly comparable, they do point up significant

*continued*

Engine	Life (pages)	Duty cycle (pg./mo.)	PPM	DPI	Size	Weight	Software	Documentation pages	Suggested price
Canon LBP-SX	300k	Not rated	8	300	8.5 x 20 x 18	45	No	152	\$4599
Canon LBP-SX	300k	Not rated	8	300	8.5 x 20 x 18	45	No	152	\$6599
Toshiba A-739	600k	10k	12	300	18.1 x 19.8 x 19.5 <sup>2</sup>	107 <sup>2</sup>	No	280	\$7995
Toshiba A-740	3M	80k	26	300	16.1 x 23.4 x 26.7	176	No	44	\$18,700
Ricoh 1060	180k	3k	6	300	16.1 x 16.5 x 9	38	Mac fonts Mac drivers	172	\$4199
Undisclosed	Not rated	4k	6	300	17.7 x 16.5 x 8.4	38	Adapter w/ fonts	250	\$4999 <sup>3</sup>
N/A	N/A	N/A	N/A <sup>1</sup>	300	N/A	N/A	Adapter w/ fonts	83	\$2495
N/A	N/A	N/A	N/A <sup>1</sup>	300	N/A	N/A	Adapter w/ fonts, DDL software	221	\$1995
Mitsubishi G650	Not rated	4k	1	300	13.8 x 20.9 x 22.2 <sup>2</sup>	114 <sup>2</sup>	No	206	\$24,995
Canon CX-D	300k	10k	8	300	18.7 x 18.1 x 19.5	99	PostScript utilities	130 + 2 PS Manuals	\$6495
Canon LBP-SX	300k	5k	8	300	18 x 9.1 x 25	44	No	206	\$5495
Hitachi	300k	5k	10	300	20 x 17.25 x 15	90	No	179	\$5695
Ricoh 4150	1.5M	25k	15	300	21.5 x 28.5 x 17.5	88	No	349	\$7995
Undisclosed	360k	3k	10	600	18.5 x 23 x 21.1	161	No	146	\$15,995





Figure 1: Finer characters are in the sample at left, from the 600-dpi Varityper VT600. The sample at right, from a QMS PS 810, shows 300-dpi resolution.

differences in how the interfaces and controllers work together. The ITT Qume ScripTen, for example, printed our graphics file from the Macintosh significantly faster than it printed basically the same file from the IBM PC AT. This

is in sharp contrast to the performance of the QMS printers, which did much better on the DOS side. Better AppleTalk compatibility from ITT Qume accounts for this difference.

General Computer's Business Laser

Printer follows Apple's lead in making the AppleTalk connection of the DIN-8 variety, rather than the DB-9 favored by all the other AppleTalk printers. The other printers use the DB-9 connection as an additional RS-422 serial port when they are not in AppleTalk mode. These differing connectors can present a problem—though trivial—when connecting different printers to the network.

We chose the parallel interface when testing throughput from the IBM PC AT because we thought it was the least complicated way to connect a DOS machine to a printer. One printer that we ran into some trouble with using this approach was the QMS Color Script 100, which refused to receive instructions through the parallel port. QMS acknowledged the problem and suggested that we use a 30-foot parallel cable to correct it. Since only a 12-foot cable was available, we were forced to use the RS-232C port to get around the buggy parallel interface.

Though PostScript was developed for serial communications and Interactive PostScript depends on it, using a communications program to talk to a printer from an IBM PC AT is a trying experi-

# Freedom of Press.



Over the last few years, Adobe Systems has brought forth some very revolutionary ideas.

Such as the Adobe PostScript® page description language. Adobe® Type Library. Adobe Illustrator 88™. The Display PostScript™ system.

Software that gives you the freedom to create professional-quality reports, news-

letters, business graphics and more. Using virtually any kind of computer. IBM® PC. Macintosh® Mini or mainframe.

That's why choosing printers with PostScript software is your declaration of vendor independence. It's the only standard adopted by virtually every major company in the computer industry.

So any computers you have will work with any printers you buy equipped with PostScript software.

And that means even more choices when it's time to print. You can use laser and color printers. At a variety of resolutions. Or even professional typesetters.

The Adobe Type Library also gives you

ence. Even after the initial headache of matching the protocols, stripping line-feeds, and making sure the software was not expanding any tabs or sending any extraneous control characters, we continued to run into problems where the only solution was to turn the printer on and off. If you have a choice in interfacing from an IBM PC AT, choose the parallel port.

**Memories and Storage**

PostScript printers owe their ability to create quality, high-resolution output to more than just sheer processing power. Effective use of memory and mass storage capability is vital to the performance of the system. Every controller has at least 2 megabytes of RAM, most have some ROM, and some even have a hard disk drive or that capability. What sets a controller apart is the way it uses available memory to conduct the functions required by PostScript.

Most of the printers use ROM exclusively for retaining resident fonts. Obviously, the greater ROM storage a controller has, the more fonts it can keep readily available. The Texas Instruments Omni-

Laser 2115 stores most of its font information in ROM cartridges, and it has only a small amount of on-board ROM.

The IBM 4216 Personal Pageprinter and the LaserJet add-on cards opt for no ROM at all; their "resident" typefaces are stored on the system's hard disk drive and are downloaded to controller RAM when the system is initialized. This configuration lets you change your resident font set through software, so whichever typefaces you use most frequently are automatically downloaded. While this gives added versatility, especially to those who commonly use unusual fonts, it does add a significant delay to the initialization process.

Nonresident fonts can be downloaded to RAM from either the controlling microcomputer or a hard disk drive. Only Varityper's VT600 and QMS's Color Script 100 controller come with hard disk drives installed, but Apple's IINTX and General Computer's Business Laser Printer have small-computer-system-interface (SCSI) ports for making optional hard disk drive connections.

Two types of font information are kept in controller memory: the fonts them-

selves, and a PostScript standardized font cache. The font cache consists of characters that have already been processed and for which a bit-map outline has already been generated. Needless to say, fonts fetched from the font cache are utilized much more rapidly than those that must be taken from regular font memory and completely processed. It's in storing the font cache that a large amount of fast RAM can really make its presence felt.

Controller RAM stores downloaded fonts, the PostScript page description, the page bit map, and whatever header files an application may require. The controller uses any additional space for the font cache. The Color Script 100 comes standard with 8 megabytes of RAM to lead the field, but the IINTX's standard 2 megabytes can be upgraded to 12 megabytes. The VT600 comes with 6 megabytes installed, and the LZR 1260 comes with 4 megabytes; all the other controllers come with 2 or 3 megabytes standard.

Once again, the VT600 and the Color Script 100 are in a class by themselves.

*continued*

# Freedom of Choice.



NBI, Inc.  
Model 808



QMS-PS\*  
800 B, 810



Linotype Company  
LaserJet™ 100, 300, 500



Digital Equipment Corp.  
PrintServer™ 407, ScriptPrinter™



Texas Instruments  
OmniLaser™ 210B, 2115



The Laser Connection  
PS Jet/PS Jet™



Dataproducts Corp.  
LZR™ 2885



Qume Corporation  
ScriptTEN™



Texas Instruments  
OmniLaser™ 2106



AST  
Turbo Laser™/PS



IBM 4216-020  
Personal Pageprinter™



Varityper  
VT600



General Computer  
Business LaserPrinter Plus™



Quadram  
Outfitter™ PS



Agfa-Gevaert  
P400PS™



Apple Computer Inc.  
LaserWriter™ IINTX, IINTX

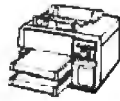

Wang  
LCS15™



NEC Information Systems  
SilentWriter™ LC-800



Diconix  
Digi™ MPS



Apollo Computer Inc.  
Domain Laser™ 28™



QMS PS™ 2400,  
QMS™ JetScript™

choices—literally hundreds of typefaces that let you communicate any idea more effectively.

Adobe Illustrator 88 software gives you freedom, too.

It lets you easily create anything from simple line drawings to complex masterpieces. Even if you can't draw a straight line.

And our new Display PostScript software

is a powerful system that brings the power of Adobe's PostScript software to any PC or workstation display.

So before you invest in any laser printer, make sure it's equipped with PostScript software from Adobe.

For more information, call 800-29-ADOBE.

Because Adobe's PostScript software is your only guarantee of true freedom of expression.



Look for this symbol on computers, printers and other products that support PostScript software from Adobe Systems. It's your guarantee of quality and connectivity.

Macintosh is the registered trademark of Apple Computer, Inc. ©1988 Adobe Systems Incorporated. All rights reserved. This ad was produced using the Adobe Type Library and PostScript printers and typewriters. The illustrations were created with Adobe Illustrator® software.



## How the Tests Were Done

We tested the printers on the two factors that users care most about: speed and print quality. For speed, we give objective numbers; for print quality, we provide numbers that are subjective but not arbitrary.

We printed three files, each designed to emulate a typical user file, in our speed test. First, we printed a 125K-byte, 16-page file that contained seven pages to emulate a large (and somewhat poorly designed) report. Next, we printed a 25K-byte, 6-page file that used only three fonts but also incorporated some small graphical elements. This file was typical of a small newsletter or flier. Finally, we printed a 34K-byte, single-page file of graphics and highly manipulated text. This page made extensive use of PostScript's facilities for text manipulation (e.g., rotation, scaling, and distortion), line rendering, and shading.

On the IBM PC AT, we created a separate PostScript file for each test, and we used the DOS PRINT command to send the file to the printer. Each printer except the QMS Color Script 100 was con-

nected to the AT via the parallel port.

On the Macintosh SE, we connected to the printer through AppleTalk and printed each file from its creating application. The file sizes for the Macintosh tests were 118K bytes, 21K bytes, and 20K bytes, respectively, for the large text, small text, and graphics tests. We used MacWrite 5.0 for the text files and Adobe Illustrator 1.0 for the graphics file. Since the two computers required different means for sending the files to the printers, you should not try to draw conclusions concerning the IBM PC AT versus the Macintosh as platforms for driving a printer.

For the print quality tests, we took one page of mixed-font text and a graphics page from each printer, taped them to a wall, and had 20 members of our editorial and art departments rate them on quality of text and graphics, using a scale of 1 (worst) to 5 (best). The result in table 1 is the mean of the scores.

One test we did not run was for noise level. We took readings on all printers and found that none added significantly to the noise level of the testing room.

Both of them have more than the standard amount of RAM, and both have a hard disk drive. The hard disk drive, in addition to storing downloaded fonts, is used as additional nonvolatile caching space. Less frequently used fonts in the cache are sent to disk as the RAM cache becomes full, enabling the cache to grow to 10 megabytes. Of course, retrieving fonts from the disk cache takes far longer than getting them from the RAM cache, but it is still faster than regenerating an entire character set.

All the printers except the VT600 provide Times, Helvetica, and Courier fonts among their standard resident fonts. See table 2 for the number of resident fonts each printer provides.

### Doing the Dirty Work

Although PostScript gets the headlines, the print engine does all the dirty work. In fact, the engine, more so than the PDL, determines the overall quality of type. The engine affects the main attributes by which a printer is measured: resolution, print quality, durability, and—to some extent—speed.

We often credit PostScript for sparking the laser-printer revolution. In fact, it was Canon who, by unveiling the LBP-

CX print engine in 1983, enabled low-cost laser printers to enter the market. When Hewlett-Packard introduced the Canon-based LaserJet in 1984, laser printers became a viable alternative for the office.

The print engine performs the printer's electromechanical functions. In a laser printer, the print engine contains the laser itself, which generates an electrical charge on a photosensitive drum. The charged area corresponds to desired markings on the page. Depending on the type of engine, the laser exposes either the black area of the image (write-black) or the white area of the image (write-white). The rotating drum attracts the toner to the charged areas and transfers it to a piece of paper. A final burst of heat melts the toner, thus fixing it to the page.

This process can affect print quality. Write-black engines produce darker blacks; write-white engines handle finer text. The resolution offered by the engine will, of course, affect print quality the most. Only the Varityper VT600 deviates from the 300-dpi standard, offering a fourfold increase in density at 600 dpi.

Because of the PostScript bottleneck, a manufacturer's rated engine speed

means very little. The printer will spit out sheets only as fast as PostScript can compose them. The Dataproducts LZR 2665 advertises a print speed of 26 ppm, but our benchmarks show little speed enhancement over engines with slower ratings. Only if you're churning out multiple copies of the same text file will the engine realize its advertised print speed.

If you intend to use your printer as a shared resource, consider the rated engine life. The original Canon CX has a rated engine life of only 100,000 pages. The Canon SX—the engine driving the newer Apple LaserWriters, the QMS PS 810, and others—claims an engine life of 300,000 pages. The Texas Instruments OmniLaser 2115, equipped with a Ricoh 4150 engine, boasts a life cycle of 1½ million pages. The most durable engines, like the Toshiba A-740 or the Agfa engine, will pump out over 3 million copies before giving out. None of the printers reviewed use the Agfa engine.

The print engine will have a significant effect on the printer's price. The LZR 2665 carries a hefty price tag, mainly because of its top-of-the-line Toshiba A-740 engine. Printers stocked with the Ricoh 1060 engine fall in a lower price range.

### Putting It All Together

The 14 printers and boards we reviewed were more than the sums of their controller, memory, and print-engine capabilities. They all are quiet and will fit nicely into an office environment, but each has special features and idiosyncrasies that you should consider when deciding on a PostScript printer. For a description of how we evaluated each printer, see the text box "How the Tests Were Done."

**Apple LaserWriter IINT:** Apple's replacement for its original LaserWriter PostScript board is a good controller designed for an excellent printer. Although it turned in a mediocre performance on most of our throughput benchmarks, the times were very good for the engine-intensive 36-page text test.

The IINT, which sells for \$4599, has a 68000 controller and limited memory, but it is easy to install and use and produces high-quality output.

**Apple LaserWriter IINTX:** This is a confession: Ever since we got this printer for evaluation back in February, we've used it for creating nearly all our hard copy in the lab. The print quality is excellent, and the printer is fast, versatile, and trouble-free.

Its combination of a 68020 controller and expandable memory gives it the un-

*continued*



# The secret to my success.



When I first showed up with print-outs from my Jet-Setter II laser printer, people just said, "Looks great!" or "Where did you have this typeset?" or "Did the art department do these charts?"

Everyone assumed I couldn't afford a laser printer. But now I think they're starting to get suspicious.

## **Upwardly mobile.**

The Jet-Setter II is compatible with the H-P LaserJet II® series printers, and has optional emu-

lation cartridges available for Epson® and Diablo®. So it works with just about every computer and every popular software package you can name. And with a large library of fonts, and options like a memory expansion package for the full page graphics you need in desktop publishing, it will be hard to obsolete.

## **Don't tell anyone.**

I'll admit it. The C. Itoh Jet-Setter II is the secret to my success. But when the word gets around that

you can get laser quality output without a big cash outlay, everybody's gonna want one.

So keep it to yourself, okay?

For more information or the C. Itoh reseller nearest you, call (800) 227-0315 or (714) 757-4492

**We build more in.  
So you get more out.**

# **C. ITOH**

**C. Itoh Electronics, Inc.**

2505 McCabe Way, Irvine, CA 92714.



## The Un-PostScript Alternative

Given PostScript's processing speed, you'd do best to schedule complex print jobs around coffee breaks and staff meetings. But there are alternatives. The CAPcard controller from LaserMaster prints so fast that we started wondering if our benchmarks were sufficient.

LaserMaster refers to its product as the Un-PostScript solution. In contrast to PostScript, which converts a bit-map graphic into ASCII, the CAPcard uses a dedicated graphics coprocessor to directly execute function calls.

Our first test used a complex PageMaker document with multiple fonts and integrated graphics. The CAPcard, installed in a Hewlett-Packard LaserJet Series II, printed the file from a standard IBM PC AT in 11 minutes and 13 seconds. For comparison, we chose the QMS JetScript card for obvious reasons: It installs in the same printer; it employs true Adobe PostScript; and its performance compares favorably with the other PostScript printers. Its performance could not match the CAPcard's, though. The complex PageMaker docu-

ment took the JetScript almost an hour to print.

So we tried something else. We pulled an AutoCAD drawing into PageMaker and printed that. CAPcard spit it out in 2 minutes and 13 seconds. The PostScript method took 32 minutes and 19 seconds. LaserMaster claims its proprietary graphics chip processes vectors at the rate of 10,000 per second. The AutoCAD benchmark bears this out.

The CAPcard beats the JetScript in price, too. With 1.5 megabytes of RAM standard, LaserMaster's controller sells for \$1395; enhanced versions—with more RAM, scalable typefaces, and drivers—are also available.

In fairness, the CAPcard software was hard to install; LaserMaster says a quick install kit, now available, will take care of the problem. Also, JetScript ran pure text files faster. But you don't buy a desktop publishing system and a laser printer to print just text. You want fancy logos, startling graphics, and total integration. Both products deliver the goods; it's just that CAPcard delivers them much, much faster.

matched graphics speed it demonstrated in our benchmarks. The print engine is the same classic LaserWriter that did well by the IINT. If there is a drawback to this system, it's the price tag: At \$6599, the IINTX is at the top end of the 300-dpi printers, but in this case you get a lot for the money you spend. [Editor's note: For a comprehensive review of the IINT and the IINTX, see "Remaking a Classic" by Curtis Franklin Jr. in the May BYTE.]

**Dataproducts LZR 2665:** The LZR 2665 is a hard printer to categorize. Though its \$18,700 price tag places it in a class with the Varityper VT600, it prints at only 300 dpi. As if to make up for that deficiency, the print engine posts an outstanding set of specs: a throughput speed of 26 ppm, a duty cycle of 80,000 pages per month, and a life expectancy of 3 million pages. The printer will also output ledger-size paper.

With all those impressive credentials, why doesn't this printer perform better? Perhaps it's the 10-MHz 68000. For what you pay, you deserve the 68020. Or maybe it's the limited storage, or some other design flaw. In any case, the LZR 2665 is simply not worth that much money. Its sluggish performance on

throughput tests negates the impressive engine speed. It's not hard to use, but it is difficult to set up. And, to top it all off, the print quality is poor.

Simply put, you can get a better printer for much less money than the LZR 2665, but if you happen to have \$18,700 burning a hole in your pocket, go for the VT600 and 600 dpi.

**Dataproducts LZR 1260:** The LZR 1260 combines a powerful controller with an excellent print engine to provide speed that blows by Apple's IINTX. In contrast to the earlier LZR 2665, the manufacturer focused on the controller rather than on the engine, resulting in a superior machine well worth \$7995. Though compact in comparison to the LZR 2665, the LZR 1260's print engine is sturdier than average, with a rated duty cycle of 10,000 pages per month.

The controller, built around a 68020 and connected to a print engine rated at 12 ppm, delivers impressive speed. One important flaw in its otherwise excellent benchmark performance—and the only thing that keeps this from being our favorite printer—is its relatively poor print quality. It also showed an unusual tendency for the status lights to remain active well after the last page had left the

printer. This "busy" indication, though disquieting, did not seem to interfere with subsequent printing.

A liquid-crystal-display readout and a membrane keypad on the front panel let you select both the interface and the PostScript mode (batch or interactive) without resorting to the manual. You can also select a Hewlett-Packard LaserJet Plus emulation mode if you need to print a document outside PostScript.

**General Computer Corp. (GCC) Business Laser Printer:** If you're willing to sacrifice some performance—but no versatility—for economy, this may be the printer for you. It features a 68000-based controller with 2 megabytes of RAM; a 6-ppm print engine; AppleTalk, RS-232C serial, and Centronix interfaces; and a SCSI port for connection to an external hard disk drive. All this will run you only \$4199 for the complete system, or you can upgrade the GCC Personal Laser Printer for \$2299.

The printer is aimed squarely at the Macintosh market, and a large part of its clearly written documentation is dedicated to operating from a Macintosh. Its default interface mode is AppleTalk, and connection to the parallel port requires flipping a DIP switch on the back of the printer. Printer-driver and font software are included for the Macintosh, but there are no equivalent fonts for the IBM PC.

Speed performance was poor, but the output was fine, and the Business Laser Printer compared favorably to several more costly printers on our print quality test. As a matter of fact, this is the least expensive laser printer we reviewed, and you can definitely do worse in finding a solid, reliable printer.

**IBM 4216 Personal Pageprinter:** IBM markets the 4216 as part of its Solution-Pac Personal Publishing System. The printer itself is offered with the controller card and software in a minimum operating configuration that sells for \$4999.

The printer shares its design with the General Computer printer. The toner and OPC (organic photoconductor) cartridges both load in the same way, and everything but the interface is similar in both machines. For the interface, the printer must be connected to an adapter card mounted in an IBM PC AT or PS/2 slot.

System software lets you load fonts from your system's hard disk drive to controller RAM, and it includes a print utility and PageMaker and Windows drivers. Hard disk drive-resident fonts can be altered.

*continued*



# LOWEST PRICE EVER FOR PRINTER SHARING.



## \$500 Value For \$149\*

\*Introductory price. Suggested Retail: \$195.

## AUTO-T PLUS



**4 USERS SHARE 1 PRINTER**  
Serial or Parallel

### ...with Softspool

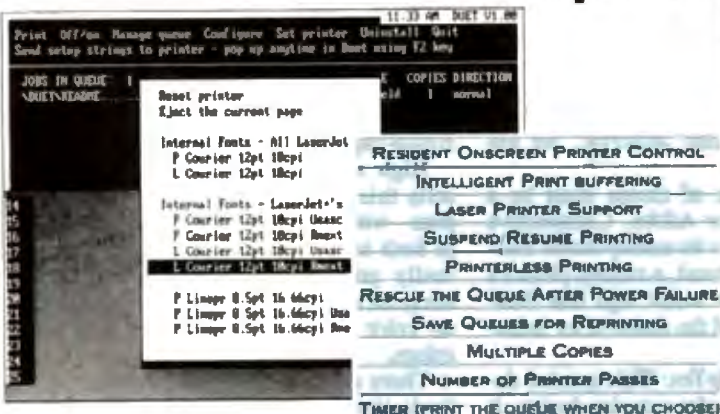

**MADE IN U.S.A.**

Now, there is an alternative to printer sharing devices costing \$500 or more: The Auto-T Plus with Softspool.

Transparent to the user and easy to install, the Auto-T Plus cost per user is little more than the price of a cable – yet offers features found only in costly buffered devices. These include background spooling and a host of printer utilities that alone would justify the low price of Auto-T Plus – a quality U.S. made product with a one year warranty.

Call for Local Dealer.  
OEM & Corporate Inquiries Welcomed.

## 800-537-5999



**Integrated  
Marketing  
Corporation**

1031H East Duane Avenue, Sunnyvale, CA 94086  
Telephone (408) 730-1112  
Telex 5106018576 FAX (408) 730-1452

Manufacturing & Marketing of "Interface Tools."





**Figure 2:** This drawing, done with Aldus FreeHand, is typical of output from the QMS Color Script 100. To date, this is the only PostScript-compatible color printer.

The printer produced output of poor quality, and its speed performance was mediocre when connected to the IBM PC AT. The SolutionPac (including a PS/2 Model 80) may be a good turnkey system, but as a stand-alone printer, the 4216 is woefully average.

**PC Publisher Kit:** The first of the PostScript clones has finally arrived. Imagen's UltraScript language emulates the Adobe standard, bringing PostScript compatibility to the Hewlett-Packard LaserJet Series II. In addition to PostScript, the PC Publisher Kit can print DDL, PCL, and Hewlett-Packard Graphics Language (HPGL) files. The kit features the 68000 processor with 2 megabytes of memory and 22 typefaces.

The \$1995 PC Publisher Kit sells for \$500 less than JetScript, a true PostScript controller. Lower prices should be a major selling point of the coming clones, since they will be immune from Adobe royalties. The kit comes with two boards, one for the IBM PC AT and one for the printer. Installation of both software and hardware is quick and painless. If you need help, the two manuals should prove adequate.

Much has been made of Adobe's proprietary font-scaling algorithm. We were anxious to see how well PC Publisher Kit would handle our large text file, a benchmark designed to wring out the font cache and test font-scaling capability.

Imagen uses its own algorithm to scale fonts. Also, though it does not license Adobe fonts, it does license from original foundries. Adobe's font-scaling claims do gain some credence here, as PC Publisher Kit ran the large text benchmark significantly slower than the JetScript controller. Unfortunately, the kit stores fonts on the host's hard disk drive, so slow disk access time will affect throughput.

For the most part, though, Imagen has created a sufficient clone. PC Publisher Kit posted adequate times on the other benchmarks, it was able to print all the PostScript test files, and it displayed print quality comparable to JetScript's. If you have long documents with multiple font changes, you can't ignore the kit's speed deficiency; but if you're on a tight budget, you can get PC Publisher Kit for 25 percent less than JetScript. Yet another trade-off.

The emergence of clones must be a mixed blessing for Adobe. Competitive prices will cut into its monopolized market. On the other hand, a sudden plethora of imitators is the surest sign that PostScript has attained the status of an industry standard.

**ITT Qume ScriptTen:** This printer deserves high marks for exterior design. It is pleasing to the eye. The output, on the other hand, fails to meet that same aesthetic. The write-white Hitachi engine

puts out some deep blacks, but it does not print high-quality text. It scored near the bottom on our print quality tests and average on throughput. The engine has a rated speed of 10 ppm, a duty cycle of 5000 pages per month, and a life expectancy of 300,000 pages.

The ScriptTen employs the 68000 processor and holds 1 megabyte of ROM and 3 megabytes of RAM. The \$5695 printer is extremely easy to set up and just as easy to use. Indicator lights are accessible and self-explanatory. Documentation includes a guide to operations and a PostScript supplement. The supplement covers basic PostScript commands—the ones you are most likely to use—and explains how to issue these commands from interactive mode. The ScriptTen scored high on our IBM PC AT benchmarks, especially on the large text throughput. However, it did not handle the AppleTalk small and large text tests very well. In any case, given the poor print quality, those benchmarks don't mean much.

**QMS Color Script 100:** If you think 300-dpi graphics look good in black and white, wait till you see them in color. The Color Script 100 lets you take that step by being the first color PostScript printer. The results are spectacular.

QMS has put together a high-powered print controller featuring a 68020 CPU, 8 megabytes of memory, a 20-megabyte hard disk drive, and a four-color thermal print engine to create the Color Script 100, a high-performance printer capable of some truly beautiful graphics. The system lists at an eye-popping \$24,995, and at over 3 times the price of most 300-dpi printers, it's reserved for customers who need high-resolution color.

The print engine is slow, especially when processing large files like our large text benchmark file. Printing in color takes far longer, as the printer needs to make four passes on the page: one each for cyan, magenta, yellow, and black. The high-speed controller enabled the printer to perform admirably on our single-page graphics benchmark.

High speed is not, of course, what sells this printer. It's the pages it outputs—with high-quality text or graphics in both black and white and color—that really grab you. The system can also make an excellent proof printer, as it can do color separations for three or four colors.

There are, unfortunately, two serious limitations to the otherwise excellent Color Script 100: the lack of a reliable parallel interface, as discussed earlier,

*continued*





# QNX vs. OS/2 UNIX

**QNX<sup>®</sup>: Bend it, shape it, any way you want it.**

**ARCHITECTURE** If the micro world were not so varied, QNX would not be so successful. After all, it is the operating system which enhances or limits the potential capabilities of applications. QNX owes its success (over 60,000 systems sold since 1982) to the tremendous power and flexibility provided by its modular architecture.

Based on message-passing, QNX is radically more innovative than UNIX or OS/2. Written by a small team of dedicated designers, it provides a fully integrated multi-user, multi-tasking, networked operating system in a lean 148K. By comparison, both OS/2 and UNIX, written by many hands, are huge and cumbersome. Both are examples of a monolithic operating system design fashionable over 20 years ago.

**MULTI-USER** OS/2 is multi-tasking but NOT multi-user. For OS/2, this inherent deficiency is a serious handicap for ter-

minal and remote access. QNX is both multi-tasking AND multi-user, allowing up to 32 terminals and modems to connect to any computer.

**INTEGRATED NETWORKING** Neither UNIX nor OS/2 can provide integrated networking. With truly distributed processing and resource sharing, QNX makes all resources (processors, disks, printers and modems anywhere on the network) available to any user. Systems may be single computers, or, by simply adding micros without changes to user software, they can grow to large transparent multi-processor environments. QNX is the mainframe you build micro by micro.

**PC's, AT's and PS/2's** OS/2 and UNIX severely restrict hardware that can be used: you must replace all your PC's with AT's. In contrast, QNX runs superbly on PC's and literally soars on AT's and PS/2's. You can

run your unmodified QNX applications on any mix of machines, either standalone or in a QNX local area network, in real mode on PC's or in protected mode on AT's. Only QNX lets you run multi-user/multi-tasking with networking on all classes of machines.

**REAL TIME** QNX real-time performance leaves both OS/2 and UNIX wallowing at the gate. In fact, QNX is in use at thousands of real-time sites, right now.

**DOS SUPPORT** QNX allows you to run PC-DOS applications as single-user tasks, for both PC's and AT's in real or protected mode. With OS/2, 128K of the DOS memory is consumed to enable this facility. Within QNX protected mode, a full 640K can be used for PC-DOS.

**ANY WAY YOU WANT IT** QNX has the power and flexibility you need. Call for details and a demo disk.

**THE ONLY MULTI-USER, MULTI-TASKING, NETWORKING, REAL-TIME OPERATING SYSTEM FOR THE IBM PC, AT, PS/2, THE HP VECTRA, AND COMPATIBLES.**

<b>Multi-User</b>	10 (32) serial terminals per PC (AT)	<b>C Compiler</b>	Standard Kernighan and Ritchie.
<b>Multi-Tasking</b>	64 (150) tasks per PC (AT)	<b>Flexibility</b>	Single PC, networked PC's, single PC with terminals, networked PC's with terminals. No central servers. Full sharing of disks, devices and CPU's.
<b>Networking</b>	2.5 Megabit token passing. 255 PC's and/or AT's per network. 10,000 tasks per network. Thousands of users per network.	<b>PC-DOS</b>	PC-DOS runs as a QNX task.
<b>Real Time</b>	3,200 task switches/sec (AT)	<b>Cost</b>	From US \$450. Runtime pricing available.
<b>Message Passing</b>	Fast intertask communication between tasks on any machine.		

*For further information or a free demonstration diskette, please telephone (613) 591-0931.*

Quantum Software Systems Ltd. • Kanata South Business Park • 175 Terrence Matthews Crescent • Kanata, Ontario, Canada • K2M 1W8

Circle 227 on Reader Service Card

QNX is a registered trademark of Quantum Software Systems Ltd.

UNIX is a registered trademark of AT & T Bell Labs. IBM, PC, AT, XT and PS/2, PC-DOS and OS/2 are trademarks of International Business Machines. HP and Vectra are registered trademarks of Hewlett-Packard Company.



and a limited imageable area. In order to keep the margins required for tight tolerance on color alignment, the thermal print engine accesses only an 8.11- by 8.91-inch region on a standard 8.5- by 11-inch page. This is significantly less than the average 8.1- by 10.5-inch imageable region afforded by most of the laser printers, and it can actually lead to some clipping. You can avoid the problem by simply designing pages with this limitation in mind.

**Laser Connection/QMS JetScript:** The JetScript controller provides PostScript compatibility to the Hewlett-Packard LaserJet Series II. Two cards, a manual, four floppy disks, and a parallel cable come in the package. You must first install the software. This copies the PostScript code onto the host computer's hard disk drive. The prompts are clear and easy to follow, and the directions cover everything, including jumper settings on the board.

Hardware installation is just as easy: Slide one card into the IBM PC AT, pop the other into the rear slot of the LaserJet, plug in the cable, and boot up. An AUTOEXEC file will load PostScript code onto the controller board's RAM. Unlike the PostScript printers, the code is not ROM-resident. Though this configuration causes some inefficiencies, it also means you won't have to swap ROM chips with each upgrade.

JetScript's ASAP (Advanced System Architecture for PostScript) technology, extended font cache, and 16-MHz 68000 MPU combine for exceptionally fast throughput. JetScript cranked out the large text file in only 4 minutes and 18 seconds. The \$2495 controller supports the 35 standard Adobe typefaces. Installing the card will not void the printer warranty.

If you have a LaserJet Series II and need PostScript compatibility, JetScript offers a ready solution. In fact, the smooth operation and impressive speed of this controller almost justify purchasing the LaserJet just to put the JetScript card in it.

**Laser Connection/QMS PS 800 II:** QMS has a reputation for producing quality printers at a reasonable price, and the printers in the PS 800 series are no exception. Though marketed by The Laser Connection, this printer is QMS through and through. The PS 800 II, with an attractive price of \$6495, is a 300-dpi printer with a fast 68000 controller, 2 megabytes of RAM, and an engine rated at 8 ppm. The combination affords good overall performance in both text and graphics printing.

Text and graphics quality rank the PS 800 II in the middle of the field. Highest performance was achieved in the printing of our graphics-intensive benchmark, where the controller's speed could really shine.

Top this printing performance off with provisions for the three common interface connections, a 10,000-page-per-month duty cycle, a double print tray combination, and emulation support for the Hewlett-Packard LaserJet Plus,



POSTSCRIPT®

Adobe's new logo  
sets apart  
true PostScript products  
from clones.

HPGL, and the Diablo 630, and you have a full-featured printer capable of handling network print jobs with style.

**QMS PS 810:** The PS 810 is a compact, comparatively light-duty version of the PS 800 II, with the same controller configuration driving an electrophotographic recording engine. Though the engine is rated for the same 8-ppm speed, the system is much smaller than the PS 800 II, which uses the raster-scan print method. The printer weighs in at 44 pounds, approximately half the bulk of its larger cousin, but it also has only half the recommended duty cycle at 5000 pages per month. It costs \$5495.

Print quality was excellent for this machine, consistently on top in our quality benchmarks. Beyond this, the PS 810 and PS 800 II are remarkably similar, sharing the same interfaces and emulations. The PS 810 does not have the dual input trays of the more network-oriented PS 800 II, but the two machines' only critical design difference is in print capacity. If you're looking for a printer to handle less than a whole office's output, you might do well to consider the lighter and even less expensive PS 810.

**Texas Instruments OmniLaser 2115:** The Ricoh 4150 engine gives the OmniLaser 2115 some impressive specs. With a 25,000-page-per-month duty cycle and a life expectancy of 1½ million pages, the 2115 looks great on paper. If only its

output looked better on paper. The write-white engine produces deep blacks, but the text lacks crispness. Still, the 2115 scored average on our print quality tests and above average on throughput.

The \$7995 unit has a compact structure, with all switches, trays, and cartridges readily accessible. It is easy to set up and use. Two manuals provide all the information you'll need in a clear, well-organized format. Chances are good, though, that you won't have to refer to them often.

If you're looking for a printer to add to a network, you can't ignore this one. It has all the features you look for in a shared resource: durable duty cycle, long life expectancy, exceptional speed, and ease of use.

**Varietyper VT600:** If you're ready to plunk down a good-size chunk of capital and graduate from the ranks of the 300-dpi laser-printer owners, you're ready for a Varietyper VT600. At \$15,995, the VT600 is definitely not for the casual user, nor even for the serious individual user. This is a machine meant for organizations with a real need for very high-quality printing but not yet ready to go into the publishing business full-time with the purchase of a Linotype.

The VT600 is the first PostScript printer to achieve 600-dpi resolution. The 600-dpi print engine is fast—rated at 10 ppm—and able to give the printer good throughput ratings when printing large files. Processing power is vital when dealing with the vast amounts of information manipulated at this resolution. The controller is built around a 68020 CPU and 6 megabytes of RAM, 4 megabytes of which are necessary for the page buffer alone. A 20-megabyte hard disk drive provides additional storage space.

The system comes with surprisingly few fonts installed, but you can purchase almost any imaginable font from Varietyper's library of 53 typeface families. Text printed with these installed fonts is distinctively good. The printer topped our text quality test.

Graphics, especially those with gradations from dark to light, are beautiful at 600 dpi. Black areas are black, and edges are clearly defined. The VT600 was not, however, the most highly rated graphics printer according to our test, which favored the 300-dpi Apple IINTX.

#### The Pick of the Lasers

In selecting the best of these printers, our single most important criterion was print quality, an elusive and often subjective

*continued*

Now from NRI comes the first course of its kind . . . anywhere!

# Learn to use, program, and service today's digital electronic music equipment as you build your own computer-controlled music center



Now NRI puts you at the heart of the most exciting application of digital technology to date! With NRI's new at-home training in Electronic Music Technology, you get hands-on experience with the equipment that's revolutionizing the music industry—Atari ST Series computer with built-in MIDI ports, Casio CZ101 digital synthesizer with advanced MIDI capabilities, and ingenious MIDI software that links computer keyboard to synthesizer keyboard—all yours to train with and keep.

This year, over \$1.5 billion worth of digital electronic music instruments—keyboards, guitars, drum machines, and related equipment—will be sold in the U.S. alone. Who's buying this new-tech equipment? Not just progressive musicians and professional recording technicians, but also thousands of people who have never touched a musical instrument before. And there's good reason why.

Something called MIDI (Musical Instrument Digital Interface) has suddenly transformed musical instruments into the ultimate computer peripherals . . . and opened up a whole new world of opportunity for the person who knows how to use, program, and service this extraordinary new digital equipment.

Now NRI's breakthrough Electronic Music Technology course puts you at the forefront of this booming new technology with exclusive hands-on training built around a MIDI-equipped computer, MIDI synthesizer, and MIDI software you keep.

## Dynamic New Technology Opens Up New Career Opportunities for You

The opportunities are unlimited for the person who's trained to take advantage of today's electronic music phenomenon. Now you can prepare for a high-paying career as a studio technician,

sound engineer, recording engineer, or road technician . . . even start your own new-age business providing one-stop sales and service for musicians, technicians, and general consumers alike. Or simply unleash your own musical creativity with the breakthrough training and equipment only NRI gives you.

## Only NRI Gives You an Atari ST Computer, Casio Synthesizer, and Innovative MIDI Software You Train With and Keep

The Atari ST Series computer included in your course becomes the heart of your own computer-controlled music center. With its tremendous power, superior graphics capabilities, and built-in MIDI interface, the 16/32-bit Atari ST has almost overnight become the computer of choice for today's most knowledgeable electronic musicians.

The Casio CZ101 digital synthesizer, also included in your training, is the perfect complement to your Atari ST. The polyphonic, multitimbral CZ101—which stores up to 32 voices internally—"communicates" with your ST computer through MIDI, bringing life to virtually any sound you can imagine.

Plus, you get ingeniously designed MIDI software that opens up amazing new creative and technical possibilities . . . you actually build your own 4-input audio mixer/amplifier . . . and you test the electronic circuits at the core of today's new-tech equipment with the hand-held digital multi-meter included in your course.

## No previous experience necessary—in electronics or music!

No matter what your background, NRI gives you the skills you need

to take advantage of today's opportunities in electronic music technology.

With your experienced NRI instructor always available to help, you master the basics of electronic theory step by step, gaining the full understanding of electronics that's now so essential for technicians and musicians alike. You move on to analyze sound generation techniques, digital logic, microprocessor fundamentals, and sampling and recording techniques . . . ultimately getting first-hand experience with today's explosive new technology as you explore MIDI, waveshaping, patching, sequencing, mixing, special effects, and much more.

Plus, even if you've never been involved with music before, NRI gives you enough basic training in music theory and musical notation to appreciate the creative potential and far-reaching applications of today's electronic music equipment.

## Send Today for Your FREE Catalog

For all the details about NRI's innovative new training, send the coupon today. You'll receive a complete catalog describing NRI's Electronic Music Technology course plus NRI courses in other high-tech, in-demand electronics fields.

If the coupon is missing, write to NRI School of Electronics, McGraw-Hill Continuing Education Center, 3939 Wisconsin Avenue, Washington, DC 20016.

**NRI School of Electronics**  
McGraw-Hill Continuing Education Center  
3939 Wisconsin Avenue  
Washington, DC 20016

### CHECK ONE FREE CATALOG ONLY

- Electronic Music Technology     Computers and Microprocessors  
 TV/Video/Audio Servicing     Basic Electronics

Name \_\_\_\_\_ Please Print \_\_\_\_\_ Age \_\_\_\_\_



Street \_\_\_\_\_

City \_\_\_\_\_ State \_\_\_\_\_ Zip \_\_\_\_\_

NRI is accredited by the Accrediting Commission of the National Home Study Council #170-098





In 1988, \$3.5 billion in micro-computer software will be sold worldwide. During that same time, another \$3.0 billion in sales will be lost to free distribution — better known as software piracy. And right now, Rainbow Technologies' Software Sentinel™ is protecting close to \$1.0 billion in software for developers who never wanted to be part of the free software distribution network in the first place.  The Software Sentinel hardware key is “execution control” software protection. It ships with the software and simply plugs into the PC's parallel port to be one hundred percent invisible to both user and the software. Users can make as many copies as they want. Make working submasters. Use a hard disk. Virtually anything that can be done with unprotected software. Except start freely distributing that software to other users.  The family of Software Sentinel products. Selected by the very big to the not-so-big developers of MS-DOS, OS/2 and Xenix software in worldwide markets. To the tune of close to a billion dollars. So far.



**RAINBOW TECHNOLOGIES**

18011-A Mitchell South, Irvine, CA 92714 • (714) 261-0228 • TELEX: 386078 • FAX: (714) 261-0260  
 Copyright ©1988 Rainbow Technologies, Inc. Software Sentinel and SentinelPro are trademarks of Rainbow Technologies, Inc.



Computer of the Year.

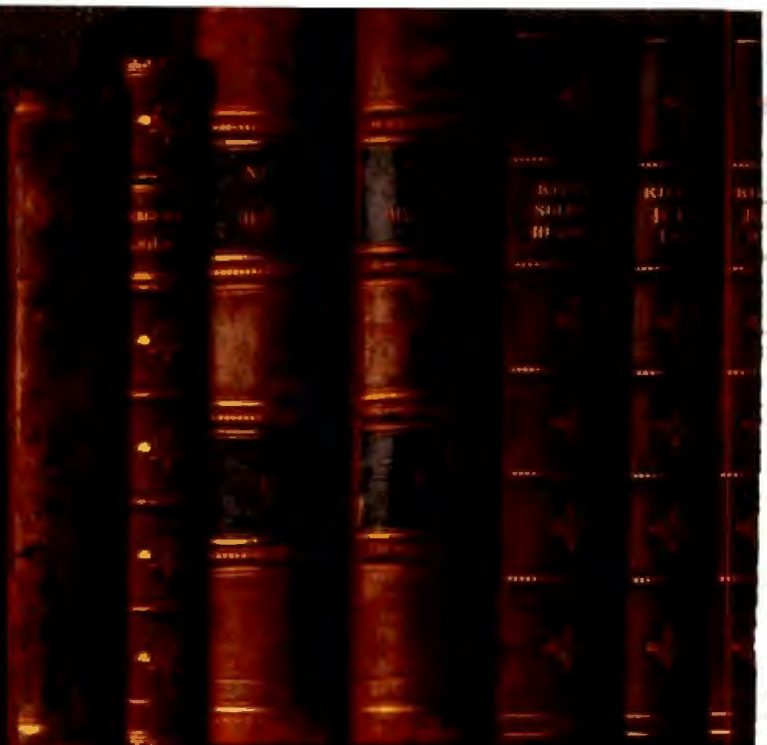

# “Secure.”

**si·kūr', a.** [L. securus]: *The ability to keep your confidential data and your whole personal computing environment away from prying eyes and meddling associates.*

Securing your personal computer files has, until now, been a complicated and mostly unreliable matter. Not any more.

The Tandon Personal Data Pac is the world's first truly removable, self-contained Winchester hard disk drive that pops in and out of its receptacle with the stroke of a key. You just lock the Personal Data Pac with your entire computing environment in your desk or your safe.

And when your business keeps you on the move, the Tandon Personal Data Pac lets you take your office with you. It fits easily in your briefcase or your garment bag. If the airlines lose it, don't



a hearty little traveller that can take a lot of abuse. It can cope with the rough and tumble world of the postal system, as well as take an occasional knock off your



fret. Backing up a full Personal Data Pac onto another takes only a few minutes. So you can take one and keep a copy secure in your safe.

The Personal Data Pac protects your data well. It's

transferring high-capacity files quickly and easily. And, you can make any computer your personal dedicated workstation, simply inserting your own Data

Let your Tandon Dealer show you how the Personal Data Pac can make living with your PC more economical and productive. See him today, or call us at **1-800-556-1234**, Ext. 171 (in California **1-800-441-2345**, Ext. 171). Security for a small price.



## Tandon

*We're redefining personal computing.*



# The Hot Performers.



ME 386-20  
Tower



ME 386-18

“Solid performance and low price make this system an excellent value.”  
—InfoWorld

## ME 386-20

20 MHz 80386-20 processor  Microsoft OS/2 and DOS compatible  1 MB 32-bit RAM running at “0” wait state (upgradable to 8 MB)  Socket for 80387/80287 math co-processor  High performance NCL floppy/hard disk controller  1.2 MB floppy disk drive  CMOS clock/calendar with battery back-up  Enhanced keyboard

**\$2350**

Upright Case  
Add \$300



## ME Roadrunner

12 MHz 80286 processor  Socket for 80287 math co-processor  640K memory (1 MB option)  New Super-Twist LCD with Backlit and Reverse; 640 x 200 dots (640 x 400 option); 80 char. x 25 lines  Monochrome/Color graphics card for external monitor  6 expansion slots  Floppy/hard disk controller  Serial/parallel/clock-calendar  1.2 MB floppy disk drive  20 MB hard disk (30, 40, or 60 MB optional)  12-function AT style keyboard  110/220V auto-switchable  20 pounds

**\$1799**

## ME 386-18

18 MHz 80386 processor  Microsoft OS/2 and DOS compatible  512K 32-bit memory on board  Two 32-bit expansion slots  Socket for 80387 math co-processor  High-performance NCL floppy/hard disk controller  1.2 MB floppy disk drive  CMOS clock/calendar  Enhanced AT keyboard

**\$1799**

### ★ SPECIAL ★

ME V20  64K (upgradable to 640K)  360K floppy disk drive  Monochrome graphics card  Monochrome monitor  Keyboard  Complete system...\$499.00

## HOT PORTABLES

## Roadrunner Plus (386)

Intel 80387 processor  6/16 MHz clock speed  1 MB of memory  Socket for math co-processor  Floppy/hard disk controller  1.2 MB high capacity floppy disk drive  42 MB fast access hard disk (60 MB optional)  Serial/parallel ports  Color/mono display card for external monitor  New Super-Twist LCD with Backlit and Reverse; 640 x 400 dots; 80 characters x 25 lines  6 expansion slots  12-function keyboard  110/220V auto-switchable  20 pounds

**\$3399**

## ME 286-12

8/12 MHz 80286 processor  512K memory (upgradable to 1 MB on board)  “0” wait state option (s.i. I5.3)  Microsoft OS/2 and DOS compatible  8 I/O expansion slots  High-performance NCL floppy/hard disk controller  1.2 MB floppy disk drive  CMOS clock/calendar  Enhanced keyboard

**\$899**

## The Network Solution

ELS Network for two-to-four users. Increase your company's productivity without making a big increase in expenditures. Complete software...

**\$499**

Call for all Novell Products

Prices and availability  
subject to change  
without notice



CALL TOLL-FREE

**(800) MICRO-21**  
in Calif. (714) 662-1973

**ME MICRO EXPRESS**

2114 South Grand Avenue  
Santa Ana, California 92705  
Fax: (714) 662-1258 • Telex: 910 240 3029



# Two for the Road



Sleek and powerful  
80386-based portables:  
the Toshiba T5100 and  
the GRiDCase 1530

Mark L. Van Name

**W**hen IBM PC-compatible portable computers first appeared, you needed arms like a gorilla to carry them. You were limited to an 8088 CPU, 640K bytes of RAM, 320K-byte floppy disk drives, and a small monochrome screen, if you were lucky. Portable computers have come a long way since then.

Toshiba and GRiD are now offering two of the first 80386-based true portables. GRiD's GRiDCase 1530 runs off battery power, and the Toshiba T5100 requires 115 volts AC. Other than that difference, the two systems I reviewed are very similar. Both are sleek units weighing 15 pounds or less that, when closed, are about a foot wide, a little over a foot deep, and a couple of inches high. You open both of them from the front, where the screen swings up to reveal the keyboard.

Both computers use the 80386 CPU, but the T5100's runs at 16 MHz, while the GRiDCase 1530 uses a slower 12.5-MHz speed to help conserve power. Both have 2 megabytes of memory, a 40-megabyte internal hard disk drive, a jack for an external keyboard, one DB-9 serial port, one DB-25 parallel port, and one RGB connector for an external monitor. Each also has a gas-plasma display, but the T5100's is EGA-compatible, while the GRiDCase 1530 offers only CGA graphics, with an optional expansion cartridge that supports an external VGA monitor. The T5100 also includes an internal 1.44-megabyte 3½-inch floppy disk drive, while the GRiDCase 1530 came with its optional 1.44-megabyte 3½-inch external floppy disk drive. Both systems run versions of MS-DOS.

The GRiDCase 1530 includes an external peripheral port to which you can connect devices such as the external floppy disk drive. To connect an external drive to the T5100, you use the parallel port and a switch on the front left side of the system. The switch lets you make that port act as the connection to drive A or drive B, or as a normal parallel port.

The T5100 I reviewed, which included MS-DOS, is the standard T5100 unit. It has a retail price of \$7499.

The GRiDCase 1530 also came with an optional internal 2400-bit-per-second Hayes-compatible modem, a 20-watt-hour internal battery, and both a 35-W and a 70-W battery charger/AC power supply.

The standard model of the GRiDCase 1530, with a list price of \$4695, initially appears much cheaper than the T5100. However, the standard GRiDCase 1530 has only 1 megabyte of RAM, two internal 3½-inch floppy disk drives, and a 10-inch diagonal backlit liquid crystal display (LCD); it runs only on AC power, and it has no hard disk drive. It also does not include any software. To make it comparable to the T5100, you

*continued*

GRiDCase 1530 (left) and Toshiba T5100 (right).



### GRiDCase 1530

#### Company

GRiD Systems Corp.  
47211 Lakeview Blvd.  
Fremont, CA 94538  
(415) 656-4700

#### Components

**Processor:** 16-MHz 80386 running at 12.5 MHz, with compatibility speed of 6 MHz; socket for 16-MHz 80387 coprocessor running at 12.5 MHz  
**Memory:** 2 megabytes of 32-bit 120-ns DRAM on motherboard, expandable to 8 megabytes; 128K bytes of BIOS ROM  
**Mass storage:** 1.44-megabyte external 3½-inch floppy disk drive; 40-megabyte internal hard disk drive  
**Display:** Gas-plasma; orange letters on a black background; CGA-compatible; seven shades of orange  
**Keyboard:** 72-key IBM PC keyboard layout; 10 function keys  
**I/O interfaces:** One DB-9 RS-232C serial port; one DB-25 parallel port; DB-9 RGB monitor port; external peripheral DB-25 port; DIN external keyboard connector; two 256K-byte ROM sockets

#### Size

11½ x 15 x 2½ inches; 13¼ pounds

#### Software

None

#### Options

10-inch diagonal 640- by 400-pixel plasma display: \$995  
2-megabyte memory upgrade: \$595  
16-MHz 80387 coprocessor: \$1195  
20-megabyte hard disk drive and 1.44-megabyte 3½-inch floppy disk drive: \$1175  
40-megabyte hard disk drive: \$1675  
External 1.44-megabyte 3½-inch floppy disk drive: \$350  
External 360K-byte 5¼-inch floppy disk drive: \$395  
MS-DOS 3.21 (on disk): \$150  
MS-DOS 3.21 (in ROM): \$200  
Rechargeable battery pack: \$70  
Battery charger: \$90  
AC power pack: \$195  
Internal 1200-bps Hayes-compatible modem: \$395  
Internal 2400-bps Hayes-compatible modem: \$595  
Expansion chassis and expansion bus interface cartridge: \$1295  
VGA cartridge: \$695

#### Documentation

GRiDCase 1500 Series Owners Guide

#### Price

Model 1530: \$4695  
System as reviewed: \$9375

#### Inquiry 896.

### Toshiba T5100

#### Company

Toshiba America, Inc.  
Information Systems Division  
9740 Irvine Blvd.  
Irvine, CA 92718  
(714) 583-3000

#### Components

**Processor:** 16-MHz 80386, with compatibility speed of 8 MHz; socket for 16-MHz 80387 coprocessor  
**Memory:** 2 megabytes of 32-bit 80-ns DRAM on motherboard, expandable on a memory card to 4 megabytes; 128K bytes of BIOS ROM  
**Mass storage:** 1.44-megabyte 3½-inch floppy disk drive; 40-megabyte internal hard disk drive  
**Display:** Gas-plasma; bright orange letters on a darker orange background; EGA-compatible; four shades of orange  
**Keyboard:** 82-key IBM PC keyboard layout (101-key compatible); 10 function keys; indicator lights for Caps, Num, and Scroll Lock; cursor and page control keys; numeric keypad available by using a special function key  
**I/O interfaces:** One DB-9 RS-232C serial port; one DB-25 parallel/floppy disk drive port; DB-9 RGB monitor port; DIN external keyboard connector; expansion slot designed for proprietary Toshiba cards

#### Size

12½ x 14¼ x 3½ inches; 15 pounds

#### Software

Toshiba's MS-DOS 3.30 (includes TEST), a diagnostic and setup program, and XCHAD, a program for controlling the mapping of colors to the T5100's four gray shades); Microsoft Windows/386

#### Options

2-megabyte memory-expansion card: \$1299  
External 360K-byte 5¼-inch floppy disk drive: \$499  
Internal 1200-bps Hayes-compatible modem: \$399  
Carrying case: \$99  
PC Floppy Link: \$199  
Expansion chassis: \$999  
Expansion chassis interface card: \$199  
GWBasic 3.0: \$75

#### Documentation

The First Time; T5100 Reference Manual; T5100 Portable Companion; MS-DOS 3.30 Operating System; MS-DOS 3.30 Operating System Quick Reference

#### Price

Standard T5100 system (as reviewed): \$7499

#### Inquiry 895.

have to add an additional megabyte of RAM, a 40-megabyte hard disk drive (in place of one floppy disk drive), an external floppy disk drive, a gas-plasma display, and MS-DOS. These options bring the GRiDCase 1530's price up to \$8780—or \$1281 more than a comparable T5100.

### Working on the Road

While an AC power supply is standard equipment on both units, the GRiDCase 1530 can also run on a rechargeable internal 20-watt-hour nickel-cadmium battery. The battery is fairly large (5¼ by 2¼ by 1½ inches) and fits into a slot in the rear left of the machine. It goes in easily, and you are supposed to be able to pop it out by pushing on a tab underneath it. However, I could get it out only by hitting the tab with a blunt instrument.

The GRiDCase 1530's manual includes a section and table that discuss battery life. The table lists each major possible system component (such as the LCD or plasma screen or the optional 80387 coprocessor) and the amount of power it draws. The internal battery pack is supposed to supply 20 watt-hours of power, and from that figure and the table, you can calculate how long the battery should last on your system.

I tested the system several times with a fully charged battery, and it lasted an average of about 31 minutes. The system was admittedly fairly power-hungry because of its hard disk drive and plasma display. Any system that uses an 80386, however, almost certainly needs a hard disk drive, and the plasma display is much easier on the eyes than the LCD screen. GRiD also has an optional 54-watt-hour external battery pack that can more than double your time in the field.

The GRiDCase 1530 has a red battery-low light that warns you, well in advance, that the machine is about to run out of power. Further, if you install a special GRiD device driver, the computer will beep at you approximately every 30 seconds, starting about 10 minutes before the failure.

### Looking and Typing

Aside from the type of power it requires, perhaps the most important other aspects of any portable computer concern how it feels in use. Screen and keyboard quality are crucial.

The T5100 has a 9¼-inch diagonal gas-plasma monitor that displays bright orange characters on a darker orange background. There are contrast and brightness knobs on the swivel arm that

*continued*



# Toshiba T5100 GRiDCase1530

## APPLICATION-LEVEL PERFORMANCE

Toshiba T5100 **11.7\***

WORD PROCESSING	Toshiba Med./Lrg.	GRID Med./Lrg.	DATABASE dBASE III+ 1.1	Toshiba	GRID
XyWrite III+ 3.52					
Load (large)	:14	:19	Copy	:46	1:24
Word count	:03/:24	:04/:32	Index	:12	:21
Search/replace	:06/:35	:09/:34	List	1:23	1:52
End of document	:02/:19	:02/:21	Append	1:21	2:21
Block moves	:11/:11	:15/:15	Delete	:01	:02
Spelling check	:10/:14	:14/:40	Pack	1:02	1:41
<b>Microsoft Word 4.0</b>			Count	:10	:18
Forward delete	:15	:22	Sort	:51	1:31
<b>Aldus PageMaker 1.0a</b>			<b>Index:</b>	<b>2.23</b>	<b>1.29</b>
Load document	:04				
Change/Bold	:30		<b>SCIENTIFIC/ENGINEERING</b>		
Align right	:23		<b>AutoCAD 2.52</b>		
Cut 10 pages	:21		Load SoftWest	1:02	1:21
Place graphic	:06		Regen SoftWest	:54	1:02
Print to file	2:27		Load StPauls	:12	:17
<b>Index:</b>	<b>2.39</b>	<b>1.75</b>	Regen StPauls	:07	:11
			Hide/redraw	13:37	20:54
<b>SPREADSHEET</b>			<b>STAT 1.5</b>		
<b>Lotus 1-2-3 2.01</b>			Graphics	:27	:42
Block copy	:04	:05	ANOVA	:15	:26
Recalc	:01	:02	<b>MathCAD 2.0</b>		
Load Monte Carlo	:19	:20	IFS 800 pts.	:17	:28
Recalc Monte Carlo	:04	:08	FFT/IFFT 1024 pts.	:17	:29
Load rlarge3	:05	:05	<b>Index:</b>	<b>3.05</b>	<b>2.03</b>
Recalc rlarge3	:01	:01			
Recalc Goal-seek	:04	:07	<b>COMPILERS</b>		
<b>Microsoft Excel 2.0</b>			<b>Microsoft C 5.0</b>		
Fill right	:06	:07	XLisp compile	5:51	7:35
Undo fill	2:11	2:23	<b>Turbo Pascal</b>		
Recalc	:02	:02	Pascal S compile	:08	:08
Load rlarge3	:29	:35	<b>Index:</b>	<b>1.51</b>	<b>1.36</b>
Recalc rlarge3	:01	:02			
<b>Index:</b>	<b>2.47</b>	<b>1.91</b>			

All times are in minutes:seconds. Indexes show relative performance; for all indexes, an 8-MHz IBM PC AT = 1.

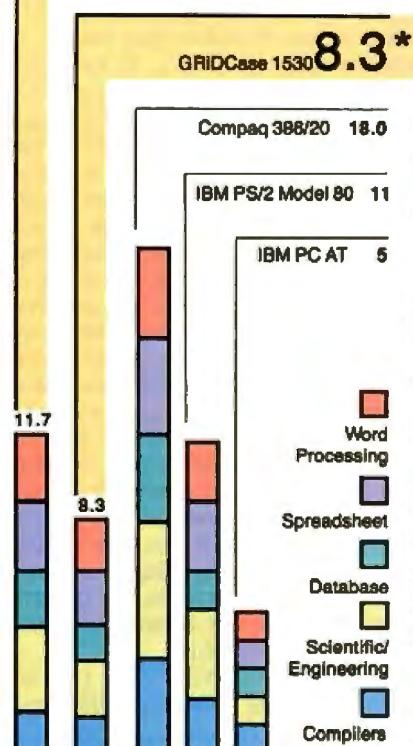

\*Cumulative applications index. Graphs are based on indexes at left and show relative performance.

## LOW-LEVEL PERFORMANCE<sup>1</sup>

CPU	Toshiba	GRID	DISK I/O	Toshiba	GRID	VIDEO	Toshiba	GRID
Matrix	4.67	6.35	Hard Seek <sup>4</sup>			Text		
String Move			Outer track	3.34	3.32	Mode 0	5.00	12.49
Byte-wide	40.83	52.87	Inner track	3.31	3.32	Mode 1	5.00	12.47
Word-wide			Half platter	8.77	8.30	Mode 2	4.78	13.05
Odd-bnd.	40.57	52.69	Full platter	11.06	11.50	Mode 3	4.60	13.04
Even-bnd.	20.43	27.66	Average	6.62	6.61	Mode 7	N/A	N/A
Sieve	28.78	38.34	<b>DOS Seek</b>			<b>Graphics</b>		
Sort	22.36	44.12	1-sector	9.50	9.82	CGA:		
<b>Index:</b>	<b>2.39</b>	<b>1.68</b>	32-sector	22.93	33.17	Mode 4	2.19	2.89
			<b>File I/O<sup>5</sup></b>			Mode 5	2.22	2.91
<b>FLOATING POINT<sup>2</sup></b>			Seek	0.16	0.30	Mode 6	2.31	3.02
<b>Math</b>			Read	0.02	0.02	EGA:		
Error <sup>3</sup>	9.54	23.54	Write	0.02	0.02	Mode 13	4.21	N/A
Sine(x)	4.36	8.67	<b>1-megabyte</b>			Mode 14	4.55	N/A
Error	2.00E-09	2.00E-09	Write	8.77	11.62	Mode 16	4.56	N/A
e <sup>x</sup>	4.15	8.64	Read	7.16	12.58	<b>Index:</b>	<b>1.90</b>	<b>1.25</b>
Error	1.77E-02	1.77E-02	<b>Index:</b>	<b>4.06</b>	<b>3.12</b>			
<b>Index:</b>	<b>4.53</b>	<b>2.09</b>						

N/A=Not supported by graphics adapter.

<sup>1</sup> All times are in seconds. All figures were generated using the 8088/8086 version (1.1) of Small-C (16-bit integers). Figures for 80386 machines do not use 80386-specific instructions.

<sup>2</sup> The floating-point benchmarks use 8087-compatible instructions only.

<sup>3</sup> The errors for the floating-point benchmarks indicate the difference between expected and actual values, correct to 10 digits or rounded to 2 digits.

<sup>4</sup> Times reported by the Hard Seek and DOS Seek are for multiple seek operations (number of seeks performed currently set to 100).

<sup>5</sup> Read and write times for the File I/O benchmarks are in seconds per 64K byte.

<sup>6</sup> For the Livermore Loops and Dhrystone tests only, higher numbers mean faster performance.

## CONVENTIONAL BENCHMARKS

	Toshiba	GRID
LINPACK	236.88	448.30
Livermore Loops <sup>6</sup> (MFLOPS)	0.11	0.06
Dhrystone (MS C 5.0) (Dhry/sec)	4118.00	2944.00

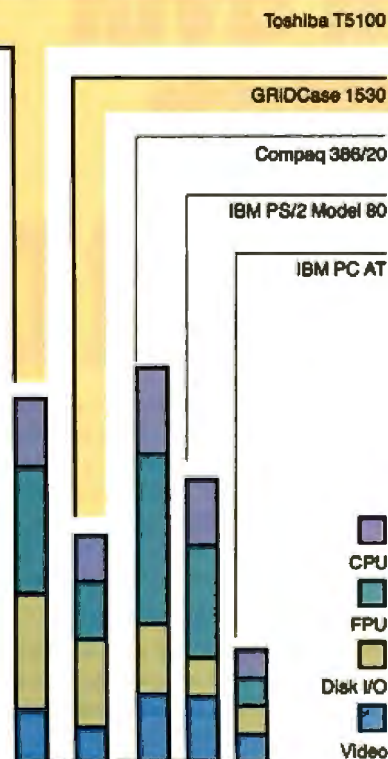



supports the screen.

The monitor is EGA-compatible. The T5100 maps each of the 16 possible EGA colors to one of its four gray shades, or levels of intensity (off,  $\frac{1}{4}$ ,  $\frac{2}{4}$ , and full). Toshiba and Paradise did the EGA BIOS jointly, while the EGA chip is Paradise's PEGA-2. If you install a special device driver, the T5100 will copy the EGA ROM BIOS into the faster system RAM.

You can sometimes get into trouble with the default color-to-gray-scale mappings. For example, the calculator in Borland's SideKick displays numbers that are by default the same shade as the background. Fortunately, Toshiba provides a nice utility, XCHAD (Enhanced Change Display), that addresses this problem. If you load XCHAD as a terminate-and-stay-resident (TSR) program, you only have to enter Alt-SysReq, and it will clean up the screen so that you can see everything on it. It does so by reading the screen and then mapping the colors to gray scales that provide the greatest amount of contrast between adjacent pixels of different colors.

The screen in the GRiDCase 1530 is a 10-inch-diagonal CGA-compatible gas-

plasma display. It displays orange letters on a black background. There is a sliding brightness control on the bottom right of the screen, but I could never see any difference in the screen regardless of the control's position. A Yamaha video chip provides the CGA emulation.

Like the T5100, the GRiDCase 1530 maps colors to gray scales. It offers seven levels of intensity:  $\frac{1}{4}$ ,  $\frac{1}{3}$ ,  $\frac{1}{2}$ ,  $\frac{2}{3}$ ,  $\frac{3}{4}$ , full intensity, and off. Some of these levels are very close, however; only three or four are easily visible. The 1530 comes with six predefined color mappings. A GRiD spokesperson said that these mappings were enough to support nearly all MS-DOS applications. You can cycle through them with a key sequence or choose one with one of GRiD's extensions to the MS-DOS MODE command.

Both the T5100 and the GRiDCase 1530 let you connect an external monitor (EGA for the T5100 and CGA for the 1530). Both let you alternate between the internal and external displays by using a special key sequence. However, neither system lets you display the same image on both screens simultaneously.

The GRiDCase 1530's black back-

ground is much more soothing to the eyes than the bright orange background of the T5100's display. However, the finer standard font on the T5100 and its EGA capabilities make it more pleasant for prolonged text work.

Just as these machines have similar displays, so, too, do they follow similar approaches in their keyboard layouts. Both keyboards are small and are attached, integral parts of the system. Both have fewer than the 101 keys of the IBM Enhanced keyboards. They get around this deficiency by using a special function key, Fn, in multikey sequences to simulate "missing" keys, such as those normally on the numeric keypad. Both also provide a DIN jack to which you can connect any external AT-compatible keyboard.

The T5100's keyboard has a pleasant feel, with strong tactile feedback and an audible keyclick. There are Caps, Num, and Scroll Lock indicators on the screen swivel arm. The 82 keys are arranged much like an IBM PC's, but with the 10 function keys across the top. The left side of the keyboard follows that same stan-

*continued*

# Travel With A Fast Crowd.



Wherever your business takes you, take along the WorldPort 2400™ Portable Modem. Leaving the office doesn't have to mean leaving behind the world of high-speed, 2400 bps communications. Worldwide, in virtually every situation, including hotel rooms and phone booths, your ability to communicate clearly and efficiently remains intact.

Representing the cutting edge of modem technology, the WorldPort line of portable modems combine a broad range of features that bring you the best value in modems today. Features

that go far beyond costly internal units, such as Bell and CCITT standards, direct connect and acoustic interface (300 and 1200 bps), battery power, shirt pocket size, and a tiny price.

In fact, the WorldPort modems are the ultimate for both portable and desktop applications. And the WorldPort 2400 comes with Carbon Copy PLUS™ communications software, for even greater value.

If you want a modem that works where you do, put the WorldPort Series to work for you. In

the office. On the road. Or at home. For more information about our full line of WorldPort modems, or the name of your nearest dealer, call us at 800-541-0345. (In New York, 516-261-0423.)



Touchbase Systems, Inc.  
160 Laurel Avenue  
Northport, NY 11768  
(516) 261-0423  
TELEX: 6502848020  
FAX: (516) 754-3491

WorldPort 2400 is a trademark of Touchbase Systems, Inc. Carbon Copy PLUS is a trademark of Mendian Technology, Inc.

# VIDEOTRAX DATA BACK-UP. WE JUST INTRODUCED IT. AND ALREADY 50 MILLION PEOPLE OWN HALF OF IT.

Every human in the hemisphere who owns a standard VCR has half of what's needed to back up data. The rest of what you need is neatly contained on the new Videotrax<sup>®</sup> controller board by Alpha Micro.

Slip the half-size Videotrax board into the expansion slot of any PC. Meaning any IBM<sup>®</sup>, PC, XT, AT, Compaq<sup>®</sup> 386 or true compatible.



*High-tech. Open your PC and slide the controller board into any expansion slot. Low-tech. Hook up VCR to computer with standard connector cables.*

Connect the computer to a VCR with standard connector cables. And, as of that moment, you are under the protection of a highly sophisticated, stringently reliable, data backup system.

In fact, exhaustive testing and the long term experience of over 20,000 Alpha Micro users have proven Videotrax technology to be more reliable than any other backup option available. More dependable, even, than

the hard disk you're covering for.

## QUICK STUDY

Videotrax has been designed to extremely demanding standards. So that it won't put a lot of demands on you. Anyone who can run a VCR knows most of the drill. The rest is covered by our menu-driven software. By clear, concise documentation. And by a range of backup modes that keeps it simple:

Insert a blank video cassette tape and follow the directions which appear on screen. These guide you through the painless steps for copying or restoring an entire hard disk, specific files, or only files modified since the last backup.

Meanwhile, Videotrax rigorously monitors itself for proper functioning. **WE MAKE THE VCR PART OF IT, TOO.**

If you like, opt for our enhanced Videotrax VCR and experience the extra joy of its automatic, unattended backup capabilities.

It will be a most prudent investment. Because, for the price of

taping Dallas you can preserve your most precious data. Up to 80MB on a single



*Your basic video cassettes. Reliable, inexpensive, easy to find.*

cassette, at less than a tenth of the cost of streamer tape.

And now the price is low. Just \$399 for the board and \$1199 for the board and enhanced VCR, suggested retail.

And of course, if you ever require service, your authorized Alpha Micro dealer and our worldwide network of factory service centers will provide all the support you need.

For the name of your nearest Videotrax dealer, call Alpha Micro at 1-800-992-9779. In California, call 1-800-821-0612.

The Videotrax System. It's a great leap forward in backing up.

**Circle 14 on Reader Service Card (DEALERS: 15)**



Corporate Headquarters: 3501 Sunflower, P.O. Box 25060, Santa Ana, CA 92709  
© Alpha Microsystems 1983. All rights reserved. IBM is a registered trademark of International Business Machines. Videotrax is a registered trademark of Alpha Microsystems. Compaq is a registered trademark of Compaq Computer Corp. Radio Shack Computer Center is a registered trademark of Tandy Corporation.

Available at **Radio Shack** Computer Centers<sup>®</sup>/Plus Computer Centers and other fine computer dealers worldwide.



# "Give me one good reason to give up C."

## "How about 43?"

Modula-2 saves more time and money than any other programming environment.

1. High-level language
2. Readable, maintainable code
3. Ideal for team programming
4. Supports multi-tasking
5. Emerging international standard
6. Pascal or C programmers learn it in hours
7. Language for modern engineering
8. Consistency checks across modules
9. User control over exported/imported objects
10. Traps most programming errors
11. Fewer bugs in final code
12. Easy low-level access

The LOGITECH Modula-2 programming environment goes far beyond the language.

13. Faster project throughput
14. Corporations rely on it
15. Adds a rich set of tools to the language
16. Best debuggers for any language
17. Configurable, easy to use text editor
18. Integrated environment
19. Powerful windowing interface
20. Compiles twice as fast as MS-C
21. Code as fast as the best C compilers
22. Mature and reliable
23. Extended library
24. Standard object format
25. C libraries can be used
26. Supports EGA 43-line mode
27. Automatic MAKE
28. Flexible overlays
29. Price/performance leader

dard, but on the right it diverges. There it has special arrow, Home, PageUp, PageDown, End, Insert, and Delete keys. You get the numeric keypad numbers, +, -, and decimal point, as well as F11 and F12, by using Fn and another key. To make it easy for you to find these other characters, alternate key functions appear in blue on the front of the keys. By using the Fn key, you can get this keyboard to generate all the key sequences of the IBM Enhanced keyboard.

The keyboard on the GRiDCase 1530 has only 72 keys—10 fewer than the T5100's—but it follows the same approach to provide other keys, such as those on the numeric keypad. Its action feels mushy at first, but the keys spring back quickly. It also has a much softer keyclick than the T5100. There are no indicator lights, not even for Caps or Num Lock—a tiny omission that I found annoying.

It also has the 10 function keys across the top, but it unfortunately also has Backspace up there, well beyond its usual position. There are four arrow keys on the right side, but you can get the other numeric keypad keys only by using the Fn key. Alternate key functions appear in different colors on the keys. There are also a few printable characters, including square brackets, curly brackets, and the tilde character, that you get only by using the Fn key. Programmers (especially C programmers) may find this bothersome.

### Performance and Compatibility

As you can see in the performance charts, the T5100 is about the same speed as the 16-MHz IBM PS/2 Model 80. This performance puts it right in the middle of the zippy 16-MHz 80386 pack but still leaves it behind the 20-MHz and 25-MHz speedsters.

The GRiDCase 1530 is roughly 30 percent slower than the T5100. Most of this difference must come from its 28 percent slower 12.5-MHz clock. The 1530 actually uses a 16-MHz chip, but it runs with a slower clock to save power.

There are a few performance anomalies worth noting. While both units use the same basic hard disk drive, the T5100 actually beats the GRiDCase 1530 on the File I/O Seek test. The T5100 has its typical 30 percent edge on the 1-megabyte file Write and Read tests, and takes the Disk I/O tests overall.

The T5100 also has an unusually large edge on both the floating-point tests and tests involving applications that do a lot of floating-point math (e.g., the Engineering/Scientific application tests).

Both machines have a socket for an 80387; the T5100's runs at 16 MHz, and the GRiDCase 1530's runs at 12.5 MHz.

One reason these systems don't break out of the 16-MHz pack is that they do nothing special to help speed memory access. For example, neither system uses a hardware cache. The T5100 uses 80-nanosecond dynamic RAM (DRAM), which leaves it with one wait state. The GRiDCase 1530 also has one wait state, although its slower clock speed lets it get away with 120-ns DRAM chips.

On the compatibility front, there is some obvious hardware bad news and lots of mostly good software news.

The hardware bad news is that neither of these systems can handle even one standard IBM PC expansion card. Both let you expand system memory by adding memory within the main unit—with single in-line packages (SIPs) in the 1530, and with a memory-expansion card in the T5100.

You can expand the T5100 in two other basic ways. There is one expansion slot in the right rear of the machine. It is a proprietary slot that works only with cards designed for the T5100 and, usually, the T3100, T1200, and T1100 Plus. (A card will work in all these units as long as it does not play with memory addressing in any unusual ways.) You typically would use this slot to hold an internal modem. However, you can also use it for the other major expansion option: a card that lets you attach Toshiba's external expansion chassis, which can handle full-length cards.

The GRiDCase 1530 also offers an optional interface card and expansion chassis for full-length cards, but it does not have an explicit expansion slot. Instead, you use a GRiD-proprietary expansion cartridge that fits into the battery slot. You can also buy other expansion cartridges from GRiD, including one that supports VGA graphics on external VGA-compatible monitors. The 1530 offers one other odd expansion option: It has sockets on the main face of the unit, above the keyboard and before the screen, for two ROM chips. GRiD offers its MS-DOS, as well as several other software packages, on such ROM chips.

These machines run nearly all PC-compatible software. I ran them both through a test suite that included a copy-protected Lotus 1-2-3 version 2.0; DESQview 2.0 and its accompanying Quarterdeck Expanded Memory Manager 386 version 1.0; Kermit 2.30; Norton Utilities 3.0; Microsoft's Windows/386 2.03, Word 4.0, and PC Paintbrush 2.0; WordStar 3.3 and 4.0; Q&A 1.1;

Digitalk's Smalltalk/V 1.2; and Borland's Quattro 1.0, Turbo C 1.5, Turbo Basic 1.1, Turbo Pascal 4.0, Reflex 1.14, SideKick 1.56A, and SuperKey 1.16A.

The T5100 has one software compatibility problem: It will not run Windows/386. When I tried, I got the message: Error: Unsupported DOS version. A Toshiba technical-support person said that Toshiba is aware of this problem and that it should go away when Toshiba releases MS-DOS 3.3 for the T5100.

The 1530 also seemed to have a compatibility problem, but there was a way around it. The Quarterdeck Expanded Memory Manager 386 version 1.0 would not work, and instead reported: No room for Page Frame. Cannot load because there is not enough memory. GRiD's own expanded memory manager (GRiD-386) worked like a champ, however. A GRiD support person led me to try putting the page frame at memory locations C000x and D000x hexadecimal, both of which worked. He said that the error was due to my old version of the Quarterdeck software, and that it would not occur with a newer version.

If necessary, both machines can operate at a slower compatibility speed. The T5100 offers 8-MHz operation; the 1530 can run at 6 MHz. However, they each ran Lotus 1-2-3 version 2.0 without making me slow them to their compatibility speeds.

### Digging Inside

Getting inside most personal computers is a fairly simple matter; not so with these tightly packed portables. I don't recommend that you take one of these apart unless you are willing to move very slowly and carefully.

The bottom of the T5100 curves slightly, so when its rear tilt stand is up, the keyboard sits flat. To accommodate this bend, the motherboard, which runs along the bottom of the machine, is in two pieces: There's a small piece under the keyboard, and a larger one under the rest of the machine.

The section under the keyboard is attached to the main section by several wide ribbon cables and is easily accessible. It contains the ROM chips, the keyboard controller, the memory, and some support chips. It also contains an expansion connection for the memory-expansion board, which goes to its right. This board can increase the system memory to 4 megabytes of 32-bit memory. You can make the T5100 copy the ROM BIOS (from Award and Toshiba) into the faster RAM by choosing the fast ROM option

in the T5100's Setup program.

The T5100's memory chips are 1-megabit chips mounted on single in-line memory modules. The SIMMs are soldered, not socketed. There is also a small daughtercard, seated above the main part of the motherboard, that holds the EGA chips, 256K bytes of EGA memory, and some other support chips.

The main piece of the motherboard contains the 80387 socket, the 80386, and a number of Toshiba chips; many of the chips are surface-mounted. Not counting the memory chips, the three motherboard components contain a total of only about 70 chips. The boards are clearly manufactured by Toshiba and use many Toshiba parts.

The GRiDCase 1530 has a flat bottom, so it has a single main motherboard. It also has a daughtercard above part of the motherboard. GRiD manufactures both boards. The daughtercard contains the Yamaha CGA chip and the sockets for the two ROM-expansion chips that you can install.

The main motherboard contains 109 chips, not counting DRAM chips, but very few are surface-mounted. Its 2 megabytes of DRAM are mounted in eight 256K-byte SIPs. You can replace some or all of these SIPs with 1-megabyte versions to get either 4 or 8 megabytes of RAM. The motherboard contains the 80386, the 80387 socket, the ROM BIOS chips, and four large Faraday chips, among many other chips. The four Faraday chips do much of the standard AT work, while most of the others provide the discrete logic that handles the 80386 and its 32-bit memory bus. The 1530's ROM BIOS is Phoenix's 80386 ROM BIOS version 3.06, dated 3/17/88.

Both machines use the same Conner 40-megabyte hard disk drive. This drive has a formatted capacity of 40.8 megabytes and an average access time of 29 milliseconds.

Toshiba made a modification to its setup and MS-DOS that lets you avoid the usual 32-megabyte partition limit and have a single 40-megabyte partition. The T5100 uses 1024-byte sectors to support this larger partition.

The floppy disk drives of the two machines are standard 1.44-megabyte 3½-inch models. The T5100 uses a Toshiba drive; the GRiDCase 1530's external drive is from Epson.

### The Rest of the Package

The T5100 comes with Toshiba's MS-DOS 3.30, and you can buy GWBASIC 3.0 as an option. Toshiba's MS-DOS in-

*continued*



## Announcing Modula OS/2. The operating system finally catches up with the language.

- 30. Support for dual mode operations
- 31. Dynamic link libraries
- 32. For standard/extended version of OS/2
- 33. Multiple threads
- 34. Virtually unlimited program size
- 35. Makes mixing languages easy
- 36. Most powerful editor under OS/2
- 37. Background compilation while editing
- 38. Run-time checks
- 39. Stack checks even in threads
- 40. OS/2 uses Modula-2 parameter passing mechanism
- 41. Upgrade available for Modula-2 DOS users
- 42. Direct Hotline and free Bulletin Board support for all Modula-2 products

### 43. It's affordable!

Call toll-free:  
800-231-7717  
In California:  
800-552-8885

Please send me:

- Modula-2 Compiler Pack (DOS) \$ 99.00
- Modula-2 Toolkit (DOS) \$ 169.00
- Modula-2 Development System (DOS, includes Compiler and Toolkit) \$ 249.00
- Modula OS/2 \$ 349.00
- Modula-2 VAX/VMS version \$2,500.00
- Shipping & Handling (per item) \$ 6.50
- CA residents add applicable sales tax \$ \_\_\_\_\_
- Total \$ \_\_\_\_\_
- Check/money order Included
- Visa  MasterCard

Card Number \_\_\_\_\_ Exp. Date \_\_\_\_\_

Cardholder Name \_\_\_\_\_

Authorized Signature \_\_\_\_\_

Ship to: \_\_\_\_\_

Name \_\_\_\_\_

Address \_\_\_\_\_

City \_\_\_\_\_ State \_\_\_\_\_

Zip \_\_\_\_\_ Phone \_\_\_\_\_

Offer valid in U.S. Only Dealer Inquiries welcome. Educational prices available. BY988

Send to:



Logitech, Inc.

Attn: Coupon Redemption Program  
6505 Kaiser Drive, Fremont, CA 94555

In Europe, contact:

LOGITECH SA In Switzerland

Tel: ++41 (0) 21-869-96-56

In the United Kingdom, contact:

LOGITECH UK

Tel: ++44 (0) 525-22-22-11



cludes setup options that let you allocate memory above 640K bytes to expanded and/or extended memory. A Toshiba spokesperson said that the company would be offering Unix and OS/2 in the future. With the T5100, Toshiba is also bundling Lotus's Metro, a desktop manager with 12 accessories and a macro generator.

The T5100 also comes with a boxed set of five manuals. This set includes an MS-DOS 3.30 reference manual, an MS-

DOS quick reference guide, a manual for new users, a T5100 reference manual, and a thin "Portable Companion" manual that summarizes most of the information in the T5100 reference manual. The reference manual is particularly useful, with thorough explanations of nearly all the system's features.

The standard GRiDCase 1530 does not include any software. You can buy GRiD's MS-DOS 3.21; its MS-DOS extensions include many new MODE options

that let you control hardware options, a GRiDScan program that gives system configuration information, and the GRiD386 expanded memory manager.

A GRiD spokesperson said that the 1530 will run both the Santa Cruz Operation's (SCO) Xenix System V and Interactive Systems' 386/ix Unix; GRiD sells only the SCO Xenix, however. The spokesperson said that GRiD was experimenting with OS/2 and would offer it when enough customers requested it.

The GRiDCase 1530 comes with an owner's guide and short reference manuals for each of the hardware options. You also get an MS-DOS manual if you buy that option. The owner's guide is short but useful, with a fairly thorough discussion of the system's options, including much useful information on its battery usage and power requirements.

The telephone-support people at both companies were among the best with whom I've had the pleasure to talk. They were able to answer nearly all my questions, including very technical ones, quickly and correctly. Those few that they could not answer, they researched and answered later. There does not seem to be any limit on the telephone support that either company offers, and you can reach both support services through toll-free numbers.

The T5100 comes with Toshiba's one-year "Exceptional Care" limited warranty. You can buy an additional two years of support, but it is expensive: \$979 for the basic unit alone, and more for each option.

The GRiDCase 1530 includes a 90-day limited warranty.

### Juggling Options

Given the short life of my GRiDCase 1530's battery, battery operation seems to be for occasional use only. If you need that capability and can do without EGA graphics, it is a good machine. It also provides a cheaper entry-level model than the T5100.

The T5100 has a higher price for an entry-level machine, but if you want a faster CPU and EGA graphics at a less expensive price (for comparably equipped machines), and if you do not have the need to run from a battery, go with the T5100.

Both machines are signs of the times and of things to come: ever more power in ever-smaller, sleeker packages. ■

*Mark L. Van Name is a freelance writer and computer consultant living in Durham, North Carolina. He can be reached on BIX as "editors."*



**DATAPRO**  
Means Accurate.

*Information. We base our purchases on it. Formulate opinions from it. Make intelligent decisions with it.*

*Provided... it is correct. Inaccurate information is oftentimes less useful than none at all. It leads to misinterpretation. And in making a poor choice.*

*Datapro means accuracy. Our information services contain up-to-date documented reports on products and*

*services in microcomputers, information processing and data and voice communications. Reports that help you separate truth from fiction. And in today's ever-changing industry, that requires constant research and review. Our product and pricing comparisons are carefully developed. Technology reports are documented. User ratings are statistically analyzed. Competitive reports are scrutinized. And How-to-Advice columns are meticulously edited.*

*Start making your decisions based on the facts. To receive your free literature pack on Datapro's subscription services, call us today at 1-800-DATAPRO (1-800-328-2776) or use the reader service card.*

**datapro** 

# Great Selection + Superior Service + Competitive Prices = Top Value

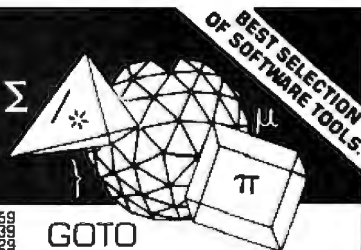

BEST SELECTION  
OF SOFTWARE TOOLS

We have the technical expertise to fulfill your specialized needs in software development, circuit design, data analysis, CAD and much more. Call today!

- No one offers you more variety.
- 30-day Money-Back Guarantee\*
- Latest versions
- Over 500 name-brand products in stock, if you don't see it — call!

## Software Development Tools

ASSEMBLERS	
ADVANTAGE Disassembler, Lifeboat	\$ 279
Microsoft MASM	99
OPTASM, SLR Systems	109
BASIC	
Flash-up, Software Bottling Co.	\$ 80
MS Basic Com. 6.0	189
MS QuickBASIC	59
QuickPak, Crescent Software	60
T BASIC, TransEra Corp.	453
Turbo Basic, Borland	69
Turbo Basic Toolboxes, Borland	69
C	
AZTEC C-Commercial, Manx	\$ CALL
C-term, Gimpel	536
Lattice C V. 3.3	199
m/Source	484
Microsoft C	99
QuickC, Microsoft	99
Turbo C, Borland	99
LIBRARIES	
C TOOLS PLUS 5.0, Blaise	\$ 101
C Utility Library, Essential	125
Essential Communications	125
Greenleaf Turbo Functions	1059
Greenleaf Coma Library	155
Greenleaf Functions	155
Pfor-C, Phoenix	215
TimeSlicer, Lifeboat	279
Turbo C TOOLS, Blaise	101

COBOL	
Micra Focus Products	\$ CALL
MS COBOL, Microsoft	452
Realia COBOL	754
RM/COBOL, Austec	754
SCREENIO, Marcom	392
PASCAL	
MS Pascal, Microsoft	\$ 199
Pascal-2, Oregon Software	159
Turbo Pascal, Borland	69
Professional Pascal, Metaware	549
PASCAL LIBRARIES (TURBO)	
Turbo Pascal Dev. Lib., Borland	\$ 289
Metabyte Data Acq. TOOLS, Quinn-Curtis	90
Turbo Pascal S & E Tools, Quinn-Curtis	69
Turbo HALO, Media Cybernetics	80
Turbo MAGIC, Sophisticated Software	175
Turbo ASYNCH PLUS, Blaise	101
Turbo Power Tools Plus, Blaise	101
MODULE-2	
LOGITECH Module-2	\$ 81
Compiler Kit	199
Development System	141
Toolkit	141
SOLID B - Toolbox, Solid Software	89
StonyBrook Module-2	179
386 DEVELOPMENT TOOLS	
386-Max, Qualitas	\$ 66
ADVANTAGE 386 C, Lifeboat	839

FORBASE - /386	459
Hill C, Metaware	939
NOP FORTRAN, Microway	259
Pharlap 386/ASM/LINK	409
386 SOFTWARE	
DEBVIEW, Quarterdeck	\$ 115
Microsoft - Sys. V/386 Comp.	799
MS Windows/386, Microsoft	130
PC MOS/386, Software Link	181
VM/386, IGC	162
SCO XENIX - Complete	1279
DEBUGGERS	
Periscope II	\$ 141
OTHER Periscope Products	CALL
Advanced Trace-86, Morgan Computing	121
Breakout, Essential	89
Trace PLUS V.4.0, Turbo Power Soft.	41
w/Source	79
Pfor86plus, Phoenix	215
EDITORS	
BRIEF, Solution Systems	\$ CALL
w/BRIEF	CALL
EDIX, Emerging Technology	159
EMACS, Unpress	268
Epilink, Lugaru	151
KEDIT, Mansfield	129
MULTI-EDIT, American Cybernetics	90
Norcan Editor	269
PC/EDY, Boston Business Computing	115
Phox, Phoenix	115
SPF/PC, Command Technology	185
VEEDIT PLUS, CompuView	131
XTC, Wendin	60
FILE MANAGERS	
Btrieve, Softrcraft	\$ 185
Xtrieve	189
Report Option	109
CBTREE, Peacock System	141
c-tree, Faircom	318
r-tree	172
dbc III, Lattice	363
dbc III/II w/Source	599
dbc III PLUS	599
db VISTA OR db QUERY, Rama	CALL
XDL, Softrcraft	599
GRAPHICS	
ADVANTAGE Graphics, Lifeboat	\$ 229

GOTO	
Drawbridge, Courseware Applic	111
Essential Graphics	229
GraphicS, Software Endeavors	322
GSS Graphics Dev. Toolkit, Software Endeavors	399
HALO '88, Media Cybernetics	229
HOOPS, Ithaca Software	554
MetaWINDOW, Metagraphics	162
TurboWINDOW/PC	232
Turbo WINDOW/C	80
Turbo HALO (Turbo C), Media Cybernetics	80
OBJECT - ORIENTED	
ACTOR, White Water Group	\$ 423
ADVANTAGE C, Lifeboat	479
Pfor-C, Phoenix	215
Smalltalk/V, Dig talk	85
Smalltalk/V286	169
OPERATING SYSTEMS	
Microsoft DOS Merge	\$ 219
Microsoft Sys V/AT	579
SCO XENIX System V	999
Wendin-DOS	80
Other Microport, See, Wendin Products	CALL
SCREENS WINDOWS	
Greenleaf Data Windows	\$ 229
MS Windows, Microsoft	69
MS Windows Dev. Kit, Microsoft	329
PANEL 9C or 7C	395
Vitamin G, Creative Programming	162
Windows for Data, Vermont Creative	CALL
ScreenStar w/Source, Essential	159
SoftCode, Software Bottling Co	119
Turbo POWER SCREEN	101
OTHER PRODUCTS	
Don Bricklin's Demo Program, Software Garden	\$ 60
MKS Toolkit	139
MS OS/2 Programmer's Toolkit	239
PC Unit, Gimpel	101
PinK86Plus, Phogen	279
Relaytron PVCS CORPORATE	423
Prac-C, Phoenix	159
SEIDL Version Manager	269
Source Print, Adabaran Labs	81

## Science & Engineering Software

CIRCUIT DESIGN SCHEMATIC CAPTURE	
HWIRE, Wintek Corp.	\$ 849
MICRO-CAP II, Spectrum Software	759
PAOS DRILL, CAD Software	CALL
PAOS PCB	CALL
PAOS Routs	CALL
Spice, MicroSm	899
Device Equations Source	309
Probe graphics post-processor	399
Parts parameter estimator	359
Monte Carlo Analysis	359
Digital Files	309
Schemo II, Dmaton	449
anARTWORK, Wintek Corp.	849
Tango PCB, ACCEL Tech	469
Tango Routs, ACCEL Tech	469
DATA ACQUISITION SIGNAL ANALYSIS	
Asyst 2.3	\$2,179
Asyst Modules 1, 2, 3	1,989
Asyst Modules 1, 2, 4	1,989
Asyst Module 1, 2	1,609
Asystant Plus, Macmillan	849
Asystant, Macmillan	445
DADISP - DSP Systems	749
DADISP-486, DSP Systems	175
Ferret PERSPECTIVE II, Alligator Trans	329
HYPERSIGNAL, Hyperception	309
HYPERSIGNAL Plus	439
LABTECH Acquire, Lab Tech Corp	179
LABTECH CHROM	709
LABTECH Notebook	759
LABTECH Real Time Access	269
Lites Measure	445
G.E.D. O.A. and Central, Hart Scientific	759
SNAP-CALC, HEM Data Corp	295
SNAP-FFT, HEM Data Corp	295
SNAPSHOT STORAGE SCOPE	495
UnkelScope Junior, Unkel Software	109
UnkelScope Level 1	315
UnkelScope Level 2	499
PLOTTING AND GRAPHING	
ChartMaster PC, Interchart Software	\$ 369
Dataseq Graph, Mathesis Assoc	259
Omniplot, Scientific Endeavors	269
PC MAP III, Peerless Engineering	755
PLOTZ, Curtis Technical Soft	319
TECH*GRAPH*PAD, binary engineering	259
EQUATION SOLVERS	
Eureka: The Solver, Borland	\$ 119

MechCAD 2.0, MathSoft	262
Mech Meta, MCAE Technologies	89
meMATH, Soft Warehouse	189
Behvelli, Structured Scientific Software	79
Behv-e, SDOC	79
TK!Silver Plus, Universal Tech Sys	395
CAD	
AUTOCAD, by Autodesk	\$ CALL
Autodesk, by Autodesk	65
Speed Enhanced Version	279
Design CAD, American Small Bus Comp	279
Prefix 1 Plus, Foresight	229
Prefix 3-D Moduler, Foresight	169
EASYCAD, Evolution Computing	139
ECAD, Pelton Engineering	859
FASTCAD, Evolution Comput ng	1,849
Generic CAD	69
Generic 3-D Solid Modeling	159
3-D Rendering Module	119
In-A-Vision, Micrografix	459
Windows Draw w/Clip Art	239
Windows Graph	319
LaserCAD, DSL Link	89
PRO-3D/PC, Enabling Technologies	355
TurboCAD, MSA Group	79
AUTOCAD ADD-ONS	
AutoESL, Systems Unl-m-td of CA	\$ 279
AutoSHAPES	189
FSIMPLEX	89
Turbo View, Sublogic Corp	449
MOUSE PRODUCTS	
LOGITECH HIRES Mouse	\$ 149
LOGITECH Serial or Bus Mouse	99
LOGITECH Others	CALL
LOGITECH Series 2 Mouse	89
Microsoft Ser or Bus Mouse	99
W/Easy CAD	139
W/MS Windows	139
SUMMAMOUSE, Summagraphics	99
APL LANGUAGE	
APL*PLUS/PC, STSC	\$ 499
APL*PLUS PC TOOLS,	209
Packet APL	60
SCIENTIFIC TEXT PROCESSING	
CHEM-TEXT, Molecular Design Ltd	\$1 500
EXACT, Technical Support Software	419

EXP, Brooks/Cole Publishing	129
For Math, Shantha Software	379
Lotus Manuscript	445
PC TEX, Personal TEX	259
T3 Sci. Word Proc., TCI Software Res	499
STATISTICS	
ABstat, Anderson Bell	\$ 315
CSS, StatSoft	469
Microstat, Ecosoft	319
MVA STATPAK, Northwest	749
P-STAT	659
The Scientific Wheel, Dalis Inc.	749
SPSS/PC	539
StatPac Gold, Walchick Associates	229
STATS - StatSoft	CALL
THE SYSTAT	CALL
ADDITIONAL SEE PRODUCTS	
ATLAS*GRAPHICS, STSC	\$ 339
Atoms, Curtis Technical Selt	25
COMPEDITOR, Ayecolinc	155
Engineer's Add, Eng Prog Concepts	649
LASCALX 1000 Calculator	55
PC-Matlab, The Math Works	659
Central System Toolbox	459

System ID Toolbox	459
JOINT FIVE, Pacific Crest	279
The Professional Wheel, Dain Inc	199
Units, Curtis Technical Soft	25
FORTRAN LANGUAGE	
DIFF-E-Q, Microcompatibles	\$ 449
Extend, Design Decisions	131
Graphic or Plotmatic, Microcompatibles	119
Math P77-EM/32	799
Lakey Personal FORTRAN	89
Lakey PFC/Systolic Systems	445
Microsoft FORTRAN w/CadeView	289
Numerical Analyst, Magus	249
RM/FORTRAN, Austec	479
Spindrift Library, Laboratory LTD	135
SSP/PC, Lattice	279
GAUSS	
GAUSS Prog. Lang., Aptech Sys	\$ 340
GAUSS Math & Stat System	380
X-RAYS SIMULATORS	
Microtec, Relms, Uniwere, Queto	\$ CALL

**Ordering Information**  
We accept AMERICAN EX. PRESS, MC, VISA and PERSONAL CHECKS. There is no surcharge on credit card or C.O.D. New York State residents must add sales tax. Shipping and handling \$3.95 per item within the U.S. sent UPS ground. Rush and international service available. Call for prevailing rates.  
• International orders add \$10 for export preparation.  
• Prices and policies may change without notice.  
• Dealers and Corporates Buyers call for special prices.  
• Most orders must include phone number.  
• Ask for details before you buy some manufacturers won't take returns if disk units are broken.

Call for your FREE catalog today!  
In the U.S. call  
**1-800-333-3141**  
International Orders: 914-332-0756  
**Science & Engineering SOFTWARE CO.**  
55 South Broadway, Tarrytown, NY 10591



# Take any 3 books for only \$1<sup>00</sup> each



**UNDERSTANDING & USING dBASE III+ PLUS.** By R. Krumm. 874 pp., illus., softbound. Widely regarded as the most comprehensive one-volume reference on the subject, it covers everything from basic concepts to advanced programming techniques. 583940-7 Pub. Pr., \$22.95

**UNIX UTILITIES.** By R.S. Tare. 352 pp., illus., softbound. This practical manual shows how to make the best use of UNIX utilities. It covers more utilities than any other book of its kind and provides numerous examples of real applications. 628/84X Pub. Pr., \$24.95

**VSAM: Performance, Design, and Fine Tuning.** By J. Ranade. 280 pp., illus. Find out how to adapt VSAM to your particular needs and cut processing time in half! This new work by an authority on VSAM provides the detailed, hands-on assistance you need to design and implement efficient systems. 583963-6 Pub. Pr., \$34.95

**TURBO PASCAL PROGRAMMER'S LIBRARY.** By K. Jamsa and S. Name-rol. 495 pp., illus., softbound. An outstanding and varied collection of more than 200 routines that you can quickly key into any computer that runs under PC-DOS. Includes some vital math functions not provided in Turbo Pascal's standard package. 583762-5 Pub. Pr., \$18.95

**ADVANCED GRAPHICS IN C: Programming and Techniques.** By N. Johnson. 430 pp., illus., softbound. Now C programmers can write crisp graphics programs for the IBM-PC using the IBM EGA (Enhanced Graphics Adaptor) or the AT&T Image Capture Board (ICB). Includes GRAPHIQ, a complete C graphics toolkit. 881257-7 Pub. Pr., \$22.95

## when you join BYTE Book Club<sup>®</sup> Values up to \$59.95

- Your one source for computer books from over 100 different publishers
- the latest and best information in your field
- discounts of up to 40% off publishers' list prices

**A COMPREHENSIVE GUIDE TO AI AND EXPERT SYSTEMS: Turbo Pascal Edition.** By R.I. Levine, D.E. Drang, and B. Edelson. 256 pp., 99 illus. A must for everyone who wants to understand and utilize artificial intelligence for commercial, military, scientific, or educational applications. It's all in clear, simple language with many illustrations and sample programs. 374708 Pub. Pr., \$22.95

**32-BIT MICROPROCESSORS.** Edited by H. J. Mitchell. 248 pp., 104 illus. and tables. A comprehensive survey of the powerful new microprocessors for large, technically complex projects. Coverage includes: AT&T's WE32100, Imros' T414 and T424, Intel's 80386, Motorola's 68020, and Zilog's Z80000. 425 85X Pub. Pr., \$45.00

**CIARCIA'S CIRCUIT CELLAR, Volume VI.** By S. Ciarcia. 224 pp., 75 illus., softbound. More marvelous projects from the incomparable Ciarcia! This new volume contains easy-to-follow plans for a home security system, a serial Eprom programmer, a turnkey bulletin board, an audio-and-video multiplexer, plus 10 more projects. 109/680 Pub. Pr., \$19.95

**PROGRAMMER'S CHALLENGE: 50 Challenging Problems to Test Your Programming Skills.** By S. Chen. 464 pp. If you enjoy testing your programming skills, then you'll enjoy solving these 50 challenging problems. Solutions are provided in BASIC, Pascal, and C with full explanations and test data. 583883-4 Pub. Pr., \$29.95

**ADVANCED TURBO C.\*** By H. Schildt. 397 pp., illus., softbound. Complete Turbo C mastery can be yours—from stacks, queues, linked lists and binary trees, to operating system interfacing, porting, debugging, and much more. Fully explains how to get the most from the power and speed of Turbo C. 881280-1 Pub. Pr., \$22.95

**DATABASE SYSTEM CONCEPTS.** By H. F. Korth and A. Silberschatz. 546 pp., illus. From fundamental concepts to advanced problem solving, this book provides a clear understanding of the design and use of database systems. Also demonstrates the best ways to protect data from unauthorized access and malicious or accidental alteration or destruction. 447/527 Pub. Pr., \$42.95

**ARTIFICIAL INTELLIGENCE USING C: The C Programmer's Guide to AI Techniques.** By H. Schildt. 412 pp., 37 illus., softbound. This hands-on guide shows you how to create your own AI applications and systems using C. After an introductory overview it provides coverage of expert systems, logic, natural language processing, machine learning, pattern recognition, and more, with ready-to-run programs illustrating each topic. 881255-0 Pub. Pr., \$21.95

**PROGRAMMING USING THE C LANGUAGE.** By R.C. Hutchison and S.B. Just. 519 pp., illus. Whether you want to understand programs in C written by others, or write better C programs of your own, this practical, authoritative book gives you the tools and guidance you need. Coverage includes program organization, sorting algorithms, recursion, linked lists, and more — with many sample programs. 315/418 Pub. Pr., \$28.95

**HARD DISK MANAGEMENT with MS-DOS and PC-DOS.** By D. Gookin and A. Townsend. 307 pp., illus. Shows you how to make the best use of your hard disk for all types of programs, with an emphasis on organization, data security, and enhancing performance. Easy enough for novices, yet sophisticated enough for power users, it's packed with helpful hints, proven shortcuts, and clear explanations. 583954-7 Pub. Pr., \$26.95

**TRICKS OF THE UNIX MASTERS.** By R.G. Sage. pp. illus. Many of UNIX's most interesting features have virtually been kept secret from users — until now! This master guide goes beyond the basics to show you the shortcuts, tools, tips, and tricks it could take years to discover on your own. 584637-3 Pub. Pr., \$22.95

**SADT: Structured Analysis and Design Technique.** By D. Marca and C. McGowan.  
402/353 Pub. Pr., \$44.95

**PROGRAMMING WITH TURBO PASCAL.** By D. Carroll  
852908-5 Pub. Pr., \$39.95

**HIGH-SPEED ANIMATION & SIMULATION FOR MICROCOMPUTERS.** By L. Adams  
583855-9 Pub. Pr., \$19.95

**DATABASE MACHINES & DATABASE MANAGEMENT.** By E. Ozkarahan  
583770-6B Pub. Pr., \$53.00  
(Counts as 2 of your 3 books)

**PRINCIPLES OF PARALLEL AND MULTI-PROCESSING.** By G. R. Desrochers  
165/793 Pub. Pr., \$49.50  
(Counts as 2 of your 3 books)

**GETTING THE MOST FROM UTILITIES ON THE IBM PC.** By R. Krumm  
583790-0 Pub. Pr., \$19.95

**THE ADA PRIMER.** By P. I. Johnson  
326/266 Pub. Pr., \$17.95

**THE DATABASE EXPERTS' GUIDE TO DATABASE 2.** By B. Larson.  
232/679 Pub. Pr., \$34.95

**NETWORKING SOFTWARE.** By C. B. Ungaro.  
606969-9 Pub. Pr., \$37.95

**THE DATABASE EXPERT'S GUIDE TO SQL.** By F. Lusardi  
390/061 Pub. Pr., \$39.95

**PRINCIPLES OF ARTIFICIAL INTELLIGENCE AND EXPERT SYSTEMS DEVELOPMENT.** By D. W. Rolston  
536/147 Pub. Pr., \$39.95

**HOW TO WRITE COMPUTER DOCUMENTATION FOR USERS, 2nd Ed.** By S. J. Gnm  
583783-8 Pub. Pr., \$29.95

**DATA STRUCTURES USING PASCAL, 2nd Ed.** By A. M. Tenenbaum & M. J. Augenstein  
583738-2 Pub. Pr., \$46.00

**MICROCOMPUTER LANS: Network Design and Implementation.** By M. F. Hordesk  
584580-6 Pub. Pr., \$28.95

**OPERATING SYSTEMS.** By M. Milenkovic  
419/205 Pub. Pr., \$40.95

**HYPERTEXT PROGRAMMING.** By D. Shafer.  
584653-5 Pub. Pr., \$24.95



Any 3 books for \$1.00 each... if you join now and agree to purchase three more books — at handsome discounts — during your first year of membership.

**ADVANCED TURBO PASCAL: PROGRAMMING AND TECHNIQUES.** By H. Schildt  
583761-7 Pub. Pr., \$18.95

**SOFTWARE ENGINEERING: A FRACTIONNER'S APPROACH.** By R. S. Pressman.  
507/83XB Pub. Pr., \$47.95  
(Counts as 2 of your 3 books)

**68000 ASSEMBLY LANGUAGE PROGRAMMING, 2nd Ed.** By L. Leventhal; D. Hawkins; G. Kane & W. Cramer  
583817-6 Pub. Pr., \$28.95

**ADVANCED COBOL, 2nd Ed.** By A. S. Philippakis and L. J. Kazmier.  
498/13X Pub. Pr., \$35.95

**RECOMMENDED DIAGRAMMING STANDARDS.** By J. Martin  
583597-5 Pub. Pr., \$48.00  
(Counts as 2 of your 3 books)

**FILE ORGANIZATION FOR DATABASE DESIGN.** By G. Wiederhold  
701/334 Pub. Pr., \$40.95

**USING TURBO C.** By H. Schildt  
881279-8 Pub. Pr., \$19.95

## More Books to Choose from

**FOILING THE SYSTEM BREAKERS: COMPUTER SECURITY AND ACCESS CONTROL.** By J. Lobel  
383/57X Pub. Pr., \$37.50

**IMS (DL/I) DATABASE ORGANIZATION AND PERFORMANCE.** By G. Hubbard  
583840-0 Pub. Pr., \$32.95

**HOW TO BE A SUCCESSFUL COMPUTER CONSULTANT.** By A. R. Simon  
572/968 Pub. Pr., \$19.95

**THE THEORY AND PRACTICE OF COMPILER WRITING.** By J. P. Tremblay & P. G. Sorenson  
651/612B Pub. Pr., \$46.95  
(Counts as 2 of your 3 books)

**INTRODUCING PC-DOS AND MS-DOS: A GUIDE FOR BEGINNING & ADVANCED USERS.** By T. Sheldon  
565/597 Pub. Pr., \$24.95

**COMPUTER ORGANIZATION.** By M. Andrews.  
584588-1 Pub. Pr., \$39.95

**DEBUGGING TECHNIQUES FOR IBM PC BASIC.** By J. R. Corsi & W. F. Hills  
583693-9 Pub. Pr., \$17.95

**CIARCIA'S CIRCUIT CELLAR, Volume V.** By S. Ciarcia  
109/672 Pub. Pr., \$21.95

**HANDBOOK OF SOFTWARE MAINTENANCE.** By G. Parikh  
583639-4 Pub. Pr., \$35.95

**THE C PRIMER, 2nd Ed.** By L. Hancock & M. Krieger  
259/95X Pub. Pr., \$22.95

**DATA TYPES AND DATA STRUCTURES.** By J. J. Martin  
583689-0 Pub. Pr., \$44.67

**TROUBLESHOOTING AND REPAIRING THE NEW PERSONAL COMPUTERS.** By A. Margolis  
583871-0 Pub. Pr., \$17.95

**APPLYING EXPERT SYSTEMS IN BUSINESS.** By D. N. Choralas  
108/803 Pub. Pr., \$31.95

**STRUCTURED COBOL: A STEP BY STEP APPROACH.** By C. R. Litley and G. B. Davis  
157/88X Pub. Pr., \$30.95

**TELECOMMUNICATIONS AND DATA COMMUNICATIONS FACTBOOK.** By J. Abbatiello and R. Sarch  
606965-6 Pub. Pr., \$39.95

**DESIGN OF DISTRIBUTED OPERATING SYSTEMS.** By P. J. Fortier  
216/215 Pub. Pr., \$42.95

**WORDPERFECT®: THE COMPLETE REFERENCE.** By K. Acerson.  
881312-3 Pub. Pr., \$27.95

**HANDS-ON-BASIC: FOR THE IBM PERSONAL COMPUTER.** By H. Peckham  
491/78X Pub. Pr., \$26.95

## Here's how Byte Book Club® works to serve you:

- **Important information... we make it easy to get!** Today, professionals who perform best are those who are best informed. For reliable, hands-on information, turn to the Byte Book Club. Every 3 or 4 weeks (12-15 times a year), members receive the Club Bulletin offering more than 30 books — the best, newest, most important books from all publishers.
- **Dependable service... we're here to help!** Whether you want information about a book or have a question about your membership, just call us toll-free or drop us a line. To get only the books you want, make your choice on the Reply Card and return it by the date specified. If you want the Main Selection, do nothing — it will be sent to you automatically. (A small shipping and handling charge is added to each shipment.)
- **Club convenience... we do the work!** You get a wide choice of books that

simply cannot be matched by any bookstore. And all your books are conveniently delivered right to your door. You also get 10 full days to decide whether you want the Main Selection. (If the Club Bulletin ever comes late and you receive a Main Selection you don't want, return it for credit at our expense.)

- **Substantial savings... and a bonus program too!** You enjoy substantial discounts — up to 40%! — on every book you buy. Plus, you're automatically eligible for our Bonus Book Plan which allows you savings up to 70% on a wide selection of books.
- **Easy membership terms... it's worthwhile to belong!** Your only obligation is to purchase 3 more books — at handsome discounts — during the next 12 months, after which you enjoy the benefits of membership with no further obligation. You or the Club may cancel membership anytime thereafter.

Fill out the card and mail today! If the card is missing, write to:

**BYTE BOOK CLUB®, P.O. Box 582, Hightstown, New Jersey 08520-9959**  
For faster service in enrolling, call 1-800-2-MCGRAW



# Daisywheel Printer...\$198

**Satisfaction  
Guaranteed!  
Since 1975**

## Turbo-XT \$398



- 4.77 & 10 MHz
- 640K Motherboard with 256K
- 8 slots • 8087 socket
- 150W power supply

## Turbo-286 \$998



- 1 MB Motherboard with 640K
- 6 or 10 MHz switchable
- 8 slots • 80287 socket
- 200 watt power supply
- 1.2 floppy disk drive
- Hard disk/floppy controller

### Option A...Add \$148

- High resolution amber monitor
- Graphics card & printer port

### Option B...Add \$258

- Hi-res RGB color monitor
- Graphics card & Printer port

### Option C

- Hard disk drive

30 MB for XT add \$298    40 MB for XT add \$398    40 MB For AT add \$348

## Amdek 310A \$98

Best selling hi-resolution non-glare amber monitor



## intJ Math Coprocessors

8087 \$98	8087-2 \$138
8087-1 \$198	80287-6 \$178
80287-8 \$228	80287-10 \$288
80387-16 \$468	80387-20 \$728

## Mouse

With Software



\$29

Logitech mouse	\$78
Mouse systems mouse	\$98
Microsoft mouse	\$108
Fastrap trackball	\$98
Deluxe joystick	\$24

Place orders toll free!

Continental U.S.A. 1-800-421-5500

Inside California 1-800-262-1710

All others 1-213-973-7707

Fax machine 1-213-675-2522

Prices at our eight store locations will be higher on some items.

### California

Torrance, Santa Ana, Woodland Hills  
Kearny Mesa Sunnyvale

### Texas

Addison, Houston

### Georgia

Smyrna



## 1200 Baud Modem \$58



2400 baud 1/2 card internal	\$128
1200 baud external	\$88
2400 baud external	\$168

## 30 MB Hard Disk

Complete kit with controller

## CMS \$298



10 MB PC/XT Kit	\$188
20 MB PC/XT Kit	\$248
20 MB Card	\$398
40 MB for AT	\$348
40 MB PC/XT Kit	\$398
Mountain 40 MB Tape	\$398

## 360K Disk Drive

Half height,  
Direct Drive

\$68



Tandon TM100-2 full height	\$89
1.2 MB for AT	\$98
5 1/4" drive for PS/2	\$268
720K 3 1/2" disk drive	\$98
1.44 MB 3 1/2" disk drive	\$128

## No Slot Clock \$48



## MICROSOFT.

## MS-DOS 3.3 \$98

## VGA Package

Monitor & Card \$648



- 800 x 560
- Up to 256K brilliant colors

Hi-res EGA card 640x480	\$128
EGA monitor 640x350	\$378
VGA AutoSync 800 x 560	\$498
NEC MultiSync II 800x560	\$598
RGB color monitor 640x240	\$258
Vega VGA card	\$278
Paradise VGA card	\$278

## Daisywheel Printer

26 CPS  
\$198

40 CPS  
\$298

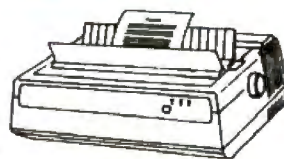

Diablo compatible, 1 year warranty  
Parallel and serial interface

## EPSON 9 Pin

\$198 LX-800

Near Letter Quality  
FX-850, FX-1050, EX-800 ... Call



## EPSON 24 Pin

\$369 LQ-500

Letter Quality Printers  
LQ-850, LQ-1050, LQ-2500 .. Call



## HEWLETT PACKARD LaserJet II

\$1698

Extra Toner Cartridge \$98  
PDP 4 MB RAM card w/OK \$198  
1 MB. \$348 2 MB. \$648 4 MB. \$1148



## HP DeskJet

\$698

PDP 128K RAM \$98  
Extra ink cartridge \$18



## Laser Printer

\$1198

1.5 MB RAM card \$198  
Toner cartridge \$58

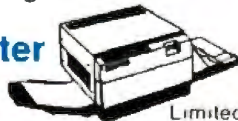

Limited  
Quantity!

## OKIDATA

Okidata 320	\$358
Okidata 321	\$498
Okidata 390	\$498
Okidata 391	\$688



# JADE COMPUTER

We accept checks, credit cards or purchase orders from qualified firms and institutions. No surcharge on credit card orders. CA., TX. & GA. residents add sales tax. Prices & availability subject to change without notice. Shipping & handling charges via UPS ground 50¢/lb. UPS air \$1.00/lb. Minimum charge \$3.00.

4901 W Rosecrans Ave. Box 5046  
Hawthorne, California 90251-5046



Circle 133 on Reader Service Card





# An 80386 with a Twist



Competitive pricing and an intelligent bus distinguish the AST Premium/386 from its peers

Jeff Holtzman

In an increasingly crowded field of 20-MHz 80386-based AT compatibles, AST Research's Premium/386 is a unique entry. Like IBM's PS/2 series, it includes several peripheral controllers on the motherboard. But what separates the Premium/386 from the rest of the 80386 pack is its intelligent bus design, which lets devices on the motherboard other than the CPU take control of the bus to gain fast access to system memory and peripherals. And unlike the PS/2's Micro Channel architecture (MCA) bus, the Premium/386's bus is fully compatible with IBM PC XT and AT buses.

The Premium/386 comes in five configurations. The basic unit is the Model

300 (\$5195), which includes a 20-MHz 80386, sockets for both an 8-MHz 80287 and a 20-MHz 80387, 1 megabyte of 32-bit 80-nanosecond static-column RAM, one parallel and two serial ports, and seven expansion slots. One expansion slot is dedicated to AST's proprietary 32-bit memory card; two are standard 8-bit (XT-style) slots; one is a standard 16-bit (AT-style) slot; and three are SmartSlots. The latter closely resemble a standard AT expansion slot, except that the lower connector carries several new signals that allow a "master" device on a specially built card to take control of the bus from the CPU (see the text box "AST's SmartSlot Architecture" on page 196).

The base unit also comes with a battery-backed clock/calendar, a 101-key enhanced-style keyboard, and a floppy disk drive controller that controls a maximum of four devices in all 5¼-inch and 3½-inch formats. The Premium/386 can accommodate three externally accessible half-height drives; another unexposed bay accepts either one full-height or two half-height devices.

Unlike many high-performance 80386-based microcomputers, the Premium/386 has no hardware cache, nor does it support the Weitek 1167 math coprocessor. The base system does not come with a graphics card, a monitor, or a hard disk drive.

Standard software includes MS-DOS 3.30, GWBASIC 3.22, a ROM- and RAM-based setup program, and utility software (an expanded/extended memory manager, RAM disk, disk cache, and print spooler). AST's version of OS/2 1.0 is available for an extra \$325.

I reviewed the Model 390, which includes an additional megabyte of memory and a 90-megabyte 18-millisecond enhanced-small-device-interface (ESDI) hard disk drive. The hard disk drive automatically parks the read/write heads in the last cylinder when powered down. The review system came with a 20-MHz

*continued*



## AST's SmartSlot Architecture

The SmartSlot architecture is the most unusual and innovative feature of AST's Premium/386. Considering the simplicity of the SmartSlot concept, it's surprising that no one thought of it before. And because the SmartSlot is an extension of the classic AT bus, it runs at 8 MHz with one wait state and is fully downward-compatible with existing expansion cards.

SmartSlot provides a way for an intelligent peripheral (e.g., a disk controller, video adapter, or network or micro-to-mainframe interface) to take control of the bus from the microprocessor. Thus, the peripheral can access system memory or other peripherals directly, without help from the CPU. This not only frees the CPU for other tasks, it also speeds memory transfers, depending on the application and the peripheral you're using, because not every byte of data you transfer goes through the CPU.

For example, to draw a circle in a graphics program, a CPU working by itself must load 1 to 4 bytes of memory (depending on bus width), manipulate it, and restore it to memory. This process is repeated for all memory locations involved. However, with an intelligent graphics coprocessor running in a SmartSlot, the CPU gives the command and then goes on to something else. Meanwhile, the coprocessor loads the affected region from video memory in one quick burst, draws the circle, and

then restores the region in one chunk just as quickly.

The Premium/386 has three SmartSlots, each of which looks like a standard 16-bit expansion slot that has been stretched to accommodate four new pins on each side of the slot. Of these eight pins, five are currently used; three are reserved for future use.

Two of the five signals are status signals generated by a SmartSlot-mounted peripheral device (called a Master). One (MASTER8) identifies the master as capable of 8-bit transfers only; the other (MASTER16) identifies the master as capable of either 8- or 16-bit transfers.

The remaining three signals synchronize use of the bus. When a master wants the bus, it asserts a bus request (BUSREQ). If the bus is available, the arbitration logic asserts a bus grant (BUSGNT), and then the master device asserts a bus busy (BUSBSY). The master can then maintain control of the bus until BUSGNT is released, at which point it must finish its current activity and then release BUSBSY.

Things are actually a little more complicated than this, however, because to maintain compatibility with the AT bus, the refresh circuitry must uphold dynamic RAM (DRAM) refresh timing. The arbitration logic senses when a refresh cycle must occur; if a master device has control of the bus, the arbitra-

tion logic takes the bus, allows refresh to occur, and then gives the bus back to that master. The same process occurs when a direct memory access transfer takes place.

The arbitration logic sees to it that two masters do not try to gain bus control simultaneously. It also has a provision for locking the bus (for up to 150 microseconds) while executing critical sections of code—servicing a hardware interrupt, for example.

Another complication is that, in a process that AST calls bus hogging, the master does not need to relinquish the bus if it takes responsibility for providing DRAM refresh. In such a situation, the master could perform sustained, uninterrupted data transfers indefinitely.

The result is a bus that, unlike the PS/2's MCA, is completely compatible with the classic IBM bus but also has advanced capabilities like the MCA.

As unique as the SmartSlot architecture is, however, it's unclear whether other manufacturers (or even AST itself) will develop hardware that takes advantage of the SmartSlot's advanced features. AST claims to have developed an advanced ESDI disk controller that can take advantage of the SmartSlot architecture, but the company doesn't plan to release the product until late this year.

Currently, AST has no plans to develop additional SmartSlot cards.

80387, an AST 3G Plus II EGA card, and an AST EGA monitor. The price for this system, excluding the 80387 (which AST doesn't sell), is \$9585.

AST's 32-bit memory card can hold a maximum of 13 megabytes of memory; you add 256K-byte and 1-megabyte single in-line memory modules (SIMMs) in 1-megabyte (\$1095) or 4-megabyte (\$7995) increments.

### Architectural Details

The Premium/386's architecture is interesting both for what it has and for what it doesn't have. AST didn't build a hardware cache into the machine. Since the 32-bit expansion slot is fed directly by signals from the microprocessor, AST could add a cache-based memory system. Currently, it implements memory as a static-column (or page-mode) system. This architecture divides memory into relatively small, equal-size chunks of

memory called pages. In the Premium/386, the page size is 2K bytes.

The CPU accesses a specific memory location through the memory-decoding circuitry, which presents row and column addresses to RAM and then reads or writes the desired information. To access another location on the same page, the memory-decoding circuitry needs only to change the row address. Access in the same page occurs with zero wait states. However, accessing memory on a different page incurs two wait states, because the memory-decoding circuitry must specify both row and column addresses, and because it must prepare (precharge) the static-column RAM for access.

Static-column RAM can increase performance because programs tend to execute sections of code repetitively in relatively small areas of memory. However, because more than 2K bytes of RAM often separates code and data segments

of Intel microprocessors, sustained operation within a 2K-byte chunk of RAM (i.e., at zero wait states) seldom occurs. AST engineers report an average of 0.6 to 0.7 wait states when running typical applications.

The Premium/386 allocates memory in a unique fashion. Of the first megabyte of RAM, it decodes 640K bytes to appear at the usual addresses (0000:0000 hexadecimal through 9000:FFFFh). It maps the remaining 384K bytes, which AST calls Reserved Memory, to the top of the 16-megabyte address space (00FA0000h), but it may remap 128K bytes of it to the top 128K bytes of the first megabyte (E000:0000h through F000:FFFFh). You can use that 128K bytes, called Shadow RAM, to hold a write-protected copy of the BIOS, which will then run about twice as fast as it does directly from the pair of 8-bit ROMs.

*continued*





# AST Premium/386

APPLICATION-LEVEL PERFORMANCE

AST Premium/386 **14.9\***

## WORD PROCESSING

<b>XyWrite III + 3.52</b>	<b>Med./Large</b>
Load (large)	:13
Word count	:03/:20
Search/replace	:05/:20
End of document	:02/:12
Block moves	:11/:11
Spelling check	:08/1:00

### Microsoft Word 4.0

Forward delete	:13
----------------	-----

### Aldus PageMaker 1.0a

Load document	:06
Change/Bold	:23
Align right	:16
Cut 10 pages	:15
Place graphic	:04
Print to file	1:39

■ Index: **2.86**

## SPREADSHEET

### Lotus 1-2-3 2.01

Block copy	:03
Recalc	:01
Load Monte Carlo	:11
Recalc Monte Carlo	:05
Load rlarge3	:03
Recalc rlarge3	:01
Recalc Goal-seek	:03

### Microsoft Excel 2.0

Fill right	:04
Undo fill	1:53
Recalc	:02
Load rlarge3	:30
Recalc rlarge3	:01

■ Index: **2.90**

## DATABASE

### dBASE III + 1.1

Copy	:52
Index	:07
List	1:06
Append	1:37
Delete	:02
Pack	1:25
Count	:03
Sort	:51

■ Index: **2.42**

## SCIENTIFIC/ENGINEERING

### AutoCAD 2.52

Load SoftWest	:41
Regen SoftWest	:33
Load StPauls	:09
Regen StPauls	:05
Hide/redraw	11:13

### STAT 1.5

Graphics	:22
ANOVA	:12

### MathCAD 2.0

IFS 800 pts.	:15
FFT/IFFT 1024 pts.	:15

■ Index: **3.98**

## COMPILERS

### Microsoft C 5.0

XLisp compile	3:34
---------------	------

### Turbo Pascal

Pascal S compile	:04
------------------	-----

■ Index: **2.74**

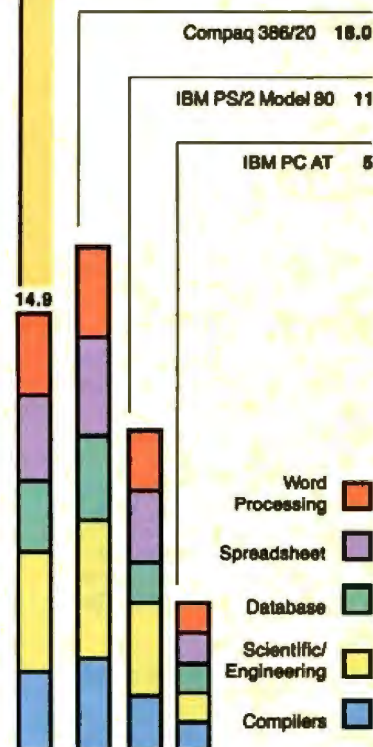

\*Cumulative applications index. Graphs are based on indexes at left and show relative performance.

All times are in minutes.seconds. Indexes show relative performance; for all indexes, an 8-MHz IBM PC AT=1

## LOW-LEVEL PERFORMANCE<sup>1</sup>

AST Premium/386

### CPU

Matrix	3.97
<b>String Move</b>	
Byte-wide	42.57
Word-wide:	
Odd-bnd.	32.10
Even-bnd.	21.29
Sieve	23.56
Sort	27.63

■ Index: **2.51**

### FLOATING POINT<sup>2</sup>

Math	8.52
Error <sup>3</sup>	0.00E+00
Sine(x)	3.64
Error	2.00E-09
e <sup>x</sup>	3.56
Error	1.77E-02

■ Index: **5.26**

### DISK I/O

<b>Hard Seek<sup>4</sup></b>	
Outer track	3.29
Inner track	3.33
Half platter	6.65
Full platter	10.00
Average	5.82
<b>DOS Seek</b>	
1-sector	7.53
32-sector	18.37

<b>File I/O<sup>5</sup></b>	
Seek	0.11
Read	0.48
Write	0.78

<b>1-megabyte</b>	
Write	3.09
Read	2.93

■ Index: **2.41**

### VIDEO

<b>Text</b>	
Mode 0	5.58
Mode 1	5.58
Mode 2	5.44
Mode 3	5.47
Mode 7	5.52

<b>Graphics</b>	
CGA:	
Mode 4	1.92
Mode 5	1.90
Mode 6	2.02
EGA:	
Mode 13	3.77
Mode 14	4.06
Mode 16	4.12

■ Index: **1.90**

### CONVENTIONAL BENCHMARKS

LINPACK	193.01
Livermore Loops <sup>6</sup> (MFLOPS)	0.15
Dhrystone (MS C 5.0) (Dhry/sec)	4945.00

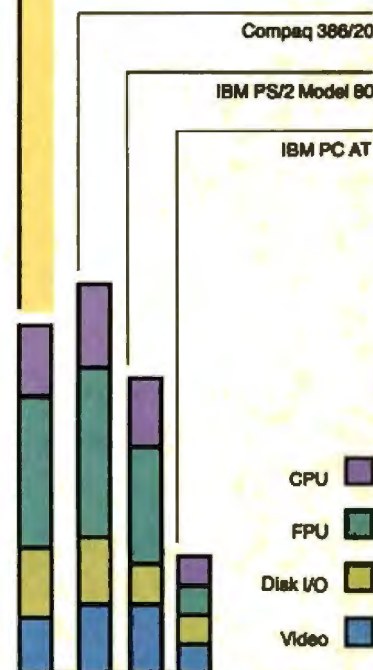

<sup>1</sup> All times are in seconds. All figures were generated using the 8088/8086 version (1.1) of Small-C (16-bit integers). Figures for 80386 machines do not use 80386-specific instructions.

<sup>2</sup> The floating-point benchmarks use 8087-compatible instructions only.

<sup>3</sup> The errors for the floating-point benchmarks indicate the difference between expected and actual values, correct to 10 digits or rounded to 2 digits.

<sup>4</sup> Times reported by the Hard Seek and DOS Seek are for multiple seek operations (number of seeks performed currently set to 100).

<sup>5</sup> Read and write times for the File I/O benchmarks are in seconds per 64K byte.

<sup>6</sup> For the Livermore Loops and Dhrystone tests only, higher numbers mean faster performance.



## AST Premium/386

### Company

AST Research, Inc.  
2121 Alton Ave.  
Irvine, CA 92714  
(714) 863-1333

### Components

**Processor:** 20-MHz Intel 80386;  
sockets for 20-MHz 80387 and 8-MHz  
80287

**Memory:** 2 megabytes of 80-ns static-  
column DRAM, expandable to 15  
megabytes with 13-megabyte  
expansion card

**Mass storage:** 1.2-megabyte 5¼-inch  
floppy disk drive; 90-megabyte 18-ms  
ESDI hard disk drive

**Display:** Optional EGA monitor and 3G  
Plus II EGA card

**Keyboard:** 101-key enhanced keyboard

**I/O interfaces:** Two RS-232C serial  
ports (25-pin); one parallel port (25-pin);  
one 32-bit memory-expansion slot; two  
8-bit and one 16-bit expansion slots;  
three 16-bit AT-compatible SmartSlots

### Size

19¼ x 6¼ x 16½ inches; 40 pounds

### Software

MS-DOS 3.30, GWBASIC 3.22, ROM-  
and RAM-based setup, diagnostics, RAM  
disk, disk cache, print spooler,  
expanded/extended memory manager

### Options

OS/2 1.0: \$325

1 megabyte of SIMM memory: \$1095

4 megabytes of SIMM memory: \$7995

3G Plus II EGA card: \$395

VGA card: \$445

VGA Plus card: \$599

Monochrome monitor: \$195

EGA or VGA monitor: \$695

1.2-megabyte floppy disk drive: \$235

360K-byte floppy disk drive: \$215

1.4-megabyte floppy disk drive: \$695

40-megabyte tape backup: \$695

### Documentation

AST Premium/386 User's Manual; AST  
Premium Utility Software User's Manual;  
AST Operating System 3.30

### Price

Model 300: \$5195

Model 340 (with 40-megabyte hard disk  
drive): \$6295

Model 390 (with 90-megabyte hard disk  
drive): \$8495

Model 3150E (with 150-megabyte hard  
disk drive): \$9795

Model 3320 (with 320-megabyte hard  
disk drive): \$10,795

System as reviewed: \$9585

### Inquiry 894.

With an AST EGA card, you can load the FASTEGA.SYS driver via your CONFIG.SYS file; this copies the EGA BIOS to Shadow RAM. Typing a 32K-byte ASCII file to the screen took about 38 seconds without using FASTEGA.SYS, but only about 11 seconds with it installed. Unfortunately, FASTEGA.SYS won't let you copy third-party EGA (or VGA) BIOSes to Shadow RAM.

Of the remaining 256K bytes of reserved memory, you can use 64K bytes (or 60K bytes in a 1-megabyte system) to load AST's expanded memory manager, ASTEMM.SYS, leaving 192K bytes (196K bytes in a 1-megabyte system) for use as Expanded Memory Specification (EMS) 4.0 memory. Like similar drivers from other vendors, ASTEMM.SYS also uses the 80386 processor's hardware memory-paging capability to emulate EMS 4.0 using standard 32-bit and 16-bit extended memory. 386MAX also knows how to add the Premium/386's reserved memory to its pool of EMS memory.

My only complaint with this allocation scheme is that 64K bytes of the 128K bytes of Shadow RAM (the segment beginning at E000:0000h) is wasted if you don't run an AST video adapter. That segment is unavailable to other adapters (e.g., a network card) or programs that might otherwise be able to use it. 386MAX, for example, could have used it for program loading. You can regain the use of the segment by disabling Shadow RAM, but then you lose the speed advantage of running the BIOS from RAM.

### Up and Running

Getting the machine running is simple, thanks to AST's well-written and well-illustrated directions. To run the ROM-based setup program, you press and hold any key during the boot process. When the machine displays an error message, you press Ctrl-Alt-Esc to enter the setup program. AST also supplies a RAM-based version of the setup program.

The setup information occupies two screens. If you've ever used an AT clone with a BIOS written by Award Software, AST's setup program will be familiar to you. With auto-slowdown enabled and the system operating at its fastest speed, processing slows to the XT-compatible speed (4.77 MHz) whenever the system accesses the floppy disk.

During operation, you can change speed at any time by pressing Ctrl-Alt-Up to increase speed or Ctrl-Alt-Down to decrease speed. You can also execute SPEED.EXE to switch among high (20-MHz), medium (8-MHz), low (4.77-MHz), or default speed, or to enable and

disable auto-slowdown. With all these speeds, though, the actual clock speed doesn't change.

Booting is fast because the system performs only a limited memory check. You can run more extensive diagnostics with a supplied set of routines that check various subsystems (e.g., memory, keyboard, disk, and video) and that also include a low-level disk-format routine.

### Benchmark Standings

The Premium/386 offers performance that lies between that of the 16-MHz IBM PS/2 Model 80 and that of the 20-MHz Compaq Deskpro 386/20. In the low-level memory-access tests, the Premium/386 performed the Sieve and Sort benchmarks nearly as fast as the Compaq, but in the String Move and Matrix operations, it dipped to the level of the Model 80. Here the Premium/386's static-column architecture had a negative effect.

On the floating-point benchmarks, the Premium/386 fell between the Model 80 and the Deskpro in all three tests. It was a consistent 26 percent faster than the Model 80, and it ranged from 10 percent to 20 percent slower than the Deskpro 386/20.

The Disk I/O tests show that the performance of AST's Control Data hard disk drive with Western Digital's controller is nearly identical to that of the Compaq's drive. The two exceptions are the DOS Seek 1-sector test, where the Premium/386 was some 30 percent faster, and the 1-megabyte Write test, where the Premium/386 performed about 20 percent faster than the Compaq.

The Premium/386's performance in the Video benchmarks was disappointing. The Compaq was consistently faster in both text and graphics tests. The Model 80 performed better than the Premium/386 in the text benchmarks, and the Premium/386 barely edged out the IBM in graphics modes.

The applications benchmarks generally correspond to the low-level benchmark results. In most tasks, the Premium/386 lagged behind the Compaq and was 10 percent to 50 percent faster than the Model 80. Overall, a user running disk-intensive applications wouldn't notice much difference between the Premium/386 and the Compaq. Applications relying more heavily on computation and graphics output would find the Compaq somewhat faster.

### What Runs

The Premium/386 had no trouble running the following software: DESQview

*continued*

# REAL CADD FOR YOUR MAC... JUST \$99.95!

**Affordable CADD. And it's  
only the beginning.**

The CADD stands for Computer Aided Design and Drafting. With a suggested retail price of just \$99.95, Generic CADD Level 1 makes the power of real CADD affordable. And it's just part of a family of Generic CADD products that will make you more productive than ever before.



**Standard Mac interface for  
ease of use.**

Now you can produce accurate drawings with real world scale on the Mac Plus, Mac SE, or Mac II. You can edit multiple drawings in separate windows and cut and paste between them. CADD Level 1 is also multifinder compatible.

**Symbol Libraries boost  
productivity.**

From office furniture to specialized electronics symbols, our Symbol Libraries save you the time of redrawing repetitive elements every time you need them.

**Add the power of real CADD  
to your Mac.**

Move your Macintosh drawings into the real world. Call us at 1-800-228-3601 for your free CADDalog or the name of your Generic dealer. And find out why we say the only thing generic about us is the price.

© 1988 Generic Software, Inc. Generic CADD Level 1 is not copy protected and carries with a 60-day money back guarantee. Registered users get free technical support from Generic.

Level 1 and Generic CADD are trademarks of Generic Software, Inc. Macintosh is a trademark of the Apple Computer Corp.

11911 North Creek Parkway South, Bothell, WA 98011

**Circle 106 on Reader Service Card  
(DEALERS: 107)**

**Generic**  
SOFTWARE





Circle 128 on Reader Service Card

Integrand's new Chassis/System is not another IBM mechanical and electrical clone. An entirely fresh packaging design approach has been taken using modular construction. At present, over 40 optional stock modules allow you to customize our standard chassis to nearly any requirement. Integrand offers high quality, advanced design hardware along with applications and technical support *all at prices competitive with imports*. Why settle for less?

## Rack & Desk PC/AT Chassis



### Rack & Desk Models

Accepts PC, XT, AT Motherboards and Passive Backplanes

Doesn't Look Like IBM

Rugged, Modular Construction

Excellent Air Flow & Cooling

Optional Card Cage Fan

Designed to meet FCC

204 Watt Supply, UL Recognized

145W & 85W also available

Reasonably Priced

# INTEGRAND

RESEARCH CORP.

Call or write for descriptive brochure and prices:

8620 Roosevelt Ave. • Visalia, CA 93291

209/651-1203

TELEX 5106012830 (INTEGRAND UD)

EZLINK 62926572

We accept BankAmericard/VISA and MasterCard

IBM, PC, XT, AT trademarks of International Business Machines. Drives and computer boards not included.

## REVIEW

AN 80386 WITH A TWIST

2.01 (with QEMM), 386MAX, Windows/386, Windows 2.0, AST's version of OS/2, Concurrent DOS 386, WordStar 4.0, a beta release of WordStar 5.0, Turbo Pascal 4.0, T-DebugPLUS 4.0, Procomm 2.4.2, Microsoft BASIC 6.0, Lotus 1-2-3 version 2.01, VP-Planner 1.0, Professional CED 1.01a, Brooklyn Bridge 1.30, DeskLink 1.06/2.16, AutoCAD 9.0, AutoSketch enhanced version 1.01, Excel 2.0, and PageMaker 1.0.

AST's optional OS/2 software lets you boot either DOS or OS/2 from the hard disk. In addition, AST's OS/2 leaves your hard disk better organized than does IBM's. It stores only a dozen or so files in the root directory, versus three or four dozen with IBM's version. The rest it stores in the OS2 directory and in other subdirectories below it.

As for hardware, I had no problems installing and using a Microsoft Serial Mouse, a Quadram JT Fax board, a BocaRAM/AT extended memory board, or a Paradise AutoSwitch monochrome EGA card. However, I did have problems installing Orchid's Designer VGA and Paradise's VGA Plus boards on my review machine. With either card installed, the machine became extremely unstable, sometimes refusing to boot and at other times crashing unexpectedly, especially when I changed speeds using the keyboard commands. Also, the Orchid board simply wouldn't fit into the machine unless I removed the mounting bracket.

AST said it had not tested the Orchid board, but it claimed that the Paradise board was compatible. The company sent a second machine, and this time the boards worked flawlessly. Both machines were using BIOS version 1.2.

### Supporting Details

The Premium/386 has a 220-watt power supply and carries an FCC Class B certification, which means it's approved for home use. The motherboard, measuring about 10 by 13 inches, is divided into three areas. At the rear left are seven expansion slots. At the rear right are the peripheral interfaces (serial and parallel ports and the disk controller). The front half of the board holds most of the system logic, including the CPU, math coprocessor, BIOS EPROMs, keyboard controller, and I/O decoding. Instead of mounting memory on the motherboard, however, AST put it on a 32-bit card. The overall workmanship of the motherboard is excellent; there are only three jumper wires on the back of the board.

The Premium/386's keyboard is the same unit that ships with the Premium/

286. Its mushy feel is disappointing, given the overall quality of the system.

Finally, my EGA monitor had a tilt-and-swivel stand, but I couldn't tilt the monitor forward from the upright position. Counterbalancing that fault, however, are the front-mounted power switch and brightness and contrast controls.

Technical support is available for the price of a phone call. The technician I talked to was knowledgeable about simple setup and operational questions but weak in knowledge about wait states, reserved memory, and similar topics. A local dealer fared somewhat better, however.

The machine carries a 12-month parts and labor warranty (after shipping from an authorized AST reseller, or 14 months from AST, whichever comes first).

### The Cost Effect

If performance is paramount and money is no object, there are faster machines (Compaq's Deskpro 386/20 and ALR's FlexCache 20386, for example). However, you can buy a Premium/386 Model 390 with VGA adapter and monitor for \$9585, whereas a comparably equipped Compaq costs about \$11,400. In other words, the Premium/386 costs 85 percent of the Compaq price, but it provides more than 85 percent of the performance overall.

Also, the performance of AST's new 16-bit VGA card (released too late for this review) may equal or exceed the video performance of the Compaq and other machines, for just a few hundred dollars over the Premium/386's current price.

On the other hand, the motherboard has no on-board video adapter, regular memory, or cache memory. But because graphics standards are evolving so rapidly, the lack of a built-in video adapter is an advantage—you can upgrade that portion of the system as your needs require.

AST's SmartSlot architecture is a potential advantage for the Premium/386, if vendors design products that take advantage of its features. AST has published SmartSlot's specifications and has instituted a liberal licensing policy. But even if SmartSlot doesn't take off, the Premium/386 still provides good performance for a good price. ■

*Jeff Holtzman owns Publishing Concepts, a firm that specializes in evaluation, verification, and documentation of high-technology products. He lives in Ann Arbor, Michigan, and can be reached on BIX as "editors."*

# TimeWand® - Organizing Information

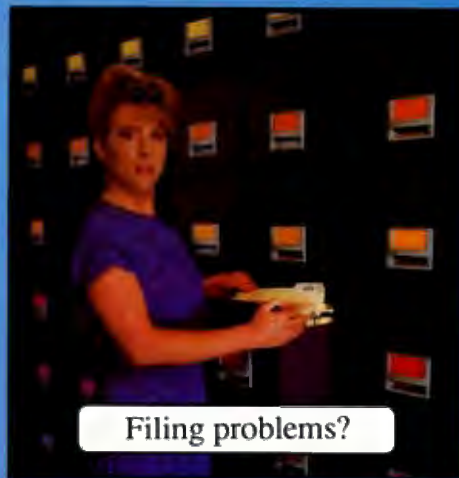

Filing problems?



Scan File



Scan ID Card



Transfer Scan Data



Edit Scan Data

**Document Control Report**  
File Room #5  
September 4, 1987

Code	Description	Employee	Date
006148	Jones Account	Fannie Bates	8/31/87
006164	Dawson Account	Pauline Towers	8/31/87
006165	Smith Reference	Pauline Towers	8/31/87
006166	Charlin Account	Pauline Towers	8/31/87
006167	Baker File	Matthew Webster	9/01/87
006173	1987 Research Budget	Matthew Webster	9/01/87
006178	Trowbridge Report	Matthew Webster	9/01/87
006179	Advertising Plan	Barb Mirch	9/02/87
006189	Laboratory Results	Barb Mirch	9/02/87
006195	Meeting Notes	Barb Mirch	9/02/87
006182	Garth Correspondence	Fannie Bates	9/02/87
006183	July Computer Sales	Fannie Bates	9/02/87
006184	Commerce Study	Fannie Bates	9/02/87
006185	Teller Audit	Matthew Webster	9/03/87
006186	Product Specifications	Matthew Webster	9/03/87
006187			9/03/87
006188			9/03/87

Develop Data Reports

## Applications for the TimeWand - Document Control

*Ever wonder who has that important file on the Jones account?* There is no record of who took it from the file room and no one remembers who had it last. You spend your valuable time and patience tracking it down, but when you finally locate the file, it may be too late for timely use.

Make it easy on yourself by tracking documents with the TimeWand. By simply scanning the bar code on the Jones file and your employee ID number (or department name), the TimeWand records who has the file *and* the time it was taken.

The TimeWand is simple to operate, yet provides the data necessary to create detailed reports. Generate reports by incorporating data collected with the TimeWand into your data base. The reports allow you to quickly find who has those important files, check a file's current activity, identify which items are 'slow movers', or show the amount of traffic the file room handles each day.

No manual data entry or deciphering of your co-worker's handwritten notes is required. All TimeWand entries are made by scanning bar codes! It's fast, easy, and, most importantly, organized.

TimeWand. It helps you keep up with the Joneses.

**TimeWand (2K version) - \$198**  
**Single Recharger and Cable - \$149**  
**TimeWand Manager Software (Macintosh) - \$489**  
**TimeWand Communication Software (IBM) - \$299**



1105 N.E. Circle Blvd., Corvallis, OR 97330-4285  
503-758-0521

Videx and TimeWand are registered trademarks of Videx, Inc.



# CLEO is your SNA, BSC and Coax Gateway



VMS  
UNIX  
XENIX  
PC-DOS  
Macintosh  
NetBios LAN

## Sharing Information

Whatever your industry, your computers need to share information with your mainframe. Or, they need to exchange data with other computers. In either case, you need a total communications solution. You need software, hardware interfaces and modems that all work together smoothly. You need CLEO!

CLEO software products allow your computer to communicate with mini-computers and mainframes, and to emulate their workstations. Since 1981, CLEO has provided communications between micros, minis, and mainframes for the automotive, insurance, medical and banking industries. Today over 78,000 CLEO users worldwide are running on all major computer brands. The greatest number of these users run CLEO software on IBM Personal Computers and NETBIOS LANs.

## Complete Software/Hardware Package

Every CLEO package contains all the software and hardware accessories you'll need. Your selected CLEO SNA, BSC, or Coax software is packaged with 1) an internal modem card for dial-up applications, or 2) an interface card and cable for use with your existing modem, or 3) a Coax card for local connectivity. There's no waiting for non-CLEO add-ons. And, you get prompt, single-source service.



Package prices range from \$795.00 for most stand-alone packages, up to \$1,995.00 for the 32-user SNA gateway.

Call us today to discuss your application.

**CLEO Software**  
1639 North Alpine Rd.  
Rockford, IL 61107  
Telex 703639  
FAX 815/397-6535

## Headquarters:

USA: 1-800/233-2536  
Illinois: 1-800/422-2536  
International: 815/397-8110

## Sales and Distribution:

Benelux: 31 (0) 33-948888  
Canada, East: 800/361-3185  
Canada, West: 800/361-1210  
Canada, Montreal: 514/737-3631  
Colombia, S.A.: 12172266  
Denmark: 02 94 81 19  
England: (0993) 776543  
France: 146861136  
Italy: (0331) 634 562  
Mexico City: 596-5539  
Sweden: 468311780

**CLEO**



# Fax Board Faire

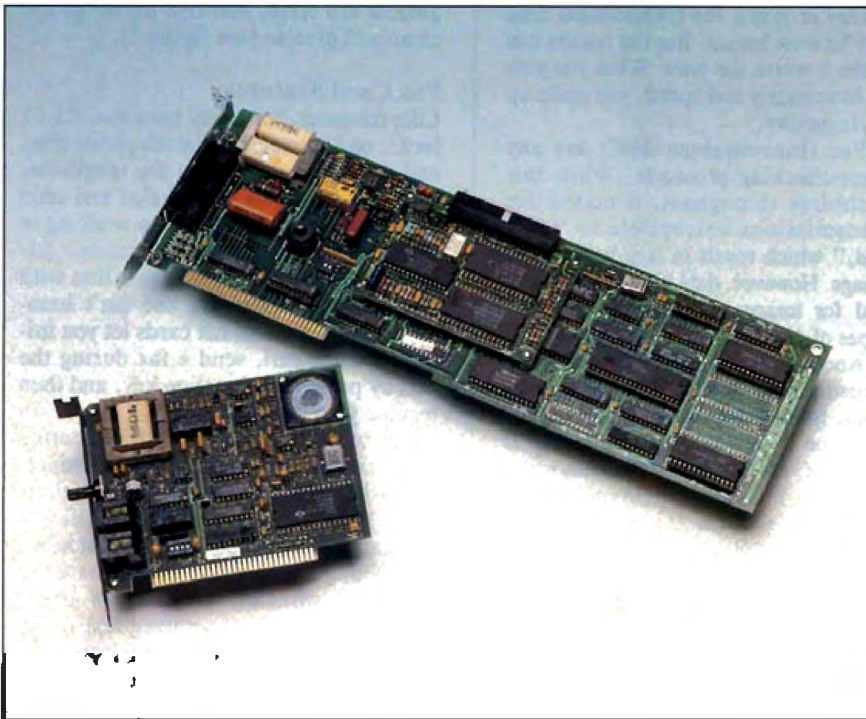

Facsimile boards offer high-speed text and graphics file transfers from the desktop

Brock N. Meeks

The latest high-tech catchphrase is the trendy-sounding "image communications." This entails sending bit-mapped text and graphics information across a city, or across continents, simply by inserting a document into a facsimile machine and pressing a button. In 30 seconds or less, an exact duplicate crawls out of the remote machine. It's a heady process, and it's easier to comprehend than the telephone. Now implementations of this technology on microcomputers are gaining popularity.

If the last fax machine you were acquainted with was that hulking monster in the corner of the mail room, look again. The newest fax machines are smaller, cheaper, and easier to use than some multibutton telephones. Microcomputer fax cards share much of the same simplicity while offering better

image quality and the ability to store image files to disk. Regular RJ-11 connectors tie them into your telephone line, giving you the option of voice or fax transmission.

## What, Me Fax?

The appeal of fax technology isn't so much due to its trendy high-tech status as to its down-to-earth practicality. Fax can marry graphics images with pages of text and send those documents from Toledo to Tibet in a matter of seconds—something that anyone who has tap-danced on a tight deadline or winced at the price of sending documents by overnight courier can appreciate. And since fax is virtually instantaneous, it can salvage a deadline for the price of a phone call.

Fax cards fit into a standard slot in your microcomputer and support the 9600-bit-per-second CCITT Group III fax standard. (See the text box "How Fax Works" on page 204.) The cards also include software for converting ASCII text and graphics files to bit-mapped fax image files. Once you've converted a file, you can store it, fax it to another machine, or print it out.

Fax cards aren't intended to replace the traditional fax machine, but to turn the desktop into a communications center with full graphics capabilities. Still, fax cards do have some distinct advantages over their stand-alone cousins.

One advantage is better image quality. A traditional fax machine is convenient; you simply insert a document, dial the remote machine, and press a button. But what stand-alone fax gives you in convenience, you give up in quality. Chunky, jagged fonts printed on flimsy thermal-transfer paper are the trademark of stand-alone fax machines. These look bad, in part, because they're third-generation copies. The document usually starts out as a file, which you then print. Next, you feed the document into the fax machine, which scans it and sends it to

*continued*

Datacopy's Microfax (top) boasts a Hayes-compatible modem and support for AutoCAD files; Quadram's JT Fax 4800 (bottom) offers basic fax capabilities for under \$400.



## How Fax Works

**A**lthough current fax technology zips along at 9600 bps, the road to these high-speed image transfers was a long one.

The ability to transmit bit-mapped images isn't new; the technology to transmit signals over a wire and onto paper has been around since Alexander Bain patented such a device in 1842, and newspapers have used the wire services to transmit photographs for decades. So what took so long? In a word: standards. There were none.

Fax machines became popular only after the mid-1960s, when the CCITT (International Telephone and Telegraph Consultative Committee) hammered out the world's first set of fax transmission standards, called Group I. Since then, the CCITT has developed three other sets of standards (Groups II through IV). Each successive standard has provided fax technology with a quantum leap both in image quality and transmission speed.

The Group I and Group II standards are based on analog technology. Early Group I fax machines operated much like a 300-bps modem and took 6 minutes to send a single page. Group II machines, introduced in the mid-1970s, improved resolution and cut transmission time to 3 minutes per page. These are the fax machines most people probably remember dealing with in the mailroom. They were unwieldy and were prone to jamming and telephone line noise. A fair number of Group II machines are still around.

The big break in fax technology came in 1980 when the CCITT approved the 9600-bps Group III standard; most fax machines and fax cards today conform to it. Group III broke away from the analog world by implementing digital image scanning and data compression methods.

Many Group III products use the Rockwell V.29 chip set, which uses the CCITT V.29 half-duplex 9600-bps file transmission standard and the Modified Huffman compression scheme. Fax machines use this scheme to compress much of the white space in a document. The fax image file is compressed en route to the remote machine; on arrival, it is decompressed (decoded) for storing to disk or printing.

The top-end resolution for Group III fax machines is 200 dpi. A typical

transmitted page in normal resolution (actually 203 dpi horizontal by 98 lines per inch) takes from 15 to 20 seconds on a "clean" phone line. However, many documents, especially those with lots of graphics, are transmitted in fine mode, which increases the vertical resolution to 196 lines per inch and doubles the transmission time. If your fax card happens to have gray-scaling capability (the ability to read and transmit subtle shades of gray), the transmission time can be even longer. But the results can make it worth the wait. What you give up in economy and speed, you make up for in quality.

Fax transmissions don't use any error-checking protocols. While this optimizes throughput, it makes fax transmissions susceptible to "data hits," which result in tiny holes in an image. However, data hits aren't as critical for images as they are for other types of data, such as program code.

Another nice feature of Group III fax transmissions is that they have automatic fallback protocols. If a Group III machine is transmitting to a Group II machine, for example, it automatically falls back to the slower Group II transfer rate. In addition, if it can't establish a connection at 9600 bps due to poor line quality, it will try to connect at 7200 bps, and then at 4800 bps.

The Group IV standard, approved last January, is a bit ahead of its time. To use a Group IV-compatible fax, you must have a leased telephone line or connect to an Integrated Services Digital Network (ISDN), which has yet to become widely available. Group IV-compatible machines, at about \$10,000, are high-priced, but you do get a dramatic increase in performance: 30 pages per minute at 400 dpi. Federal Express based its ill-fated Zap Mail service on Group IV fax.

While the fax industry looks to the day when ISDN becomes a reality, at least one promising advance awaits implementation in the Group III arena. Last September, Rockwell announced a compact, CMOS low-power, full-duplex V.32 9600-bps modem board, called the R9696DP. Essentially a modem on a chip, this board promises to change the complexion of the fax card market by allowing such cards to support full-duplex fax or modem transmissions at 9600 bps.

the remote fax, which prints it again. This process of converting and printing the document file lowers image quality significantly.

By contrast, documents created on a personal computer and sent from a fax card require no intermediate conversions, so they produce first-generation documents. If you happen to be sending an image file to another fax card, it's possible to store the image to disk or output it to a laser printer. Anyone familiar with the less-than-stellar thermal-print quality of a fax document is in for a pleasant surprise: Laser-printed fax documents are crisp, and line drawings are clean and precise (see figure 1).

### Fax Card Features

Like modems, fax cards have two RJ-11 jacks; one connects to the telephone line, and the other attaches to the telephone. The first input lets the fax dial and send and receive documents, often working in background or unattended mode. Although your telephone shares a line with the fax card, telephone use isn't hampered. In fact, most fax cards let you initiate a voice call, send a fax during the call by pressing a function key, and then resume your conversation.

Software is the key to differentiating between fax cards. Some of the products reviewed here are "bare bones" units that offer conversion of ASCII files to bit-mapped fax image files, but not much else. Others are packed with an array of bells and whistles. If your fax needs don't go beyond transmitting text documents and an occasional graph or two, then a fax card without all the fancy features should serve you well. However, if you're looking for a full-function card, you'll want to check into some of the more advanced features.

Two key features included with most fax cards are unattended (automatic) polling, and broadcasting. With automatic polling, you configure your fax to call a designated group of other fax numbers at a specified time to see if they have anything to deliver. To broadcast a document, you specify a list of telephone numbers you want a document faxed to at a specific time; transmission then occurs automatically. Some fax cards limit the number of locations you can put into a list; others let you string together multiple lists to broadcast to a virtually unlimited number of machines. Broadcast capability makes it easy to schedule transmissions in the early morning hours, when telephone rates are lowest. And when your fax card isn't sending those documents, it can receive fax



transmissions or poll other machines.

Another consideration is whether you can view files on-screen before printing or faxing them. Most fax cards support this capability. Seeing how a file will look before faxing it helps ensure that the receiver will get the correct image. Another handy feature is background-mode operation, which lets you work on a spreadsheet or word-processing file while sending a fax.

You may want a fax card that accepts optical scanner input. Some cards include special optical-character-recognition (OCR) software for this purpose. Others may also include a port to connect the scanner directly to the fax card. A related feature is the ability to accept and transmit gray-scale images—a crucial feature for transmitting multicolor drawings or photographs. Fax cards with gray-scale capability pick up and transmit subtle shades.

Not all fax cards are compatible with every graphics format. Be sure that the conversion software supports TIFF (Tag Image File Format) if you're using PageMaker, .PCX files for PC Paintbrush, .PLT files for AutoCAD, and so on.

Most cards keep some kind of "activity log" that stores information about the fax transfer process. This lets you monitor fax transmissions and determine if any transmission failures have occurred. Some cards also include a modem, making maximum use of the computer's slot. Finally, you should make sure that the fax card supports your printer.

### Trials and Tribulations

I tested 10 fax cards on an IBM XT compatible with a 20-megabyte hard disk drive, a Hercules graphics card, and 640K bytes of RAM. All tests were run at 8 MHz. See the table on page 206 for a listing of the products and their features.

Before reviewing the results, a few caveats are in order. First, converting files from ASCII to fax with a system running any slower than 8 MHz is unbearably slow. Second, converted fax images gobble disk space, so leave plenty of room on your hard disk. A typical page of text requires about 60K bytes of storage as a fax image file; a detailed, multi-gray-scale picture can eat up as much as 500,000K bytes.

Also, if you're a fan of RAM-resident programs, break your habit, at least when you're using fax software to convert files to fax images. More than once, after I waited minutes for a fax image conversion to finish, the entire system locked up because I didn't have enough RAM overhead.

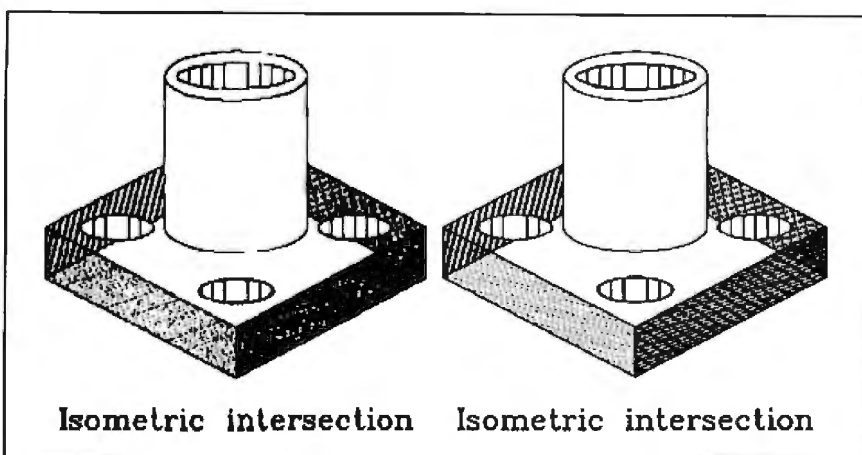

Figure 1: The image at left is an AutoCAD file that was printed on a LaserJet II and transmitted between standard fax machines. The image at right is the same file, sent between PC fax cards and output to the same printer.

I also experienced problems when exiting from some fax card programs. Not all software packages would issue error reports; some locked my machine up and I had to reboot. Here again, you have to watch what programs you have in RAM. It's a trial-and-error process, unfortunately, as none of the manuals give specifics on which RAM-resident programs may cause problems.

That said, here are the highlights of my experience with 10 fax cards.

### Fax-Mail 96

Brooktrout Technology's Fax-Mail card comes in three versions: the \$599 9600-bps fax card reviewed here, a 2400-bps model (\$399), and a 4800-bps model (\$499). For the difference in price, I can't imagine why anyone would opt for the slow speed of the 2400-bps fax card.

The Fax-Mail 96 includes the ability to merge text files with letterhead. Getting the letterhead encoded as a bit-mapped fax image file requires a scanner, however. You could input a printed copy of the letterhead from a stand-alone fax machine, but the image quality would leave much to be desired.

Brooktrout's Chop feature separates a received fax image into different files. For example, you can cut both the letterhead and the signature from an original fax so you can merge them into other fax documents. You can also use PC Paintbrush to clean up the letterhead or other images.

Other features include Supershow, which lets you scale down a multipage fax image so you can view multiple pages on your screen, and a printer capture option that can create a fax image file from word-processing files sent to the printer

port in Epson FX-80 format. The latter converts text and attributes (such as bold-facing and italics) to fax image files. Fax-Mail also supports several word-processor file formats, including Microsoft Word and WordPerfect.

Conversion software transforms ASCII and PC Paintbrush files to fax image files, and it also can convert fax image files back to PC Paintbrush.

### JT Fax 4800

If any fax card marches to the beat of a different drummer, Quadram's JT Fax is it. Although this is the least expensive of the cards reviewed, it offers several heavyweight features that make it ideal for small business or personal use.

One standout feature of this card is the way it converts files to fax images. With most fax cards, you must run all files through a conversion process before transmitting them. The large size of fax image files quickly depletes hard disk real estate, however. In contrast, the JT Fax does file conversion on the fly. It determines what type of file it's going to send, and after making a connection with a remote machine, it converts the file as it's transmitted.

This approach has one small drawback: It limits the board's speed to 4800 bps. The slower speed shouldn't be a problem for the occasional fax user, however, and the board's low price and the fact that your disk drive isn't cluttered with several 50K-byte-plus files is adequate compensation.

The JT Fax accepts input from an external scanner and lets you send documents to another fax or to your printer as they're scanned, without first storing

*continued*



REVIEW  
FAX BOARD FAIRE

Product and company	Price	Speed (bps)	RAM required (bytes)	Board size	Hayes-compatible modem	Scanner port
<b>Fax-Mail 96</b> Brooktrout Technology, Inc.	\$599	9600	512K	Full	No	Yes
<b>JT Fax 4800</b> Quadram Corp.	\$395	4800	256K	Half	No	No
<b>The Complete Fax</b> The Complete PC	\$499	4800	512K	3/4	No	No
<b>MFA96P</b> Microtek Lab, Inc.	\$995	9600	256K	Full	No	Yes
<b>Facsimile Pac</b> Dest Corp.	\$995	9600	640K	Full	Optional 1200-bps (\$129)	Yes
<b>pc-Fax</b> EIT, Inc.	\$1095	9600	640K	Full	No	No
<b>GammaFax</b> GammaLink	\$995	9600	256K	3/4	Optional 1200-bps (\$200)	Yes
<b>Microfax</b> Datacopy Corp.	\$1195	9600	384K	Full	1200-bps	No
<b>Faxcard/Fax Partner</b> SpectraFAX Corp./Panasonic Industrial Co.	\$999	9600	640K	3/4	No	No
<b>SmartFax</b> American Data Technology, Inc.	\$949	9600	640K	2/3	No	Yes

them to disk. The unit does not operate in background mode, however.

Another feature is support for gray-scale images, and there is another utility that automatically merges text with an image file containing your letterhead and signature. Again, the process occurs on the fly.

#### The Complete Fax

The Complete Fax is a low-cost, multi-featured fax card from The Complete PC that operates at 4800 bps. The Complete PC doesn't make grandiose claims; it simply promises solid fax transmission capabilities. It delivers.

You can create fax documents from PC Paintbrush, Windows Paint, and Dr. HALO formatted files, and you can store these converted documents in either standard or fine mode. (Fine mode is 203 by 196 dots per inch, which eats disk space at four times the rate of the stan-

dard 203-by 98-dpi mode.) The file conversion process is one of the quickest I tested.

The Complete Fax's Facsimile Directory function lets you overlay any fax image with another. This merging function gives you crude, but effective, graphics manipulation capability. However, it's easier to just convert the files to .PCX or another graphics format, massage them with a paint program, and turn them back into fax files again. If your word processor includes an Epson MX printer driver, you can also send text files with all attributes.

An option, The Complete Hand Scanner (\$249), works in tandem with The Complete Fax. The scanner is a glitzy, mouse-type device that scans images up to 2½ inches wide by 10 inches long. You can store the images in any file format compatible with The Complete Fax. The scanner is great for scanning logos, line

art, and letterheads. It also includes custom software, called Soft Stationery, that lets you create any kind of letterhead you can scan into your computer.

Another card, the CFA9600 (\$599), was introduced too late to include in this review. This 9600-bps fax card features a scanner interface port, an optional 2400-bps modem, a mail-merge function, and Epson FX print-capture capability.

#### MFA96P

The MFA96P fax card is an appendage of Microtek Lab's scanner line. Six months ago this board was a bad deal. Today, it's an adequate implementation of fax technology.

Version 1.11 of MFA's software left much to be desired, including the glaring omission of an ability to view a fax image file on your monitor before transmitting it. The beta copy of version 2.0 that I reviewed has solved that problem.

REVIEW  
FAX BOARD FAIRE

Background mode	Polling	Maximum broadcast	Printers supported	Software features	Standard files converted
Send/receive	Yes	Unlimited	Epson, IBM, HP LaserJet, others	Text/graphics editor	ASCII, PC Paintbrush, formatted Epson FX-80 word-processing files
No	No	Unlimited	Epson, IBM, Toshiba, HP LaserJet, others	Automatic file conversion, help	ASCII, PC Paintbrush
Send/receive	Yes	25	Epson FX, Toshiba, IBM Graphics, NEC, HP LaserJet, others	Help, cover-page generation, graphics editor	ASCII, Dr. HALO, PC Paintbrush, Microsoft Windows Paint, Epson MX-formatted word-processing files
Send/receive	Yes	Unlimited	Epson FX, LQ; Canon, HP laser; others	None	ASCII, TIFF
Send/receive, print	No	Unlimited	Epson FX, IBM Graphics, Toshiba, IBM Matrix, HP LaserJet, others	Mail-merge fax, image file encryption	ASCII, Dr. HALO, PC Paintbrush
No	Yes	Unlimited	Epson, HP LaserJet, others	Help, text and image merging	ASCII, PC Paint
Send/receive	Yes	Unlimited	Epson, IBM, Fujitsu, NEC, Toshiba; Canon, HP laser; others	Help, windows, LAN support	ASCII, AutoCAD, Dr. HALO, PC Paintbrush, TIFF, Hewlett-Packard HPGL plotter files
Send/receive	Yes	160	Epson FX, Toshiba, IBM Graphics, NEC, HP LaserJet, others	Help, text editor, direct printing of incoming fax, automatic file conversion	ASCII, PC Paintbrush, TIFF
Send/receive	Yes	100	Epson, NEC, Toshiba, Panasonic, HP LaserJet, others	Graphics editor	ASCII, PC Paintbrush, many word-processing files
Receive	No	999	Epson FX, LQ; IBM Graphics; Canon, HP laser; others	Help, graphics editor, area-code lookup, blank page creation	ASCII, TIFF, Dr. HALO, PC Paintbrush, WordStar

High points of the new software include the ability to print documents at either 204 by 196 dpi or 300 by 300 dpi. This lets you expand a fax image to 300 dpi when printing to a laser printer, which is handy if you've received a fax that's formatted on a desktop publishing program.

You can also send a text file without running it through the conversion program. This solves the MFAX's earlier problem of having to break multipage documents into separate files before converting them. When you choose an ASCII file for faxing, the software automatically converts it to a fax image, as long as the file has a .TXT extension.

The program's built-in editor lets you create memos without exiting to your word processor. This is handy when you need to fax quick notes, but for extensive text processing, you'll still want to use your word processor.

The Easy Send feature lets you send hard-copy documents through a scanner to the MFAX card and on to another fax machine with the press of a key. This feature is so simple that even the most paranoid technophobe can handle sending a fax from the computer. Also, the MFAX96P has a built-in scanner port, so you can add a scanner without giving up an extra slot in your computer.

I have two gripes about this unit. First, the board requires you to set more hardware switches than does any other fax card, and the process isn't well documented. Other fax cards operate on a "plug and go" principle; I don't know why Microtek chose to make the user do all the work.

Also, while the MFAX supports TIFF files, there is no facility to convert files from any paint programs; you have to either scan pictures into the system or forget about sending graphics. EyeStar

Plus software, included with Microtek scanners, converts PC Paintbrush and Windows Paint files to fax image files, but for this you have to purchase a scanner, which ranges from \$995 to \$3995.

#### Facsimile Pac

Dest's Facsimile Pac has two noteworthy options. The first is a 1200-bps Hayes-compatible modem (\$129). The second is a plug-in chip (\$195) on the fax card that provides full Department of Defense Data Encryption Standard (DES) encryption capability.

The DES chip is a serious-minded (and handy) capability, although the documentation, which reads like backyard mystery theater, takes itself perhaps too seriously. One passage reads: "Use this option to send and receive confidential documents in *secret code*" (italics added).

*continued*



For security at both ends, the DES chip establishes a public key (key A) between the two machines. This is common to the encrypted message. However, a second, private key (key B) is known only to the receiver. If both keys don't match, the message remains scrambled.

Like the MFAX, the Facsimile Pac card includes a scanner port, saving a card slot if you decide to add a scanner.

Facsimile Pac supports file conversion, printing, and sending and receiving files in background mode. The software operates as a terminate-and-stay-resident (TSR) program that you can invoke within other applications to send files. It also lets you set up a rather sophisticated telemarketing blitz using fax machines: By inserting "tags" into your text, you can create a mail-merge application that sends mass mailings via fax.

Dest has provided a fax card with an impressive array of features. If you need the security of DES encryption (when transmitting confidential contracts, for example), you should think seriously about the Facsimile Pac. You certainly don't lose any capability; in fact, the card is of intelligent design, and the software is more than adequate. For those who want sophisticated scanner support and multiple fax options, this is the product.

#### pc-Fax

EIT's pc-Fax provides the usual host of features, including polling, laser-printer support, and a funky background mode for receiving image files.

Contrary to what the name implies, "background" mode is only in the background until called on to receive a fax. When pc-Fax picks up a carrier tone, it automatically halts everything—your computer locks up and becomes hostage to the fax transfer. Although this acts as an "insurance policy" for the reliability of the fax transfer, it's annoying to have your work flow suddenly and unexpectedly grind to a halt for an incoming fax. EIT says it is working on true background-mode capability.

The card also has a built-in binary transfer capability that runs on the IBM PC AT and compatibles at the blazing rate of 9600 bps, as long as each end runs a pc-Fax board. With vanilla PCs, the transfer rate slows to 4800 bps. (Other fax cards with binary transfer capability performed similarly.) The software uses pull-down menus and provides mouse support.

The pc-FAX's OCR capability recognizes four fonts and converts them to ASCII format. In addition, you can "teach" the software to recognize other

fonts. The pc-Fax card is perhaps the most versatile of the bunch at turning hard copy into a machine-readable format.

#### GammaFax

GammaLink was one of the earliest players in the fax card market, and that experience shows in the number of features its GammaFax card offers. The latest version of the software (4.0D) is a vast improvement over an earlier version I received, which didn't function properly when sending a fax during a voice-initiated call.

Features include the ability to write batch files to, for example, send a text file from one microcomputer to another microcomputer's GammaFax card via a local-area network. Also, a cut-and-paste function lets you cut out sections of a fax image, such as a logo or a signature, and put them into separate files.

Like the pc-Fax board, GammaFax can also perform binary file transfers between PCs or ATs and compatibles using GammaFax boards at 4800 and 9600 bps, respectively. You can also purchase a version of the GammaFax card that includes a 1200-bps Hayes-compatible modem for an extra \$200.

GammaFax's software converts ASCII, Dr. HALO, PC Paintbrush, AutoCAD, TIFF, and Hewlett-Packard Graphics Language (HPGL) plotter files. If you haven't converted your file before it's queued to send, the software will automatically convert it to a fax image.

GammaLink technical support helped solve a problem I had with converting from ASCII to fax image files—this was the previously mentioned RAM overhead problem caused by TSR programs. Finally, the documentation is well written and includes numerous tips sections, set apart from the main text by italics.

#### Microfax

Datacopy's Microfax is the standard against which to measure other PC fax cards. Microfax's documentation is straightforward, and Datacopy seems to have a clear idea of the proper role of a fax card.

After crawling through thousands of pages of documentation for other cards that was either poorly printed or "typeset" on the first available letter-quality printer, the documentation supplied with Microfax was a sight for sore eyes. Ample use of white space and crisp typefaces gave me the impression that the company cared about its product. That impression wasn't misleading.

Easy-to-use menu screens and simple file-conversion procedures make the Microfax's software stand out. The Microfax can convert TIFF and PC Paintbrush files, and AutoCAD converts files to the Microfax's proprietary .IMG image format. The unit also includes a 1200-bps Hayes-compatible modem that worked flawlessly. If you're sending a file to a remote PC with a Microfax card, you can also take advantage of the card's 9600-bps binary file-transfer capability.

Datacopy is known for its scanners, so it's no surprise that Microfax is compatible with a host of units. Microfax stores scanned files to disk as an image file before letting you send them to another fax machine. Optional OCR software (\$695) converts between fax images and a variety of word-processing formats. The scanner software recognizes 19 fonts, and you can program it to recognize others.

#### Faxcard/Fax Partner

Ease of use and attention to detail are the hallmarks of SpectraFAX's Faxcard. Panasonic also licenses this board as the Fax Partner, which is identical in every respect to the Faxcard. SpectraFAX has gone out of its way to make things easy, including building the fax card around the 8081 microprocessor and stuffing the 3/4-length board with 256K bytes of RAM, which isn't cheap these days.

The 8081 gives the fax card a certain independence not found in other products. This is handy if you plan to send and receive fax documents in background mode. Most fax cards will slow the application you're currently working on when the fax card goes into action. But because the 8081 processes the fax transmission, even a system running at 4.77 MHz isn't affected.

This card gets a special nod for the way it converts files. You don't have to agonize through the tedious conversion process. Instead, sending a file entails nothing more than selecting it with a highlight bar. The software then takes care of all conversion before transmitting it to the remote fax.

The Faxcard/Fax Partner automatically converts images it receives to a proprietary .PCX-type format. You can only manipulate the graphics format files through a built-in graphics editor, however. This feature relieves you from fumbling with several file formats, but it limits you to working with PC Paintbrush files. As extensive as the graphics editor is (the 320-plus-page manual contains 134 pages of instruction on how to

*continued*

# 7.5 good reasons to try ASYSTANT GPIB.



**1** No programming required—  
be up and running from day one.

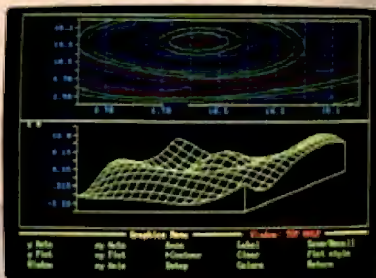

**2** Now you can store,  
plot, reduce, analyze,  
compare, archive,  
characterize,  
and calculate  
your data.

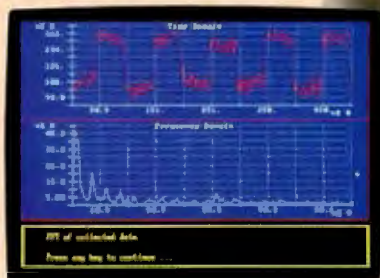

**3** Pick from a menu  
to create automated  
routines that bring  
your data from source  
to solution—even when  
you're not there.

**4** You can generate  
hard copy records,  
both tables and plots,  
with a single keystroke.

**5** ASYSTANT GPIB  
supports most IEEE-488  
interface boards.\*

**6** Full technical support is never  
more than a phone call away.

**7.5** 90-day money-back guarantee.

This is only half a reason, because we know  
you'll find ASYSTANT GPIB indispensable.

For the IBM PC, XT, AT, or 100% compatible computers and the IBM PS/2.

\*GPIB interface boards supported include:

#### PC/XT/AT:

- National Instruments GPIB-PC, GPIB-PCII, GPIB-PCIIA, and GPIB-PCIII
- Capital Equipment PC <-> 488 Models 300 and 310, 4x488
- MetraByte IE-488
- IBM IEEE488-GPIB
- Hewlett Packard 27209A
- IOtech GP488A

- Scientific Solutions IEEE-488LM
- Qua Tech MXI-100
- BBS GPIB-1000
- Ziotech ZT 1444
- Advantek PCL-748

#### PS/2:

- IOtech Personal488/2
- Capital Equipment PS <-> 488

Please give us a call for additional boards supported.

For technical details call 1-800-348-0033.

Circle 20 on Reader Service Card

**ASYST**  
SOFTWARE TECHNOLOGIES, INC.

100 Corporate Woods  
Rochester, NY 14623  
1-800-348-0033  
(or 716-272-0070)

\*IBM, Asyst Software Technologies, Inc.

ASYSTANT is a trademark of Asyst Software Technologies, Inc. Other brand and product names are trademarks or registered trademarks of their respective holders.



## Company Information

### American Data Technology, Inc.

44 West Bellevue Dr., Suite 6  
Pasadena, CA 91105  
(818) 578-1339  
Inquiry 923.

### Brooktrout Technology, Inc.

110 Cedar St.  
Wellesley Hills, MA 02181  
(617) 235-3026  
Inquiry 924.

### The Complete PC

521 Cottonwood Dr.  
Milpitas, CA 95035  
(408) 434-0145  
Inquiry 925.

### Datacopy Corp.

1215 Terra Bella Ave.  
Mountain View, CA 94043  
(415) 965-7900  
Inquiry 926.

### Dest Corp.

1201 Cadillac Court  
Milpitas, CA 95035  
(408) 946-7100  
Inquiry 927.

### EIT, Inc.

25 Just Rd.  
Fairfield, NJ 07006  
(201) 227-1447  
Inquiry 928.

### GammaLink

2452 Embarcadero Way  
Palo Alto, CA 94303  
(415) 856-7421  
Inquiry 929.

### Microtek Lab, Inc.

16901 South Western Ave.  
Gardena, CA 90247  
(213) 321-2121  
Inquiry 930.

### Panasonic Industrial Co.

Two Panasonic Way  
Secaucus, NJ 07094  
(201) 348-7000  
Inquiry 931.

### Quadram Corp.

One Quad Way  
Norcross, GA 30093  
(404) 923-6666  
Inquiry 932.

### SpectraFAX Corp.

209 South Airport Rd.  
Naples, FL 33942  
(813) 643-5060  
Inquiry 933.

use it), it's only adequate, at best, for most advanced graphics needs. The fax card seems more useful for transferring text documents.

Transmitting any kind of ASCII file with this card is easy. However, you can broadcast to a maximum of only 10 machines per list, although you can string together up to 10 lists to broadcast to up to 100 machines per session. The software converts files from a variety of word-processing formats, including WordStar, Microsoft Word, and WordPerfect.

### SmartFax

SmartFax from American Data Technology comes in a slick, fire-engine-red box. The documentation manuals are also slick, fire-engine-red. Unfortunately, that's as slick as it gets. Once you've slogged your way through a tedious setup procedure, you're ready to decipher a manual "typeset" on some-

one's letter-quality printer.

A special software module handles file conversion. The manual makes a point of telling you that you don't need to convert files beforehand, thus wasting disk space, because SmartFax can handle such a feat when the transmission sequence begins. But just a few paragraphs later, the manual warns against transmitting documents on the fly. The reason: If you're converting a big document, it could take a long, long time—and chew up disk space in 100K-byte chunks, to boot.

SmartFax supports Dr. HALO, TIFF, PC Paintbrush, and WordStar files. It also includes a small graphics editor that is woefully lacking. It can rotate an image and cut and paste, but not much else. Yet the manual spends an inordinate number of pages teaching how to use it.

When you get ready to transmit a document, you can choose to display the world's time zones on your screen with

the hours (+ and -) as they relate to Greenwich mean time. In addition, SmartFax includes a built-in database of worldwide area codes.

A new version of the SmartFax software, and a new board, the SmartFax Plus, were introduced too late for this review. The software is now RAM-resident and offers an FX-80 print-capture ability. The new card includes an on-board 8188 with 512K bytes of RAM and a 1200-bps modem option.

### Fax Me the Envelope, Please

Getting the most out of microcomputer-based fax requires a supporting cast of hardware, such as an image scanner and a laser printer. Scanners are probably the most prevalent option, but they still are considered expensive extras. In addition, they may take up a precious slot in your computer, and their supporting software eats disk space. And if you don't already have one, you might not be prepared to buy a laser printer just so your fax card can generate high-quality printouts. What you save by buying a fax card (for around \$1000, compared to \$2000 to \$3000 for stand-alone machines), you can end up spending many times over on supporting hardware. On the other hand, the convenience of being able to send a fax directly from your computer and the ability to use fax to transmit graphics image files between machines are distinct advantages.

The bottom line on fax cards, and on fax technology in general, is that they give you easy access to a fairly complex technology. A stand-alone fax machine is essentially a telephone into which you can insert a piece of paper. With a fax card, you can eliminate the paper at both ends.

Which fax card is the best? That depends on your application. The JT Fax 4800 has all the features most people need for the least amount of money. For a full-featured fax card, Datacopy's Microfax is the best bet. This card handles a variety of file formats, includes an on-board modem, and is compatible with Datacopy scanners. Although other fax cards offer similar features, Microfax's implementation makes things easier for the user. The documentation is good, file conversion is uncomplicated, and the software's menus are easy to use. ■

*Brock N. Meeks is a San Diego-based freelance writer specializing in high technology. He also writes BYTE's monthly column on microcomputer communications. He can be reached on BIX as "brock."*





"The Dataworld 286 [12MHz] AT compatible... [is]... the fastest machine of the nine tested in that review [July 1988]."

(September 1988 edition).

and

... speed and excellent compatibility ... hundreds of dollars less expensive than other AT compatible.



### DATA-286 20MHz

80286 running at 20/10MHz. Phoenix or Award BIOS  
1 MB of RAM expandable to 16 MB (2 MB on board)  
W.D. 1:1 interleave dual hard disk controller  
101-key keyboard with "click". Socket for 80287  
EMS 4.0 support for memory over 1 MB. Real time clock  
Monographics card w/parallel port. TTL Monitor included.  
**\$1555.00**

### DATA-286 12MHz

80286 running at 12/8MHz. Phoenix BIOS  
512 KB of RAM expandable to 16 MB (1 MB on board)  
One 1.2 floppy drive. Floppy/Hard disk controller  
101-key keyboard with "click". Socket for 80287  
Real time clock with battery back-up. 200W power supply  
Monographics card w/parallel port. TTL Monitor included.  
**\$1195**

DATA-286 10MHz  
AVAILABLE

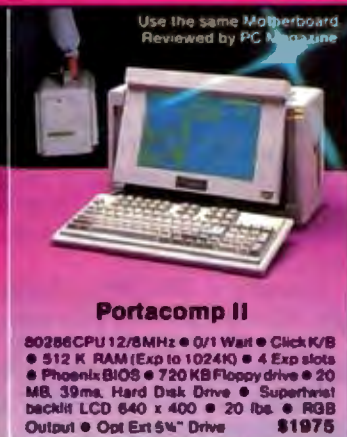

Prices subject to change. No charge for credit card, check, C.O.D. 30 day moneyback guarantee (Shipping charges non-refundable). Dealer/overseas inquiries welcome.

**In-Calif. 1-800-722-7734** INFO: (213) 695-3777  
**Out-Calif. 1-800-722-7702** TECH: (213) 699-8250  
Monday through Friday,  
7 A.M. to 6 P.M.  
Saturday 9 A.M. to 3 P.M. PST.

A PREFERRED COMPUTER SYSTEM  
**DATAWORLD**®

3733 San Gabriel River Parkway, Pico Rivera, CA 90660-1495



# GET SERIOUS

NEW MENUING  
INTERFACE AND  
RELIABILITY PROCEDURE



## ...ABOUT ANALYZING

**YOUR DATA.** You might be spreading your spreadsheet a little too thin. Or maybe you're starting from scratch. But if you're serious about data analysis, you're ready for SPSS/PC+™ — a full software family that brings you eight high-powered ways to complete any data analysis task.

*Enter it.* SPSS Data Entry II™ is a fully integrated data entry, cleaning and editing tool.

*Analyze it.* The SPSS/PC+ base package provides a powerful array of statistical and reporting procedures.

*Picture it.* SPSS/PC+ Graph-in-the-Box™ featuring New England Software's Graph-in-the-Box™ offers full color "snapshot" graphics.

*Examine it.* SPSS/PC+ Advanced Statistics™ lets you get more serious with your data.

*Predict it.* SPSS/PC+ Trends™—our latest option—is the complete time series analysis/forecasting tool.

*Table it.* SPSS/PC+ Tables™ produces presentation-ready tables instantly.

*Chart it.* SPSS/PC+ Graphics™ featuring Microsoft® Chart creates show-stopping graphs and charts.

*Map it.* SPSS/PC+ Mapping™ featuring MAP-MASTER™ creates maps where vast amounts of data can be summarized and presented in one, simple picture.

SPSS/PC+ products are being put to productive use by serious fact finders in business, government and education. For countless purposes such as market research. Wage and salary studies. Survey analysis. And quality control. Plus each product is superbly documented and supported by SPSS Inc., a leader in statistical software for nearly 20 years. While specially tailored customer support is available through the VALUE PLUS™ plan. And SPSS now offers a SPSS/PC+ version for Novell LANs.

So if you're serious about data analysis, step up to SPSS/PC+. For details, contact our Marketing Department.

**CALL 1/312/329-3315**

**SPSS inc.**

SPSS Inc. • 444 North Michigan Avenue, Suite 3000 • Chicago, Illinois 60611

In Europe: SPSS Europe BV • P.O. Box 115 • 4200 AC Gornchem, The Netherlands • Telephone: + 31183036711 • TWX: 21019

SPSS/PC+ runs on IBM PC/XT/AT's with hard disk. Contact SPSS Inc. for compatible microcomputers. SPSS/PC+, SPSS Data Entry II, SPSS/PC+ Graph-in-the-Box, SPSS/PC+ Advanced Statistics, SPSS/PC+ Trends, SPSS/PC+ Tables, SPSS/PC+ Graphics and SPSS/PC+ Mapping are trademarks of SPSS Inc. VALUE PLUS is a trademark of SPSS Inc. Chart and Microsoft are trademarks of Microsoft Corporation. MAP-MASTER is a trademark of Ashton-Tate. Graph-in-the-Box is a trademark of New England Software, Inc. © 1987, SPSS Inc.

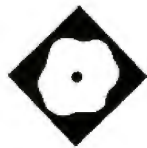

# Ada Comes to the Mac



Does the Mac make a reasonable Ada development system?

Namir Clement Shammass

**T**he Meridian AdaVantage compiler has come to the Apple Macintosh world from the same company that implemented Ada compilers for the IBM PC and the Zilog System 8000 computers. The Mac version reviewed here, which sells for \$1195, is an Ada compiler that works under the Mac Programmer's Workshop (MPW) shell and its C compiler (see "MPW C for the Mac" by Mike Wilson on page 156 of the February BYTE).

This is because the Ada compiler first translates Ada source code into MPW C source code, then invokes the MPW C compiler transparently.

Like its Ada compilers for the PC-DOS and MS-DOS computers and Unix systems, Meridian's Mac 2.2 has been officially validated. Meridian offers additional libraries and other utilities (e.g., a math library package and a debugger) to complement the basic compiler package. (The debugger was not available for this review.)

## Crank It Up

The Meridian AdaVantage compiler is easy to install. I first installed the MPW shell, which is included with the package, and the MPW C compiler (not included) on my hard disk drive. Although this was my first time using the MPW shell, installation was smooth. Next, I installed the Meridian Ada compiler, using the manual's clear instructions. While the manual does discuss installation trouble-

shooting, I didn't have to worry about that section; the compiler ran on the first try. Also, the setup command adds a menu for operating the computer.

The Ada compiler supports integer and floating-point data types. A short integer occupies 2 bytes, while an integer requires 4 bytes of memory. A floating-point type needs 8 bytes, compared to 4 and 2 bytes required by the long and short fixed-point types, respectively. Fixed-point types have a great appeal for programmers working in "no round-off" situations.

The version I reviewed (2.2) does not support the MC68881 12-byte representation of floating-point numbers. The manual mentions that the compiler implements the two fixed-point types using integers with imaginary decimals. Regarding advanced data types, Meridian's compiler supports discriminant records (i.e., they are declared with arguments that allow client routines to define the record's actual size) and arrays. (Discriminant arrays have bounds that are defined as arguments, so the array size is not determined until you actually declare a variable of the array type.)

While AdaVantage supports the complete `text_io` package (i.e., the predefined library unit containing routines for text I/O), Meridian includes three simpler I/O libraries: `l1o`, `f1o`, and `ada_io`. The `l1o` package is an instantiation of `text_io.integer_io` using the following simple Ada statements:

```
with text_io; use text_io;
package l1o is new
  text_io.integer_io(integer);
```

Similarly, the `f1o` package is an instantiation of the `text_io.float_io` for the float-data type. The `ada_io` package is a library that contains simple console I/O routines for characters, strings, integers, and float-type data. While `l1o`, `f1o`, and `ada_io` are not part of the standard

*continued*



## AdaVantage 2.2

### Type

Language compiler  
for the Apple Macintosh

### Company

Meridian Software Systems, Inc.  
23141 Verdugo Dr., Suite 105  
Laguna Hills, CA 92653  
(714) 380-9800

### Format

Two 3½-inch double-sided double-density (800K-byte) floppy disks

### Language

MPW C

### Hardware Needed

Mac with at least 1 megabyte of memory and a hard disk drive with 1.6 megabytes of free space

### Software Needed

Mac Programmer's Workshop C 2.0 or higher, System 4.1, and Finder 5.5 or higher

### Documentation

227-page three-ring manual

### Price

\$1195

### Inquiry 906.

packages, their inclusion offers uniformity among your programs when you inevitably create these libraries.

### Files

AdaVantage can access files either as arrays of bytes (using `direct_io`) or as byte streams (using either `sequential_io` or `text_io`). You can have up to 30 files opened at one time. However, your available memory can place limitations on the actual number of open files.

You use the Mac Hierarchical File System naming convention for referencing both filenames and directories (i.e., folder names). Obviously, this can create compatibility problems when porting Ada source code from one operating system to another; you may need to edit string constants that represent filenames in programs. Under the MPW shell, your programs can use piping and I/O redirection. For example, the MPW command `Ada_lister|sort` pipes the output of a program lister (written in Ada) into a sort application. The MPW shell predefines several special devices, such as the console, a null output device, the standard output stream, the standard input

stream, and the diagnostic output stream.

### Inside

The AdaVantage compiler supports generics implemented as macros. The trade-off is between the speed gain and the increase in size of the instantiated generic code. Meridian recommends that, in order to conserve memory, you not excessively use instantiation of generic code. To use the generic feature, place the generic code body and its specification in the same compilation file.

AdaVantage permits your Ada source code to interface with assembly and C language. Using the pragma (i.e., compiler directive) interface, you specify the language, the name of the foreign language subprogram, and its optional link-name. For example, you may write a routine in MPW C that implements a one-line editor and call it `oneLineEdit`. The code sequence would appear in the general form shown below:

```
/* MPW C */  
void oneLineEdit(s)  
char* s  
{  
    ....  
}  
  
-- AdaVantage  
package editLine is  
    procedure oneLineEdit(s :  
        string);  
    pragma interface(c,  
        oneLineEdit)  
end editLine;  
  
with editLine;  
procedure get_line(s : string)  
is  
begin  
    editLine.oneLineEdit(s);  
end get_line;
```

The reviewed Ada implementation supports a somewhat limited form of tasking. AdaVantage does not use true preemptive time-slicing to perform task switching. Instead, the processor switches from one task to another at activation points, entry calls, completions, and wait states. So you have to be careful when coding long-lived looping routines that do not include processor-switching constructs previously mentioned; such routines can block other tasks from being scheduled. The manual suggests you insert into indefinite loops a delay 0.0, which will reschedule the current task.

The priority pragma assigns the task's priority at compile time. While no

default task priorities are defined by the Ada standard, the AdaVantage compiler assigns the lowest priority as the default value. Each task is assigned its own 2K-byte stack space, a value that you can alter in the source code.

### Invoking Ada

The Meridian Ada compiler is invoked to compile source code files. These can be stand-alone programs, package specification, package body, or separate subunits. Each type of compiled file requires a distinct file extension name separated from the main filename by a dot. Meridian provides a number of versatile compiler switches that determine both major and minor compiling steps. Among these switches is one that simply compiles your Ada source code into MPW C. Using another switch, you can supplement the output C code with the original Ada code inserted as comments.

Other compiler switches suppress the additional checking that is usually required during software development. These include switches for suppressing numeric checking and overall checking. Numeric checking monitors division-by-zero and numeric overflow, while overall checking includes numeric checking as well as checking for violations of array boundaries, string lengths, and so on. Suppressing numeric checking or all types of checking reduces the size of the executable code and increases the program's execution speed.

Another category of compiler switches relates to the support of debugging. The `-fD` switch prepares a compiled file for use with the Meridian AdaVantage Debugger, available as a separate product. The `-g` switch enables you to use the MacsBug machine-level debugger (this option is actually passed on to the MPW C compiler and causes the compiler to insert each procedure's name into the generated object code).

Meridian has integrated an optimizer with its compiler. Using compiler and linker switches, you can optimize for speed or for code size. If you optimize for code size, the compiler trims the unused portion of code imported from libraries from the resultant program. You can gain additional speed if you turn off checking and, in case you are using a Mac II with its standard MC68020 processor, you can instruct the AdaVantage compiler to emit 68020 instructions.

Meridian provides `adaaff`, a special version of the Ada compiler that is more suited for working with error-riddled source code. You can use the `adaaff` com-

*continued*

# How to look good from start...

What if...

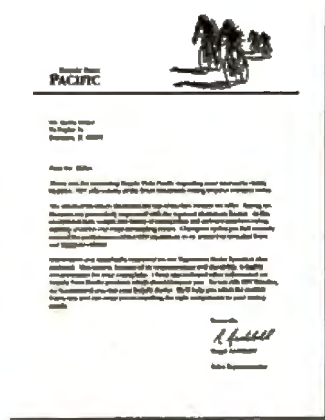

**HP LaserJet Series II Printer**

Nothing brings your ideas to life like the HP LaserJet Series II Printer—from office memos to forms to newsletters. As the leading laser printer, it works with all popular PCs and PC software packages. And, with a wide range of fonts, you get more options to create superior looking documents.

**Multiple Party Profile**

3rd Quarter, 1988

Company	Revenue	Profit	Assets	Liabilities	Equity
ABC Corp.	100	20	50	30	20
DEF Inc.	150	30	75	45	30
GHI Ltd.	200	40	100	60	40
JKL Corp.	250	50	125	75	50
MNO Inc.	300	60	150	90	60
PQR Ltd.	350	70	175	105	70
STU Corp.	400	80	200	120	80
VWX Inc.	450	90	225	135	90
YZA Ltd.	500	100	250	150	100
Subtotal	2000	400	1000	550	450

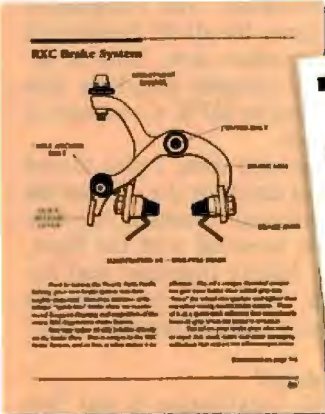
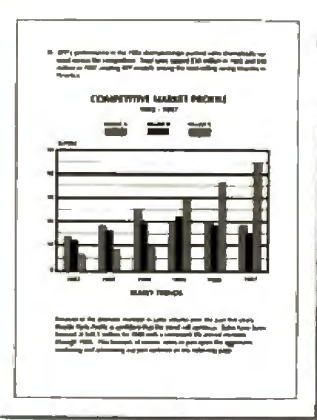

**Mail Order Price Sheet**

COMPANY OFFERS:

Product	Price
Product A	\$10.00
Product B	\$15.00
Product C	\$20.00
Product D	\$25.00
Product E	\$30.00
Product F	\$35.00
Product G	\$40.00
Product H	\$45.00
Product I	\$50.00
Product J	\$55.00
Product K	\$60.00
Product L	\$65.00
Product M	\$70.00
Product N	\$75.00
Product O	\$80.00
Product P	\$85.00
Product Q	\$90.00
Product R	\$95.00
Product S	\$100.00

**PATH**

**CHUCKLE, JAN WILL BEING HOME THE GOLD**

**BRACE SYSTEM HELLS OUT ALL STOPS AT BFF CLASSIC.**

The Golden Ring With The Bell.

With additional memory you can even print sophisticated 300 DPI full-page graphics. And with HP's ScanJet scanner, you can also easily add photographs, illustrations and text.

to finish.

## The HP LaserJet Series II Printer.

Nothing brings your ideas to life like the HP LaserJet Series II Printer—from office memos to forms to newsletters. As the leading laser printer, it works with all popular PCs and PC software packages. And, with a wide range of fonts, you get more options to create superior looking documents.



With additional memory you can even print sophisticated 300 DPI full-page graphics. And with HP's ScanJet scanner, you can also easily add photographs, illustrations and text.

No wonder more people choose the original over all other laser printers combined. So call 1 800 752-0900, Ext. 900D for your nearest HP dealer.



© Hewlett-Packard 1988

Print samples were created using Microsoft Word, Microsoft Excel, and Aldus PageMaker



**Table 1: Benchmark results for optimized and unoptimized runs. (All times are in min:sec.)**

Test	File Size (K bytes)			Compile + link time		Run time	
	Source	Unoptimized	Optimized	Unoptimized	Optimized	Unoptimized	Optimized
Sieve	1	22	21	3:39	3:43	0:34	0:08
Sort	3	26	24	4:13	4:12	2:36	0:18
Float	1	30	28	4:17	4:14	1:08	1:08
Invert Matrix	2	31	29	4:28	4:23	0:39	0:27
Recursion	2	23	21	4:04	4:12	0:44	0:11
Disk Write	1	28	27	3:32	3:30	0:19	0:19
Disk Read	1	27	26	3:26	3:28	0:13	0:13

piler to pipe compilation error messages through the `ff` utility, where the messages are converted to executable editor commands. You can then use these commands to locate and edit the offending source-code lines in the proper file.

The BAMP (Build Ada Main Program) command invokes the MPW linker and creates programs that you can launch from the Mac Finder or the MPW shell. The default action of BAMP is to create an MPW tool, a program that runs only under the MPW shell. You can fine-tune BAMP with options that let you override the default 32K-byte segment size, perform global and local optimization, select an alternate run-time library, and request the output of a link map (i.e., symbol names and where they are).

The intricate relationship between the various libraries and compiled units dictates the use of library database files. These files permit the compiler to maintain the integrity and version consistency of the compiled code. The Meridian package contains a number of utilities that create, maintain, modify, and remove library databases. When a file is compiled, the information related to that file is added to the library database.

The AdaVantage pull-down menu uses the Mac user interface for invoking the AdaVantage compiler, BAMP, other library management commands, and a HyperCard-based on-line help. The user interface provided through the pull-down menu is attractive. The screen contains option buttons, command switches, an internally generated command-line window, and a help window.

The option buttons enable you to select the operational switches, program names, library names, and so forth. Using the mouse, you click at the command switch boxes to turn the commands on or off. If you click the mouse and hold the button down, the help window displays a short description for that switch. As you select options, program files, and

libraries, the command-line window is automatically updated to reflect the current choices. You can execute the command easily by clicking on a special button. The HyperCard help stack contains an on-line reference for components of the compiler and their commands.

#### Stack It Up

I ran the various Ada compilers through a suite of benchmarks. The programs I developed for the compiler test are based on popular operations, such as sorting and matrix inversion. The first three benchmarks I used were the Sieve test; integer-array Sort test, in which an ordered array of 1000 integers is created and reverse sorted using the Shell-Metzner method; and the Floating-Point operations test, which uses the standard BYTE benchmark that performs the four basic operations 5000 times.

I used the Matrix Inversion test to measure the speed of floating-point operations by employing matrix inversion. The program creates a square matrix with 20 rows and 20 columns, and assigns 2's to diagonal elements and 1's elsewhere. The program then inverts the matrix and measures the execution time.

The last three tests I used were the Recursion, the Disk Read, and the Disk Write tests. With the recursion test, I used a recursive version of the popular QuickSort algorithm. This is similar to the nonrecursive Sort test, except that recursion is heavily employed. The Disk Read and Disk Write tests are standard BYTE benchmarks that measure times for reading and writing a file to a newly formatted double-sided double-density 3½-inch floppy disk in the Mac's internal drive.

I ran the benchmarks on an unmodified Mac Plus with a 20-megabyte Data-Frame hard disk; I launched them from the MPW shell. [Editor's note: The source code listing for the benchmark programs is available in a variety of for-

*mats. See page 3 for further details.]*

Table 1 shows the benchmark results. I ran the benchmarks twice: with and without optimization. The compilation and linking times for all the benchmark programs are rather slow. This is because the Ada compiler translates Ada source code first to MPW C and then to executable code.

In the optimized runs, I also turned off all types of checking (i.e., I used the `-q` and `-fs` switches). Dramatic run-time improvements occurred with the Sieve, Integer Sort, Matrix Inversion, and Recursion tests. There was no noticeable change in the run time of the other tests.

#### Any Advantage?

The Meridian AdaVantage is the first commercial Ada compiler for the Mac. While the execution-code speed ranges from good to satisfactory, the compilation and linking cycle is on the slow side. The price tag suggests that AdaVantage is aimed at professional Mac programmers, rather than those who occasionally program in Ada. I find the general price-performance ratio works slightly against the implementation examined, especially when you have to add the cost to purchase MPW C. The stiff competition for the AdaVantage for the Mac comes from validated Ada compilers for the IBM PC, including a fine implementation by Meridian itself that sells for less than \$1000. I believe that serious Ada programmers should go with the IBM PC implementations and obtain a better buy for the dollar. However, the company says it will release a new version for the Mac early in 1989 that will produce native code without MPW C. That could tip the scales in favor of the Mac version. ■

*Namir Clement Shamas is a columnist for several computer magazines and a freelance writer living in Glen Allen, Virginia. He can be reached on BIX as "nshamas."*

# Small cash input for laser-quality output.



Dear Reader:

This letter was printed on one of the finest printers available today.

The HP DeskJet Printer.

It prints text and graphics more crisp and clear than 24-pin printers. And as you can see from the chart, it's a lot quieter than 24-pin printers, too.

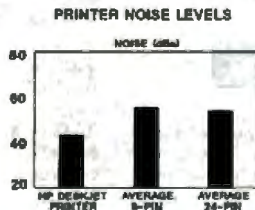

It's also easy to use. It does your important office tasks, but it's small enough to fit on your desk. Everything considered, it's the perfect personal printer.

And one of the most amazing features of all is its price. It's under \$1,000.

Call us for the name of your local HP Dealer at 1 800 752-0900 Ext. 9088. Then go see for yourself why we call it laser-quality printing.

Sincerely,

Richard Snyder

## The HP DeskJet Printer. Laser-Quality Output for Under \$1000.



we never stop asking "What if..."



# Mainframe Power for your PC!

If you need or are accustomed to the throughput of a 32-bit mini, including any of DEC's VAX series, MicroWay has great news for you. The combination of our NDP compilers and our mW1167 numeric coprocessor gives your 386 PC, VAX speed! If you don't own a 386 PC, we provide a number of economical PC and AT upgrade paths.

Many of our NDP Fortran-386 users are reporting turn around times that are two to six times faster than their VAX. The exact times are a function of the VAX processor being used, the speed of the 386, the number of users being served by the VAX, and the coprocessor being used with the 386. There are currently over 400 developers using our NDP tools to port 32-bit applications. To help the 386/1167 engineering standard emerge, MicroWay is co-marketing several mainframe applications that have been ported by our customers. In addition, this ad-

*Dr. Robert Atwell, a leading defense scientist, calculates that NDP Fortran-386 is currently saving him \$12,000 per month in rentals of VAX hardware and software while doubling his productivity!*

*Fred Ziegler of AspenTech in Cambridge, Mass. reports "I ported 900,000 lines of Fortran source in two weeks without a single problem!" AspenTech's Chemical Modeling System is in use on mainframes worldwide and is probably the largest application to ever run on an Intel processor.*

*Dr. Jerry Ginsberg of Georgia Tech reports "My problems run a factor of six faster using NDP Fortran-386 on an mW1167 equipped 386/20 than they do on my MicroVAX II."*

roduces the first of many utilities that will ease the porting of your favorite in-house programs. These include tools like NDP-Plot, which provides CalComp compatible screen and printer graphics, and NDP Windows.

MicroWay has mW1167 boards in stock that run on the Compaq 386/20, IBM PS2/80, Tandy 4000, AT&T 6386, Acer 386/20, Everex Step 386/16(20), H.P. Vectra RS/16(20) and others. We now have a new board for the Compaq 386/20 which combines an 1167 with VGA support that is register compatible with IBM — the "SlotSaver". It features an extended 800x600 high res mode that is ideal for 386 workstations.

Finally, we still offer the 16-bit software and hardware which made us famous. If you own a PC or AT and are looking for the best 8087/80287 support on the market, call (508) 746-7341 and we'll send you our full catalog.

## 32-Bit Compilers and Tools

NDP Fortran-386™ and NDP C-386™ Compilers generate globally optimized mainframe quality code and run in 386 protected mode under PharLap extended MS-DOS, UNIX, or XENIX. The memory model employed uses 2 segments, each of which can be up to 4 gigabytes in length. They generate code for the 80287, 80387, or mW1167. Both compilers include high speed EGA graphics extensions written in C that perform BASIC-like screen operations..... \$595 each

- NDP Fortran-386™ Full implementation of FORTRAN-77 with Berkeley 4.2, VAX/VMS and Fortran-66 extensions.
- NDP C-386™ Full implementation of AT&T's PCC with Microsoft and ANSI extensions.

### NDP Package Pricing:

387FastPAK-16: NDP Compiler, PharLap, and 80387-16 Coprocessor ..... \$1299

1167FastPAK-16: NDP Compiler, PharLap, and mW1167-16 Coprocessor ..... \$1695

NDP Windows™ — NDP Windows includes 80 functions that let you create, store, and recall menus and windows. It works with NDP C-386 and drives all the popular graphics adapters. Library ..... \$125, C Source ..... \$250

NDP Plot™ — Calcomp compatible plot package that is callable from NDP Fortran. It includes drivers for the most popular plotters and printers and works with CGA, Hercules, EGA and VGA ..... \$325

NDP/FFT™ — Includes 40 fast running, hand coded algorithms for single and double dimensioned FFTs which take advantage of the 32-bit addressing of the 386 or your hard disk. Callable from NDP Fortran or NDP C with 1167 and 387 support ..... \$250  
387FFT for 16-bit compilers ..... \$250

387BASIC™ — A 16-bit Microsoft compatible Basic Compiler that generates the smallest .EXE files and the fastest running numeric code on the market. .... \$249

## MicroWay® 80386 Support

### Parallel Processing

#### Monoputer™

The world's most popular Transputer development product runs all MicroWay Transputer software using either a T414 or T800. The T800 processor has built-in numerics and provides performance comparable to an 80386 running at 20 MHz with an mW1167. The new 3L Parallel C and Fortran Compilers makes this an especially attractive porting environment. Can be upgraded to 2 megabytes.

Monoputer with T414 (0 MB) ..... \$995  
Monoputer with T800 (0 MB) ..... \$1495

#### Quadputer™

This board for the XT, AT, or 386 can be purchased with 2, 3 or 4 Transputers and 1, 4 or 8 megabytes of memory per Transputer. Two or more Quadputers can be linked together to build networks with mainframe power which use up to 36 Transputers. One customer's real-time financial application has gone from 8 hours on a mainframe to 16 minutes on a system containing five Quadputers. .... from \$3495

#### Transputer Compilers and Applications

MicroWay and 3L offer Parallel languages for the Monoputer and Quadputer.

MicroWay Parallel C ..... \$595  
MicroWay Occam2 ..... \$495  
3L Parallel C ..... \$895  
3L Parallel Fortran ..... \$895  
µField — A specialty finite element analysis package targeted at Transputer networks. Ideally suited to take advantage of the 6 Megaflop speed of the Quadputer. .... \$1600

**Call (508) 746-7341 for our  
free catalog!**

## Numeric Coprocessors

mW1167™ — Built at MicroWay using Weitek components and an 80387 socket.

mW1167-16 ..... \$995  
mW1167-20 ..... \$1595  
mW1167/VGA-20 "SlotSaver" ..... \$1995  
8087 ..... \$99  
8087-2 ..... \$154  
80287-8 ..... \$239  
80287-10 ..... \$295  
80387-16 ..... \$450  
80387-20 ..... \$675  
287Turbo-12 (for AT compatibles) .... \$450  
DRAM ..... CALL  
(All of our Intel coprocessors include 87Test.)

## PC and AT Accelerators

MicroWay builds a number of 8086 and 80286-based PC accelerators that are backed up by the best customer support in the industry.

Number Smasher™ (8087 & 512K) .. \$499  
FastCACHE-286/9 MHz ..... \$299  
FastCACHE-286/12 MHz ..... \$399  
SuperCACHE-286/12 MHz ..... \$499  
Intel Inboard™ PC (1 MB) ..... \$950

## Intelligent Serial Controllers

MicroWay's AT4™, AT8™, and AT16™ are the fastest 80186-based intelligent serial controllers on the market. They come with drivers for UNIX, XENIX, and PC MOS.

AT4 ... \$795 AT8 ... \$995 AT16 ... \$1295

## 32-Bit Applications

COSMOS-M/386 — SRAC's finite element package for the 80386 with an 80387 or mW1167 provides mainframe speed and capacity. Turn around times rival the VAX 8650 and are 6 to 15 times that of an AT: from \$995

PSTAT-386 — This mainframe statistics package has been used by government and industry for 20 years. The full version was ported. Requires 4 to 6 megabytes of memory: \$1495

NDP/NAG™ — Features a library of 800 engineering and scientific numerical algorithms. Callable from NDP Fortran ..... \$895

**Micro  
Way**

**The World Leader in PC Numerics**

P.O. Box 79, Kingston, MA 02364 USA (508) 746-7341  
32 High St., Kingston-Upon-Thames, U.K. 01-541-5466  
St. Leonards, NSW, Australia 02-439-8400

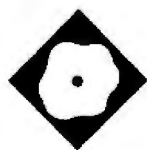

# Software for Hardware-Style Debugging

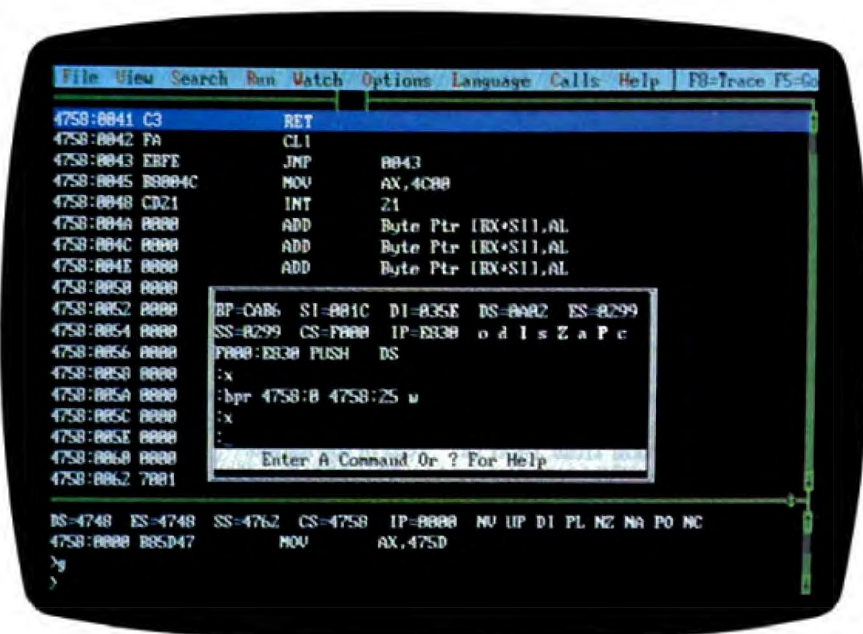

Soft-ICE runs  
CodeView and 8086-  
based programs  
on 80386 systems

Namir Clement Shammass

Programs that improperly access code or data haunt their creators. OS/2 promises relief, but MS-DOS programmers continue to suffer. There is an intermediate solution: Soft-ICE, from Nu-Mega Technologies, a debugger that adds break-on-memory-access and break-on-interrupt features to existing debuggers, such as DEBUG, SYMDEB, and CodeView. Soft-ICE can provide these capabilities—normally associated with hardware-based debuggers—only if your debugger and target program restrict themselves to the 8086 (i.e., the real address mode) instruction set, and if you run Soft-ICE, your debugger, and your target program on an 80386 machine. Given this configuration, Soft-ICE runs your 8086-based program and debugger on a virtual DOS machine that it creates on the 80386.

You can instruct Soft-ICE to watch for events that your debugger can't see, like a hardware interrupt or a write to a region within your program's code segment.

When it traps such an event, it deposits a breakpoint instruction (INT3 for DEBUG or SYMDEB, NMI for CodeView) in the code, thereby activating your debugger so you can use it to investigate. Soft-ICE can also go where other debuggers can't: into device-driver code that loads when DOS boots. Here Soft-ICE works as a stand-alone debugger.

Most 80386-based microcomputers work with Soft-ICE, including the IBM PS/2 Model 80, 80386 AT compatibles, and AT-style machines with 80386 coprocessors. The program is compatible with monochrome, CGA, EGA, VGA, and Hercules graphics adapters. I tested it on an IBM PC AT equipped with an 80386 card, and I used it along with DEBUG, CodeView, and T-DebugPlus 4.0, the Turbo Pascal debugger from TurboPower Software.

Nu-Mega recommends that you use Soft-ICE in conjunction with extended memory. In the absence of extended memory, the program loads as high as possible within 640K bytes, then adjusts the high-memory mark so as to hide itself from DOS programs. Because the program alters the amount of memory DOS can see, you should load it before you load any terminate-and-stay-resident (TSR) program. When extended memory is present, Soft-ICE loads at the top of it, so you must arrange to name its extended-memory driver in CONFIG.SYS before you name any other installable device drivers. One minor annoyance is that you can't load programs, drivers, or utilities (other than Soft-ICE itself) that use 80286 or 80386 protected-mode instructions, since the program supports only real-address-mode software. I had to create a special boot disk to avoid loading device drivers that use 80386 protected modes.

Soft-ICE loads from the DOS command line and takes arguments to override its defaults. For example, you can replace its default hot key, Ctrl-D,

*continued*



## Soft-ICE

**Type**  
Debugger

**Company**  
Nu-Mega Technologies  
P.O. Box 7607  
Nashua, NH 03060  
(603) 888-2386

**Format**  
One 5¼-inch double-sided,  
double-density floppy disk; 3½-inch  
floppy disk available on request

**Language**  
Assembly

**Hardware Needed**  
80386 PS/2 and compatibles; 80386 AT  
compatibles; 80386SX; monochrome,  
CGA, EGA, VGA, or Hercules graphics  
adapters; extended memory  
recommended

**Software Needed**  
MS-DOS/PC-DOS 2.0 or higher

**Documentation**  
130-page reference manual,  
reference card

**Price**  
\$386

**Inquiry 907.**

with Alt-D or SysReq. You can also unload Soft-ICE from the DOS command line.

The program presents itself in a pop-up window that you can move or resize. Screen controls include FLASH, a command that restores the target program's output while Soft-ICE traces or steps its execution, and RS (restore program screen), which displays your program's output until you press a key. If you have a second monitor attached to your system, you can use Alt-SCR to redirect Soft-ICE's output to it.

The window contains a command line; the colon serves as a prompt. A command-line editor provides the usual services (e.g., move cursor left and right, move to the beginning and end of a line, and delete a character), and it can recall command lines. As you type the names of Soft-ICE commands, an EMACS-style completion facility displays choices that match what you've typed. You can use the HELP command to see all the commands, along with short descriptions.

## Dueling Debuggers

When you use Soft-ICE with another debugger, first you should set up the protocol that it uses to communicate with your debugger. The ACTION command specifies where control goes when a Soft-ICE breakpoint triggers. ACTION's default is HERE, which means that control passes to Soft-ICE itself; you use this configuration when Soft-ICE operates as a stand-alone. If you haven't overridden this default, you issue the command ACTION INT3 (DEBUG or SYMDEB) or ACTION NMI (CodeView) to arrange for one of these debuggers to take control.

DEBUG and CodeView both worked well with Soft-ICE. I found Soft-ICE's window-oriented interface more convenient than DEBUG's; while debugging a screen-oriented program, I was able to view its output and separately monitor its progress in the Soft-ICE window. Since Soft-ICE provides all the DEBUG commands (and then some), there's only one reason not to bypass DEBUG entirely—you need to use it to load your target program. Nu-Mega says it plans to endow a future version of Soft-ICE with the ability to load a target program directly.

For CodeView users, Soft-ICE offers two major benefits: enhanced breakpoint capability and protection from DOS or ROM BIOS reentrancy. With ACTION set to NMI, I was able to specify a memory-range breakpoint in Soft-ICE and gain control in CodeView when it triggered. For debugging in situations where you have access to source code, you'll probably prefer CodeView, with its ability to work with source code and symbolic information, to Soft-ICE. But the combination of the two debuggers lets you specify more powerful breakpoints than you can with CodeView alone.

The reentrancy issue requires some explanation. Soft-ICE doesn't use DOS or ROM BIOS, but other debuggers (notably CodeView) do. If you're using Soft-ICE to break on interrupts serviced by DOS or ROM BIOS code and then want to transfer control to your debugger, there may be a conflict: DOS and ROM BIOS routines aren't fully reentrant. Soft-ICE therefore provides a Warn facility; when enabled, it returns control to Soft-ICE first. You can then choose to let your debugger take control, but Nu-Mega recommends that, in this situation, you should use Soft-ICE unless you know that your debugger uses no DOS or ROM BIOS calls. With Warn enabled, I used CodeView to step through a program that contained BIOS calls; control did revert to Soft-ICE when the program entered BIOS code.

Neither ACTION INT3 nor ACTION NMI will work with T-DebugPlus 4.0, because this debugger uses a different trapping mechanism. You can, however, place an INT3 in Pascal source (i.e., Intr(3, Registers);), use Soft-ICE's I3HERE command to capture control, then debug a Turbo Pascal program with Soft-ICE alone. When the INT3 instruction triggers a break, the Soft-ICE window pops up and displays the CPU registers and the next executable machine instruction.

## Breakpoints

Soft-ICE provides a rich set of breakpoint functions. The BPM (breakpoint-on-memory) command tags a byte-, word-, or double-word-size region of memory beginning at an address you specify. One type of modifier specifies the mode of access that triggers the breakpoint: R (read), W (write), RW (read/write), or X (execute). Another type of modifier, applicable only to read and write breakpoints, makes the breakpoint contingent on the value residing in the specified region: EQ (break when equal) and NE (break when not equal). A third type of modifier, C (count), renders the breakpoint dormant until the Cth access of the region.

The BPR (breakpoint-on-range) command works like BPM but lets you specify an arbitrarily large region of memory. BPR's access-mode qualifiers are restricted to R, W, and RW; you can still break on execution by using R, but you can't differentiate between read and execute modes. BPIO (breakpoint-on-I/O) works with I/O ports. CSIP makes all existing breakpoints contingent on the instruction pointer, which you specify to be within or, with the NOT modifier, outside a range.

Finally, BPINT (breakpoint-on-interrupt) tags hardware or software interrupts. To use it, you need to specify the interrupt's number in hexadecimal format. The modifiers AL, AH, and AX enable you to further qualify the breakpoint. For example, the command BPINT 21 AH=4C selects the terminate-program function from among the many services that interrupt 21h provides.

You can enable and disable breakpoints, and you can edit the description of a breakpoint and use it as a template for the description of a new breakpoint. Soft-ICE supports 16 concurrent breakpoints. Of these, 4 can be of type BPM, and 10 can be of any other type. You can use BPAND (breakpoint-AND) to construct a complex breakpoint that triggers

*continued*



Embedded systems designers have already used CrossCode C in over 172 different applications.

# Introducing CrossCode C for the 68000 Microprocessor Family

## Finally, a 68000 C Compiler that's tailor-made for ROMable applications

**C**rossCode C is designed *specifically* to help you write ROMable code for all members of the Motorola 68000 family.

### A ROMable C Compiler?

To get truly ROMable code, you have to start with a truly ROMable compiler. Here are three CrossCode C features that you won't find in any ordinary C compiler:

- Compiler output code is split into five independent memory sections that you can assign into ROM or RAM as you please.
- You can optimize the code for your application because *you* control the sizes of data types. For example, you can optimize for speed by using two byte *ints*, or get maximum versatility by using four byte *ints*.
- You can easily write assembly language routines that call C functions and vice-versa, because the compiler uses simple, well documented parameter passing conventions.

### How About Low Level Control?

CrossCode C comes with an assembler that has all the features that assembly language programmers require. In fact, you could write

your whole application with it:

- The assembler features an advanced macro language, conditional assembly, "include" files, and an unlimited size symbol table.
- Detailed cross references show you where you've defined and referenced your symbols.
- After a link, you can actually convert your "relocatable" assembler listings into "absolute" listings that contain absolute addresses and fully linked object code.

### Can It Handle The Link?

The CrossCode C linker is designed to handle truly huge loads. There are no limits on the number of symbols in your load or on the size of your output file. And you can always count on full 32 bit target addressability, because the linker operates comfortably in the highest ranges of the 68020's address space.

### How Does It Get To ROM?

CrossCode C comes with a *downloader* that puts you in touch with all EPROM programmers and emulators. It can convert your load into Motorola S-Records, Intel Hex, Tek Hex, Extended Tek Hex, and Data I/O ASCII Hex. You can also produce a binary

image and convert that image into any format you might want. In all formats, bytes can be split into EPROMs for an 8, 16, or 32 bit data bus.

### Why Wait?

Once you start using CrossCode C, you may just wonder how you ever got the job done before! It's available under MS-DOS for just \$1595, and it runs on all IBM PCs and compatibles (640K memory and hard disk are required). Also available under UNIX & XENIX.

CALL TODAY for more information:

**1-800-448-7733**

Inside Illinois or outside the United States, please dial

PHONE: 1-312-971-8170

FAX: 1-312-971-8513

SOFTWARE DEVELOPMENT SYSTEMS, INC.  
3110 WOODCREEK DRIVE  
DOWNERS GROVE, ILLINOIS 60515 USA

CrossCode™ is a trademark of SOFTWARE DEVELOPMENT SYSTEMS, INC. MS-DOS® is a registered trademark of Microsoft. UNIX® is a registered trademark of AT&T. XENIX® is a registered trademark of Microsoft.



# HOW DO YOU GET A JOB WITHOUT EXPERIENCE? AND HOW DO YOU GET EXPERIENCE WITHOUT A JOB?

Most young people have one answer to this problem. They avoid it until they're out of college. But they could be getting solid work experience while they're still in college. With your company's help. And ours.

We're Co-op Education. A nationwide program that helps college students get real jobs for real pay, while they're getting an education.

But we can't do it without you. Those real jobs have to come from real companies. Like yours.

For more information on how you can participate in this valuable program, write Co-op Education, Box 775E, Boston, MA 02115.

Not only will you be giving students a chance to earn money and pick up the most valuable kind of knowledge, you'll be giving yourselves a chance to pick up the most valuable kind of employee.

## Co-op Education.

You earn a future when you earn a degree.



A Public Service of This Publication ©1987 National Commission for Cooperative Education

only when the conditions of all its component breakpoints are satisfied.

The BREAK facility provides a breakpoint of last resort. When it's enabled (at a slight cost to performance), you can always activate Soft-ICE by means of its hot key, even when the virtualized DOS system's interrupts are disabled and, from the DOS perspective, the system is completely hung.

### Stand-Alone Debugging

Soft-ICE's toolkit is well stocked. Of course, when you use Soft-ICE with another debugger, you don't need these tools. Soft-ICE helps you catch events that you couldn't otherwise have caught, then transfers you to your own debugger. But for projects outside the scope of standard debuggers, like debugging loadable device drivers or DOS or ROM BIOS code, Soft-ICE has everything you need. The standard debugger commands—to display and change registers, display and edit memory, unassemble instructions, read from or write to I/O ports, trace, step, and go—resemble their counterparts in DEBUG or CodeView.

Commands unique to Soft-ICE—notably MAP and BOOT—support the tasks for which you deploy Soft-ICE as a stand-alone. MAP displays a memory map of the system, noting the names, locations, and sizes of device drivers, RAM-resident programs, DOS, the debugged program, and any other programs already loaded into memory. BOOT uses interrupt 19h of the ROM BIOS; this restarts DOS but retains Soft-ICE. To debug an installable device driver, you use MAP to locate the driver, then dump its header and decode its entry point, set an execution breakpoint on the entry point, and use BOOT to restart DOS. The breakpoint triggers, and you can use Soft-ICE to debug the driver.

Developers of 8086-based software who use or have access to 80386 machines should find this product very attractive. It implements a debugging environment otherwise available only with hardware-based debuggers that cost at least three times as much. Soft-ICE alone is a powerful tool for debugging device drivers and interrupt service routines. It merges smoothly with other debuggers, such as DEBUG and CodeView, and can extend their breakpoint capabilities as well as protect against reentrancy. ■

*Namir Clement Shammas is a columnist for several computer magazines and a freelance writer living in Glen Allen, Virginia. He can be reached on BIX as "nshammas."*

# Get your work done before 1991.

The future of personal computing is clear. More powerful PCs. Easier to use PCs. With graphics and character-based programs working side by side. Talking to each other. Multitasking, Windowing, Menuing, Mousing. Getting your work done easier and faster.

## Have it all now.

DESQview™ is the operating environment that gives DOS the capabilities of OS/2™. And it lets you, with your trusty 8088, 8086, 80286, or 80386 PC, leap to the productivity of the next generation. For not much money. And without throwing out your favorite software.

Add DESQview to your PC and it quickly finds your programs and lists them on menus. So you can just point to the program, using keyboard or mouse, to start it up. DESQview knows where that program lives. And what command loads it.

For those who have trouble remembering DOS commands, it adds menus to DOS. It even lets you sort your files and mark specific files to be copied, backed-up, or deleted—all without having to leave the program you're in.

Best of all, DESQview accomplishes all this with a substantial speed advantage over any alternative environment.

## Multitask beyond 640K.

When you want to use several programs together, you don't have to leave your current program. Just open the next program. View your programs in windows or

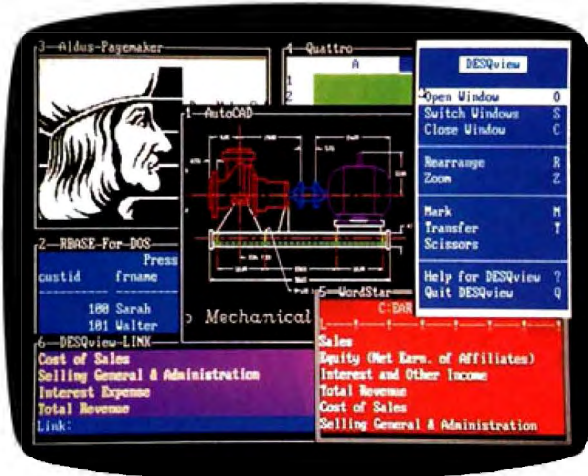

For programmers, DESQview's API, with its strengths in inter-task communications and multitasking, brings a quick and easy way to adapt to the future. With the API's mailboxes and shared programs, programmers are able to design programs running on DOS with capabilities like those of OS/2.

full screen. Open more programs than you have memory for. And multitask them. In 640K. Or if you own a special EMS 4.0 or EEMS memory board, or a 386 PC, DESQview lets you break through the DOS 640K barrier for multitasking. If you have other non-EMS memory expansion products like AST's Advantage or the IBM® Memory Expansion Option, we have a

solution for you, too. The ALL CHARGE-CARD™ 'unifies' all your memory to provide up to 16 megabytes of continuous workspace. DESQview lets you use this memory to enhance your productivity. You can start 1-2-3 calculating and tell Paradox to print mailing

labels while you're writing a report in Word Perfect, or laying out a newsletter in Ventura Publisher, or designing a building in AutoCAD.

DESQview even lets you transfer text, numbers, and fields of information between programs.

## Fulfill the 386 promise.

For 80836 PC users, DESQview becomes a 386 control program when used in conjunction with Quarterdeck's Expanded Memory Manager (QEMM)-386—giving faster multitasking as well as virtual windowing support.

And when you use DESQview on an IBM PS/2™ Model 50 or 60 with QEMM-50/60 and the IBM Memory Expansion Option, DESQview gives you multitasking beyond 640K.

Experts are voting for DESQview. And over a million users, too.

If all of this sounds like promises you've been hearing for future systems, then you can understand why over a million users have chosen DESQview. And why PC Magazine gave DESQview its Editor's Choice Award for "The Best Alternative to OS/2," why readers of InfoWorld twice voted DESQview "Product of the Year" why, by popular vote at



Comdex Fall for two years in a row, DESQview was voted "Best PC Environment" in PC Tech Journal's Systems Builder Contest.

DESQview lets you have it all now.

**DESQVIEW SYSTEM REQUIREMENTS:**  
IBM Personal Computer and 100% compatibles (with 8086, 8088, 80286, or 80386 processors) with monochrome or color display. IBM Personal System/2\* Memory: 640K recommended, for DESQview start 0-145K\* Expanded Memory (Optional): expanded memory boards compatible with the Intel AboveBoard, enhanced expanded memory boards compatible with the AST RAMpage; EMS 4.0 expanded memory boards\* Disk: two diskette drives or one diskette drive and a hard disk\*Graphics Card (Optional): Hercules, IBM Color/Graphics (CGA) IBM Enhanced Graphics (EGA), IBM Personal System/2 Advanced Graphics (VGA)\* Mouse (Optional): Mouse Systems, Microsoft and compatibles\* Modem for Auto-Dealer (Optional): Hayes or compatible\* Operating System: PC-DOS 2.0-3.3; MS-DOS 2.0-3.2\* Software: Most PC-DOS and MS-DOS application programs; programs specific to Microsoft Windows 1.03-2.03, GEM 1.1-3.0, IBM TopView 1.1\* Media: DESQview 2.0 is available on either 5-1/4" or 3-1/2" floppy diskette

**YES!**  
I need increased productivity now!

Name \_\_\_\_\_  
Address \_\_\_\_\_  
City \_\_\_\_\_ State \_\_\_\_\_ Zip \_\_\_\_\_  
Payment Method  Visa  MasterCard Expiration \_\_\_\_/\_\_\_\_  
Account # \_\_\_\_\_

Qty	Product	Format	Price Each	Totals
	DESQview 2.0	<input type="checkbox"/> 5-1/4 <input type="checkbox"/> 3-1/2	\$129.95	
	QEMM-386	<input type="checkbox"/> 5-1/4 <input type="checkbox"/> 3-1/2	\$59.95	
	QEMM-50/60	<input type="checkbox"/> 5-1/4 <input type="checkbox"/> 3-1/2	\$59.95	
	ALL CHARGE CARD (Special for DESQview owners)			\$200.00*

Shipping & Handling \$5 in USA / \$10 outside USA  
Calif Residents add 6.5%

Grand Total \_\_\_\_\_

**Quarterdeck**

150 Pico Boulevard, Santa Monica, CA 90405  
(213) 392-9851

\*This ALL CHARGE CARD is designed for the IBM PC AT and PS/2 50 and 60. If you have another type of 80286-based PC, there's a version for you, too. Please call 1-800-387-2744 for special ordering information. Offer expires August 31, 1988. Trademarks are property of their respective holders: IBM, OS/2, PS/2, 1-2-3, Paradox, Word Perfect, Ventura Publisher, AutoCAD, Intel, Above Board, AST, RAMpage, Advantage, Hercules, Mouse Systems, Hayes, Microsoft, Windows, TopView.



# FLEXSCAN™ 9070S, PC Hi-Res That Looks Like a Million.

The FLEXSCAN 9070 Multiple Scan monitor is of course compatible with other multi-scans, but includes improvements that will give you the professional edge which is the mark of a good investment. You can extend your multi-scan range from 20kHz to 50kHz in practical terms. This means that, at the 48-50 kHz range, you can make use of PC CAD/CAE capabilities at a resolution of up to 1024 dots × 768 lines. The FLEXSCAN 9070 takes advantage of non-interlace high resolution signal as high as 1024 × 768 to provide you with a flicker free display at much brightness. You can also use the 9070 with IBM PS/2 or VGA compatible boards at a high resolution mode like 800×600 and 1024 × 768 (non-interlace).

The FLEXSCAN 9070 provides a 16-inch screen, large enough for CAD/CAE and 3-D projections, yet small enough to fit comfortably into your home work space.



1024 dots × 768 lines Graphics (Non-interlace)  
AutoCAD

Also, for your convenience, all controls and switches, including the alternate video input, are located within easy reach on the front panel. The FLEXSCAN 9070 is compatible with a wide range of IBM, Apple, and other products, allow you to use all of today's popular programs---at a resolution that looks like a million.

## FLEXSCAN™ MODEL 9070S

- IBM VGA(PS/2), 8514/A, PGC, EGA compatible and CAD/CAE use.
- Apple Mac. II and SuperMac Spectrum compatible
- Max. 1280 dots × 800 lines high resolution
- 1024 dots × 768 lines display on Non-Interlace signal delivers flicker-free high-res graphics
- 20kHz to 50kHz horizontal scan automatic adjustment. 50Hz to 80Hz vertical scan automatic adjustment
- 16 inch, 0.31mm dot pitch and newly developed XF(Extended Field) Gun to obtain both brightness and sharp focus.
- Front mounted controls including the input signal select switch between 2 video input.
- Selecting white or Amber displays colored application in shades of gray or amber
- Tilt-Swivel stand standard

# NANAO<sup>®</sup>

**NANAO USA CORPORATION**

23510 TELLO AVE., SUITE 5 TORRANCE, CA 90505  
PHONE (213) 325-5202 FAX (213) 530-1679

Specifications are subject to change without notice.

APPLE, Macintosh II are registered trademarks of Apple Computers Inc. ARTIST, ARTIST 1 Plus, ARTIST 10, ARTIST 10-16 are trademarks of Central Systems Inc. IBM, PC, XT, AT and PS/2 are registered trademarks of International Business Machines Corporation. SuperMac is a trademark of SuperMac Technology. SuperVGA II Plus, SuperVGA and SuperVGA II Plus are trademarks of Genie Systems Corporation. Oracle Designer, VGA Oracle Designer, VGA 2, TurboVGA and TurboVGA are trademarks of Oracle Technology. Paradise VGA Professional Card, Paradise VGA Plus Card and AutoCAD IGA are trademarks of Paradise Systems, Inc. Paradise Systems is a registered trademark of Paradise Systems, Inc. VGA Deluxe and VGA VGA are trademarks of Video Design Inc. Macintosh is a registered trademark of Apple Computer Corporation. AutoCAD is a registered trademark of Autodesk Inc. GFA is a registered trademark of Digital Research Inc. Lotus and 1-2-3 are registered trademarks of Lotus Development Corporation. SigmaVGA and SigmaEGA are trademarks of Sigma Design, Inc. FLEXSCAN is a trademark of NANAO CORPORATION. NANAO is a registered trademark of NANAO CORPORATION.

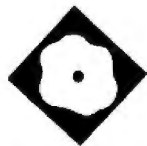

# Total Word

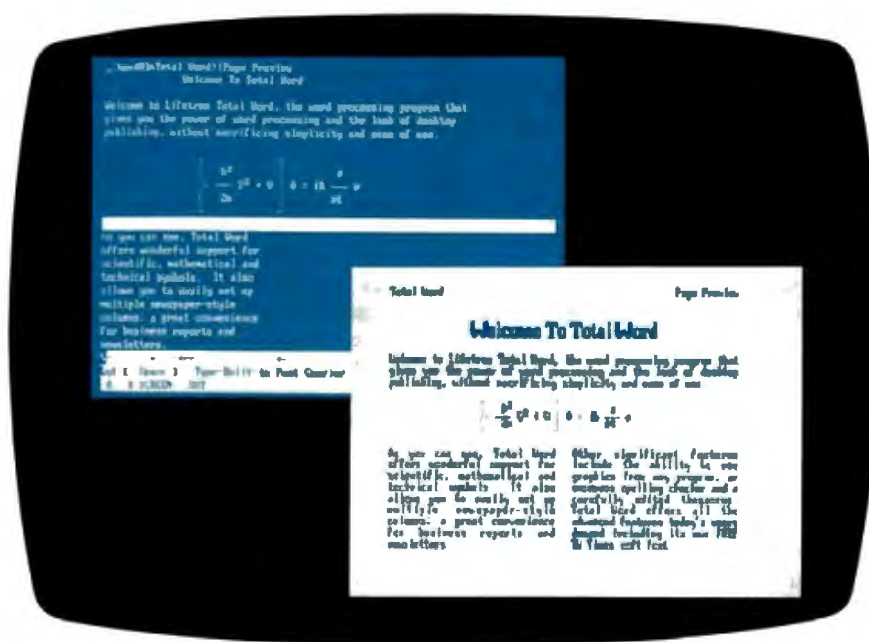

Does it offer the total solution for word-processing and desktop publishing?

Lamont Wood

If you're a closet typographer or graphics designer, you want an infinite number of desktop publishing features. But if you're like most people, you just want your printouts to look good—without having to learn the difference between a point and a pica, and without having to take a sabbatical to get your font files, software, and printer configured the way you want.

Total Word 1.012 (\$495) from Life-tree Software—the company behind the Volkswriter dynasty of MS-DOS word processors—is for that latter group. It works on the IBM PC and compatibles with 480K bytes of RAM and a CGA, EGA, VGA, or Hercules graphics adapter. The program also requires a hard disk drive, where it occupies about 2.7 megabytes of space (including LaserJet fonts).

Total Word offers you enough functionality to produce handsome documents with all the trademarks of desktop publishing, but it still manages to keep things simple. It includes differing typefaces and sizes with or without proportional spacing, boxes, columns, graphics, and special characters for engineering and scientific formulas, and it takes a stab at WYSIWYG (what you see is what you get). Basically, it's a word processor with limited desktop publishing features for those who are more interested in content than appearance but who still want presentable printouts in a world

where typewriter emulation is no longer good enough.

The program achieves its simplicity by, essentially, limiting and prescribing what you can do in terms of graphics layout. But its limitations probably still exceed the ambitions of many users.

Indeed, Total Word is still a word processor. As you type, your text appears on an alphanumeric screen with fixed spacing. It gives you full editing features, plus a dictionary and a thesaurus. In fact, it has all the features you'd expect from a word processor.

Beyond that, things get interesting. You can capture and include graphics images in your word-processing files; you can type math, engineering, and chemical equations straight from the keyboard; and you can change fonts easily.

## Almost Desktop Publishing

Call up Total Word and start typing, and there is little to differentiate it from the scores of other MS-DOS word processors—except for the intriguing label in the status line at the bottom of the screen: "Type: Built-in Font Courier 10 Pitch Medium 12 pt Roman." This refers to the default font in a Hewlett-Packard LaserJet Plus (I tested it with a Quadram QuadLaser emulating a LaserJet Plus).

As you might expect from a program that carefully labels the font it's using, it also knows other fonts. Pressing Alt-Y brings up the Typestyle menu with a list of other possible fonts (for the LaserJet): standard, bold, italic, small headline, large headline, and small text. These turn out to be rather disingenuous labels for softfonts (i.e., downloadable typefaces for a laser printer) included with Total Word; they are, respectively, Times Roman 12-point medium, bold, and italic; 10-point medium; 16-point medium bold; and 24-point medium bold. (A point is  $\frac{1}{72}$  inch.)

Switching to one of these typefaces

*continued*



Total Word 1.012

**Type**

Word processor with desktop publishing features

**Company**

Lifetree Software, Inc.  
411 Pacific St.  
Monterey, CA 93940  
(408) 373-4718  
(800) 543-3873

**Format**

Nine 5¼-inch floppy disks or five 3½-inch floppy disks

**Language**

Pascal, C, and assembly

**Hardware Needed**

IBM PC or compatible with 480K bytes of RAM, a hard disk drive, and CGA, EGA, VGA, or Hercules graphics adapter

**Software Needed**

DOS 2.1 or higher

**Documentation**

480-page Total Word Manual  
48-page Printer Technical Information  
16-page Total Word Quick Reference

**Price**

\$495

**Inquiry 897.**

produces no immediate change on the screen—except that the right margin shifts and there's a new label for the type name. However, once you start typing, it's a new experience. The format line on the bottom of the screen, which has a marker showing the position of the cursor, no longer seems to match the actual cursor position.

Unlike many word processors that offer some sort of proportional spacing, Total Word has a preview-page mode that toggles the screen to graphics mode (if available) and shows the page as it will look when printed.

The preview screen has two modes: full page and half page. In full-page mode, you can see the image of a full page, but the text is illegible except for the headlines. The half-page mode has a high-enough resolution for you to make out the text immediately, although I did not find it comfortably legible.

Mixing different sizes on a line, which often spells trouble in other word processors, didn't bother Total Word. It still

managed to figure the spacings as it went along, and the printed margins tracked nicely. What you see with the preview screen matches the printout exactly. However, vertical spacing is based on whatever typeface the line begins with, so tossing a headline typeface into the middle of a line of 12-point type can cause problems.

Total Word controls appearances with precision because it supplies the fonts and oversees the installation of any new Hewlett-Packard or PostScript fonts you purchase from a third party, such as Bitstream (although, realistically, the supplied fonts probably cover the average user's requirements). You can name the font whatever you wish when you install a new one, and it is added to Total Word's list of fonts. The confusing details of width tables and software installation are handled for you.

But with simplicity also comes limitations. Total Word supports hundreds of printers, but only because those printers emulate one of the several printer definitions that Total Word recognizes: PostScript, Hewlett-Packard LaserJet, Epson, IBM Proprinter, NEC Pinwriter, Okidata Laserline, Toshiba, and the Xerox Diablo 630. The software is familiar with the various cartridges available for each.

**Scientific Word Processing**

The softfonts supplied with Total Word include more than 300 special characters, from the integral sign to the null set to the Hebrew aleph. These special characters are useful in transcribing scientific and engineering formulas.

You call up these formulas by pressing Alt-K. The program then gives you a list of possible keyboards (1 through 10); you invoke one by pressing Alt plus the number of the one you want. A diagram of the key assignment of the keyboard you choose is displayed while you are in the Alt-K mode.

The first keyboard has the standard QWERTY layout, and the second adds bullets, blocks, and business symbols, like the trademark sign and the British pound. The eight remaining keyboards offer the following additional features in their respective order: international characters (i.e., letters with umlauts and accents, and foreign punctuation); math logic and set symbols, such as union, congruent, and such that; square root, delta, sigma, and other special math operators; the Greek alphabet; a collection of arrows; various lines and brackets for box drawings; the standard IBM extended graphics; and various angled

slashes used in organic chemistry.

To actually see these symbols as they are supposed to look, you need EGA, VGA, or MCGA circuitry, or a Hercules RAMfont card. Otherwise, you see some other standard characters, unrelated to the ones you want to use, that are either boldfaced, blinking, or both.

If you can put up with those blinking oddments on the screen, you don't really need the correct graphics boards. Total Word comes with printed keyboard charts that let you pick your symbols even without being able to recognize them on the screen.

But keep in mind that, to Total Word, the symbols are just that—symbols. It has no sense that the formulas are as meaningful as words. The integrals and root signs, for instance, do not grow to cover the formula, as some scientific word processors can do. In other words, you're just doing typewriter drawings. Still, it's a lot more functional than most general-purpose word processors.

Total Word will do arithmetic, however, and it adds up rows and columns (and even blocks) of numbers. Unlike some word processors with this capacity, Total Word can even multiply and divide as well as add and subtract.

**Graphic Imports**

Many of the leading word processors lack any graphics capabilities, but depend on the user to create a print file with some graphics package. The user can then insert a command in the word-processing document to have the file printed on the page at that point, perhaps with some instructions for how it will be placed between the margins.

Total Word elaborates on this theme. The package includes a utility called Snapshot that you have to invoke from DOS. It sits in the background until, one moment when you're using some graphics program, you press Ctrl-Alt-Q. Snapshot then takes over and lets you crop the image on the screen and save it to a file. Control then reverts back to the graphics program.

Later, back in Total Word, you can call up the graphics menu with Ctrl-G, give it the name of the file, and answer some questions about the type of formatting you want, such as the size (100 percent means it will stretch from margin to margin), whether you want a border around it, and how dark you want it. Total Word then inserts a print-file command in your document to invoke graphics printing; you don't have to fool with the syntax at all.

*continued*





**Table 1: Total Word did poorly in BYTE's reformat and search-and-replace tests compared to Word 4.0.**

	Keystroke count	Search & replace	Reformat 4K file	Convert ASCII to WP*	Convert WP to ASCII	Print in columns	Scroll test	Load WP file	Save WP file
Total Word 1.012	322	364	94	18	8	170	42	16	9
Microsoft Word 4.0	158	24	<1	1	5	160	35	3	6

\*Text format used by word processor.

Note: Results are in seconds, except for keystroke count, which is the total number of keystrokes necessary to edit a standard document.

All you see in word-processing mode is that one-line command, but you can go into page-preview mode (although you have to use the full-page option) to see that miniature rendition of the page with the graphic on it.

When printed, the graphic is a faithful representation of the screen you captured, except for whatever minor distortions crept in when it was resized. However, it is also faithful to the original resolution of the screen from which it was captured, and that resolution can be markedly inferior to your laser printer's resolution.

Total Word also includes several other printer commands, mostly inherited from Volkswriter. These commands, which you embed in the text by preceding them with two periods, are intended for mail-merge projects, chain printing (i.e., one document invoking another), sophisticated printer control, and the generation of an index or table of contents.

### Full-Featured Word Processing

Aside from desktop publishing-like features, Total Word remains a word processor with strong roots in Volkswriter, including peculiarities you may not like.

Like Volkswriter, Total Word does not reformat as you go along. If you are inserting text in the middle of a paragraph, it adds blank lines for you to type the new text in, making it look like a mess until you stop and press a cursor-control key or the F8 (reformat) key. This is a rather antiquated approach, and the only apparent advantage is that it will be familiar to Volkswriter users.

The cursor-control keys can also fluster you. While the arrow keys work as expected, both the Home and End keys mean the same thing (i.e., "go all the way") when used with an arrow key. For instance, Home-left arrow means "go to the start of the line." Most word processors simply use Home for this purpose. And since after inserting some text, you first want to move elsewhere with the cursor-control keys, you, of course, press one, but this causes the text to reformat, and you end up going to the wrong place.

### Surprising Performance

Total Word is the first word processor I've encountered in a long time that cannot keep up with my typing, especially when I used a proportional typeface (although it also happened in Courier mode); the moment it word-wraps to start a new line, it falls behind and starts to issue warning beeps. After the beeps, it picks up only about half of what I typed.

I used a 4.77-MHz 8088 machine, but I discovered that the problem lessened on a PC AT-class machine (which was at least three times faster). Still, it was a disappointment not to be able to type two lines on a run without trouble.

In fact, Total Word presented a mix of comfortable speed and frustrating sluggishness. File loads and saves were tolerable, print speed and cursor movement were average, reformatting was tedious (because the program scrolls through the text and shows what's being reformatted), and the search-and-replace feature was embarrassingly slow—more than 15 times slower than Microsoft Word (see table 1) and more than 45 times slower than WordPerfect. The keystroke-count benchmark gave poor results, even among mouseless programs.

Speed aside, Total Word has impressive functions, most of them quite easy to use. You can add footnotes, for instance, just by pressing Alt-F. It takes care of placing the reference number in the text and the footnote at the bottom of the page (or on the last page—you get to choose). All you have to do is type Alt-F, then type the footnote text, and go on. A slight annoyance is that the spelling dictionary does not access the footnote text.

Redlining is also available, in which inserted text is shown with a special demarcation, and deleted text is not deleted but given yet another demarcation. Total Word also includes a command that lets you jump through the file from one change to another, and a global command to make all the redline insertions and deletions official.

There's also a feature that lets you define an abbreviation. Once Total Word

notifies that you have typed a defined abbreviation, it backspaces over it and then types the full text. This feature would be more impressive if it were faster, since I had to stop and wait for the replacement text to type itself, which rather defeated the whole idea.

You can print text in multiple columns, but in text mode you see only one column on the screen. You have to go to page-preview mode to see how the multiple-column page will really look.

The spelling dictionary has 170,000 words—about 50 percent more than average—and it can recognize words that were accidentally repeated, or abbreviations that need a period. There is also a word-count feature. The built-in thesaurus has 30,000 root words.

You can also store document formats in style sheets, create macros, insert commands that will not print, print in background mode (with DOS 3.0 or higher), create and fill out data-entry forms, generate form letters, sort lists, and exit to DOS to run DOS commands.

All in all, Total Word would seem to demonstrate the state of the market rather than the state of the art in word processors. It has every feature you would expect from an old warrior in the checklist word-processing wars—the ongoing competition to cram in every feature that any competitor ever found marketable. Now that desktop publishing has come along, some of its features must also be embraced by serious contenders, and in Total Word, they certainly are.

How few or how many desktop publishing features the market will bear (i.e., how many typographic complications users really want) has yet to be determined. But Total Word is in the forefront of those trying to find out.

Editor's note: *At press time, Lifetree began shipping version 1.1, which it claims is faster than version 1.012.* ■

*Lamont Wood is a freelance writer in the computer and electronics fields and lives in San Antonio, Texas. He can be reached on BIX as "editors."*

# Get A Better Spreadsheet Than Lotus For Only \$69.95



"Silk's improved graphics, fine use of function keys, interactive help, global search and replace, and easy-to-rearrange worksheets are reason enough to buy... At some point, you have to think about moving onward and upward (from Lotus). Silk gives you reason enough." — PC MAGAZINE

While it's not a clone, Silk has a Lotus-like user interface and easy file transfer (to/from Lotus) for a smooth transition to exciting new capabilities...

- Twice as fast as Lotus® with 8087/80287 coprocessor installed
- Keystroke logging prevents the loss of your worksheet sessions
- Fast, productive forms processing — just fill in the blanks
- Allocation models — cut the pie any way you want!
- Easy-to-rearrange worksheets
- Goal seeking, i.e. what price to charge to make X% profit?
- Two foreign exchange formats

Javelin®-type time series model  
in your conventional spreadsheet

Live help

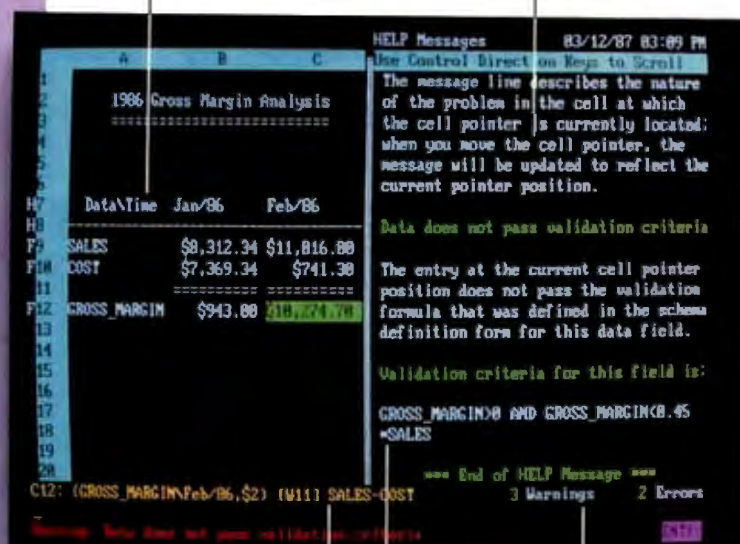

English language formulas

User-defined validation criteria

Spreadsheet validation

## And That's Just The Start Of Silk's® Exciting Features...

With all this — and more — going for Silk, Jim Gultinan of Cordata concludes "On a scale of 1 to 10 with Lotus being a 10, Silk is a 12." Soft Sector sums it up by saying "Silk is one of the most complete spreadsheet packages on the market today."

Yes, here's your spreadsheet wish list come true. At a price you dreamed of!

### Special Introductory Offer — New Version 1.1 Is Just \$69.95!

In reviewing the original Silk spreadsheet, Seybold Outlook said "this is a lot of software for the money." And we say "with this special introductory offer, it's a lot less!" Enhanced Silk 1.1 is just \$69.95 when you order directly from the publisher, now through September 30, 1988. After that, it's still an exceptional value at \$298.00 retail.

Why not order right now? And see for yourself why Orange Bytes Magazine says "Try Silk, but be careful, you may find your copy of 1-2-3 collecting dust."



**DAYBREAK**  
TECHNOLOGIES, INC.

Charge to your credit card and call toll-free: **1-800-443-0100**, ext. 361N. Toll-free number is for credit card orders only. For product information, call Customer Service at (213) 542-5888.

System Requirements: IBM® PC or compatible with PC-DOS® or MS-DOS® 2.0 or higher, with 512KB memory; hard disk recommended.

Silk is a registered trademark of Daybreak Technologies, Inc. IBM and PC-DOS are registered trademarks of International Business Machines Corporation. Lotus and Lotus 1-2-3 are registered trademarks of Lotus Development Corporation. Microsoft and MS-DOS are registered trademarks of Microsoft Corporation. Javelin is a registered trademark of Javelin Software Company.

Rush My Silk 1.1 Today!

Name \_\_\_\_\_

Organization \_\_\_\_\_

Address \_\_\_\_\_

City \_\_\_\_\_ State \_\_\_\_\_ Zip \_\_\_\_\_

Phone (\_\_\_\_) \_\_\_\_\_

\_\_\_\_\_ copies of Silk 1.1 @ \$69.95

Add \$10 per copy for 3.5" diskettes

Add shipping & handling (\$6.50 each for U.S. & Canada, \$40.00 each all other countries)

Calif. residents add 6.5% sales tax

Total \$ \_\_\_\_\_

Payment Method

Check or money order enclosed, made payable to Daybreak Technologies. (Sorry, no CODs!)

Charge my  Visa  Master Card

Acct. # \_\_\_\_\_ Expir. Date \_\_\_\_\_

Signature \_\_\_\_\_

MAIL TO: Silk 1.1 Introductory Offer, Dept. 361N  
Daybreak Technologies, Inc., P.O. Box 5629,  
2123B Hawthorne Blvd., Torrance, CA 90509

Do not enclose cash. Offer valid through September 30, 1988. Please allow 4-6 weeks for delivery.

Circle 74 on Reader Service Card (DEALERS: 75)



# The Official Endorsed Books On Quattro®

Over 175,000 Copies In Print



"Borland-Osborne/McGraw-Hill offers you the only full line of endorsed books on Quattro. These titles combine Borland's own technical expertise with Osborne/McGraw-Hill's publishing savvy. With these official Quattro titles, you'll have a comprehensive library that keeps pace with you as you develop greater skills with Quattro."

Philippe Kahn, President & CEO, Borland International, Inc.

**Quattro: Math Facts**  
by Lisa Biow

Guides you through a step-by-step introduction  
\$19.95 600 pp.  
ISBN: 0-07-881347-6

**Using Quattro:  
The Professional Spreadsheet**  
by Stephen Cobb

Gets you up and running fast with basic to more advanced techniques.  
\$21.95 584pp.  
ISBN: 0-07-881330-1

**Quattro: Secrets,  
Solutions, Shortcuts**  
by Craig Stinson

Unveils a clever selection of Quattro tricks.  
\$21.95 650pp.  
ISBN: 0-07-881400-6  
Available: 8/88

**Quattro: Power User's  
Guide**  
by Stephen Cobb

Unlocks Quattro's full power for serious business.  
\$22.95 600pp.  
ISBN: 0-07-881367-0

**Quattro: The Complete  
Reference**  
by Yvonne McCoy

Details every Quattro feature, command, and function.  
\$24.95 666pp.  
ISBN: 0-07-881337-9

**Quattro: The Pocket  
Reference**  
by Stephen Cobb

Puts essential commands and features at your fingertips.  
\$5.95 128pp.  
ISBN: 0-07-881378-6

## ORDER TODAY!

Available at Fine Book Stores and Computer Stores  
Everywhere or  
**CALL TOLL FREE  
800-227-0900**  
Visa, MasterCard, &  
American Express Accepted

BORLAND-OSBORNE/McGRAW-HILL

BUSINESS SERIES



Osborne McGraw-Hill  
2600 Tenth Street  
Berkeley, CA 94710



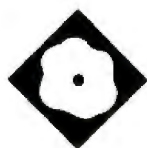

# Data Entry Goes High-Tech



DataPlex provides data conversion and a universal front end for data entry

Lamont Wood

If the computer world has a hierarchy, data entry is at the bottom. It offers no glamour, and it gets no attention. The rest of the computer world seems to see it as a necessary evil. But someone has to do it. Those ill-paid someones used to be found struggling mainly with card-punch machines, but in this increasingly personal computer-oriented world they're far more likely to

be struggling with off-the-shelf software whose data-entry facilities were, at least in many cases, an afterthought.

Those data-entry struggles may be over: Now there's DataPlex, from Tools & Techniques of Austin, Texas. Touted as a "universal front end" for data entry, DataPlex uses a low-level form of artificial intelligence to format incoming data. Its attempt to be universal offers a side effect—data conversion—that may make it noteworthy even to those who could otherwise never work up an interest in data-entry software.

DataPlex runs on an IBM PC or compatible with two floppy disk drives and 512K bytes of RAM, though the company recommends a hard disk drive and 640K bytes of RAM. It works with DOS 2.0 or higher and sells for \$195.

## The Problem

By "data entry," I mean more than the thankless mechanical task of keying information from paper into a computer. Of

course, that keyboard entry has to happen, but the computer ought to be doing data checking and editing. *Range checking* can keep a typist from inadvertently paying someone \$3 trillion an hour, or from doing anything on February 31. *Data typing* can ensure that ZIP codes and Social Security numbers aren't confused. The software ought to supply prompts that lead the typist through the task. And the typist ought to have the option of checking and editing data that's been input during that particular session.

Generally, if an organization has any software addressing the task, it's something cooked up by an in-house programmer who reinvented the wheel while doing so. So there are no standards: The data-entry clerks have to relearn every system they encounter. When you consider that one package might use the Tab key to move between fields, the next might use the Return key, and the next might use the space bar, you can see why data entry is considered a high-stress job. The big advantage to DataPlex, therefore, is not that it provides just the data-entry facilities mentioned, but that it eliminates the problem of learning a new system when the data-entry clerk moves to another system.

To be such a universal front end, DataPlex must address all major data-file formats. And it stands to reason that if it can do that, DataPlex can also let you move existing data from one package to another, so that database files can be fed directly to a spreadsheet, and vice versa. And DataPlex does, indeed, do that.

## DataPlex Explained

While DataPlex helps you enter data that can be used by off-the-shelf PC software packages—chiefly dBASE II and III, Lotus 1-2-3, Paradox, SuperCalc 4, and their many compatibles—it does not actually use those software packages. Instead, it produces files in the formats they use. If data input (as opposed to data

*continued*



## DataPlex 2.0A

### Type

Data entry and conversion package

### Company

Tools & Techniques, Inc.  
1620 West 12th St.  
Austin, TX 78703  
(800) 444-1945

### Format

Eight 5¼-inch floppy disks

### Language

C

### Hardware Needed

IBM PC or compatible with two floppy disk drives and 512K bytes of RAM

### Software Needed

DOS 2.0 or higher  
(Xenix-286/386 and UNIX V-68000 versions available)

### Documentation

290-page user's guide

### Price

\$195

### Inquiry 908.

manipulation) is all you're interested in, you don't even need to possess those packages.

The list of packages that DataPlex is compatible with is much longer than it seems, because many packages use or at least load files in 1-2-3 or dBASE formats, even if they are not functional clones of those two products. DataPlex can also use ASCII files, which most packages can at least import. DataPlex also supports the mail-merge data list formats used by WordStar, WordPerfect, and Microsoft Word. DataPlex's menu lists 24 formats or packages it can work with (see table 1), and it seems the list could easily be lengthened by adding more clones or packages that can use an intermediate format for input purposes. (The company says it intends to add about one new format a month.)

But you don't need to worry about formatting when you start using DataPlex. All you need is the ability to type and a vague realization that data files should be arranged in records that are themselves divided into fields. The address of BYTE magazine would be a record; the name, street address, city, state, ZIP code, and phone number would be fields.

The screen is divided into three windows. The bottom one has a list of com-

mand options that you select by moving a color bar from one to another and then pressing Return, as in Microsoft Word. The middle third of the screen has a box where help messages appear. (Contextual help messages are available at any time by pressing Alt-H.) The top of the screen is where your data is shown.

When you fire up the software and go into data-entry mode, the data-entry area of the screen has, centered in it, an enclosed space marked FIELD 1. If you type BYTE magazine, the words appear in the field. (For longer entries, the field expands to include the text.) When you press Return, FIELD 1 is joined on the right by FIELD 2. You can go on entering the street address, city, state, ZIP code, and phone number. Each time you hit Return, a new field is added.

At the end of the address, you press Return twice—and the magic begins. The software pauses for about 20 seconds (on my 4.77-MHz system), and the word Styling appears in the help box.

Then the data reappears. The name, address, and city fields are, as before, labeled FIELD 1-4. But the state field (containing NH for New Hampshire, BYTE's home) is labeled ST (state). And the phone number field is segmented into three subfields, labeled Area Code, Exchange, and Number.

In other words, DataPlex recognizes data for what it is. On subsequent records, you will not be able to enter anything in the ST field except a valid state abbreviation, and the phone field will accept only appropriately formatted numbers.

It's not perfect. BYTE's ZIP code, 03458, comes out as 3458, DataPlex having seen it as just a five-digit number. But leaving that field highlighted, you can go into command mode (by pressing Escape) and go to the Format menu, choose the Use command from the menu, and choose ZIP Code from the list of possible formats that appears. Suddenly, the ZIP code turns back into 03458. According to the company, DataPlex's designers were leery of letting the software classify every five-digit numeric field as a ZIP code, so you have to format it manually. The software readily recognizes ZIP+4 codes, however.

There are 44 different data formats it can recognize (actually more, if you count a number coupled with a unit measure as a format), including Social Security numbers, Canadian and European postal codes, 26 formats for calendar dates, and 6 formats for time of day.

These aren't perfect either. The date formats will let you specify February

31—but not February 32. The system knows only that a month should not have more than 31 days, or a year more than 12 months.

You can specify your own formats for a field, too. Numbers can be assigned a range, and an entry outside that range won't be allowed; thus, the computer can't try to pay someone \$3 trillion an hour. Or you can assign a list of possible entries. Anything not on the list will not be allowed, and as you type your entry DataPlex will try to match it with the entries on the list, beginning with the first letter. Generally, two or three keystrokes will be enough to produce a correct match. You can also compose your own lookup tables, so that an entry in one field will trigger an entry in another. For instance, an entry of 0 to 59 in a Semester Average field of a classroom tracking system could trigger the entry of an F in the Semester Grade field.

You can also set prompts for a particular field, so the computer can ask the typist to Enter last name, for example, instead of displaying a default prompt like Enter Data for FIELD 1.

Once you're finished with a session, you then use the Transfer command to save the file. DataPlex then saves it in a proprietary format with a .DP2 file extension.

At this point, you still don't have a database or spreadsheet file. To produce one, you invoke DataPlex's Connect facility and choose from the list of 24 formats, and the system produces a file of the corresponding file format and extension. The original .DP2 file still exists, so you can render it in multiple formats if you want.

DataPlex has no data-processing facilities of its own, but you can have it filter the data you want to output by using the Extract command in the Connect facility. Using simple logical operators tied to specified fields, you can have DataPlex output only those records that have fields meeting the requirements of the logical operators. Using the example address file mentioned above, you could specify the ST field, set the logical operator to =NH, and output a file containing only records with New Hampshire addresses. In fact, I found DataPlex's Extract function more approachable than the similar function in my database package.

### A Data Converter, Too

The data input procedure described above also works with existing data files. When you import a data file in one of the listed formats, DataPlex will attempt to

*continued*

# STATGRAPHICS®

New Version—2.6  
Upgrades Available

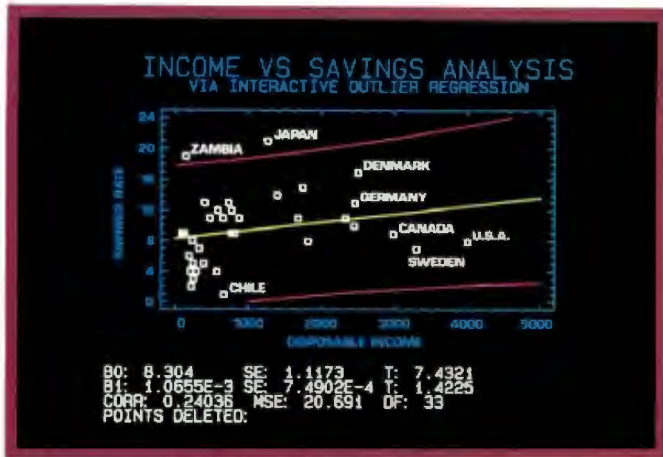

Select the points you want to remove from your regression model . . .

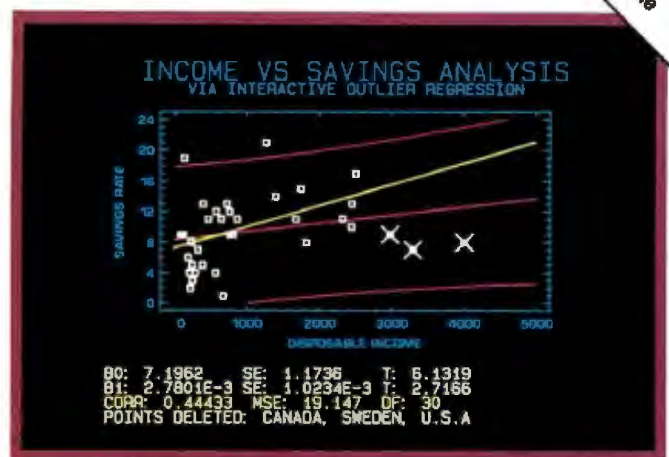

. . . Then press F6 to refit the model and recalculate the statistics.

## Because "Statistical Graphics" Is Better Than Just Statistics and Graphics

Most of today's PC statistical packages give you all the statistics you'll ever need. Some even give you a few graphics. But only STATGRAPHICS from STSC gives you integrated statistical graphics in an environment you control.

### Unique "What If" Interactivity

STATGRAPHICS lets you explore data relationships fully, producing higher quality, more timely solutions. Define your data and assumptions, run the procedure and review the results, modify data and assumptions repeatedly and take another look—and another. All without leaving the procedure or making permanent changes to your data.

### Integrated Statistical Graphics

Coupled with STATGRAPHICS' interactive environment are over 50 types of graphs—traditional pie and bar charts, histograms, 3-D line and surface plots, quality control charts, and more. All are integrated with the procedures so that they can be displayed instantly and modified repeatedly.

Query data points, do on-screen forecasting and model fitting, overlay graphs, or zoom-in on any area for a closer look. With flexibility like that, you can spot and investigate visual trends in your data—trends you may have missed if you looked only at the numbers.

### Over 250 Statistical Procedures

- Direct Lotus® and dBASE® interfaces
- ANOVA and regression analysis
- Experimental design
- Quality control procedures
- Multivariate techniques
- Nonparametric methods
- Exploratory data analysis
- Forecasting, time series analysis, and more.

### STATGRAPHICS—

#### The Best Way to Do Statistics!

Put the power of STATGRAPHICS to work for you today—all for only \$895\*. For our free convincer kit or the name of a dealer near you, call **(800) 592-0050 ext. 400**

In Maryland, (301) 984-5123;  
Internationally, (301) 984-5412.  
Telex 898085 STSC ROVE

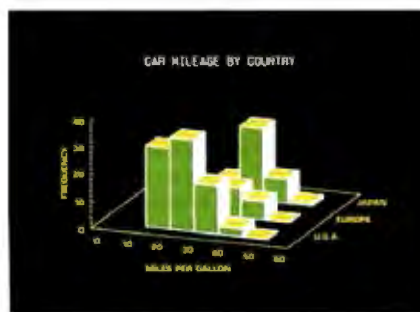
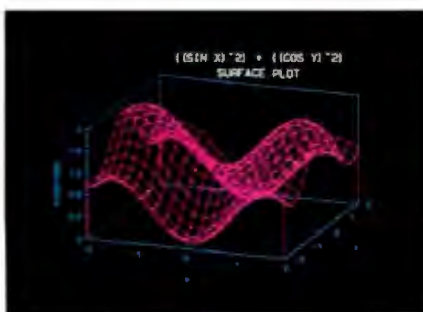

A wide variety of graphs supported on over 100 displays, printers and plotters, including the new IBM PS/2™ Series.

**STSC** STSC, Inc.  
2115 East Jefferson Street  
Rockville, Maryland 20852

\*Suggested retail price in U.S. and Canada. International prices vary. Available through dealers and distributors worldwide. STATGRAPHICS, Lotus, and dBASE are registered trademarks of Statistical Graphics Corporation, Lotus Development Corporation, and Ashton-Tate, respectively.



# IEEE-Z

IOtech offers the widest selection of **easy-to-use** IEEE 488 (GPIB) interfaces for the Macintosh.

• NuBus IEEE board for the Macintosh II

• SCSI / IEEE controller for the Macintosh Plus, SE & II

• Serial / IEEE controller for long-distance applications

• Serial / IEEE plotter converter for HP-IB plotter interfacing

• Desk accessory software for IEEE control from any application

• Language drivers for IEEE control from Basic, C, Fortran, Pascal, Hypercard and more

• Menu-driven software for scientific analysis and graphics

• **30 day money-back guarantee**

• **2 year warranty**

• **Call or send for your FREE Technical Guide**



IOtech...the choice is easy

## IOtech

**(216) 439-4091** Telex 6502620864  
Fax (216) 439-4093

25971 Cannon Road • Cleveland, Ohio 44146

London (0734) 86-12-87 • Paris (1) 348 01 78 • Zurich (01) 821 944  
Milan 02-41 20360 • Ljubljana 013 11 01 40 • Gortachem 01830-35333  
Stdney (2) 452 3831 • Seoul 784-9942 • Munich and other European,  
North Africa and Middle East countries not listed (089) 710020.

## REVIEW

### DATA ENTRY GOES HIGH-TECH

**Table 1: A list of file formats currently supported by DataPlex.**

ASCII delimited-field format (delimiters can be specified)  
ASCII fixed-field format  
IBM binary (EBCDIC)  
dBASE II  
dBASE III  
DIF (Data Interchange Format)  
Lotus 1-2-3  
Paradox  
FoxBASE  
FoxBASE Plus  
Microsoft Word (mail-merge list format)  
WordPerfect (mail-merge list format)  
WordStar (mail-merge list format)  
Symphony  
Catamount (nine-track tape interface board)  
Overland (nine-track tape interface board)  
Framework II (database format)  
Framework II (spreadsheet format)  
Multiplan 2.0 (ASCII list format)  
Multiplan 2.0 (spreadsheet format)  
Reflex  
SuperCalc 4  
VP-Info  
VP-Planner

classify the contents of each field in the first record (or the first row in a spreadsheet file) and apply it to the rest of the file. After it's loaded, you can add further data, or you can edit the data and (after saving it as a .DP2 file) output it in either the same format or a different one.

A new file or a newly converted file can also be appended to an existing data file, although the manual warns against doing this with certain spreadsheets.

Actually, you can use the program as a data converter independent of data entry, and vice versa. DataPlex can be invoked with its FE (front end) command, in which case you're immediately in the data-entry facility, or through the regular DP (DataPlex) command, which gives you access to both the data-entry and file conversion commands. So it's possible to use DataPlex as purely a data converter without being aware of its data-entry facilities.

DataPlex also handles binary data entry downloaded through a modem. This refers to data in IBM mainframe format, using the EBCDIC alphabet code instead of the ASCII code and representing numbers in packed decimal format. DataPlex can also convert data from nine-track tapes when used with a PC equipped with a Catamount or Overland tape interface board and an optional DataPlex software enhancement that costs \$595.

Inside DataPlex, a numeric field can be assigned a unit of measure; the unit will not be listed in the field, but it will appear in the prompt. DataPlex has 31 units of measure, covering distance, weight, and volume. After assigning a unit to a field, you can then change the measure and DataPlex will recalculate the figure. Thus, for instance, you can convert from English to metric and change all your tons to kilograms automatically.

#### All Things to All People?

The manual is thorough, but it was apparently written by and for programmers, saying things like "connect to an outside application" when it means "output your data in a particular file format." Nor were things clear even after I broke this code: Pertinent information tends to get lost in the forest of options. For instance, it turns out that to output the ZIP code mentioned above correctly to a data file (as 03458 instead of 3458), you also have to format that field with the Width command in the Format menu to add leading zeros.

And while DataPlex seeks to be a "universal front end" for data-entry tasks, that means the company is offering its data-entry screen as *the* universal data-entry screen—and a lot of people won't be happy with it. The (usually empty) help box and the command lines consume so much of the screen that you only see the data record you're working on, plus the last three records (which are shown at the top of the screen). There's no way to adjust the size of the data-entry area, so what you see is what you get. In addition, there is no provision for using color to give extra meaning or emphasis to the input screen, although color is all the rage nowadays.

DataPlex is easy enough to use for a data-entry clerk, although the naive user is in danger of getting lost in the formatting options when approaching anything but the most rudimentary task. But it is a powerful tool in the hands of a computer-literate manager. When you have scores of people struggling through the ghastly tedium of inputting data into the typical spreadsheet, even slight improvements in productivity are important, and DataPlex offers major improvements for most folks. And in any office where the professionals each have their own unique and beloved software package, DataPlex is an invaluable integration tool. ■

*Lamont Wood is a freelance writer in the computer and electronics fields and lives in San Antonio, Texas. He can be reached on BIX as "editors."*



DXIS system running Lotus 1-2-3



SCO XENIX system running SCO Professional

## THIS IS AN IBM PS/2 MODEL 80 RUNNING DOS

Under DOS, this PS/2™ is a powerful 80386-based single-tasking, single-user computer that can run thousands of DOS applications. In 16-bit, 8086 mode.

One at a time.

When OS/2™ software becomes available, the PS/2 can become a multitasking, single-user computer running in 16-bit, 286 mode that can also single-task those DOS applications under OS/2.

One at a time.

With DOS or OS/2, the PS/2 will support one user.

	1 user (DOS)	1 user (OS/2)
Cost per system**:	\$12,389	\$12,594
Cost per user:	\$12,389	\$12,594

## THIS IS AN IBM PS/2 MODEL 80 RUNNING SCO XENIX

Under SCO XENIX®, this PS/2 becomes a powerful 80386-based multitasking, multiuser computer that can run thousands of XENIX applications. In full-tilt, 32-bit, 386 mode.

Many at a time.

And using SCO VP/ix™\* the PS/2 can multitask DOS applications under SCO XENIX.

Many at a time.

With SCO XENIX, the PS/2 will support one user.

Or 9 users. Or even 33 users.

And it can do all that today because you can get SCO XENIX for the PS/2—*now!*

	1 user	9 users	33 users
Cost per system**:	\$14,559	\$19,726	\$40,402
Cost per user:	\$14,559	\$2,192	\$1,224

SCO XENIX System V and the SCO XENIX family of software solutions are available for all industry-standard 8086-, 80286-, and 80386-based computers, and the IBM® Personal System/2™ Models 50, 60, and 80.

Circle 239 on Reader Service Card

\*SCO VP is available as separate product.

\*\* Cost comparisons are based on most recently published U.S. domestic suggested list prices. Cost included: Base machine: IBM PS/2 Model 80™ 70Mb disk, 1Mb RAM, IBM 0512 color monitor, 1Mb additional IBM RAM, IBM Professional XL™ 1-user DOS system. Base machine, plus DOS 3.3, WordPerfect 4.1, Lotus 1-2-3™ dBASE III PLUS™ 1-user OS/2 system, 1-user DOS system, substitute OS/2 for DOS, 1-user SCO XENIX system. Base machine plus SCO XENIX 996 for PS/2, SCO VP (ix, SCO 1-yr) (word processing), SCO FileBASE™ (dBASE III PLUS compatible), SCO Professional™ (1-2-3 compatible), 9-user SCO XENIX system, 1-user SCO XENIX system, plus intelligent 8-user multipoint card, 1 IBM 3151 ASCII terminal, 53-user SCO XENIX system, 9-user SCO XENIX system, plus 4 more intelligent 8-user multipoint cards, 24 more IBM 3151 ASCII terminals, 4 Mb additional RAM, additional 70Mb disk.

IBM and Professional XL are registered trademarks and Personal System/2, PS/2 and OS/2 are trademarks of International Business Machines Corporation. • Lotus and 1-2-3 are registered trademarks of Lotus Development Corporation. • dBASE III PLUS is a registered trademark of Ashton-Tate. XENIX is a registered trademark of Microsoft Corporation. • VP (ix) is a trademark of INTERACTIVE Systems, Inc. • Lyras is a registered trademark and SCO Professional is a trademark of The Santa Cruz Operation, Inc. • G. FileBASE is a trademark of Fox Software, Inc. 10/87 © 1987 The Santa Cruz Operation, Inc. 400 Central Expressway, Santa Cruz, CA 95061. The Santa Cruz Operation, Ltd., 18 Noel Street, P.O. Box 417N, London W1A 4YN United Kingdom. ••• 415 2911 (FAX) ••• 41 637 9582 TELEX 917372 sco us

**SCO**  
THE SANTA CRUZ OPERATION

(800) 626-UNIX (626-8649)  
(408) 425-7222  
FAX: (408) 458-4227  
TWX: 910-598-4510 sco sacz  
unep. ... devax!microsoft!sco!info!



# Some Datacomm Standards Should Be Carved in Stone



In the matter of full-duplex data communication at 9600 bps, a number of approaches have been discussed. There's the CCITT-approved V.32. There are even some "pseudo V.32s" around. Some suggest that, because of their somewhat lower cost, non-standard modems may be the answer.

At Universal Data Systems, our position is carved in stone: for full end-to-end compatibility, regardless of equipment source, standardization on true V.32 is the only workable solution.

That's why the fully featured UDS V.32 is the acknowledged price/performance leader.

Our exclusive near-end/far-end echo cancellation techniques, combined

with trellis coding, result in  $-17$  dBm signal-to-noise ratio; that's plenty of horsepower for voice-grade lines.

As back-up for your dedicated four- or two-wire system, or for a 9600 bps upgrade of your present dial-up communications, check out the UDS V.32. It's the standard!

Universal Data Systems, 5000 Bradford Drive, Huntsville, AL 35805.

Telephone 205/721-8000;

Telex 752602 UDS HTV.

**\$1595<sup>00</sup>**  
Quantity One



Universal Data Systems

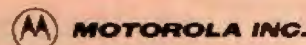

Circle 286 on Reader Service Card

# Review Update

## NEC's Newest MultiSyncs

Since the February review of multiscan color monitors, we've been able to test NEC's three new monitors: the MultiSync II, XL, and GS.

The \$899 MultiSync II, the successor to NEC's original MultiSync, has a 13-inch screen with a 0.31-millimeter tri-dot pitch. Front-panel controls include brightness, contrast, and power. You can access more switches from beneath a front-panel cover. These include vertical position and size, horizontal position and size, text mode, and text color. When the text-mode switch is on, text appears in the color selected by the text-color switch—white, amber, or green.

Rear controls include a manual switch, a mode switch, and a color-mode switch. When the manual switch is off, the MultiSync II automatically adjusts to the scanning frequency, resolution, and color requirements of the graphics adapter you're using. With the manual switch on, you select the mode (gray-scale or color) and the number of colors (8, 16, or 64) that the graphics adapter requires. The monitor's single D-sub 9-pin adapter accepts digital or analog inputs, and the unit comes with a tilt-swivel base.

The monitor's horizontal scan frequency automatically ranges from 15.5 kHz to 35 kHz, and vertical scan ranges from 50 Hz to 80 Hz. The bandwidth is 30 MHz, and resolution runs 800 dots horizontal by 560 lines vertical. A 21-page manual covers adjustments, connections, basic troubleshooting, pin assignments, and timing charts. The MultiSync II's warranty is limited to 1 year for labor, 2 years for parts.

Our Microvision Superspot 100 tests recorded a 0.534-mm spot size for the MultiSync II. The monitor's spot size bloomed to 0.642 mm at maximum brightness, but this difference is within acceptable limits. Spot size indicates the true fineness of the display, while blooming reveals how resolution is affected by brightness. A small spot size

and a small difference between low and high levels are best. In earlier tests, the Electrohome ECM 1910 and the NEC MultiSync Plus registered the best spot sizes—around 0.45 mm. The MultiSync II numbers represent a median range.

Spot sizes usually deteriorate at the corners. Too much difference between a center spot size and a corner spot size reveals poor design. Corner spot size for the MultiSync II measured 0.648 mm at normal brightness and 0.75 mm at maximum brightness. These numbers fall within tolerable bounds. The finest corner spot sizes of the monitors we tested fell between 0.55 mm and 0.60 mm.

The MultiSync II displays pure colors, but it lacks striking sharpness. Our tests noted very little misconvergence, but they did reveal some unacceptable jitter. Swim and drift were not problems. In fact, the MultiSync II monitor posted exceptionally small numbers for horizontal time variance.

In the February review, we presented general specifications for NEC's 19-inch MultiSync XL, but we hadn't received the monitor in time to run our Microvision tests. The XL has a 0.31-mm tri-dot pitch, and our equipment measured a center spot size of 0.562 mm and a corner spot size of 0.585 mm. Both the spot size itself and the difference between best-case (center) and worst-case (corner) measurements were small. However, at high intensity, blooming begins to affect the display. The center spot size increases to 0.809 mm at maximum intensity; the corner spot size rises to 0.919 mm.

Measurements for jitter and swim were average, but the XL's numbers for both vertical drift (0.041 mm) and horizontal drift (0.015 mm) were exceptionally low. The XL also scored very well on our misconvergence tests, registering less than 0.1 mm in red-to-green, blue-to-green, and red-to-blue errors. The tests also revealed very little difference between misconvergence at the center of the screen and at the corner.

The MultiSync XL comes with a 25-page pamphlet that covers adjustments, connections, basic troubleshooting, pin assignments, and timing charts. Like the MultiSync II, the XL's warranty is 1 year for labor and 2 years for parts.

The \$279 MultiSync GS (gray scale) monitor has a 14-inch screen with a flattened face to minimize glare. The monitor comes with a tilt-swivel base. The controls are easily, though somewhat inconveniently, accessible atop the monitor. These controls include brightness, contrast, vertical size, vertical position, horizontal position, and power. A TTL/analog switch at the rear of the monitor selects the proper video input mode. The monitor comes with an adapter to interface it to the analog video port of IBM PS/2 systems.

Resolution for the MultiSync GS reaches a maximum of 720 dots horizontal and 480 lines vertical. The horizontal scan frequency automatically adjusts to a maximum of 31.5 kHz; the vertical scan reaches a maximum frequency of 70 Hz. A 17-page manual covers controls, connections, basic troubleshooting, pin assignments, and timing charts.

Spot sizes for the MultiSync GS were fairly high: 0.719 mm at the center and 0.765 mm at the corner. However, spot size did not vary greatly from best-case (center) to worse-case (corner), and intensifying the brightness did not cause excessive blooming. These numbers reveal a well-designed monitor with average fineness.

Our time variance tests for the MultiSync GS registered excessive jitter: vertical jitter measured 0.016 mm, and horizontal jitter measured 0.0089 mm. However, measurements for swim fell within the median range, and drift measurements were very low.

Visually, the GS display is much more appealing than a conventional monochrome screen. Colors are represented by up to 64 shades of gray, providing greater clarity and versatility than the monochrome option offers. For programs that use extensive graphics or color menus, the GS display also enhances functionality.

All three monitors are available from NEC Home Electronics (USA), Inc., 1255 Michael Dr., Wood Dale, IL 60191, (312) 860-9500.

—Stan Diehl







Striking 16" x 20" Limited Edition Prints from the pages of Byte. Each print is signed and numbered by the artist, Robert Tinney.

### Limited Edition Classics

You've seen them on the cover of Byte — now enjoy these delightful images as stunning limited edition prints! Each print pictured here is published in an edition strictly limited to only 1000 signed and numbered prints, and each is accompanied by its own Certificate of Authenticity.

These gorgeous reproductions are printed on select 100% cotton fiber stock; this is a museum grade acid-free paper, highly resistant to yellowing and cracking. You will be assured of a print which will retain its color and beauty for generations.

### Price and Shipping

The price of Byte Limited Editions, which depends on the number of unsold prints in each edition, is shown above each print pictured here. In addition, a 15% discount is available if you order two or more prints.

Your prints will be shipped flat, usually within a week of our receipt of the order. Shipping is via UPS Blue Label.

### Guarantee

Ship your prints back to us within 30 days of your order, and you will be given a complete, no-questions-asked refund.



Yes! Send me the following Byte Limited Editions.

QTY	#	TITLE	AMOUNT
			\$
			\$
			\$
			\$
			\$
			\$
			\$
Deduct 15% if ordering two or more prints.			\$
Shipping: \$4 (\$20 overseas).			\$
<b>TOTAL</b>			<b>\$</b>

- I have enclosed U.S. check or money order.  
 C.O.D. (via UPS—stateside orders only)  
 VISA  MasterCard  American Express

Card #: \_\_\_\_\_

Expires: \_\_\_\_\_ Signature: \_\_\_\_\_

Ship my Print(s) to:

Name: \_\_\_\_\_

(Business): \_\_\_\_\_

Address: \_\_\_\_\_

City: \_\_\_\_\_

State: \_\_\_\_\_ Zip: \_\_\_\_\_

mail this coupon to:

**Robert Tinney  
Graphics**

1864 North Pamela Dr  
Baton Rouge, Louisiana  
70815

For VISA, MasterCard or  
American Express orders,  
or for more information

Call 1-504-272-7266



Please send your COLOR brochure



# Display Technology

- 243 Face to Face**  
by Gene Smarte and  
Nicholas M. Baran
- 257 Taking the Wraps  
off the 34020**  
by Ron Peterson, Carrell R.  
Killebrew Jr., Tom Albers,  
and Karl Guttag
- 275 Lighting the Way**  
by Rolland Von Stroh and  
Brian Dolinar
- 282 Monitor Makers**

**W**hat you see isn't just what you get—it's everything. When you're interacting with a computer on a visual level, as many of us spend a great deal of time doing, what you see and how well you see it often makes the difference between health and headaches, efficiency and eyestrain. The quality of that visual interaction can—dare I say it—affect the very quality of our lives, at least the portion that we spend looking at our display screens.

As soon as you start talking about various types of displays, it becomes very clear that there are almost as many opinions about what is best as there are people working at display monitors. One person wants an amber monochrome display while another prefers green. One person likes a display that is garish with bright colors while another wants just a few carefully chosen soft colors. One person wants as sharp a contrast as possible between the characters on the screen and their background, while another finds that combination blinding. And who among us hasn't had to adjust the brightness controls and the viewing angle on nearly every monitor we've used?

This month, BYTE looks at display technology and the various types of monitors popular today. In "Face to Face," Gene Smarte and Nicholas M. Baran look inside the CRT, gas-plasma, liquid crystal display (LCD), and electroluminescent (EL) display and describe what they find there. Gene and Nicholas explain the hows and whys of these technologies, how each one creates the light we see, and what the various problems with each are.

"Behind every successful monitor is a hard-working graphics chip." Well, maybe not every one, but certainly the various graphics chips are heavily in-

involved in "what you see." This month we are excited to present "Taking the Wraps off the 34020" by Ron Peterson, Carrell R. Killebrew Jr., Tom Albers, and Karl Guttag. The 34020 is the new 32-bit graphics microprocessor from Texas Instruments, and these gentlemen have been intimately involved with its design and implementation. It's a fascinating article about a chip sure to have an effect on the marketplace, and we are delighted to be able to give you the inside scoop so soon after its release.

Next, we take a look at a screen type undergoing significant changes—the EL display. In "Lighting the Way," Rolland Von Stroh and Brian Dolinar expose the secrets of electroluminescence, how and why it's so bright, and Planar Systems' recent foray into the world of EL color.

There may never be one monitor or one type of display that pleases all of us all the time, but as the technology improves, choosing the best is becoming more and more difficult. There are literally hundreds to choose from. In fact, there are simply too many to list, so this month rather than listing monitors you might pick, we have included a list of the companies that make microcomputer monitors in "Monitor Makers."

As headaches and sore eyes—at least those caused by poor display quality—become a thing of the past, and display technologies approach each other in quality, prices will have to come down. As a result, the choice between monitors will become just that—a choice, a matter of personal preference. Then, it will be interesting to see which technology comes out on top.

—Jane Morrill Tazelaar  
Senior Technical Editor, *In Depth*





# THE BEST WAY TO SEE THE FRUITS OF YOUR LABOR.

**Seiko Instruments' CM-1430 Monitor offers you the finest color image of any monitor available today.**

More precise focus. Better contrast. A brighter picture. The richest colors. No other color monitor made today offers you an IBM® XT, AT, PS/2™ or compatible system a better image than that produced on our Super Fine Pitch™ Black Trinitron™ screen.

The CM-1430 Color Monitor is compatible with CGA, MDA, HGC, EGA, PGC, MCGA and VGA software modes. It also supports the IBM 8514/A graphics adaptor in resolutions as high as 1024 x 768. So it's ready for the next generation of video standards even before you are.

And, to make compatibility even easier, the CM-1430 automatically switches itself to work in whatever mode you're using. So now, all of your applications can be handled by just one high per-

formance yet very affordable monitor. You'll never have to spend money upgrading or adding extra boards again.

Of course, the color monitor with the best picture is backed by the company known for quality — Seiko Instruments. Call today for the name of the Seiko dealer nearest you. And see for yourself how the fruits of your labor can now blossom with more vivid, life-like colors than ever before.

Inquiries, call Bob Clark **(408) 922-5900**.

*Circle 244 on Reader Service Card*

## **Seiko Instruments**

Seiko Instruments USA, Inc. PC Products Division (408) 922-5900

© 1988 Seiko Instruments USA. IBM and PS/2 are registered trademarks of IBM Corp. Super Fine Pitch and Trinitron are registered trademarks of Sony Corp.



# Face to Face

*Where are we now,  
and where are we going?*

*Gene Smarte and Nicholas M. Baran*

**F**our major display technologies compete for the right to go "face to face" with all of us. They appear not only in computers, but also in televisions, household appliances, medical equipment, military equipment, and in other devices that need to display text or graphics.

These technologies are the CRT, liquid crystal display (LCD), gas-plasma display, and electroluminescent (EL) display. Other technologies, such as vacuum fluorescent displays (VFDs), electrophoretic displays, and light-emitting diode (LED) displays, are comparatively minor, and we won't cover them here.

Due to the great number of display products manufactured and their complexities, it's impossible to provide technical details of all the competing products. However, we have tried to show the technology behind each approach in a representative manner.

In the midst of continual improvements in computer-processing power, I/O speeds, and storage capacity, advances in display technology are often overlooked. But with the increasing importance of the graphical user interface in all aspects of computing, advances in



display technology will play a key role in defining the computer of the 1990s.

Over the years, many industry watchers have predicted that one or another display technology would dominate and eventually wipe out its competitors. However, there seems to be no basis for this prediction. As industry analyst David Mentley of Stanford Resources in San Jose, California, points out, "Each

technology finds its own niche. The concept that one technology is going to dominate the market is not valid."

Two major forces are driving the display market. One is the television industry. According to Mentley, "The Japanese display effort is driven by televisions, not by computers." The Japanese dominate the television industry and are devoting major efforts to improving displays for both portable, pocket televisions and large-screen, high-definition TVs. Of course, the technological advancements in television then have a corresponding effect in the computer industry. "It's a short drop back to produce monitors instead of TVs," says Mentley.

The second driving force is the demand for color. As graphical user interfaces are becoming increasingly popular, color is almost a necessity in a graphics environment. At this time, CRTs still have the edge in displaying color.

## **CRTs**

Even though it's about 85 years old, the CRT still has many miles left in it, according to companies who use the tubes

*continued*



in their monitors. They may be investigating other display technologies, but they are not abandoning their bread and butter. The CRT's reliability and price-to-performance ratio are tough to beat, and millions and millions of these tubes are in use around the world.

Currently, the CRT is the only relatively inexpensive system that can produce large full-color images. As Dick Sager, product manager for high-resolution monitors at Mitsubishi, said, "For the past 20 years I've heard that the CRT would be dead in about 5 years."

The "Multiscan Color Monitors" review in the February BYTE takes a close look at how 14 modern color monitors performed and provides detailed technical information on monitor specifications.

### A CRT Primer

Let's take a quick look at how a CRT works before we look at today's technology. Conventional CRT displays produce an image by directing an electron beam on a phosphorescent coating on the glass face of the tube. When struck by the electron beam, the phosphor glows, producing the light that reaches our eyes. When the electron beam stops hitting a phosphor, the light quickly fades. Different phosphor compositions control how long the glow lasts, their *persistence*, and, in color CRTs, what colors are produced.

Figure 1a shows a simplified cross section of a CRT. The negatively charged electron beam starts in an electron gun at the back of the tube and is accelerated toward its face by a large positive voltage. Along the way, the beam is focused into

a round shape and swept across the tube face horizontally and vertically.

These days, most video-monitor CRTs use electromagnetic focusing and deflection coils, the windings of which are often referred to as a *yoke*. Turning the electron beam on and off at appropriate times via the control grid produces a glowing pattern on the tube's face. For monochrome displays, the phosphors can be just about any color: white, green, amber, and so forth. But that's just what you get—one color.

The long "neck" of the CRT significantly contributes to cabinet depth. Efforts to shorten the neck create deflection and focusing problems, because then the electron beam must be moved through large angles; it strikes the tube face more obliquely as it moves away from center.

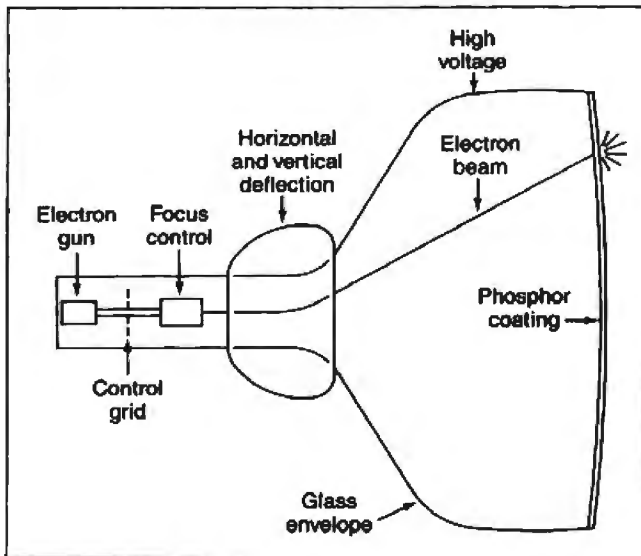

**Figure 1a:** Typical monochrome CRT operation. Negatively charged electrons are produced in an electron gun and are attracted to the high positive voltage at the front of the tube. The resultant electron beam is focused on and deflected across the CRT face.

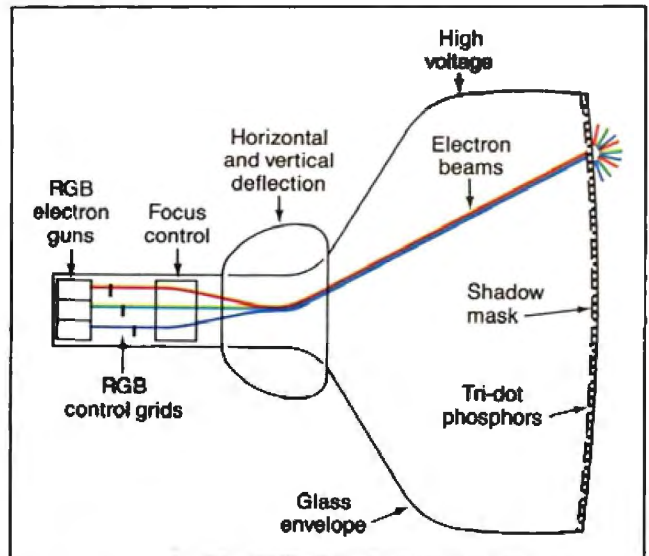

**Figure 1b:** A typical color CRT uses three electron guns for red, blue, and green, and corresponding colored phosphor dots on the CRT face. A thin metal screen, a shadow mask, is perforated with tiny holes that must align with the phosphor dots (see figures 1c and 1d).

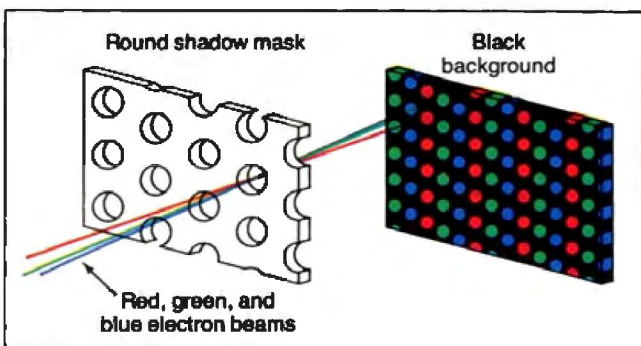

**Figure 1c:** Close-up of a round-holed shadow-mask and phosphor-triad arrangement.

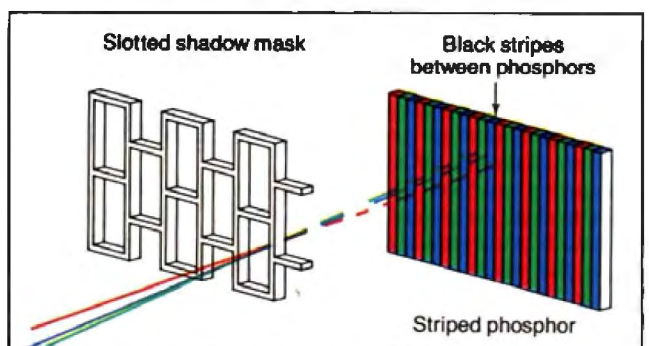

**Figure 1d:** Close-up of a rectangular-holed, striped-phosphor shadow-mask arrangement.

Full-color displays add complexity to the basic CRT design. Figure 1b shows that a typical color CRT has three electron guns, one each for red, green, and blue (Sony uses a single gun); a tube face covered with tiny triads of red, green, and blue phosphors; and a shadow mask.

You will often hear the *dot-pitch* specification mentioned when comparing CRT monitors. Dot pitch or *tri-dot pitch* is the distance in millimeters between the phosphor triads and is some measure of the resolution capabilities of the CRT itself. Many EGA monitors have dot-pitch measurements in the 0.28- to 0.31-mm range, and the trend is toward finer dot pitches.

The shadow mask is made of metal and has tiny holes in it that must be precisely aligned with the phosphor triads to prevent the beams from striking and illuminating other phosphor triads. The holes are often round with corresponding round phosphors on the face of the tube (see figure 1c).

Some CRT designs use a shadow mask with rectangular slots to illuminate alternating stripes of red, green, and blue phosphors (see figure 1d). As in a monochrome display, the beams are swept across the tube face, striking their appropriate phosphors through the shadow mask. By controlling which electron beams strike which of their corresponding phosphors, full color can be realized.

Recently, a big change in monitors has been the introduction of multifrequency scanning capability. Pioneered by NEC and its MultiSync family of monitors, multifrequency scanning capabilities have rapidly become commonplace. Early on, computer monitor manufacturers used the same horizontal and vertical scanning rates as television—that is, 15,750 Hz for horizontal and 60 Hz for vertical. To improve brightness (by hitting the phosphors more often in the same amount of time), permit faster screen updates, and reduce flicker, many monitors and controllers can now operate under a wide range of frequencies.

This flexible scanning approach also lets your monitor adapt to different graphics display standards. Generally, as the scanning frequencies increase, the image quality increases. But a system designed to operate at only one frequency can usually be optimized to produce a better-quality image than one that must be capable of accepting a broad range of operating conditions.

### Bigger and Better

There's an ongoing demand for higher resolutions and larger displays in both

monochrome and color. In CAD, image processing, graphics specialties, and others, the demand is for photographic resolutions. The trend seems to be toward color, even though certain applications, such as word processing, can seem cluttered with extraneous color boxes and menus. Also, monochrome monitors clearly have the edge in resolution. A CGA display is harder on the eyes than a decent monochrome monitor.

The desire for higher resolution runs into two old problems: lack of brightness and unwanted heat. With monochrome monitors, heat is a persistent, but not insurmountable, problem. There's no shadow mask to absorb and waste energy.

MegaScan Technology in Gibsonia, Pennsylvania, holds a patent on a yoke-heat dissipation technique and uses it in a 19-inch white monochrome monitor. It provides up to 4096- by 3300-pixel resolution using an electron-beam spot size of 0.005 inch. This precision translates to 300 dots per inch. Photo 1 shows the ultrahigh-resolution MegaScan screen; the actual screen looks better than the original photo, whose appearance has been slightly degraded through the off-set-printing process.

This extremely high resolution is excellent for use in medical imaging and in desktop publishing for font inspection.

According to Gary Zeller, a sales-support engineer for MegaScan, 3-point type displayed on the 19-inch monitor is readable, "though not for very long." This resolution comes with a price: about \$16,000 for an "intermediate-level" system consisting of monitor, controller, and interface in single-lot quantities.

Also, tube shape is now affecting display quality. Because of the way the electron beam is deflected across the face of the tube, it makes sense to have the face curved hemispherically. The electron beam then acts like the radius of a circle whose circumference is the tube face. Once focused, the round-shaped beam strikes the tube face perpendicularly regardless of position as long as the beam radius matches the spherical dimension. Because of manufacturing requirements and the methods employed to deflect the beam, maintaining a round spot on the tube face is difficult anyway. And it becomes even more difficult as tube faces become flatter and flatter—another trend.

As the focused round beam moves away from the center position in a "flat" tube, the radius length increases, changing the focus, and it also begins to strike the tube face at an angle, forming an ellipse. This ill-shaped beam degrades the

*continued*



**Photo 1:** A display on an extremely high-resolution monochrome monitor screen. The actual quality of the screen display has been degraded by the printing process. What you see is only about one-third the quality of what you get. (Photo courtesy of MegaScan Technology, Inc.)



image. Different manufacturers address this problem through various means, but they generally employ some kind of beam-shaping circuitry to adjust the shape of the beam on-the-fly, according to where on the tube face it's located.

To get higher resolution in color tubes, shadow-mask holes and phosphor triads need to be smaller. Reducing phosphor size means that there is less material to glow, reducing brightness. Also, with smaller shadow-mask holes, fewer electrons strike the phosphors if the electron-beam intensity is held constant.

Generally, to get more electrons to strike the phosphors, you can increase the number of times the phosphors are illuminated in a given period or increase the electron-beam intensity. Unfortunately, either way, the energy that strikes the shadow mask then also increases, manifesting itself in the form of heat. This heat can warp or *dome* the mask and distort the alignment between hole and triad, degrading the image. One CRT manufacturer said that less than one-third of the electron-beam energy actually reaches the phosphors. This means that more than two-thirds never makes it beyond the mask and turns into unwanted heat.

A couple of different approaches are being taken to stabilize the shadow mask. One is to replace the common iron mask with a more thermally stable material such as Invar, an iron-nickel alloy. Another method, used by Zenith, is to put the shadow mask under tension to prevent it from moving when it heats up.

According to a Zenith spokesperson, the flat-tension mask (FTM) is tightly stretched steel that is much thinner than

standard masks. As a result, fewer electrons are absorbed by the mask, while the tension in the mask prevents distortion and misalignment as it heats up. The upshot is a much brighter picture with more contrast—50 percent brighter and 70 percent better contrast, according to Zenith—and improved color purity.

Unlike other CRTs with a uniform dot pitch, the Zenith tube has an "average" 0.28-mm dot pitch. In the center of the tube, the dot pitch is 0.27; at the edges, it's 0.30. Zenith owns several patents on the technology behind the FTM. The company also says that while it has experienced the normal problems associated with a project start-up, it is going forward with the program. Other CRT manufacturers claim that the FTM is viable from a technological standpoint, but it is also expensive.

In spite of the problems that have been encountered, several CRT-based monitor manufacturers continue to increase resolution and performance. Mitsubishi recently showed a prototype of a 19-inch color monitor with a 2000- by 2000-pixel resolution. It uses 0.21-mm dot pitch and a horizontal scanning-frequency limit of 128 kHz. Toshiba has worked on the shape of its CRT, added an Invar mask, and improved the electron gun, focusing elements, and deflection system to provide a unit that is 50 percent brighter than before. The battle to improve the CRT is in full swing.

#### A Moving Target

The CRT has turned out to be a very robust and continuously evolving technology. As David Mentley says, "The CRT is a moving target: 1280 by 960 shadow

masks are now quite common. Who would have predicted that 5 years ago?"

In addition, the development of multiscan gives CRTs a big edge over the competition. With a multiscan CRT, you can change from one resolution to another (by changing the graphics controller or mode) without having to replace the monitor.

The competing technologies are all fixed-format displays that are built for a specific resolution. Once you buy one, you're stuck with it. If you have a gas-plasma or LCD display and want to switch to a higher-resolution controller, you'll have to buy a new display, too. You can use these fixed-format displays at lower resolutions, however. For example, a 640- by 400-pixel display also supports 640- by 200- or 320- by 200-pixel resolutions (the maximum specified resolution must be evenly divisible by the supported lower resolutions).

#### LCDs

Once a "hold it just right and you can read it, sort of" laptop computer display, the LCD now competes favorably with parts of monochrome CRT technology and may eventually supplant the color CRT. The old problems of low contrast and poor readability in low ambient light are mostly behind us.

LCDs offer many advantages: small size, light weight, low power consumption, and good resolution, typically 640 by 480 pixels. But making large LCDs to compete head-to-head with CRTs is difficult. Manufacturing large LCD panels in which every pixel must be operable strains the fabrication capabilities of many companies. Prototypes are one

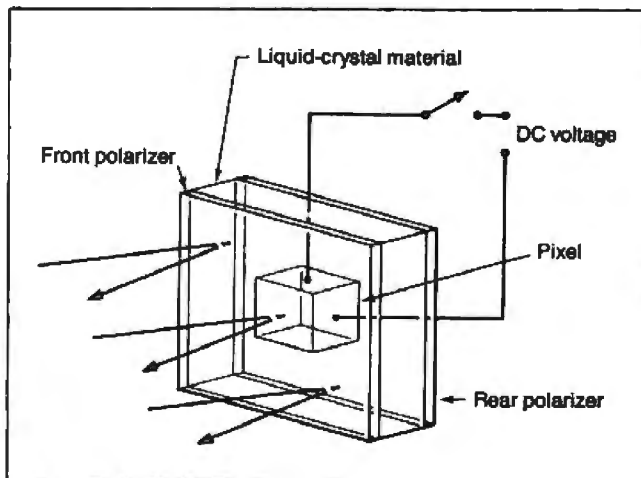

Figure 2a: When an LCD pixel is off, the polarized light reflects uniformly on the liquid-crystal material; thus, no contrast is created.

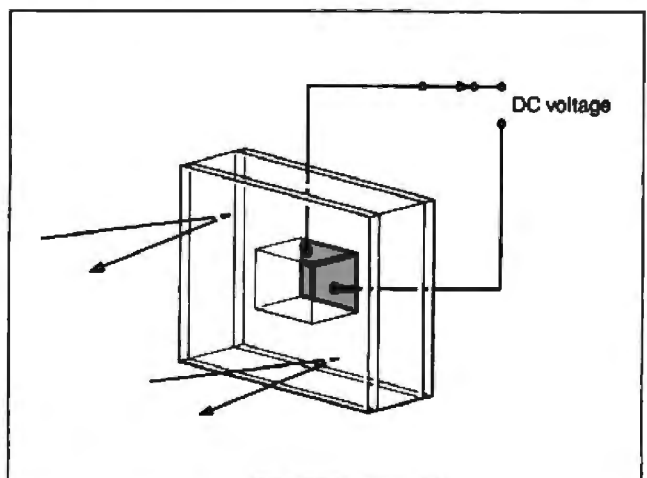

Figure 2b: When an LCD pixel is activated, it lets polarized light pass through it to strike a rear polarizer and be absorbed. The absorbed light appears dark.

thing; production runs are quite another.

Color LCDs currently are available only in relatively small sizes. Many are 4-inch diagonal (3½-inch viewable) displays with 480- by 220-pixel resolution and are used in portable TV receivers. Larger LCD color displays are the center of attention in the research and development departments of many companies.

An inherent advantage of LCD and other flat-panel technologies is their linearity. The screens are flat, unlike the CRT, and because the illuminating elements are addressed directly, there is no electron beam to deflect and distort.

Figure 2a is a simplified drawing of a typical twisted nematic-crystal monochrome display, probably the most common in use today. Nematic crystals are stable between liquid and solid and are responsive to electric fields, among other things.

The example LCD panel consists of a matrix of twisted crystal pixels that can be addressed via a row-and-column scheme. The crystals are sandwiched between two polarizers. In their normal twisted "off" state, the crystals modify the polarization of the light striking the panel so that most of it is reflected back; the panel color appears as the familiar uniform gray.

When voltage is applied (see figure 2b), crystal molecules untwist, changing the polarization of the incident light. When the light is able to pass through the crystals, it strikes the back polarizer and is absorbed; thus, the addressed pixel looks dark compared to the rest of the panel. Unfortunately, incident light scattered in the panel's layers and reflected back through them diminishes contrast.

The early problems with low contrast and poor readability have been nearly eliminated by using a rear-lighting, or

backlit, approach that does away with a dependence on ambient light.

Because of backlighting, reflective LCD displays are on their way out. In fact, so-called supertwist LCDs require backlighting to take advantage of their increased contrast, and it's often more appealing to have a light-emitting display. Also, color LCDs require backlighting. Still, it's a trade-off between readability and power consumption. A passive LCD panel uses a tiny amount of power, while the light source used for backlighting usually consumes many times the power required to control the liquid crystals.

In addition to the portable or laptop computer displays, an interesting and growing application for LCD panels is coupling a computer and an overhead projector. Whatever you have on your computer screen can be displayed on a portable window-like panel that sits on top of the projector in place of transparencies.

#### An Active Future

The most promising type of LCD is the recently developed *active-matrix* or thin-film transistor (TFT) LCD. Rather than using standard multiplexing techniques (e.g., time-sharing of pixel electronics drivers) to address the matrix of crystals, the active-matrix LCD includes a thin-film transistor fabricated along with each pixel. These transistors act as switches to turn on individual pixels.

The TFT method eliminates the time dependency associated with multiplexing (diminishing contrast as more lines are displayed) and allows direct addressing of each pixel. Color is added by using organic filters and backlighting.

Currently, active-matrix LCDs have primarily been produced for full-color

3½-inch pocket TVs. The Japanese produced some 2 million active-matrix LCD pocket TVs last year. At the Society for Information Display (SID) convention in May in Anaheim, California, several manufacturers displayed 9-inch active-matrix LCD screens.

The major obstacle to producing 9-inch and larger screens is the low throughput and poor manufacturing yield of current photomasking equipment. Defective panels have to be thrown away, and typical manufacturing yields are 20 percent. However, David Mentley says, "It's going to happen." According to his research, there are some 30 Japanese companies heavily investing in advanced-matrix LCD technology. Within a few years, we should see 9- and 11-inch advanced-matrix LCD monitors.

#### Gas-Plasma Displays

Gas-plasma displays operate by exciting a gas, usually neon or an argon-neon mixture, through the application of a voltage. Figure 3 shows the general construction ideas embodied in gas-plasma displays. The two types of displays are AC and DC. In both cases, a matrix of electrodes, separated by the gas, allows a certain point or pixel to be addressed.

By applying sufficient voltage at an addressed matrix intersection, the gas is excited, emitting an orange-red light. The DC type is simpler to construct but usually has an inherent background glow due to the continuously present DC voltage necessary for refresh. The AC version is more complicated to build but has no background glow or image-refresh requirements.

Because gas-plasma displays produce light, they need no backlighting. Still, they use more power than a backlit LCD.

*continued*

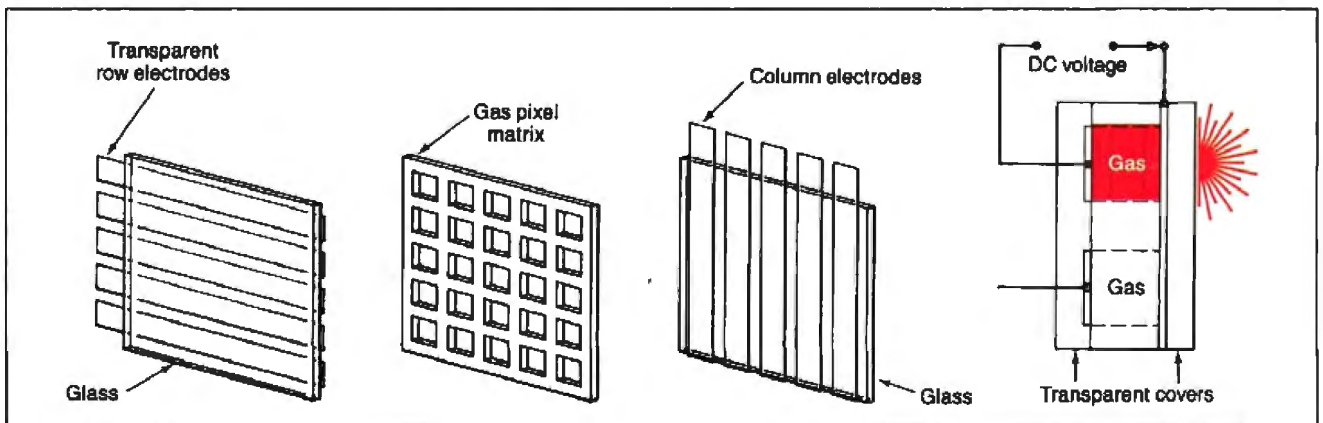

Figure 3: Gas-plasma displays use tiny pixels of gas to produce visible light. When sufficient voltage is applied at the intersection of two electrodes, the gas glows an orange-red.



Because of the need for operating voltages higher than normal, few battery-operated computers with this type of display have appeared. Manufacturers have to include converter circuitry to change the low voltage of the batteries to high voltage for the screen (about 200 volts for DC), and that adds power consumption, weight, and complexity.

Originally, gas-plasma technology provided only on-off control. Recent advances have improved control over the brightness of the pixels and provided several steps between the dimmest and brightest conditions, sort of an orange-red "gray" scale. Photo 2 shows a gas-plasma panel that offers both 4- and 16-step "gray" scales.



Photo 2: Gas-plasma displays can now display up to 16 levels of so-called "gray." (Photo courtesy of Panasonic Industrial Co.)

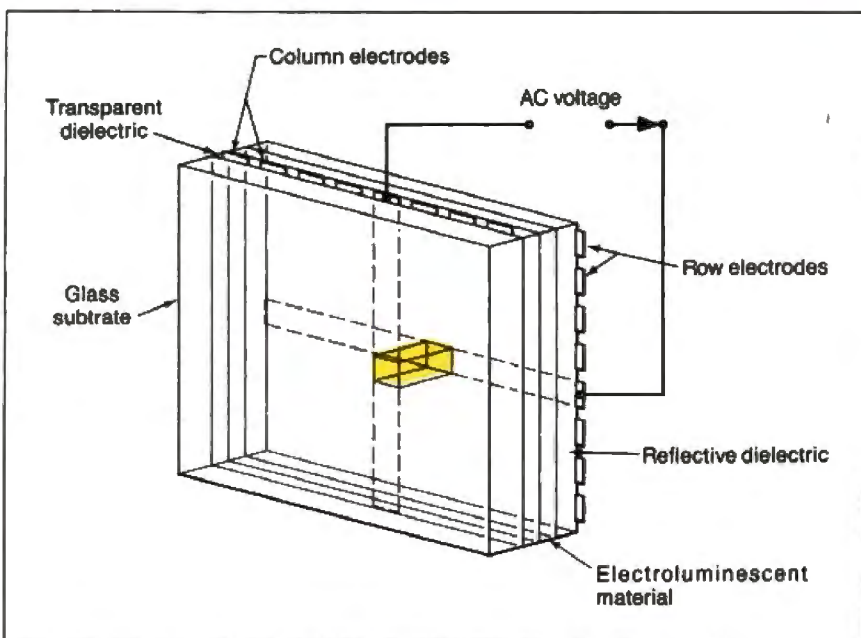

Figure 4: EL displays address pixels of EL material with electrodes. An AC voltage causes the material to produce its characteristic yellow light.

Gas-plasma displays have faced many problems. Their lack of full-color capabilities, their relatively short life span, and their cost have all contributed to their slow emergence. IBM's 17-inch gas-plasma display panel listed for about \$3300 in 1985, which is hardly competitive with CRTs. Another company recently bought the AC plasma technology from IBM and made some innovations in reducing driver count and power consumption, hoping to reduce the cost significantly.

At the May SID show, NHK Laboratories discussed its full-color 20-inch DC plasma panel intended for use in high-definition television. (This is another example of how television can drive the display-technology industry.) Also, Fujitsu has announced 8- and 15-inch color displays with 76,000- and 256,000-pixel resolutions, respectively. Most important, the company claims that the life expectancies of the new displays now match those of CRTs. As with LCDs, a great deal of effort will be expended before large, full-color gas-plasma panels are ready for mass marketing.

### EL Displays

EL displays operate on the principle of electroluminescence—phosphors emitting light in the presence of an alternating electrical field. EL displays are becoming increasingly popular in military and industrial applications requiring portability and reliability in hostile environments. Their truly solid-state construction makes them rugged.

A typical EL display consists of a thin film of EL material (phosphor) sandwiched between thin films of insulating dielectric material (see figure 4). The front material is transparent, while the rear material is reflective. The zinc-sulfide-with-manganese phosphor emits a bright yellow light when subjected to approximately 200 V AC. The voltage is applied via a grid of electrodes (also very thin), each pixel of which can be individually switched on. Other phosphors can be used for different colors.

EL displays range in size from 2 by 2 inches to 12 by 14 inches, with resolutions ranging from 320 by 128 pixels to 640 by 400 pixels. As with gas-plasma displays, a "gray" scale can be achieved by using a controller chip that provides that function. Planar Systems of Beaverton, Oregon, plans to introduce a 640- by 480-pixel display early next year. (See "Lighting the Way" on page 275 for additional information on EL displays.)

EL displays offer better contrast and

*continued*

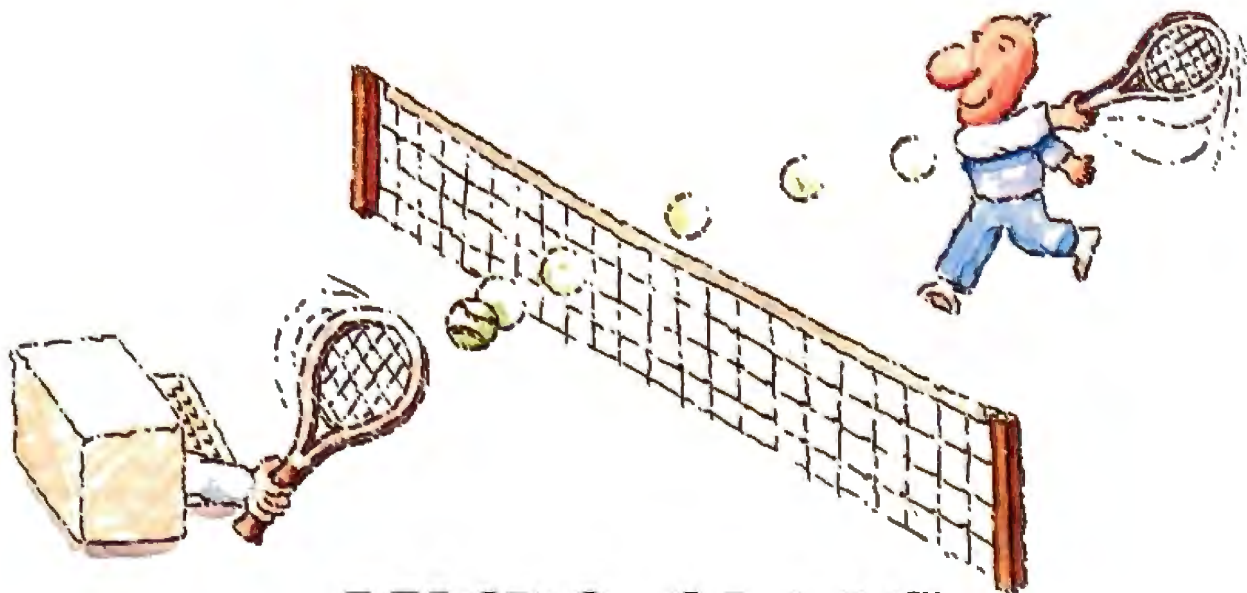

# MICRO-CAP II.™

## The CAE tool with fully interactive analog simulation for your PC.

Spectrum Software's MICRO-CAP II® is fast, powerful, and feature rich. This fully interactive, advanced electronic circuit analysis program helps engineers speed through analog problems right at their own PCs.

MICRO-CAP II, which is based on our original MICRO-CAP software, is a field-proven, second-generation program. But it's dramatically improved.

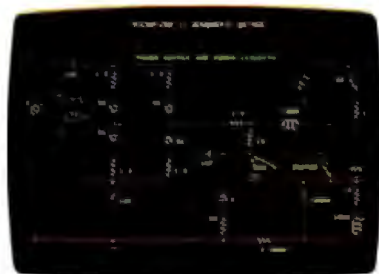

*Schematic Editor*

MICRO-CAP II has faster analysis routines. Better resolution and color. Larger libraries. All add up to a powerful, cost-effective CAE tool for your PC.

The program has a sophisticated integrated schematic editor with a pan capability. Just sketch and analyze. You can step

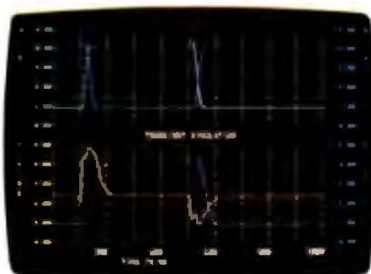

*Transient Analysis*

component values, and run worst-case scenarios—all interactively. And a 500-type\* library of standard parts is at your fingertips for added flexibility.

MICRO-CAP II is available for IBM® PCs and Macintosh.™ The IBM version is CGA, EGA, and Hercules® compatible and costs only \$895 complete. An evaluation version is available for \$100. Call or write today for our free brochure and demo disk. We'd like to tell you more about analog solutions in the fast lane.

- Integrated schematic editor
- Fast analysis routines
- High-resolution graphic output
- Standard parts library of 500\* types

\* IBM versions only.

- Transient, AC, DC, and FFT routines
- Op-amp and switch models
- Spec-sheet-to model converter\*
- Printer and plotter\* hard copy

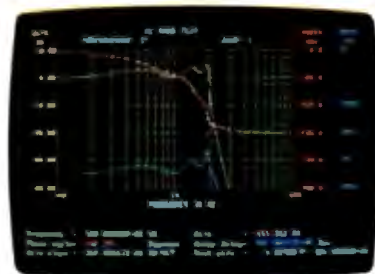

*AC Analysis*

**Spectrum**

1021 S. Wolfe Road, Dept. E  
Sunnyvale, CA 94087  
(408) 738-4387

MICRO-CAP II is a registered trademark of Spectrum Software.

Macintosh is a trademark of McIntosh Laboratory, Inc. and is being used with express permission of its owner.

Hercules is a registered trademark of Hercules Computer Technology

IBM is a registered trademark of International Business Machines, Inc.



broader viewing angles than gas-plasma and LCD displays. They use more power than LCDs but less than gas-plasma and considerably less than CRTs. As with gas-plasma, operating an EL display from batteries has its drawbacks.

In addition to being more compact and lightweight than CRTs, EL displays are much more reliable. Manufacturers claim an average mean time to failure of about 40,000 hours, in contrast to an average of 10,000 hours for typical CRTs.

While EL displays are rugged and feature excellent contrast, they are still quite expensive. A typical 640- by 400-pixel 12-inch EL display costs about \$400 to manufacture today, while an equivalent CRT costs under \$100. However, industry analysts expect the price of EL displays to drop to about half their present cost by 1990.

However, the EL display market is faced with the "chicken and egg" problem. The prices won't come down until the displays are manufactured and sold in larger volumes, and that's dependent on the prices coming down. According to spokespersons from Planar Systems, many workstation vendors are expressing greater interest in EL displays.

EL displays are still offered primarily in monochrome configurations. Full-color EL displays have been hampered by difficulties in producing a good blue phosphor. Planar Systems plans to offer

a red and green EL display for military applications in late 1989 and hopes to bring full-color displays to market by late 1990.

In spite of their appeal, EL displays are still at the high end of the market and are likely to remain so. The color problem is another obstacle to widespread acceptance. Since most commercial computers are priced extremely competitively, it's likely that many manufacturers will continue to opt for the lower-priced gas-plasma displays, while EL will remain the favorite in military applications and perhaps in high-priced workstations.

#### Chips Ahead

The consensus among display manufacturers is that, although some interdependency exists, the chips and controllers to drive the displays seem able to stay up with or keep slightly ahead of the actual light-producing displays.

This is evidenced by an announcement from Yamaha's Systems Technology Division concerning its new Enhanced Panel Display Controller chip. This 128-pin package will support IBM monochrome, CGA, EGA, NEC MultiSync, LCD, EL, and gas-plasma (with "gray" scale) in 640- by 200-, by 400-, and by 480-pixel, and 320- by 200-pixel modes. For 640 by 480 pixels, the package supports 16 colors. For the LCD's 320 by 200 pixels, it supports 8 colors. (For a

look at Texas Instruments' new graphics chip, see "Taking the Wraps off the 34020" on page 257.)

#### Back to the Future

Despite advances in display technologies over the years, information traditionally has been presented in a two-dimensional flat format. For most text-based applications, two dimensions appear to be enough. Humans are used to seeing in three dimensions, but often little is gained by adding depth to words and numbers alone. For just about everything else, however, three-dimensional displays make sense.

Experiments with three-dimensional displays go back to the stereoscopic viewers that used still photographs to add depth, proceeded through movies, and into television. Holography was once in vogue. In CAD and other real-world applications where a picture is worth a thousand words, a genuine need for three dimensions exists. As with most display systems, cost and image quality figure heavily into the future of such displays.

There have been many different approaches to three-dimensional displays, some involving mechanical motion and others strictly electronic. One solid-state approach from Tektronix in Beaverton, Oregon, uses special liquid-crystal shutter (LCS) eyeglasses synchronized with a CRT display.

Binocular vision—seeing two images from slightly different locations—contributes to our depth perception. Early attempts to exploit this used red and blue lenses and corresponding red and blue images. Other versions have employed polarized light, prisms, and lenticular screens.

With the LCS system, each side of the glasses worn by the viewer is alternately transparent and opaque while the corresponding image shifts slightly on the CRT screen. The viewer's retinas retain each image long enough to minimize the switching flicker and fool the brain. Having one eye see an image in a slightly different position than the other provides the three-dimensional illusion on a flat screen.

An intriguing approach to truly three-dimensional displays was demonstrated by Texas Instruments (TI) at the May SID show. A common drawback to LCS or polarized viewing of two-dimensional images to simulate three dimensions has been the limited viewing angle. As you move away from an ideal viewing position, usually directly in the center of the display, the depth illusion fades. Often

*continued*

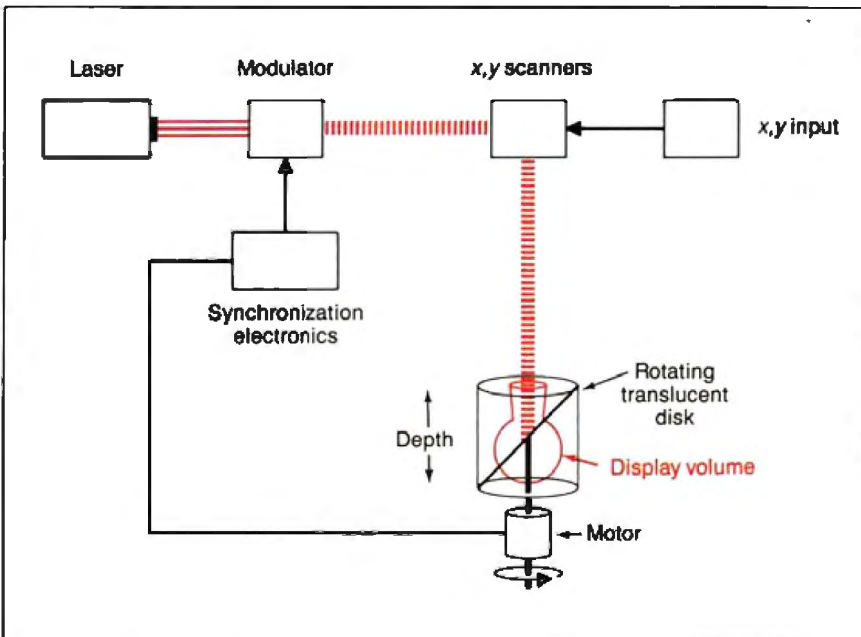

**Figure 5:** Will this be the wave of the future? A prototype display system uses a laser and rotating translucent disk to produce the elusive third dimension. (Diagram modified. Original courtesy of Texas Instruments, Inc.)



Actual retouched screen image.



Actual unretouched screen image!

## Screen stars with The Visible Edge.

What gives Princeton's new generation of screen stars the Visible Edge is a screen image of incomparable clarity and resolution. Where brilliant colors and infinite shades of gray, with striking contrast and dimension, are commonplace.

The versatility of the Princeton family of monitors gives the new generation (and present generation) of computers, the greatest autosynchronous horizontal/vertical scan range combination available (ULTRASYNC and MAX-15). The clarity of .28mm dot pitch (ULTRASYNC and PSC-28). 1024x750 display resolution (MAX-15). And the entire spectrum of color, with the ease and comfort that can only accompany an ergonomically designed monitor.

Experience a world of unlimited vision. And the technology that's made our high level of quality, service, value and performance, second nature. Experience the Visible Edge. And see what we do best. For more information call (609) 683-1660 x 100.

PSC-28



PSM-03



ULTRASYNC



MAX-15



Compatibility: IBM PC, XT, AT, PS/2, Apple Macintosh SE

Compatibility: IBM PC, XT, AT, PS/2, Apple Macintosh II, SE

**PRINCETON**  
GRAPHIC SYSTEMS  
THE VISIBLE EDGE

601 Ewing Street, Building A, Princeton, New Jersey 08540 (609) 683-1660

Circle 210 on Reader Service Card

NOW AVAILABLE FOR ULTRASYNC:  
AC-100 DATA CABLE FOR MAC II



## YOUR MACINTOSH™ CAN READ BAR CODES & MAGNETIC STRIPES



### with TPS ELECTRONICS' WEDGE READERS

- Connects on ADB or in series with keyboard cable
- Does not affect keyboard operation
- No additional port needed
- No card slot needed
- No extra software needed
- Completely transparent to any program; looks like keyboard input
- Most formats available
- *Also available:*
  - Bar code printing software
  - Magnetic encoders
  - Portable bar code readers
  - Readers for other micros and terminals

**TPS ELECTRONICS**  
4047 Transport Street  
Palo Alto, CA 94303  
415-856-6833  
Telex: (Graphnet)  
371 9097 TPS PLA  
FAX: 415-856-3843

## IN DEPTH FACE TO FACE



**Photo 3:** Artist's conception of a three-dimensional image produced using the laser system described in the text. (Photo courtesy of Texas Instruments, Inc.)

three-dimensional schemes also require some sort of special glasses or goggles.

Using an electromechanical approach as shown in figure 5, Don Williams of the User System Engineering Group at TI displayed a system that uses low-power laser light to project images onto a slanted 10-inch rotating translucent disk. The result is a "real-time, auto-stereoscopic, multiplanar three-dimensional display system" (patent pending).

In the \$10,000 proof-of-concept prototype, the disk rotates at between 400 to 600 revolutions per minute to synchronize with the laser light source. The rotation provides a translucent display volume into which a laser projects points of light. By scanning the laser in two dimensions on the rotating disk, a viewer's eyes fuse the points of light into a "solid" object. The resulting image can be viewed from any angle and has a resolution of 500 by 500 pixels and a 4-inch depth of field. Williams said that with larger disks and higher resolutions, bigger and better images can be generated, and by mixing red, green, and blue laser light, full color would also be possible.

A potential use of this system promoted by TI would be in air-traffic control. An entire airspace around an airport might be displayed, with air-traffic controllers able to walk around the scene, viewing it from different angles and heights, and identifying aircraft using small hand-held lasers (see photo 3). Williams is a human-factors engineer, and, for him, the driving force be-

hind three-dimensional displays is to come up with something that works well with humans.

### Going Up?

Considering the advantages of thin, lightweight displays and our affection for solid-state construction, it looks like flat panels could eventually replace CRTs, but don't count our old friend out yet. It's pretty commonplace to produce large, full-color display panels when cost is of little consideration. Reducing costs so that mass production is possible will take some time. And who knows what kinds of technological breakthroughs might launch another display scheme along the way and perhaps displace all the current contenders?

The synergy of physics, chemistry, and fabrication technologies seems to be taking display development along an exponential increase. The future is bright, in full color, and maybe even in three dimensions. ■

### ACKNOWLEDGMENT

Special thanks to David Mentley of Stanford Resources, Inc., a consultant on display technology based in San Jose, California.

Gene Smarte is West Coast bureau chief for BYTE in Costa Mesa, California. You can contact him on BIX as "gsmarte." Nicholas M. Baran is a BYTE technical editor in San Francisco. You can reach him on BIX as "nickbaran."

# Our Profile Will Make You Smile!



# Our Price Will Make You Happy!

## Introducing IntelliSync® The New Intelligent Multi-Frequency Monitor From 3LYNX®

It starts with the outstanding design features such as the small foot print, and streamlined profile (even slimmer than single frequency color monitors).

Next the IntelliSync is compatible with the CGA, EGA, VGA, and more, as well as being an excellent companion to all PC/XT/AT\*, Apple Macintosh II\*, and the new IBM PS/2\* systems.

The cost of IntelliSync is nearly 1/3 less than its major competitor. Most impressive is that it is manufactured by 3LYNX, a video display monitor manufacturer producing critical video components for the majority of the top FORTUNE 500 computer companies for years.

For information on the new 3LYNX IntelliSync Monitors call or write today. Call toll free 1-800-243-5969. Or 1-800-24-3LYNX. Fax # (408) 434-0466.



**IntelliSync Monochrome Monitor 15" flat screen with vivid gray scale.**

## IntelliSync The Best Choice

FEATURES	3LYNX INTELLISYNC	NEC MULTISYNC II*
Size	14"	14"
Front Controls	Yes	Yes
Auto Horizontal Frequencies	15.50-35KHz	15.50-35KHz
Tilt & Swivel	Yes	Yes
<b>Intellisync has incorporated all of the features of Multisync II plus more...</b>		
Auto Vertical Frequencies	45-120 Hz	50-80 Hz
Inverse Video Option in MDA Mode	Yes	No
Selection of Text Color	Auto	Manual
Color Text Options	7	3
Dimensions (mm)	341(w) 346(h) 386(d)	369(w) 357(h) 406(d)
Weight	29(lbs)	31(lbs)
Suggested Retail Price	\$695.00	\$899.00

# 3Lynx®

1450 Searcel Lane  
San Jose, CA 95131

\*Registered trademarks of their respective companies. 3LYNX and IntelliSync are registered trademarks of 3LYNX Technologies Corp.

Circle 3 on Reader Service Card

SEPTEMBER 1988 • B Y T E 253





# One Language For W

## BBX<sup>®</sup> Specifications:

**Ease-of-use**—BB<sup>x</sup> is the fastest, most powerful development tool available for business oriented program creation. Programmers can write code in minutes.

**Execution time**—BB<sup>x</sup>'s partially compiled format provides enhanced execution speed.

**Easy Maintenance**—BB<sup>x</sup> is an interactive programming language, with a trace facility and a full screen editor which makes program maintenance a snap.

**Portability**—BB<sup>x</sup> runs under UNIX and other operating systems without recompilation.

**Compatibility**—BB<sup>x</sup> is an enhancement of the Business BASIC language, an industry standard, giving you access to thousands of applications.

**Supportability**—Program maintenance utilities and complete documentation save considerable time and money. It lets you build and support applications easily.

**Utilities**—A complete set of BB<sup>x</sup> utilities are provided for program and file management.

**Conversion**—A complete set of conversion utilities are provided with every BB<sup>x</sup> package.

### Features

#### Math Functions

- 14 place precision and computational accuracy
- Floating point conversion
- Task specified rounding precision
- Binary to decimal conversion
- Long function names
- Dynamic arrays

#### String Functions

- Numeric to string conversion
- String manipulation
- No string length restriction

#### I/O Functions

- Windowing
- I/O mnemonics
- Device independent verbs
- X,Y cursor addressing
- Masking
- Soft key loads
- No record length restrictions

- BB<sup>x</sup> file sizes are limited only to the size of the available media

#### File Structures

- INDEX
- KEYED

- MIKEYED
- SERIAL
- SORT
- PROGRAM
- STRING

#### System Structure

- Multi-testing - which provides record and file level locking
- Program overlay
- Public programming which provides:
  - Local variables
  - Dynamically called sub-programs
  - Argument passing
  - Automatic public program drop from memory at exit
  - Public program in memory lock option

#### Language Structure

- Interactive program development
- Online syntax checking
- Compound statements
- User defined functions
- Unlimited nesting
- Remote I/O lists
- Program self modification
- Case insensitive console mode
- Various debugging tools

#### BB<sup>x</sup> Utility Set

- File Browse
- Create Data Bundle
- Calculator
- Clear Workspace
- Program Compare
- Copy File
- Define/Redefine File
- Directory Listing
- Erase File
- Generate Filelist
- Program List/Cross Reference
- Move File
- Program Renumbered
- Rename File
- File Resizer
- Execute O/S Shell Command
- Search and Replace Program
- Color & FUNC Key Setup
- Time/Date Examiner/Set
- Utility Menu
- Visual Utility Interface
- BXSND/BXRCV conversion utilities

Its portability crosses all operating environments, and now its performance is crossing all oceans.

Around the world, the industry's best and brightest programmers are discovering the astonishing power that BB<sup>x</sup> brings to Business BASIC. Write your program once, and have complete movement to MS/PC-DOS, OS/2, UNIX/XENIX, AIX, IX370 and VMS.

This year, over 50,000 copies of BB<sup>x</sup> are performing throughout the United States, Canada, Europe, Asia and South America.

Commitment to innovation, development within industry standards and technological leadership have grown BB<sup>x</sup> around the globe.

In 1988, aggressive marketing and uncompromising customer support will continue to compliment our success, and expand the BB<sup>x</sup> standard among many of the world's most respected companies.

Get in touch with one of our world distributors, and feel the pulse of the power of BB<sup>x</sup>!

Die Portabilität schlägt sämtliche, bisher bekannte und unbekannte, EDV-Umgebungen. Die Leistung überzeugt inzwischen die gesamte EDV-Industrie.

Weltweit entdecken die besten Software-Entwickler die besten erstaunliche Leistung von BB<sup>x</sup>, mit der Business BASIC bereichert wird. Die Anwendungen werden nur einmal entwickelt und laufen ohne Änderungen oder Anpassungen auf MS/PC-DOS, OS/2, UNIX/XENIX, AIX, IX370 oder VMS.

Mehr als 50.000 BB<sup>x</sup>-Lizenzen stellen die Leistung in den USA, Canada, Europa, Asien und Süd-Amerika unter Beweis.

Zur Innovation nach Industrie-Standard Spezifikationen verpflichtet, und mit dem Ziel nach technologischer Führung, wächst BB<sup>x</sup> um die Welt.

Mit aggressivem Marketing ohne Kompromisse im Bereich Kundenservice, wird der Erfolg von BB<sup>x</sup> in 1988 fortgesetzt. Es steht auf sämtlichen Systemen namhafter Computerhersteller zur Verfügung und stellt seine Akzeptanz bei den anspruchsvollsten Anwendern unter Beweis.

Kontaktieren Sie unsere Vertretungen in aller Welt. Entdecken Sie die Schlagkraft von BB<sup>x</sup>!

BB<sup>x</sup> PROGRESSION/2<sup>®</sup> is available for Intel Based Computers, Altos, Arete, AT&T, PCS Cadmus, Computer Consoles, Convergent Technologies, Counterpoint/MultiTech, Cubix, Data General, Digital Equipment, Fortune, Honeywell, Hewlett Packard, ICL, Motorola, Nixdorf, Prime, Pyramid, Raxon, Sanyo, Sequent, Siemens, Texas Instruments, Unisys, and the IBM family of products. BASIS is continually adding new systems.





# World Class Business.

Portable, il franchit tous les cadres d'opération, et sa performance traverse, maintenant, tous les océans.

Dans le monde, les meilleurs et les plus brillants programmeurs de l'industrie découvrent l'étonnante puissance que BB<sup>x</sup> amène au BASIC des affaires. Ecrivez votre programme une seule fois, et accédez totalement à MS/PC-DOS, OS/2, UNIX/XENIX, AIX, IX370 et à VMS.

Cette année, plus de 50 000 copies de BB<sup>x</sup> fonctionnent aux Etats-Unis, au Canada, en Europe, en Asie et en Amérique du Sud.

Un esprit constant d'innovation, un développement conforme aux normes de l'industrie, et une position de leader dans le domaine technologique, tels sont les atouts qui ont contribué à la croissance de BB<sup>x</sup> dans le monde entier.

En 1988, un marketing dynamique et un appui inconditionnel à notre clientèle continueront à couronner notre réussite, et à étendre le standard BB<sup>x</sup> à de nombreuses sociétés parmi les plus respectées au monde.

Contactez l'un de nos distributeurs mondiaux et découvrez la puissance de BB<sup>x</sup>!

Su portabilidad traspasa todos los medios de operación y ahora su funcionamiento esta cruzando todos los océanos.

Los mejores y más brillantes programadores del mundo, están descubriendo la asombrosa potencia que BB<sup>x</sup> ofrece al negocio BASIC. Escriba su programa una vez y tenga movimiento completo a MS/PC-DOS, OS/2, UNIX/XENIX, AIX, IX370 y VMS.

Este año, más de 50,000 copias de BB<sup>x</sup> estan funcionando en Estados Unidos, Canadá, Europa, Asia y América del Sur.

Empeño de innovación, desarrollo en los estandards de la industria y superioridad tecnológica han hecho crecer a BB<sup>x</sup> en todo el mundo.

En 1988, mercadotecnia agresiva y apoyo constante a nuestros clientes seguirán complementando el éxito y desarrollo de BB<sup>x</sup> entre las compañías más respetadas del mundo.

Comuniquese con uno de nuestros distribuidores mundiales y sienta la potencia de BB<sup>x</sup>!

## World Distributors:

**Belles Hans Kirehneff & Co. KG**  
Pingstbornstr. 25, 6200 Wiesbaden  
West Germany  
TEL: (06122) 2016  
FAX: (06122) 16505  
TLX: 416-2563 edie d

**Mattleys**  
Torgar Vraas Plaza SA  
3044 Drammen Norway  
TEL: (03) 83-86 05  
FAX: (03) 89 02-53

**J. F. Brown and Associates**  
780 Gordon Baker Road  
Willowdale, Ontario M2H 3B4  
TEL: (416) 494-0472

**PI Informatique**  
8, rue Benjamin Constant  
75019 Paris, France  
TEL: (01) 40 05 10 65  
TLX: 214 583  
FAX: (01) 40 05 99 63

**Softech Pty. Limited**  
10 Eileen Road, Blagowrie  
Randburg 2194, South Africa  
TEL: (011) 787-8539  
FAX: (011) 886-3880  
TLX: 422869 S.A.

**Risegold Pty. Ltd.**  
678 Paramatta Road  
Croydon, N.S.W. 2132  
Australia  
TEL: (02) 789-6622  
FAX: (02) 799-3090

**Tampo Computadoras**  
Av. Americas #670  
Guadalajara 44680  
Jalisco, Mexico  
TELS: 30-29-45  
30-29-46  
30-28-66

**In the United States:**  
**BASIS Incorporated**  
P.O. Box 20400  
Albuquerque, New Mexico 87154  
TEL: (505) 821-4407  
FAX: (505) 821-1625

West Germany, The Netherlands  
Austria, Switzerland  
Denmark, Luxembourg, Belgium  
England, Italy

Norway, Sweden, Finland,  
Greenland, Iceland

Canada

France, Spain, Portugal

South Africa

**Risegold Pty. Ltd.**  
86 Havelock Street  
West Perth  
Western Australia 6005  
TEL: (09) 481-0607  
FAX: (09) 481-3162

**Infotel, S.A., de C.V.**  
Laguna de Mayran  
No 256 3 piso  
Col. Anahuac C.P. 11320  
Mexico, D.F.  
TELS: 05 45 6730 et  
05 45 6734

Australia

Mexico

**BASIS**  
INCORPORATED

BB<sup>x</sup> PROGRESSION/2<sup>m</sup>, BB<sup>x</sup> and BASIS Incorporated are trademarks and/or service marks of BASIS Incorporated, Albuquerque, New Mexico. All references to computer systems and software products contained within this advertisement recognize the trade and/or service marks of the corresponding manufacturer and holder of the trade and/or service mark.

Circle 316 on Reader Service Card

**10% DISCOUNT!**  
ANY ORDER BY A NEW CUSTOMER, ACCOMPANIED  
BY THIS ADVERTISEMENT, QUALIFIES  
FOR A 10% DISCOUNT.  
Call TOLL FREE directly to our  
Order Department.  
**1-800-423-1394**  
BSP







# Taking the Wraps off the 34020

*A trio of chips that puts workstation power  
on a small board*

*Ron Peterson, Carrell R. Killebrew Jr., Tom Albers, and Karl Guttag*

**T**he new TMS34020 32-bit graphics microprocessor (the '20) is well suited to workstations and personal computers requiring highly interactive user interfaces. The '20 is also suited to laser printers, which are becoming more performance-hungry, with requirements for on-the-fly font compilation, and the increased complexity of page-description languages, which are constantly demanding more performance.

Data and image compression such as facsimile and CD-ROM are other areas where the '20 will find ready applications, since fast bit-addressable processors provide inherent advantages over general-purpose processors for performing the Huffman-type encoding and decoding necessary for CCITT Groups 3 and 4 fax standards. In fact, for TMS340 Graphics System Processors (GSPs), fax-type compression and decompression is just another program (i.e., no additional hardware is required).

#### **A Chip off the Old Block**

The '20 is the newest member of Texas Instruments' (TI) TMS340 GSP family.

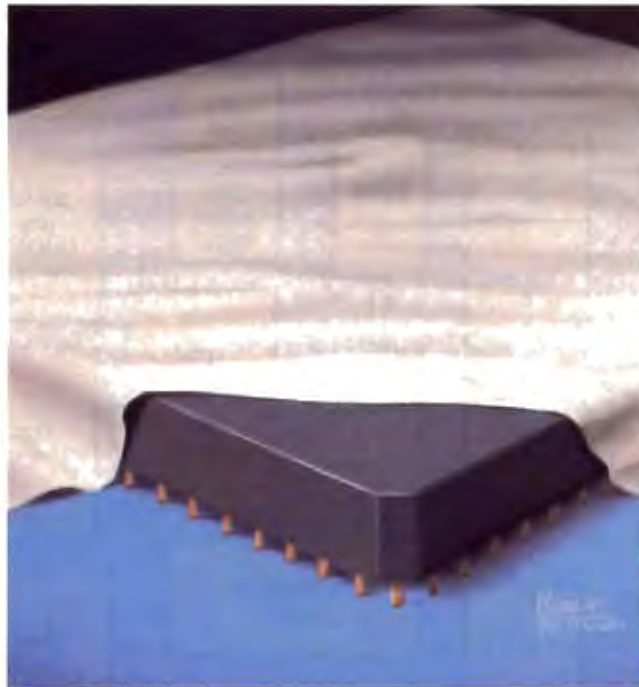

Depending on the instruction mix, it's between 6 and 50 times faster in key graphics operations than its predecessor, the TMS34010 (the '10). The '20 runs at 10 million instructions per second (MIPS) when executing from its 512-byte instruction cache. It's designed to connect directly to a second '20 as well as to the 40-million-floating-point-operation-per-second (MFLOPS) TMS34082 graphics

floating-point coprocessor (the '82 FPU). The '20 has instructions that can perform pixel- or bit-aligned block transfers at 142 megabits per second, and when using the TMS44C251 1-megabit video RAM (the 44C251 VRAM), the '20 can execute fills at up to 1.136 gigabits per second.

The '20 has all the architectural features that define TI's TMS340 GSP family (see figure 1). These features include a host-bus interface, a local-bus interface with semi-autonomous memory controller, a display-control interface and registers, instruction cache, 31 32-bit registers, single-cycle general-purpose instructions, and multiple-cycle graphics instructions. (For details on the '10, see "The TMS34010 Graphics System Processor" in the December 1986 BYTE.)

The '82 FPU is based on the same design used by many bit-slice graphics workstation engines. It directly connects to the '20's coprocessor interface and has external expansion for both microcode and data.

The '20 has also been designed to take full advantage of the features of the 44C251 1-megabit VRAM. These im-

*continued*



provements allow faster fills, masked operations, and text without resorting to the expense of the wide data buses used in many workstations.

**Theory of Evolution**

The concept of a graphics engine designed around a fully programmable microprocessor is what made the '10 different from other graphics chips and has led to the TMS340 family's success. The device differs from a normal microprocessor in the special hardware and microcode included to support bit-mapped graphics operations. It also integrates graphics system-control features for the CRT, dynamic RAM (DRAM), and VRAM onto one device. The underlying goal in this design was to let the

flexibility of bit-mapped graphics be matched by the flexibility of a graphics processor.

The definition of the '20 began during final development of the '10. Features that were too expensive or that would cause major schedule delays on the '10 were slated for implementation on the '20. The first issue was to obtain an overall speed improvement over the '10. This began with the obvious expansion of the '10's 32-bit internal and 16-bit external busing to a full 32 bits for both on the '20.

With the addition of 32-bit pixel and 32-bit external bus support, several graphics features have been enhanced on the '20. Pixel-formatted registers are expanded from 16 to 32 bits in significance; these include the color-expand

registers and the plane-masking register. Other enhancements include improving the processor cycle time and utilizing the fast page mode of DRAM. Also, the instruction cache was doubled to 512 bytes on the '20 to reduce cache misses and let larger algorithms fit into the cache.

New capabilities were also added. Three-operand block transfers were needed by both laser-printer manufacturers dealing with large textured objects and system developers building extensive window environments. Many system designers using the '10 had requested better support for direct host access to the TMS340's memory, and some of the more sophisticated applications required the graphics processor to do operations

*continued*

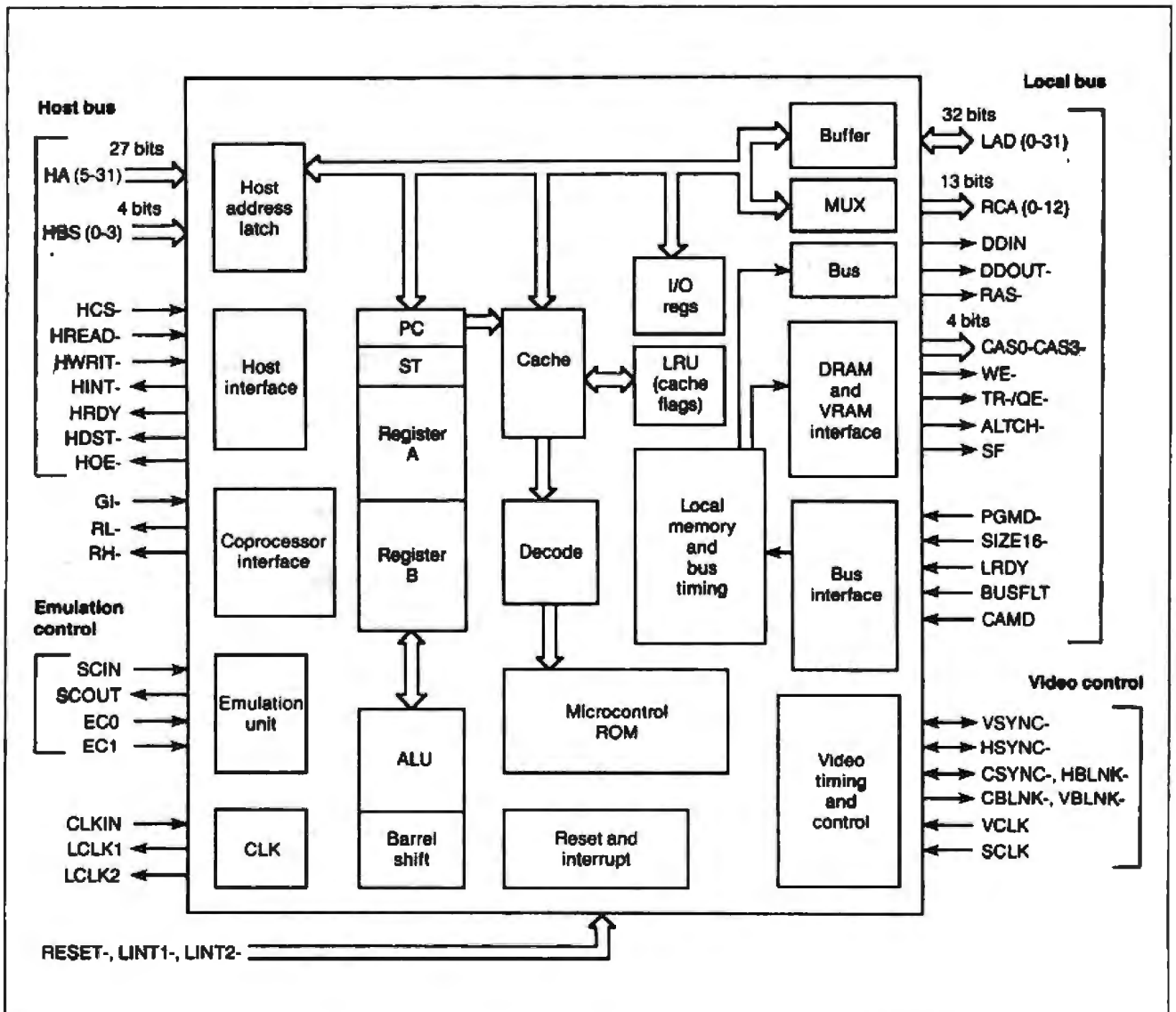

Figure 1: The TMS34020 block diagram. Note the coprocessor interface and the built-in host attachment capabilities.

# THE WORLD'S BEST-SELLING DRIVE

Field-proven  
30,000 hour  
MTBF



## THE ST225

Proven reliability. That's the reason Seagate's 20 MB half-height hard disc drive is so popular, with over 3 million sold in less than three years.

Who proved it? Millions of computer users around the world. They've benefited from our continued design and manufacturing improvements. And they've proved that the ST225 has an MTBF of 30,000 hours.

Which means years of uninterrupted performance. And a disc drive you can rely on.

Reliability has helped make Seagate the world's leading independent manufacturer of 5¼" and 3½" hard disc drives.

If you're looking for a proven 20 megabyte drive, ask for the ST225. Call Seagate at 800-468-DISC. Put the best seller to work for you.

 **Seagate**

The first name in disc drives.



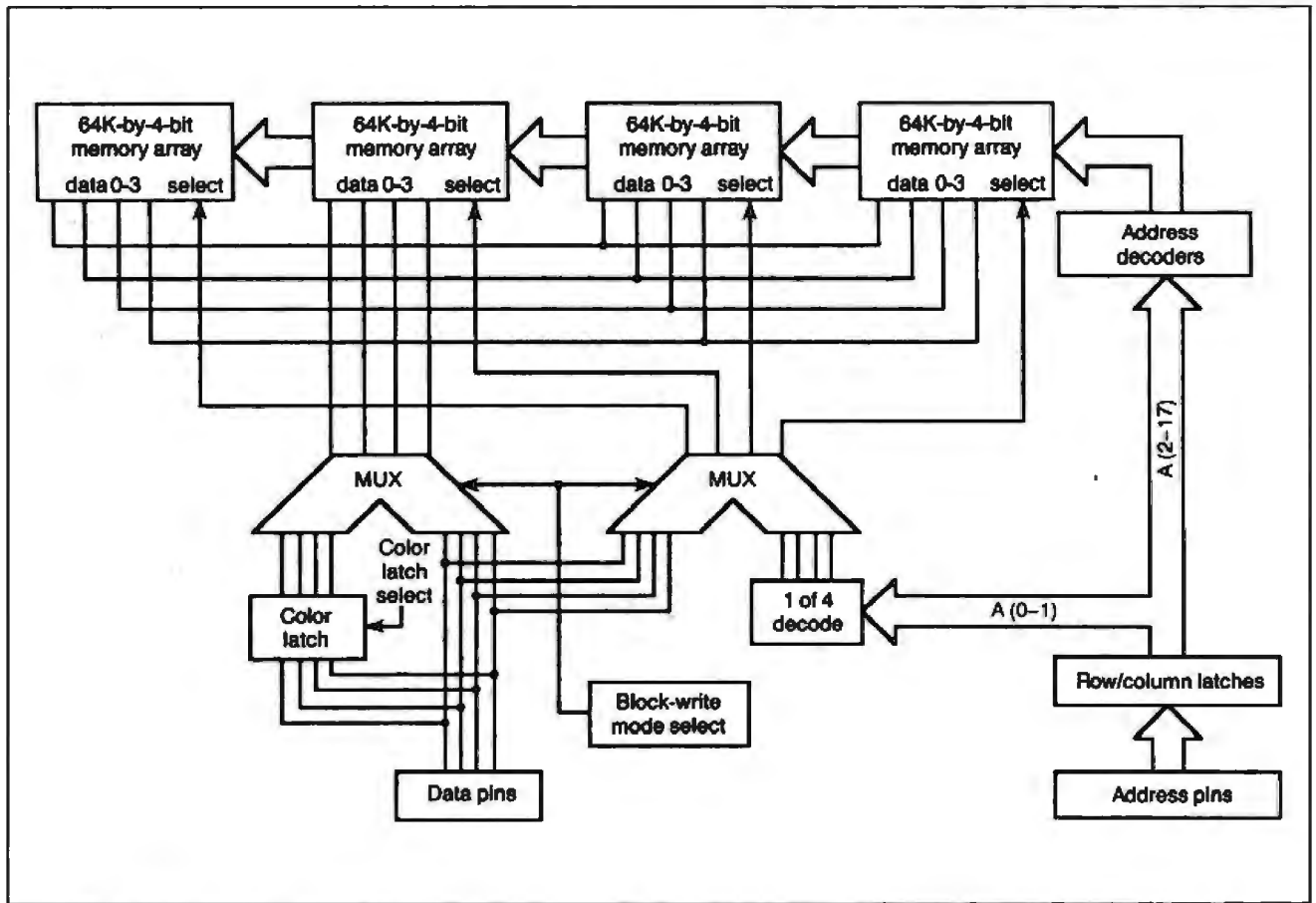

Figure 2a: TMS44C251 VRAM internals. Notice the four banks of 64K-by-4-bit memory, for a total internal width of 16 bits.

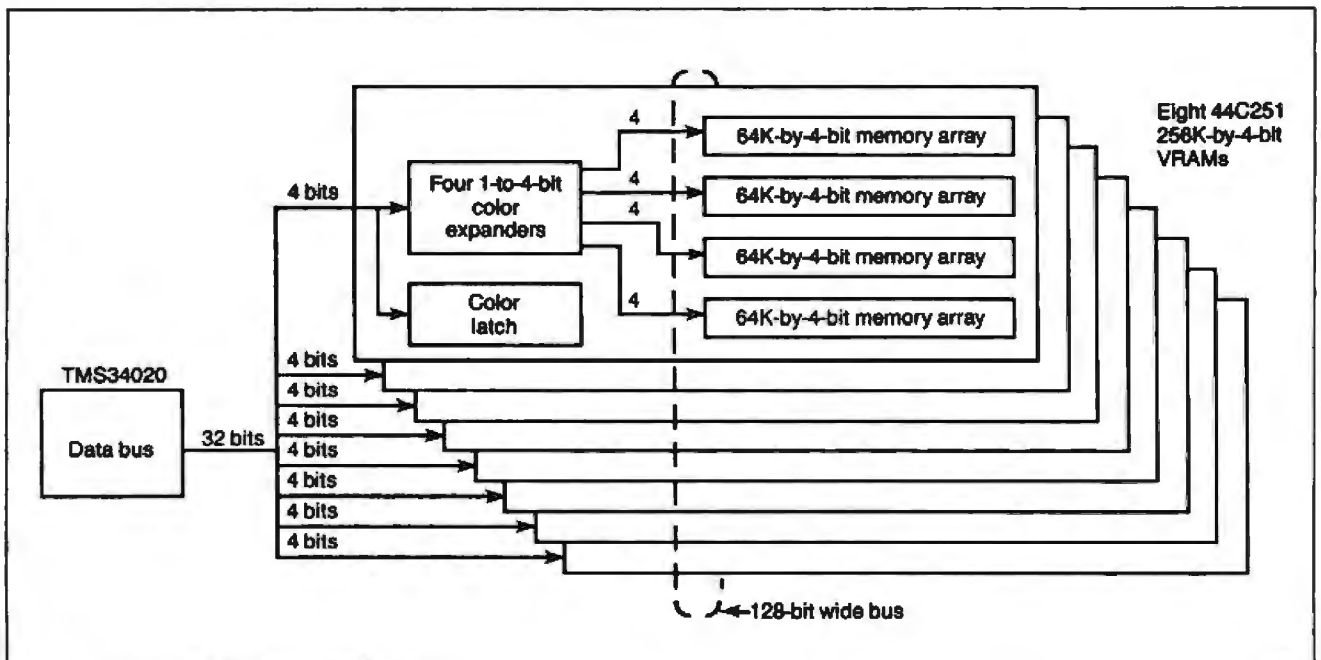

Figure 2b: An overall picture of the 44C251 and its connection to the '20. Notice how the '20 expands the 32-bit data path to 128 bits wide inside the VRAM.

# Compose Yourself!

Now create superb sounding music on your IBM® PC. Ad Lib™ makes it easy.

Just when you thought you'd heard it all, along comes Ad Lib.

And with it comes rich, room-filling music like you've never heard from a PC before. With rumbling bass, crystal clear highs, up-front mid-range. All of it composed and performed on the first complete PC music system for people like you — long on desire, a little short on experience.

The heart of the system is the Ad Lib Music Synthesizer Card.™ An electronic sound synthesizer based on the same digital technology found in professional keyboards and the finest music computers.

Just plug it into your PC and get clean, powerful music through high fidelity headphones, bookshelf speakers, even your home stereo. It'll handle up to eleven different instrument sounds playing at once, so it's perfect for anything from a solo to a symphony.

There's also Ad Lib Visual Composer,™ about the most instinctive composition software ever devised. Simply draw lines to indicate notes, using the on-screen piano keyboard as a guide. Change instruments, tempo and volume with a couple of keystrokes. Cut, copy and paste portions of your music in a snap.

Included with the program is Composition Projects™ #1, a step-by-step guide to creating all kinds of music, including classical, jazz, bossa nova, ragtime, and more. Just the thing for an ever-expanding repertoire.

Visual Composer is worth \$89.95 if purchased separately, but it's yours free when you buy the system.

Then play back all of your creations, as well as several pre-programmed selections, on the Juke Box™ playback software, also included with your system.

Look for the Ad Lib Personal Computer Music System™ at selected computer and music stores, or order direct from Ad Lib with your check, Visa or MasterCard.



The Ad Lib Personal Computer Music System. At last, you have what it takes to make great-sounding music.

**The Ad Lib Personal Computer Music System.** Includes the Ad Lib Music Synthesizer Card, Juke Box playback software, free Visual Composer software with 50 pre-set instrument sounds and Composition Projects #1 ..... \$245.00

Enhance your system further with this additional Ad Lib software:

**Music Championship™ #1 — Basic Concepts.** Learn to identify basic musical concepts, including tempo, mode, rhythm and key. Perfect for all ages. The first in a series of music training programs combining syn-



thesized music with exciting computer game competition . . . \$39.95

**Instrument Maker software.** Lets you create and save new instrument

sounds for use with Visual Composer. Alter 23 sound characteristics like attack, sustain and decay. Modeled after professional music synthesizer software . . . \$49.95

Look for more Ad Lib music software titles coming soon.

Requires IBM PC, XT, AT or compatible, 256K RAM, CGA, EGA, or MGA.

For the name of your nearest dealer and a free demonstration recording, or to place an order, call us toll free today from either the US or Canada.

Ad Lib Inc.  
50 Staniford Street  
Suite 800  
Boston, MA 02114



**Ad Lib™**  
Personal Computer  
Music System

Circle 7 on Reader Service Card

# 1-800-463-2686



in the host's memory space.

As a result, the host interface was totally revamped for the '20. Better CRT timing control was added to the display controller to enable broadcast-quality RS170 National Television System Committee (NTSC) timing. New *XY* addressing support and improved VRAM control were also added to pack together frame-buffer scan lines for better memory utilization. The '20's VRAM support takes advantage of the 1-megabit

VRAM's split shift register as well as the older (and less efficient) 256K-bit VRAM's midline reloading.

The '20 has enhanced the *XY* addressing support of the '10 to include direct support for *pitches* other than binary for the *XY* address space. (Pitch is the distance between pixels on corresponding lines.) Both pitches that are the sum of two powers of 2 ( $A + B$  where both  $A$  and  $B$  are powers of 2) and completely arbitrary pitches are supported. This makes

the coding of output routines into linear memory and instruction support for packed screen organizations much easier. In addition, both  $X$  and  $Y$  values on the '20 are treated as signed 16-bit numbers.

The definition of the '20 has gone far beyond its own chip boundaries to include the development of an extremely fast graphics floating-point coprocessor, the '82. This processor is 30 to 100 times faster than the typical microcomputer's FPU. (See the text box "The Class of '82" on page 264.)

The '20 project team also worked closely with TI's memory-design engineers to allow the '20 to distribute some processing within the new 1-megabit VRAM, the 44C251. (See the text box "Making Videos" on page 272.) Coordination between the development programs and the resulting cooperation between these three chips enables simpler system design and higher performance.

#### A Marriage of Convenience

Since the '20 and the 44C251 1-megabit VRAM definitions were coordinated during development, the '20 supports performance and system features added to the 44C251. The designers of the '20 had the advantage of knowing and influencing the definition of the VRAM, so the two architectures fit together.

The importance of that joint definition can be seen most clearly with the block-write mode (BWM). The 44C251 has four banks of 64K-by-4-bit memory, for a total of 16 bits wide internally (see figure 2a). In normal mode, the two least-significant bits of the address select one of four banks—only one can be selected at a time—and the four data lines provide the data. In BWM, the four data lines used enable writing to any and all combinations of the four banks within each 44C251, and the special color-latch data is multiplexed to provide the data when it's written. The '20 controls the 44C251 to expand the 32-bit data path to 128 bits wide inside the VRAM (see figure 2b).

The BWM function is modeled after the TMS340 family's "binary to color expand" function. Color expansion works by turning data into control signals that select whether or not to write a color. Since each data line controls a multiple-bit color value, we use the term "color expansion."

Both the '20 and the '10 have flexible color expanders that turn 1-bit-per-pixel shape information into 1, 2, 4, 8, or 16 bits per pixel. The '20 extends this function to 32 bits per pixel. This function,

*continued*



Everything you see here...

12 MHz 80286  
AT-Compatible  
1Mb on-board DRAM  
Full set of AT-compatible controllers  
EGA/CGA/MDA/  
Hercules compatible  
HD/FD controllers  
...and more

you see here.

THE LITTLE BOARD™/286

#### Big

power for smaller systems.

Little Board/286 is the newest member of our family of MS-DOS compatible Single Board Systems. It gives you the power of an AT\* in the cubic inches of a half height 5¼" disk drive. It's a complete AT-compatible system that's functionally identical to the 5-board system above. And it runs all AT software.

Ideal for embedded applications. Its low power requirement, wide operating temperature range, solid-state disk support and tiny form factor make Little Board/286 perfect for embedded applications and harsh environments: controllers, data acquisition, instruments, telecomm, workstations... anywhere small size and complete AT hardware/software compatibility are important.

Better answers for OEMs. Little Board/286 is not only a smaller answer, it's a better answer... with the packaging flexibility, low power, I/O capabilities and pricing OEMs need. For information and the name of your nearest U.S. or international Ampro rep, call us today. Or, write for Little Board/286 product literature.

Compare features. Both systems offer:

- 12MHz CPU
- 512K 1MByte onboard DRAM
- 80287 coprocessor option
- AT-compatible controllers and bus expansion
- Floppy disk controller
- EGA/CGA/MDA/Hercules video options

But only Little

Board/286 offers:

- 5.75" x 8" form factor
- SCSI device support: Hard disk, tape, bubble drives, etc.
- Two byte-wide sockets for on-board solid-state disk support
- Single voltage (+5VDC only), 8W power consumption
- 0-60°C operating range

\*Trademark AT & PC—IBM Corp. Hercules—Hercules Comp. Tech., Inc. MS-DOS—Microsoft Corp. Little Board—Ampro Computers, Inc.

408-734-2800

Fax: 408-734-2939 TLX: 4940302

**AMPRO**  
COMPUTERS, INCORPORATED

1130 Mountain View/Alviso Road  
San Jose, CA 94089

Reps: Australia - 61 3 720-3296, Belgium - 32 87 469012, Canada - (804) 438-0028, Denmark - 45 3 66 20 20, Finland - 358 0 585-322, France - 331 4502-1800, Germany, West - 49 89 811-6151, Israel - 972-3 49-16-95, Italy - 39 6 811-9406, Japan - 81 3 257-2630, Spain - 34 3 204-2099, Sweden - 46 8 56-00-65, Switzerland - 41 1 740-41-05, United Kingdom - 44 2 964-35511, USA, contact AMPRO.



# NEW Graphics Solution™

## Make a Great Impression

How do you make a great impression in an industry where everything is so impressive? We made it with the Graphics Solution, a multi-purpose Monochrome-Color Graphics Card. Displaying Color Graphics, Games or the latest Software Applications on either Monochrome or RGB monitors are not the only features of the Graphics Solution. It's ease of use

Circle 21 on Reader Service Card



which has made this card so attractive to hundreds of thousands of Computer users. The ability to display spreadsheets and word-processing in the wide screen format of 132 columns is another of its many impressive features. Uncomplicated and dependable, just what

you're looking for?

Check it out; even the price will impress you.

Available at all leading Computer dealers.



**TECHNOLOGIES INC.**

Technology you can Trust.

ATI Technologies Inc.  
3761 Victoria Park Ave.  
Scarborough Ontario Canada  
M1W 3S2  
Tel: (416) 756-0711  
Telex: 06-966040  
Fax: (416) 756-0720



## The Class of '82

The 34082 is a high-performance graphics floating-point coprocessor developed exclusively for the 34020. Integrating a microsequencer, register file, floating-point ALU, and multiplier onto one chip (see figure A), and supporting high-level graphics instructions, the '82 can execute floating-point operations at up to 40 MFLOPS.

The register file on the '82 consists of 22 64-bit registers. The file has 10 A-file registers and 10 B-file registers for data storage and two C-file registers for feedback. This large register file lets complex algorithms store intermediate results internal to the device, thereby reducing the memory cycles necessary to reload these operands for future cal-

culations. The device also incorporates a local bus for storing up to 64K 32-bit words for data and microcode expansion. This expansion memory lets you develop your own functions or store data local to the '82.

Using the '20's coprocessor interface, the '82 directly interfaces to the '20 with no "glue" logic, letting the '82 be either initially designed into the system or socketed for later addition. This interface allows connecting up to four '82s to the '20. The '20 provides a general coprocessor interface to let the external implementation of advanced functions improve performance. The '82 is one example of a coprocessor taking advantage of this interface for per-

formance increases. The interface consists of five basic cycles for data communication and control:

1. Move data from '20 register to coprocessor.
2. Move data from coprocessor to '20 register.
3. Move data from memory to coprocessor (indirect '20 register move).
4. Move data from coprocessor to memory (indirect '20 register move).
5. Execute coprocessor command.

Not only does it support fully compatible IEEE Standard 754-1985 additions, multiplications, divisions, square roots, and comparisons, the '82 has instruc-

Figure A: TMS34082 floating-point coprocessor block diagram. Notice the 22 64-bit registers internal to the chip.

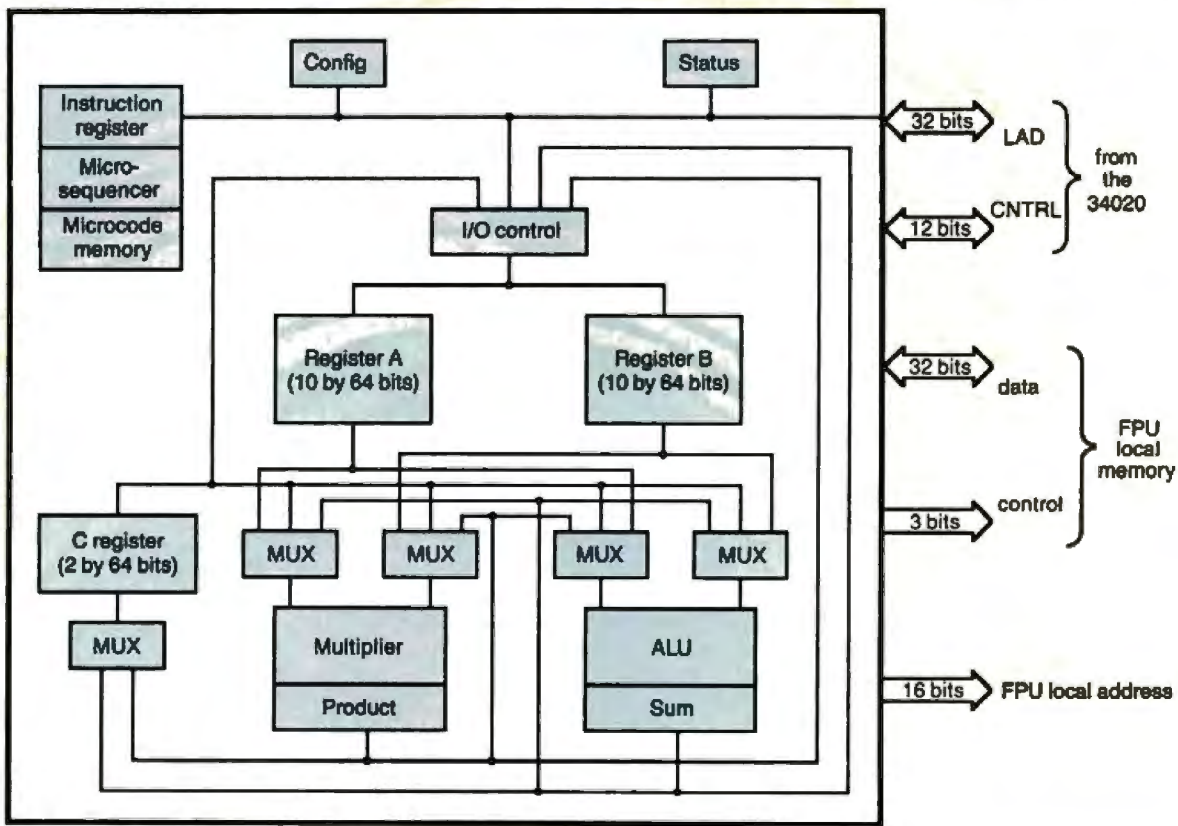

widely used in bit-mapped color graphics, would be very tedious without hardware help.

Although the BWM has the potential to give an additional performance increase of four times or more for fills and color text, it requires special addressing and control- and data-mapping hardware built into the '20. The mapping hardware makes writing pixels into the memory

consistent with how they would be written without BWM and can be thought of as the "key" that unlocks the block-write feature.

When using the BWM, you can think of each 44C251 VRAM as having four 1- to 4-bit fixed color expanders in it; in other words, each memory can expand 4 bits of incoming data or control information into 16 bits. By combining two

VRAMs (to get an 8-bit-wide color latch and expander), you can get four 1- to 8-bit expanders.

By using the '20's color-expander hardware plus additional on-chip hardware to generate the control signals necessary to interface to the VRAMs, the '20's 32-bit data bus is effectively expanded to 128 bits during BWM cycles. The '20 also supports the color-expand



tions for complex graphics math. Table A gives a complete list of instructions. And the expansion capability of the '82 allows for the creation of an indefinite number of user-defined functions.

**Table A: Capabilities of the 34082 FPU instruction set.**

**One-operand operations**

Absolute value      1's complement  
Square root          2's complement

**Two-operand operations**

Add                      Divide  
Subtract                Compare  
Multiply

**Conversions**

Integer to single      Single to integer  
Integer to double      Double to integer  
Single to double        Double to single

**Matrix operations**

4x4, 4x4 multiply      3x3, 3x3 multiply  
1x4, 4x4 multiply      1x3, 3x3 multiply

**Graphics operations**

Backface testing  
Polygon clipping  
Polygon elimination  
Viewport scaling and conversion  
2-D linear interpolation  
2-D window compare  
2-plane clipping (X,Y,Z)  
2-D cubic spline  
3-D linear interpolation  
3-D volume compare  
2-plane color clipping (R,G,B,I)  
3-D cubic spline

**Image processing**

3x3 convolution

**Chained operations**

Polynomial expansion  
1-D minimum/maximum  
Multiply/accumulate  
2-D minimum/maximum

**Vector operations**

Add                      Dot product  
Subtract                Cross product  
Magnitude              Normalization  
Scaling                  Reflection

function for memories without BWM, which still gives an improvement that is roughly 10 times that of microprocessors without color-expand hardware.

Two special instructions were added to the '20 to take advantage of the BWM. VFILL is used for fast solid filling. The VBLT instruction reads binary shape information and controls the VRAM for

*continued*

# The Grand Canyon of the Arctic

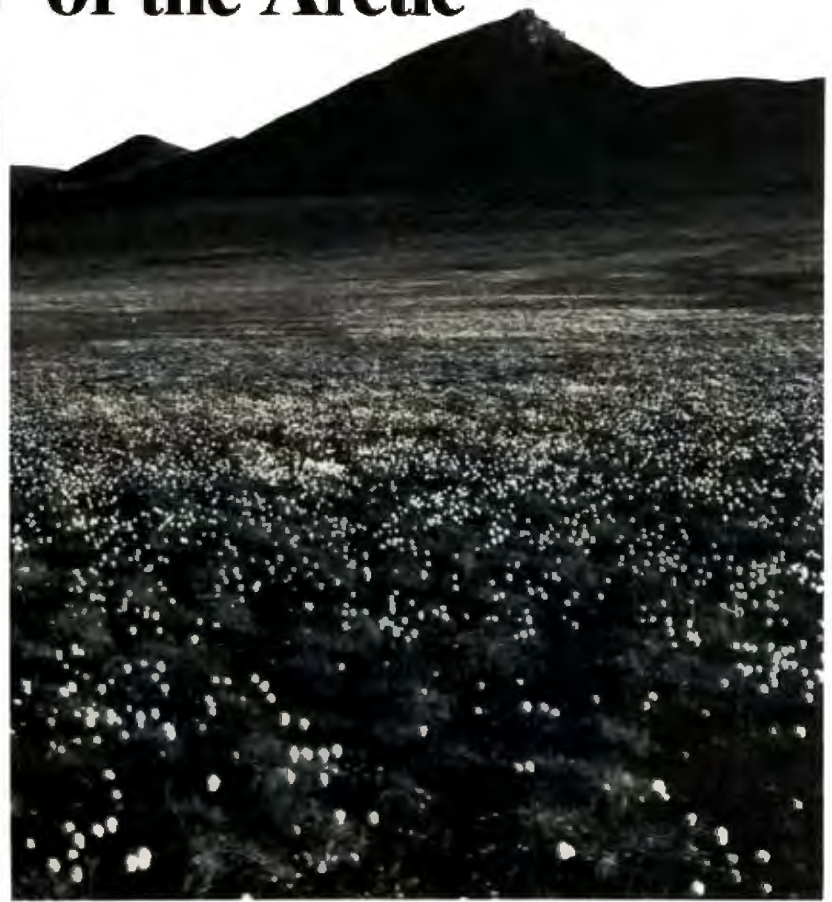

Dennis & Debbie Miller

In Alaska there's a place as magnificent and rare as the Grand Canyon—the Coastal Plain of the Arctic National Wildlife Refuge. More animals than you could ever see in Yellowstone live and migrate through there.

The oil companies want permission from Congress to drill on the Coastal Plain (even though the odds are four in five that there's no oil). That's like damming the Grand Canyon for hydropower.

Approval to drill will destroy our most spectacular Arctic wilderness. Future generations will never see it, or even have the comfort of knowing it's there. The Coastal Plain is the only part of Alaska's north coast that hasn't been opened to oil development—our last 100 miles. To learn how you can help us preserve it, write or call: Sierra Club, 730 Polk Street, San Francisco, CA 94109, (415) 776-2211.



## SIERRA CLUB





text and pattern color expansion.

Another area of improvement is in the plane-masking function. The 44C251's "persistent write per bit" speeds up this function. The '20 doesn't have to do read-modify-write (RMW) cycles to perform the masking operation.

By combining the wider data bus, fast page mode, faster processor cycle, and BWM support on the '20, you get a performance advantage of up to 50 times over the '10 when writing color text.

Remarkably, the '10's internal color-expand hardware already gave it a significant advantage over general-purpose processors at this function.

The 44C251's split shift register greatly simplifies the timing requirements for loading the shift register while it's still allowed to shift. The special control and timing are directly supported by the '20, removing the time-critical real-time reload headache from the system designer.

### Strike Up the Band

The '20 significantly increases the system-bus bandwidth of the '10 due to improvements in three basic areas: a wider data bus (32 bits on the '20 versus 16 bits on the '10), exploiting enhanced page-mode accesses on DRAMs and VRAMs, and a faster clock speed or state rate. The wider data-bus and page-mode accesses let the '20 fetch more instructions in less time on a cache miss. And, at a clock speed of 40 MHz, the '20 typically fetches 16 instructions in 900 nanoseconds, while a 50-MHz '10 fetches only 3. Together, these improvements provide performance increases of three to seven times on the '20 when executing programs written for the '10.

The largest performance increases due to local-bus bandwidth improvements, however, come in the multiple-cycle data-manipulation instructions. The '20's FILLs, PIXBLTs, and BLOCK MOVES have improved the most. For example, a fill operation on the '20 paints the screen in one-seventh the time required by the '10; you can get even more dramatic performance increases, up to 50 times that of the '10, if you use the block-write capabilities of the 44C251 VRAM. For large data transfers, the '20 incorporates an eight-word (32 bits per word) first-in/first-out that scoops up the source data, modifies it, and returns it to the destination within local memory.

Another unique feature of the '20 is the four CAS- outputs (see figure 1) that support byte-write operations, thus avoiding RMW cycles. Many graphics and string operations require intensive byte manipulation provided by the '20's CAS- strobes. Furthermore, these strobes let the '20's line-drawing engine splatter the display with 5 million pixels in a single second (RMW cycles would reduce performance to less than 3 million pixels per second).

In addition, the '20 dynamically sizes to 16- and 32-bit-wide memories via the SIZE16- input; simultaneously, the '20 can dynamically change its column and address multiplexing to support memories of different array sizes in the same system without additional hardware.

### Hosting the Affair

The '20 operates as either a host processor or a graphics processor attached to a host bus. The host interface on the '20 is completely transparent to the host system. When the '20's memory is mapped directly into the host system's memory map, the '20 functions as a DRAM controller.

*continued*

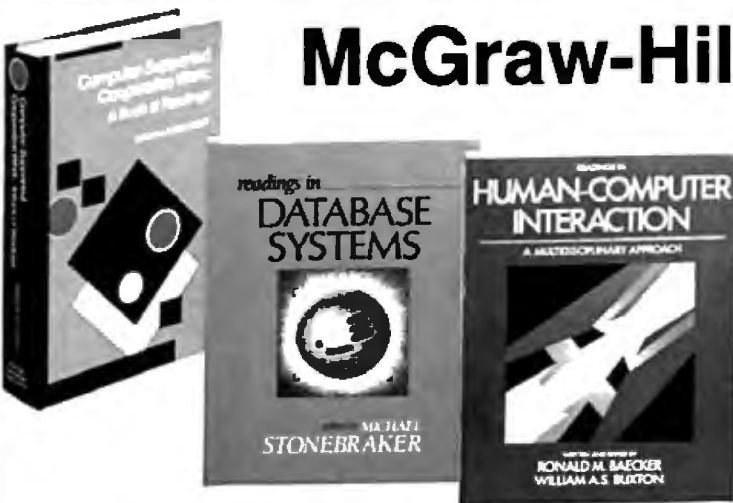

# McGraw-Hill

Bookstore

**Books that point the way** from Morgan Kaufmann Publishers

1. **Computer-Supported Cooperative Work: A Book of Readings** edited by Irene Greif. An exciting new discipline devoted to understanding group work processes and developing tools to enhance collaborative efforts. 783 pp. \$36.95
2. **Readings in Database Systems** edited by Michael Stonebraker. Forty key articles present the breadth of database research and applications through original research...with fascinating commentary by the editor. 650 pp. \$29.95
3. **Readings in Human-Computer Interaction: A Multidisciplinary Approach** by Ronald M. Baecker and William A. S. Buxton. Drawing on research from diverse fields, over 60 papers are balanced by relevant case studies and synthesizing original material, discussing approaches and core concepts. 738 pp. \$32.95
4. **Exploring Artificial Intelligence: Survey Talks from the National Conferences on Artificial Intelligence** (not shown) edited by Howard E. Shrobe and the American Association for Artificial Intelligence. Each chapter is based on a survey talk by a leading researcher who has updated his information for publication here. Hardcover Approx. 600 pp. \$34.95
5. **Softcover** Approx. 600 pp. \$19.95

**McGraw-Hill Bookstore**  
1221 Ave. of the Americas, New York, N.Y. 10020

Please send me (circle) book #  1  2  3  4  5 MB9

Number of copies \_\_\_\_\_

Check or credit card: Visa  Amer. Exp.  Mastercard

Acct. No. \_\_\_\_\_ Expires \_\_\_\_\_

Name \_\_\_\_\_

Address \_\_\_\_\_

City \_\_\_\_\_ State \_\_\_\_\_ Zip \_\_\_\_\_

Add applicable sales tax, plus \$2.50 postage and handling.

# Price is one reason to buy **Print Master II** for printer sharing.



## Performance and support are two others.

- 6 serial and 2 parallel ports
- Any port can be a computer or printer port
- All ports can send and receive data simultaneously
- Computer to computer data transfer
- Printer selection via resident pop-up menu
- 256 KB buffer saves computer time
- Buffer may be field expanded to 1.25 MB
- Easily connects to computers, printers, plotters, and modems
- Competitive price
- Unlimited toll-free telephone support
- 30 Day money back guarantee

### **BayTech**

Bay Technical Associates, Inc., Data Communications Products Division  
200 N. Second St., Bay Saint Louis, Mississippi 39520 USA  
Telex: 910-333-1618 BAYTECH, Telephone 601-467-8231 or toll-free  
**800-523-2702**



**Table 1: New 34020 instructions added to the current set for the TMS340 GSP family.**

**Graphics Instructions**

CLIP	Clip DADDR,DXDY to window
CVSXYL RS,RD	Convert source XY address to linear address
FLINE Z	Fast line draw with linear addressing
FPXLEQ	Find pixel equal to COLOR0
FPXLNE	Find pixel not equal to COLOR0
GETPS RD	Get pixel size
HPPILL XY	Horizontal pattern fill
LCOLOR	VRAM load-color latch
LINIT	Line initialization
PIXBLT B,M,L	Masked PixBlt: binary to linear
PIXBLT L,M,L	Masked PixBlt: linear to linear
PPROC RS,RD	Process pixels in registers
RPXL RD	Replicate pixel
SETCDP	Set CONVDP I/O register based on DPTCH register
SETCMP	Set CONVMP I/O register based on MPTCH register
SETCSP	Set CONVSP I/O register based on SPTCH register
VBLT	VRAM pixel block transfer
VPILL	VRAM fill array with processed pixels: linear

**Coprocessor Instructions**

CEXEC	<i>S,coIn,i</i>	Coprocessor internal operation: short
CEXEC	<i>S,coIn,i</i>	Coprocessor internal operation: long
CMOVCG	<i>RS,RD,S,coIn,i</i>	Move from coprocessor to 34020 register(s)
CMOVCG	<i>RS,coIn,i</i>	Move from coprocessor to 34020 register(s)
CMOVCM	<i>-*RD,K,S,coIn,i</i>	Move coprocessor to memory indirect (predecrement)
CMOVCM	<i>*RD+,K,S,coIn,i</i>	Move coprocessor to memory indirect (post-increment)
CMOVCS	<i>coIn,i</i>	Move coprocessor to 34020 status register
CMOVGD	<i>RD,coIn,i</i>	Move one 34020 register to coprocessor
CMOVGC	<i>RS,RD,S,coIn,i</i>	Move two 34020 registers to coprocessor
CMOVNC	<i>-*RS,K,S,coIn,i</i>	Move indirect (predecrement): memory to coprocessor
CMOVNC	<i>*RS+,K,S,coIn,i</i>	Move indirect (post-increment): memory to coprocessor
CMOVNC	<i>*RS+,RD,S,coIn,i</i>	Move indirect (post-increment): memory to coprocessor

where: *i* = the coprocessor ID (0-7)  
*K* = a count of parameters to move  
*S* = size of values operated on (0 = 32-bit, 1 = 64-bit)  
*coIn* = the coprocessor instruction field

**Move Instructions**

BLKMOV	Move block
--------	------------

**General instructions**

RMO RS,RD	Rightmost one
-----------	---------------

**Program-control and context-switching instructions**

IDLE	Idle: Wait for interrupt
MWAIT	Memory wait
SWAPP *RS,RD	Swap field (read-modify-write field)
TRAPLN	Software interrupt: long

On a host access to the '20's local memory, the host's address is latched into the '20. The address is then reformatted and presented on the LAD and RCA buses to the '20's local memory (see figure 1). Data is routed via external data buffers that are directly con-

trolled by the '20.

The 38-pin interface supports burst rates of up to 20 megabytes per second in either block-transfer or random-access mode. The '20 provides option bits in the internal host control register to let the interface pipelining be configured for

block (read or write) or RMW operations for maximum performance.

The '20 supports multiprocessing environments and can access host memory directly to improve system performance when accessing host resources. Built-in bus-fault and retry mechanisms handle address violations and bus-contention conditions. The '20 supports data operations in *big endian* (data indexed from the most-significant data bit) and *little endian* (data indexed from the least-significant data bit) modes, thus removing *swizzling* (data remapping) operations.

**Hold That Line**

The '20's Hold/Holda protocol not only lets another processor suspend the master GSP from operating on its local bus, but also lets other GSPs be directly wired onto the same local bus. Three signal lines—grant in (GI-), low-priority request (RL-), and high-priority request (RH-)—provide the handshake mechanism on this interface (see figure 1). These three lines are necessary to handle special problems associated with both graphics systems and DRAM- and VRAM-based systems.

In a typical Hold application, the '20 must reassert bus control if a shift-register-transfer (display-refresh) or memory-refresh cycle is pending. Internal counters schedule latency of these events to provide maximum performance. Internal refresh queuing of up to 12 DRAM refresh cycles limits bus rearbitration.

Two or more '20s can be directly wired together to increase system performance. Multiple GSPs synchronized to the same local clock can efficiently handshake over the three-wire interface, allowing control of the bus to be passed between processors on every local memory cycle. With the increased size of the instruction cache and the improved efficiency of instruction acquisition, a significant performance increase can be obtained by using this interface.

**Learning the Rules**

The '20 has built on the '10's full suite of general-purpose instructions and combined them with a rich set of application-specific graphics instructions (see table 1). Note that the processors have a sufficient set of the necessary assembly language instructions to support a robust C language with direct field support.

Both the '10 and the '20 have direct support for operations on fields in memory. Since they are bit-addressable processors, fields in memory can start on any bit boundary; the instruction set fur-

*continued*

New Prices

OS/2

# WINDOWS FOR DATA®

MULTI-LEVEL MENU SYSTEM  
NESTED POP-UP FORMS  
SCROLLABLE REGION  
CHOICE LIST

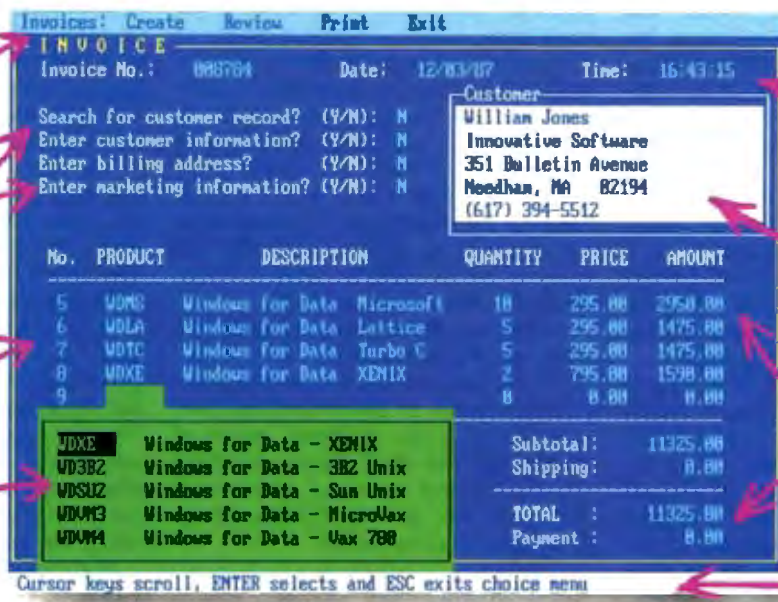

CLOCK  
POP-UP WINDOW  
RUNNING TOTALS  
MESSAGE WINDOW

If you program in C, take a few moments to learn how Windows for Data can help you build a state-of-the-art user interface.

- ☑ Create and manage menus, data-entry forms, context-sensitive help, and text displays — all within windows.
- ☑ Develop window-based OS/2 programs right now, without the headaches of learning OS/2 screen management. Run the same source code in PC DOS and OS/2 protected mode.
- ☑ Build a better front end for any DBMS that has a C-language interface (most popular ones do).



## FROM END TO BEGINNING

Windows for Data begins where other screen packages end, with special features like nested pop-up forms and menus, field entry from lists of choices, scrollable regions for the entry of variable numbers of line items, and an exclusive built-in debugging system.

## NO WALLS

If you've been frustrated by the limitations of other screen utilities, don't be discouraged. You won't run into walls with Windows for Data. Our customers repeatedly tell us how they've used our system in ways we never imagined — but which we anticipated by designing Windows for Data for unprecedented adaptability. You will be amazed at what you can do with Windows for Data.

## YOU ARE ALWAYS IN CHARGE

Control functions that you write and attach to fields and/or keys can read, compare, validate, and change the data values in all fields of the form. Upon entry or exit from any field, control functions can call up subsidiary forms and menus, change the active field, exit or abort the form, perform almost any task you can imagine.



## OUR WINDOWS WILL OPEN DOORS

Our windows will open doors to new markets for your software. High-performance, source-code-compatible versions of Windows for Data are now available for PC DOS, OS/2, XENIX, UNIX, and VMS. PC DOS

versions are fully compatible with Microsoft Windows. **No royalties.**

## MONEY BACK GUARANTEE

You owe it to yourself and your programs to try Windows for Data. If not satisfied, you can return it for a full refund.

Prices: PC DOS \$295, Source \$295. OS/2 \$495. XENIX \$795. UNIX, VMS, please call.

**Call: (802) 848-7731**

Telex: 510-601-4160 VC SOFT

**ext. 51**

FAX 802-848-3502



**Vermont  
Creative  
Software**

21 Elm Ave.  
Richford,  
VT 05476



ther supports varying field widths (from 1 to 32 bits). This can be especially important in manipulating C "fields" and in the memory storage required for packed arrays in C. The TMS340 family's hardware support for fields augments these operations. (Pixels are a special case of regularly sized, packed fields in frame-buffer memory.)

Two-operand pixel-block-transfer instructions (PIXBLTs) perform 16 binary and 6 arithmetic raster operations on a pair of two-dimensional pixel arrays. The two-operand PIXBLTs are useful for manipulating and moving bounded objects and operating with solid color.

You can simulate more elaborate operations using multiple PIXBLTs, arithmetic raster operations, and the 10's binary-expand operations. Using the binary expand, fonts stored as bit patterns form color text (with transparency), and two-color patterned operations can be performed on the bit map. The flexibility of the PIXBLT instructions lets you build operations such as the 8514/A's compare operations, as well as foreground and background raster operations. In addition, you can build support for nonrectangular objects on top of two-operand PIXBLTs.

The '20 extends the '10's PIXBLT instructions by adding a third operand, a binary-mask operand. While the '10 supplies hardware support for rectangular window regions and pixel blocks, many applications have begun to require control and rendering of nonrectangular window regions. The third mask array supports this feature on the '20. The mask is used to describe the window region on a pixel-by-pixel basis. This provides complete flexibility in describing a region: It can be filled, concave, convex, outlined, have holes, and so on.

The three-operand PIXBLT employs the binary-mask array to act on the first operand, the source-pixel array. This mask array selects individual pixels in the source array to be combined with the destination array (an independent operand). For text, the source array can be an arbitrary pattern (dithered or halftoned) describing the "color" or "shading" of the text (see figure 3). The mask array contains the description of the shape of the character, or glyph. The destination array is the displayable "canvas" onto which the character is painted.

In this way, the bits having a value of 1 in the mask select pixels (1, 2, 4, 8, 16, or 32 bits deep) in the source-array pattern to transfer to the destination location. There is the additional option of performing one of 22 raster operations on the selected source or destination pixels, as well as several transparency and plane-masking options.

#### See-Through Pixels

Raster operations on the TMS340 family include all the Boolean combinations of 2 bits and their complements, plus an arithmetic set. This latter set supports addition and subtraction of pixels as well as a unique pair of comparison operations. The first computes the maximum of the source and destination pixels. The second computes the minimum pixel value. These operations are useful for layering "planes" of data via the intelligent ordering of pixel indexes or colors. They have been used to "drag" sprite-like objects around the screen without corrupting background or foreground images. Pixels are combined through binary or arithmetic raster operations to form a resultant pixel.

Raster operations for the '20 contain several new transparency modes. Trans-

parency is the notion that there are cases in which it is useful to inhibit the writing of new pixel data to the destination based on information within the actual operands of the raster operation. Thus, transparency circumvents the normal determination of what value is to be written to the destination pixel.

The four '20 transparency modes are transparency inhibited, transparency on resultant pixel = 0, transparency on source pixel = 0, and transparency on destination = COLOR0. The first two are '10-compatible modes.

When transparency is inhibited, raster operations proceed as normal. For transparency on the resultant pixel equal to 0, the '20 checks the pixel value that results from the raster combination for zero-valued pixels. The zero value is then replaced with the original destination-pixel value so that the destination-pixel location is not changed.

For transparency on the source pixel equal to 0, the source-pixel value is checked before the raster operation for zero-valued pixels. Each zero value is identified so that the destination pixel retains its original value. This is useful for maintaining transparent pixels in the source-pixel array while using other '20 raster operations.

For transparency on the destination equal to COLOR0, the destination-pixel value is checked before the raster operation for pixels that equal the "background" color (stored in the 32-bit COLOR0 register). Each background-value pixel in the destination is not modified by the raster operation. This is useful for maintaining background pixels in the destination bit map, regardless of the value of the source pixel and which of the 22 raster operations are enabled.

#### Working on the Line

Several design areas on the '10 in the area of line support were targeted for enhancement on the '20. Among these were fast line draw, line initialization, and support for patterned lines and arrays.

To enhance line-draw performance, the '20 has added a fast line-draw instruction to the '10's Bresenham-algorithm line draw (see "Better Bit-Mapped Lines" in the March BYTE). This FLINE instruction performs the same arbitrary-angle algorithm found on the '10, but it assumes preclipped endpoints as input. This allows the CPU to bypass the window-checking microcode and execute the heart of the line-draw algorithm at memory-bandwidth speeds (raster operations, plane masking, and transparency

*continued*

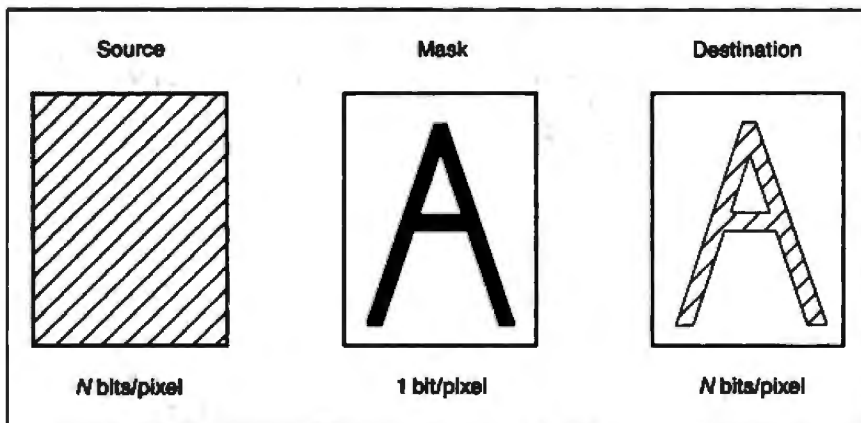

Figure 3: The three-operand PIXBLT. The third operand is a 1-bit-per-pixel array that provides a mask for pixel-by-pixel control over the destination pixels.

# SCSystems

# 1-800-669-9933

Serving Computer Buyers For  
Eight Years

Para Asistirle En Espanol  
Llame Al Tel 1-800-842-1777

**STAR  
NX1000  
Printer  
\$174**

**SAMSUNG  
12" Flat Amber  
Monitor  
\$82**

**LOGITECH  
C7 Mouse  
W/Plus Software  
\$68**

## HARDWARE

## SOFTWARE

### ACCESSORIES

CopyIIPC Brd Deluxe..... \$ 99  
Masterpiece + ..... 95

### COMPUTERS

#### SCSystems Series 88 XT Computer

Slide Case Top w/upfront key-  
lock, turbo button/led, reset  
button, 150 watt power sup-  
ply, 360K drive, 477-10MHz,  
640K, Phoenix Bios, AT style  
keyboard, Limited one year  
warranty.

**\$565**

### AST Premium/286

Model 120 ..... \$2279  
Model 80 ..... 1629  
Model 140X ..... 2479

### BOARDS

AST Adv Prem 1mb ..... \$ Call  
AST 6Pac Prem 1mb ..... 525  
AST Sixpac ..... 115  
Hercules Grph + ..... 182  
Intel Above 286 ..... Call

### EGA BOARDS

ATI EGA Wonder ..... \$ 175  
Genoa SuperHiRes+ ..... 195  
Orchid Designer ..... Call  
Paradise 480 ..... 155  
Paradise VGA +XT ..... 259  
Paradise VGA Prof ..... 385  
Vega VGA ..... 269

### EGA MONITORS

Princeton U/Sync ..... \$ 529  
NEC Multisync 2 ..... 579  
Samsung ..... 359

### HARD DRIVES

Seagate 125 w/cont ..... \$ 321  
Seagate 138 w/cont ..... 411  
Seagate 30MB w/cont ..... 294  
Seagate 20MB w/cont ..... 269

### MICE

Logitech ..... \$ 68  
MS Bus Mouse ..... 99

### MODEMS

Hayes 1200 ..... \$ Call  
Hayes 1200B ..... Call  
Incomm RPC1200 ..... 62  
Incomm RPC2400 ..... 147  
Incomm T1200 ..... 76  
Incomm T2400 ..... 167  
Incomm T2400EC ..... 224

### MONITORS

Amdek 410 ..... \$ 145  
Princeton MAX15 ..... Call  
Samsung RGB ..... 215  
Samsung Amber ..... 82

### 3COM

3C508 ELink II ..... \$345  
3C523 ELink/MC ..... 432

### PRINTERS

Citizen  
120D ..... \$ Call  
180D ..... 199  
MSP-15E ..... 319  
MSP-40 ..... 285

C. Itoh  
ProWriter C715 ..... 925  
ProWriter Jr.+ ..... 255

NEC  
P2200 ..... Call

Okidata  
Call on all models.

Panasonic  
10801/M2 ..... 164  
10911/M2 ..... 199  
10921 ..... Call

Star  
NX-1000 ..... 174  
NX-1000 Color ..... Call  
NX-15 ..... Call

Toshiba  
321SL ..... 500  
341SL ..... 674  
351SX ..... 1005

### ACCOUNTING

DacEasy ..... \$ 54  
Dollars & Sense ..... 95  
Managing Your \$ ..... 119

### COMMUNICATION

Carbon Copy Plus ..... \$ 106  
CrossTalk XVI ..... 89  
CrossTalk 4 ..... 115  
PC Anywhere ..... 57  
SmartCom II ..... 82

### DATABASE

Clipper ..... \$ 370  
Data Perfect ..... 284  
DBase III ..... 379  
DBXL Diamond ..... 109  
Fox Base + ..... 190  
Paradox 2.0 ..... Call  
Q and A ..... 188  
Relate & Report ..... 100

### DESKTOP PUBLISHERS

Pagemaker 3.0 ..... \$ Call  
PFS First Pub ..... 55  
Ventura ..... 495

### GRAPHICS

Chartmaster ..... \$ 199  
Generic Cad 3.0 ..... 51  
Printshop ..... 33  
Signmaster ..... Call

### INTEGRATED

Ability Plus ..... \$ 139  
First Choice ..... 89

### LANGUAGES

MS QuickBasic ..... \$ 60  
MS Quick C ..... 60  
Turbo Basic ..... 59  
Turbo C ..... 59  
Turbo Prolog ..... 59

### SPREADSHEETS

Lotus 123 ..... \$ Call  
Plan Perfect ..... 192  
Quattro ..... 150  
Surpass ..... 329

### UTILITIES

CopyIIPC ..... \$ 18  
Desqview ..... 71  
Duel ..... 48  
Fastback Plus ..... 88  
Formtool ..... 52  
Mace ..... 48  
Norton Advanced ..... 72  
PC Tools Deluxe ..... 36  
Sidekick Plus ..... 119  
Sideways Print ..... 39

### WORD PROCESSING

Word Perfect 5.0 ..... \$ 219  
Wordstar ProPack ..... Call  
Wordstar 2000 ..... Call



No Charge for  
Mastercard or Visa



**Call For Items Not Listed**

**SCSystems**

205 S. 29th St., Phoenix, AZ 85034

Order Line 800-669-9933

Espanol 800-842-1777

Status Line 602-275-1395

FAX No. 602-273-0043

Order Line for Europe & Mexico 602-275-1395

**TERMS:** No charge for Visa or Mastercard. We do not charge your card UNTIL WE SHIP your order. Manufacturers warranty applies in all cases, all warranties are handled by the manufacturers. We accept Purchase Orders from authorized companies only, for 3.5% above cash price. No COD orders. No refund on opened software. All prices are subject to change. Allow 14 days for personal/company checks. Arizona orders add 6.7% tax. Add 2% for shipping plus \$2.00 for handling. We do not guarantee compatibility.



## Making Videos

The video RAM (VRAM) is a dynamic RAM (DRAM) modified to let it transfer a large number of bits from the memory array to a separate internal serial-shift register. Prior to VRAMs, the majority of the available bandwidth in conventional frame buffers (designed around DRAMs) was used for display refreshing. This left virtually no time for a processor to update the display data.

After making the transfer, the contents of the shift register are independently shifted out to the display. As a result, the random port of the VRAM allows unimpeded access to the graphics processor. With the increasing resolutions of graphics displays and denser memory devices, the VRAM is becoming indispensable to frame-buffer design.

The original 64K-bit VRAM was organized as a 64K-by-1-bit device and had a single 256-bit shift register with four *tap points* (the starting column position for the shift register). Memory-array-to-shift-register transfer cycles could be made only during horizontal retrace when the serial clock to the shift registers was stopped.

The next-generation VRAM was a 256K-bit device that combined the functionality of four 64K-bit VRAMs on a single chip. The device was organized into a 64K-by-4-bit device and contained four 256-bit "serial-shift" registers. A static RAM and counter emulated the shift-register function of its predecessor, allowing the shift function to start from any tap point.

Transfers in the middle of a line were enabled by changing the timing of the shift-register-to-memory transfer. This "midline reload" allowed designs to use fewer VRAMs for certain frame-buffer sizes, but the timing was so critical that few systems could take advantage of it. Furthermore, various manufacturers experimented with features including fast page mode, Boolean functions, and alternate shift-register timing modes.

The latest VRAM generation is a 1-megabit device that has several architectural enhancements to improve performance. The organization is 256K-by-4-bit with four 512-bit shift registers. Some manufacturers plan an alternative 128K-by-8-bit VRAM. It's important

to note that when graphics architectures use data buses wider than 128 bits, some memory devices will be only partially used, because they need extra devices just to reach the required data-bus width due to the "deeper" organization of the by-4 memories. To compensate for the increase in the depth of the memory, the 1-megabit VRAM includes features to improve its performance without requiring wider buses.

Most 1-megabit VRAMs support the block-write mode (BWM), which gives a performance improvement of four times or more on key graphics operations, such as fills and color-text generation. Fast page-mode accesses (common on 1-megabit DRAM) further improve memory bandwidth. Some 1-megabit VRAMs will support "persistent write per bit," which lets color masking be "locked in" on the VRAMs, reducing read-modify-write (RMW) cycles. The 1-megabit VRAM will also support "split-shift-register transfers," simplifying the timing and control circuitry necessary for real-time reloading of the serial-shift register. The split shift registers provide memory savings in non-binary-powered display resolutions.

BWM is the most significant new architectural feature on the 1-megabit VRAM. On the 256K-by-4-bit VRAM, an internal 4-bit color register is loaded from the 4-bit-wide data bus during a special write cycle. At 4 bits per pixel, this latch contains the color value to be written; at 8 bits per pixel, two VRAMs are concatenated to form an 8-bit register.

When the VRAM's control signals select BWM, the two least-significant bits of the address are ignored, and the four "data pins" control the writing of the contents of the color register into any or all of four consecutive locations (a "block") in memory. A "1" on a data line initiates the writing of the color-register value, while a "0" prevents that writing to the corresponding position in the block. With four data lines controlling the four 4-bit memory cells, the net effect is an effective increase of four times in write bandwidth. The ability to support individual pixel control in BWM allows this feature to be used for rendering color text and area filling.

are all active).

To reduce overhead during line initialization, the LINIT instruction performs the necessary setup for the LINE instruction. LINIT speeds up and simplifies the operation overhead associated with line initialization. More important, LINIT allows larger algorithms utilizing the LINE instruction to fit into cache, thereby increasing drawing performance.

For enhanced patterned-drawing support, the '20 adds a horizontal-fill instruction, HFILL, which supports patterns described in a 32-bit internal register. The repeating pattern is taken from the register and rotated as pixels are drawn if the register contains a nonzero pattern. The PATTRN register contains the current drawing position in bit 0 at the end of the instruction.

### But Can I Use It?

The '20 offers a full line of development-tool support built on the '10 support environment. A full Kernighan and Ritchie optimizing C compiler utilizing many of the extended features of the TMS340 architecture is available. Supporting the C language environment is a full set of assembly language tools for building relocatable, ROMable, or all-RAM executable files. A TMS340 family common-object-file-format (COFF) loader, C I/O package, and high-level-language debug support are planned for the '20.

The '20 is object code-compatible with the '10. This means that math libraries, graphics libraries, graphics interfaces, and graphics-standards software are already available for the '20. These will be enhanced over time to use the extensions of the '20.

### A Family Reunion

With the entrance of the '20 and '82, the TMS340 architecture addresses a very wide range of graphics applications. The '10's smaller package size and high level of system integration is ideally suited to high-volume cost-sensitive applications. The more powerful '20 provides an upwardly compatible migration path for '10 designs and meets the needs of higher performance systems.

By adding a TMS34082 Graphics Floating-Point Unit and TMS44C251 VRAM to a 34020-based system, a small board can have all the graphics and math capabilities of a high-end workstation. ■

*Ron Peterson, Carrell R. Killebrew Jr., Tom Albers, and Karl Guttag are all members of Texas Instruments' design team for the 34020. They can be reached on BIX as "editors."*



# NATURAL LANGUAGE INTERFACE



## THE COMPUTER CHRONICLES MAKES KEEPING UP WITH THE INFORMATION AGE EASY

Stewart Cheifet and Gary Kildall are your co-hosts for a weekly half-hour television program aimed at computer users, owners, educators and computer industry professionals. If you're looking for help in finding out what's new and what's news, tune in to **THE COMPUTER CHRONICLES** every week on your local public television station.

Regular commentators are Jan Lewis, President of Lewis Research Corporation and publisher/editor of



JAN LEWIS



GEORGE MORROW

*The Computer Chronicles is funded in part by McGraw-Hill's **BYTE** magazine. The Computer Chronicles is a co-production of WITF/Harrisburg and KCSM/San Mateo.*

HyperAge magazine, and George Morrow, founder of Morrow Designs.

Topics this season include: CD ROMS — Shareware — Multitasking — Business Graphics — Investment Software — PC Imaging — PC Networks — Decision Support Software — Laser Printers — Hypercard — Input Devices — and MUCH MORE.

Each week **THE COMPUTER CHRONICLES** looks at the top stories of the week in Random Access, a news segment designed to keep you informed about the latest developments in the computer industry.

**THE COMPUTER CHRONICLES**, a weekly half-hour of public television that just might be the help you need.

### THE COMPUTER CHRONICLES IS NOW ON BIX

Bix, the Byte Information Exchange, now has a conference for the Computer Chronicles.

Now you can communicate directly with the staff of the Computer Chronicles to suggest topics for future shows or to request information or details on past shows.

Once on Bix, just type "join comp.chron" at the colon (:) prompt.



# You can rely on a file server for LAN communications...



## All you need is patience. And faith.

**Y**ou're getting the drift of this message already. File servers aren't designed to solve the PC user's communications problem. But now there's a system that is.

### **Now there's COMMIX™ 32.**

It's a general purpose local area network for PCs and minicomputer hosts. It connects you with the host, other PCs, and peripherals such as printers, plotters, or modems through simple, pop-up menu commands.

For file transfer and E-mail as a background task. For printer spooling and sharing directly from your applications programs. For terminal emulation that's automatic. COMMIX 32 will let anyone perform common LAN tasks—without the need for expert assistance.

### **Install it quickly. Expand it easily.**

Almost any PC user can install and connect with COMMIX. With each connection, you're saving time and money. Because each COMMIX connection costs as little as \$150.

Then take advantage of expansion possibilities. With our optional Ethernet® Link Module, you can create larger LANs with thousands of users. And through our optional Wide Area Network Module, distant COMMIX LANs can appear as one network.

### **If you're lost at sea.**

And looking for solid LAN. The COMMIX 32 is available now. Send us a message: ITRON, a Division of Infotron Systems Corporation, 130 Gaither Drive, Suite 116, Mount Laurel, NJ 08054.

TEL: (609) 722-5575 FAX: (609) 234-0451

In the United Kingdom: (01) 735-0731

In Europe: (2) 725-0770

**1-800-423-8044**



COMMIX is a trademark of Infotron Corporation. Ethernet is a registered trademark of Xerox Corporation.

Circle 132 on Reader Service Card

# Lighting the Way

*The brightness of EL is expanding from yellow only to red, green, and blue*

*Rolland Von Stroh and Brian Dolinar*

**T**he importance of light-emitting flat-panel displays, the performance advantages of thin-film electroluminescent (TFEL, or EL) displays, and the development of color capabilities make EL a heavyweight contender in the high-information-content display field.

Ergonomic yellow color, brightness, contrast, angle viewability, ruggedness, reliability, and long life all stem from the structure of EL displays. These displays use a solid-state construction (no gases or liquids trapped between glass plates).

EL consists of layers of thin films (angstroms thick) that are deposited on a single glass substrate. These layers are composed of metals and dielectrics, similar to a semiconductor device. The solid-state nature is responsible for both the long life and ruggedness of EL displays.

The core thin-film layer is a phosphor layer of zinc sulfide (ZnS) treated with manganese (Mn), which emits light when subjected to a high-voltage field. The phosphor layer is insulated from the outer electrodes—one reflective and one transparent—by two insulating dielectric layers (see figure 1).

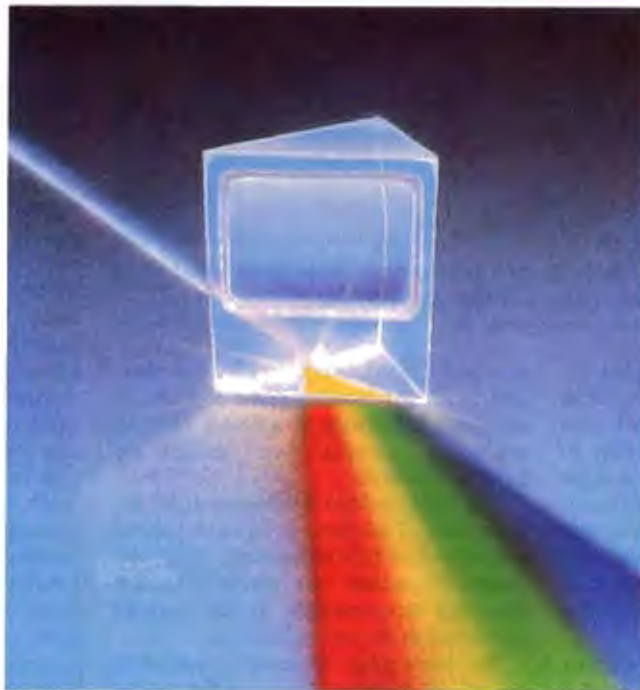

The thinness of the overall thin-film stack provides several benefits: There is almost no physical thickness (approximately one micron) to the display, and light is emitted uniformly across a pixel and in a direction normal to the pixel surface. The light doesn't emanate in all directions, causing a Gaussian distribution, or "fuzzy-pixel," effect.

This means that with EL you see

bright, highly defined pixels. *Cross-talk* between on and off adjacent pixels, so common with light-emitting technologies, is almost nonexistent with EL due to the thin-film structure. This lack of cross-talk also provides the extremely wide viewing angle (about 160 degrees) and eliminates *parallax*—an important point for touch panels.

## What You See Is . . .

The chief attribute of any display would have to be its *viewability*. It consists primarily of brightness, fill factor, contrast, angle insensitivity, and acuity. The amount of light a display emits is considered its *brightness*; this can be measured as an average or as pixel brightness. *Fill factor* is determined by comparing the amount of illuminated area to the surrounding nonilluminated area; it's given as a percentage. The greater the fill factor, the greater the apparent, or perceived, brightness. For a 640- by 400-pixel format, EL has a pixel brightness of 30 footlamberts (ft-L) and a fill factor of 50 percent, for an average yield of 12.5 ft-L.

*Contrast* is the ratio of on-pixel brightness to the surrounding off-pixel bright-

*continued*



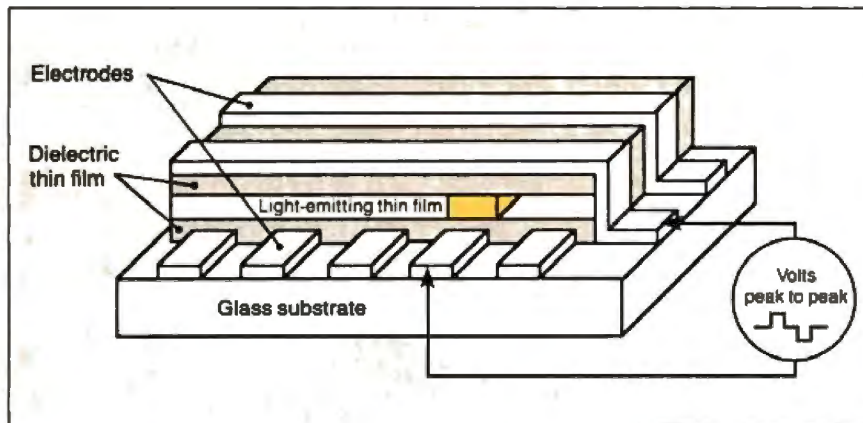

**Figure 1:** The basic device structure of the thin-film electroluminescent display panel.

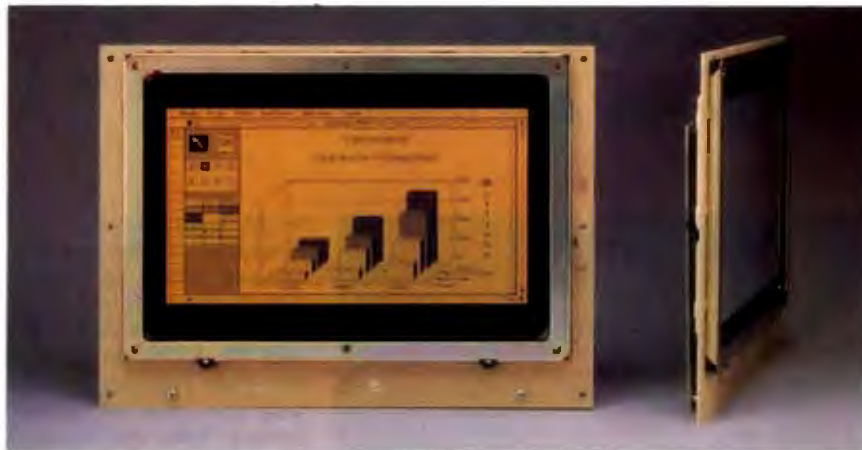

**Photo 1:** The ergonomic yellow of the principal EL phosphor. Note the thinness of the overall display panel. (Photo courtesy of Planar Systems, Inc.)

ness. The greater the ratio, the higher the resulting contrast. At 500 lux of ambient light, a typical EL display/contrast ratio value is 20 to 1. A display's ability to maintain its contrast ratio over a wide viewing angle is called its angle insensitivity. We measured contrast ratio at various angles in a 500-lux environment and found that an EL display remains at or above 10 to 1 over a full range of viewing angles—up to about 160 degrees.

**Acuity** is the uniformity of light emission across a pixel and the amount of a pixel's edge definition. Once the contrast ratio is high enough to easily distinguish between on and off pixels, image crispness is determined by how uniformly the on pixels emit light and how minimally that light "leaks" into the adjacent off-pixel areas. EL has a highly uniform distribution of light over the pixel area and is also highly one-directional since the light-emitting layer is so thin.

An overall rating of good viewability

consists of good ratings in all these characteristics. Acceptable contrast with inadequate brightness or a small viewing angle, for example, won't suffice for most applications.

The light emitted by the principal EL phosphor, ZnS:Mn, is amber yellow with a peak of 585 nanometers. This "ergonomic" yellow (see photo 1) is the phosphor recommended by the German and Swedish display authorities.

The eye's peak response is located in the yellow-to-green region of the visible color spectrum (see figure 2). Although green is the more eye-sensitive color, amber yellow is less fatiguing to the eye over extended, intensive-use sessions.

### Reflections

A contrast-enhancing filter helps any display technology achieve its optimum performance. Increasing ambient light reduces the display's contrast ratio until it reaches a level where the display is

washed out. To enhance the contrast, you need to use a filter with an anti-reflective coating; this will preserve a good luminance from the on pixels while reducing any undesirable reflection off the screen.

There are two primary types of ambient-light reflections that you must consider when viewing an EL display. The first is the front-surface reflection off the substrate glass on which the display is constructed (i.e., the front of the screen). About 5 percent of the incident light is reflected from this front surface; about 70 percent of it comes from the rear electrodes of the EL display. An unfiltered EL display is a 75 percent-efficient mirror (see figure 3). Both reflections need to be reduced, and although both appear to be a problem, they are not. In fact, the reflection off the rear electrodes actually enhances the contrast of an EL display when you use it with a filter.

For medium-to-high ambient-light levels, you'll want to use a circular polarizer (CP). It will remove nearly all ambient reflection from the rear electrodes. However, the fact that the rear electrodes are reflective enhances the CP's ability to improve the display's contrast.

When the light reaches the quarter-wave retarder, the single electric-field vector divides into its two components, one pointing along each axis of the retarder (see figure 4). These components travel at different speeds. The result is right-circularly polarized light. This means that the tip of the electric-field vector traces a right-helical path through space. The direction of the helix is determined by the right-hand rule. When circularly polarized light is reflected off a smooth, shiny surface, the direction of its polarization changes. In this case, the right-circularly polarized light changes into left-circularly polarized light.

When this light reaches the quarter-wave retarder, it approaches from the rear, and the retarder imparts an additional quarter-wave left-helical motion to the light wave's electric-field vector. The result is light that is linearly polarized perpendicular to the axis of the linear polarizer. Since this light cannot pass through the polarizer, you can't see any reflection from the back electrodes.

You also need to reduce specular as well as diffuse reflected light from the front surface of the filter. Two basic modes of anti-reflection work well: thin-film coating and etched, or frosted, surfaces. They are very different in their properties, however. Figure 5 shows the percentage of reflection on the front surface for untreated glass, etched glass, and thin-film coating.

The etched surface reduces reflections by scattering or diffusing the reflection. In high-ambient light like you'd find outdoors, the reflection washes out the display, since the etched surface doesn't diminish the reflected light but only scatters it. That is, the contrast between the signal and reflected light degrades to less

than 2 to 1, and displayed information becomes illegible. The etched surface is effective for indoor applications and for ground-based sun-shielded applications.

The thin-film coating has a lower reflection and is used for high-ambient-light applications, where the etched surface would be illegible.

### Rough, Tough, and Ready

EL uses surface-mounted CMOS drivers and other circuitry, modulating between 185 and 215 volts. Surface mounting gives EL displays toughness and reliability and makes them easy to repair.

The luminance-voltage characteristics *continued*

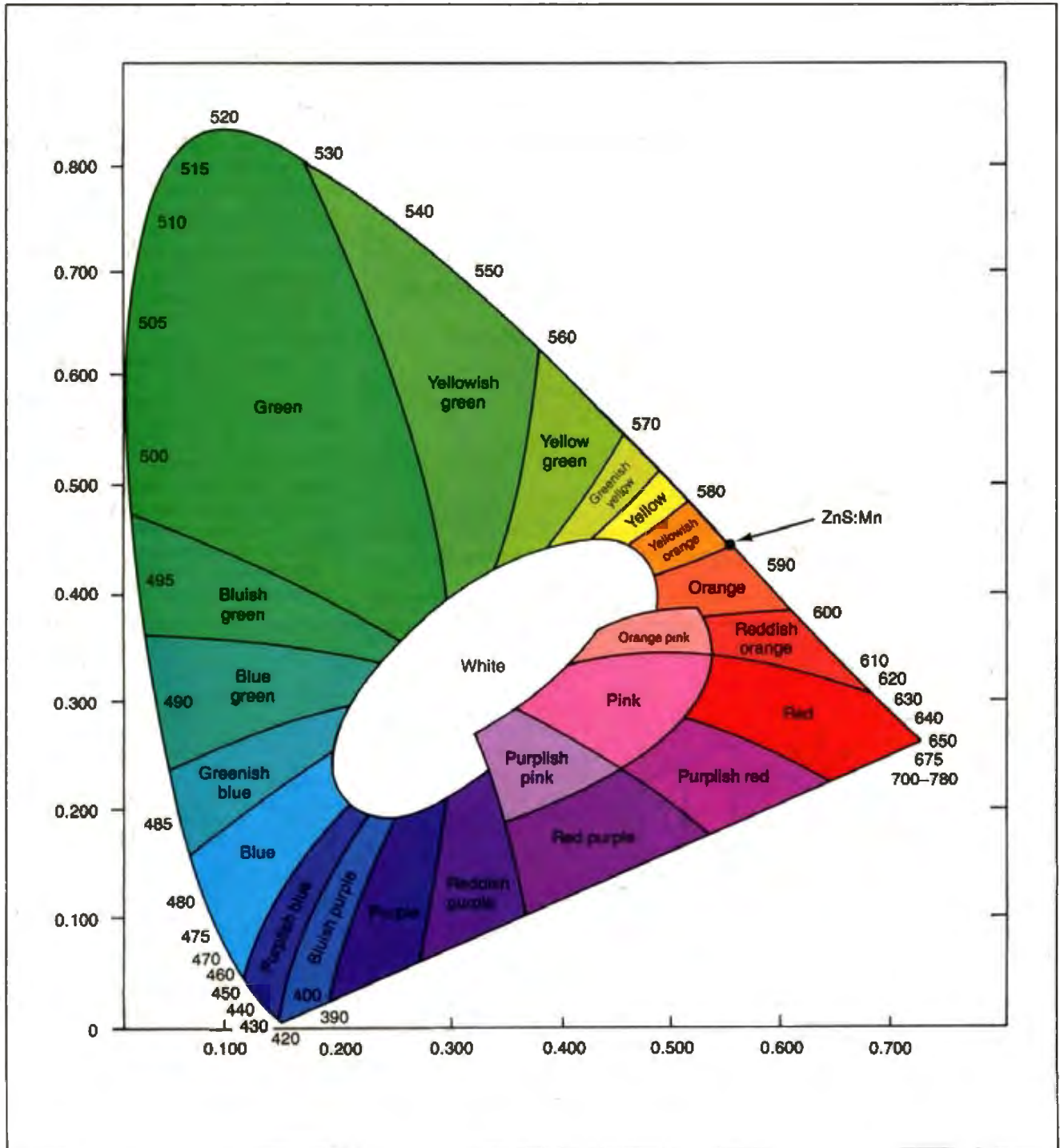

Figure 2: The 1931 CIE chromaticity diagram of the color spectrum with approximate color names.



of a typical EL device feature a threshold voltage below which little light is emitted, then a steeply rising slope just above the threshold, and finally a leveling off, or saturation region. This non-linear characteristic means that you can address the device electrically at a high multiplexing ratio and still maintain excellent contrast.

### Hooking It Up

Three basic elements are involved in interfacing EL monitors with computer-graphics hardware: a display-refresh RAM, a monitor controller, and a video

clock. The RAM must be shared between the system CPU, which writes graphical data as bit patterns into the memory, and the monitor controller, which reads this data on a cyclical refresh cycle and translates it into information the display drivers and EL panel can use. In noninterlaced systems, this refresh cycle usually takes place at a 60-Hz rate to create a flicker-free image. In other words, the display controller reads one entire frame of RAM display data every sixtieth of a second.

The monitor controller converts this RAM data into a serial video-data (VID)

stream and provides a video clock (VCLK) and two basic synchronizing signals: horizontal sync (HS), which determines when to present each row of pixels, and vertical sync (VS), which determines when to present each new display frame. Usually, there is enough time between the presentation of individual pixel rows or display frames for the CPU to update the display-refresh RAM.

EL monitors operate on the same basic signals that CRT monitors do. Thus, off-the-shelf CRT-controller chips, which provide all the basic control signals plus the interface logic required to communicate with the display-refresh RAM and CPU, can now meet the monitor-control requirements of many systems.

In addition, since flat-panel use is increasing, display-control chip manufacturers are providing the necessary control signals and timing specifications so you can easily integrate EL into many of the designs using these chips. Both new-generation chips (e.g., those produced by Yamaha, Paradise, and Gemini) and older CRT-controller chips work with EL. Due to similar phosphor speed, line-at-a-time addressing for EL is much like that for noninterlaced CRT circuits. You don't need to learn new interfacing techniques. The newer chips also contain many new modes, such as simulated gray scale, to display contrast for color software on a monochrome monitor.

RS-232 cards, video-controller cards, and touch panels have all been designed

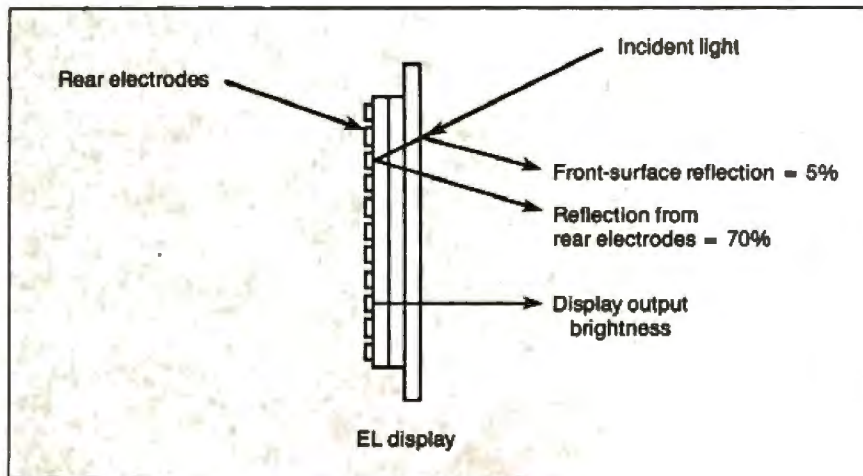

**Figure 3:** Unfiltered EL display reflections. An unfiltered EL display is a 75 percent-efficient mirror.

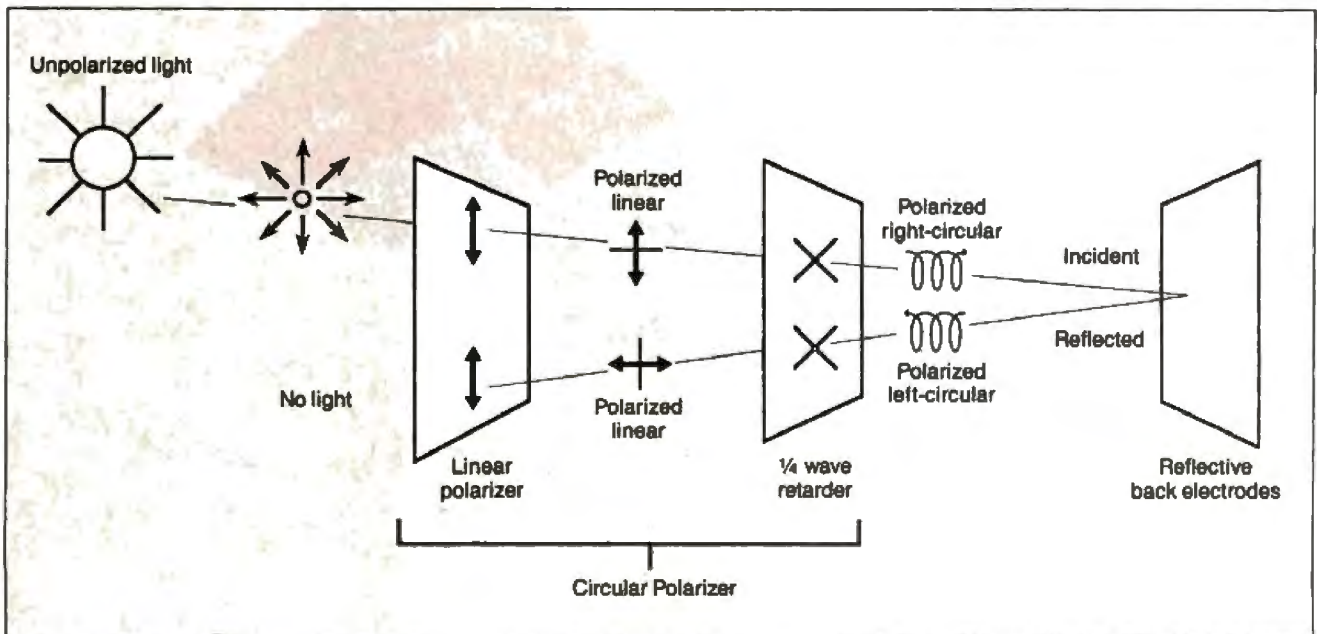

**Figure 4:** This diagram shows how unpolarized incident light can be controlled and its reflection eliminated by using a circular polarizer.

for use with EL. Touch-entry devices work well with it. EL is flat, not curved like a CRT, so parallax with touch is not a problem. A touch-entry overlay—whether resistive or capacitive—reduces the optical transmission of a display. Infrared, resistive, and capacitive touch panels work well with EL due to its crisp image quality, low electrical emissions, and light-emitting properties.

The ability to perform to various data-communication interface standards, such as RS-232, VT-100, or VT-220, is not a function of the EL device itself, but rather of the availability of chips and cards to support these applications. Support for these standards is available.

### In Living Color

Planar Systems of Beaverton, Oregon, has developed the phosphors and processes to produce prototypes of two- and three-color EL displays. Full RGB monitors are feasible, and the next step is to come up with an economic manufacturing practice for color. The company recently shipped its second full-color prototype to the U.S. Army Laboratory

*continued*

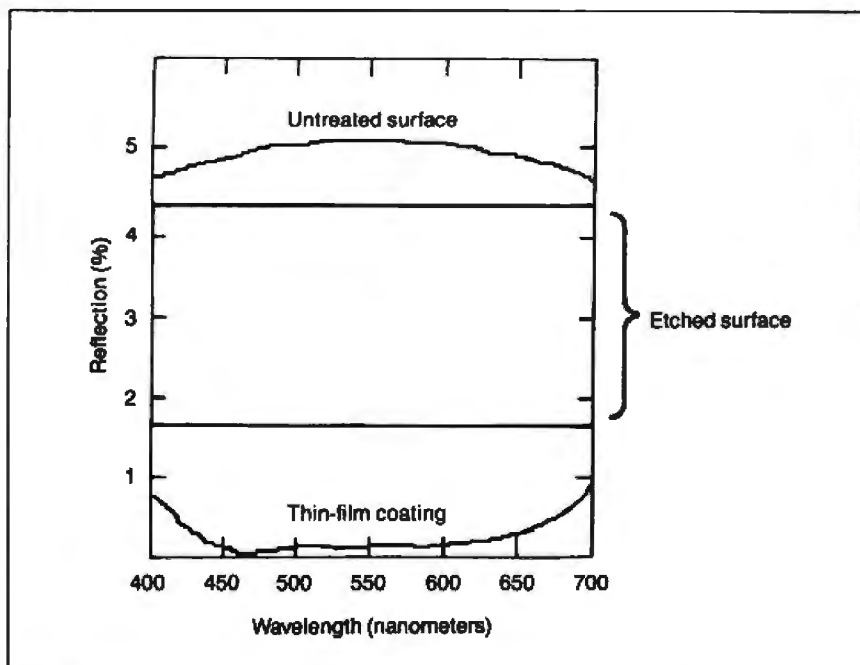

Figure 5: The comparative percentages of reflection off various front surfaces. Untreated glass fares the worst, and thin-film coating works better than etched glass in high-ambient-light situations.

at **\$99<sup>00</sup>**  
Small talk is Cheap



... at \$99, this modem is hard to beat.  
Ann Fischer Lent, p.98, BYTE, June, 1988

## DELTA GOLD<sup>®</sup> Voyager Modem

The most fully packaged, easy to use portable modem in the marketplace costs only \$99. The DeltaGold Voyager modem.

The Voyager modem is 100% Hayes compatible, has 300/1200 baud transmission speeds, and has a 28 character non-volatile memory.

It comes with features you wouldn't expect for \$99: Remote ring, low battery LED indicator, tone sensing, busy and dial tone monitoring, pulse/DTMF (touch tone) dialing, auto dialing/auto answer, and auto power on/off.

Like all DeltaGold products, the Voyager modem comes complete with everything you'll need: communications software, the best documentation in the industry, telephone cord, and an external 9-25 pin adaptor. And it's accompanied with an 18-month warranty.

The Voyager modem will work for approximately 10 hours on a 9-volt battery, or can be used with an AC adaptor, available for \$6.00.

So when you're looking for a full-featured modem that can travel anywhere, remember that small talk is cheap. The DeltaGold Voyager modem, for only \$99.

DELTA GOLD<sup>®</sup>  
DELTA COMPUTER CORP

1-800-255-DELTA  
(617) 339-5575  
(508) 339-5575



Command (LABCOM) Division in Fort Monmouth, New Jersey (see photo 2). The color prototypes have a pixel matrix of 320 by 240 (by 3 colors) and offer an active display area of 4.8 by 3.6 inches (a 6-inch diagonal). The pixel pitch is 0.005 inches (200 lines per inch).

Red, green, and blue phosphors are currently composed of ZnS:SmCl<sub>3</sub> (zinc

sulfide with samarium chloride), ZnS:TbF<sub>3</sub> (zinc sulfide with terbium fluoride), and SrS:Ce (strontium sulfide with cerium), respectively. A split-pixel approach, patterned for red, green, and blue (see photo 3), optimizes the trade-offs in brightness, processing cost, and electronic addressing. When you mix them, the pixels are bright enough to gen-

erate a full white. For TV video, however, you want more brightness and color saturation from the blue phosphor. Planar is working on that problem, looking at processing enhancements, and exploring other phosphor compositions.

### Bigger, Better, and Brighter

Over the last 2 years, the typical power consumption of a full-page EL display has decreased from the mid-20-watt range to under 10 watts. This has been accomplished by combining less-power-hungry drivers with power-recovering drive architecture. Since an EL display is a large capacitor, you can recover the capacitive current through an inductive design, reducing the power dissipation.

At the same time, breakthroughs in materials, architecture, and processing have brought a 50 percent increase in EL brightness. For outdoor applications, the brightness of EL panels increases with the refresh rate (up to 1 kHz).

Monochrome emulation of full-color information requires control of pixel-by-pixel brightness at various levels. EL's large bandwidth of on-to-off contrast provides wide levels for a discernible gray scale. Full 16-level gray-scale EL drivers have been developed and used to display sharp, clear video and graphics. EL provides a full range of gray-scale design options: voltage, pulse width, and refresh-rate modulation.

Multiplexed addressing of digital flat-panel displays has constraints in size and pixel count due to the time required to address each frame a line at a time within the common 60-Hz refresh cycle. Planar has recently expanded these constraints to produce glass panels of roughly 19 inches diagonal with a resolution of about 1024 by 1024 pixels. These developments potentially expand EL markets to workstations and other large-panel applications where compactness, high resolution, and image stability are important.

### A Bright Future

In the past, EL's main problem in market acceptance has been its price. Now, it's in high-volume production, bringing down the costs of the ICs, circuit boards, glass, and other materials used in its creation, and thus the final cost of the EL panels as well. The bright clarity of EL, once too expensive for most of us, is coming into view. ■

*Rolland Von Stroh is vice president, marketing, of Planar Systems, Inc. in Beaverton, Oregon. Brian Dolinar is marketing engineering manager at Planar. They can be reached on BIX as "editors."*



Photo 2: An example of a color display on a full-color EL prototype display from Planar Systems. (Photo courtesy of Planar Systems, Inc.)

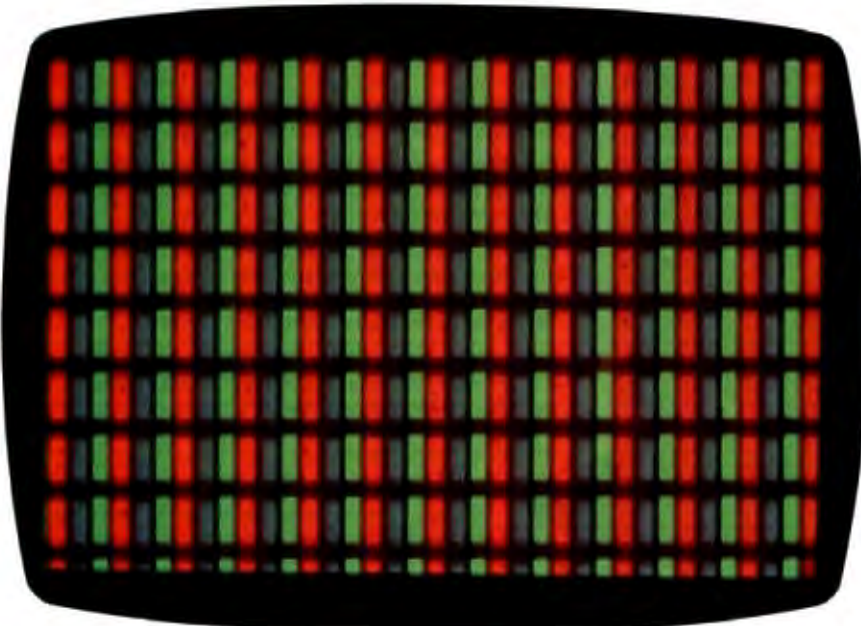

Photo 3: The red, green, and blue pixel matrix used to produce color in the traditionally "yellow only" EL display. (Photo courtesy of Planar Systems, Inc.)



INTRODUCING FUJITSU'S  
DL3000 SERIES PRINTERS.

If you have  
to ask  
how  
much  
it costs,  
this is the  
printer for you.



Meet Fujitsu's new DL3000 series printers. All you ever wanted from a 24-wire dot matrix printer at a surprisingly affordable price.

**Superb Paper Handling, Speed, and Quiet Operation.**

First, with just a push of a button you can switch between letterhead and computer paper. The built-in tractor with paper parking does all the work.

Next, print fast. 288 characters per second, or one-page memos in 10 seconds.

Finally, print quiet. Quiet enough to let you comfortably carry on a conversation.

Easier, faster and quieter than the competition. Ask to see one. We'll prove it.

**Comes Fully Loaded, Ready To Go To Work.**

The DL3000 printers give you crisp graphics and exceptional letter quality printing.

They give you an easy-to-use programmable operator panel with memory for two different menus. And you'll be compatible with today's popular business systems and software.

You even get an industry leading reliability rating of

8,000 hours  
MTBF. For years  
of trouble-free  
performance.

Call 800-  
626-4686 today  
for more information on this  
or any of our  
world famous  
family of printers, including daisywheel, dot matrix,  
laser and band.

Because the more you ask, the more we can do for you.

DL3000 (Narrow Carriage), DL3400 (Wide Carriage)		
Speed	High Speed Draft	288 cps at 12 cpi
	Draft Quality	216 cps at 12 cpi
	Letter Quality	72 cps at 12 cpi
Fonts	Courier 10	
	Prestige Elite	
	Compressed	
	Optional Font Card with 2 Fonts per Card	
Paper Handling	Standard Push Tractors with Automatic Sheetloading and Paper Parking; Optional Single and Double Bin Cut Sheet Feeders	
Acoustic Noise	55 dBA	
Interfaces	Centronics Parallel or RS232C Serial	
Emulations	IBM® Proprinter XL® IBM Graphics Printer® Diablo 630® API, Epson JX80® (with Color Option)	
Color Option	User Installable Kit	

A COMPANY WITH CHARACTER AND DRIVE

**FUJITSU**

**FUJITSU AMERICA**  
Computer Products Group

**FOR MORE INFORMATION ON THE DL3000 SERIES PRINTERS, CALL 800-626-4686**



## Monitor Makers

*Since the monitors available for microcomputers are too numerous to give here, this list contains only contact information for the companies that make the monitors*

**Amdek Corp.**<sup>1,2,A,B</sup>  
1901 Zanker Rd.  
San Jose, CA 95112  
(800) 722-6335  
(408) 436-8570  
**Inquiry 968.**

**American Research Corp.**<sup>1,2,B</sup>  
1101 Monterey Pass Rd.  
Monterey Park, CA 91754  
(800) 423-3877  
(213) 265-0835  
**Inquiry 969.**

**AOC International**<sup>F,A,B</sup>  
10991 Northwest Airworld Dr.  
Kansas City, MO 64153  
(816) 891-8066  
**Inquiry 970.**

**Apple Computer, Inc.**<sup>1,2,A,M</sup>  
20525 Mariani Ave.  
Cupertino, CA 95014  
(408) 996-1010  
**Inquiry 971.**

**AST Research, Inc.**<sup>1,2,B</sup>  
2121 Alton Ave.  
Irvine, CA 92714  
(714) 863-1333  
**Inquiry 972.**

**Axtel, Inc.**<sup>2,B,M</sup>  
18848 Arbutus St.  
Fountain Valley, CA 92708  
(714) 963-6790  
**Inquiry 973.**

**Aydin Controls**<sup>1,B,M</sup>  
414 Commerce Dr.  
Ft. Washington, PA 19034  
(215) 542-7800 ext. 229  
**Inquiry 974.**

**Beltron Computer Systems, Inc.**<sup>1,B</sup>  
2215 North Broadway  
Los Angeles, CA 90031  
(213) 222-9680  
**Inquiry 975.**

**BFA Sales**<sup>1,A,B</sup>  
8401 Washington Place NE  
Albuquerque, NM 87113  
(505) 828-9100  
**Inquiry 976.**

**Blue Chip International**<sup>1,2,B</sup>  
7305 West Boston Ave.  
Chandler, AZ 85226  
(602) 961-1485  
**Inquiry 977.**

<sup>1</sup> = Color or RGB monitors available  
<sup>2</sup> = Monochrome monitors available  
<sup>A</sup> = Apple II, IIe, IIc, or IIGS compatible  
<sup>B</sup> = IBM PC, XT, AT, RT, or PS/2 compatible  
<sup>C</sup> = Compaq compatible  
<sup>D</sup> = Data General compatible

<sup>K</sup> = Kaypro compatible  
<sup>M</sup> = Mac 512, SE, Plus, or II compatible  
<sup>N</sup> = NEC compatible  
<sup>P</sup> = Sperry compatible  
<sup>R</sup> = Tandy compatible  
<sup>S</sup> = Sanyo compatible  
<sup>T</sup> = AT&T compatible  
<sup>U</sup> = Unisys compatible  
<sup>Z</sup> = Zenith compatible

**C. Itoh Electronics**<sup>1,2,A,B</sup>  
2505 McCabe Way  
Irvine, CA 92713  
(714) 660-1421  
**Inquiry 978.**

**Carroll Touch**<sup>1,2,B</sup>  
P.O. Box 1309  
Round Rock, TX 78680  
(512) 244-3500  
**Inquiry 979.**

**Chugai International Corp.**<sup>1,B</sup>  
55 Mall Dr.  
Commack, NY 11725  
(516) 864-9700  
**Inquiry 980.**

**Colorgraphic Communications Corp.**<sup>1,B</sup>  
5388 New Peachtree Rd.  
P.O. Box 80448  
Atlanta, GA 30366  
(404) 455-3921  
**Inquiry 981.**

**Compaq Computer Corp.**<sup>1,C</sup>  
20555 FM 149  
Houston, TX 77070  
(800) 231-0900  
**Inquiry 982.**

**Compuadd Corp.**<sup>1,2,B</sup>  
12303-G Technology Blvd.  
Austin, TX 78727  
(800) 531-5475  
(512) 250-1489  
**Inquiry 983.**

**Conrac**<sup>1,2,B</sup>  
Display Products Group  
1724 South Mountain Ave.  
Duarte, CA 91010  
(818) 303-0095  
**Inquiry 984.**

**Control Systems, Inc.**<sup>1,B</sup>  
2675 Patton Rd.  
P.O. Box 64750  
St. Paul, MN 55164  
(800) 826-4281  
(612) 631-7800  
**Inquiry 985.**

**Cornerstone Technology**<sup>2,B,M</sup>  
1883 Ringwood Ave.  
San Jose, CA 95131  
(408) 279-1600  
**Inquiry 986.**

**Corvus Systems, Inc.**<sup>1,2,B</sup>  
160 Great Oaks Blvd.  
San Jose, CA 95119  
(800) 426-7887  
(408) 281-4100  
**Inquiry 987.**

**CTX International**<sup>1,2,A,B,C,M,N</sup>  
260 Paseo Tesoro  
Walnut, CA 91789  
(714) 595-6146  
**Inquiry 988.**

**Data General Corp.**<sup>1,2,B,D</sup>  
North American Sales Division  
4400 Computer Dr.  
Westboro, MA 01580  
(617) 366-8911  
**Inquiry 989.**

**Datafox, Inc.**<sup>2,B</sup>  
2215 East University  
Phoenix, AZ 85034  
(800) 821-6317  
(602) 275-2072  
**Inquiry 976.**

**Dotronix, Inc.**<sup>1,2,B</sup>  
160 First St. SE  
New Brighton, MN 55112  
(612) 633-1742  
**Inquiry 977.**

**E-Machines, Inc.**<sup>2,M</sup>  
9305 Southwest Gemini Dr.  
Beaverton, OR 97005  
(503) 646-6699  
**Inquiry 378.**

**Electro Mechanical Systems**<sup>2,B</sup>  
801 West Bradley  
Champaign, IL 61820  
(217) 359-7125  
**Inquiry 379.**

**Electrohome, Ltd.**<sup>1,2,B</sup>  
809 Wellington St. N  
Kitchener, Ontario  
Canada N2G 4J6  
(519) 744-7111  
**Inquiry 380.**

**4Site Technologies, Inc.**<sup>1,M</sup>  
Machroma Division  
200 Seventh Ave., Mail Stop 250  
Santa Cruz, CA 95062  
(800) 634-7483  
**Inquiry 381.**

**Goldstar Electronics International, Inc.**<sup>1,2,A,B</sup>  
1050 Wall St. W  
Lyndhurst, NJ 07071  
(800) 562-0244  
(201) 460-8870  
**Inquiry 382.**

**Greatwest Technology**<sup>1,2,B</sup>  
SYSDYNE Products Division  
P.O. Box 30728  
Oakland, CA 94604  
(415) 639-2000  
**Inquiry 383.**

**Hitachi Sales Corp. of America**<sup>1,2,A,B</sup>  
401 West Artesia Blvd.  
Compton, CA 90220  
(213) 537-8383  
**Inquiry 384.**

**Hyundai Electronics America**<sup>1,2,B</sup>  
4401 Great America Pkwy.  
3rd Floor  
Santa Clara, CA 95054  
(408) 986-9800  
**Inquiry 385.**

**IBM Corp.**<sup>1,2,B</sup>  
Old Orchard Rd.  
Armonk, NY 10504  
(914) 765-1900  
**Inquiry 386.**



**IMC Computer, Inc.**<sup>1,2,B</sup>  
11100 South Wilcrest St., Suite H  
Houston, TX 77099  
(713) 561-8857  
**Inquiry 387.**

**Indtech, Inc.**<sup>1,2,B</sup>  
1349B Moffett Park Dr.  
Sunnyvale, CA 94089  
(408) 743-4300  
**Inquiry 388.**

**Industrial Computer Source**<sup>1,B</sup>  
5466 Complex St., Suite 208  
San Diego, CA 92123  
(800) 523-2320  
(619) 279-0084  
**Inquiry 389.**

**Intecolor Corp.**<sup>1,B</sup>  
225 Scientific Dr.  
Technology Park  
Norcross, GA 30092  
(404) 449-5961  
**Inquiry 390.**

**Kaypro Corp.**<sup>1,2,B,K</sup>  
533 Stevens Ave.  
Solana Beach, CA 92075  
(800) 452-9776  
(619) 481-3900  
**Inquiry 391.**

**Kimtron Corp.**<sup>1,2,B</sup>  
1709 Junction Court  
Building 380  
San Jose, CA 95112  
(408) 436-6550  
**Inquiry 392.**

**Kraft Systems Co.**<sup>2,B</sup>  
450 West California Ave.  
Vista, CA 92083  
(619) 724-7146  
**Inquiry 393.**

**Link Computer, Inc.**<sup>1,2,B</sup>  
560 South Melrose St.  
Placentia, CA 92670  
(714) 993-6976  
**Inquiry 394.**

**Logitech, Inc.**<sup>1,B</sup>  
6505 Kaiser Dr.  
Fremont, CA 94555  
(415) 795-8500  
**Inquiry 395.**

**MAI Basic Four, Inc.**<sup>1,2,B</sup>  
14101 Myford Rd.  
Tustin, CA 92680  
(800) 854-3194  
(714) 731-5100  
**Inquiry 396.**

**MegaScan Technology**<sup>2,B</sup>  
4000 Kenneth Dr.  
Gibsonia, PA 15044  
(412) 443-5820  
**Inquiry 397.**

**Micro Cellular Comm.**<sup>1,2,A,B</sup>  
7100 West Camino Real  
Suite 402  
Boca Raton, FL 33433  
(407) 391-0808  
**Inquiry 398.**

**Micro Display Systems**<sup>2,B,M</sup>  
1310 Vermillion St.  
P.O. Box 455  
Hastings, MN 55033  
(800) 328-9524  
(612) 437-2233  
**Inquiry 399.**

**MicroGraphic Images**<sup>2,M</sup>  
439 Calle San Pablo  
Camarillo, CA 93010  
(805) 484-3799  
**Inquiry 400.**

**Microtouch Systems, Inc.**<sup>1,B</sup>  
10 State St.  
Woburn, MA 01801  
(617) 935-0080  
**Inquiry 401.**

**Microvitec, Inc.**<sup>1,A,B,C,M,T</sup>  
1943 Providence Court  
Airport Perimeter Business  
Center  
College Park, GA 30337  
(404) 991-2246  
**Inquiry 402.**

**Mitsuba Corp.**<sup>1,2,B</sup>  
650 Terrace Dr.  
San Dimas, CA 91773  
(800) 648-7822  
(714) 592-2866  
**Inquiry 403.**

**Mitsubishi Electronics America, Inc.**<sup>1,B,T</sup>  
991 Knox St.  
Torrance, CA 90502  
(213) 515-3993  
**Inquiry 404.**

**Moniterm Corp.**<sup>2,B</sup>  
5740 Green Circle Dr.  
Minnetonka, MN 55343  
(612) 935-4151  
**Inquiry 405.**

**Nanao USA Corp.**<sup>1,2,B,T</sup>  
23510 Teleo Ave., Suite 5  
Torrance, CA 90505  
(213) 325-5202  
**Inquiry 406.**

**NEC Home Electronics**<sup>1,2,B,M</sup>  
Personal Computer Products  
Division  
1255 Michael Dr.  
Wood Dale, IL 60191  
(800) 323-1728  
(312) 860-9500  
**Inquiry 407.**

**Orientec Corp. of America**<sup>2,B</sup>  
748 Monterey Pass Rd.  
Monterey Park, CA 91754  
(213) 268-4001  
**Inquiry 408.**

**Packard Bell**<sup>1,2,B</sup>  
21800 Oxnard St., Suite 700  
Woodland Hills, CA 91367  
(818) 716-2727  
**Inquiry 409.**

**Panasonic Industrial**<sup>1,B,N</sup>  
Computer Products Division  
2 Panasonic Way  
Secaucus, NJ 07094  
(201) 348-7000  
**Inquiry 410.**

**PDS Video Technology**<sup>1,2,M</sup>  
1152 Santa Barbara St.  
San Diego, CA 92107  
(619) 222-7900  
**Inquiry 411.**

**Personal Computer Peripherals Corp.**<sup>1,M</sup>  
4710 Eisenhower Blvd.  
Tampa, FL 33634  
(813) 884-3092  
**Inquiry 412.**

**Phillips Consumer Electronics Co.**<sup>1,2,B</sup>  
I-40 and Straw Plains Pike  
P.O. Box 14810  
Knoxville, TN 37914  
(615) 521-4316  
**Inquiry 413.**

**Planar Systems, Inc.**<sup>2,B</sup>  
1400 Northwest Compton Dr.  
Beaverton, OR 97006  
(503) 690-1100  
**Inquiry 414.**

**Princeton Graphic Systems**<sup>1,2,B,M</sup>  
601 Ewing St., Building A  
Princeton, NJ 08540  
(609) 683-1660  
**Inquiry 415.**

**QIC Research, Inc.**<sup>1,2,B</sup>  
1961 Concourse Dr., Suite C  
North San Jose, CA 95131  
(408) 432-8880  
**Inquiry 416.**

**Quadram Corp.**<sup>1,2,B</sup>  
One Quad Way  
Norcross, GA 30093  
(404) 923-6666  
**Inquiry 417.**

**Qubie**<sup>1,2,B</sup>  
509 Calle San Pablo  
Camarillo, CA 93010  
(800) 821-4479  
(805) 987-9741  
**Inquiry 418.**

**Quimax Systems, Inc.**<sup>1,2,B</sup>  
844 Del Rey Ave.  
Sunnyvale, CA 94086  
(800) 228-0530  
(800) 232-8282 in California  
(408) 773-8282  
**Inquiry 419.**

**Radius, Inc.**<sup>2,M</sup>  
404 East Plumeria Dr.  
San Jose, CA 95134  
(408) 434-1010  
**Inquiry 420.**

**Relisys**<sup>1,2,B</sup>  
320 South Milpitas Blvd.  
Milpitas, CA 95035  
(408) 945-1062  
**Inquiry 421.**

**Roland DG**<sup>1,2,B</sup>  
7200 Dominion Cir.  
Los Angeles, CA 90040  
(213) 685-5141  
**Inquiry 422.**

**Sampo Corp. of America**<sup>1,2,B</sup>  
Industrial Products Division  
5550 Peachtree Industrial Blvd.  
Norcross, GA 30071  
(404) 449-6220  
**Inquiry 423.**

**Samsung Electronics America, Inc.**<sup>1,2,A,B</sup>  
18600 Broadwick St.  
Rancho Dominguez, CA 90220  
(213) 537-6791  
**Inquiry 424.**

**Sanyo Business Systems**<sup>1,2,B,S</sup>  
Computer Division  
51 Joseph St.  
Moonachie, NJ 07074  
(201) 440-9300  
**Inquiry 425.**

**Sharp Electronics**<sup>1,2,A,B</sup>  
Systems Division  
P.O. Box 650  
Sharp Plaza  
Mahwah, NJ 07430  
(800) 526-0264  
(201) 529-9500  
**Inquiry 426.**

*continued*



**Sony Corp. of America<sup>1,3</sup>**  
Microcomputer Products Div.  
Sony Dr.  
Park Ridge, NJ 07656  
(800) 222-0878  
(201) 930-1000  
**Inquiry 427.**

**SuperMac Technology<sup>2,M</sup>**  
295 North Bernardo Ave.  
Mountain View, CA 94043  
(415) 964-8884  
**Inquiry 428.**

**Tandy/Radio Shack<sup>1,2,3,4</sup>**  
1800 One Tandy Center  
Fort Worth, TX 76102  
(817) 390-3700  
**Inquiry 429.**

**Tatung Co.<sup>1,2,3,4,5,6,7</sup>**  
2850 El Presidio St.  
Long Beach, CA 90810  
(213) 637-2105  
**Inquiry 430.**

**Taxan USA Corp.<sup>1,2,3,4,5,6,7</sup>**  
18005 Courtney Court  
City of Industry, CA 91748  
(818) 810-1291  
**Inquiry 431.**

**Tektronix, Inc.<sup>2,3</sup>**  
P.O. Box 14928  
Portland, OR 97214  
(800) 835-9433 ext. 100  
(503) 627-7111  
**Inquiry 432.**

**Texas Instruments, Inc.<sup>1,2,3</sup>**  
Data Systems Group  
P.O. Box 181153  
Austin, TX 78718  
(800) 527-3500  
**Inquiry 433.**

**Thomson Information  
Systems Corp.<sup>1,2,3,4,5,6</sup>**  
5731 West Slauson Ave.  
Suite 111  
Culver City, CA 90230  
(800) 325-0464  
(800) 237-9483 in California  
(213) 568-1002  
**Inquiry 434.**

**3A Computer Corp.<sup>1,2,3</sup>**  
45-56 Pearson St.  
Long Island City, NY 11101  
(718) 361-7878  
**Inquiry 435.**

**3Lynx Technologies  
Corp.<sup>1,2,3,4</sup>**  
1450 Searceel Lane  
San Jose, CA 95131  
(408) 432-8833  
**Inquiry 436.**

**Toshiba America, Inc.<sup>1,2,3,4</sup>**  
9740 Irvine Blvd.  
Irvine, CA 92718  
(714) 583-3000  
**Inquiry 437.**

**TW Casper Corp.<sup>1,2,3,4</sup>**  
2153 O'Toole Ave., Suite E  
San Jose, CA 95131  
(408) 922-0188  
**Inquiry 438.**

**Ultra-Comp<sup>1,2,3</sup>**  
2600 North Broadway  
St. Louis, MO 63102  
(314) 621-4999  
**Inquiry 439.**

**Unisys Corp.<sup>1,2,3,4,5,6,7</sup>**  
1 Unisys Place  
P.O. Box 418  
Detroit, MI 48202  
(313) 972-7000  
**Inquiry 440.**

**Wells American<sup>1,2,3</sup>**  
3243 Sunset Blvd.  
West Columbia, SC 29169  
(803) 796-7800  
**Inquiry 441.**

**WYSE Technology<sup>1,2,3</sup>**  
3571 North First St.  
San Jose, CA 95134  
(408) 433-1000  
**Inquiry 442.**

**Xtron Computer  
Equipment Corp.<sup>1,2,3,4</sup>**  
19 Rector St.  
New York, NY 10006  
(800) 854-4450  
(212) 344-6583  
**Inquiry 443.**

**Zenith Data Systems<sup>1,2,3,4,5,6,7</sup>**  
1000 Milwaukee Ave.  
Glenview, IL 60025  
(800) 842-9000  
(312) 391-7000  
**Inquiry 444.**

# Before you buy 7 books and 2 compilers, get the *C Workshop*.

C is a great programming language. Now the *C Workshop* makes it easy. Whether you're new to programming or a dBase pro. You get:

- Interactive tutorial with 100+ program examples
- Full-screen editor with popup menus
- Online help in context
- Standard "K&R" C compiler
- Coordinated 384-page book

The *C Workshop* guides you with feedback on your program exercises. It's like getting private lessons from your computer.

Only the *C Workshop* gives you everything you need to learn and use C in one economical package. Move among tutorial, editor and compiler with a key-stroke or two. It's all in RAM memory to give you instant response.



Here's the clearest presentation of C pointers you'll find. The *C Workshop* covers it all, from structured programming to advanced list techniques.

Write your own programs (up to 64K) or modules of a big project. Your code will move to virtually any other compiler.

Join companies like AT&T and thousands of people like Al Patrizio, who says, "What I learned in five days with your book and software has taken me over a month before."

ComputerWorld's William Zachmann advises, "I'd offer the *C Workshop*, an extremely well-done instructional package, to anybody on my staff who wanted one."

**Satisfaction guaranteed**  
or return in 30 days for refund. Order now and C how easy it is!

Call **(800) 888-0852**  
ext. 955. It's toll-free!

Or write Wordcraft, 3827 Penniman Av., Oakland, CA 94619. Only \$69.95 plus \$5 shipping (Priority Mail). In CA, add \$4.90 sales tax. Visa/MC/AmEx or check. Runs on IBM PC compatibles, uses 220K RAM.



# WAREHOUSE SALE

Order These Back Issues of *BYTE* and *Popular Computing* Before They're Gone Forever!

## BYTE

Limited Quantities — Order Now!

	1979	1980	1981	1982	1983	1984	1985
January							
February							
March							
April							
May							
June							
July							
August							
September							
October							
November							
December							
Inside the IBM PCs							

\$4.00 U.S. includes shipping and handling  
\$5.00 foreign includes shipping and handling

Available Issues

## Popular Computing

Limited Quantities — Order Now!

	1982	1983	1984	1985
January				
February				
March				
April				
May				
June				
July				
August				
September				
October				
November				
December				
Special Guide to Computers				

\$3.00 U.S. includes shipping and handling  
\$4.00 foreign includes shipping and handling

## Special Bound Copies of BYTE

- Volume I, Part 1— September 1975 through April 1976
- Volume I, Part 2— May 1976 through December 1976
- Volume II, Part 1— January 1977 through June 1977
- Volume III, Part 1— January 1978 through June 1978
- Volume III, Part 2— July 1978 through December 1978



\$9.95 U.S. includes shipping and handling  
\$11.95 foreign includes shipping and handling

Check enclosed. Payments from foreign countries must be made in U.S. funds payable at a U.S. bank.

Name \_\_\_\_\_

Address \_\_\_\_\_

City \_\_\_\_\_ State \_\_\_\_\_ Zip \_\_\_\_\_

Postcode \_\_\_\_\_ City \_\_\_\_\_

Country \_\_\_\_\_

Please indicate which issues you would like by checking (✓) the boxes.

Send requests with payments to:

BYTE Back Issues  
One Phoenix Mill Lane  
Peterborough, NH 03458  
(603) 924-9281

Charge:  VISA  MasterCard

Card # \_\_\_\_\_

Exp. Date \_\_\_\_\_

Signature \_\_\_\_\_





# PICK BIX BRAINS

## ... With a 10 Day Trial Membership

If you've thought about joining BIX before but weren't sure it was what you needed, now is the time to try it. Because now for a limited time, we're inviting you to try BIX for 10 days. If at any time during this 10 day trial period you don't feel BIX has made you a more knowledgeable microcomputer user, we'll refund your entire registration fee. You pay only for time spent on the system.\* (See log-on instructions for hourly rates).

Explore BIX in your home or office. Put its power to work for you and unleash your full microcomputer potential — programming, designing, specifying, researching — and more.

Try BIX for 10 full days and see what it can do for you. Explore more than 160 conferences. Access vendor support. Speak to expert consultants. Research new products and systems, and download public domain software.

### Prepare yourself for success

It takes a sharp mind and hard work to stay ahead, and having the right tools helps.

Today, you can put one of the most powerful instruments for career advancement to work for you: BIX.

- Learn about new products before they hit the market.
- Get quality marketplace feedback on the products you're thinking of purchasing before you invest.
- Research problems and find the solutions that no one else has been able to render.
- Access some of the most advanced public domain software available in the industry.
- Increase your working knowledge of micros to make more confident purchasing decisions and recommendations.

### Join BIX and arm yourself with the latest in microcomputer-related information

BIX's exclusive *Microbytes* newswire gives you complete, daily, up-to-date computer industry information. You'll gain insight from BYTE editors and writers who analyze new products and their potential impact, inform you of the latest mergers and acquisitions, and report late-breaking news from important seminars and conferences.

### Talk to colleagues worldwide

You'll stay on top of your company's

business with BIX's electronic mail service.

"Talk" to your east coast, west coast — even European — contacts all in the same day.

Or, simply communicate with other BIX users worldwide. Share information and ideas privately, or in conference.

### Choose any option for online access with a one time \$39 membership fee

- Use MasterCard, VISA or American Express and begin your 10 day trial use of BIX right now.
- The 10 day trial also applies if you open an individual pre-paid account on BIX. Trial commences once we open your account and notify you.
- Other billing options including qualified corporate accounts are available. (Sorry, our 10 day trial is not available for these accounts.) Call or write BIX for details.

Use credit cards for immediate access or call the BIX Helpline for information on any other payment option at, 1-800-227-2983 (from U.S. and Canada) 603-924-7681 (in New Hampshire and elsewhere).

Act now! Our 10 day trial offer is subject to cancellation at any time.

\* To notify BIX that you wish to discontinue service at any time during the trial period, call the BIX Helpline, and your entire membership fee will be refunded.

\*\* BIX can be accessed via Tymnet throughout the U.S. and Canada. For the Tymnet number nearest you, call the BIX Helpline or Tymnet at 1-800-336-0149.

† If your local Tymnet number is a toll call you will receive additional charges from your local phone company at their prevailing rate.

†† Continental U.S. Tymnet rates. Rates from other areas are available from BIX.



### BIX is easy to join

To log-on to **BIX**, simply:

Set your computer's telecommunications program for full-duplex, 8-bit characters, no parity, 1 stop bit OR 7-bit characters, even parity, 1 stop bit. Use 300 or 1200 baud.

Call your Tymnet number \*\* and respond as follows:

<b>Tymnet Prompt</b>	<b>You Enter</b>
Garble or request for "terminal identifier"	a
login:	bix<CR>
<b>BIX</b> logo/name:	bix.038 <CR>

Callers outside the U.S. who have a communicating computer or terminal and a packet switching account with their host country phone system

can reach **BIX** by entering 310690157800. To commence registration, enter the code listed at the **BIX** logo/name prompt.

After you register, you'll automatically be taken to the **BIX** Learn Conference, an online tutorial that will show you how to begin using the system immediately. Time spent in the Learn Conference is FREE. Complete system documentation will be sent to you within a few days.

Access time will be billed at the following hourly rates.†

**Off-Peak Time** \$11/hr. (\$9 **BIX**, \$2 Tymnet)††  
(7 PM - 6 AM weekdays, all day weekends and holidays)

**Peak Time** \$20/hr. (\$12 **BIX**, \$8 Tymnet)††  
(6 AM - 7 PM weekdays)

# **BIX**

BY TELEINFORMATION EXCHANGE

One Phoenix Mill Lane  
Peterborough, NH 03458



# BETWEEN MAN AND MACHINE

*New advances in user-interface technology could change the way we interact with our computers*

*Ernest R. Tello*

**N**early a quarter of a century has passed since the publication of Marshall McLuhan's *Understanding Media*. During that time, the appearance of the personal computer has vindicated many of McLuhan's farseeing views. If he were alive today, he would probably characterize the personal computer as a marriage of several previous inventions: the clock, the calculator, the typewriter, and the television. But the personal computer is more than just a marriage of separate inventions. It is a unique medium that specializes in conducting marriages between different media and technologies.

McLuhan believed that electronics represents an extension of the human nervous system. If he was right, then the new technologies being developed at research centers represent a quantum leap in the ways that human beings will be able to extend themselves into the worlds of digital electronic simulation and control. And given the speed with which new ideas migrate into end-user products, you might be seeing some of these innovations sooner than you think.

## **Datahands and Databodies**

At present, getting data into a computer usually means typing it in or using a pointing device such as a mouse or trackball to interact with the screen. One company developing new ways of interacting with the computer is VPL Research of Redwood City, California. VPL specializes in devices that let you manipulate an on-screen "virtual" device that is the same shape as the actual input device. The firm now has two commercial products: the DataGlove and the DataSuit.

The DataGlove (see photo 1) is a hand-gesture interface invented by VPL's Thomas G. Zimmerman and Young L. Harvill. Used with advanced graphics workstations, the DataGlove lets you manipulate virtual tools and objects just as you would the real tools and objects they emulate. The DataGlove has applications in high-end graphics workstations, robotics, biomedicine, and human-factor engineering.

Running through the light material of the glove are treated

optical fibers that measure the degree of bending of the user's hand joints. The DataGlove also contains a magnetic sensor that tracks the absolute position and orientation of the top of the user's hand in reference to a magnetic source located within 30 inches of the glove.

A control unit connected to the glove transmits the position and orientation of the hand and the measured values of the hand joints to a host computer. The control unit can send this information, at up to 60 times per second, through the RS-232C or RS-422 port to your computer in a user-definable format. Using a Macintosh Plus, SE, or II, or an IBM PC, XT, or AT, you can create personalized calibration files and a library of your own gestures.

Recognizing and representing human hand gestures is a challenge that rivals speech and handwriting recognition in its potential difficulty. Gestures range from symbolic signals or commands, such as the peace sign, to dynamic actions such as grasping, lifting, tossing, and squeezing. VPL researchers have developed a technique in which they use dynamic-gesture templates and perform a finger-by-finger evaluation to match gestures with these templates.

VPL's newest product, the DataSuit (see figures 1a and 1b), is a whole-body input device that, using the same principles as the DataGlove, captures, records, and displays the movements of the human body. The DataSuit is used in applications such as kinesthetic learning, monitoring and feedback of certain aspects of human performance, and simulations for training personnel in hazardous environments. It can track up to 68 joints of a person's body moving within a 10- by 14-foot area.

The DataSuit system relies on software called Body Electric, a name derived from a poem by Walt Whitman and subsequently used by science fiction author Ray Bradbury. The software drives a graphical animation of a stick-figure representing the user. Body Electric incorporates a dataflow language called Flex, a hierarchical interactive tree interface called Tree, and an interpreter called Script, to customize the applica-

*continued*





tion to the user's requirements.

VPL is developing a commercial version of the DataGlove, incorporating a more sophisticated tactile-feedback system that will allow you to actually feel virtual objects that exist only on the computer screen. This system will evolve into *force-feedback*, a technology that will constrain your hand when it comes into "contact" with the virtual object.

### The Force

Systems that imply force-feedback technology are being studied at other institutions, such as George Washington University, where Teresa W. Bleser, John L. Sibert, and their coworkers have created an intriguing artists' paint system.



**Photo 1:** The DataGlove is a device that uses optical fiber sensors to measure and evaluate the range of joint movements, hyperextension, and abduction in the hand.

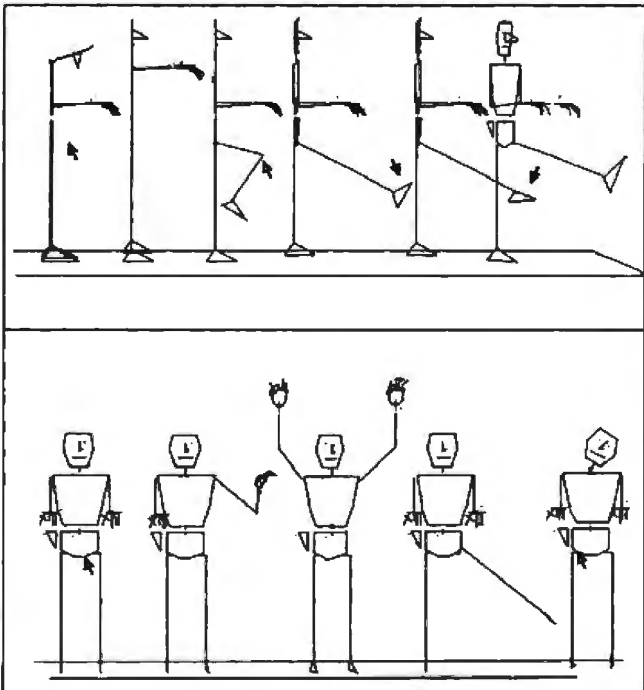

**Figure 1a:** On an animation called *Clint*, you can see some of the real-time output from the DataSuit.

With this technique, called *GWPaint*, artists use a data tablet that senses not only the position of their drawing stylus, but also its orientation and the amount of force they apply. The computer uses this information to simulate the articulation of a piece of charcoal. When the stylus senses that the artist is applying downward force, it dynamically increases the width of the line. The computer can also vary the texture of the line with the angle of attack.

Another force-feedback device, the *joysting* (see figure 2), was invented by John Staudhamer of the University of Florida at Gainesville, and modernized and developed by Richard J. Feldman of the National Institutes of Health in Bethesda, Maryland. The *joysting* consists of a T-shaped hand grip whose vertices are kept in a state of tension by three taut, thin guy wires. Force sensors at the ends of the wires measure the force produced by various twisting movements of the user's hand and transmit that information to the computer. The computer, in turn, directs servo motors to exert the equivalent forces in real or virtual environments. In effect, the *joysting* recognizes and communicates the force and torque that you generate.

In settings where temperatures or other conditions make it impossible for humans to be physically present but where dexterity and strength are essential, force-feedback systems measure and mimic the delicate dynamics of our arms and hands. Another area in which this technology has been used is for remotely operated telerobots like those that handle radioactive materials. Applications such as physical therapy and athlete training systems could also emerge, using sophisticated tactile-sensing and feedback systems.

### Eyeing the Future

Although magicians often claim that the hand is quicker than the eye, in some applications the hand may be too slow—or too busy doing something else—to interact with a computer. A technology called *eye tracking* makes the human eye a computer-input device for such situations.

Perhaps naturally, one of the first organizations to show a serious interest in eye-tracking technology was the U.S. Air Force. However, the results of research in this area make it clear that there are more applications for it than in fighter jets.

Basically, eye tracking works by using special cameras that lock onto the eye, then bounce a beam off its cornea and continually record the direction in which the light is reflected. Current techniques allow resolution fine enough to determine

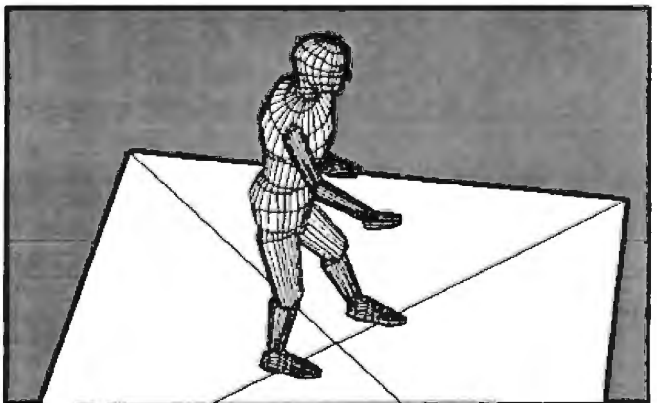

**Figure 1b:** *Ralph* is a post-processed animation driven by the DataSuit. Potential applications for the DataGlove and DataSuit include high-end workstations, robotics, biomedicine, and human-factor engineering.

which word on a computer screen you're focusing on. Various software systems have been devised for making use of this kind of information. For example, when coupled with a natural-language processing system and voice recognition, such a system would let you glance at a word and ask various questions about it, such as its meaning and other occurrences of the word.

Another scheme is graphical-display software programmed to respond dynamically to the user's focus of attention. Such systems could determine that you were focusing your eyes on one specific portion of the screen display and alter the display accordingly—bringing a window to the foreground of the screen, for instance.

Several eye-tracking projects are currently under way by both universities and commercial firms. At Texas A&M University, there has been ongoing research on an eye-tracking system using the frames of eyeglasses equipped with infrared-emitting diodes and phototransistors. Basically, this device uses electro-optical sensing in such a way that the positioning of the eye determines the amount and intensity of the light emitted to the phototransistors.

Because the eye's response time is so rapid (20 to 30 milliseconds) you could conceivably give a computer commands with your eyes much faster than with your hands or even a mouse. Applications for a system like this include aircraft and air traffic control handling, wheelchair maneuvering, and certain types of microsurgery.

Sentient Systems Technology of Pittsburgh, Pennsylvania, develops eye-tracking systems for use mainly by health care personnel and handicapped persons. The Eye-Typer 300, an eye-gaze-controlled keyboard system, lets you enter information into a computer by focusing your eyes for a specified amount of time (called dwell-time) on LEDs positioned like a checkerboard around the edge of the unit. The camera, centrally located in the device, measures the reflection of an infrared light on your cornea relative to a reflection on a "target" worn on your face just below the eye. If you want, you can customize the specific fields on the face of the unit to represent words, phrases, or pictures.

You can plug the Eye-Typer 300 into an IBM PC, XT, or AT. You can send your input out the RS-232C port to a printer. A one-line liquid crystal display (LCD) across the bottom of the computer lets you see your input. As you "type" each letter, word, phrase, or picture with your eyes, the computer repeats it back to you using an embedded speech synthesizer. When you hit a carriage return, the computer repeats the entire sentence you have just entered. You can also use this device to operate an environmental control system and, for example, work lights, televisions, and other appliances.

A request from NASA led Analytics of Willow Grove, Pennsylvania, to come up with OASIS (Ocular Attention Sensing Interface System), an eye-tracking system that uses a combination of eye and voice input. With OASIS, without taking your hands off the controls of your airplane or car, you can, for instance, look at an analog gas gauge, ask it exactly how many gallons are left in the tank, and get a vocal answer.

The OASIS device consists of eye-position and voice-processing firmware, eye-tracking signal processing, and head-motion algorithms. Analytics provides the type of customized application I/O or interface software you would need to work with your existing system or create a complete system from scratch.

Another possible application for OASIS would be providing quality control functions on, for example, a widget production line. As the widgets go by, you would look at each one and speak into a microphone (either placed in your helmet or re-

motely embedded between the monitor and a keyboard), saying the words "Accepted" or "Rejected." The widgets would drop into the proper bins by themselves, without your having to stop to look down and write, or physically throw the widgets into "good" or "bad" bins. In this type of interface, your eye position works as the cursor, and your voice operates as a button, in place of computer keys.

### Talk to Me

Systems that let you talk to your computer, long a staple of science fiction, are just now appearing as commercially available systems for desktop computers. Generally, these voice-recognition systems have a vocabulary in the range of 1000 to 10,000 words and have to be trained to recognize individual users' voices. Another limitation is that with most of these devices, you have to adjust your phrasing and choice of vocabulary to the machine.

Ray Kurzweil, the creator of the "voice typewriter," optical character readers, and music-synthesis devices, is the founder of Kurzweil Applied Intelligence in Waltham, Massachusetts. Kurzweil has produced a 5000- to 10,000-word voice-recognition system that consists of a printed circuit board and proprietary software for use with an 80386-type personal computer.

The Voice RAD and Voice EM systems let you talk directly into your machine, which can then send the information to your printer for text output. You still have to train the computer to recognize your voice, but you can customize your output by inputting "voice macros"—that is, teach your system words that

*continued*

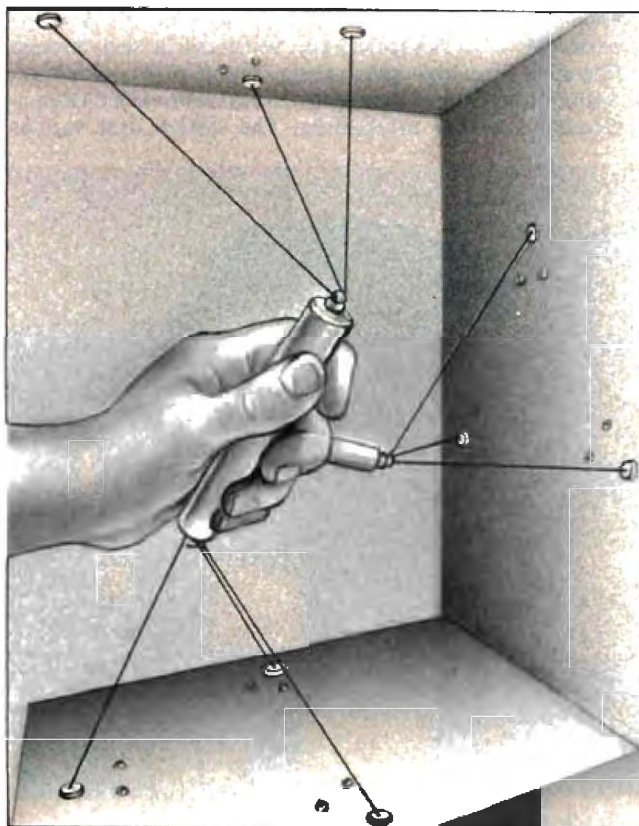

**Figure 2:** The joystick is a force-feedback device that recognizes and communicates the force and torque that you generate.



stand for complete phrases. Used largely by the medical community, the systems let doctors dictate a patient's medical findings or x-ray results into their computers and, without having to go through a transcriptionist, immediately receive a hard copy of the information.

Creating workable real-time speech-recognition systems will require some very advanced hardware—perhaps computers that use parallelism or the concept of neural networks. Among the companies and universities currently tackling this problem are BBN Laboratories and Thinking Machines, both of Cambridge, Massachusetts; Battelle Institute Columbus Labs in Columbus, Ohio; and Carnegie Mellon University in Pittsburgh, Pennsylvania.

### Heads Up

At the Aerospace Human Factors Research Division of NASA's Ames Research Center in Mountain View, California, scientists have combined three of the most promising new interface technologies into one integrated environment. The Virtual Interactive Environment Workstation (VIEWS) uses head-tracked and head-mounted displays, gesture-tracking, and voice input and output. (NASA's Langley research branch is also working on head-mounted VIEWS devices. See photo 2.)

VIEWS consists of a head-mounted stereoscopic display that projects a wide-angle three-dimensional panorama, which you can control with your head movements, voice commands, and hand gestures. The system lets you explore a 360-degree field of vision that can be either a simulated or remotely sensed environment, and you can have direct interaction with its virtual components.

The head-mounted display unit uses two medium-resolution monochrome LCD display screens, which can be seen through a wide-angle binocular optics viewer. The display is coordinated with the user's head movements in real time via a 6-degree-of-freedom tracking mechanism. The system uses various



**Photo 2:** Used as a research tool at NASA's Langley facility, this helmet is a flight simulator that enables pilots to try out technologies such as eye tracking, voice recognition and synthesization, and three-dimensional graphics displays.

video mixing and switching devices, combining both commercially available and custom equipment to merge images from a variety of sources into a single integrated representation.

VIEWS also incorporates a commercially available binaural, three-dimensional sound system. With headphones, you can hear sounds, either from within or outside your immediate field of view. A speech-recognition module lets you give vocal commands in a natural, conversational manner.

NASA's interest in these technologies stems from its desire to incorporate on the planned space station an implementation of the concept of "telepresence"—the ability to put yourself into almost any environment you can envision. The agency has committed itself to using the most advanced user-interface technology for control of autonomous and semi-autonomous telerobotics devices.

### Breeding Ideas at MIT

The MIT Media Lab in Cambridge, Massachusetts, is a well-spring of human-machine interface research. Since the early 1970s, people such as Nicholas Negroponte, director of the Media Lab, and Seymour Papert, director of the Learning Research Group and head of the School of the Future project, have been actively working to develop novel ways for humans and machines to interact.

Papert's research has had wide-ranging benefits, such as the Logo programming language and the field of Turtle Geometry. Negroponte's interest in the expressive communication of the human body encompasses the subtle expressions of the face—particularly the eyes and lips.

One of the projects under Negroponte's direction involved research with a full-body optical tracking suit that allows a computer to record the expressive movements of the entire human body. These recorded movements were used to drive a computer-animation system called the "Graphical Marionette," an undertaking that is part of ongoing work being sponsored by the Japanese Broadcasting Corp.'s NHK-TV. In another of his ventures, Negroponte studied how the human sense of "presence" (i.e., audio and visual representations of a person) might be captured and transmitted over long distances via various media.

Delle Maxwell, a graduate of Negroponte's program, made use of her graphical animation background when she worked on NHK-TV's Dr. Holon project. This venture involved the creation of a (pre-Max Headroom) computer-generated TV-show host that, through hand gestures, could express emotion and personality while also walking and turning its body.

Another MIT Media Lab graduate student, Steve Strassman, has made an impressive achievement with his Hairy Brushes program. Hairy Brushes lets an artist "dip" a virtual paintbrush into different types of ink, use fast or slow drawing, apply splatter effects, and even simulate a drybrush style.

### Strength in Synergy

As evidenced at Ames Research Center and MIT's Media Lab, the fullest potential for advanced user interfaces could come through the use of a combination of two or more interface technologies. By using more than one interface technology at a time, you can overcome the limitations of each; thus, the user can work in a way that is more natural. For example, using a natural-language interface combined with some type of pointing interface—whether a mouse, a datahand, or perhaps even an eye tracker—could simplify complex language-parsing problems and save precious CPU time for other tasks.

Eventually, full-body tracking suits may become valuable for systems that use video-camera-based vision systems to de-



## A Stick with a Difference

Janet J. Barron

If it's important that you keep your hands on the wheel of your car while you are driving, think how important it is that pilots keep their hands on the controls of the plane while they are flying. A new user interface invented by scientists at NASA's Langley Research Center in Hampton, Virginia, lets pilots do just that. It is called the Thumball, a joystick with a trackball installed on it.

The Thumball was developed to enable pilots of military and commercial planes to make adjustments to the plane's electronic data system without taking their hands off the controls. With this device (see figure A), they can precisely enter data, position a cursor, and receive digital readouts in two axes on a CRT screen. Pilots will be able to use it to make changes in heading, pitch, or trim, or to make other precise adjustments. Currently, and until the Thumball becomes commercially available, pilots must take their hands off the controls and turn knobs to provide these functions.

The Thumball's mechanism, called a *spherical integrator*, works like an optoelectronic mouse. A pilot will be able to operate the device with his thumb while his hands remain on the controls. So far, only one of the devices exists. It is installed in the cockpit of a simulator at Langley for testing.

The Thumball is one step in NASA's development of the concept of a "Glass Cockpit." In this project, NASA is placing all the aircraft's controls and readings on one CRT display. This way, pilots can have a wider field of view than they now have and can see all the readings by looking at one screen instead of a whole bank of instruments.

In Boeing 757s and 767s, the Glass Cockpit's beginnings are already in place, says NASA's H. Douglas Garner.

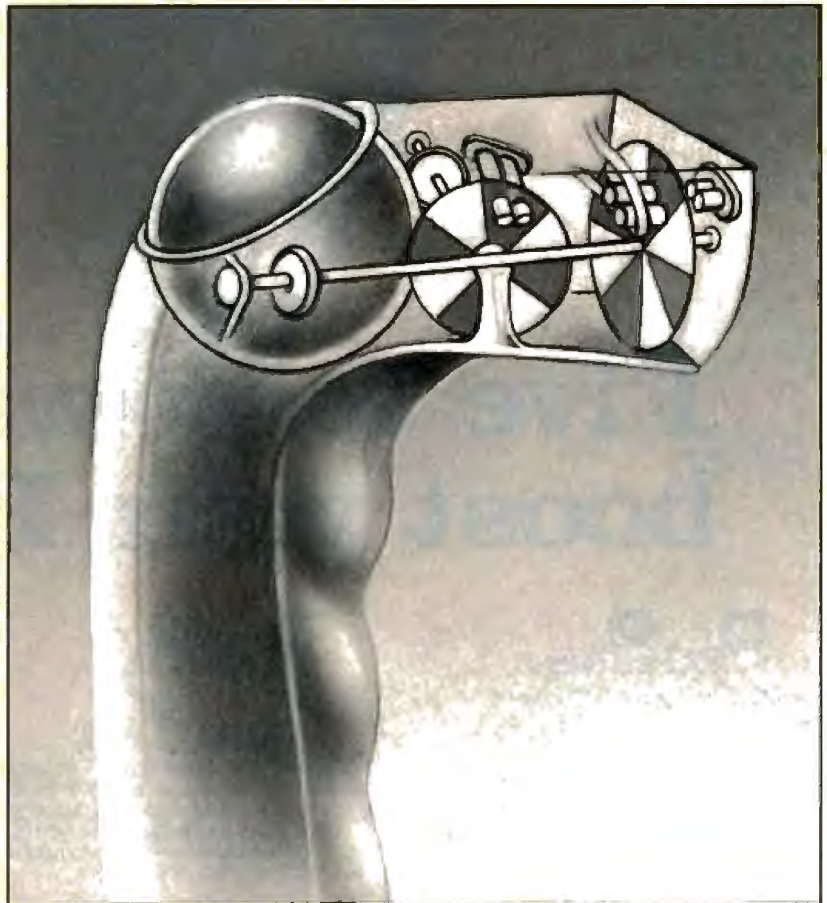

Figure A: The Thumball, a joystick with a mouse on top, lets pilots enter data into their flight computers without taking their hands off the jet's controls.

While in flight, the pilots and the passengers are able to "see" where they are geographically. In the cabin, passengers can watch large projection screens showing macro and wide-angle representations of the plane's position.

The Thumball was created by Gar-

ner, Anthony M. Busquets, Thomas W. Hogge, and Russell V. Parrish of NASA's Langley Research Center.

Janet J. Barron is a BYTE technical editor. You can reach her on BIX as "neural."

rive gesture-recognition and other types of pattern-recognition data. With advances in artificial intelligence techniques, object-oriented programming, and graphics methodologies, you may someday soon be working in a three-dimensional simulation of an office environment. Such a setting would allow you to zoom in on objects not physically in sight or available for your use (such as a filing cabinet), extract information from the object (say, a letter or document), and manipulate the data with tools, such as a pair of virtual scissors.

In the end, the real key to advanced user-interface technol-

ogy lies in the development of software with enough intelligence to provide synergism between you and the machine. As user interfaces become more sophisticated, talking to our computers could become as natural as talking to each other—with all the speed, variety, and subtle nuances that implies. ■

Ernest R. Tello of Santa Cruz, California, is a contributing editor for BYTE and the author of *Mastering AT Tools and Techniques* (Indianapolis, IN: Howard W. Sams). He can be reached on BIX as "editors."





# Five easy ways to boost your BASIC

## PROBAS™ Professional Basic Programming Library

PROBAS is a library of 232 routines that kicks BASCOM and QuickBASIC into 5th gear and gives you powers and abilities far beyond those of mortal men. So much for the hype, now down to brass tacks:

- 600 page 3-part manual
- Full-featured windowing
- Screen snapshots
- Virtual screens in memory
- Lightning-fast file I/O
- Full mouse support

Plus over 200 essential services from directory and equipment routines to handy string, date, time, and input routines. For all versions of QuickBASIC and BASCOM including BASCOM 6.0 for OS/2. Just \$99.00!

## PROREF™ On-Line Help For PROBAS

PROREF is a pop-up help system for the 232 routines in PROBAS, pop-up help for your routines, and an extension of the QuickBASIC programming environment. See the calling syntax and help for any PROBAS routine, or any of your routines, with just a few keystrokes or mouse clicks. Pop-up and ASCII chart, calculator, keyboard scan code module or almost any DOS program via hot-key. Just \$50.00!

## PROBAS™ TOOLKIT

The TOOLKIT is a collection of assembly and BASIC modules that use the PROBAS library to save you even more hours of grunt work. Why spend hundreds of hours re-inventing the wheel when you can just plug in TOOLKIT modules like:

- Menu Generators
- Fast B-tree indexing
- Mini-editor with word-wrap
- Patch .EXE files
- Protected storage areas
- Julian date routines

Plus clock, calendar, BCD math routines, and much more. Complete with BASIC source code and comprehensive manual. The PROBAS adds capabilities and helps conserve your most valuable asset of all, time! Requires PROBAS. Just \$99.00!

## PROSCREEN™ Professional Screen Management System

PROSCREEN is a full-featured screen generator/editor that will save you more design and coding time than you ever thought possible. PROSCREEN works with screens like a word processor works with text to provide complete control over screen characters, placement and colors. PROSCREEN comes with subroutine source, extensive on-line help and a 285 page manual with tutorial and reference. Just \$99.00!

## PROBAS™ TELECOMM TOOLKIT

The PROBAS TELECOMM TOOLKIT is a collection of high-level communications modules that you plug into your code to provide popular file transfer protocols, terminal emulations, login scripts and baud rates up to 57,600 bps. You get:

- Xmodem/Modem7/Xmodem-1k
- Ymodem (single and batch)
- CRC-16 and Checksum
- VT52, VT100, ANSI BBS etc.
- Auto Dialer & data base
- Documented BASIC source

Why use clumsy SHELLs to complex terminal programs when you can plug just the communications routines you need into your code? Implement just the features, and commands you want. Requires PROBAS. Just \$75.00!

Our thirty day, money-back guarantee assures you the highest quality and our technical support staff is always ready to help. Try our BBS at (301) 953-7738 or give us a call at:

**HAMMERLY**  
COMPUTER SERVICES, INC.

8008 SANDY SPRING ROAD • LAUREL, MD 20707

**(301) 953-2191**

Add \$3.00 per item (\$7.00 Canada) for shipping. Trade-marks ProBAS, ProREF, ProSCREEN: Hammerly Computer Services, Inc. QuickBASIC, BASCOM: Microsoft Corp.

Circle 116 on Reader Service Card

# THE BASIC REVIVAL

*The "beginner's" language has significant new features and a structured approach*

*Namir Clement Shammas*



his year marks a quarter of a century since the birth of BASIC at Dartmouth College. Just as people change and mature as they age, so has BASIC changed in 25 years.

The original BASIC interpreters became very popular because they were easy to use and widely available. But the advent of both the IBM PC family and Borland's very affordable, fast Turbo Pascal compilers opened the eyes of many BASIC programmers who had pushed the language to its limits. BASIC implementations, such as Applesoft BASIC and Microsoft BASIC, lacked many important features, such as callable subroutines, multiline functions, and local variables. In addition, Pascal already had a better reputation as a neat, structured language that fostered efficient modular coding.

Correcting these shortcomings, as well as other faults, has led to a BASIC revival. The new ANSI BASIC standard includes many new features, some of which have outdone Pascal, Modula-2, and even C. And the ANSI standard serves as a launching point for a number of BASIC implementations, such as True BASIC, Turbo Basic, and QuickBASIC, that also add their own extensions to the language.

## A Break with the Past

The new BASIC implementations do not require the use of the much-criticized line numbers. Instead, numeric or alphanumeric labels can direct jumps in program flow. Listings 1a and 1b compare the coding of the same program under BASICA and QuickBASIC, respectively. Notice that the line numbers are removed in listing 1b, and lines 1030 and 2000 of listing 1a are replaced with the more meaningful and highly readable labels `GetNum:` and `Center:`. Even if the line numbers 1030 and 2000 were kept in the QuickBASIC version, they would still be regarded as labels. Using labels is a more mature route for highlighting program locations relevant to unconditional or subroutine jumps.

Turbo Basic and QuickBASIC support new features related

to data objects: long integers, structures (in QuickBASIC), and formal dynamic and static arrays. In previous BASIC interpreters, integers were limited to 2 bytes; this, in turn, limited the record number of random-access files to 32,767. Thus, only half the range of integer values was useful to file I/O. The new long-integer types extend the range of whole numbers to 2 billion. Using long integers, you can not only reach the previously sought limit of 65,535 records, but also go well beyond that number (the limitations are imposed by the operating systems). You use the `&` suffix to declare a variable or a function as having a long integer.

QuickBASIC supports constants of all simple types, such as the following:

```
CONST MAX.DIM% = 100, MAX.REC& = 65535
CONST MISSING.DATA# = -1.0E30
```

The type-declaration character is not part of the constant, and it can be dropped when using the constant in the program. For this reason, constant identifiers are unique: No two constants can have the same name and have different data types.

The support of symbolic constants is something new and important to BASIC. Symbolic constants replace numbers or strings with more meaningful identifiers. They also make updating the same constant value throughout the program quick, easy, clear, and less error-prone. Structured languages such as Pascal, C, Ada, and Modula-2 also support constants.

Unlike the BASIC interpreters, the early BASIC compilers that worked with Microsoft BASIC and BASICA programs did not support dynamic arrays. Now, the Turbo Basic and QuickBASIC compilers support formal dynamic and static arrays. The `$STATIC` and `$DYNAMIC` compiler directives declare arrays as static or dynamic, respectively. You can also include the `STATIC` or `DYNAMIC` keywords with the `DIM` declarations to override the current default type of arrays.

You can erase and optionally redimension dynamic arrays at

*continued*



run time using the ERASE and DIM statements, respectively; applying ERASE to a static array merely assigns zero or null characters to its elements. True BASIC regards its arrays and matrices as dynamic. You can even redimension an array nondestructively to add more elements. BASIC's new support of dynamic arrays is very significant, since programs can now size up arrays and matrices on the fly. Languages like Pascal,

Modula-2, and C support dynamic arrays via dynamic memory allocations using pointers.

QuickBASIC 4.0 has introduced record structures that resemble those of traditional structured languages. To define a personal data record, for example, you declare the type PersonalRec as follows:

**Listing 1a: A BASICA program.**

```
1000 T$ = "Test Program" : GOSUB 2000
1010 T$ = "version 1.0" : GOSUB 2000
1020 PRINT : PRINT
1030 INPUT "Enter positive number ";X
1040 IF X <= 0 THEN 1030
1050 PRINT SQR(X)
1060 END
2000 ' Center string
2010 L = LEN(T$)
2020 PRINT SPC(40-L\2);T$
2030 RETURN
```

**Listing 1b: The QuickBASIC version of the program in listing 1a.**

```
T$ = "Test Program" : GOSUB Center
T$ = "version 1.0" : GOSUB Center
PRINT : PRINT
GetNum:
INPUT "Enter positive number ";X
IF X <= 0 THEN GetNum
PRINT SQR(X)
END

Center:' Center string
L = LEN(T$)
PRINT SPC(40-L\2);T$
RETURN
```

**Listing 2a: The BASICA version of a quadratic equation solver.**

```
1000 CLS
1010 PRINT "Solve for X in A*X^2 + B*X + C =
      0" : PRINT
1020 INPUT "Enter A, B, C "; A,B,C
1030 Determinant = B*B - 4*A*C
1040 IF Determinant > 0 THEN 2000
1050 IF Determinant = 0 THEN 3000
1060 ' solve for imaginary roots
1070 Root1 = B/2/A
1080 Root2 = SQR(-Determinant))/2/A
1090 PRINT "Root = ";Root1;" +/-i ";Root2
1100 END
2000 ' solve for real and different roots
2010 Root1 = (B + SQR(Determinant))/2/A
2020 Root2 = (B - SQR(Determinant))/2/A
2030 PRINT "Root1 = ";Root1;" Root2 = ";Root2
2040 END
3000 ' solve for real and equal roots
3010 Root1 = B/2/A
3020 PRINT "Roots are ";Root1
3030 END
```

```
TYPE PersonalRec
  PersonName AS STRING*30
  Profession AS STRING*40
  Age AS INTEGER
  Weight AS SINGLE
END TYPE
```

This QuickBASIC record is made up of a 30-character name field, a 40-character profession field, an integer-type age field, and a single-precision floating-point body-weight field. QuickBASIC records cannot contain fields that are either arrays or dynamic strings, but nested record declaration is allowed. Compare the above with a similar Pascal record:

```
Personal_Rec = RECORD
  Person_Name : STRING[30];
  Profession : STRING[40];
  Age : INTEGER;
  Weight : REAL;
END;
```

An array of records for the personal data is declared as

```
DIM People(MAX.PERSONS) AS PersonalRec
```

Thus, QuickBASIC 4.0 has introduced the syntax to declare new data-type identifiers—something new to the purist BASIC programmer.

**Beyond Simple Decisions**

Decision-making constructs are more sophisticated under the new BASICs. They include, in a nutshell, an expanded IF statement and a powerful new SELECT CASE. These arm the new ANSI BASIC with constructs found in structured languages. For example, the old one-line IF...THEN...ELSE statement can be extended into a multiline version. You can also use ELSE-IF clauses like those in Pascal.

Listing 2a shows a BASICA program that solves for the root of a quadratic equation. Listing 2b contains the Turbo Basic version, which uses an IF...THEN...ELSEIF...ELSE statement. Note the difference in code readability between the two versions. Listing 2c shows a Turbo Pascal version of the same program; notice how similar the IF statements are in listings 2b and 2c. The new multiline IF statement also shows that BASIC fosters structured coding and simultaneously demotes the use of GOTOS.

The SELECT CASE statement is a new decision-making statement that resembles the Pascal CASE and C switch statements—and, in fact, it's even more powerful than CASE and switch. It is similar to the IF...THEN...ELSEIF statement, but it lets you try several tests. Consider the following SELECT CASE statement in QuickBASIC:

```
SELECT CASE NumData
CASE IS <= 0 ' relational test
  ' same as IF NumData <= 0 THEN
  Message$ = "YOU HAVE NO DATA"
  ErrNum = 1
```

```

CASE 1,2,3 ' enumerated list
  Message$ = "TOO FEW OBSERVATIONS"
  ErrNum = 2
CASE IS 4 TO 30 ' a value range
  Message$ = "MINIMAL SAMPLE SIZE"
  ErrNum = 3
CASE ELSE
  Message$ = ""
  ErrNum = 0
END SELECT

```

This example illustrates the three basic types of CASE labels: relational test, enumerated list, and value range. The relational CASE label in BASIC extends the use of SELECT CASE in place of IF...THEN...ELSEIF statements beyond that of other structured languages. In addition, the CASE labels can include several clauses of various types; for example, the statement CASE 1,2,3, IS > 100, 10 TO 30 is acceptable.

Another important feature, found in QuickBASIC and Turbo Basic, is that the CASE labels can also contain expressions. These compilers will accept a statement like CASE x/y, IS > SQR(n+1), for example. The popular structured languages do not support this use of expressions in CASE labels. The SELECT CASE statement lets you construct very powerful multiway decision making.

BASIC has also expanded the number and types of loops. The previous BASIC interpreters provided the fixed-iteration FOR...NEXT loop and the conditional WHILE...WEND loop, and now the new ANSI standard also recognizes fixed, conditional, and infinite loops.

While the FOR...NEXT loop is still used in the new BASICs, the EXIT FOR statement now provides an elegant exit from that loop. There is also a DO...LOOP loop that provides the following versatile variations:

```

DO [WHILE <expression>]
  <loop statements>
LOOP [UNTIL <expression>]

```

The DO WHILE...LOOP loop is essentially the same as the conditional WHILE...WEND loop found in BASICA and Microsoft BASIC. The DO...LOOP UNTIL loop is new and resembles the REPEAT...UNTIL loops in Pascal and Modula-2. DO...LOOP is an open or infinite loop with parallels in Ada, C, and Modula-2, but not in Pascal.

Listing 3 shows a QuickBASIC program that employs DO...LOOP, DO WHILE...LOOP, and DO...LOOP UNTIL. Note that you can use a DO...LOOP with both the UNTIL and WHILE clauses; this serves to monitor the continuation of the loop when two conditions must apply. (The conditions are separated into the UNTIL and WHILE clauses to enhance logical readability.) You can use the EXIT DO statement to exit any type of DO...LOOP, especially the infinite type; listing 3 uses it to exit the outer DO...LOOP.

In general, the various forms of DO loops and the EXIT DO statement promote structured thinking and coding.

### New Functions and Subroutines

The new BASICs promote the more powerful multiline functions. The familiar DEF FN<name> function can now be spread over multiple lines; under many of the older BASIC interpreters, you had to mimic such functions using subroutines. The other type of function does not begin its name with the letters FN, so you must list it in DECLARE DEF statements.

Under the new BASICs, functions can be recursive. Listing 4

shows a recursive factorial function. As with any multiline function, END DEF marks the end of the function. The function result is returned by assigning an expression to the function identifier. Function arguments are passed by value and, except in True BASIC, cannot be arrays. With the multiline function, the new BASICs support the EXIT DEF statement to allow an

*continued*

#### Listing 2b: The Turbo Basic version of a quadratic equation solver.

```

CLS
PRINT "Solve for X in A*X^2 + B*X + C = 0" : PRINT
INPUT "Enter A, B, C "; A,B,C
Determinant = B*B - 4*A*C
IF Determinant > 0 THEN
  ' solve for real and different roots
  Root1 = (B + SQR(Determinant))/2/A
  Root2 = (B - SQR(Determinant))/2/A
  PRINT "Root1 = ";Root1;" Root2 = ";Root2
ELSEIF Determinant = 0 THEN
  ' solve for real and equal roots
  Root1 = B/2/A
  PRINT "Roots are ";Root1
ELSE
  ' solve for imaginary roots

  Root1 = B/2/A
  Root2 = SQR(-Determinant)/2/A
  PRINT "Root = ";Root1;" +/-1 ";Root2
END IF

END

```

#### Listing 2c: The Turbo Pascal version of a quadratic equation solver.

```

Uses CRT;

VAR A, B, C, Determinant, Root1, Root2 : REAL;

BEGIN

ClrScr;
Writeln('Solve for X in A*X^2 + B*X + C = 0');
Writeln;
Write('Enter A, B, C '); Readln(A,B,C);
Determinant := B*B - 4*A*C;
IF Determinant > 0 THEN BEGIN
  { solve for real and different roots }
  Root1 := (B + SQR(Determinant))/2/A;
  Root2 := (B - SQR(Determinant))/2/A;
  Writeln('Root1 = ',Root1,' Root2 = ',Root2)
END
ELSE IF Determinant = 0 THEN BEGIN
  { solve for real and equal roots }
  Root1 := B/2/A;
  Writeln('Roots are ',Root1)
END
ELSE BEGIN
  { solve for imaginary roots }
  Root1 := B/2/A;
  Root2 := SQR(-Determinant)/2/A;
  Writeln('Root = ',Root1,' +/-1 ',Root2)
END;

END.

```



# The Working Environment

As BASIC has matured and developed, the programming environment for developing software has also improved. Today's compiled BASIC packages offer integrated editors, file managers, debuggers, and a DOS interface. They are a far cry from the old interpreted BASIC environment.

## True BASIC

The True BASIC environment is notable for its simple visual appearance (see photo A). The screen is split into two areas: the command history and the screen editor. Typing Help provides you with on-line help for specific topics—which you'll need, because True BASIC does not display a menu for the available environment-related commands.

You can display any directory using the FILES command, with the default aimed at listing \*.TRU files in the current directory. True BASIC enables you to change directories, save the file currently being edited under a new name, update the edited file, or start a new one. You can also type True BASIC language statements from the command level. This lets you test pre-defined functions for proper use or examine results after a program terminates.

Typing RUN causes the program displayed by the editor to start executing. If the True BASIC compiler detects an error, it displays an error message and the line number in the command window. True BASIC points to the nature of the error and to the routines and files (if any) where the offending code is located; the editor does not automatically invoke other files that contain the located compile-time error. The compiler displays a list of errors found in the program.

True BASIC implements DO commands, which let you run secondary programs and external subroutines. Normally, the DO command invokes a utility that interacts with the program in the screen editor buffer. If the filename following the DO command contains a complete True BASIC program, then the invoked program performs a task not directly affecting the edited program; for example, you can invoke a menu-driven DOS shell program to format a disk, copy files, or delete files. Alternatively, you could invoke programs that provide on-line help to accompany your custom programs. But DO commands really shine when they invoke external subroutines that interact with the program in the editor. The True BASIC distribution disk provides external subroutines to perform program formatting, cross-referencing, and tracing via DO commands.

Another versatile feature of the True BASIC environment is the LOAD command, which lets you load BASIC libraries and modules, making them part of the language. This means that an executing program need not explicitly declare loaded libraries or modules, so compiling is faster. (True BASIC is actually a semicompiler that verifies the correctness of the entire program before it executes.)

## Turbo Basic

Turbo Basic's environment is similar to the well-received environment in Turbo Prolog (see photo B). The default setting features five windows, including the one-line main menu and the Edit, Message, Run, and Trace windows. The options in the main menu let you invoke the filer, edit a program, compile, compile/run, set compiler switches, select environment options, reconfigure windows, and set up debugging features. The main menu File option lets you manipulate selected files and directories, invoke the DOS shell, and exit.

The commands for the Turbo Basic editor are very similar to WordStar commands in nondocument mode. You can customize the key commands using the Install program. The main



Photo A: The True BASIC programming environment.



Photo B: The Turbo Basic programming environment.



Photo C: The QuickBASIC programming environment.



menu's Compile option features automatic debugging similar to that of True BASIC, except that if Turbo Basic finds an error in an included file, it will load that file into the editor.

Turbo Basic offers three classes of compiler options. The first lets you select the destination of the compiled code—to memory, or to an .EXE file. The second class specifies the compiler toggle switches, such as the 8087 requirement, keyboard break, checking bounds, detecting overflow, and stack checking. The third class of suboptions lets you directly enter the command-line arguments and specify the sizes for the stack, music buffer, and I/O communications. These sizes may also be specified by metacommands embedded in the source code.

The Setup and Window options let you fine-tune certain aspects of the Turbo Basic environment, such as colors, code directories (i.e., include, source, and compiled files), and window configurations. The Debug option permits you to turn tracing on or off, and the Run-Time Error suboption makes Turbo Basic display the message that accompanies the error instead of merely displaying an error number.

### QuickBASIC

The new QuickBASIC 4.0 environment (see photo C) comes with a number of very significant enhancements over previous versions. For example, it enables you to open new text windows to edit a specific function or subroutine. This new feature makes the environment responsible for locating your sought routine and placing its code in a separate window.

The QuickBASIC environment initially displays two windows. The editing window occupies most of the screen, and the one-line main menu is located right above it. The second, much smaller window contains two lines reserved for the immediate mode. This mode lets you type BASIC commands and execute them immediately, just as in BASICA or GWBASIC.

The File options perform functions similar to those in Turbo Basic, but with a few differences. The QuickBASIC environment permits you to load (and also unload) more than one file into memory. When the environment loads a QuickBASIC source code file, it precompiles it and (if it uses subroutines) builds an internal subroutine map. Pressing the F2 function key pops up a window that displays the name of the main routine(s) in memory, along with indented lists of subroutines. You use the cursor keys to select a main program or a subroutine. The QuickBASIC environment provides on-line help screens that show the editor's commands, an ASCII table, and the QuickBASIC keywords.

The QuickBASIC editor is connected with the QuickBASIC threaded p-code compiler/interpreter. When you type a line of code and then press Enter or move the cursor, the compiler verifies the new line and immediately flags any syntax error. The editor uses most WordStar nondocument editing commands.

The View options enable you to view code hierarchy and select a code segment, as discussed earlier. You can also view the next routine in the code hierarchy, the next statement, the output screen (even after program execution has terminated), and the code of included files.

The Run options let you create .EXE programs (as either stand-alone files or smaller files requiring the QuickBASIC run-time library), create compiled libraries, and start/restart a program in memory. The Debug options offer debugging tools. You can specify variables to be monitored in the Watch window, and you can also set breakpoints that stop the program when specific lines are reached or when specified expressions attain certain values. Other options let you trace the program execution and keep track of the last 20 statements executed.

early function exit. These enhancements undoubtedly give functions additional power; nevertheless, they still lag a bit behind those of languages like Pascal and C.

While GOSUBs can employ labels to direct their subroutine jumps, a new and more powerful class of callable procedures is taking their place. The procedures have a name and a parameter list. Parameters are passed by value or by reference—the general rule is that expressions are passed by value, and variables (simple or arrays) are passed by reference. Enclosing a simple variable in parentheses causes it to be passed by value, as an expression; QuickBASIC also supports the BYVAL keyword to explicitly specify that a parameter is to be passed by value. The parameter list is the main data interface between the procedure and the calling program unit. The variables in other programming units cannot be accessed or shared without special declarations.

An important feature in these procedures is the ability to handle arrays of any size. The LBOUND and UBOUND functions return the lower and upper array bounds, respectively; they work with both one-dimensional and multidimensional arrays. Turbo Basic implements these predefined functions slightly differently from the proposed ANSI standard (which QuickBASIC and True BASIC follow). With the LBOUND and UBOUND functions, you can write general-purpose routines for manipulating arrays and matrices much more easily than in Pascal or, to a lesser extent, Modula-2 and C.

BASIC procedures can have local variables. When using local arrays, you must dimension them early in the procedure and remove them before the end. While the BASIC implementations impose a strict data interface between the procedure and other programming units, they differ in implementing local variables and accessing (or sharing) global variables. In QuickBASIC, you declare local and global variables using STATIC and SHARED, respectively. SHARED variables can also be exported (i.e., created by the procedure and submitted to the pool of global variables). Turbo Basic uses the LOCAL, STATIC, and SHARED declarations to define local, static, and shared global variables within procedures. True BASIC places procedures before the unique END of a program, giving them access to all global variables. By contrast, procedures located beyond the END statement or in external libraries cannot share global variables. All the variables in these procedures are strictly local.

Listings 5a and 5b show the True BASIC and Turbo Basic versions of the same procedure. The listings illustrate using local variables and handling arrays of various sizes.

### Modular Approach

QuickBASIC and True BASIC implement modules. These, along with external libraries, foster a new level for structured programming in BASIC. True BASIC modules are made up of functions and procedures, as well as the following sections:

```
MODULE <name>

PUBLIC <list of exported variables>
PRIVATE <list of local routines>
DECLARE DEF <list of functions>
SHARED <list of variables global in module only>
<module initialization statements>
<function or subroutine declarations>
END
```

The PUBLIC declaration lists the names of simple variables and arrays exported to client programs. This creates public vari-

*continued*



**Listing 3: A QuickBASIC program that demonstrates DO...LOOP, DO...LOOP UNTIL, and DO WHILE...LOOP.**

```
CLS
DO

INPUT "Want to calculate a square root? ";A$
IF A$ = "" THEN A$ = "N"
A$ = UCASE$(LEFT$(A$,1))

IF A$ <> "Y" THEN EXIT DO ' exit main loop

DO
  INPUT "Enter a positive number ";X
  PRINT
  LOOP UNTIL X > 0

  S = X / 2
  DO WHILE ABS(S*S - X) > 0.000001
    S = (X/S + S) / 2
  LOOP

  PRINT "Square root of ";X;" = ";S : PRINT

LOOP

END
```

**Listing 4: A recursive function written in Turbo Basic.**

```
DEF FNFactorial%(N%)

  IF N% > 1 THEN
    FNFactorial% = N% * FNFactorial%(N%-1)
  ELSE
    FNFactorial% = 1.0
  END IF

END DEF
```

ables that are global and accessible to all parts of the module, as well as to the program that calls the module. The PRIVATE declaration lists the functions and procedures that are local to the module; all routines that are not listed are strictly private. The DECLARE DEF statement indicates the names of all the functions declared within the module. The SHARED declaration lists the scalar and array variables that are accessible to all the routines in the module, but not to any client program; they should not appear in the routines' argument lists.

Module initialization is carried out automatically before the program starts running; thus, any PUBLIC variable involved in the initialization step must be assigned an initial value from within the module itself. This makes the initialization step independent of the client programs.

### The Grand Picture

The new ANSI BASIC standard and the implementations based on it have brought significant improvements to the BASIC programming environment. BASIC programs benefit from structured coding: They're more clearly defined and easier to read and maintain. This structure is apparent at two levels: within the program itself, and in the multiline functions and procedures. The avenue for writing reusable BASIC libraries has reached new and unprecedented levels on microcomputers.

The BASIC revival is indeed real and is worthy of the notice

**Listing 5a: True BASIC listing of a callable procedure.**

```
SUB Basic.Stat(X(), Mean, Sdev)
  ! Return average and standard deviation
  ! of an array X()

  LET SumX = 0
  LET SumXX = 0
  LET Sum = Size(X)

  IF Sum < 2 THEN ! return with numeric
  ! error values

    LET Mean = -1.0E+30
    LET Sdev = -1.0E+30
    EXIT SUB
  END IF

  FOR I = LBound(X) TO UBound(X)
    LET SumX = SumX + X(I)
    LET SumXX = SumXX + X(I)^2
  NEXT I

  LET Mean = SumX / Sum
  LET Sdev = SQR((SumXX - SumX^2/Sum)/(Sum-1))

END SUB
```

**Listing 5b: Turbo Basic listing of a callable procedure.**

```
SUB Basic.Stat(X%(1), Mean#, Sdev#)
  ! Return average and standard deviation of
  ! an array X()

  LOCAL Sum#, SumX#, SumXX#, I#
  SumX# = 0
  SumXX# = 0
  Sum# = UBound(X%(1)) - LBound(X%(1))

  IF Sum# < 2 THEN ! return with numeric
  ! error values

    Mean# = -1.0E+30
    Sdev# = -1.0E+30
    EXIT SUB
  END IF

  FOR I# = LBound(X%(1)) TO UBound(X%(1))
    SumX# = SumX# + X%(I#)
    SumXX# = SumXX# + X%(I#)^2
  NEXT I#

  Mean# = SumX# / Sum#
  Sdev# = SQR((SumXX# - SumX#^2/Sum#)/(Sum#-1))

END SUB
```

of many veteran BASIC programmers who have migrated to Pascal and C. There was a valid cause for this exodus of programmers. But now, there is a good reason to give BASIC a second look: It's getting better all the time. ■

### BIBLIOGRAPHY

Shammas, Namir. *The New BASICs*. Redwood City, CA: M&T Publishing, 1987.

*Namir Clement Shammas is a columnist for several computer magazines and a freelance writer living in Glen Allen, Virginia. You can reach him on BIX as "nshammas."*

Advertise your  
computer products  
through  
**BYTE BITS**  
(2" x 3" ads)

For more information  
call Dan Harper at  
603-924-6830

BYTE  
70 Main St.  
Peterborough, NH 03458

Circle 312 on Reader Service Card

## Bullet Modem



- 19,200 BPS on PSTN Lines
- 100% Error Free Data
- MNP Class 5, ESP Class 6
- AT Command Set



E-Tech Research  
3333 Bowers Avenue, # 165  
Santa Clara, CA 95054  
(408) 982-0270, FAX (408) 982-0272

Circle 311 on Reader Service Card

## FRAME GRABBERS

MODEL	RESOLUTION	PRICE with frame grab	PRICE without frame grab
HRT 256-4	256 x 256 x 4	495	NA
HRT 256-8	256 x 256 x 8	795	NA
HRT 512-8	512 x 512 x 8	995	NA
HRT 512-24	512 x 512 x 24	1495	1095

- IBM PC/XT/AT COMPATIBLE
- DIGITALIZE IN REAL TIME
- COMPOSITE VIDEO IN
- 24 BIT RGB OUT except model HRT 256-4
- 16 level gray scale out

- SOFTWARE LIBRARY OF IMAGE ANALYSIS ROUTINES
- FREE SOFTWARE UPGRADES TO REGISTERED OWNERS
- FULL CREDIT ON UPGRADE PURCHASE IN FIRST YEAR
- RETURN OLD BOARD AND JUST PAY DIFFERENCE

INPUT DEVICES (optional)

Microsoft Mouse (bus or serial) 199  
Be Pad Plus by Summagraphics 3359

**HRT**  
HIGH RES TECHNOLOGIES

HIGH RES TECHNOLOGIES  
P.O. BOX 76  
LEWISTON, N.Y. 14092

PHONE 416-497-6493

FAX 416-497-1988

Circle 315 on Reader Service Card

# BASIC PROGRAMMING TOOLS

Whether you're a seasoned expert or just starting out...

We'll help you create programs that run faster, work harder, and simply look better. All Crescent Software products include source code, demonstration programs, clear documentation, and a 30-day guarantee.

• **QuickPak** More than 65 essential routines for BASIC programmers including windowing, access to DOS and BIOS, searching/sorting string arrays, Lotus™ and pull-down menus, data input, and more. QuickPak is loaded with examples and tutorial information, and comes with *The Assembly Tutor*—an introductory guide to assembly language from a BASIC perspective. \$69

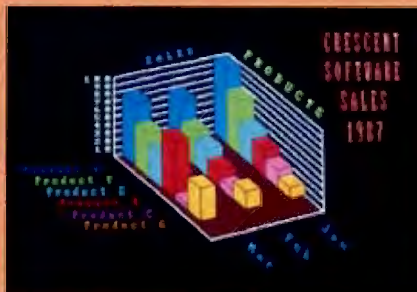

## New QuickPak Professional

The most comprehensive set of tools ever developed for BASIC programmers. Hundreds of assembler and BASIC subroutines including array manipulation, pop-up utilities, multiple windows, mouse support, scientific and financial functions, multi-tasking menus, and more. Includes dozens of examples and complete applications. \$149

• **QBase** A superb screen designer and full-featured relational database with BASIC source code to allow customizing. QBase provides a complete database, and is outstanding for creating titles, help screens, and product demos. \$99

• **QBase Report** Enhances QBase by generating reports with multiple levels of sorting, record updating, and browsing. Report comes with a complete time billing application for computer professionals. \$69



• **GraphPak** A complete collection of BASIC subroutines for displaying presentation quality 3D bar, line, and pie graphs from within your programs. Includes sophisticated font and tile editors. (EGA/VGA recommended) \$69

## New GraphPak Professional

All the features of GraphPak plus scientific graphs, 3D surface plots and multiple fonts. Also comes with very fast text-based bar charts. \$149

## New LaserPak

A comprehensive set of subroutines for generating graphics on a LaserJet or compatible. Includes scales, grids, text labeling, Hi-Res pattern editor, and control over all LaserJet commands. \$69

## New QuickMenu

A full-featured DOS menu system for novices and experienced users. Define the menu titles and DOS commands for each choice, and they will be executed automatically. QuickMenu is not memory resident, and features context-sensitive help and optional password protection. \$49

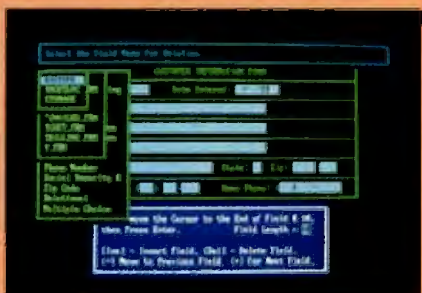

• **QuickTALK magazine** is our way of saying thank you. The catalog includes feature articles, tips and tricks, and late-breaking news about BASIC. Call or write for your copy. FREE!



## CRESCENT SOFTWARE

11 Grandview Avenue, Stamford, CT 06905 (203) 846-2500

Separate versions available for QuickBASIC and Turbo Basic—please specify when ordering. Trade-ups are available to professional versions—call for information. Add \$3 per order for shipping / \$10 overnight—Foreign \$10 per item / \$35 UPS 2nd day. Visa, M/C, C.O.D. and checks accepted.

Circle 61 on Reader Service Card



# Discover Parallel Processing!

## Monoputer™

*The Most Cost Effective  
Transputer Development System*

MicroWay's **Monoputer** is the best selling Transputer-based PC coprocessor in the world. It was the first board available to run the 20 MHz T414 or T800. As a result, it received many rave reviews in the UK (available on request) and became the standard Transputer software development tool. Parallel code can be executed on a single Monoputer or on an array of Monoputers wired together by their external link lines. The Monoputer includes 2 megabytes of 100 nsec DRAM, a 20 MHz T414 or T800 and the MicroWay stand alone Occam Compiler, which generates Transputer code that runs under MS-DOS. Optional tools include our licensed version of the TDS and a Pascal, Fortran, C, and Prolog.

## Quadputer™

*Mainframe Power  
For Your PC!*

MicroWay's **Quadputer** is the most versatile multiple Transputer coprocessor on the market today. It can be purchased with 2, 3, or 4 Transputers, each of which has 1 or 4 megabytes of local memory. Two or more Quadputers can be easily cabled together to build larger parallel processor systems. A single Quadputer using four T800s provides 40 MIPS of CPU and 6 megaflops of NDP throughput at one fiftieth the cost of a comparably performing mainframe.

For more information please call (617) 746-7341. After July, 1988, call (508) 746-7341.

# Micro Way

## The World Leader in PC Numerics

P.O. Box 79, Kingston, Mass. 02364 USA (617) 746-7341  
32 High St., Kingston-Upon-Thames, UK 01-541-5466  
St. Leonards, NSW, Australia 02-439-8400

## Part 2

# WHY MICROCONTROLLERS?



The DDT-51 is a low-cost IBM PC-based Intel 8031/8051 development system

**H**aving explained last month why we want to design projects around a single-chip microcontroller, it's time to talk about getting the software into the microcontroller. As I previously suggested, your options are either burn and crash (burn the program into an EPROM and figure out why it crashed) or use a development system.

The DDT-51 8031 development system I'll describe in this article offers many of the features of more expensive software development systems, at a fraction of the price. Unlike those systems, you can build this one yourself, modify the features to suit your tastes, and wind up with a system tailor-made for your application.

I'll start with the DDT-51 system hardware, then describe the software interface that lets an IBM PC control the target 8031 system.

### The DDT-51 Development Tool

Nothing ever works the first time. When you are debugging microcontroller-based hardware, you need to be able to

load and run a program, stop at breakpoints, single-step through critical parts of the code, disassemble instructions, examine and change registers, and continue where you left off. An ideal development system helps you do all that without using any 8031 system resources: no pins, no ICs, no program RAM—nothing at all. In-circuit emulators (ICEs) come closest to that ideal, because they replace the microcontroller with a hard-wired equivalent of the microcontroller chip—an equivalent that lets you directly observe the chip's (normally hidden) inner functions.

The DDT-51 system isn't quite that ideal, but it comes close. It needs one interrupt input, one output pin, and a 2K-byte RAM chip to hold debugging code and data. A 40-pin DIP clip attaches directly to the 8031 IC, and there are no other connectors to the target board. Photo 1 shows the prototype DDT-51 development system board, and figure 1 shows a block diagram of the hardware.

The software that runs on the host IBM PC is called DEBUG31. DEBUG31 shows all the 8031's internal RAM and the main registers when the microcontroller is stopped, as illustrated in figure 2. You can load new values into the registers, set a breakpoint to trap the program, and single-step through the code. You use function keys on the host to control all these operations.

Like an ICE, the DDT-51 supplies the data, address, and control lines needed to simulate an 8031's operations, although at a much slower rate. When the connections are disabled, the 8031 will run as though the DIP clip wasn't there.

### Under the Hood

As described last month, an 8031 doesn't have an internal program ROM, so it needs an external EPROM (usually a 2764). If you replace that EPROM with a pin-compatible 6264 8K-byte RAM, the DDT-51/PC link can load and change the

*continued*

**Photo 1:** Prototype of the DDT-51 development system.



8031's program. Once you've got the program loaded, the 8031 can execute it normally, just as though it were in EPROM.

The debug RAM is a key component of the DDT-51 system, but some 8031 systems may not need any RAM. Because the DIP clip connects to the 8031 bus control lines, it's easy enough to put the debug RAM on the DDT-51 board. I used a 2K-byte RAM simply because it is the smallest one that's readily available. An 8K-byte RAM would work just as well.

Unfortunately, the 8031 wasn't designed to share its bus control lines with other hardware. All the bus lines float when the RESET input is high (they use tristate drivers), but the program halts until RESET goes low again. The program restarts from address 0000 hexadecimal after a RESET, rather than con-

tinuing where it left off, which is exactly what a RESET should do. What's needed is a dual-ported RAM that can be accessed by either system independently, with separate control, data, and address lines. The two systems can then store and examine data in the common RAM without interaction.

Although the PC and the 8031 can both access the debug RAM, they can't do so simultaneously. To keep the hardware simple, there are no interlocks to prevent collisions (both systems attempting to access the RAM at the same time). If a collision does occur, one processor will always get bad data because the proper buffers are not active. The PC and 8031 programs must adhere to a software gentleman's agreement to prevent RAM conflicts. It turns out that this is not at all difficult to accomplish.

How do they do that? Once the 8031

program starts running, the DDT-51 can pull INT1 low to interrupt normal execution. A few debugging instructions added to the 8031 code handle the interrupt and examine a location in the debug RAM to determine what function was requested. The 8031 copies the results into the debug RAM and returns to normal operation, giving DEBUG31 (on the PC) free access to the RAM.

The gentleman's agreement is controlled by two wires: the IRQ line, triggering an 8031 interrupt, and the 8031 HALTED line, which is set while the interrupt handler is in control. Remember that the 8031 isn't halted after the interrupt, but is in the middle of the interrupt handler.

Figure 3a describes the physical connection between the PC and the target system; figure 3b shows the timing diagram that manages access to the debug RAM. DEBUG31 on the PC writes control information into the debug RAM and pulls the IRQ line low. The 8031 responds to the interrupt, examines the debug RAM, and executes whatever functions are needed. When it's done, it sets the HALTED line active and waits for DEBUG31 to restore the IRQ line to a high level. The 8031 then sets HALTED low, reloads the registers, and returns to normal operation in the interrupted program.

Figures 4a and 4b show the DDT-51 system circuit diagram. The DDT-51 system divides neatly into four sections: the PC parallel-port interface, bus buffers to control the various lines, the debug RAM, and an EPROM programmer.

#### The Port Swings Both Ways

The DDT-51 system trades hardware for software. The DDT-51's hardware pro-

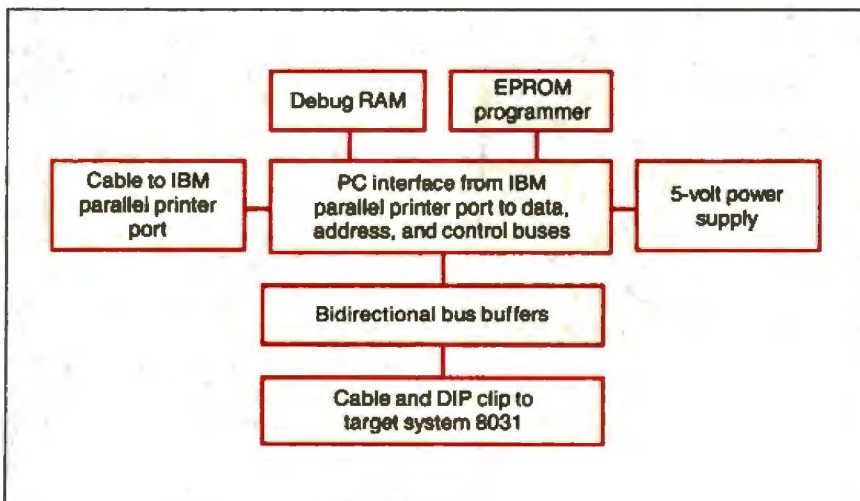

Figure 1: A block diagram of the DDT-51 development system.

```

HALTED at single step
Reading debug RAM, interrupt count is 2
A = ED  B = 00  DPTR = 0016  SP = 07  PSW = 00  (CY AC F0 0V P)  PC = 0056 → LCALL 00DB
Reg Bank 0: EE ED ED ED ED ED ED ED  Reg Bank 1: 56 00 00 ED EE 00 16 00
Reg Bank 2: 3F 84 00 00 ED ED ED ED  Reg Bank 3: ED ED ED ED ED ED ED ED
Bit-addressable RAM:
20 ED ED ED ED ED ED ED ED ED ED ED ED ED ED ED ED ED
General RAM:
30 ED ED ED ED ED ED ED ED ED ED ED ED ED ED ED ED ED .....
40 ED ED ED ED ED ED ED ED ED ED ED ED ED ED ED ED ED .....
50 ED ED ED ED ED ED ED ED ED ED ED ED ED ED ED ED ED .....
60 ED ED ED ED ED ED ED ED ED ED ED ED ED ED ED ED ED .....
70 ED ED ED ED ED ED ED ED ED ED ED ED ED ED ED ED ED .....

Use F9 to step, F10 to run
    
```

Figure 2: A sample display from the DEBUG31 program, shown here in single-step mode.

vides only essential functions; the software handles most of the logic. DEBUG31 merely sets and reads bits in the DDT-51 hardware to find out what's going on in the target 8031. Sounds simple enough.

Because speed of interaction between the host PC and the DDT-51 is important, the DDT-51 connects to the PC via a bidirectional parallel port (using the serial port would greatly increase the hardware complexity of the DDT-51). Unfortunately, an irritating problem with the design of the PC is that its standard parallel printer port is output only.

All the hardware needed to read or write 8 bits of data is already in place, but it lacks a connection to enable that function. While you can buy a custom parallel I/O board, I think changing a single trace on the existing board might be worth it to some readers. Figure 5 shows the single cut and addition to convert a standard parallel printer port to bidirectional operation.

Of course, all the clone boards (even the IBM boards) seem to use different IC numbers and assign the bits to different pins on the ICs, so this modification can be a real mystery. If you are unwilling to chop up your printer port card, buy a \$50 clone printer port card. They are usually bidirectional. Some clone cards also omit the input connection between the data bus and pin 14 of the LS174. I suppose they figure that because the output is unused, the input is irrelevant. It's easy to find the two unused pins, however (a modified port will still work correctly with all your other software, simply because the code doesn't know about the change and won't take advantage of it).

DEBUG31 examines each of the three possible printer ports, working down from LPT3, to find which one has the modification installed. This provides a convenient way to check your work. DEBUG31 will tell you which card it's using.

### Creating Five Ports from One

The DDT-51 system needs more than one I/O port to control all its hardware. Rather than burden the PC with more ports, I used an 8255 parallel peripheral interface (PPI) chip and a pair of LS374s to get five more ports. DEBUG31 controls these ports using the four standard printer control lines.

IC9, the control register, holds bits that must be active all the time, like the 8031 RESET and IRQ lines. It also supplies the 8255's register addresses and several bits for the DDT-51's bus logic.

IC12, the system register, holds the

8031 system bus control bits. There are 4 unused bits in this register that can be used for additional functions. The outputs are disabled whenever the 8031 drives the DDT-51's address and data buses, so that there is no conflict.

IC8, the 8255 bus interface, drives the high byte of the external address bus through port B and writes and reads the external data bus using port A. Port C samples the 8031 HALTED line. Other port C bits monitor the outputs of the DDT-51 logic circuits when running diagnostics from the PC.

Every 8031 system has a latch that demultiplexes the low-order byte of the address from the combined address/data bus. You might think that, because the outputs of that latch don't connect to the 8031, the DDT-51 system would need another DIP clip to get access to that part of the address bus. Instead, it is simpler to duplicate the latch, using IC10.

The DDT-51's debug RAM presents a similar problem, since the RAM requires a chip select line and the target 8031 system may not have an address decoder. I added IC11 to provide chip selects on 8K-byte boundaries throughout the 64K-byte address space. The EPROM programming socket, which is empty in normal use, also gets a chip select line from this decoder.

### Bus Buffering

Both the 8031 and the DDT-51 system have control lines to read and write the program RAM (normally on the 8031 board) and the debug RAM (on the DDT-51 board). There are more combinations of data, address, and control line directions than might seem possible at first, which is why the logic isn't as simple as you'd expect.

IC9 supplies two control lines, called

*continued*

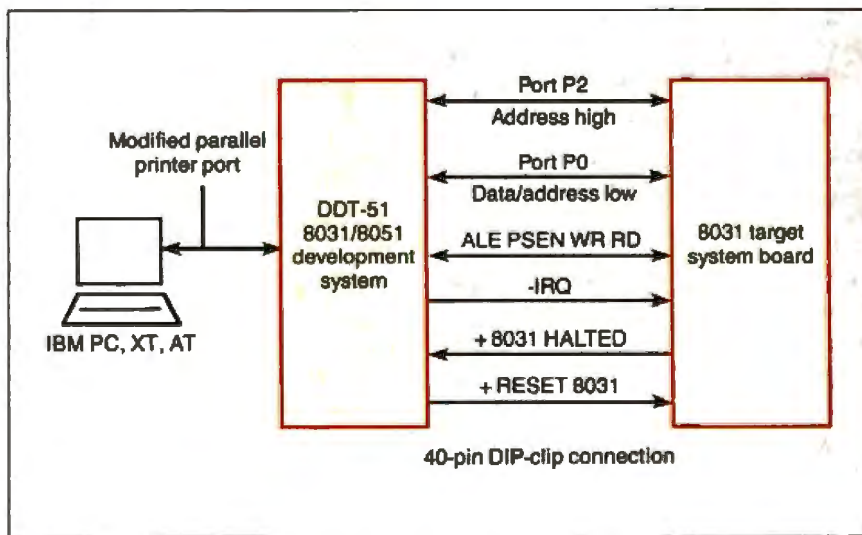

Figure 3a: Physical connections between the DDT-51 and its host and target systems.

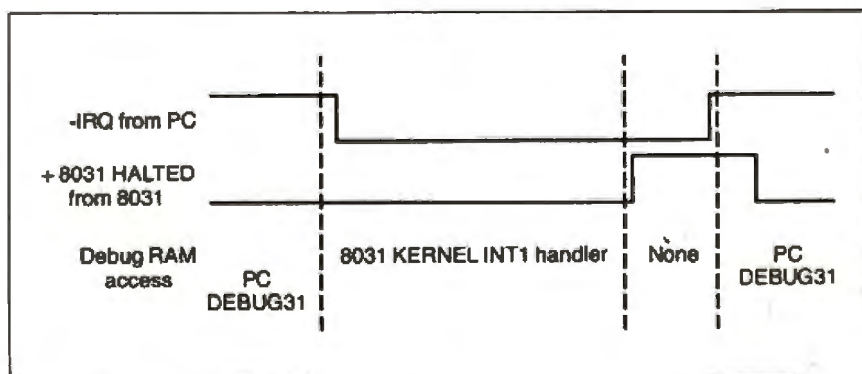

Figure 3b: A timing diagram showing the system's "gentleman's agreement" for controlling access to the debug RAM.



CTLS TO 8031 and CTLS FROM 8031, to select one of three states. The 8031 controls the DDT-51 logic when CTLS FROM 8031 is active, DDT-51 logic controls the 8031 system when CTLS TO 8031 is active, and the two systems are isolated from each other when both lines are inactive.

Setting the direction of the data and address lines isn't a simple task. For example, when the target 8031 system writes to the debug RAM, both the address and data come from the 8031. When it's reading from the debug RAM, the address comes and the data goes. A similar situation, in reverse, occurs when the DDT-51 reads the 8031's program RAM.

IC14 sets the DATA TO 8031 and DATA FROM 8031 lines by deciding which way the data must flow based on the current address, read or write activity, and signal source. This must be handled by hardware because it varies cycle by cycle as the 8031 runs its program.

When the two systems are isolated, the PC can access the debug RAM and the 8031 can access the program RAM without interacting. If either system tries to access the other while they're isolated, the data returned will be indefinite.

You've probably noticed that there's no hardware preventing both the CTLS TO 8031 and the CTLS FROM 8031 lines from being active at once. Further, as the schematic shows, this is definitely an illegal condition; it should never occur with properly operating PC code.

The reason for using an LS374 (IC10) to latch the address should now make sense. The bus buffers can't be activated until the control and address lines indicate in which direction the data should go. When the 8031 system supplies the ALE signal, the DDT-51 hardware accepts the 8031 data bus and tries to latch it in IC10. An LS373 is a *transparent* latch, meaning that the outputs track the inputs whenever the clock is high. When the 8031 lowers ALE, the bus buffers turn off and the data goes away before an LS373 can reliably latch it.

The LS374 is an *edge-triggered* latch, which means that the outputs change at the upward transition of the clock. Using ALE to clock the latches gives a sharp edge just before the data buffers turn off. This way, the LS374 records the inputs correctly.

### Debug RAM

The debug RAM is simply a 6116 2K-byte static RAM chip, driven by the buffered address and data lines. Either sys-

*continued*

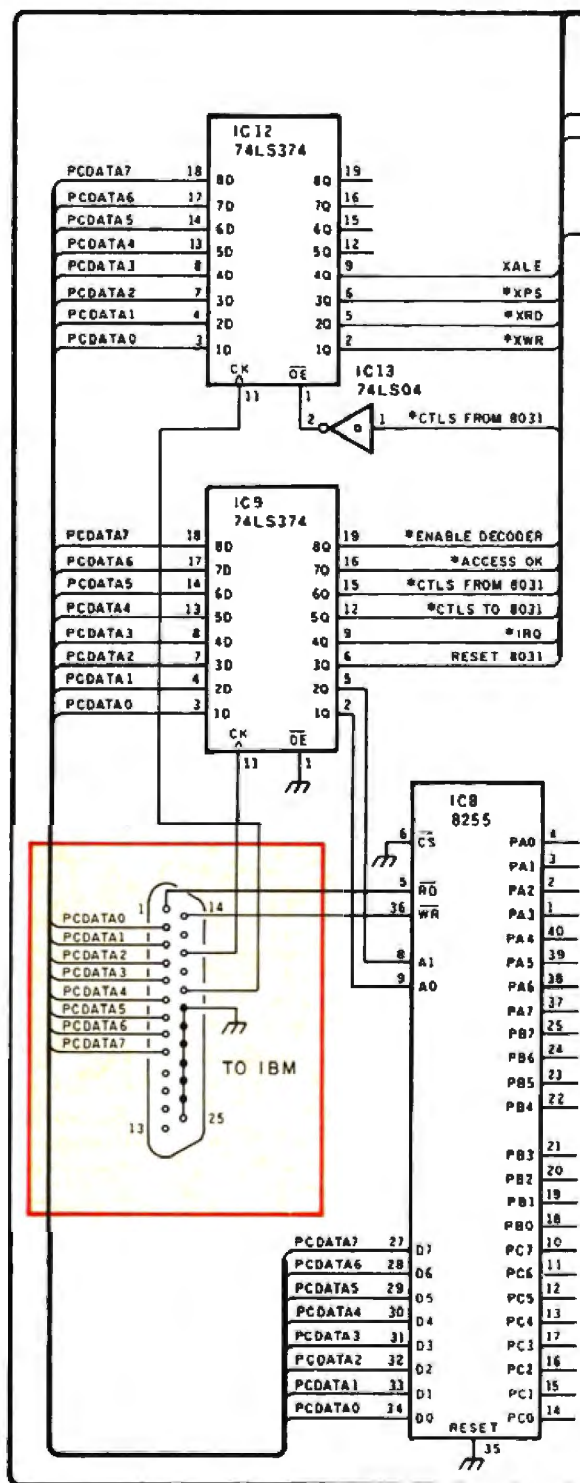
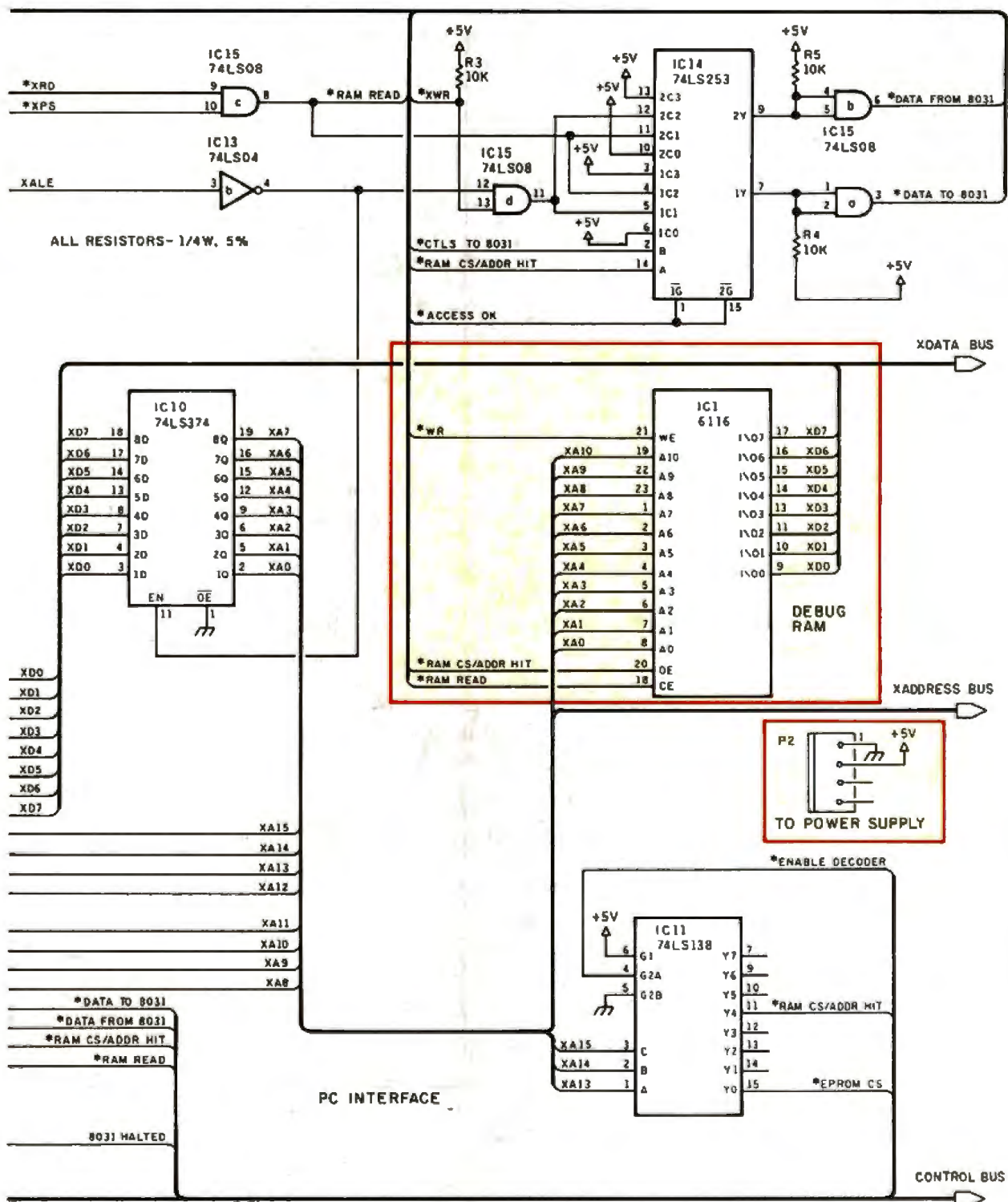

Figure 4a: The DDT-51 schematic, showing the PC interface and the debug RAM.

# HANDS ON CIARCIA'S CIRCUIT CELLAR





tem can access it. DEBUG31 assumes that the debug RAM is located at 8000 hexadecimal.

### EPROM Burning

Although the DDT-51 system is used to develop programs using RAM instead of EPROM, there (presumably) comes a time when you've finished the program and you're ready to ship it. At that point, you need an EPROM programmer. DDT-51 incorporates the world's least expensive 2764 EPROM programmer.

The programmer section of figure 4b shows all the hardware required to program a 2764 EPROM. The programming supply voltage comes from two 9-volt batteries hard-wired to add +18 V to the +5-V power supply. A simple emitter follower reduces this 23-V level to 21 V and provides enough current for the programming pulse. The 0.1-microfarad capacitors filter out noise glitches from the logic. You'll have no problem with battery life unless you start using this programmer for production quantities.

It turns out that programming a 2764 EPROM is much like writing to a rather slow RAM. First, you set up the address and data lines, select the chip, and pulse pin 27 low for 50 milliseconds. If pin 1 has +21.0 V on it while pin 27 is low, you've just programmed 1 byte of the EPROM. That's all there is to it.

DEBUG31 can already write data to any 8031 address, so programming an EPROM simply requires an "EPROM burn" software flag to lengthen the write pulse to 50 ms. A manual switch applies 21.0 V to the zero-insertion-force (ZIF) socket.

This system handles code that fits into a single 2764 EPROM. A DIP switch on the DDT-51 system board sets the chip-select address range so you can burn EPROMs at different addresses. And 8K bytes of EPROM holds a lot of 8031 code, particularly for smaller projects. Unlike the Circuit Cellar serial EPROM programmer (see the October 1986 Circuit Cellar), however, there are no circuits to prevent damage occurring when you insert or remove an EPROM from a "live" socket. Make sure you turn the DDT-51 system's power off and disconnect the DIP clip from the 8031 before inserting or removing the EPROM.

Of course, 2764s allow faster "intelligent" programming methods, but I haven't implemented them (I thought an EPROM programmer that required zero additional chips was pretty good). As a result, the DDT-51 system is both the world's least expensive and slowest

*continued*

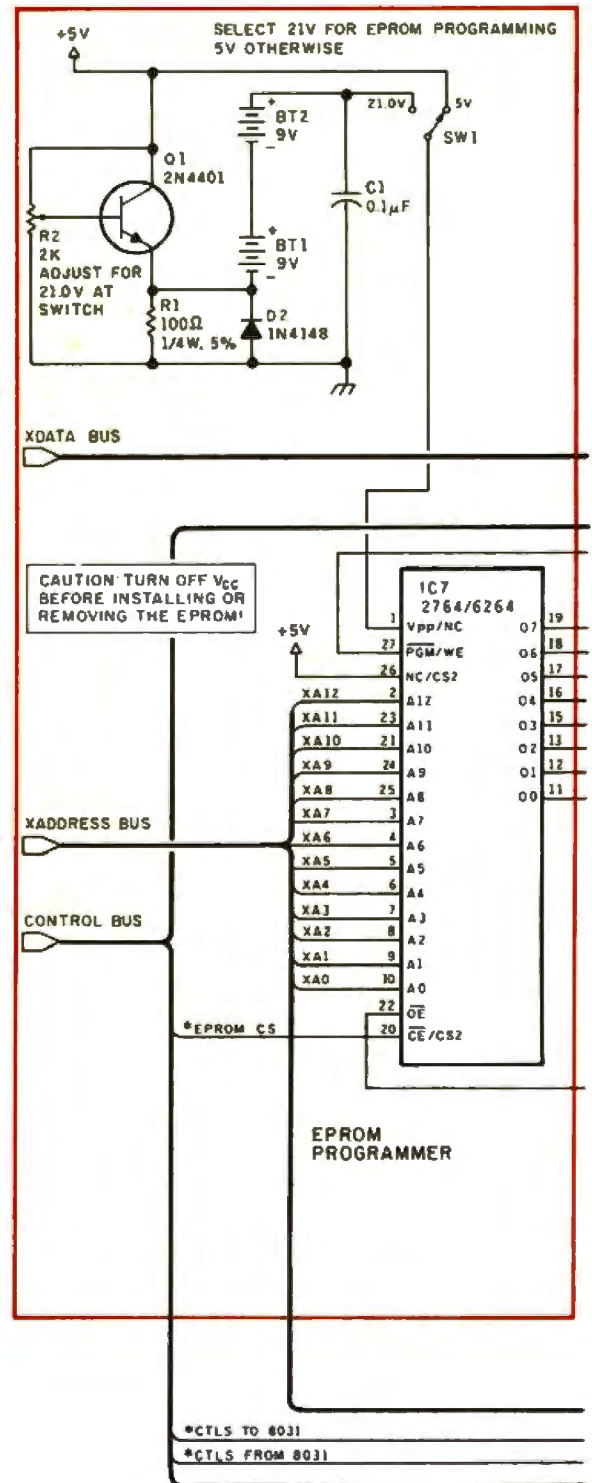
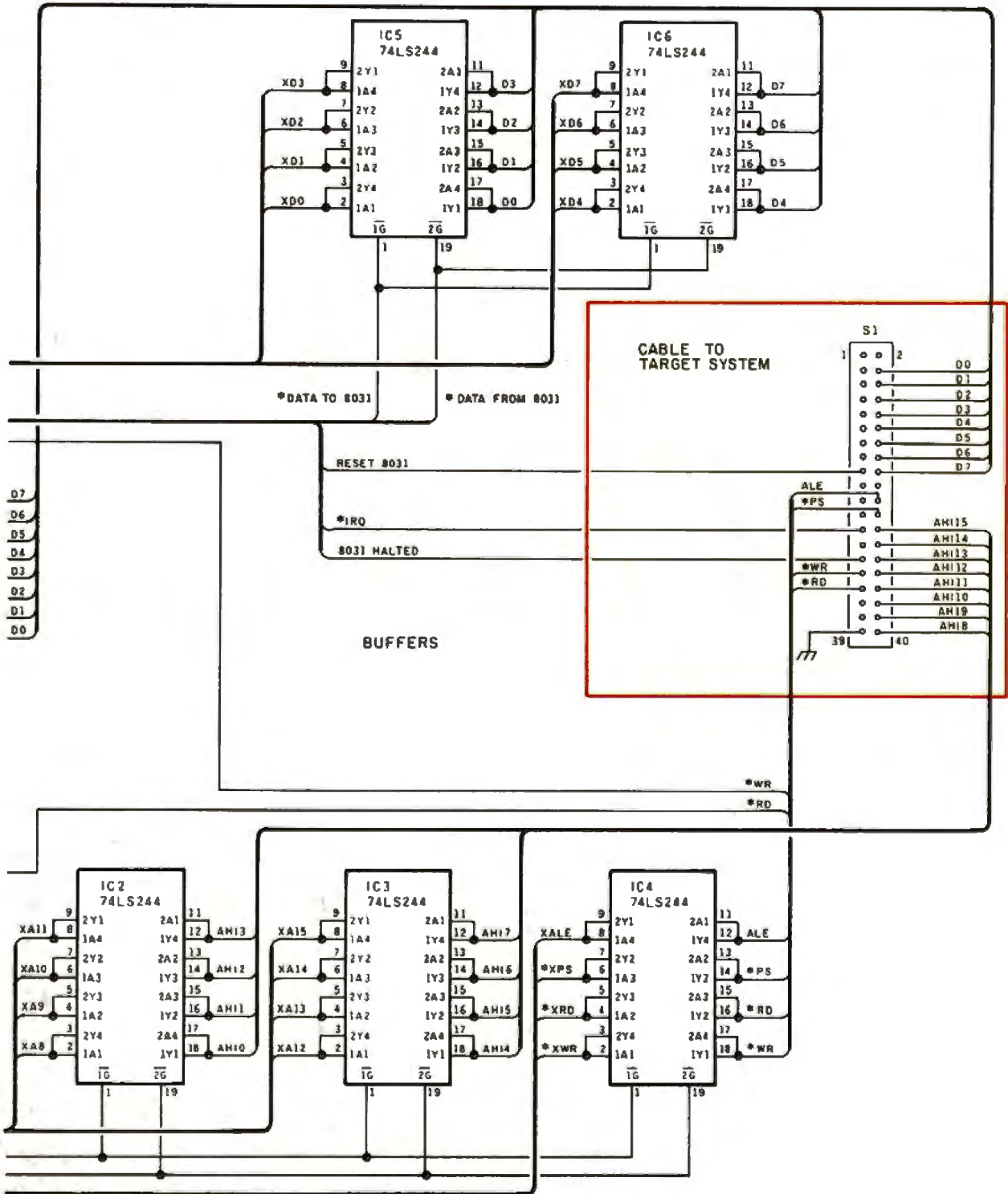

Figure 4b: The EPROM programmer subsystem and bidirectional bus buffers.

HANDS ON  
CIARCIA'S CIRCUIT CELLAR





EPROM programmer. If you start writing long programs, you may want to step up to my serial EPROM programmer.

### DEBUG31 Essentials

You might think that DEBUG31 on the PC is written in assembly language to handle all the bit manipulation needed to control the hardware. It turns out that it's all done in Turbo Pascal, which is a whole lot easier to read and understand. All the tricky stuff is handled by a few low-level routines.

At the highest level, DEBUG31.PAS is a simple loop that waits for function keys to be pressed. Each function key triggers a separate procedure to handle whatever is requested. Listing 1 shows the entire main loop, which is easy enough to understand.

Listing 2 shows a procedure called by the main loop (and elsewhere, too). SysReset activates the RESET 8031 line

from IC9 and sets up DDT-51 hardware so that the PC has access to the 8031 through the bus buffers. When the RESET line is active, the 8031 has stopped operating and floated all its bus and control lines, so the PC can read or write any hardware on the shared data bus.

SysReset calls SetCR (set the control register IC9), SetSR (set the system register IC12), and Load8255 (interface to the 8255), which are some of the lowest-level routines in the system. Each controls a single IC connected to the printer-port data lines. The routine handles all the operations required by other code and provides a convenient set of mnemonics that are easier to remember than the actual bit locations and values.

### The 8031 Kernel

The DDT-51 system depends on a small kernel of 8031 code to handle interrupts

and perform functions on behalf of the PC program. This code runs only during INT1 interrupts and must adhere closely to the gentleman's agreement interface to avoid hardware collisions.

Unlike DEBUG31.PAS, KERNEL.ASM must be written in 8031 assembly language and incorporated into any 8031 program that uses the debugging features of DEBUG31, but most of it is located in the 2K-byte debug RAM located on the DDT-51 board. The normal program memory must hold only about two dozen bytes of KERNEL's code, and you can move most of that chunk to any convenient location.

Because the 8031 registers and internal RAM are not directly accessible through the DDT-51 interface, KERNEL must copy those values into the debug RAM before DEBUG31 can see them. Once they've been copied, the PC can read, display, and change them as

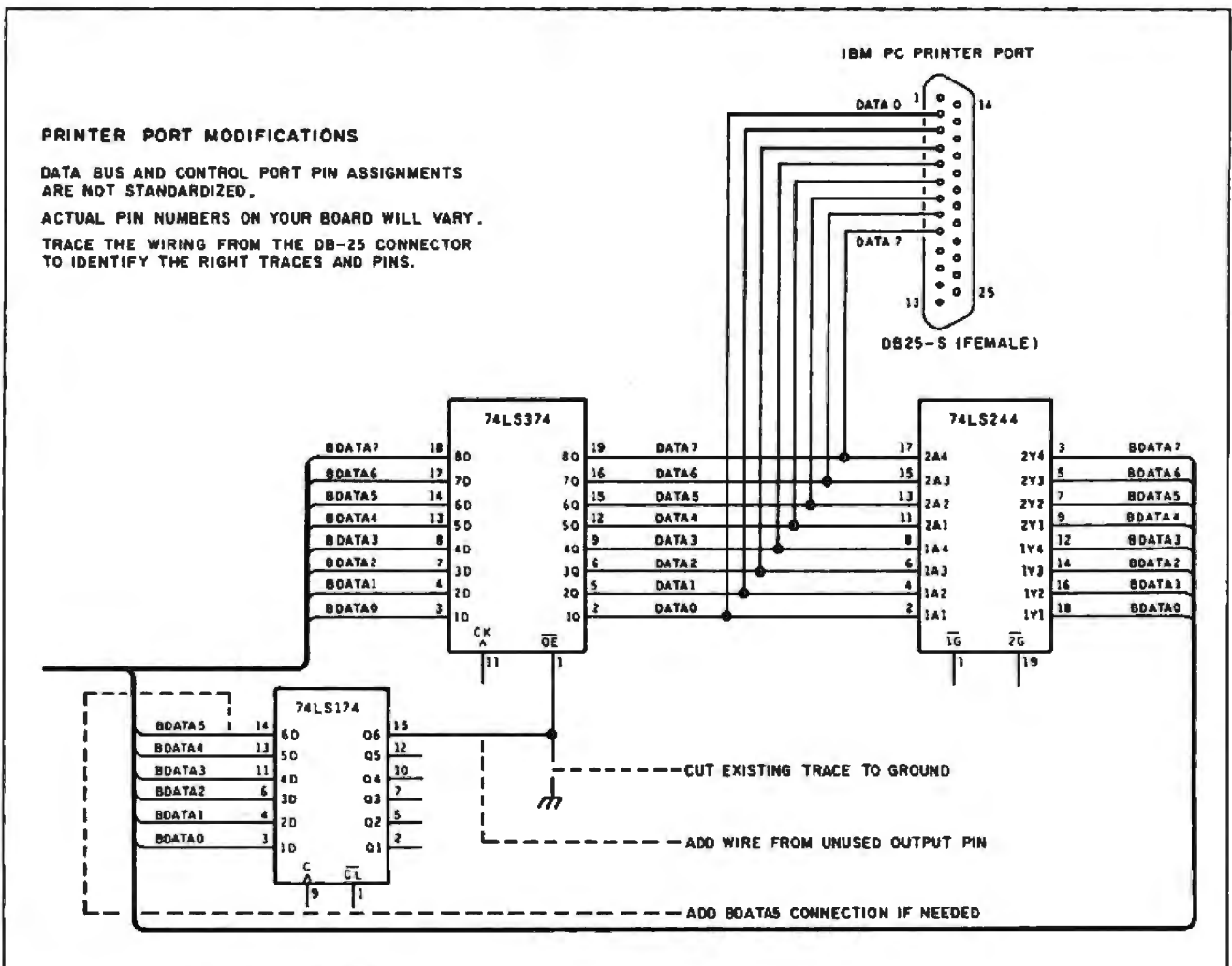

Figure 5: How to make an IBM PC's unidirectional parallel printer port bidirectional.

needed. KERNEL then copies the new values back into the internal locations and returns to the interrupted code.

The software handles breakpoints in a similar manner. DEBUG31 stores the breakpoint address in debug RAM and triggers an interrupt. KERNEL decodes the operation and writes an LJMP instruction at the specified address. The KERNEL breakpoint handler gets control when the 8031 executes the LJMP and copies the internal values into debug RAM.

At the heart of the interrupt-handler routine, the first order of business, as with any interrupt code, is to save all the CPU registers. Later on, these saved values will be copied into debug RAM so that DEBUG31 can reconstruct the actual state of the machine when the interrupt occurred.

If a breakpoint was active, the UndoBP routine removes the LJMP and restores the program RAM so that the next instruction is ready to go. Because an LJMP requires 3 bytes, it may have overwritten one or two instructions following the breakpoint. Regrettably, the 8031 does not have a single-byte software interrupt instruction like the 8088's special INT 3 breakpoint.

The DumpRAM routine copies the internal RAM values into debug RAM as described before, as well as extracting the registers saved on the stack. Remember that the internal RAM reflects the current registers rather than the ones used by the main program. Some internal RAM locations can't be read without introducing side effects: Reading the serial buffer will reset a pending interrupt, which would cause a malfunction in the main code.

Both KERNEL and DEBUG31 increment separate IRQ counters; KERNEL's counter is stored in debug RAM. If DEBUG31's counter differs from KERNEL's version, at least one IRQ got lost, which probably means that the 8031 program is out of control.

Because most of KERNEL is in the debug RAM, DEBUG31 can't read that RAM while the 8031 executes from it. The StepSpin routine is located in 8031 program RAM, which frees up the debug RAM for the PC. The StepSpin code sets 8031 HALTED to indicate that the debug RAM is available, then waits for the PC to raise INT1 when it's done changing the RAM. At that point, it's safe to begin executing from debug RAM again, so the code returns to SpinRet to continue.

The code following SpinRet reads the

*continued*

#### Listing 1: The DEBUG31.PAS main loop.

```
(*** setup code omitted here ***)

REPEAT
  ( Get next key )
  GetKey(key1, key2);
  { Is it an extended key? }
  IF key1 = Chr(ESC)
  THEN BEGIN
    { Which function key? }
    CASE Ord(key2) OF
      59 : ShowHelp;
      60 : SysReset;
      61 : LoadKernel;
      62 : Download;
      63 : SetBurn;
      64 : WriteLn('F6 not used');
      65 : SetRegs;
      66 : SetBP;
      67 : SysStep;
      68 : BEGIN
          { Normal, no IRQ }
          SysRun(running, FALSE);
          WriteLn('Use F9 to stop/step');
        END;
    ELSE;
  END;
END;

UNTIL (key1 = Chr(ESC)) AND (key2 = Chr(0));

(***) some cleanup code omitted (***)
```

#### Listing 2: The system reset procedure.

```
{ Force reset and take control of bus }

PROCEDURE SysReset;

BEGIN
  { Ensure a reset }
  SetCR(Reset8031, ON);

  { Get control of bus }
  SetCR(IRQ, OFF);
  SetCR(Ct1To8031, ON);
  SetCR(Ct1From8031, OFF);
  SetCR(AccessOK, ON);
  SetCR(EnableDec, ON);

  { Set up controls }
  SetSR(XRD, OFF);
  SetSR(XPSEN, OFF);
  SetSR(XALE, OFF);
  SetSR(XWR, OFF);

  { Our data and address }
  Load8255(I55Ct1s, I55AoBoCi);

  { Reset IRQ counter }
  IRQctr := 0;
  PutRAMbyte(IRQctrB, $00);

  WriteLn('8031 hardware is reset');

  { Indicate reset }
  state := reset;
END;
```



# FREE BUYER'S GUIDE.

Programmer's Connection is an independent dealer representing more than 250 manufacturers with over 750 software products for IBM personal computers and compatibles. We have supplied the programming community with quality software since 1984 by providing a wide selection of products, competitive pricing, and attention to customer service. Our comprehensive Buyer's Guide includes up-to-date product descriptions of a wide variety of compilers, interpreters, utility libraries, text editors, relational databases, UNIX tools, and much more. In addition, informative articles by some of today's industry leaders make the Buyer's Guide a complete reference tool for your software needs. Call or write today to receive your FREE copy, and find out why Programmer's Connection is your best one-stop connection for software tools.

## Programmer's Connection

7249 Whipple Ave NW North Canton, OH 44720



US ..... 800-336-1166

Canada ..... 800-225-1166

OH & AK (Collect) ... 216-494-3781

International ..... 216-494-3781

FAX ..... 216-494-5260

Refer to page 39 of this journal for a partial listing of our software products.

new run-mode byte from debug RAM and handles the request. This code also installs the new breakpoint L JMP instruction.

Finally, the StuffRAM routine copies the (possibly changed) values from debug RAM back into internal RAM. It inserts the new values for the registers into the right stack locations, so that the main program's registers can be altered by the PC. It does not restore registers with side effects (e.g., the serial transmitter buffer) for the same reason that DumpRAM didn't read from them.

After the registers are restored, the 8031 executes a RETI (return from interrupt) and the interrupted main code resumes execution, perhaps with new register values. (The complete listings for DEBUG31.PAS and KERNEL.ASM are available for downloading from the Circuit Cellar bulletin board system.)

### A Middle Ground

Does working on the DDT-51 development system convert me into a software jockey? Certainly not. To maintain a high level of performance in Circuit Cellar designs at a time when the rest of the industry is moving to application-specific ICs (ASICs) and other development-intensive reduced-component custom designs, I have chosen a middle ground of using programmable microcontroller chips.

In the same way that a large board of IC logic chips is reduced functionally to an ASIC, I have lumped the controlling elements of the TTL circuit I usually use into a configurable application-specific controller that can simulate these functions. Using simple three- or four-chip microcontrollers as standard computer engines in my projects, I am now better able to concentrate on presenting applications of technology rather than providing redundant explanations of low-level logic.

The DDT-51 development tool will hopefully help other BYTE readers consider the benefits of this middle ground.

The DDT-51 development system won't handle all possible 8051 target systems, but it will give you a good start. With that in hand, we can continue with other interesting Circuit Cellar project designs.

### Experimenters

As is the custom with all Circuit Cellar projects, the software for the DDT-51 development system is available for downloading from my multiline bulletin board free of charge. Call (203) 871-1988. Of course, this downloaded soft-

ware is limited to noncommercial personal use unless licensed otherwise.

### Next Month

I'll present a real-world example of multiprocessing. ■

*Special thanks for the technical contributions provided for this article by Jeff Bachiochi and Ed Nisley.*

**Editor's Note:** Steve often refers to previous Circuit Cellar articles. Most of these past articles are available in book form from BYTE Books, McGraw-Hill Book Co., P.O. Box 400, Hightstown, NJ 08250.

*Ciarcia's Circuit Cellar, Volume I* covers articles in BYTE from September 1977 through November 1978. *Volume II* covers December 1978 through June 1980. *Volume III* covers July 1980 through December 1981. *Volume IV* covers January 1982 through June 1983. *Volume V* covers July 1983 through December 1984. *Volume VI* covers January 1985 through June 1986.

### Circuit Cellar Ink

It's virtually impossible to provide all the pertinent details of a project or cover all the designs I'd like to in the pages of BYTE. For that reason, I have started a bimonthly supplemental publication called Circuit Cellar Ink, which presents additional information on projects published in BYTE, new projects, and supplemental applications-oriented materials. For a one-year subscription (6 issues), send \$14.95 to Circuit Cellar Ink, 12 Depot Square, Peterborough, NH 03458. Credit card orders can call (203) 875-2199.

There is a multiline Circuit Cellar bulletin board system (running TBBS 2.0M) that supports past and present projects in BYTE and Ink. You are invited to call and exchange ideas and comments with other Circuit Cellar supporters. The 300-/1200-/2400-bps BBS is on-line 24 hours a day at (203) 871-1988.

To receive information about the Circuit Cellar Ink publication for hardware designers and developers, please circle 100 on the Reader Service inquiry card at the back of the magazine.

*Steve Ciarcia (pronounced "see-ARE-see-ah") is an electronics engineer and computer consultant with experience in process control, digital design, nuclear instrumentation, and product development. The author of several books on electronics, he can be reached on BIX as "sciarcia."*

*Your questions and comments are welcome. Write to: Editor, BYTE, One Phoenix Mill Lane, Peterborough, NH 03458.*

# FLOATING-POINT WITHOUT A COPROCESSOR



A high-precision floating-point-emulation library for your PC

Most of the applications for floating-point calculations are obvious: scientific analysis, engineering design, financial calculations. Others, like graphics and desktop publishing (calculations involving reduction and enlargement), are less obvious. Interest in increasing floating-point throughput has grown; this is most apparent in the attention being paid to higher-performance math coprocessors—witness the inclusion of sockets for both the Weitek and the Intel coprocessors on many of the new 80386 machines.

For some situations, a coprocessor is the best answer for hurrying the throughput of floating-point calculations. But for many others, a coprocessor is either not cost-effective (although the prices are coming down—I'm waiting until I can get an 8087 for \$50) or simply unavailable (as is the case with many laptop computers). Software designers of products dependent on floating-point operations cannot assume all targets for their products will have a floating-point coprocessor available. (Apple provides its floating-point support as part of the Standard Apple Numeric Environment [SANE], which is incorporated into the Macintosh's System file.)

I decided on this month's topic partly in response to a comment I heard at a recent seminar: A participant was designing an application and complained that he wanted to include floating-point support but could not find any real working examples. I also believe that it's instructive to investigate the inner workings of a system you take for granted. Who knows? You might improve things and design the

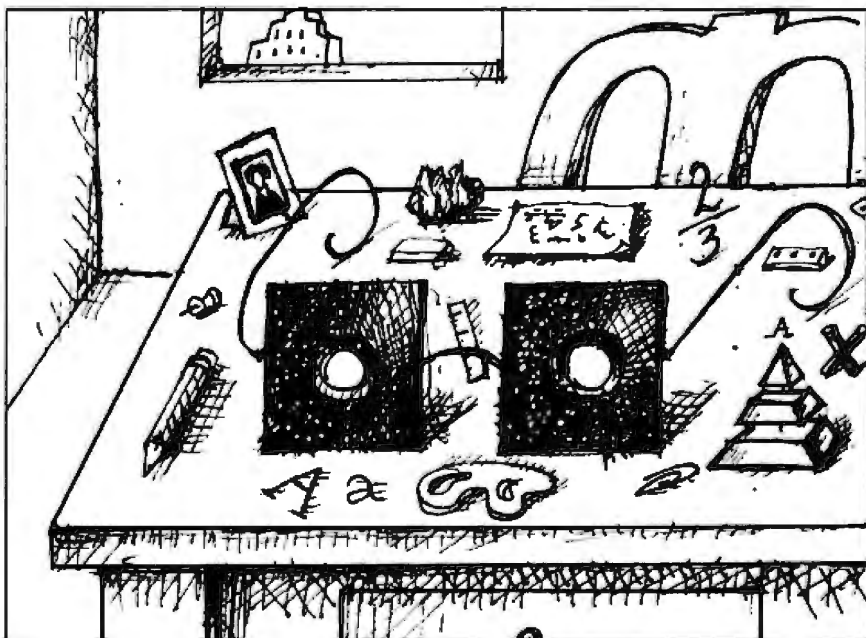

next IEEE standard for floating-point numbers.

The package I designed performs the four basic operations: add, subtract, multiply, and divide. I'll describe these this month. I've also incorporated some basic I/O routines, which will appear next month.

The system is written in 8088 assembly language, and to test it, I provided some simple interface routines with BYTE Small-C. You should be able to modify this interface to hook into your favorite compiler. (You'll find pseudo-code listings of the main routines here. The 8088 source code for the package, FLOATPAK.TXT, is available in a variety of formats. See page 3 for details.)

First, let's take a look at the format of floating-point numbers.

## Know the Beast

It's important to be clear about the format of floating-point representation. Lord knows it's tough enough to be clear

about base-10 floating-point numbers; base-2 floating-point is even worse.

Scientific notation provides a compact means of representing numbers when there is the possibility of wide swings in value. Simply put, even though you don't have room for lots of digits, you can still write very big *and* very small numbers. Instead of writing 1,000,000, you can write  $1.0E+6$ ; and instead of writing  $-.00000032$ , you can write  $-3.2E-7$ .

It's a mathematical shorthand. The expression  $-3.2E-7$  means  $-3.2 \times 10^{-7}$ . For a little terminology:  $-3.2$  is referred to as the mantissa, and  $-7$  is the exponent. How can we get this representation into our binary computer? Use the same idea, only make everything base 2.

Figure 1 shows the format my floating-point math package uses. FAC1\_EXP stores the exponent, and FAC1\_MAN holds the mantissa. Since this is all in base 2, you can express a floating-point number in scientific notation format as follows:

*continued*



`<FAC1_MAN> × 2<FAC1_EXP>`

FAC1\_MAN is a binary number with both integer and fractional parts. Just as the decimal mantissas above use a decimal point to separate their integer and fractional portions, binary floating-point numbers use a *binary point* to separate integer and fractional portions. Of course, this binary point is an imaginary entity; it has no real existence inside the computer—we just assume its location.

As usual, things are never really quite as simple as they appear at first glance. What I've described is a fairly accurate description of the representation—but with a couple of minor exceptions.

Minor exception number one is that FAC1\_EXP is a *biased* exponent. This simply means that the value stored in FAC1\_EXP is the true exponent value plus a bias. Adding a bias allows the package to represent positive and negative exponents. For example, in my package, the bias is 16384. An exponent of 0 would be represented as 16384; +12 would be 16396; and -5 would be 16379. Thus, the exponent has a range of  $2^{16385}$  to  $2^{-16383}$ —something like  $10^{4931}$  and  $10^{-4931}$ . As a means of rapidly identifying true zero, the package recognizes FAC1\_EXP equal to zero as signaling the special case that the entire number is zero. (The number 16384 isn't something I pulled out of the air. Since FAC1\_EXP is 16 bits, a bias of 16384 gives us a 15-bit exponent with the high bit left over to detect exponent overflow.)

Minor exception number two revolves around the fact that the internal represen-

tation of a floating-point number (i.e., how the package sees the number when an operation is being executed) is different from that number's external representation (i.e., how calling routines see the number). Specifically, the internal representation of the number sports an additional word's worth of precision. You'll see how this—and other trickery—becomes important when I get to the floating-point output routine.

You can think of FAC1 as a *floating-point accumulator*—a floating-point register, if you will—internal to math package uses. There are actually two accumulators: FAC1 and FAC2. Each holds one of the two arguments involved in the math operation, and when the addition, subtraction, multiplication, or division is finished, FAC1 holds the result. A third storage location, FAC3\_MAN, saves temporary values during the multiplication and division routines.

Now that we've gone over the blueprints, it's time to get to the construction work. As I stated earlier, we begin at the foundation.

#### Addition

Before you can add two floating-point numbers, you have to do something anyone who has ever added fractional numbers is familiar with: align the decimal points. Only now you're aligning the base-2 equivalent of the decimal point, and in our representation of floating-point numbers, this translates to *matching up the exponents*.

You do this by determining which number has the largest exponent and

moving that number into FAC1. The other number goes into FAC2. Then you simply subtract FAC2's exponent from FAC1 and examine the result to determine how many bits to shift FAC2 to line up its binary point with FAC1.

Note that since you've guaranteed that the number in FAC2 has a smaller absolute value than FAC1, the shift will be to the right. Why? What you're doing is matching the exponents of the two numbers, and you accomplish this by adding an amount—call it *y*—to FAC2\_EXP. This has the effect of multiplying the entire number by  $2^y$  (just as adding to the exponent of a base-10 floating-point number has the effect of multiplying by 10), so we have to offset that by shifting FAC2's mantissa to the right. (Remember that shifting a binary number right 1 bit divides that number by 2.)

If you have to shift FAC2 more than 78 bits, you can exit the routine immediately; FAC1 is so much larger than FAC2 that the addition will have no effect on the result.

Next, you examine the signs of the two numbers. If they differ, negate the mantissa of FAC2 (since you're *really* performing a subtraction). You can then go about the business of the actual addition, which looks for all intents and purposes just like addition of 80-bit integers. See listing 1 for the addition pseudocode.

If bit 79 (the highest bit) has been set as a result of the addition, then an overflow must have occurred. This can happen only if FAC1 and FAC2 had the same sign, and if that's the case you don't have to modify FAC1.

However, a subtraction may have taken place (if FAC1 and FAC2 had different signs); in this case, a 1 in bit 79 indicates that the result is a negative number in two's complement form (and that the absolute value of FAC2\_MAN was greater than FAC1\_MAN). You can determine this by reexamining the FAC1\_SIGN and FAC2\_SIGN. If they differ, you know the sign of the result is the sign of FAC2, so move FAC2\_SIGN to FAC1\_SIGN and negate the mantissa of FAC1 to make it positive again.

The last step is to normalize the contents of FAC1, so let's go ahead and talk about normalization. What is it, and why is it important?

#### Make It Normal

It would be a waste of space to write a floating-point number as 0.00003E-4; it's better to instead write it as 3.0E-9. Likewise, you wouldn't want to write 1,200,000.0E+6; use 1.2E+12 instead.

*continued*

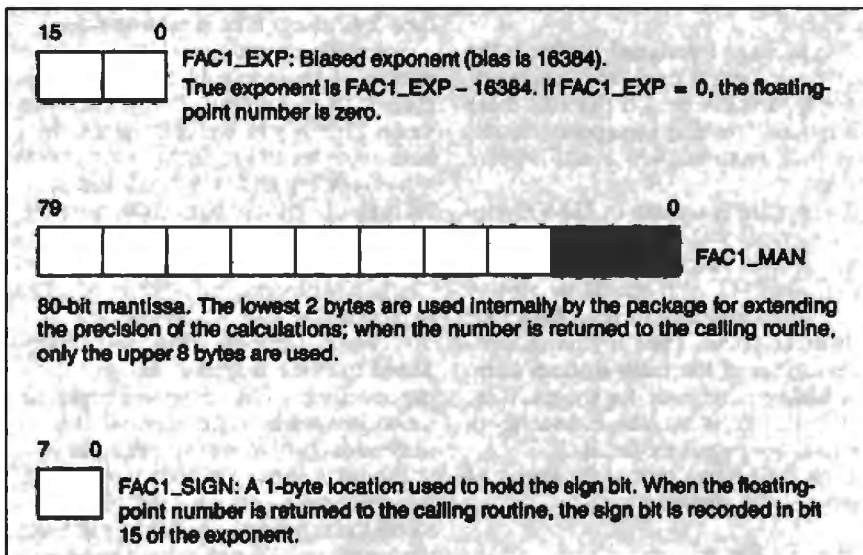

Figure 1: Floating-point representation. Note that the internal format adds an additional word of precision.

# How to create high-performance programs without wasting your time or money



**C Source Window**

```

30  addr->zip = 76442;
31  printf("The structure memb
32  printf("%d\n",addr->zip);
33  addr->street, addr->ci
34  size = sizeof(struct ADDR
35  printf("The structure size
36  printf("addr->street start
37  pr
38  pr
39  pr
40  )

```

**Watch Point Window**

```

A watchpoint has matured.
size > 8
Old value was 8
New value is 122
Space bar will clear notice & watchpoint

```

**Output Window**

```

Space for struc
starting at address 5416:0000
assigning values to numbers.

The structure number values...

Joe Bob's Texas
1251 Cow Chip Trail
Fort Worth TX 76442

```

**Variables Window**

```

1128:001199
addr->name      far ptr   0x5416:0000 "Joe Bob's Te
addr->street    array    "1251 Cow Chi
addr->city      array    "Fort Worth"
addr->state     array    "TX"
addr->zip       array    76442
size
job(0)         pointer  0x0203
job(1)         struct  0x0203
job(11)        pointer  0x0203

```

**Power Ctrace Debugger**

## Step 1: The \$19.95 Power C compiler

**P**ower C is the new ANSI compatible C compiler that runs faster than Microsoft C and has more functions than Turbo C\*. Power C combines high-performance software with superb documentation, all for less than the price of most C books alone. It's your fast route to fast programs without the fast bucks. Compare Power C to the competition and see how much time and money you'll save.

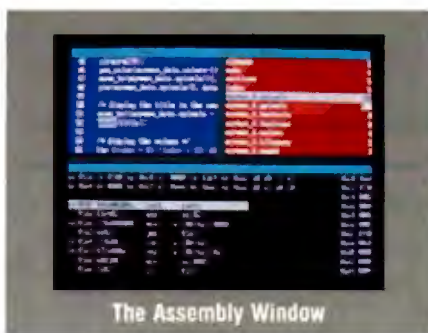

**Technical Specifications**

**Power C includes:** Power C compiler with integrated Make Power C Linker, Power C Libraries (450 functions), the Power C book (680 pages), and support for ..

- ANSI standard
- IEEE floating point
- 8087/80287 coprocessor
- auto-sensing of 8087/80287
- automatic register variables
- unlimited program size
- mixed model (near & far pointers)
- graphics on CGA, EGA, VGA, & Hercules

**Optional Products:**

- Power Ctrace debugger
- Library source code
- BCD business math

## Step 2: The \$19.95 Power Ctrace debugger

**P**ower Ctrace is the new state-of-the-art C debugger that makes Microsoft's Codeview look like old technology. Power Ctrace will reduce the time you spend debugging your C programs by at least a factor of 10. With Power Ctrace, you'll be working smarter instead of harder. Actually, you'll be having so much fun that it won't even feel like work anymore.

**U**nlike other debuggers, Power Ctrace lets you debug graphics programs on a single monitor. You can even debug programs that write directly to video memory. However, the major advantage of Power Ctrace is simple operation. You won't waste any time trying to understand or remember cryptic commands. With Power Ctrace, a single keystroke is all it takes. Help screens show you which key to press and pop-up menus list your options. Invest just 10 minutes with Power Ctrace now and you'll save hours from now on.

**O**rders now by calling our toll free number or mail the coupon to Mix Software, 1132 Commerce Drive, Richardson, TX 75081.

**1-800-333-0330**

For technical support call: 1-214-783-6001

Minimum System Requirements  
DOS 2.0 or later, 320K memory, 2 floppy drives or hard drive  
Runs on IBM PC, XT, AT, PS-2 and compatibles

Performance/Price Chart (execution times in seconds)			
	Power C	Quick C*	Turbo C**
1) fib	23.8	53.4	26.4
2) sieve	27.6	43.2	25.5
3) tdbi	3.5	9.0	9.6
4) diskio	13.5	14.4	14.3
5) report	11.0	71.7	60.7
6) drystone	36.6	41.6	31.8
Compile/Link	73.9	113.5	81.4
EXE File Size	25120	32092	27184
Compiler Price	\$19.95	\$99.00	\$99.95
Debugger Price	\$19.95	N.C.	N.A.
Library Source	\$10.00	\$150.00	\$150.00
Total Cost	\$49.90	\$249.00	\$249.95

N.C no charge - N.A not available  
Benchmarks compiled using Make utility, command-line compiler, and medium memory model

Circle 182 on Reader Service Card

**60 day money back guarantee**

Name \_\_\_\_\_  
Street \_\_\_\_\_  
City \_\_\_\_\_  
State \_\_\_\_\_ Zip \_\_\_\_\_  
Telephone \_\_\_\_\_  
Paying by  Money Order  Check  
 Visa  MC  AX  Discover  
Card # \_\_\_\_\_  
Card Expiration Date \_\_\_\_\_  
Computer Name \_\_\_\_\_ Disk Size  5¼"  3½"

Product(s) (Not Copy Protected)

Power C compiler (\$19.95) \$ \_\_\_\_\_  
 Power Ctrace debugger (\$19.95) \$ \_\_\_\_\_  
 Library Source Code (\$10.00) \$ \_\_\_\_\_  
 (includes assembler & library manager)  
 BCD Business Math (\$10.00) \$ \_\_\_\_\_  
 Add Shipping (\$5 USA - \$20 Foreign) \$ \_\_\_\_\_  
 Texas Residents add 8% Sales Tax \$ \_\_\_\_\_  
 Total amount of your order \$ \_\_\_\_\_

Power C & Power Ctrace are trademarks of Mix Software Inc.  
 Quick C & Codeview are registered trademarks of Microsoft Corp.  
 Turbo C is a registered trademark of Borland International





The point: Don't consume space with zeroes; get the most significant nonzero digit near the decimal point. This process is called *normalizing* the number.

You can normalize a binary floating-

point number using a series of shift operations, as shown in listing 2. Since in the base-2 system the only nonzero digit is a 1, normalization amounts to shifting the contents of the mantissa left or right until

a 1 appears in bit 78. Hence, a normalized mantissa in this notation might look (in base 2) like the following:

0.100100111001011

**Listing 1: Floating-point addition.**

```
Add FAC2 to FAC1:

FPADD:
IF FAC1_EXP < FAC2_EXP THEN
    exchange FAC1 and FAC2;
Bits_to_shift = FAC1_EXP-FAC2_EXP;
IF Bits_to_shift > 78 THEN
    RETURN;
IF FAC1_SIGN <> FAC2_SIGN THEN
    Negate FAC1_MAN;
REPEAT Bits_to_shift TIMES
    Shift FAC2_MAN right;
Add FAC2_MAN to FAC1_MAN;
IF (FAC1_SIGN<>FAC2_SIGN) AND
    (Bit 63 of FAC1_MAN = 1) THEN
    BEGIN
        Negate FAC1_MAN;
        FAC1_SIGN=FAC2_SIGN;
    END
GOTO NORM_FAC1;
```

**Listing 2: Normalizing floating-point numbers. The four primary routines exit through this code.**

```
Normalize The Number In FAC1:

NORM_FAC1:
IF FAC1_MAN=0 THEN
    FAC1_SIGN=0;
    FAC1_EXP=0;
    RETURN;
IF bit 79 of FAC1_MAN=1 THEN
    BEGIN
        Shift FAC1_MAN right 1 bit;
        FAC1_EXP=FAC1_EXP+1;
    END
WHILE bit 78 of FAC1_MAN=0
    BEGIN
        Shift FAC1_MAN left 1 bit;
        FAC1_EXP=FAC1_EXP-1;
    END
IF bit 15 of FAC1_EXP=1 THEN
    RETURN Exponent_overflow_error;
IF FAC1_EXP=0 THEN
    RETURN Exponent_underflow_error;
RETURN;
```

**Listing 3: Floating-point subtraction, based on the fact that  $x - y = x + (-y)$ .**

```
Subtract FAC2 from FAC1:

FPSUB:
FAC2_SIGN = FAC2_SIGN XOR 128;
GOTO FPADD;
```

(I've shown only the top 16 bits.) Notice that the topmost bit (bit 79) stays zero. Its job is to play bucket and catch any overflow bit that occurs as the package performs floating-point operations on the number.

Of course, shifting the mantissa left or right is the same as multiplying or dividing (respectively) by 2. So that the value of the floating-point number doesn't change, you must offset the effects of the shift operation by incrementing or decrementing the exponent. The rule is simple: If you shift left (a multiply), offset that by decrementing the exponent; if you shift right (a divide), offset that by incrementing the exponent.

Finally, the normalization routine has to check for exponent overflow and underflow. This will happen if, during the shifting process I just mentioned, the routine increments the exponent above the maximum allowed (overflow) or decrements it to zero (underflow). The normalization routine shown in listing 2 returns an error code if the exponent overflows or underflows. It's up to the calling routine to decide how to handle the situation.

All four of the floating-point routines exit through the normalization routine.

**Subtraction**

This is tough. You invert FAC2's sign (FAC2\_SIGN) and do a floating-point add (see listing 3). Next!

**Multiplication**

Multiplication is simpler than you probably think. If you can multiply decimal numbers, binary multiplication is a snap. Furthermore, multiplying numbers in scientific notation is not much harder. Just keep two simple rules in mind: 1) Add exponents and 2) multiply mantissas. Adding the exponents is the easy part—it's just a matter of adding two 16-bit numbers. But multiplying the mantissas—that's what we really came here for.

Think of how you learned multiplication in grade school—writing one number above the other, then proceeding across the lower number, multiplying one digit at a time, generating partial products, and adding. It's the same thing here.

Take a look at figure 2a, where two binary numbers are being multiplied. Proceeding from right to left on the lower

## SOME ASSEMBLY REQUIRED

number (the multiplier), if the digit is a 1, then write the upper number (the multiplicand) under the bar. If the digit is a 0, then write 0 under the bar. (These numbers under the bars are the partial products.) Keep going until you run out of bits in the multiplier. The rightmost digit of each partial product lines up with its generating digit in the multiplier. The result is the sum of the partial products.

You'll notice that the result can have up to twice the number of bits in the multiplier (or multiplicand, whichever has more bits). So when you go to multiply two 80-bit mantissas, the result can be up to 160 bits, the top 80 of which are all that you're really interested in. To multiply binary fractional numbers (the mantissas) so that the lower unwanted bits fall off the right end, see figure 2b.

The process is similar to the one in

figure 2a, with the addition of an accumulated value. You scan the digits of the multiplier from right to left. If the digit is a 1, add the multiplicand to the accumulated value; if the digit is a 0, add a 0 to the accumulated value. Then—and this is the trick—shift the accumulated value to the right prior to the next addition. The result is the same, only we've slid the least-significant bits off to the right.

That pretty much covers the technique used by the floating-point multiplication routine (the pseudocode is shown in listing 4), except for a couple of points: First, since the routine adds *biased* exponents, it has to subtract the bias from the result (otherwise the result would be doubly biased). Second, the multiplication operation actually shifts FAC3 (which holds the accumulated value, as shown in

*continued*

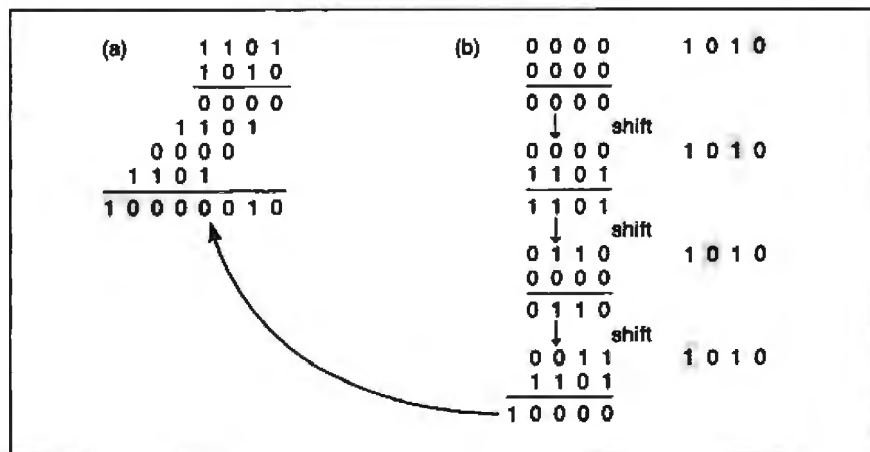

Figure 2: (a) Multiplying binary integers. This should remind you of the longhand multiplication you learned on the chalkboard. (b) Multiplying binary fractions. Notice that the result is the same as in (a), but we've shifted least-significant bits off to the right.

## Listing 4: Floating-point multiplication.

```

Multiply FAC1 by FAC2

FPMULT:
FAC1_SIGN = FAC1_SIGN XOR FAC2_SIGN;
FAC1_EXP = FAC1_EXP + FAC2_EXP -
            (BIAS+1);
Clear FAC3_MAN;
REPEAT 79 TIMES
BEGIN
Shift FAC3_MAN right;
Shift FAC1_MAN right;
IF carry=1 THEN
FAC3_MAN = FAC3_MAN +
            FAC2_MAN;
END
FAC1_MAN = FAC3_MAN;
GOTO NORM_FAC1;

```

Tools and Toolboxes  
Modula-2

## Applications Generator

**Amadeus** \$ 395  
Generate Modula-2 programs directly from your own input, and save yourself hours of coding!

## Graphics

**M2Graph\*** \$ 65  
Controls Hercules cards in Modula-2.

**M2EGA\*** \$ 65  
Controls EGA cards in Modula-2.

**Modula Graphics Toolbox I\*** \$ 112  
A collection of extremely fast graphics routines for CGA cards written in Modula-2.

**Modula Graphics Toolbox II\*** \$ 188  
Comprehensive package of Modula-2 procedures for all currently available graphics cards. Includes graphics window system, font generator, sprite handler, mouse driver, maths routines, as well as pie chart, histogram and line graph functions etc.

## Input/Output

**LCR-Window Manager\*** \$ 133  
Fast, compact window system.

**M2Windows** \$ 188  
Fast, professional window system. Small, high-performance library with menu and menu system and simple mask generator.

**Modula Mask & Menu Generator\*** \$ 360  
Development system for creating masks and menus in Modula-2 source code. Mask, menu and frame editor. Supports all colors and attributes.

## Other Tools

**M2 Prof\*** \$ 495  
The professional library

**B-Tree ISAM** \$ 290  
Ultra fast database

**Pascal-Modula Converter** \$ 59  
Converts Turbo-Pascal to Modula-2.

**RTA-Utility Disk** \$ 30  
2-10x faster I/O, extended MathLib.

**EMS-Utilities\*** \$ 188  
Make full use of your 1 megabytes of memory expansion!

**M2IEEE-Interface\*** \$ 144  
Modula-2 interface to National Instruments IEEE Interface

This is only a small selection from our comprehensive range of tools for Modula-2. Demo disks are available for products marked with an asterisk. Send \$ 10 for the demo disks. \$ 20 for seven. There is also a wide choice of books and literature on Modula-2.

We have Modula-2 compilers for the Amiga, HP-UX, IBM-370, ICL (Days), MS-DOS, PDP-11, and Sun/SPARC. The list is constantly growing.

Prices include postage and are valid for International Orders with \$ 20 shipping.

## The Modula-2 people:

**INTERFACE TECHNOLOGIES**

3336 Richmond, Suite 323  
Houston, TX 77098-9990 (713) 523 8422

## Dealer inquiries welcome

International  
Austria: 0222/4545010 United Kingdom: 01/6567333  
Belgium: 071/366133 Germany: 02983/8337  
France: 20822662 0731/26932  
Italy: 02/405174 0821/85737  
Scandinavia: +45/3/512014 04106/3998  
Switzerland: 01/9455432 0531/347121



A. + L. Meier-Vogt  
Im Späten 23  
CH-8906 Bonstetten/ZH  
Switzerland  
Tel. (41)(1) 700 30 37



# BYTE's Subscriber Benefits Program

Your BYTE subscription brings you a complete menu of the latest in microcomputer technology every 30 days. The kind of broad-based objective coverage you read in every issue. In addition, your subscription carries a wealth of other benefits. Check the check list:

## BONUSES

- ✓ **Annual Separate Issues:** In addition to BYTE's 12 monthly issues, subscribers also receive our annual IBM PC issue free of charge, as well as any other annual issues BYTE may produce.
- ✓ **BYTE Deck:** Subscribers receive five BYTE postcard deck mailings each year—a direct response system for you to obtain information on advertised products through return mail.
- ✓ **Reader Service:** For information on products advertised in BYTE, circle the numbers on the Reader Service card enclosed in each issue that correspond to the numbers for the advertisers you select. Drop the post-paid card in the mail and we'll get your inquiries to the advertisers.
- ✓ **TIPS:** BYTE's Telephone Inquiry System is available to subscribers who need *fast response* from advertisers. After obtaining your Subscriber I.D. Card, dial TIPS and enter your inquiries. You'll save as much as ten days over the response to Reader Service cards.
- ✓ **Free Programs Via BYTEnet:** You get access to the BYTEnet Bulletin Board Service, which allows you to download, via



modem, valuable program listings. There is no connect charge for this service.

- ✓ **Subscription Service:** If you have a problem with, or a question about your subscription, you may call our service department toll-free at 800-423-8272 (in New Jersey call 800-367-0218) during regular business hours (Eastern Time). You can also use Subscription Service to obtain back issues. Should you care to correspond, use the following address: P.O. Box 6821, Piscataway, N.J. 08855.
- ✓ **Editorial Indices:** Available through our customer service department P.O. Box 328, Hancock, New Hampshire 03449.

## PAID SERVICES

- ✓ **BIX:** BYTE's Information Exchange puts you on-line 24 hours a day with your peers via computer conferencing and electronic mail. All you need to

sign up is a microcomputer, a modem, and telecomm software. For further information and cost, call 1-800-227-BYTE.

- ✓ **Program Listings:** Listings of programs that accompany BYTE articles are now available on BIX, on disks or in quarterly printed supplements (see reply cards in this issue for cost information), or call 1-800-258-5485.
- ✓ **Microform:** BYTE is available in microform from University Microfilm International in the U.S. and Europe. See Contents page for cost information.

## DISCOUNTS

- ✓ One-year subscription at \$22.95
- ✓ Two-year subscription at \$39.95
- ✓ Three-year subscription at \$55.95
- ✓ One-year group subscription for ten or more at \$18.95 each. (Call or write for details.)

## TOLL-FREE NUMBERS FOR YOUR CONVENIENCE:

### Subscriptions & Back Issues:

1-800-423-8272  
(in N.J., 1-800-367-0218)

BIX: 1-800-227-BYTE

Program Listings Orders:  
1-800-258-5485

# BYTE



It's indispensable.

**Listing 5: Floating-point division.**

```

Divide FAC1 by FAC2:

FPDIV:
IF FAC2_EXP = 0 THEN
  RETURN Division_by_zero_error;
FAC1_SIGN = FAC1_SIGN XOR FAC2_SIGN;
FAC1_EXP = FAC1_EXP - FAC2_EXP + BIAS;
Clear FAC3_MAN;
FAC1_MAN = FAC1_MAN - FAC2_MAN;
REPEAT 80 TIMES
  BEGIN
    Shift FAC3_MAN left;
    Shift FAC1_MAN left;
    IF carry=1 THEN
      FAC1_MAN = FAC1_MAN +
        FAC2_MAN;
    ELSE
      FAC1_MAN = FAC1_MAN -
        FAC2_MAN;
      Set bit 0 of FAC3_MAN = 1;
    END IF;
  END
END
FAC1_MAN = FAC3_MAN;
GOTO NORM_FAC1;

```

figure 2b) to the right before each addition, so the result of the multiplication is  $FAC1 \times FAC2 \times 2$ . This reduces accuracy loss that can arise from the fact that the routine multiplies binary fractions. This loss of precision is analogous to multiplying .2 and .4, yielding .08 and wasting a digit position on the 0. The routine accounts for the additional multiplication by 2 by subtracting 1 from the exponent of the result (I sneaked this into the part where the routine subtracts the bias from the resulting exponent).

**Division**

This will sound ridiculously obvious, but floating-point division is a lot like the reverse of floating-point multiplication. Instead of adding exponents, you subtract them. With binary floating-point numbers in particular, instead of a series of shift-right-and-add operations applied to the mantissas, the algorithm consists of shift-left-and-subtract operations.

Again, let's concentrate on the division of binary fractions (the mantissas). The procedure is similar to integer division (a topic I won't go into in great detail, since there are many introductory texts on the subject). At the core of the routine is a loop that compares the divisor (FAC2) to the dividend (FAC1) to determine if the divisor can "go into" the dividend. If so, the routine subtracts the divisor from the dividend (creating a partial remainder), sets the 0th bit in the quotient (FAC3), and shifts everything to the left for the next operation.

You'll notice that the routine doubles up the subtraction and comparison operations: If subtracting the divisor from the dividend generates a borrow (indicating a negative result), the routine reverses the effect of the subtraction by adding the divisor back into the dividend (this is what happens when the divisor won't go into the dividend). This shift-and-subtract process (with an occasional add) is repeated for each bit of the mantissa.

Of course, the complete floating-point division routine must first check for division by zero. This is easy: Since the routines define an exponent of zero as an indicator of true zero, the FPDIV routine simply tests FAC2\_EXP. If FPDIV finds that FAC2\_EXP is equal to zero, the routine exits with an error condition (see listing 5).

**Getting It In and Out**

Next month, I'll wrap up the floating-point library with a description of the routines for loading and storing the floating-point accumulators, I/O, and some suggestions for extending the package. ■

*Rick Grehan is a BYTE senior technical editor at large. He has a BS in physics and applied mathematics and an MS in computer science/mathematics from Memphis State University. He can be reached on BIX as "rick\_g."*

*Your questions and comments are welcome. Write to: Editor, BYTE, One Phoenix Mill Lane, Peterborough, NH, 03458.*

**A new concept in managing  
Megabytes  
of memory**

**IX-BoX\***

Have you ever spent hours

- searching for a letter which you know exists, but can't seem to find?
- looking for addresses which you can only remember half of?
- tracking down a variable which was initialised somewhere in your programs, and which is now causing them to crash?
- rummaging through your ultra-modern database, simply because you omitted to define a simple key field when setting it up?
- searching your literature index for an urgently needed article?
- looking and looking, but without success?

Then we can help! IX-BoX will instantly find all your correspondence, addresses, programs, entries, summaries - in fact, anything and everything stored on your computer. IX-BoX delivers the document you require in seconds, and you can carry out any necessary changes to it using our built-in editor. What more could you possibly need?

IX-BoX is much more than a simple information retrieval system, yet it only costs \$ 275

Demo disk costs \$ 10

\* IX-BoX is a trade mark of Snark AG, Zürich.

**Farsight**

Once you've used the Farsight integrated software package, you'll know the fun of working with and exploiting Megabytes of memory.

Window manager, word processor and spreadsheet together cost only \$ 99

Graphics \$ 29

Texas residents add 8% sales tax. International Orders add \$ 20 shipping

The Modula-2 people:



3336 Richmond, Suite 323  
Houston, TX 77098-9990 (713) 523 8422

Dealer inquiries welcome

International	
Austria: 0222/4545010	United Kingdom: 01/6567333
Belgium: 071/366133	Germany: 02983/8337;
France: 20822662	0731/26932;
Italy: 02/405174	0821/65737;
Scandinavia: +45/3/512014	04106/3998;
Switzerland: 01/9455432	0531/347121

**A** + L. Meier-Vogt  
Im Späten 23  
CH-8906 Bonstetten/ZH  
Switzerland  
Tel. (41)(1) 700 30 37



# PUT 420,000 MICRO MENTORS TO WORK.

Advertise in the new BYTE magazine and let the people other people come to for advice help spread your message. We have a total of 420,000 paid readers who are powerful because they're knowledgeable. Each one is a leader in personal computer decision-making at his company. And each one believes that ads in BYTE are a valuable source of information.

- 93% provide advice about *acquiring* micros, peripherals and software, an average of 25 times a month.
- 85% are directly involved in purchasing decisions about microcomputers and related equipment for their company.
- 96% work for a company that currently owns or uses microcomputers.
- 75% of these companies plan to buy an average of 145 microcomputers in the next 12 months.

In short, when it comes to making a purchase decision, people listen to BYTE readers. So if you're not planning on advertising in BYTE, you may be planning an advertising schedule without teeth.

**THE  
NEW  
BYTE**

SOURCE: 1988 BYTE Subscriber Profile

# BYTE LISTINGS YOUR WAY!

It's easy. Now there are three ways to get source-code listings that go with BYTE articles—on disk, in print or on line.

## LISTINGS ON DISK

BYTE listings on disk are right for you if you want to compile or run programs quickly. Also included on disk are the month's BIX highlights specific to your machine format.

## LISTINGS IN PRINT

This print supplement contains source-code listings described in the issues of BYTE.

## LISTINGS FROM BIX

(BYTE Information Exchange) By joining BIX, you can download BYTE source-code listings at standard BIX rates. See BIX informational ad listed in Reader Service index in this issue.



**FOR DIRECT ORDERING CALL TOLL FREE: 800-258-5485**

**Call: M-F, 8:30 a.m. to 4:30 p.m. Eastern Time**

**(603-924-9281 for New Hampshire residents)**

**For credit card orders only.**

## ON DISK - \*Including the Month's BIX Highlights Specific To Your Machine Format.

Disks of listings from December 1985 to present are available at the prices stated at right. Please mark the appropriate format and note the issue date below. If you are ordering a subscription, please note the issue date on which you would like it to begin.

Month \_\_\_\_\_

Year \_\_\_\_\_

	Single Month (one disk)	IN USA: Annual Subscription (13 disks)	OUTSIDE USA: Single Month (one disk)	Annual Subscription (13 disks)
<b>5 1/4 inch:</b>	<input type="checkbox"/> \$8.95	<input type="checkbox"/> \$69.95 (Save \$46.40)	<input type="checkbox"/> \$10.95	<input type="checkbox"/> \$89.95 (Save \$52.40)
<input type="checkbox"/> IBM PC*				
<input type="checkbox"/> Apple II				
<input type="checkbox"/> Kaypro 2 CP/M				
<input type="checkbox"/> MS-DOS 8 Sector*				
<input type="checkbox"/> TI Professional				
<b>3 1/2 inch:</b>	<input type="checkbox"/> \$9.95	<input type="checkbox"/> \$79.95 (Save \$49.40)	<input type="checkbox"/> \$11.95	<input type="checkbox"/> \$99.95 (Save \$55.40)
<input type="checkbox"/> Apple Macintosh*				
<input type="checkbox"/> Atan ST*				
<input type="checkbox"/> Amiga*				
<input type="checkbox"/> IBM PS/2*				

## IN PRINT

### 1988 Supplement Issues

- January through March \$6.95 in USA \$7.95 outside USA

Monthly supplements replace quarterly supplements starting in April. Indicate the month you're ordering in the space below.

Month \_\_\_\_\_

Year \_\_\_\_\_

\$2.50 per issue in USA  
\$3.60 per issue outside USA

### Annual Subscriptions:

\$19.00 in USA  
\$22.00 outside USA

Please note month and year you would like the subscription to begin.

Month \_\_\_\_\_

Year \_\_\_\_\_

### 1987 Supplement Issues

#### IN USA:

- January through March 1987 for only \$6.95.  
 April through June 1987 for only \$6.95. (Includes 1986 Index)  
 July through September 1987 for only \$6.95.  
 October through December 1987 for only \$6.95.  
 1987 subscription only \$18.00

#### OUTSIDE USA:

- January through March 1987 for only \$7.95.  
 April through June 1987 for only \$7.95.  
 July through September 1987 for only \$7.95.  
 October through December 1987 for only \$7.95.  
 1987 subscription only \$21.00.

### 1986 Supplement Issues

#### IN USA:

- January through June 1986 for only \$8.95.  
 July through September 1986 for only \$6.95.  
 October through December 1986 for only \$6.95.  
 1986 Annual Subscription for only \$18.00.

#### OUTSIDE USA:

- January through June for only \$9.95.  
 June through September for only \$7.95.  
 October through December for only \$7.95.  
 1986 Annual Subscription for only \$21.00.

FOLD  
HERE

## COMBINED DISK AND PRINT SUBSCRIPTION

Bundled together, giving you the convenience of disk-based source-code plus the ease of reference of print.

If you are ordering a subscription, please note the issue date on which you would like it to begin.

	IN USA: Annual Subscription	OUTSIDE USA: Annual Subscription
<b>5 1/4 inch:</b>	<input type="checkbox"/> \$89.95 (Save \$68.35)	<input type="checkbox"/> \$109.95 (Save \$75.35)
<input type="checkbox"/> IBM PC		
<input type="checkbox"/> Apple II		
<input type="checkbox"/> Kaypro 2 CP/M		
<input type="checkbox"/> MS-DOS 8 Sector		
<input type="checkbox"/> TI Professional		
<b>3 1/2 inch:</b>	<input type="checkbox"/> \$99.95 (Save \$61.35)	<input type="checkbox"/> \$119.95 (Save \$78.35)
<input type="checkbox"/> Apple Macintosh		
<input type="checkbox"/> Atan ST		
<input type="checkbox"/> Amiga		
<input type="checkbox"/> IBM PS/2		

FOLD  
HERE

Please complete in full.

SEPTEMBER

Name \_\_\_\_\_

Address \_\_\_\_\_

City \_\_\_\_\_ State \_\_\_\_\_ Zip \_\_\_\_\_

County or Parish \_\_\_\_\_ Country \_\_\_\_\_

Credit Card # \_\_\_\_\_

Exp. Date \_\_\_\_\_ Signature \_\_\_\_\_ Date \_\_\_\_\_

Check enclosed

MasterCard

VISA

U.S. Funds enclosed (If ordering from outside the U.S. please remit in U.S. funds drawn on a U.S. bank. Thank you.)

Please allow 4-8 weeks for delivery.

**BYTE**



FOLD  
HERE



NO POSTAGE  
NECESSARY  
IF MAILED  
IN THE  
UNITED STATES

**BUSINESS REPLY MAIL**  
FIRST CLASS MAIL PERMIT NO. 10 PETERBOROUGH, NH

POSTAGE WILL BE PAID BY ADDRESSEE

**BYTE** Listings

One Phoenix Mill Lane  
Peterborough, NH 03458-9990

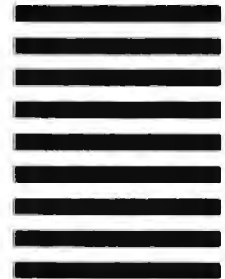

FOLD  
HERE

# THE BUYER'S MART

## A Directory of Products and Services

THE BUYER'S MART is a monthly advertising section which enables readers to easily locate suppliers by product category. As a unique feature, each BUYER'S MART ad includes a Reader Service number to assist interested readers in requesting information from participating advertisers.

RATES: 1x—\$475 3x—\$450 6x—\$425 12x—\$375  
Prepayment must accompany each insertion. VISA/MC Accepted.

AD FORMAT: Each ad will be designed and typeset by BYTE. Advertisers must

furnish typewritten copy. Ads can include headline (23 characters maximum), descriptive text (250 characters is recommended, but up to 350 characters can be accommodated), plus company name, address and telephone number. Do not send logos or camera-ready artwork.

DEADLINE: Ad copy is due approximately 2 months prior to issue date. For example: November issue closes on September 9. Send your copy and payment to THE BUYER'S MART, BYTE Magazine, 1 Phoenix Mill Lane, Peterborough, NH 03458. For more information call Mark Stone at BYTE 603-924-3754.

### ACCESSORIES

#### FREE CATALOG

Thousands of parts and new surplus electronic parts at super low prices. FAST ORDER PROCESSING AND SHIPPING (95% of all orders shipped within 48 hours).

CALL OR WRITE FOR A FREE CATALOG  
**ALL ELECTRONICS CORPORATION**  
P.O. Box 567, Van Nuys, CA 91408-0567  
**1-800-826-5432**

Inquiry 576.

### ACCESSORIES

#### YOUR OWN COMPUTER PAPER

Put your name and/or department, project, proposal, or report across the bottom of every final presentation page. Send us your copy plus name, address, phone number and printer make and model number and we'll send you FREE SAMPLES.

**FORMSMART, INC.**  
P.O. Box 592, E. Freetown, MA 02717

Inquiry 581.

### BAR CODES

#### BAR CODES & BIG TEXT

On EPSON, IBM, OKI dot matrix or LaserJet. Design any formatize on ONE easy screen. 1-120 field/label. 13 text sizes to 1" — readable at 50 ft. AIAG, MIL-STD, 2 of 5, 128, UPC/EAN, Code 39, etc. Color, Reverses, File Input, FAST—\$279. Other menu-driven bar code programs from \$48. 30 day \$ back.

**Worthington Data Solutions**  
417-A Ingalls St., Santa Cruz, CA 95060  
(800) 345-4220 In CA: (408) 458-9938

#### RE-INK COSTLY FABRIC RIBBONS AND SAVE!

Electric ribbon inker comes with FREE 3 oz. bottle ink, roller & roller cover. Specify printer manufacturer and model number. MC/VISA. Money-back guarantee. \$48 \$2.50. Canada, Hawaii, Alaska, COD \$48 \$5.

ImageWriter Inker \$48.00  
Epson Inker \$42.95  
Custom Inker—Factory set for your ribbon \$48.95

#### Bede Tech

8327 Clinton Rd., Cleveland, OH 44144  
800-772-4536 In Ohio 216-631-4214

Inquiry 577.

### ARTIFICIAL INTELLIGENCE

#### HIGH PERFORMANCE RULES BASED EXPERT SYSTEM "SHELL" (H.E.S.).

Caters for thousands and thousands of rules. Integrate with your existing database. Easy to use, no knowledge of programming required. Applications: medical diagnosis, fault diagnosis, business, admin, banking, finance, insurance, law, engineering, education, electricity boards and many other application areas. Available on PC/XT/AT, MS-DOS, Xenix, Unix. Demo copy \$84 (with facility to create 300 rules). Full version \$21,000.

#### HORIZON SOFTWARE LTD.

27 East St., Leicester LE1 6NS U.K.  
Tel (44) 533 568550

Inquiry 733.

### BAR CODE READERS

From the manufacturer for PC/XT/AT, & PS/2. Attaches as 2nd keyboard, reads as keyed data. External or bus install. With steel wand—\$399. Also Kimtron, Link, Wyse, & RS-232. Portables, Lasers, slot badge readers, and MagStripe tool. 30 day \$ back.

#### Worthington Data Solutions

417-A Ingalls St., Santa Cruz, CA 95060  
(800) 345-4220 In CA: (408) 458-9938

### FREE UPS CATALOG

Protect your computer and make it last longer. Call or write today!

#### Best Power Technology, Inc.

World's largest manufacturer of uninterruptible power systems.

P.O. Box 290, Necedah, WI 54648  
TOLL FREE (800) 356-5794 ext. 1003  
or (808) 565-7200 ext. 1003

Inquiry 578.

### NanoLISP \$99.99

An MS-DOS Common LISP interpreter that supports most Common LISP operations and strictly adheres to the standard. Numerous advanced and extra features, excellent debugging facilities, sample AI programs, fully-indexed manual, free technical support.

#### Microcomputer Systems Consultants

P.O. Box 6646, Santa Barbara, CA 93160  
(805) 967-2270

### PRINT BAR CODES/BIG TEXT FROM YOUR PROGRAM

Add bar codes and big graphics text to your program. Print from ANY MS-DOS language. Bar codes: UPC, EAN, 2 of 5, MSI, Code 39. Epson, Oki, IBM dot matrix text up to 1/2", LaserJet up to 2". Font cartridges not required. \$159-\$239. 30 day \$ back.

#### Worthington Data Solutions

417-A Ingalls St., Santa Cruz, CA 95060  
(800) 345-4220 In CA: (408) 458-9938

### CUT RIBBON COSTS!

Re-ink your printer ribbons quickly and easily. Do all cartridge ribbons with just one inker! For crisp, black professional print since 1982. You can choose from 3 models: Manual E-Zee Inker — \$38.50  
Electric E-Zee Inker — \$89.50  
Ink Master (Electric) — \$159.00

1000's of satisfied users in 5 years. Money back guarantee.

#### BORG INDUSTRIES

525 MAIN ST., JANESVILLE, IA 50647  
1-800-553-2404 In IOWA 319-887-2976

Inquiry 579.

### NEW Expert System

FirstExpert - expert system generator. Ridiculously easy yet extremely powerful. No programming needed. Speed up business decisions and analysis. Information transferable to other environments. Amplifies your intelligence! An ingenious program for a sensational price. Many examples included.

\$99 Call or write for more information.

#### NovaCast Expert Systems

2530 Beryessa Rd. Suite 607, San Jose, CA 95030  
(408) 272-4071 fax: (408) 437-7777

Inquiry 583.

### COMPLETE LINE OF BAR CODE PRODUCTS

- PrintBar II • PrintBar Softfonts
- PrintBar I • CodeScan 2000

FREE BROCHURES (916) 622-4640

#### Bear Rock Software Co.

8069 Enterprise Dr. Piscerville, VA 95667

### SELF-INKING PRINTER RIBBON

Awarded United States Patent #4701062  
Lasts 10-15 times longer than the conventional ribbon  
For printers using 1/2" width open spool ribbons:

Okidata 82A-83A-84-82-93 Dec LA 180/120  
Teletype-33, 35 Dec LA 350/84M 1443  
Star Gemini 10x Teletype-Model 40  
Epson TI 80081D, 820, 880

Contact us by mail, phone or telex and we will forward you a brochure.

#### CONTROLLED PRINTOUT DEVICES, INC.

POB 889, Baldwin Rd., Arden, NC 28704  
(704) 684-9044 • TELEX: (FILMON-AREN) 577454

Inquiry 580.

### muLISP™ 87 for MS-DOS

Fast, compact, efficient LISP programming environment. muLISP programs run 2 to 3 times faster & take 1/2 to 1/3 the space of other LISP's. 450 Common LISP functions, multi-window editing & debugging, flavors, graphics primitives, lessons & help, demo programs, comprehensive manual.

#### Soft Warehouse, Inc.

3615 Harding Ave., Suite 505, Honolulu, HI 96816  
(808) 734-5801

Inquiry 584.

### BAR CODE MADE EASY

PERCON® E-Z-READER™ keyboard interface and multiuse RS-232 models make it easy to add bar code to virtually any computer terminal WITHOUT SOFTWARE MODIFICATION. Immediate shipping. Top \$\$\$ warranty. Bar code printing software available. Call for details on fast, accurate, easy data entry. Substantial reseller discounts.

#### PERCON®

2190 W. 11th St., Eugene, OR 97402  
(503) 344-1189



# THE BUYER'S MART

## BAR CODES

### READ & PRINT BAR CODES

Fast, reliable data entry into your programs as if from your keyboard. Internal unit for PC, XT, AT PS/2-M30. RS-232 unit for DOS & Non-DOS systems (Incl. all PS/2). Stainless steel wand and LASER interfaces. Powerful Bar Code and Text printing software.

#### Seagull Scientific Systems

601 University Ave., Suite 150, Sacramento, CA 95825  
(916) 386-1776

## BAR CODE READERS

Among the industries best and most widely used barcode readers, reads all major barcode formats (code 39, 2 of 5, UPC/EAN, codebar), connects between keyboard & system, advanced CMOS uses keyboard power supply, connects to all IBM compatibles and DIN terminals, completely OS independent, software independent. Same day ship, 1 year warranty, 30 day satisfaction guarantee. CALL for prices too low to advertise.

#### Solutions Engineering Sales

8653 Georgia Ave., Silver Spring, MD 20910  
800-635-6533

Inquiry 585.

## DATA INPUT DEVICES

Bar Code & Magnetic Stripe Readers for microcomputers & terminals, including IBM PS/2 & others, DEC, AT&T, CT, Wyse, Wang. All readers connect on the keyboard cable & are transparent to all software. Low cost bar code print programs & magnetic encoders are also available. GSA contract #GS00K37AG53346

#### TPS Electronics

4047 Transport, Palo Alto, CA 94303  
415-856-6833 Telex 371-9097 TPS PLA

Inquiry 586.

## CAD/CAM

### New! CADJET for CADKEY3

Call, write or contact your CADKEY dealer for information on the exciting, new CADJET Overlays for CADKEY3. Makes CADKEY3 easy to learn and use.

—30 Day Money Back Guarantee—

**HLB Technology** 703-977-6520  
PO Box 827  
Blue Ridge, VA 24064 MC/VISA

Inquiry 587.

## \$39.95 CAD

Fully featured, symbols, auto dimensioning, hatching, fillets, reads DXF, handles all but the largest drawings. Extremely powerful BASIC-like macros, on line manual plus so much more. Requires IBM XT/AT/PS2 with 640K and hard disk. 20,000 new users this year.

#### PAFEC INC.

5550 Technology Park, Norcross, GA 30092  
1-800-52PAFEC (404) 441-9300

Inquiry 588.

## CASE

### Affordable CASE

A new concept in Computer Aided Engineering for developing PC/DOS applications! C Dispatcher generates fast, efficient C code for command and menu driven applications. Develop, document, and change easily. Many features. For many compilers. \$295.00 MC/Visa

#### Amaryllis Inc.

563 Wataquodoc Rd., Bolton, MA 01740  
(617) 365-6456

Inquiry 589.

322 B Y T E • SEPTEMBER 1988

## CASE

### FINITE STATE COMPILERS

A Case program that develops complex software programs in minutes instead of hours! The COMPEDITOR forms source Finite State programs in: ADA, BASIC, C, FORTRAN and PASCAL.

IBM PC, XT, AT, PS/2 175K RAM Dos 2.0+  
Price: \$175.00 per compiler (With Primer) Sampler \$30

AYECO 5025 Nassau Circle, Orlando  
INCORPORATED FL 32808 1-800-537-4753

Inquiry 590.

## CD-ROM

### Public Data on CD-ROMs

- Econ/State I — Prices, Employment
- Consu/Stats — BLS/Census 1984 consumer data
- Agri/State — Agricultural series
- Makes tables, DIF, or ASCII
- \$49 each, req. MS-DOS
- CD-ROM publishing services available

#### Hopkins Technology

421 Hazel Lane, Hopkins, MN 55343  
(612) 931-9376 CompuServe 74017,614

Inquiry 591.

## COMMUNICATIONS

### MULTI-LINE PC-DOS BBS

The Bread Board System (TBBS): Secure, reliable, full-featured commercial information system for IBM XT/AT/386/PS2 or compatible. Menu editor allows customization by nonprogrammers. Kermit, X & Y. Modem. High performance allows up to 32 simultaneous callers. User audit trail.  
300/1200/2400/9600 bps.

#### eSoft, Inc.

15200 E. Girard Ave. #2550, Aurora, CO 80014  
(303) 699-6565

Inquiry 592.

### Bi-Directional File X-fers

Multi-Com telecommunications program offers the following:

- Simultaneous Downloading/Uploading
- Send/Receive Console Messages During File Transfers
- 100% Line Utilization During Multi-File Transfers
- Uses Full Duplex ADLC Protocol
- More Efficient Than Xmodem, Kermit, etc.
- Saves Time and Cuts Connect Costs

Information & 5 1/4" Demo Disk \$5.00 • CD with Program, 3 1/2" & 5 1/4" disks, manual... \$49.95 • \$4.95

**Multiplex Systems** (412) 276-3374 24 hrs.  
PO. Box 16174, Pittsburgh, PA 15242

Inquiry 593.

### FAX MACHINES \$395

MURATA FAX 1200/1800 ..... \$795/925  
SHARP FAX F0300/F0500 ..... \$1195/1495  
TOSHIBA FAX 30100/3300/3700 ..... \$1088/1240/CALL  
RICOH 10/20 ..... \$1295/1595  
CANON FAX 20 ..... \$1279  
PC/XT SYS.Receive/Transmit FAX + Scanner ..... \$1595  
PC/XT Telephone Answer & Voicemail ..... \$1195

Prorated prices Visa/MC 2% cash 2% restock 20%  
**TELEPHONE PRODUCTS CENTER**  
2369 #213 El Toro Rd., El Toro, CA 92630 714/739-9556

Inquiry 594.

## COMPUTER INSURANCE

### INSURES YOUR COMPUTER

SAFEWARE provides full replacement of hardware, media and purchased software. As little as \$39 a year provides comprehensive coverage. Blanket coverage; no list of equipment needed. One call does it all. Call 8 am-10 pm ET. (Sat. 9 to 5)

**TOLL FREE 1-800-848-3469**

(Local 614-262-0558)

**SAFEWARE, The Insurance Agency Inc.**

Inquiry 595.

## COMPUTER RENTALS

### RENTALS

WEEKLY MONTHLY YEARLY

IBM - APPLE

COMPAQ

**\$189**

Full Stock/Next Day Delivery  
Free Service & Maintenance

IBM PS/2 Model 50

800 PC-RENTL

Inquiry 596.

## CROSS ASSEMBLERS

### CROSS ASSEMBLERS

Universal Linker, Librarian

Targets for 36 Microprocessors

Hosts: PC/MS DOS, micro VAX, VAX 8000

Developed and supported at:

**ENERTEC, INC.**

BOX 1312, Lansdale, PA 19448

215-362-0966

MC/VISA

Inquiry 597.

### Professional Series

PseudoCode releases it's PseudoSam Professional Series of cross assemblers. Most popular processors: Macro, Conditional Assembly, and Include Files. Virtually unlimited size. For IBM PC's, MS-DOS 2.0 or greater. With manual for \$35.00. Each additional \$20.00. (MI res. 4% tax). Shipping \$5, Canada \$10, Foreign \$15. Visa/MC (Dealer Inquiries Welcome)

#### Kore

6910 Patterson, Caledonia, MI 49318

616-791-9333

Inquiry 598.

### CROSS ASSEMBLERS

Macros, PC Compatible, Relocatable, Conditionals, Fast, Reliable . . . . . from \$150

also: Disassemblers

EPROM Programmer Board

**MICROCOMPUTER TOOLS CO.**

Phone (800) 443-0779

In CA (415) 825-4200

812 Hastings Dr., Concord, CA 94518

Inquiry 599.

### 680X0 Cross Assemblers

Now, inexpensive quality 680X0 Cross Assemblers that use your IBM PC or compatible. All versions include extensive listing facilities, up to 32 color labels, sorted symbol tables, INCLUDE files, PITH names, OPG, OC, DS, EQL, many other directives (except MACROS), printed manuals. Basic versions create 5-records. Listing versions create either 5-records or relocatable modules, and include a linker which creates 5-records or binary output files. List copy protected. Minimum requirements are 320K, DOS 2.0X, & 160K+ 20000.  
Basic 68000/68010—\$49.95 Listing 68000/68010—\$69.95  
Basic 68020—\$69.95 Basic 68020/68881—\$79.95  
Checks, VISA, MC accepted. MN residents + 4% sales tax. No PCs or COOs, please.

#### RAVEN Computer Systems

Box 12118, St. Paul, MN 55112 (612) 636-0366

Inquiry 600.

### Z80/HD64180

SLR Systems cross assemblers run on PC and are compatible with Microsoft M80/L80. \$195.00 for assembler and linker. We have CPM emulator cards for PC. Up to 12.5 mhz Z80 clock speed, starting at \$249.95! Also Z80/HD64180 C compilers.

#### Z-World

1772 Picasso Ave., Davis, CA 95616 (916) 753-3722  
Please see our ads on page 348.

Inquiry 601.



# THE BUYER'S MART

## DATA CONVERSION

### MEDIA CONVERSION/DATA TRANSLATION

More than just a straight dump or ASCII transfer! Word Processing, DBMS, and Spreadsheet data on Disks or Tapes transferred directly into applications running on Mainframes, Minis, Micros, Dedicated Word Processors, Typesetters, and Electronic Publishing systems. IBM PS/2 & Macintosh supported #1 in the translation industry!

#### CompuData Translators, Inc.

3325 Wishnie Blvd., Suite 1202, Los Angeles, CA 90010  
(213) 387-4477 1-800-825-8251

Inquiry 602.

## DATABASE MGMT. SYSTEMS

### dBASE III WORKALIKE \$39

1 on 1 = 311 "a programmable relational DBMS... the menu mode is a fancier and more complete version of dBASE's... faster operation in the interactive mode... at \$39, 1 on 1 = 311 is a great deal for those who would be glad to have a dBASE III Plus clone!" PC MAGAZINE 5/17/88

\$39 + \$4 s/h AMEX add \$2.00

#### 1 on 1 Computer Solutions

26 Finchwood Dr., Trumbull, CT 06611  
203-375-0914

dBASE III is a trademark of Ashton-Tate

Inquiry 603.

## DATA/DISK CONVERSION

### QUALITY CONVERSIONS

• Disk • Scanning • Tape

\*TYPEWRITTEN \$33 per page to ASCII

\*TYPESET 6-24 point Low Rates

(\*WP Formats available)

IMAGES

Logos/Line Art/Glossies

#### 1st Run Computer Services Inc.

1261 Broadway, Suite 508, New York, NY 10001

(212) 778-0800

Inquiry 604.

### Get the Expertise You Need!

Disk/Disk • Tape/Disk • OCR

Over 1,000 formats! 3 1/2, 5 1/4, or 8 inch disks; 9 track mag tape; 10 MB Bernoulli cartridge. Data base and word processor translation. Specialists in Government Security Data. Call for free consultation.

#### Computer Conversions, Inc.

9580 Black Mtn Rd., Ste J, San Diego, CA 92126

(619) 693-1697

Inquiry 605.

## DISK CONVERSIONS

Media transfer to or from: IBM, Xerox, DEC, Wang, Lanier, CPT, Microm, NBI, CT, also WP, WS, MS/WORD, DW3, MM, Samna, DEC DX, MAS 11, Xerox-Writer, ASCII.

### FREE TEST CONVERSION CONVERSION SPECIALISTS

531 Main St., Ste. 835, El Segundo, CA 90245  
(213) 545-6551 (213) 322-6319

Inquiry 606.

## DISK & TAPE CONVERSIONS AUTOMATICALLY

SAVE TIME AND MONEY

Over 1000 formats from Mini, Micro Mainframe, Word Processors, & Typesetters.

TAPE Conversions as low as \$23.00 MB

DISK Conversions as low as \$15.00 per Disk

Call or write TODAY for a cost saving quotation.

#### CREATIVE DATA SERVICES

1210 W. Latimer Ave., Campbell, CA 95008

(408) 866-6080

Inquiry 607.

## DATA/DISK CONVERSION

### HEWLETT PACKARD TO MACINTOSH

Translate programs written in Hewlett Packard BASIC to run on the Macintosh. Copy files from HP Technical computers to Macintosh. Custom work quoted. Write:

#### Oswego Software

5525 N. Broadway St., Indianapolis, IN 46220

Inquiry 608.

## CONVERSION SERVICES

Convert any 9 track magnetic tape to or from over 1000 formats including 3 1/2", 5 1/4", 8" disk formats & word processors. Disk to disk conversions also available. Call for more info. Introducing OCR Scanning Services.

#### Pivar Computing Services, Inc.

165 Arlington Hgts. Rd., Dept. #B

Buffalo Grove, IL 60089 (312) 459-6010

Inquiry 609.

## DEMOS/TUTORIALS

### INSTANT REPLAY III

Build Demos, Tutorials, Prototypes, Presentations, Music, Timed Keyboard Macros, and Menu Systems. Includes Screen Maker, Keystroke/Time Editor, Program Memorizer, and Animator. Rec'd Great Reviews! Simply the BEST. Not copy protected. No royalties. 60 day satisfaction money back guar. IBM and Compat. \$149.95 U.S. Chk/Crd. Demo Diskette \$5.00

#### NOSTRADAMUS, INC.

3191 South Valley Street (ste 252)

Salt Lake City, Utah 84109 (801) 487-8662

Inquiry 610.

## DESKTOP PUBLISHING

### HIGH RESOLUTION MONITOR

- Desktop Publishing and CAD low cost graphics subsystem
- Workstation Resolution for your IBM PC/XT or AT compatible
- 1024 x 768 paper white 14" flat screen
- Drivers for Ventura, Page Maker, Windows, GEM and AutoCAD
- Can connect with another color graphics adapter
- Call NOW \$595 including graphics board, monitor and software
- VISA and MasterCard accepted

#### CATI INC

16840-B Jolien Way, Morgan Hill, CA 95037

HOT LINE 408-778-CATS

Inquiry 611.

## DISK COMPATIBILITY

### IBM PC's USE Mac DISKS

MatchMaker lets you plug any Macintosh external floppy drive into an IBM PC. Half size card and software lets you copy to/from, view directory, initialize, or delete files on the Mac diskette. Works with PCs, XT's, AT's, and compatibles. The easy way to move information!

\$149.00 Visa/MC/COD/Chk.

#### Micro Solutions Computer Products

132 W. Lincoln Hwy., DeKalb, IL 60115 615/756-3411

Inquiry 612.

## DISK DRIVES

### HARD DISKS

ST 4096 \$549 Micropolis \$575

Miniscribe \$639 ST251 \$339

ST251-1 \$399 148MB 28ms \$839

#### CPU INC

(714) 870-9033

Inquiry 613.

## DISK DRIVES

### PS/2 DRIVES FOR PC's AT's

CompatKit/PC ..... \$329

CompatKit/AT ..... \$269

Built-in floppy controllers—no problem.

Supports multiple drives and formats. Lets your

computer use IBM PS/2 1.44M diskettes plus more!

Call for further information or to place an order.

VISA/MC/COD/CHECK.

Micro Solutions Computer Products

132 W. Lincoln Hwy., DeKalb, IL 60115 615/756-3411

Inquiry 614.

## DISK DUPE EQUIPMENT

### DO YOUR OWN DUPLICATION

Copy 10,000 or only 10 . . . . in as little as 15 seconds each with famous Mountain Duplication equipment at the very best prices!! See us for all of your duplication equipment needs from Disks to Drives to Duplicators.

#### SYSTEMS SUPPORT DATA

223 North Royal Avenue, Front Royal, VA 22630

1-800-231-4355

Inquiry 615.

## DISK DUPLICATION

DUPLICATION IS THE SINCEREST FORM OF FLATTERY

Let us Flatter you!! See us for all disk duplication needs. 10 disks to 100,000 and more All formats—All systems. Best prices—Our own in-house printing of documentation—labels—sleeves.

#### SYSTEMS SUPPORT DATA

223 North Royal Avenue, Front Royal, VA 22630

1-800-231-4355

Inquiry 616.

## DISKETTES

### CHEAP DISKS!!!

Although this headline may not convey quality. . . . our 3 1/2" floppy disks do!

100% Certified

720pk only 98¢

1.44 MEG only \$2.60

#### SYSTEMS SUPPORT DATA

223 North Royal Avenue, Front Royal, VA 22630

1-800-231-4355

Inquiry 617.

## DUPLICATION SERVICES

### SOFTWARE DUPLICATION

- One Stop Shopping
- Technical Support
- Custom Packaging
- Drop Shipping
- Copy Protection
- Fast Turnaround
- Competitive Pricing

SATISFACTION GUARANTEED

800-222-0490 NJ 201-462-7628

#### MEGAsoft

P.O. Box 710, Freshkill, NJ 07728 See our ads on page 336

Inquiry 618.

## SOFTWARE PRODUCTION

- Disk duplication
- Warehousing
- All formats
- Drop shipping
- EVERLOCK copy protection
- Fulfillment
- 48-hour delivery
- Label/sleeve printing
- Consultation & guidance services

#### Star-Byte, Inc.

713 W. Main St., Lansdale, PA 19446

215-368-1200 800-243-1515

Inquiry 619.



# THE BUYER'S MART

## ELECTRONIC PROJECTS

### BUILD TALKING ROBOT!

- Build B.E.R.T.O. the Basic Educational Robot Trainer
- Featured in BYTE April & May / 87
- Even a child can program the talking Robot, built from off-the-shelf components
- Minimum Kit \$80.00 U.S.
- Complete Kit \$180.00 U.S.
- For further information write to:

#### GoCo Dist.

Suite 808, 1146 Harwood St.  
Vancouver, B.C. Canada V6E 3V1

Inquiry 620.

## ENTERTAINMENT

### NEMESIS™ Go Master™

Go is a popular Oriental game of intellectual complexity and elegance. NEMESIS, recognized worldwide as the best Go program, is an ideal playmate and tutor. Pourmelle's game of the month twice: "If you are interested in Go, buy this program." BYTE 7/87

#### Toyogo, Inc.

76 Bedford St., Ste. 344, Lexington, MA 02173  
(617) 861-0488

Inquiry 621.

## FLOW CHARTS

### FLOW CHARTING II+ HELPS YOU!

Precise flowcharting is fast and simple with Flow Charting II+. Draw, edit and print perfect charts: bold and normal fonts, 28 shapes — 95 sizes; fast entry of arrows, bypasses & connectors; Fast Insert Line, shrink screen displays 200-column chart; 40 column edit screen for detail work, touch moral

#### PATTON & PATTON

81 Great Oaks Blvd., San Jose, CA 95119

1-800-525-0082 (Outside CA)

408-629-5376 (CA/Int'l)

Inquiry 622.

### STRUCTURED FLOW CHART

NSChart creates Nassi-Shneiderman (structured) flowcharts from a simple PDL. Keywords define structures & text strings appear in the chart. Easy to create, even easier to revise! Automatic chart sizing, text centering. Translators for many languages available. For Mac and IBM PC.

#### SILTRONIX, INC.

P.O. Box 82544, San Diego, CA 92138

1-800-637-4888

Inquiry 623.

## GRAPHICS/SOFTWARE

### TurboGeometry Library

Over 150 2&3 dimensional routines, includes Intersections, Transformations, Equations, HiddenLines, Perspective, Curves, Areas, Volumes, Clipping, Planes, Vectors, Distance, Polydecomp, IBM PC and Comp. MAC. MSDOS 2+ Turbo Pascal, Turbo C, MSC & Turbo Pascal MAC. 400 pg. manual, source code. \$149.95 + 5.00 S&H. VISA, MC, Chk. PO. 30 Day guarantee.

#### Disk Software, Inc.

2118 E. Arapaho #487, Richardson, TX 75081  
(214) 423-7288

Inquiry 624.

## HARDWARE

### IBM PS/2's Up to 41% off

	Retail	Your Cost
MODEL 50-388	(New)	\$Call
MODEL 60-041	6,296	3,335
MODEL 60-071	6,295	3,777
MODEL 60-041	6,995	4,395
MODEL 60-071	8,495	4,995
MODEL 80-111	8,995	8,095
MODEL 80-311	11,995	8,835

American Micro Computer Center (305) 985-6406  
2890 Griffin Rd., Suite #4, Ft. Lauderdale, FL 33312

Inquiry 625.

## HARDWARE

### MYRIAD MODEM 2400BPS ONLY \$119

- Hayes compatible
- For IBM PC/XT/AT & compatibles
- Made in USA
- Free Bitcom software
- 4 Com ports selectable
- 2 years warranty

#### DATA ERA STORE (408) 729-4589

1556 Halford Ave., No. 168, Santa Clara, CA 95051

Inquiry 626.

### 8096 Microcontroller

Single Board 8096/7, Ser. Interface, 5V only; Assembler+Forth in EPROM+Manual/Software Guide \$400. Add-on EPROM Simulator Incl. download SW \$350. Hardware/Software evaluation package incl. cabling and tutorial books \$580. Cross Compiler (Assembler/Forth) available.

#### DIGITAL MICRO CONTROL

16617-25th Drive S.E., Mill Creek, WA 98012  
(206) 338-2406

Inquiry 627.

### CHIP CHECKER

- 74/54 TTL + CMOS
- 144000 CMOS
- 14-24 Pin Chips
- 8000 Nuz. + Signetics
- 9000 TTL
- .3" + .8" IC widths

Tests/Identifies over 650 digital chips with ANY type of output in seconds. Also tests popular RAM chips. IBM compatible version \$259. C128 + C64 version \$199.

#### DUNE SYSTEMS

2803 Wills Dr., St. Joseph, MI 49085

(616) 983-2352

Inquiry 628.

### Rack-Mounted AT 286 or 386

Industrial, Med-Tech, Laboratory and Comm. needs  
◊ Intel 60286 or 80386 CPU daughter card ◊ Passive back plane (8-10 expansion slots) ◊ Fits standard 19" rack ◊ Heavy duty dust fans ◊ Clean air filter ◊ High-speed, high-quality hard disk available ◊ Slide-mounted CPU chassis for easy maintenance access ◊ Power supply up to 280 Watts. For details and prices, Contact:

(516) 589-8666

#### International

Telecommunications Services

Inquiry 629.

### FREE CATALOG

Protect your computer power from black-outs, brown-outs, audio/video hash and surges! Complete line of low cost Emergency Power Supply units, Line Conditioners and Surge Suppressors prevent damage and loss of valuable data. Prevent errors, malfunctions and false printouts! Send for money saving catalog today.

#### INDUS-TOOL

730 W Lake St., Chicago, IL 60606

Phone 312-648-2191

Inquiry 630.

### PC CARDS/KITS

- 8 bit A/D card, 0-5V ..... \$79
- 8 bit D/A card, 0-2.5V ..... \$79
- Relay driver card, 8 outputs (3A) ..... \$149
- Digital I/O (8 TTL input/output) ..... \$79
- JB XT computer kit w/monitor ..... \$499

• FREE CATALOG—parts, kits, computers

#### JB COMPU-TRONIX

3816 N. Wadsworth Blvd., Wheat Ridge, CO 80033

(303) 425-9586

Inquiry 631.

## HARDWARE

### LATEST VERSION AWARD BIOS

NOW, you can have the latest AWARD BIOS for your PC/XT, 286 or 386. Upgrade your old machine for VGA, networking and new keyboard and hard drive types. Fast, knowledgeable service, guaranteed results.

Call 1-800-423-3400 (9:00 AM to 8:00 PM EST)

#### KOMPUTERWERK, INC.

851 Parkview Blvd., Pittsburgh, PA 15215

For info., call (412) 782-0384

Inquiry 632.

### 87C51 PROG. \$125.00

The UPA 87C51 Programming Adapter lets you use your general purpose programmer to program the 87C51, 8751H, AMD8753H, 87C252, and 8752BH. Also lets you program the 87C51/8751H security bits and the 87C51 encryption array. It's very simple and VERY cost effective.

#### LOGICAL SYSTEMS CORPORATION

8184 Teall Station, Syracuse NY 13217

(315) 478-0722

Telex 6715617 LOG88

Inquiry 633.

### BUY ★ SELL ★ TRADE

Apple • IBM • Compaq • Service Parts  
• Accessories • Systems •

#### PRE-OWNED Electronics, Inc.

30 Clematis Avenue, Waltham, MA 02154

800-274-5343 FAX 617-891-3556

Service Centers and Dealers welcome

Inquiry 635.

### SANYO 550/556 USERS

3.6/7.2MHz TURBO BD. W9008-2	\$79.95
IBM STYLE CGA VIDEO BD.	\$159.95
IBM STYLE RS-232	\$79.95
SANYO RS-232	\$49.95
768K MEMCLK/EXPANSION BD.	\$169.95
20 MEG HARD DISK SYSTEM	\$599.95
COMPOSITE MONO MONITOR	\$109.95
550 COMMUNICATIONS SOFTWARE	\$49.95

#### TAMPA BAY DIGITAL

1750 Drew St., Clearwater, FL 34615

\*\*\* FREE CATALOG \*\*\* 813-443-7046

Inquiry 636.

### 6800 / 68020 / 68881 COMPLETE DEVELOPMENT SYSTEM

for the 68000, 68020 and 68881 chips—includes the chips, power supply, serial interface with software, 68000/68020 cross assembler (hosted on a PC), documentation, schematic, Operating System, cables. Special Price—\$1100.00

#### Phone URDA, Inc.

1-800-338-0517

Inquiry 637.

## HARDWARE COPROCESSORS

### DIGITAL SIGNAL PROCESSOR

DSP products for the IBM PC/XT/AT based on the TI TMS32010 and TMS320C25. Designed for applications in communications, instrumentation, speech, and numeric processing. Offered with 12 bit 80 KHz A/D and D/A and continuous data acquisition & playback option. \$850 and up.

#### DALANCO SPRY

Suite 241, 2800 Connecticut Ave. NW,

Washington DC 20008

(202) 232-7899

Inquiry 638.



# THE BUYER'S MART

## HARDWARE/ENGINEERING

**RF/MICROWAVE PROBLEMS?** Soln Laboratories, Inc. would like to help. With laboratory facilities in Norcross, GA and Plano, TX, SOLN Labs has a broad range of experience in solving electronic circuit design problems. Specializing in RF/Microwave circuits, we provide complete R&D services in all areas of electronic technology including microprocessor based systems. Services range from basic consulting to turnkey system development. For more information, call or write:

**SOLN Laboratories, Inc.**  
Microwave Systems Division  
732A Holcomb Bridge Rd., Norcross, GA 30071  
Phone: (404) 449-8536

Inquiry 639.

## HARDWARE/PERIPHERALS

### BUILD SCALE SYSTEMS FOR LESS

For a fraction of your present cost, you can produce professional computerized weighing systems using building-block interface modules and software. They're versatile, easy to use and unbeatable value.

Call or write for brochures, prices and examples taken from our wide industrial experience.

#### SCALE-TRON INC.

P.O. Box 424, Lachine, Quebec, H8S 4C2 CANADA  
(514) 634-7083

Inquiry 640.

## HUMAN FACTORS

### Design Better Screens!

NaviText™ SAM gives you hypertext access to the best user interface design guidelines. SAM helps you evaluate usability, too. It's a human factors consultant on a disk! For PC's, it costs \$295.

**Northern Lights Software Corporation**  
24A Pilgrim Dr., Box 1066, Westford, MA 01886  
(508) 692-3600

Inquiry 641.

## IMAGE PROCESSING

### ZIP Image Processing

ZIP brings video image processing to the PC. Control image/size video digitizer, use 1 or 2 serial ports to capture/display images from any video source. Outstanding image display on EGA/VGA/AGA in color and 64 gray levels.

Call (314) 962-7833 for VISA/MC, or send check \$79 + \$2 s/h. MO add 5.8%.

**Hogware Company**  
470 Bellevue, St. Louis, MO 63119  
(314) 962-7833

Inquiry 642.

## INFORMATION

The "Economic Report of the President" has concise tables of the major economic indicators (GDP, Employment, Inflation, Population the deficit, and much more.) The Tables of the 1988 Report are now available on disk in (CAL, WKS, CSV, or TXT) formats for (PC or MAC or most CP/M)—\$49.95

#### FAIRFACTS

Box 536, San Rafael, CA 94915  
Tel. 415-485-1781

Inquiry 643.

## INVENTORY MANAGEMENT

#### STOCK-MASTER 4.0

Commercial grade inventory management software at micro prices.

- Supports all 12 transaction types
- Trend Analysis
- Quality Control
- Multiple Locations
- Purchase Order Tracking
- Open Order Reporting
- Serial/Lot # Tracking
- Activity History Analysis
- Bill of Materials
- Purchase Order Writing
- Order Entry
- Material Requirements
- On Line Inquiry

**Applied Micro Business Systems, Inc.**

177-F Riverside Ave., Newport Beach, CA 92663 714-798-0582

Inquiry 644.

## LANS

### Are you about to spend thousands of dollars for Novell or 3-COM?

The invisible Network does the same thing, but costs only \$249 per machine. True NETBIOS-compatible Local Area Network with high-speed 1.8 Mbps interface cards, cables, and all networking software. Works great with Multi-user dBASE, Clipper, QuickSilver, FoxBASE+, and all other file-sharing and multi-user software.

**Database Specialties (415) 652-3630**  
P.O. Box 2975, Oakland, CA 94618

Inquiry 645.

## LAPTOPS

### LAPTOP SPECIALS

Toshiba • Zenith • NEC • DAD/MUE • SHARP • NEW! Hard drives available for Tandy 1400 LT & Toshiba 1100+ • AFFORDABLE 5¼" or 3½" DRIVE UNITS for LAPTOPS & DESKTOPS • DICONIX PRINTERS • 768 card for T1000 • 2400 BAUD MODEMS for Laptops • Fast reliable and friendly service. For Low Pricing call

**COMPUTER OPTIONS UNLIMITED**  
201-469-7678 (7 Days, 9 am-10 pm Eastern time)

Inquiry 645.

### File Transfer Utility

2 PC: Connects any two PC's for file transfer and communication. Features: 115,200 baud transfer rate • directory trees • chat mode • file tagging/view/delete • print facility • universal cable • hex cable wiring diagram (so you can "roll your own" cable) • 3½" & 5¼" disks. Complete - \$55 (List: \$80), without cable - \$45. 2PC Lite: Less Expensive. Works Great! Complete - \$40 (List: \$60), without cable - \$30.

Both programs have 43-line mode.

**Thompson Computing, 687 N. Ventu Park Road,**  
Suite 306, Newbury Park, CA 91320, (805) 498-7653.  
VISA/MC add 4%

Inquiry 646.

### LAP-LINK

The ultimate solution for linking laptop computer with any IBM compatible desktop PC. 115,200 baud transfer rate—faster than any other product available. No installation necessary, easy to use split screen design. Includes incredible "universal cable" that connects any two computers. Transfer entire disks faster than a DOS copy command! Only \$129.95 including universal cable and both 3½" and 5¼" disks. "Bridge" owners can trade in for only \$89.95 w/o cable.

#### Traveling Software, Inc.

19310 North Creek Parkway, Bothell WA 98011  
1-800-343-8080 (206) 483-8088

Inquiry 647.

## LASER PRINTER RECHARGE

### Discover How to Save 30%—50% on Toner Cartridges

Let us recharge your toner cartridges for HP Series 1 & II, Apple, Canon, QMS & others. Also Canon, PC models 10, 14, 20 & 25. Factory-like method, no holes drilled. Send cartridge w/rech for \$39.95 to nearest factory.

Dealerships and Training Available

#### Laser Tech

27403 E. Hwy 4 118 N. Van Rensselaer  
Farmington, CA 95230 Rensselaer, IN 47578  
(208) 886-5440 (219) 886-8233

Add Sales Tax for CA & IN Residents

Inquiry 648.

## LEGAL

### LEGAL DOCUMENT MAKER

All pleadings and documents. Any word processor software. Free Brochure. New! Supra II™.

#### TSC - The Software Company

P.O. Box 672887, Washita, AK 90887  
(907) 373-8550

Inquiry 649.

## MAC

### DEVELOPMENT TOOLS

Professional Programmers Extender: Standard Mac interface, lists, printing, graphics, tiling. Extender GraphPac: Quality color graphs. Line, bar, semi-log, customizable symbols.

**INVENTION Software**  
(313) 996-8108

Inquiry 650.

## MEMORY CHIPS

### MEMORY CHIPS

61264-15-12-10	Call 51000 (1 Meg)	Call
4184-15	Call 51258 for Compaq 386	Call
4184-12	Call 80673-2	Call
4128 Piggy Back for AT	Call 80287-6-8-10	Call
61464-12 (64Kx4)	Call 80367	Call
414256 (256Kx4)	Call MECA20-8	Call
2764.27126.27264.27512	Call NUCSA	Call

Prices subject to change

**ESSKAY 718-353-3353**

Inquiry 651.

## MUSIC

### MIDI — PC/XT \$84.95

Your MIDI instruments can talk with your PC/XT via a MIDIATOR®. Software INCLUDED! MT-8 Sequencer, Performance Splitter/Auto-Chord, & MIDI Monitor. Requires 256K, DOS 2.0+, Std. Serial Port (COM1 or COM2) & std. cables. Needs no modifications, exp. 190L, or power sup. Introductory Price \$84.95 + \$5.00 s/h. TX res. add 7.25% tax. MC, VISA, Check (allow 10 days)

#### Key Electronic Enterprises

9112 Hwy. 80 W., Suite 221-B, Fort Worth, TX 76116  
(817) 560-1912

Inquiry 652.

## PC BOARDS

### P-C-B ARTWORK MADE EASY!

- Help Screens
- Dip & Slip Library
- Printer or Plotter Artwork
- Supports Mouse
- Auto-Router available
- ICON Menus

Requirements: IBM or Compatible PC, 384K RAM, DOS 3.0 or later.

PCBoards: \$99.00 DEMO: \$10.00

#### PCBoards

2145 Highland Ave./Ste 201, Birmingham, AL 35205  
(205) 833-1122

Inquiry 653.

## PROGRAMMERS TOOLS

### Microsoft QuickBASIC does Database Management.

db/LIB Database Library is 100% dBASE file compat. Only \$139.00.

#### AJS Publishing, Inc.

(800) 992-3363  
(818) 985-3383 IN CA.

Inquiry 654.

### C or T Pascal Code Instantly

Complete database in just minutes. Draw & Paint your screen, show what fields to use for indexes—That's it—running source code in 6 seconds. Automatic context sensitive help, programmer docs on each program. \$389/TPascal ver. or \$499/TC or MS-C ver.

**Call ASCII (800) 227-7681**

Inquiry 654.



# THE BUYER'S MART

## PROGRAMMERS TOOLS

### TLIB™ 4.0 Version Control

The best gets better! They loved TLIB 3.0: "packed with features... [does deltas] amazingly fast... excellent"—PC Tech Journal Sept 87. "has my highest recommendation"—R. Richardson, Computer Shopper Aug 87. Now TLIB 4.0 has: branching, more keywords, wildcards & file lists, revision merge, LAN and WORM drive support, more. MS/PC-DOS 2.x & 3.x \$99.95 + \$3 s&h. Visa/MC.

#### BURTON SYSTEMS SOFTWARE

P.O. Box 4156, Cary, NC 27519 (919) 856-0475

Inquiry 655.

### TURBO PLUS \$99.95

Programming tools for Turbo Pascal 4.0 Screen Painter, Code Generator, I/O Fields, Dynamic Menus, Programming Unit Libraries, Sample Programs, 200 Page Illustrated Manual, 60 Day Satisfaction Guarantee! Brochures & Demo Diskettes avail. Highly Favorable Reviews! IBM & Compatibles.

#### Nostradamus Inc.

3191 South Valley St. (Suite 252) Salt Lake City, UT 84108 (801) 487-9662

Inquiry 656.

### Get INSIDE!

INSIDE! is a powerful software performance analysis tool for popular PC compilers. INSIDE! measures the execution time of every function or procedure with microsecond accuracy or computes how often each source line is executed. Simply compile your application and INSIDE! does the rest.

#### Paradigm Systems Inc.

P.O. Box 152, Milford, MA 01757 (800) 537-5043 In MA: (508) 478-0499

Inquiry 657.

### Modula-2

Our new Potpourri Catalog lists a large number of small, inexpensive modules—many for less than \$25. Please call for your free copy. Inquiries from new authors welcome. From the creators of Repertoire, M2Asynch, DynaMatrix, EmsStorage, Graphix, Macro2, NetMod, and Repertoire/Brieve Toolkit.

**PMI** 4536 SE 50th, Portland, OR 97206 (503) 777-8844; TLX: 650-2691013

Inquiry 658.

### FREE BUYER'S GUIDE

See Page 39

Programmer's Connection is an independent dealer representing more than 250 manufacturers with over 750 software products for IBM personal computers. Call to receive our FREE comprehensive Buyer's Guide or refer to page 39 of this issue to see a partial list of our software products.

#### Programmer's Connection

800-336-1166  
216-494-3781

Inquiry 659.

### DISASSEMBLERS MPU OBJECT CODE on your PC

Relocatable, symbolic disassemblers are now available for the Motorola, Intel, RCA, TI, Rockwell, & Zilog micro! Automatic label generation, assembly capability and much more. Call and ask for what you need

#### RELMS™

P.O. Box 8719, San Jose, CA 95150 (408) 356-1210

TWX 910-379-0014 (800) 448-4880

Inquiry 660.

## PUBLIC DOMAIN

### OUTSTANDING IBM SOFTWARE

ONLY \$2.75/DISK OR LESS

Our collection contains the latest versions of the Best Shareware and Public Domain Programs. Most are menu driven with full documentation. 350" format is also available. Orders shipped First Class Within 24 hours and Satisfaction is guaranteed. Write for free printed catalogue or send a 25c stamp for a disk catalogue.

**A.C.L. (916) 973-1850**

1821 Fulton Ave., Suite #36-B, Sacramento, CA 95825

Inquiry 661.

### \$3.00 SOFTWARE FOR IBM PC

Hundreds to choose from, wordprocessors, databases, spreadsheets, games, lotto, communications, business, music, bible, art, education, language and useful utilities for making your computer easier to learn. Most programs have documentation on the disk.

WRITE FOR YOUR FREE CATALOG TODAY!

#### BEST BITS & BYTES

P.O. Box 8245, Dept. B, Van Nuys, CA 91409

In CA: (818) 781-9975 800-245-BYTE

Inquiry 662.

### FREE CATALOGUE

#### PUBLIC DOMAIN/SHAREWARE

• 400 IBM PC & compatibles disks •

• 200 Amiga disks • 125 Atari ST disks

PC disks as low as \$1.25 each. Amiga & ST as low as \$1.80 each! Rent or buy. Free shipping! Call toll free, write or circle reader service for FREE BIG CATALOGUE with full descriptions. Please specify computer—48 hr. turnaround!

#### Computer Solutions

P.O. Box 354—Dept. B, Mason, Michigan 48854  
1-800-674-9375 (M-F 10-6 EST) 1-617-628-2943

Inquiry 663.

### RENT SOFTWARE \$1/DISK

Rent Public Domain and User Supported Software for \$1 per diskfull or we'll copy. IBM (3 1/2" also), Apple, C-64, Sanyo 550 and Mac. Sampler \$3. VISA/MC. 24 hr. infolorder line. (619) 941-3244 or send #10 SASE (specify computer) Money Back Guarantee!

#### FutureSystems

Box 3040 (T), Vista, CA 92083  
office: 10-6 PST Mon-Sat. (619) 941-6761

Inquiry 664.

### QUALITY SOFTWARE IBM/COMPATIBLES

Get a Word Processor, Spreadsheet, Database, Money Manager and 5 arcade games plus our 10,000 program catalog for ONLY \$10.00 (+s/h)

800-992-1992 (National)

800-992-1993 (Ca only)

619-942-9998 (Foreign)

VISA, MC, AMEX Accepted. (COD + 1.90)

#### The International Software Library

511-104 Encinitas Blvd., Encinitas, CA 92024

Inquiry 665.

### FREE SOFTWARE

Buy or Rent \$1/disk

World's largest Free Software Library of IBM PC & Compatibles and Macintosh. Over 3000 programs for Religion, Utilities, Business, Com., Word Processor, Education, and Games on 5.4" and 3.5" format. Best quality, Lowest rate, and Fastest service. For fast free catalogue write to:

#### SOFTSHOPPE

P.O. Box 15022, Ann Arbor, MI 48106  
(313) 763-6721

Inquiry 666.

## PUBLIC DOMAIN

### \$4.00 SHAREWARE \$4.00

IBM-PC Compatible Software

- Over 700 Disks to Choose From
- Not Half Full Like Some Distributors
- Dozens of Programs in All Categories

Call or Write for FREE Catalog on Disk

— Please specify 5 1/4" or 3 1/2" Disk —

#### The Software Kingdom

P.O. Box 555, Auburn, NH 03032-0555  
1-800-663-DISK (In N.H.) (603) 483-8085

Inquiry 667.

## SCANNING SERVICES

### Signature Scanning Service

If you have a HP LaserJet Plus, Series II or compatible, have your signature made into a graphic file. Ultra Fast, Super, and DES encryption methods. Operate from menu or command line. Help. Quick tutorial in 100 page manual. \$10 Demo. \$49 introductory price. Satisfaction Guaranteed or your money back.

#### Orbit Enterprises, Inc.

P.O. Box 2575-BY, Glen Ellyn, IL 60137  
(312) 468-3406

Inquiry 668.

## SECURITY

### TOTAL PRIVACY \$49

Powerful data protection for PC/AT—documents, databases, spreadsheets—any kind of data file. Ultra Fast, Super, and DES encryption methods. Operate from menu or command line. Help. Quick tutorial in 100 page manual. \$10 Demo. \$49 introductory price. Satisfaction Guaranteed or your money back.

#### DIARY 1-800-87-DIARY Visa/MC/COD

P.O. Box 70443, Bellevue, WA 98007

FREE copy for cracking our code (No one has)

Inquiry 669.

### BIT-LOCK® SECURITY

Piracy SURVIVAL 5 YEARS proves effectiveness of powerful multilayered security. Rapid decryption algorithms. Reliable/small port transparent security device. PARALLEL or SERIAL port. Countdown and timeout options also available. KEY-LOCK™ security at about 1/2 BIT-LOCK cost.

#### MICROCOMPUTER APPLICATIONS

7805 S. Windermere Circle, Littleton, CO 80120  
(303) 922-4410 or 798-7883

Inquiry 670.

## SMALL BUSINESS SYSTEMS

### SMALL BUSINESS SYSTEMS

Finally, a complete computer system classroom designed and field tested with the Small Business Owner in mind. Business capital of America we proudly present "The YE 51 Collaborative (Your Business System) Several modules written by New England's Ross Beard II. If you are starting a new business or have been in business for less than two years, and can work with professional trainers via telephone than the YE 51 curriculum is for you. Choose from our "Starting a New Venture", "The Home Based Business" or "Women in Business" each built around NBS Hardware and our unique accounting software that we help you customize. Ask yourself if your business deserves the best then say "YES!" Write or call now for our free brochure.

#### ALTERNATIVE BUSINESS TRAINING, INC.

208 Washington Street, Keene, NH 03431  
1-800-328-7677 (In NH 367-6111)

Inquiry 671.

## SOFTWARE/ACCOUNTING

### ACCOUNTING TUTOR \$79.95

Peanuts and Caviar Accounting Software is designed to introduce the principles of accounting and bookkeeping to non-accountants through its software and textbook. It then may be used as your business' accounting software. Being used by educational institutions to teach accounting (e.g., Pepperdine, etc.) \$79.00

#### COUNTERTRADE PRODUCTS, INC.

5145 Ivywild Tr., Boulder, CO 80501  
303-530-5433

Inquiry 672.



# THE BUYER'S MART

## SOFTWARE/A/I

### dBASE BUSINESS TOOLS

- \* General Ledger
- \* Accounts Recvbl.
- \* Order Entry
- \* Sales Analysis
- \* Purch Ord/Invntory
- \* Accounts Payable
- \* Job Costing
- \* Job Estimating

\$99 EA. → s&h w/dBASE 2, 3 or 3+ SOURCE CODE

**dATAMAR SYSTEMS** Gr. Crd/Chk/COO  
4878-B Santa Monica Ave.  
San Diego, CA 92107 (619) 223-3344

Inquiry 673.

## SOFTWARE/BASIC TOOLS

### QuickWindows

As seen in the Microsoft Value-Pack Catalog! Create windows, pop-up and pull-down menus, data-entry screens, and multiple-input dialog boxes quickly and easily. Full support of Microsoft mouse. Join the many Fortune 500 companies using QuickWindows and order your copy today. QuickWindows \$79. Advanced \$139. For Microsoft QuickBASIC or BASCOM. See pg.78, BYTE, March '88.

#### Software Interphase, Inc.

5 Bradley St., Suite 106 • Providence, RI 02908  
(401) 274-5485 Call now for Free Demo Disk

Inquiry 674.

## SOFTWARE/BUSINESS

### DATA ENTRY SYSTEM

Head-down data entry with two-pass verification for the PC/XT/AT - PS/2 & compatibles. Loaded with features like: Auto dup & skip, verify bypass, range checks, & table lookups. Fully menu driven only \$395  
Call for free 30 day trial period.

#### COMPUTER KEYS

21929 Makah Rd., Woodway, WA 98020  
(206) 776-6443 1-800-356-0203

### LP88-SPREADSHEET LP

Our best-selling menu-driven linear programming system now solves problems with 1000 constraints and 5000 variables up to 30 times faster. New version reactivates Lotus worksheets. Use 1-2-3/Symphony as a matrix generator or post processor. Many other features including interactive and batch operation, spreadsheet-style display, equation processor, problem/basis storage, file I/O, Simplex restart, report generator, sensitivity analysis. *ENews* says: "The flexibility and features of this program are a bargain at its low price." \$149 with 8087 support and 100 page manual. \$29 for working demo and manual.

**EASTERN SOFTWARE PRODUCTS, INC.**  
P.O. Box 15228, Alexandria, VA 22309 (703) 360-7660

Inquiry 676.

### dFELLER Inventory

Business inventory programs written in modifiable dBASE source code.

dFELLER Inventory \$199.00

Requires dBASE II or III, PC-DOS/CPM

dFELLER Plus \$299.00

with History and Purchase Orders

Requires dBASE III or dBASE III Plus (For Stockrooms)

#### Feller Associates

550 CR PPA, Route 3, Ishpeming, MI 49849

(906) 486-6024

Inquiry 677

## BUSINESS ENGLISH FINANCES

Maintain PAYABLES, VENDORS, EXPENSE CATEGORIES, ASSETS, LIAB. Dictionary-driven English user interface to generate, query, update payables and do financial calculations. Run expense summary reports. LOAD SAVE EDIT English command text. On-screen calculator. Color screens/windows; Payables ASCII export; Fast! Easy! IBM & compat. min. 512K RAM, 1.2M or HD 888.

#### Gemma Software Components

597 Orchard Plaza, Uniondale, NY 11553  
(516) 483-2513

Inquiry 678.

## SOFTWARE/BUSINESS

### FINANCE MANAGER II

Easy to learn, fully integrated, menu-driven book-keeping system for small business and personal use. IBM PC, XT, AT, PS/2 or compatible. Try before you buy! General Ledger evaluation copy for only \$10!

**CALL TODAY!** (719) 528-8989  
HOOPER INTERNATIONAL: PO Box 62218,  
Colorado Springs, Colorado 80962

Inquiry 679.

### 1-2-3® + @RISK = Risk Analysis

Manage risk with @RISK 1-2-3 Add-In! An @RISK simulation automatically reflects thousands of "what-if" scenarios. View full range of possible outcomes. Monte Carlo simulation. Graphs in PIC format. 30 new probability distribution @functions Now required for all Harvard MBAs

FREE DEMO

#### Palladeo Corporation

2189 Elmira Road, Newfield, NY 14867

(607) 564-9993

Inquiry 680.

## SOFTWARE/CHURCH

### PowerChurch Plus®

Fast, friendly, reliable church administration system. Full fund accounting, mailing lists, membership, contributions, attendance, word processing, accts payable, payroll, multi-user support, and much more - all for \$695 complete. FREE demo version.

#### F1 SOFTWARE

P.O. Box 3096, Beverly Hills, CA 90212

(213) 854-0865

Inquiry 681.

### ROMAR CHURCH SYSTEMS™

Membership-61 fields plus alternate addresses, labels, letters, reports any field(s). Offering-256 funds; optional pledge; statements; post to 255x1yr. Finance-gen. ledger w/budget, up to 500 subtotals & 99 depts., month & YTD reports anytime for any month. Attendance-8 service times, 250 events per service. 60 consecutive weeks. Available for floppy, 3 1/2 & hard disk. Ad too short! Write for free 48-page guide.

#### Romar Church Systems, Attn: BJB

P.O. Box 4211, Elkhart, IN 46514

(219) 262-2188

Inquiry 682.

## SOFTWARE/ENGINEERING

### PRACTICAL ENGINEERING TOOLS

#### Hobbyists—Students—Engineers

CIRCUIT DESIGN...CompDes, menu selections from basic electricity to circuit designs.

MATHEMATICS...CompMath, menu selections from general math to statistics, DIGITAL SIGNAL ANALYSIS...CompDsig, Fourier analysis of waveforms and filters. PC/MSDOS. \$49 each. VISA/MC

#### BSOFT SOFTWARE (614) 491-0832

444 Colton Rd., Columbus, OH 43207

Inquiry 683.

### Affordable Engineering Software

#### FREE APPLICATION GUIDE & CATALOG

Circuit Analysis • Root Locus • Thermal Analysis • Plotter Drivers • Engineering Graphics • Signal Processing • Active/Passive Filter Design • Transfer Function/FFT Analysis • Logic Simulation • Microstrip Design • PC/MSDOS • Macintosh • VISA/MC

#### BV Engineering • Professional Software

2023 Chicago Ave., Suite B-13, Riverside, CA 92507

(714) 781-0252

Inquiry 684.

## SOFTWARE/ENGINEERING

### VERSATILE DSP & DISPLAY

PC DATA MASTER is a DOS shell which integrates a full set of signal processing functions: flexible graphics, data file math, DSP utilities, data sampling/generation, and interactive help. Support for CGA, EGA, VGA, Herc & AT&T. Add custom analysis or graphics functions easily using your favorite compiler. \$135. Toolkit \$46. Demo \$10.

#### Durham Technical Images

P.O. Box 72, Durham, New Hampshire 03824-0072

(603) 868-5774

Inquiry 685.

### Engineer's Aide

Join the Desktop Engineering Revolution!

- Pipeline/Ductwork Sizing
- Pump/Fan/Comp. Sizing
- Heat Exchanger Sizing
- Fluid Properties Library
- Orifice/Control Valve Sizing
- Project Financial Analysis
- Conversion Calculator
- Specification Writer

Above programs in one stand alone integrated package for \$695. For IBM PC & Macintosh.

#### EPCON

1-800-367-3585 (24 hr) 1-805-484-5381 (Ca)

Inquiry 686.

### STRUCTURAL ANALYSIS

MICROSAFE: Inexpensive, easy to learn and use Finite Element Analysis for IBM PCs and compatibles. Up to 400 nodes, 600 beams, 500 plates. Graphics. 2-D: \$75, 3-D: \$120, Both: \$160. Overseas add \$20. Evaluation copies. NOT COPY-PROTECTED. Ask for brochure.

#### MICROSTRESS Corp. (Dep. BM1)

10950 Forest Ave. S., Seattle, WA 98178-3205

(206) 772-0508

Inquiry 687.

### SIMULATION WITH GPSS/PC™

GPSS/PC™ is an IBM personal computer implementation of the popular mainframe simulation language GPSS. Graphics, animation and an extremely interactive environment allow a totally new view of your simulations. Simulate complex real-world systems with the most interactive and visual yet economical simulation software.

#### MINUTEMAN Software

PO Box 17177, Stow, Massachusetts, U.S.A.

(617) 897-5662 ext. 540 (800) 223-1430 ext. 540

Inquiry 688.

### Circuit Analysis — SPICE

Non-linear DC & Transient; Linear AC.

- Version 3B1 with BSIM, GaAs, JFET, MOSFET, BJT, diode, etc. models, screen graphics, improved speed and convergence.
- PC Version 208 available at \$95.

Call, write, or check inquiry # for more info.

#### Northern Valley Software

26327 Rothrock Dr., Rancho Palos Verdes, CA 90274

(213) 541-3677

Inquiry 689.

### FREE ENGINEERING MAGAZINE

Personal Engineering is a monthly magazine sent free of charge (USA only) to scientists/engineers who use PCs for technical applications. Topics each month include instrumentation • Data Acq/Control • Design Automation. To receive a free sample issue and qualification form either circle below or send request on letterhead to:

#### Personal Engineering Communications

Box 1821, Brookline, MA 02146

Inquiry 690.



# THE BUYER'S MART

## SOFTWARE/ENGINEERING

### EC-Ace ANALOG CIRCUIT ANALYSIS

You can afford to get started with EC-Ace, a subset of the powerful ECA-2 circuit simulator. Includes all the basics and built-in graphics.

- AC, DC, Temperature, Transient
- A full 525 pg. ECA-2 manual
- Interactive, twice as fast as SPICE.

**EC-Ace 2.31 IBM PC or Mac \$145.**

Call 313-663-8810 for FREE DEMO

**Tatum Labs, Inc.**

1478 Mark Twain Ct., Ann Arbor, MI 48103

Inquiry 691.

## SOFTWARE/FINANCIAL

### "THE FINANCIAL PLANNER" SOFTWARE

SAVE 40% Retail \$99.95 - OUR PRICE \$59.95 (+ 2.00 SH) PA residents add 6% S. Menu Driven program w/printed Manual

- Balance Checkbook
- Loan Amortization Schedule
- Prepare Budgets
- Manage Investments
- Prepare Financial Statements
- Plan Savings & more

Specify Apple IIc, Iie, Iigs, IBM PC or Compatible  
DISK/CD-ROM SHIPPED UPS

**SOFTTECH INDUSTRIES, INC. 717-584-8191**

RD 1, Box 117A, Dept B901, Hughesville, PA 17337

Inquiry 692.

## SOFTWARE/FORECAST

### FORECAST PRO

An excellent forecasting package that uses artificial intelligence to help both the beginner and the experienced forecaster achieve top-notch results. Time series analysis techniques include exponential smoothing, Box-Jenkins, & dynamic regression.

**CALL NOW FOR A FREE DEMO DISK!**

**Business Forecast Systems, Inc.**

68 Leonard Street, Belmont, MA 02178  
(617) 484-5050 TELEX #710-3201382

Inquiry 735.

## SOFTWARE/GEOLOGICAL

### GEOLOGICAL CATALOG

Geological software for log plotting, gridding/contouring, hydrology, digitizing, 3-D solid modelling, synthetic seismogram, fracture analysis, image processing, scout ticket manager, over 50 programs in catalog. Macintosh too! Please call, or write, for Free Catalog!

**RockWare, Inc.**

4261 Kipling St., Suite 585, Wheat Ridge, CO 80033 USA  
(303) 423-5645

## SOFTWARE/GRAPHICS

### PC TECHNICAL GRAPHICS

TEKMAR is a graphics library for the EGA or Tecmar Graphics Master. Similar to PLOT-10, includes WINDOW, VIEWPORT, AXIS. Support for HP, Hi plotters. Curve fitting, complete plotting program. Log, semi-log, multi-axis, 3-D, contours. Jerry Pournelle (Aug 86 Byte): "As good as any I have ever seen..." Demo disks, literature available.

**Advanced Systems Consultants**

21115 Devonshire St. #328, Chatsworth, CA 91311  
(818) 407-1059

Inquiry 693.

## SEGS

SCIENTIFIC & ENGINEERING GRAPHICS SYSTEM

See "What's New" pg 82, BYTE June, 1988 Log, Data & Linear Axes; Curve Fitting & Smoothing 1-3-3 interface; Numeric Spreadsheet, Supports all Video Standards, PC Printers & Plotters, 10 Curves w/6000 points each. Plus much more. Call Today.

**Edmond Software**

3817 Window Drive 1-405-842-0058  
Edmond, Oklahoma 73013 1-800-992-3425

Inquiry 694.

## SOFTWARE/GRAPHICS

### FPLOTT PEN PLOTTER EMULATOR

Use your dot matrix or laser printer as an HP pen plotter. Fast hi-res output. Vary line width. Includes VPLOTT virtual plotter utility to capture plotting commands. Supports NEC P6/16, IBM Proprinter, Epson LQ/MX/FX, HP Laserjet. Uses Hercules, CGA, EGA or VGA for screen preview. \$84 check or m.o.

### FPLOTT CORPORATION

Suite 605, 24-16 Steinway St., Astoria, NY 11103

212-418-8469

Inquiry 695.

### GRAPHICS PRINTER SUPPORT

AT LAST! Use the PrtSc key to make quality scaled B&W or color reproductions of your display on any dot matrix, inkjet, or laser printer. GRAFPLUS supports all versions of PC or MS-DOS with IBM (incl. EGA, VGA), Tecmar, and Hercules graphics boards. \$49.95.

**Jewell Technologies, Inc.**

4740 44th Ave. SW, Seattle, WA 98118

800-628-2828 x 527 (206) 937-1081

Inquiry 696.

### FORTRAN PROGRAMMER?

Now you can call 2-D and 3-D graphics routines within your FORTRAN program.

GRAF/MATIC: screen routines \$135  
PLOT/MATIC: plotter driver 135  
PRINT/MATIC: printer driver 135

For the IBM PC, XT, AT & compatibles. We support a variety of compilers, graphics bds., plotters and printers.

### MICROCOMPATIBLES

301 Pretude Dr., Dept. B, Silver Spring, MD 20901 USA  
(301) 593-0683

Inquiry 697.

## SOFTWARE/INVESTMENT

The new Business Week TOP 1000 and Mutual Fund Scoreboard Databases use the enormous power of your IBM or compatible PC to select, rate, and compare every equity and fixed income mutual fund on the market (Mutual Fund Scoreboard), and virtually every Business Week 1000 company (TOP 1000)—at the touch of a key.

**Mutual Fund Scoreboard Databases:**

\$48.95 each or \$238.90 for subscriptions to both.

TOP 1000 & TOP 500 ELITE Databases:

\$199 for the TOP 1000 & \$299 for the ELITE version which offers names & addresses of the top officers too!

Order now or receive more information by calling 1-800-453-3575 (in Illinois, call 1-312-250-8292)

Or write to: **Business Week Databases**  
P.O. Box 621, Elk Grove, IL 60009

Inquiry 698.

## SOFTWARE/LANGUAGES

### FORTRAN for Macintosh

Language Systems FORTRAN is a full-featured FORTRAN 77 compiler integrated w/MPW. Full ANSI FORTRAN 77 plus VAX-type extensions. SANE numerical calculations & data types incl. COMPLEX\*16, 88000, 68020 and 68881 object code. Arrays greater than 32K. Link with Pascal, C, MacApp, \$304 w/MPW via air. MC/VIS/Check, MAC+, SE, Mac II, HD req.

**Language Systems Corp.**

441 Carlisle Drive, Herndon, VA 22070

(703) 478-0181

Inquiry 699.

### The SPINDRIFT Library

At last! Now there's a way for FORTRAN programmers to do the things they always wanted to do: Execute other programs via CALL EXEC, edit key control of CURSOR; WINDOWS, POP UP HELP; Wildcard file search; Save/restore screen images; COLOR, 150 subroutines and functions in all. Price: \$148. + \$8H Write for DEMO DISK: \$5 credited to purchase. Specify your Compiler.

**Spindrift Laboratories, Ltd.**

116 S. Harvard Ave., Arlington Hts., IL 60005

(312) 255-8909

Inquiry 700.

## SOFTWARE/LOG

### PC USAGE LOG

The DEDUCT PC business usage, the IRS requires an auditable log and reason log. To analyze HOW time is spent on PC projects, one needs to KNOW what was done, date, start and ending times. PC USAGE LOG will automatically keep track of all this information. Saved records can then be edited, sorted, and displayed or printed to give summary or detail reports. IBM compatible PC, MS-DOS 2.0 & up, 256K memory, (80x25) monitor. Price \$24.95. Visa/MC/AmExp are OK.

**Discovery Software Corporation**

Post Office Box 17903, Salt Lake City, Utah 84117

1-801-272-3033 Orders & Technical Information

Inquiry 734.

## SOFTWARE/PACKAGING

### HARD TO FIND COMPUTER SUPPLIES FOR SOFTWARE DEVELOPERS & POWER USERS

Cloth binders & slipcases like IBM's Vinyl binders, boxes, and folders in many sizes. Disk pages, envelopes, & labels. Low quantity imprinting. Bulk disks. Everything you need to bring your software to market. Disk and binder mailers. Much more! Low Price! Fast service. Call or write for a FREE CATALOG.

**Anthropomorphic Systems, Limited**

378 E. St. Charles Rd., Lombard, IL 60148

1-800-DEAL-NOW 312-629-6180

Inquiry 701.

### SAVE SAVE SAVE SAVE LET'S TALK LABELS

We do disk labels (5 1/4" & 3 1/4")

• Better • Faster • Cheaper •

Because we specialize in disk labels... Let's Talk

We also have Tyvek Sleeves

Mailers • Binders • Vinyl Pages

We are a complete software packaging service.

**Hice & Associates**

6003 Cincinnati-Columbus Rd., West Chester, OH 45088

613-777-0133

Inquiry 702.

## SOFTWARE/SALES & MKTG

### HIGH SALES VOLUME

Requires a thorough, fast and friendly lead tracking system. CONTACT PLUS manages your sales contacts through simple tickler dates, autodialer, phone call history and graph, date stamped notes, mail/merge with history, call analysis reports, and tickler calendars. ASCII import/export. (\$79.95 plus \$5.00 S&H). Demo disk \$3. IBM PC and compatibles. VIS/AM/CCDD.

**E. Trujillo Software**

P.O. Box 23063 Albuquerque, NM 87192-1062

Orders only: 800-628-2828 ext 561 (505) 887-3223

Inquiry 703.

## SOFTWARE/SCANNERS

### Optical Character Recognition

Stop retyping: PC-OCR™ software will convert typed or printed pages into editable text files for your word processor. Works with HP ScanJet, Canon and most other scanners. Supplied with 15 popular fonts. User trainable: you can teach PC-OCR™ to read virtually any typestyle, incl. foreign fonts. Proportional text, matrix printer output. Xerox copies OK. \$385. Check/VISA/MC/AmExp/CCD.

**Essex Publishing Co.**

P.O. Box 391, Cedar Grove, NJ 07009

(201) 783-6940

Inquiry 704.

## SOFTWARE/SCIENTIFIC

### DATA ACQUISITION & ANALYSIS ON PC'S

• Free application assistance. Tell us about your DSP process control, A/D or DA needs. Our expert engineering staff will provide you with a system solution to fit your needs and budget.

• A/D & IEEE 488 boards from Metrabyte, Scientific Solutions and Analog Devices.

• Analysis software including F788 FACTOR FFT subroutines library, FOURIER PERSPECTIVE & advanced linear systems analysis.

• Menu driven software from Unix, Laboratory Technologies, Curran-Curtis, and Golden. Scientific Engineering 2 & 3D graphics.

See "What's New" page 83, BYTE July, 1988

**LOW PRICES—Satisfaction GUARANTEED**

**ALLIGATOR TECHNOLOGIES**

P.O. Box 6708, Fountain Valley, CA 92708

Tel. (714) 850-8884 FAX (714) 850-8887 MCI ALLIGATOR

Inquiry 705.



# THE BUYER'S MART

## SOFTWARE/SCIENTIFIC

### Spectra Calc Data Processing

Acquire and analyze data from commercial or custom analytical instrumentation. Fast real-time display, WYSIWYG plotting. Extremely fast applications for curve fitting, deconvolution, PLS algorithms etc. Spectral search and archive. Array programming language includes matrix, FFT, graphic commands.

#### GIC

395 Main St., Salem, NH 03079  
800-862-6004 603-898-7800 FAX 603-898-8228

Inquiry 706.

### Do You Need to do This on Your PC?

614 1/8	cu in
1.2	liter per sec
= 8.398421	sec

Lascaux1000, "The Intelligent Calculator". (For IBM PC's) Verify logic of calculations. Reduce steps by 50%. Extensive table of physical constants. Easily customized. Much more! \$59.95 Demo disk \$1.

Lascaux Graphics 3220 Steuben Ave.  
Bronx, NY 10467 (212) 654-7429

Inquiry 707.

### ORDINARY/PARTIAL DIFFERENTIAL EQN SOLVER

FOR THE IBM PC & COMPATIBLES

**MICROCOMPATIBLES INC.**  
301 Prelude Dr., Silver Spring, MD 20901  
(301) 593-0683

Inquiry 708.

### "powerful and easy to use..."

Ask for our free 16 page brochure with complete product descriptions and detailed technical application notes (and for a brief description of two of our products see "What's New", Byes, page 84, July/88).

**MicroMath Scientific Software**  
2034 East 7000 South  
Salt Lake City, Utah 84121-3144  
(801) 943-0290

Inquiry 709.

### Scientific/Engineering/Graphics Libraries Turbo & Lightspeed Pascal, Modula-2, C

Send for FREE catalogue of software tools for Scientists and Engineers. Includes: Scientific subroutine libraries, device independent graphics libraries (including EGA, HP plotter and Laserjet support), scientific charting libraries, 3-D plotting library, data acquisition libraries, menu-driven process control software. Versions available for a variety of popular languages.

#### Quinn-Curtis

1181 Chestnut St., Unit 2-5, Newton, MA 02464

Inquiry 710.

### SCREEN MANAGER

MENU, WINDOW, and DATA ENTRY Support for the Professional Programmer! Interfaces to most languages. BASIC, C, FORTRAN, COBOL, PASCAL, ASSEMBLER. 100 Page Manual. Thirty day money back guarantee. No Royalties.

from \$79. Visa/MC

#### The West Chester Group

P.O. Box 1304, West Chester, PA 19380

(215) 844-4208

CALL FOR FREE DEMO

Inquiry 711.

## SOFTWARE/SECURITY

### KEEP YOUR PC PRIVATE!

MicroLock PC Security Software protects MS-DOS files and programs from unauthorized access. MicroLock features unlimited passwords, Quick Encryption, Locks Directories, Hides files, Locks .EXE and .COM files, uses one simple control menu w/on-screen help!

Only \$89.95! (+\$3 s/h) 30 DAY MONEY BACK GUARANTEE  
Check/Visa/MC

#### MicroNiche, Inc.

The Summit, Suite 110, 4350 Brownsboro Rd.  
Louisville, KY 40207  
Orders: (502) 893-4326 FAX: (502) 893-4503

Inquiry 634.

## SOFTWARE/SORT

### OPT-TECH SORT/MERGE

Extremely fast Sort/Merge/Select utility. Run as an MS-DOS command or CALL as a subroutine. Supports most languages and filetypes including Bitwise and dBASE. Unlimited filesize, multiple keys and much more! MS-DOS \$149, XENIX \$249.

(702) 588-3737

#### Opt-Tech Data Processing

P.O. Box 678 - Zephyr Cove, NV 89448

Inquiry 712.

## SOFTWARE/TAX PREP

### W-2 & 1099 ON FLOPPY

The MAG COLLECTION of programs make an IBM/MSA FORMAT floppy from a data entry screen or imported ASCII file. Includes manual and application forms.

- Used nation wide
- Step-by-step data entry
- Free phone support
- Menus, user friendly
- Prints W-2 & 1099
- PC compatible

#### Illinois Business Machines Inc.

Department MAG  
1403 Box 310 Troy Rd., Edwardsville, IL 62025  
PH. # (618) 682-6000

Inquiry 713.

## SOFTWARE/TOOLS

### NATURAL LANGUAGE SOFTWARE

Use JAKE to create a front end to your database, game, or graphics program! JAKE translates English queries and commands into C function calls and data structures. JAKE offers context-sensitive semantic processing. Interfaces easily. < 64K mem.

\$495. INTERACTIVE DEMO \$10

#### ENGLISH KNOWLEDGE SYSTEMS, INC.

5525 Scotts Valley Dr. #22, Scotts Valley, CA 95066  
(408) 438-6922

Inquiry 714.

## STATISTICS

### STATA

Statistics and graphics join to make STATA the most powerful package for the PC. No comparable program is as fast, friendly, and accurate. \$20 Demo. Quantity discount available. Call toll-free for more information. AX/VISA/MC.

#### 1-800-STATAPC

#### Computing Resource Center

10901 National Boulevard, Los Angeles, CA 90064  
(213) 470-4341

Inquiry 720.

### THE SURVEY SYSTEM

An easy-to-use package designed specifically for questionnaire data. Produces banner format, cross tabs & related tables, statistics (incl. regression) & bar charts. Codes and reports answers to open-end questions. All reports are camera-ready for professional presentations. CRT interviewing option.

#### CREATIVE RESEARCH SYSTEMS

15 Lone Oak Cir., Dept. B, Petaluma, CA 94952  
707-765-1001

Inquiry 715.

## STATISTICS

### RESULTS NOT SIGNIFICANT?

Need time use EX-SAMPLE. Expert program estimates sample size using power analysis for comparisons of means, props, regression, ANOVA, chi-square, log-linear, LISREL, surveys, experiments, many more. Justly sample size to funding agencies, plan sampling budget. Can pay for itself in a single study. IBM/MS-DOS, \$195 + s/h. (50% educ. disc.) VISA/MC/AMEX/PO. 30-day guarantee. Call now for FREE brochure.

#### The Idea Works, Inc.

100 West Briarwood, Columbia, MO 65203  
1-800-637-4888 314-445-6824

Inquiry 716.

### STATISTIX™ II

Comprehensive, powerful and incredibly easy-to-use. Full screen editor, transformations, linear models (ANOVA, regression, logit, PCA, etc), ARIMA, most standard stat procedures. Clear, well organized documentation. Satisfaction guaranteed. \$169 PC DOS, \$99 Apple II.

#### NH ANALYTICAL SOFTWARE

PC Box 13204, Roseville, MA 55113  
(612) 831-2852

Inquiry 717.

### NCSS

Professional, easy to use, menu driven statistical system. Used by over 5,000 researchers.

- 5.0 Statistical System—\$99
- 5.1 Graphics (2D & 3D)—\$59
- 5.3 Power Pac Supplement—\$49
- 5.4 Exp. Design/OC—\$49
- 5.5 Survival Analysis—\$49

We accept checks, PC's, Visa, MC. Add \$3 s/h.

#### NCSS-B

665 East 400 North, Keyhole, UT 84037  
801-548-0445

Inquiry 718.

### EcStatic \$49.95

A full featured statistical package that's powerful, convenient, astonishingly easy to use and extraordinarily inexpensive. At least! A statistical package that gives you the tools you need, the clarity you want and at a price you can afford. Ideal for researchers, professionals, and students. Volume discounts available. To order call or write to:

#### SomeWare In Vermont, Inc.

P.O. Box 215, Montpelier, VT 05602  
1-800-481-4880 (486-3173 in Vermont)

Inquiry 719.

### Spreadsheet Statistics

NEW! 23 comprehensive statistics and forecasting modules for analyzing LOTUS worksheets. Low cost \$24.95 each. Easy to use. Includes tutorial. Basic and advanced statistics with graphics and many user-definable options. Compare. Free brochure.

#### Walonick Associates, Inc.

6500 Nicollet Ave. S., Minneapolis, MN 55423  
(612) 866-9022

Inquiry 721.

## TEXT RETRIEVAL

### TEXT RETRIEVAL

QICet, high speed text retrieval software for IBM PC compatible and Apple Macintosh computers. Highly acclaimed.

- No file conversion or indexing required.
- Searched for text in any file (ASCII, EBCDIC, WordStar, etc.)
- RAM resident operation for immediate availability, also runs as a standard DOS application—Needs Accessory on the Macintosh.
- Moves text across different file formats (DisplayWrite to WordStar, MS Word to WordPerfect, etc.)

ONLY \$79.95! Call or write to order: (VISA, MC, COB, Check)

#### Microlytics

300 Main St., Suite 1591, East Rochester, NY 14448  
(800) 828-6283 (716) 377-0136 in NY

Inquiry 722.







# Compu\$ave



Call: 1-800-624-8949 or 1-800-877-8855

## BOARDS

Above Board 286	325	NEC MVA 1024	789
Adv. Dig. Slave	545	Orchid Designer	329
AST 4 Port	299	Paradise 480 Auto.	145
AST 5251-11E	545	Paradise VGA+	238
ATI VGA Wonder	SAVE	Paradise VGA Pro.	352
ATI EGA Wonder	172	STB VGA EM	299
BOCA RAM AT	142	Sigma VGA H	252
Genoa EGA HiRes+	199	Video 7 V RAM	489
Genoa VGA HiRes	429	Video 7 Vega VGA	252
Hercules VGA	242	W. Digit. 1003 WAH	99
Artist/Computone/Intel/Methodus/Number 9	CALL		
Quadram/Talrew/Tsang Labs/Vericom/VMI	CALL		

## DISK DRIVES

MAC Hard Drives	Call	Seagate 20M Kit	262
Minscribe 40M	312	Seagate 30M Kit	279
Minscribe 6053	509	Seagate 251	369
Minscribe 6085	695	Seagate ST251-1	429
PlusCard 20M	518	Seagate 4086	625
PlusCard 40M	655	Toshiba 3.5" Kit	89
AST/Archive/Alloy/CDC/Genoa/Iomega	CALL		
Micropolis/Maynard/Mantor/Talgrass/Tecmar	CALL		

## SOFTWARE

Carbon Copy+ 5.0	108	Microsoft Works	123
CDbase III Plus	374	Microsoft Word 4.0	209
Fastback Plus	92	Multimate Advan. II	249
First Publisher 2.0	75	Top (PC or MAC)	Call
Harvard Graph 2.1	275	WordPerfect 5.0	230
MACDraw	129	Ventura Publisher	495
Microsoft Excel	PC295	Paradox 2.0	429

## COMPUTERS

AST Model 286	CALL	Toshiba 1000	739
AST Model 386	CALL	Toshiba T1200F	1595
Intel 25 MHz	CALL	Toshiba T1200H	2265
Mitsubishi 286/110	1039	Toshiba 3100/20	2995
NEC Laptops	SAVE	Toshiba 3200	3685
Samsung Laptops	SAVE	Toshiba 5100	4745
Sharp PC-7000A	1185	Zenith 183	1949
Sharp 4521	1975	Zenith Supersport	1625
Sharp PC-7100	1745	Zenith Supersport 286	3395
Acer 80386-16 MHz/0 Wait/1 Mag Ram	2745		
Acer 80386-20 MHz/0 Wait	CALL		
NEC Powermate Portable 286/640k/20M	2645		
NEC Powermate Portable 286/640k/40M	3085		
Sperry PC IT 512k/44M HD/Keyboard	2795		
Samsung S500 AT: 10MHz/40M Drive	1585		
Televideo 386: 16 MHz/2m/1.2M Drive	2595		
Wyse 2108: 8 MHz/512k/1.2M Drive	1199		
Wyse 2112: 12.5 MHz/1M/1.2M Drive	1699		
Wyse 2214: 12.5 MHz/0 Wait/0 Wait	1895		
Wyse 386: 16 MHz/1M/1.2M Drive/0 Wait	2795		
Unsysa 386: 16 MHz/1M/1.2M Drive/0 Wait	2599		
Alloy/Apple/Compaq/AT&T/TTL	CALL		

## TERMINALS

Abos V	485	Televideo 985	412
Adds 1010	299	Wyse 30	289
IBM 3151	379	Wyse 50	355
Kemtron KT-70 PC	359	Wyse 80	395
Televideo 905	515	Wyse 85G	379
Unsysa 955	375	Wyse 80GT	409
Visual/CIE/Link/Quem/Falco	CALL		

International orders are welcome.

## PLOTTERS

Calcomp 1023GT	3785	Houston 82	4485
Calcomp 9902	3385	HP 7475	1395
Calcomp 1043GT	6275	HP 7550 A	2895
Enter SP 1800	3085	HP 7595	7595
Houston DMP 52	2795	Iofine 3700	3045
Houston 41742	2095	Iofine 4000	3995
Houston 56A	3795	Roland 980	1195
Houston 61	3295	Roland 880	929
Numerics/Taxan/Versatec/JDL/Other Models	CALL		

## DIGITIZERS

Calcomp 12 x 12	365	Logitech HiRes Mouse	96
Calcomp 44 x 60	3745	Kurta IS 3	CALL
Calcomp 36 x 48	3195	Kurta IS 8.5 x 11	249
GTCD 24 x 36	1945	Kurta IS 12 x 12	315
GTCD 36 x 48	2395	Kurta IS 12 x 17	535
Huachi 11 x 11	439	Summa 12 x 12 +	348
Logitech C7 Mouse	82	Summa 12 x 18	598

## MODEMS

ATI ETC.	159	Novation Parrot	85
Anchor 2400E	145	Practical 1200L	65
AST 9600	279	Prometheus 2400B/2	119
Avatec 1200 Ext.	95	Prometheus 2400G	149
Hayes 1200	279	Racal-Vadic 2400VP	399
Hayes 2400	412	USR Courier 2400	299
Incomm T2400 MWP	235	USR 2400E	345
Megent Pocket	109	USR HST 9600	849
Multitech 224 EH	389	Van-Tel 18000	939
Multitech 224 EC	325	Zoom 2400 HC	139
Avatec/Case/Everex/UDS/Other Models	CALL		

## PRINTERS

Alps Allegro 24	362	NEC 5200	519
Canon BJ 130	295	NEC 5300	689
Citizen 1200	142	NEC P5XL	815
Citizen 1800	158	NEC P8XL	1018
Citizen MSP40	312	Panasonic 1080M2	158
Citizen MSP55	468	Panasonic 1091M2	198
Fujitsu DL3400	512	Panasonic 1524	549
Canon 88	1985	NEC LC 800	3145
Okidata 391	649	Star NX1000	169
NEC P2200	328	Toshiba P351SX	959
HP Laser Jet II	SAVE	Quadram Postscript	2795
Brother/Citoh/Data Products/Data South	CALL		
Diconix/Epson/Genicom/OMS/OTC/TI	CALL		

## MONITORS

Amdek 310A	69	PGS Ultra Synchron	519
Amdek 1280	645	PGS LM 300	539
Intercolor 19"VGA	1595	Talung Multiscan	475
Mitsubishi 1371A	489	Taxan 770+	515
Mitsubishi 20" Auto	1845	Thomson 4180 RGB199	
NEC Multisync II	562	Thomson EGA	299
NEC Multisync +	915	Sigma Laser 19"	1765
NEC Multisync XL	2085	Wyse 700	678
NEC Multisync GS	179	Vericom 2 Page	1765
Magnavox Multi	512	Zenith 1490	598
Seiko 1430: 14", Multiscan, 1024x768, 26mm	649		

## SCANNERS

Datascopy 730	1095	PGS LS-300 w/OCR	965
AST / HP / Taxan / PC Hand Scanner	CALL		

HOURS: MON-FRI 7AM-6PM/SAT 9AM-2PM

ARIZONA SALES: (602)437-4855, CUSTOMER SERVICE (602)437-4856

FAX: (602)437-9685

CompuSave: 4207 S. 37th St. Phoenix AZ 85040. Prices reflect cash discounts and are subject to change without notice. We do not guarantee compatibility. Major credit cards and selected PO's are accepted.

## PACIFIC-286-12

- 80286-12
- 1.2MB Floppy Drive (Option 8125 3 1/4" Drive)
- 640K Ram (Option 886 for 386K Drive)
- Serial/Parallel
- 101-Key Enhanced Key Board
- SI - 12.3 (1 Wait)
- SI - 15.2 (2 Wait \$150 Option)
- 8/12 MHz Key Board Switchable
- WA2 HD & PO Controller



- MONO SYSTEM
  - W/Mono Monitor
  - 20 MB Hard Disk**\$1195**
- CGA COLOR SYSTEM
  - W/CGA Monitor
  - 20 MB Hard Disk**\$1395**
- EGA COLOR SYSTEM
  - W/EGA Card
  - W/EGA Monitor
  - W/20 MB Hard Disk**\$1580**

## LCD-286 PORTABLE

- 10 MHz 80286
- 640K Ram
- SI - 10.3
- Key Board
- LCD Screen
- Super Tuner
- Back Lightng
- Serial/Parallel
- 1.2 MB Floppy Drive
- 80287 Socket
- 200 W Power Supply
- 20 MB Hard Disk
- 23 lbs
- Size 15" x 9" x 8"

\$1595

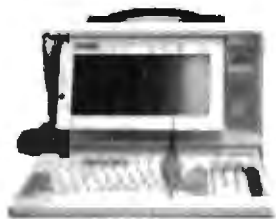

## PACIFIC-386

- 80386-16 (20 MHz)
- SI - 23
- 1 MB Memory
- One 1.2 MB Floppy Drive
- 40 MB (Seagate ST-251)
- 101 Enhanced Key Board
- 200 W Power Supply
- I/O Card Serial/Parallel
- 80387 Socket

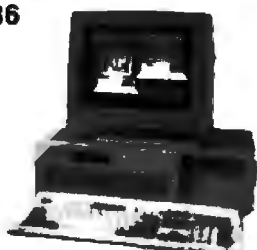

- MONO SYSTEM
  - W/Mono/P Card
  - Mono Monitor**\$2395**
- EGA COLOR SYSTEM
  - W/EGA Card (840x350)
  - EGA Monitor**\$2785**

## CRT-PORTABLE 8088

- Compact Type
- 8088-10 MHz
- 2 Floppy Drive
- 150W Power Supply
- TTL Display 8" Amber
- Key Board

\$770



## CRT-PORTABLE-286

- Compact Type
- 80286 (10 MHz or 12 MHz)
- One 1.2 MB Floppy Drive
- 200 W Power Supply
- TTL Display 8" Amber
- At Key Board
- I/O Card Serial/Parallel
- WA2 HD & PO Controller
- 20 MB Hard Disk

\$1389

PRICE SUBJECT TO CHANGE WITHOUT NOTICE

Dealers are welcome  
Call For Quantity Price

## LCD-386

- 20 MHz SI 23
- 80286-16
- One 1.2 MB Floppy Drive
- 40 MB Hard Disk (ST-251)
- LCD Screen (840x200)
- Key Board
- I/O Serial/Parallel

\$2795

## PACIFIC COMPUTER (818) 571-5548

120 E. Valley Blvd., #H, San Gabriel, CA 91775  
FAX: 818-571-0905

(800) 346-7207 (California)  
(800) 421-1102 (Outside California)

ORDER ONLY







# Worldwide • Since 1974

• QUALITY COMPONENTS • COMPETITIVE PRICING  
• PROMPT DELIVERY

MEMBER  
**MMC**  
MICROCOMPUTER  
MARKETING COUNCIL  
of the Data Marketing Association, Inc.

## JAMECO SOLDERLESS BREADBOARD SOCKETS

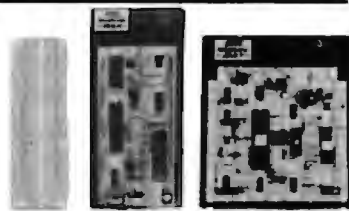

Part No.	Dim. L x W	Contact Points	Binding Posts	Price
JE20	6 1/2 x 3/4	200	0	\$ 2.29
JE21	3 1/2 x 2 1/2	400	0	\$ 4.49
JE22	6 1/2 x 1 1/2	630	0	\$ 5.95
JE23	6 1/2 x 2 1/2	830	0	\$ 7.49
JE24	6 1/2 x 3 1/2	1,380	2	\$14.95
JE25	6 1/2 x 4 1/2	1,660	3	\$22.95
JE26	6 1/2 x 5 1/2	2,390	4	\$27.95
JE27	7 1/2 x 7 1/2	3,220	4	\$37.95

## COMPUTER PERIPHERALS

Jameco  
IBM PC/XT/AT  
Compatible  
Motherboards



• Award BIOS ROMs included

JE1001

JE1001 4.77/6MHz (PC/XT) ... \$ 99.95  
JE1002 4.77/10MHz (PC/XT) ... \$119.95  
JE1007 6/8/10/12MHz (AT) ... \$349.95

Jameco  
Computer  
Power  
Protection



JE1190 Power Base ... \$29.95  
JE1191 6-Outlet Power Strip ... \$11.95

Jameco IBM PC/XT/AT  
Compatible Keyboards

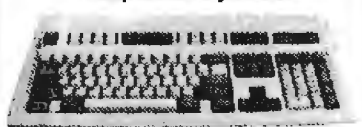

JE1016 Pictured

JE1015 Standard AT layout (XT/AT) ... \$59.95  
JE1016 Enhanced layout (XT/AT) ... \$79.95

Jameco Extended 80-Column  
Card for Apple IIe

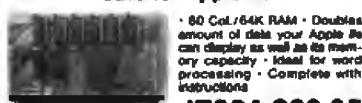

• 80 Col./64K RAM • Doubles amount of data your Apple IIe can display as well as its memory capacity • Ideal for word processing • Complete with instructions

JE864 \$39.95

ADD12 (Disk Drive 4, 8, or 20) \$99.95

## DATA BOOKS

400041 HBC Linear Data Book-Vol. 1 (88) ... \$14.95  
400042 HBC Linear Data Book-Vol. 2 (88) ... \$ 9.95  
400043 HBC Linear Data Book-Vol. 3 (88) ... \$ 9.95  
210830 Intel Memory Handbook (88) ... \$17.95  
230843 Intel Microsystems Handbook, 2nd Ed. (88) ... \$24.95

## IBM AT COMPATIBLE KIT Mini-286 6/8/10/12MHz KIT

Baby AT Motherboard (Zero-K RAM - includes Award BIOS ROMs) ... \$349.95  
JE1015 XT/AT Style Keyboard ... \$ 59.95  
JE1017 Baby AT Flip-Top Case ... \$ 69.95  
JE1022 5 1/4" Hi-Density Disk Drive ... \$109.95  
JE1032 200 Watt Power Supply ... \$ 89.95  
JE1043 360K/720K/1.2M Floppy Controller Card ... \$ 49.95  
JE1065 Input/Output Card ... \$59.95

Regular List \$789.65

SAVE \$99.70!

JE1059 \$519.95 (EGA Monitor and Card not included)

JE2009\* IBM AT Compatible Kit ... \$689.95

JE286M JE2009 Technical Manual ... \$29.95

\*RAM not included - Minimum RAM configuration 512K (18 Chips 41256-120, see left)

## IBM COMPATIBLE DISPLAY MONITORS

12" Amber Monochrome - TTL Input, High Resolution (PC/XT/AT)  
AMBER ... \$99.95

14" RGB Color - CGA Compatible Amber/Green/Color Switchable, 640 x 200 Resolution (PC/XT/AT)  
TTX1410 ... \$279.95



14" EGA Color - EGA/CGA Compat., 720 x 350 Max. Resolution (PC/XT/AT)  
TE154 ... \$399.95

14" EGA Monitor and EGA Card - EGA compatible, 720 x 350 Max. Resolution - displays up to 16 colors (PC/XT/AT)  
JE1059 ... \$519.95

14" Multiscan Color - VGA/PGA/EGA compatible, 800 x 600 Max. Resolution (PC/XT/AT)  
CTX1435 ... \$549.95

## IBM PC/XT/AT COMPATIBLE CARDS

Graphic  
Display  
Cards



JE1050

JE1050 Mono Graphics Card w/Printer Port (PC/XT/AT) ... \$59.95  
JE1052 Color Graphics Card w/Printer Port (PC/XT/AT) ... \$49.95  
JE1055 EGA Card with 256K Video RAM (PC/XT/AT) ... \$169.95  
JE1071 Multi I/O with Drive Controller and Mono Graphics (PC/XT) ... \$119.95

## Multifunction, I/O and Expansion Cards

I/O Card with Serial, Game, Parallel Printer Port and Real Time Clock (PC/XT) ... \$59.95  
JE1061 RS232 Serial Half Card (PC/XT/AT) ... \$29.95  
I/O Card with Serial, Game and Parallel Printer Port (AT) ... \$59.95  
JE1078 Expand to 384K (zero-K on-board) Multifunc w/Ser., Game, Parallel Printer Port & Real Time Clock (PC/XT) ... \$69.95  
JE1081 2MB of expanded or extended memory (zero-K on-board) (AT) ... \$119.95  
3MB of expanded or extended memory, parallel printer port, serial port and game port (zero-K on-board) (AT) ... \$169.95

## Floppy and Hard Disk Controller Cards

JE1040 360KB Floppy Disk Drive Controller Card (PC/XT) ... \$29.95  
JE1041 20/40MB Hard Disk Controller Card (PC/XT) ... \$79.95  
JE1043 360K/720K/1.2MB Floppy Disk Cont. Card (PC/XT/AT) \$49.95  
JE1045 360K/720K/1.2MB Floppy/Hard Disk Controller Card (AT) ... \$149.95

\$20 Minimum Order

IBM is a registered trademark of International Business Machines

## COMPUTER PERIPHERALS

Zuckerboard 30Meg HardDisk Drive Board for Tandy 1000, 1000A, 1000SX, 1200, 3000 and 3000HL

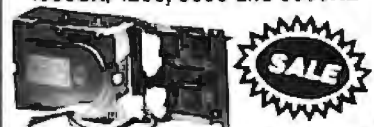

• 30 Megabytes formatted capacity • Uses only one slot • Pre-formatted with MS-DOS  
T30MB 30MB Hard Disk \$599.95 \$399.95



ST225 20MB Drive only (PC/XT/AT) ... \$224.95  
ST225XT 20MB w/Controller (PC/XT) ... \$289.95  
ST225AT 20MB w/Controller (AT) ... \$339.95  
ST238 30MB Drive only (PC/XT/AT) ... \$249.95  
ST238XT 30MB w/Controller (PC/XT) ... \$299.95  
ST238AT 30MB w/Controller (AT) ... \$389.95  
ST251 40MB Drive only (PC/XT/AT) ... \$429.95  
ST251XT 40MB w/Cont. Card (PC/XT) ... \$489.95  
ST251AT 40MB w/Controller Card (AT) ... \$539.95  
ST277 60MB Drive only (PC/XT/AT) ... \$499.95  
ST277XT 60MB w/Controller (PC/XT) ... \$549.95  
ST277AT 60MB w/Controller Card (AT) ... \$639.95

## 40MB Tape Back-Up for IBM PC/XT/AT

XR4 40MB Tape Back-Up ... \$369.95  
TB40 40MB Tape Cartridge ... \$24.95



JE1020 360K Block Bst (PC/XT/AT) ... \$ 89.95  
JE1021 360K Edge Bst (PC/XT/AT) ... \$ 89.95  
JE1022 1.2MB Edge Bst (PC/XT/AT) ... \$109.95

## 3.5" PC/XT/AT Compatible Disk Drives

352KU 3.5" 720KB (Double and Installation Kit incl.) (PC/XT/AT) ... \$129.95  
MF355B 3.5" 1.44MB (Double and Installation Kit incl.) (PC/XT/AT) ... \$149.95

## Datsatronics 2400/1200/300 Modems



NEW Pocket Version!  
• Hayes command compatible • Bell 103/212A compatible • Auto-dial/auto-answer • FCC approved • 1-year warranty • Includes Maximize Communication Software (except 1200P)

1200P 1200/300 Baud Pocket Modem ... \$109.95  
1200H 1200/300 Baud Internal Modem ... \$ 69.95  
2400S 2400/1200/300 Internal Modem ... \$139.95  
1200C 1200/300 Baud External Modem ... \$119.95  
2400E 2400/1200/300 External Modem ... \$179.95

## TEST EQUIPMENT



Metelex M4650:  
• Handheld, high accuracy  
• 4 1/2" Digit LCD  
• Manual ranging with Overload Protection  
• Audible continuity tester  
• Tests AC/DC Voltage, Resistance, Continuity, Capacitance, Frequency  
• One Year Warranty  
• Size 7 1/2" x 3 1/2" x 1 1/2"  
M4650 ... \$89.95

U.S. Funds Only  
Shipping: Add 5% plus \$1.50 Insurance  
(May vary according to weight)

California Residents:  
Add 6%, 6 1/2% or 7%  
Sales Tax

©1988 Jameco Electronics 9/88



Data Sheets - 50¢ each  
Prices Subject to Change

Send \$2.00 Postage for a  
FREE 1988 CATALOG  
FAX Numbers: 415-592-2503  
or 415-595-2664  
Telex: 176043

1355 Shoreway Rd., Belmont, CA 94002 • 24 HR. ORDER HOTLINE 415-592-8097 • All Other Inquiries (7am-5pm PST) 415-592-8121



Circle 85 on Reader Service Card

**DiskMASTER®**  
The Ultimate Diskette Value ...

Discover the Difference ...  
2 FOR 1 LIFETIME WARRANTY

- ✓ Pkg'd in 6 different colors, bulk or boxed
- ✓ 100% tested and certified
- ✓ Guaranteed clipping level of 65% or above
- ✓ Includes tyvek envelopes (not paper), write protect tabs and user labels
- ✓ Quality at affordable prices

5-1/4" - 48 TPI DS-DD	DS-HD 96 TPI IBM-AT Compatible	<b>.49</b>	<b>.90</b>
	BULK COLOR OR GRAY		
	BOXED COLOR	<b>.59</b>	<b>.99</b>

**YCENTECH®** America's Premium Quality Color Diskettes

- ✓ TIMELESS WARRANTY
- ✓ 75%+ clipping level guaranteed
- ✓ Each disk 100% tested and certified
- ✓ 18 COLORS for data organization
- ✓ Pkgs. include sleeves, w/p tabs, & ID labels

5-1/4" - 48 TPI DS-DD	DS-HD 96 TPI IBM-AT Compatible	<b>.84</b>	<b>1.39</b>
	PLASTIC STORAGE BOX COLOR		
	BULK COLOR	<b>.63</b>	<b>1.15</b>
3-1/2" - 135 TPI DS-DD COLOR	3-1/2" - 135 TPI BLACK DS-HD	<b>1.75</b>	<b>4.50</b>
	PLASTIC STORAGE BOX		

**BASF**

5-1/4" 48 TPI DS-DD	DS-HD 96 TPI IBM-AT Compatible	<b>.64</b>	<b>.94</b>
3-1/2" DS-HD	3-1/2" DS-DD	<b>4.50</b>	<b>1.34</b>

Call for best prices on Data Cartridges & Pelikan Ribbons

5-1/4" - 48 TPI DS-DD

**.72**

DS-HD 96 TPI IBM-AT Compatible

**1.48**

**Nashua**

5-1/4" - 48 TPI DS-DD	DS-HD 96 TPI IBM-AT Compatible	<b>.47</b>	<b>*.84*</b>
	BOXED		

**BULK**

**32¢** 5-1/4" DS/DD 48 TPI Exceeds ANSI specifications + 6¢ FOR TYVEK

**ORDERING INFORMATION**

TERMS: P.O. orders accepted, government and schools on net 30. SHIPPING: U.S. orders add \$3.00 per 100 diskettes or fraction thereof, add \$3.00 for COD orders. PRICE PROMISE: We will better any lower delivered price on the same products and quantities advertised nationally.

Toll Free Order Line: **1-800-233-2477** Information Line: **1-801-561-0092**

**DISC INTERNATIONAL**

SUPPLY COMPANY

1376 W. 8040 S. / WEST JORDAN, UT 84088  
HRS: 8 AM TO 5 PM (MTN. TIME)

**Tango™ Sets The Pace!**

Tango's ease-of-use, rich functionality and crisp output have brought tens of thousands of boards to life, quickly and affordably.

Start-to-finish design tools include:

Tango-Schematic With Library Manager	\$495
Tango-PCB 1 mil Grid, 9 Layers, Gerber Output	\$495
Tango-Route Autoroutes 90+%, Fast!	\$495
Tango-Tools 8 More-saving Utilities	\$295

Let's discuss your design needs Toll-free, or order a full function Evaluation Pkg. just \$10 VISA/MC

**800 433-7801** 619-695-2000 Satisfaction guaranteed

ACEEL Technologies, 7358 Trade St., San Diego, CA 92121

Circle 6 on Reader Service Card

8051, 8096, 68HC11, 68008  
**SINGLE BOARD COMPUTERS**

We feature a series of single board computers for process control applications. Available as bare boards or assembled and tested. Optional EPROM resident System Monitors and BASIC interpreters are also available.

**ALLEN SYSTEMS**  
2151 Fairfax Road  
Columbus, Ohio 43221  
614-488-7122

Circle 6 on Reader Service Card

**UNIVERSAL LOGIC PROGRAMMER**

- PROGRAMS READS, DUPLI CATES, TESTS AND SECURES HUNDREDS OF 20- AND 24-PIN DEVICES
- 23 UNIVERSAL PIN DRIVERS WITH INDEPENDENT DAC, ADC & SLEW FUNCTION'S PROGRAM ALMOST ANY LOGIC DEVICE
- MENU DRIVEN OPERATION IS EASY TO LEARN AND QUICK TO OPERATE
- CONNECTS TO ANY IBM COMPATIBLE COMPUTER VIA PARALLEL PRINTER PORT
- EDITS FUSE DATA & TEST VECTORS WITH FULL SCREEN EDITOR
- TESTS WITH VECTORS & SECURES AFTER PROGRAMMING
- SUPPORTS ALL POPULAR PLD DEVELOPMENT SOFTWARE
- GOLD TEXT TOOL ZIF IC SOCKET • ONLINE HELP FUNCTION
- MONEY BACK GUARANTEE • SELF CALIBRATING
- TOLL-FREE TECH SUPPORT • JEDEC FILE INPUT/OUTPUT
- UPDATABLE VIA FLOPPY • ONE YEAR WARRANTY
- EPROM PROGRAMMERS ALSO • SAME DAY SHIPMENT

• JUST \$799

CALL FOR FREE DEMO DISK 800/225-2102

**BP MICROSYSTEMS**  
10681 HADDINGTON # 190 HOUSTON, TX 77043  
713/461-9430 TLX: 1581477 FAX: 713/461-7413

Circle 36 on Reader Service Card

**Fix common problems fast!**

You don't need to be an expert to diagnose and correct problems involving PC setup. All you need is **HELPME™** software! More than 300 tests. On-screen help for understanding and correcting identified problems. Quick identification of system configuration and compatibility. \$99 plus shipping and handling. MC and VISA accepted. California Software Products, Inc., 525 N. Cabrillo Park Drive, Santa Ana, CA 92701 (714) 973-0440.

Circle 38 on Reader Service Card (DEALERS: 39)

**ON TARGET ASSOCIATES**

Products and Services for Design and Manufacturing Engineers.

- Micro Channel Design Consulting
- Prototype Cards
- Newsletter
- ASIC's
- Extender Cards
- Adapter Bracket Sets
- Burn-in Mother Boards

PS/2

We will move your PC/XT/AT products to the Micro Channel, or create your new design.

CALL: (408) 980-7118 for our Free catalog

**ON TARGET TARGET**

...the PS/2 leaders.

PS/2 and Micro Channel are trademarks of IBM Corp.

Circle 195 on Reader Service Card

**EPROM PROGRAMMER**

3349

THE EP-1'S A GREAT VALUE AND HERE'S WHY:

- READS PROGRAMS COPIES OVER 350 EPROM AND EEPROMS FROM 30 MFG'S INCLUDING 2716-2718-2719-2720-28256-27011
- READS WRITES INTEL MOTOROLA STRAIGHT HEX & BINARY
- OPTIONAL HEADS PROGRAM INTEL 874X, 8751, 87C21, 8755
- MENU DRIVEN CHIP SELECTION BY MFG & PIN/NO MODULES
- FAST, SLOW, QUICK PULSE PROGRAMMING ALGORITHMS
- SPLITS FILES BY BASE ADDRESS AND ODD/EVEN (18 & 32 BIT)
- ALL INTELLIGENCE IN UNIT, 280 MICROPROCESSOR BASED
- 5, 12.5, 21.25 V PROGRAMMING FOR CMOS & J-SUFFIX PARTS
- FREE PC-DOS SOFTWARE • RS232 TO ANY COMPUTER
- GOLD TEXT TOOL ZIF SOCKET • 8 BAUD RATES TO 38,400
- MONEY BACK GUARANTEE • ONE YEAR WARRANTY
- 2 FREE FIRMWARE UPDATES • SAME DAY SHIPMENT
- CHECKSUMS SUPPORTED • UV ERASERS FROM \$34.95

CALL TODAY FOR MORE INFORMATION 800/225-2102

**BP MICROSYSTEMS**  
10681 HADDINGTON # 190, HOUSTON, TX 77043  
713/461-9430 TLX: 1581477 FAX: 713/461-7413

Circle 36 on Reader Service Card

# The Amazing A-BUS

**NEW**



An A-BUS system with two Motherboards  
A-BUS adapter (IBM) in foreground

## Plug into the future

With the A-BUS you can plug your PC (IBM, Apple, TRS-80) into a future of exciting new applications in the fields of control, monitoring, automation, sensing, robotics, etc.

Alpha's modular A-BUS offers a proven method to build your "custom" system today. Tomorrow, when you are ready to take another step, you will be able to add more functions. This is ideal for first time experimenting and teaching.

A-BUS control can be entirely done in simple BASIC or Pascal, and no knowledge of electronics is required!

An A-BUS system consists of the A-BUS adapter plugged into your computer and a cable to connect the Adapter to 1 or 2 A-BUS cards. The same cable will also fit an A-BUS Motherboard for expansion up to 25 cards in any combination.

The A-BUS is backed by Alpha's continuing support (our 11th year, 50000 customers in over 60 countries).

The complete set of A-BUS User's Manuals is available for \$10.

### About the A-BUS:

- All the A-BUS cards are very easy to use with any language that can read or write to a Port or Memory. In BASIC, use INP and OUT (or PEEK and POKE with Apples and Tandy Color Computers)
- They are all compatible with each other. You can mix and match up to 25 cards to fit your application. Card addresses are easily set with jumpers.
- A-BUS cards are shipped with power supplies (except PD-123) and detailed manuals (including schematics and programming examples)

#### Relay Card

RE-140: \$129

Includes eight industrial relays. (3 amp contacts, SPST) individually controlled and latched. 8 LED's show status. Easy to use (OUT or POKE in BASIC). Card address is jumper selectable.

#### Reed Relay Card

RE-156: \$99

Same features as above, but uses 8 Reed Relays to switch low level signals (20mA max). Use as a channel selector, solid state relay driver, etc.

#### Analog Input Card

AD-142: \$129

Eight analog inputs. 0 to +5V range can be expanded to 100V by adding a resistor. 8 bit resolution (20mV). Conversion time 120us. Perfect to measure voltage, temperature, light levels, pressure, etc. Very easy to use.

#### 12 Bit A/D Converter

AN-148: \$139

This analog to digital converter is accurate to .025%. Input range is -4V to +4V. Resolution: 1 millivolt! The on board amplifier boosts signals up to 50 times to read microvolts. Conversion time is 130ms. Ideal for thermocouple, strain gauge, etc. 1 channel. (Expand to 8 channels using the RE-156 card)

#### Digital Input Card

IN-141: \$59

The eight inputs are optically isolated, so it's safe and easy to connect any "on/off" devices, such as switches, thermostats, alarm loops, etc. to your computer. To read the eight inputs, simply use BASIC INP (or PEEK)

#### 24 Line TTL I/O

DG-148: \$65

Connect 24 input or output signals (switches or any TTL device) to your computer. The card can be set for: input, latched output, strobed output, strobed input, and/or bidirectional strobed I/O. Uses the 8255A chip

#### Clock with Alarm

CL-144: \$89

Powerful clock/calendar with battery backup for Time, Date and Alarm setting (time and date); built in alarm relay, led and buzzer; timing to 1/100 second. Easy to use decimal format. Lithium battery included

#### Touch Tone® Decoder

PH-145: \$79

Each tone is converted into a number which is stored on the board. Simply read the number with INP or POKE. Use for remote control projects, etc.

#### A-BUS Prototyping Card

PR-152: \$15

3 1/2 by 4 1/2 in. with power and ground bus. Fits up to 10 ICs



ST-143



CL-144

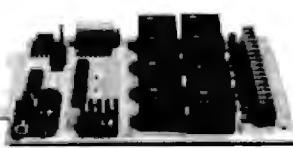

RE-140



IN-141

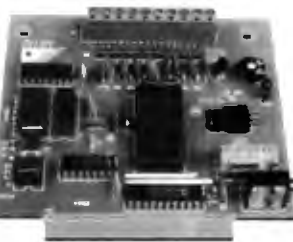

AD-142

### Smart Stepper Controller sc-149: \$299

World's finest stepper controller. On board microprocessor controls 4 motors simultaneously. Incredibly it accepts plain English commands like "Move arm 10.2 inches left". Many complex sequences can be defined as "macros" and stored in the on board memory. For each axis, you can control coordinate (relative or absolute), ramping, speed, step type (half, full, wave), scale factor, units, holding power, etc. Many inputs 8 limit & "wait until" switches, panic button, etc. On the fly reporting of position, speed, etc. On board drivers (350mA) for small steppers (MO-103). Send for SC-149 flyer. Remote Control Keypad Option RC-121: \$49. To control the 4 motors directly, and "teach" sequences of motions. Power Driver Board Option PD-123: \$89. Boost controller drive to 5 amps per phase. For two motors (eight drivers). Breakout Board Option BB-122: \$19. For easy connection of 2 motors. 3 ft. cable ends with screw terminal board.

### Stepper Motor Driver

ST-143: \$79

Stepper motors are the ultimate in motion control. The special package (below) includes everything you need to get familiar with them. Each card drives two stepper motors (12V, bidirectional, 4 phase, 350mA per phase). Special Package: 2 motors (MO-103) + ST-143 PA-181: \$99

### Stepper Motors

MO-103: \$15 or 4 for \$39

Pancake type. 2 1/4" dia. 1/4" shaft. 7.5°/step. 4 phase bidirectional. 300 step/sec. 12V, 36 ohm, bipolar. 5 oz-in torque, same as Airpax K82701-P2

### Current Developments

Intelligent Voice Synthesizer, 14 Bit Analog to Digital converter, 4 Channel Digital to Analog converter, Counter Timer, Voice Recognition.

### A-BUS Adapters for:

IBM PC, XT, AT and compatibles. Uses one short slot	AR-133 \$69
Tandy 1000, 1000 EX & SX, 1200, 3000. Uses one short slot	AR-133 \$69
Apple II II+, IIe. Uses any slot	AR-134 \$49
TRS-80 Model 102, 200. Plugs into 40 pin "system bus"	AR-136 \$69
Model 100. Uses 40 pin socket. (Socket is duplicated on adapter)	AR-135 \$69
TRS-80 Mod 3.4.4 D. Fits 50 pin bus. (With hard disk use Y-cable)	AR-132 \$49
TRS-80 Model 4 P. Includes extra cable. (50 pin bus is recessed)	AR-137 \$62
TRS-80 Model I. Plugs into 40 pin I/O bus on KB or E/I	AR-131 \$39
Color Computers (Tandy). Fits ROM slot. Multiloak or Y-cable	AR-138 \$49

### A-BUS Cable (3 ft, 50 cond.)

CA-163: \$24

Connects the A-BUS adapter to one A-BUS card or to first Motherboard. Special cable for two A-BUS cards: CA-162: \$34

### A-BUS Motherboard

MB-120: \$99

Each Motherboard holds five A-BUS cards. A sixth connector allows a second Motherboard to be added to the first (with connecting cable CA-161: \$12). Up to five Motherboards can be joined this way to a single A-BUS adapter. Sturdy aluminum frame and card guides included.

Add \$3.00 per order for shipping. Visa, MC, checks, M.O. welcome. CT & NY residents add sales tax. C.O.D. add \$3.00 extra. Canada: shipping is \$5. Overseas add 10%



**ALPHA Products**

242-B West Avenue, Darien, CT 06820

Technical info: (203) 656-1806  
Orders only: 800 221-0916  
Except in CT  
Connecticut orders: (203) 348-9436  
All lines open weekdays 9 to 5 Eastern time





**WE OFFER:**

1. Same Day Service - All orders shipped, insured, within 24 hrs
2. Guaranteed Satisfaction - Lifetime warranty, 30-day return guarantee
3. In-stock Inventory - No delays, no disappointments
4. No Minimum Order - Quantity discounts also available
5. Pre-Approved Purchase Orders and Visa & MasterCard Accepted

**AND GREAT PRICES!**

5.25 Black Disks, DS/DD . . .	.36 ea.
5.25 Color Disks, 8 Colors Available, DS/DD . . . . .	.46 ea.
5.25 Black Disks, DS/HD . . .	.82 ea.
5.25 Color Disks, 8 Colors Available, DS/HD . . . . .	.94 ea.
3.5 Blue or Gray Disks, DS/DD . . . . .	1.12 ea.
3.5 Color Disks, 5 Colors Available, DS/DD . . . . .	1.28 ea.
3.5 High Density, Black only . . . . .	3.80 ea.

100% certified and tested. Error free lifetime warranty. All disks include generic white box, Tyvek sleeves, labels, write protect tabs, shrink wrapped.



**CONTINUOUS FORM LABELS**

Size	Across	Box Qty.	Price/1,000
2 3/4 x 7/16	1 across	10,000	\$1.95
2 3/4 x 7/16	4 across	20,000	\$1.95
2 1/2 x 15/16	1 across	5,000	\$2.18
2 1/2 x 15/16	3 across	15,000	\$1.98
2 3/4 x 2 3/4*	1 across	2,500	\$12.00
2 3/4 x 1-7/16	1 across	5,000	\$3.00
3 x 15/16	4 across	20,000	\$2.00
3.3 x 15/16	4 across	20,000	\$2.05
3 1/2 x 15/16	1 across	5,000	\$1.90
3 1/2 x 15/16	2 across	10,000	\$1.90
3 1/2 x 15/16	3 across	15,000	\$1.90
3 1/2 x 15/16	4 across	20,000	\$1.90
4 x 15/16	1 across	5,000	\$3.21
4 x 15/16	3 across	15,000	\$3.21
4 x 1-7/16	1 across	5,000	\$3.25
4 x 1-7/16	3 across	15,000	\$3.25

Prices quoted for full boxes only. \* Designed for the 3 1/2" disk.

**"The Quality Disk & Label Specialist Since 1982"**  
 1040 Broadway  
 Westville, NJ 08093  
**609-456-6996**  
**FAX# 609-456-7172**  
 All products assembled in the U.S.A.  
 All orders F.O.B. Westville, NJ  
 C.O.D. orders add \$2.20

**9-TRACK MAG. TAPE SUBSYSTEM\* FOR THE IBM PC/XT/AT AND...**



For information interchange, backup and archival storage AK Systems offers a 9-track, IBM format-compatible "4" magnetic tape subsystem for the IBM PC, featuring:

- IBM format 9000 3200 and 800 cpl.
- Software for PC-DOS, MS-DOS, XENIX.
- Also for AT&T, DEC, VAX, VME, S-108, RS-232C, IEEE 488.

© January 1983 Manufacturer

**AKSystems**

20741 Avenida St.  
 Chatsworth, CA 91311  
 (818) 708-9100  
 Telex: 610-480-3071

\* IBM is a registered trademark of International Business Machines Corporation.

Circle 12 on Reader Service Card



**PC488B \$445**

**IEEE-488 INTERFACE CARD WITH BUILT-IN BUS ANALYZER**

- GIBASIC package complements IBM/Microsoft BASIC interpreter and compiler to create a programming environment similar to HP desktop computers.
- Additional libraries of over 20 high level 488 dedicated functions for C, Pascal or Fortran available (\$50).
- Powerful menu-driven bus analyzer which can run in the foreground or in the background while 488 programs or commands are executed, features program stepping, break points and real time bus data capture (4k circular buffer).
- Instant logging between foreground and Analyzer screen.
- Complete Talker/Listener/Controller capability.
- Dipswitch selectable Base Address, IRQ, DMA.

VISA MC AMEX Call today for details!!!

**B&C MICROSYSTEMS**

355 West Olive Ave., Sunnyvale, CA 94086  
 PH: (408)730-5311 FAX: (408)730-5321 TELEX: 981485

Circle 25 on Reader Service Card

**Dealers!**

**Network-OS LAN Systems** - Includes Boards, Cabling, Terminators and Software. Two-user hardware and software for under \$1,000 list!

**Close-Up Remote Communications** - Support your customer without leaving your office. Authored by Cogitate for Norton-Lambert!

**Contact Sensitive Help for DataFlex, RM/COBOL, Clipper and dBase III** - Puts your application's documentation "on line."

**DataFlex Database Management** - True Multi-User database for MS/PC-DOS, Unix and Xenix. Site licensing available.

**Dump/Restore-XT** - Seven utilities for the MS/PC-DOS user.

Call or write today for our catalog and pricing!

**COGITATE, INCORPORATED**

**"A Higher Form of Software"**

24000 Telegraph Road

Southfield, MI 48034

(313) 362-2345/Telex: 368551

Visa/MasterCard Accepted

Circle 45 on Reader Service Card

**Get the whole story on graphics terminal emulation.**



To find out more about software that lets your PC emulate **TEKTRONIX™ 4105/6/7/9** and **DEC VT100™** terminals, call or write:

**GRAFFPOINT**

4340 Severna Creeks Blvd., Suite 280,  
 San Jose, CA 95129 (408) 249-7951

Circle 113 on Reader Service Card

**IBM PC/VT220**

- EM220 \$169**
- VT220, VT102 emulation
  - File Transfer
  - 132 Column modes
  - Color Support
  - Hot Key

**TEK 4105**

- EM4105 \$349**
- Tektronix 4105 emulation
  - Tektronix 4100 emulation
  - VT220, VT102 emulation
  - Picture files
  - High resolution hardcopy
  - VGA and EGA support



**Diversified Computer Systems, Inc.**

3775 Iris Ave., Suite 1B  
 Boulder, CO 80301  
 (303) 447-9251

Trademarks: VT220, VT220 - DEC, IBM PC, XT - IBM Corp.  
 Tektronix - Tektronix Inc.

Circle 78 on Reader Service Card

**FREE!**  
**Turn-key PC Systems Handbook**

**NEW IBM Fall Winter Edition**

Save Time and Money  
 Over 1000 Hard-to-find  
 Hardware and Software  
 Items of Special  
 Interest to Technical  
 PC Users

166 Pages Available Now

- RS 232C/IEEE 488 Hardware
- Stepping & Servo Motor Controls
- Ruggedized PCs
- Pack. Mfg. (SOPs & SOCs)
- Laboratory Automation
- 1 MHz AD
- Digital Scopes to 200 MHz
- High Speed Bus Adapters
- Workstation Symulators
- Data Loggers
- PC Bus Expansion Cards
- And Much More

A How-to-Handbook that enables you to configure the BEST products from the world's leading PC hardware and software vendors into real time turn-key system solutions that meet your needs.

Get Free Notes for application assistance and convenient one stop shopping at competitive prices. 100% Satisfaction Guaranteed.

Call or write for a FREE  
 Handbook today!  
**203-786-5151**  
 (9:00 AM to 5:00 PM E.S.T.)

**CyberResearch, Inc.**  
 P.O. Box 9085, New Haven, CT 06538  
 Fax: 203-794-8023 Telex: 9109501027

Circle 64 on Reader Service Card





## RS-422/232 CURRENT LOOP



DS-225

- Single channel async communication board for IBM PC/XT/AT
- Software selectable to be RS/422/485, 232 or Current Loop
- Selectable Address & Interrupt

1-800-553-1170



478 E. Exchange St., Akron, OH 44304  
(216) 434-3154 TLX: 5101012726

Circle 217 on Reader Service Card

## SERIAL/PARALLEL Communications Board



- Two Parallel Printer Ports
- Two 8-Bit Digital I/O Ports
- Two Serial Ports, RS-232, RS-422 or RS-485
- Address Selectable
- Selectable & Shareable Interrupts



478 E. Exchange St., Akron, OH 44304  
TEL: (216) 434-3154 FAX: (216) 434-1408  
TLX: 5101012726

Circle 218 on Reader Service Card

## RS-422 Communications Board

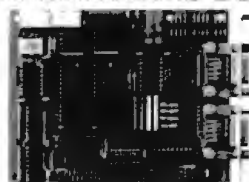

- For IBM PC/XT/AT/PS/2
- Dual channel RS-422/RS-485
- Selectable/shareable interrupts
- Differential drivers to 4000 ft.
- Immediate delivery

1-800-553-1170



Leaders in Communication Technology  
478 E. Exchange St., Akron, OH 44304  
(216) 434-3154 TLX: 5101012726

Circle 219 on Reader Service Card

## 72 Digital I/O

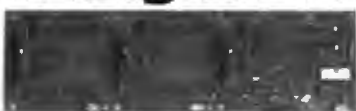

PXB-721

Parallel Expansion Board

- For IBM-PC & Compatibles
- 72 Digital I/O Lines
- Simple Programming
- Uses One Expansion Slot
- Fast Delivery

**\$195**

1-800-553-1170



478 E. Exchange St., Akron, OH 44304  
(216) 434-3154 TLX: 5101012726

Circle 220 on Reader Service Card

## MODULAR DATA ACQUISITION

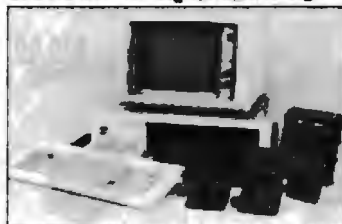

- FOR IBM & Compatibles
  - Flexible and Inexpensive
  - Money Back Guarantee
  - Free Technical Support
- Fast Delivery**  
1-800-553-1170



Leaders in Communication Technology  
478 E. Exchange St., Akron, OH 44304  
(216) 434-3154 TLX: 5101012726

Circle 221 on Reader Service Card

## IEEE-488



MXI-100

- GPIB controller board for IBM PC/XT/AT
  - Control up to 14 Devices
  - User friendly Software Commands
  - DMA Transfer to 200k byte/sec.
- \$345.00 including software



478 E. Exchange St., Akron, OH 44304  
(216) 434-3154 TLX: 5101012726  
800-553-1170

Circle 222 on Reader Service Card

## RS-232 Communications Board



- For IBM-PC/XT/AT & comp.
  - Dual RS-232C interface
  - Optional software supports COM1, COM2, COM3, COM4
  - Jumper selectable interrupts
- Fast Delivery**  
1-800-553-1170



478 E. Exchange St., Akron, OH 44304  
(216) 434-3154 TLX: 5101012726

Circle 223 on Reader Service Card

## WAVEFORM SYNTHESIZER

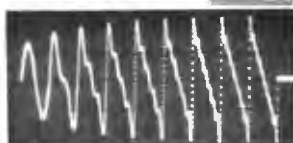

- For IBM PC/XT/AT and compatibles
- Generates user-definable signal
- Up to 2000 points per envelope

**\$795.00**

1-800-553-1170

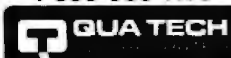

478 E. Exchange St., Akron, OH 44304  
(216) 434-3154 TLX: 5101012726

Circle 224 on Reader Service Card

## RS-422 Communications Board FOR

### PS/2

MODELS 50, 60, 80

- DUAL CHANNEL
- ADDRESS SELECTABLE
- BAUD RATE TO 256 K
- INTERRUPT SELECTABLE

1-800-553-1170



Leaders in Communication Technology  
478 E. EXCHANGE ST  
AKRON, OH 44304  
(216) 434-3154 TLX: 5101012726  
FAX: (216) 434-1408

Circle 225 on Reader Service Card

**MAXELL**  
**100% CERTIFIED**  
**5 1/4" BULK DISKS**

**5 1/4" DS/DD 59¢**

**3 1/2" DS/DD 1.09**  
 Price based on quantity of 300  
 includes sleeves, labels and tabs.

**800-222-0490**  
 In NJ 201-462-7628  
 FAX 201-462-5658

● 24 Hour Shipment ●

**MEGAsoft**  
 P.O. Box 710, Freehold, NJ 07728

Circle 164 on Reader Service Card

**BUY QUALITY FOR LESS!**  
**DYSAN**

**5 1/4" DS/DD 39¢**  
**100% CERTIFIED LIFETIME WARRANTY**  
 Price based on quantity of 250 in bulk  
 includes Tyvek sleeves and label kits.

**800-222-0490**  
 In NJ 201-462-7628  
 FAX 201-462-5658

● 24 HOUR SHIPMENT ●

**MEGAsoft**  
 P.O. Box 710, Freehold, NJ 07728  
 Full service duplication facility

Circle 165 on Reader Service Card

**FCC APPROVED!**

**Sub-Mini AT!**  
**The Space Saver**  
**3-DR. Capability**  
**8-Expansion Slots!**



**Basic System:**

- 3-LEDs, Keylock, Reset & Turbo Switch
- 200-Watt Power Supply
- 8 Full Size Expansion Slots
- 3 Exposed Half Height Drive
- Smaller Foot Print Than XT
- 6/12MHz 0 Wait State
- 80287 Math Coprocessor Ready
- On Board 0-1MB RAM With 512K
- 1ea 1.2MB High Density Drive
- 1ea WDC WA2 Floppy/H.D. Controller
- BTC-5060 AT Style Keyboard
- Assembled, Tested & Burned-in

**MAT-1 \$799.00**



**UNIVERSAL E(E)PROM PROGRAMMER \$495 (Kits from \$165)**

- No personality modules; Mass driver device selection.
- Built-in Erase/Timer option (ESU); Conductive foam pad.
- Direct technical support, Full 1 year warranty.
- Stand alone duplication & verify (27XX parts).
- Quick pulse algorithm (2726 under 60 sec).
- 27xx to 1 Mbit; 25xx; 68xx; CMOS; EEPROMS.
- 8741, 2, 4, 8, 401, 9, 901, 61, C31, 62, 55, 9761 & more.
- IBM-PC, Apple, CPM or Unix driver; Antistat RS232.
- Offset/Apple Hex, Binary, Intel & Motorola 6, 16, 32 bit.
- Mounted with complete schematics.

VISA MC AMEX Call today for distributor's list

**B&C MICROSYSTEMS**  
 355 WEST OLIVE AVE. SUNNYVALE, CA 94086  
 POC (408) 730-3311 FAX: (408) 730-3321 TELEX: 984183

Circle 26 on Reader Service Card

**SAVE ON**

**9 TRACK TAPE SYSTEM**  
 FOR IBM PC/XT/AT



- Mainframe to PC Data Transfer
- High Speed Backup
- All Software, Complete System
- Service and Support, easy Installation

call (810) 343-6565 or write to:  
**CONTECH Computer Corp.**  
 P.O. Box 153 Tarzana, Calif 91356

**CONTECH**

Circle 58 on Reader Service Card

**UNIPRO™**  
 UNIVERSAL PROGRAMMER AND  
 MEMORY/TTL IC TESTER FOR PC/XT/AT



E(EPROM) (16K-1MB)  
 PAL (20 & 24 pins)  
 BIPOLAR  
 8741/42/48/50 CPU  
 87C151/44 CPU  
 DYNAMIC/STATIC RAM &  
 TTL TESTER  
 Option: 4 Socket adaptor  
 only \$585 complete

Other products available. Individual programmers for E(EPROM) (up to 1MB), PAL, BIPOLAR, 8248 series, 8751 series, Memory/TTL Tester, and gang programmers with 4, 8, & 16 sockets. Also industrial quality EPROM Eraser with timer and safety switch is available (erases 30 of 28 pin eproms at a time).

OEM & Distributor welcome.  
 10% educational discount

473 Sapona Ct. #24  
 Santa Clara, CA 95064  
 Tel (408) 727-8995  
 FAX (408) 727-6998

**XELTEK** VISA  
 M/C AMEX

Circle 296 on Reader Service Card

**MICRO CHANNEL ENGINEERING DEVELOPMENT SUPPLIES**

**INTRODUCING: The PS/2 Burn-In Board!**  
 For Design and Manufacturing Engineers



1. First Passive Backplane for PS/2 Micro Channel
2. Test adapters without power cycling computers
3. Test adapters without damaging computers
4. Optional module and software provides single step bus simulation

CALL now for your FREE Catalog.  
 Quality PS/2 compatible products available.

**ON TARGET TARGET TARGET** ON TARGET Associates  
 1034 W. Maude Ave., # 602  
 Sunnyvale, CA 94085  
 (408) 980-7118

PS/2, and Micro Channel are trademarks of IBM Corp.

Circle 194 on Reader Service Card

**PERIPHERALS FOR XT AND AT**

**FOR XT**

1. Floppy Disk Controller With Cable \$20.00
2. Hard Disk Controller With Cable \$72.90
3. Color Graphics Card With Composi Jack \$47.10
4. Color Graphics Card With Printer Port \$51.80
5. Mono Graphics Card With Printer Port \$51.80
6. Color/Monochrome Graphics Printer Card (Runs Color Software on TTL) \$69.40
7. Enhanced Graphics Adaptor (EGA) \$147.10
8. Smart VGA \$276.50
9. Parallel Printer Card \$17.60
10. Dual Game I/O Card \$17.60
11. Serial I/O Card \$23.50
12. Dual Serial I/O Card \$41.20
13. Mouse For PC/XT/AT w/Driver Software \$61.20
14. Multi I/O (Ser/Par/Game/Cir/Cir) \$58.80
15. No Slot Clock With Software \$27.10
16. 0-576K RAM Card \$31.80
17. 8MHz XT Motherboard w/Phoenix BIOS \$81.20
18. 10MHz XT Motherboard w/Phoenix BIOS \$88.20
19. 150-Watt Power Supply \$43.50

**FOR AT**

20. Floppy/H.D. Controller w/Cables \$141.20
21. 0-2MB EMS RAM Card With Software \$112.90
22. Serial/Parallel Card \$43.50
23. 6/10MHz AT M.B. 0 Wait, Phoenix BIOS \$278.80
24. 6/12MHz AT M.B. 0 Wait, Phoenix BIOS \$325.90
25. 8/10MHz Mini AT M.B. 0-W. Award BIOS \$325.90
26. 6/12MHz Mini AT M.B. 0-W. Phoenix BIOS \$347.10
27. 200-Watt Power Supply 74.10

**10MHz XT Turbo Basic System:**

- Baby AT Case
- Keylock, LED, Reset & Turbo Sw
- 4.77/10MHz Selectable
- 8 Expansion Slots
- 8087 Math Coprocessor Ready
- 150-Watt Power Supply
- 0-640K On Board With 256K
- 1ea 360K Floppy Drive
- 1ea Floppy Disk Controller
- 1ea Mono Graphics Printer Card
- 1ea 12" TTL Amber Monitor With Swivel Base
- 1ea XT Style Keyboard
- Assembled, Tested & Burned-in

**XT10-1 \$495.00**

**6/10MHz AT-286 Basic System:**

- 6/10MHz Selectable
- 6MHz 1-Wait, 10MHz 0-Wait
- 8 Expansion Slots
- 80287 Math Coprocessor Ready
- 200-Watt Power Supply
- 0-1MB On Board With 512K
- 1ea 1.2MB Floppy Disk
- 1ea Floppy/H.D. Ctrl.
- 1ea BTC-5060 AT Style KBD

**AT10-1 \$777.00**

**ORDER HOT LINE 1-800-543-5107**  
 Technical Information (714) 990-2097  
 Hours: Mon. - Fri. 9:00 am - 6:00 pm PST  
 Please write for our complete price list.

**JAWIN COMPUTER PRODUCTS**



565 W. Lambert Rd., #C  
 Brea, CA 92621

**Terms:** Please add 5% for \$2.00, whichever is higher plus 25¢ per each \$10000 CA residents please add 6% sales tax. We accept VISA/MC/Cash. Personal checks please allow 2 weeks to clear. All merchandise is warranted for 1 year unless otherwise stated.



## Make Money With Your PC

A Revolutionary Software System, designed for maximum profits with minimum setup, now transforms any IBM PC/XT/AT or compatible computer into a secure, reliable Bulletin Board and Information Host System.

Subscription Systems throughout the free world are presently being used in dial-a-date and matchmaking applications, for multi-user databases and multiple listing endeavors, on-line order taking, along with scores of other lucrative telecommunications tasks.

To learn more about this unique, self-perpetuating opportunity that can adapt to both voice and data environments, contact: PC/WORKS at (805) 654-0721 or FAX (805) 650-0195.

Circle 204 on Reader Service Card

## PAL/EPROM PROGRAMMER CARD

For PC/XT/AT Systems

NEW - VERSION 2 OF SOFTWARE AND HARDWARE

Programs 20 and 24  
Pin LMA, NS, TL, AMD,  
ALTERA, CYPRESS,  
FICOR, and PANATEC  
PALS. Supports EPLD,  
solitary, RA, and shared  
product term types.  
Functions include: Read,  
Write, Verify, Protect,  
Erase, Print, and File load  
and save of program.  
JEDEC supported.  
Software Included



\$475

## 100MHZ LOGIC ANALYZER CARD

For PC/XT/AT Systems

\$1199



24 Channels at 250ns-25Mhz  
4 Channels at 100 Mhz  
Internal Clock up to 100 Mhz  
External Clock up to 25 Mhz  
Threshold Voltage TTL, ECL,  
or variable from -10 to +10v  
Can Stack Multiple Boards  
All Software Included

CALL NOW FOR ORDERS AND  
TECHNICAL INFO (201) 994-6669

Link Computer Graphics, Inc. 4 Sparrow Dr.  
Livingston, NJ 07038. TEL: 9102409305 LINK COMPUTER

Circle 146 on Reader Service Card

## RS-422

- RS-422/485
- Selectable Address/I/O
- Two/Four Wire Operation
- One/Two/Four Port Versions
- Delivery From Stock



SCALEVEL SYSTEMS INC  
PO BOX 1808  
EASLEY, SC 29641  
(803) 858-1881

Circle 243 on Reader Service Card

## OPTICAL DISKS

### LASERDRIVE

as featured in PC WEEK 4/26/88  
• 800MB storage on single disk  
• connecting to any host via SCSI  
interface  
• Plug'n Play to any operating system  
only \$4995 Limited time only

**PANASONIC LS5000**  
\$2495 - 200 MB

**OPTICAL MEDIA**  
For IBM & Panasonic Optical  
Drives - \$52

We carry a full line of  
51/4" & 12" Optical Drives

SKAN TEKNOLOGIES, INC.  
optical storage systems  
(212) 809-5570 (516) 295-2237

Circle 250 on Reader Service Card

## SMART SWITCHES



... at your command

Master Switch is sophisticated yet flexible. Several computers can access one another or share printers and modems. Use serial or parallel interfaces, up to nine ports. The buffer is expandable up to one megabyte. Access a job control menu from each computer to view the queue or cancel, hold, and release jobs. Many other features.

MasterNet software allows computer networking and electronic mail capabilities for PCs.

Other solutions from ROSE

- Printer Sharing
- Protocol Conversion
- Buffering
- Micro to mainframe
- Multiplexers
- Modems
- Manual Switches
- Cables

We design a variety of quality products for computer networking and data communications solutions guaranteed to work. Dealer and OEM inquiries are welcome.

**ROSE** P.O. BOX 743771 HOUSTON TX 77271  
ELECTRONICS CALL FOR CATALOG 713 933 7673

Circle 235 on Reader Service Card  
(DEALERS: 236)

## NEW! INSTANT TERMINAL

"EXACT TERMINAL EMULATION AND COMMUNICATIONS SOFTWARE"

- PRECISE EMULATION OF THE DEC VT52, VT100, VT102, VT220
- EXPANSION MODULES FOR OVER 40 EXACT EMULATIONS
- 9 FILE TRANSFER PROTOCOLS.
- EASY TO USE, QUICK TO INSTALL, AND MUCH MORE
- IBM PC, XT, AT, PS/2

FOR INFORMATION  
800/548-9777

SOFTWARES  
303/593-9540  
TELEX 450236

ONLY  
**\$97.50**

Circle 252 on Reader Service Card

## VMEbus Multibus I & II S-100 bus

To achieve performance, you need a performance bus. To find out the latest information on any of the above buses, you need

### SUPERMICRO

the magazine for integrators and users of VME, Multibus, and S-100.

SUPERMICRO, PO Box 2089, Provo, UT 84603

To find out how you can receive a trial issue, circle the number below.

Circle 264 on Reader Service Card

NEW! **BIG MOUTH**™ VERS. 2.0

REAL VOICE Digital Recording for your PC, XT, AT or Compatible

- ◆ VOICE MAIL SYSTEM
- ◆ TELEMARKETING - Inbound & Outbound
- ◆ SMARTEST ANSWERING MACHINE
- ◆ AUTODIALER—DATABASE
- ◆ VOICEPAD™ - Voice for your Programs
- ◆ PROGRAMMER'S TOOLKIT - (Optional '79)

1/2 card, software, cables, and speaker

**\$289<sup>00</sup> + 5 s/h**

(415) 652-9600  
Talking Technology, Inc.  
4383 Piedmont Ave. Suite B  
Oakland CA 94611

Circle 268 on Reader Service Card

## 6809 Single Board Computer



6809 MPU, 2 serial ports, 4 parallel ports, RAM, EPROM, real-time clock, watchdog timer, 44-pin 4.5" x 6.5" PCB  
EXPANSION MODULES: RAM, EPROM, CMOS RAM/battery, analog I/O, serial I/O, parallel I/O, counter/timer, IEEE-488, EPROM programmer, floppy disks, cassette, breadboard, keyboard/display

**WINTEK**

Wintek Corp  
1801 South Street  
Lafayette, IN 47904  
317-742-8428

Circle 293 on Reader Service Card

# DATAFLEX™

- Multi-user Database!
  - Powerful!
  - Multiple Operating System Compatibility!
  - Attractive Dealer Pricing!
  - Full Dealer Support!
- Dataflex is a trademark of Data Access  
Dealer Inquiries Invited

## COGITATE

24000 Telegraph Road  
Southfield, Michigan 48034 USA  
(313) 352-2345

Circle 46 on Reader Service Card

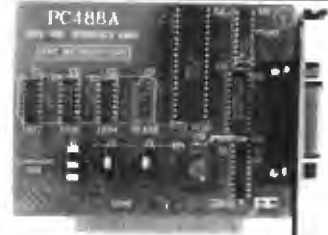

**PC488A \$145/195**

LOW COST PC/XT/AT INTERFACE FOR IEEE-488 (GPIB/HPIB)

- Includes INSTALLABLE DOS DEVICE DRIVERS and software support for BASIC
  - Optional language support for C, PASCAL, FORTRAN and ASSEMBLY - 180
  - Selectable base I/O address, IRQ and DMA
  - CONTROLLER / TALKER / LISTENER capability
  - Customer support via dedicated 24 hours B&C Microsystems BULLETIN BOARD
  - Quantity discounts available
- VISA MC AMEX *Call today for details!!!*

**B&C MICROSYSTEMS**

355 West Olive Ave., Sunnyvale, CA 94086  
PH: (408)730-5511 FAX: (408)731-5521 TELEX: 984535

Circle 27 on Reader Service Card

## ANGEL II Universal Print Buffer

SIX MOST USEFUL INTERFACE DEVICES IN ONE BOX

By combining all the features of a megabyte buffer, an interface converter, a protocol converter, an automatic A/B switch, a code generator, and an interface tester, six most useful interface devices in one box the ANGEL II is a buffer in its own class. It gives the maximum value at the lowest cost. It provides the convenience and convenience to the computer user that will never outgrow. It is the ideal buffer for your Laser printer, Pover, CAMCAD, and Desktop Publishing applications. ANGEL II DOES IT ALL FOR YOU THE ANGEL II GIVES YOU THE BEST VALUE IN THE MARKET TODAY!

Angel II-485 \$225.00  
Angel II-525 \$225.00  
Angel II-128 \$245.00

Who accept Visa, Mastercard, C.O.D. (cash) To order from the U.S. Call Toll-Free 1-800-285-7487

COMPUTER AGE LTD.  
P.O. BOX 730  
MOBILETON, ORY. LAG 1340  
1-418-627-4378

Circle 51 on Reader Service Card

## IMAGING CARD

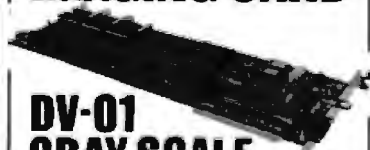

### DV-01 GRAY SCALE FRAME GRABBER

Composite video in/out  
256 x 240 resolution  
Digitize/display at frame speed  
256 gray levels in  
16 Meg. color palette out  
PC/XT/AT compatible  
\$849.00 Complete with software  
VISA/MC Demo Disk available

**Control Vision**  
P.O. Box 596, Pittsburg, KS 66762  
(316) 231-6647

Circle 59 on Reader Service Card

## "INDISPENSABLE"

Jerry Pournelle, Byte, 8/87

Vopt is the fast, safe disk organizer. It will quickly eliminate the file fragmentation that slows your disk operations.

Vopt includes Vmap for viewing the organization of your disks plus numerous other utilities that test and report on the efficiency of your system.

Call for a free demo disk!  
**\$59.95** \$3 shipping/handling  
CA add 6.5% sales tax.

**GOLDEN BOW SYSTEMS**  
2870 Fifth Ave., Suite 201  
San Diego, CA 92103  
800/284-3269

Circle 112 on Reader Service Card

Dynamic Electronics

23552  
Constance Dr  
Suite 1  
Laguna Hills  
CA 92653

Stocking Distributor of Semiconductors

8087 • 5 • 8 • 10  
80287 • 6 • 8 • 10 MEG  
80387 • 16 • 20 MEG  
256K • 64K • 128K • V 20 • V 30  
Fast • Reliable • Everytime

Phone: 714-855-0411

Fax: 714-855-8504

No return - exchange only - exchange good for 30 days unless manufacturer warranties merchandise longer

Circle 89 on Reader Service Card

# Verbatim

5 1/4" DISKS	5 BOX	10 BOX
D-Side	<b>795</b>	<b>760</b>
D-Den.	<b>730</b>	
High Den.	<b>1465</b>	<b>1390</b>
	<b>1330</b>	
3 1/2" Diskettes		
S-Side	<b>1195</b>	<b>1650</b>
D-Side		<b>3995</b>
8" Diskettes		
S-Side	<b>1695</b>	<b>2040</b>
S-Den.		<b>2345</b>
D-Den.		
International Orders Accepted		
Delaware 1-800-451-1849 Oklahoma 1-800-654-4058 Nevada 1-800-621-6221		
Diskette Connection Minimum Order 2500 - Visa, MasterCard accepted, C.O.D. orders add \$1.00 shipping charge in US, HI, or PR add 5% additional for PAL. Terms subject to change without notice.		
Telex #4933362 • Fax #405-495-4598		

# 3M

5 1/4"	5 Box	10 Box
D-Side	<b>795</b>	<b>760</b>
D-Den.	<b>730</b>	
HIGH Den.	<b>1645</b>	<b>1570</b>
	<b>1500</b>	
"Worldwide" Orders Accepted		
3.5 S-Side	<b>1250</b>	8" S-Side
35 D-Side	<b>1750</b>	8" S-Side
35 H-Den	<b>4795</b>	8" D-Den
		<b>2340</b>
DATA CARTRIDGES DC 1000 - 12.95 DC 2000 - 17.50 DC 300XLP - 19.75 DC 600A - 21.95		
Authorized Distributor Magnetic Media Division <b>3M</b>		
Delaware 1-800-451-1849 Oklahoma 1-800-654-4058 Nevada 1-800-621-6221		
Diskette Connection Minimum Order 2500 - Visa, MasterCard accepted, C.O.D. orders add \$1.00 shipping charge in US, HI, or PR add 5% additional for PAL. Terms subject to change without notice.		
Telex #4933362 • Fax #405-495-4598		

"WITH TYVEK SLEEVES"

# 29¢ ea.

1000+

## BULK 5 1/4" DISKS

Double Side-Double Den.

100% Tested & Certified Error Free, at "Minimum 55% Clipping Level or Higher." "Lifetime Warranty." With Tyvek Sleeves & Write on Labels

100	200	600
<b>.34</b>	<b>.33</b>	<b>.31</b>
each	each	each

DEALERS WELCOME

Telex #4933362 • Fax #405-495-4598  
Shipping Charges Vary With Quantity Call

Delaware 1-800-451-1849  
 Oklahoma 1-800-654-4058  
 Nevada 1-800-621-6221

Diskette Connection  
 Minimum Order 2500 - Visa, MasterCard accepted, C.O.D. orders add \$1.00 shipping charge in US, HI, or PR add 5% additional for PAL.



# SPEECH PRODUCTS

For PCs and compatibles

**SYNTHESIZER—only \$79.95**



The next versatile and best sounding speech product available for under \$4000! The amazing Speech Thing provides text-to-speech as well as PCM and ADPCM speech and music reproduction. Comes with "Thing" D/A converter that attaches to the parallel printer port outside the computer—ideal for laptops. Will not interfere with normal printer operation. Also comes with audio amplifier/speaker and power adapter. Software includes two advanced text-to-speech programs, digitized speech and music files, full screen waveform editor, sampling music keyboard, special effects mixing board, and drivers so you can add speech and sound effects to programs written in BASIC, C, PASCAL, and others. Includes 54 page manual. **SPEECH THING—\$79.95.**

**DIGITIZER—only \$89.95**



The Voice Master PC Digitizer is a full 8-bit PCM sampler board. Fits in any available slot. Up to 15,000 samples per second. Input pre-amp has automatic gain control and 4.5 Khz low pass filter. Includes a quality headset microphone. Software included for recording and editing sound files for playback through Speech Thing. Also includes a real-time spectrum display and oscilloscope display as well as assembly language source listings for writing your own drivers. **BONUS:** Voice recognition program included which is callable via an interrupt vector. Demonstration program written in GWBASIC. **VOICE MASTER PC DIGITIZER—\$89.95.**

**VOICE RECOGNITION—only \$49.95**



A price/performance breakthrough! Equal in performance to other systems costing hundreds more \$\$\$! The amazing Voice Master Key program adds voice recognition to just about any program or application. You can voice command up to 256 keyboard macros. Fully TSR and occupies less than 64K. Instant response time and high recognition accuracy. Easy and fun to use—no compilers or editors required. Works with CAD, desktop publishing, word processor, spread sheet, even other TSR programs. A genuine productivity enhancer. Voice Master Key can also be called from within a program for adding voice recognition to custom applications. Voice Master Key requires the Voice Master PC Digitizer for operation. (Please note: Voice Master Key will not replace the keyboard or mouse except under certain circumstances. Not to be confused with the still unavailable "voice typewriter.") **VOICE MASTER KEY—\$49.95.**

**BONUS OFFER!** Buy Voice Master Key with PC Digitizer for only \$129.95—you save \$10!

**BETTER BONUS OFFER!** Buy all three: Speech Thing, PC Digitizer, and Voice Master Key for only \$189.95—you save \$20!

**ALL OF THESE PRODUCTS ARE OF PROFESSIONAL QUALITY.**

**ORDER HOTLINE: (800) 342-1271**

Monday-Friday, 8 AM to 5 PM Pacific Time

Add \$5 for shipping and handling on all orders. Add an additional \$3 for 2nd day delivery. All goods shipped UPS. Master Card and VISA, money order, cashiers check or personal checks accepted (allow a 3 week shipping delay when paying by personal check). Foreign inquiries contact Covox for C&F price quotes. Specify computer type when ordering. **30 DAY MONEY BACK GUARANTEE IF NOT COMPLETELY SATISFIED. ONE YEAR WARRANTY ON HARDWARE.** Call or write for FREE product catalog.



**COVOX INC.** 675-D COMBER ST.,  
EUGENE, OREGON 97402 U.S.A.  
TEL: 503-342-1271 FAX: 503-342-1293



## GANG/SET (E)EPROM MULTIPROGRAMMERS™

Model 135-E \$995<sup>00</sup>  
Others from \$345

- Model 135 is a SET Programmer, GANG Duplicator, & UNIVERSAL Device Programmer
- Programs virtually all 24, 28, & 32-pin (E)EPROMs.
- RAM expandable to 2MegaByte
- Optional support for 40-pin EPROMs, Bipolar PROMs, 40-pin Micros, & (E)PLD/GAL/FPLA Devices.
- 18-Month WARRANTY & 12-Month FREE Device Updates.

**1-800-523-1565**

In Florida: 1-407-994-3520

**BYTEK** BYTER Corporation  
1021 S. Rogers Cr. Boca Raton, FL 33487  
FAX: (407) 994-3615 Telex: 4996369 BYTER  
\*U.S. Prices only

## The BEST for LESS 29<sup>¢</sup> EA

Quality 5 1/4" DS DD Diskettes Min. 100

Guaranteed Two-for-One Replacement

if found initially defective within six months

FREE sleeves, tabs, labels

- 5 1/4" COLOR (Min. 100) ..... 39¢
- 5 1/4" HIGH DENSITY (Min. 50) ..... 89¢
- Brand Box 5 1/4" (Min. 10) ..... \$3.99
- Brand Box COLOR 5 1/4" with FREE Plastic Case (Min. 10) ... \$4.99
- 3 1/2" DS/DD (Min. 50) ... .. \$1.09

100% Lifetime Warranty

Shipping: \$4.50 per min. order/\$2.00 each add. lot

MC/VISA Only

**1-800-537-1600**

Operator No. 227



Dept. No. 1323 P.O. Box 61000  
San Francisco, CA 94161

## Motion Control & Data Acquisition



A card in your PC creates the fast LAB 40 bus which supports up to 8 modules.  
**User Friendly Packages for PC/XT/AT**

- Intelligent DC Servo: Joystick, numeric control, motion record/playback. C calls. Up to 16 axes. Two axis package w/motors \$1550 (USA)
- 4-Axis Stepper w/source code & motor \$316
- Scope/FFT 650KHz A/D 4 ch. w/source \$525
- \*Modules: 8 & 12 bit A/D, Relay, Stepper, Clock, Servo & Amps, Prog Controller (Forth, A/D, EEPROM, 68HC11, RS-232/422/485, LAB 40)
- \*Adapter for RS-232 for Mac and others.
- \*Free immediate technical support & literature. Call (415) 755-1978 or our BBS (415) 755-1524.

75 Southgate  
Daly City, CA 94015  
**Computer Continuum**  
(415) 755-1978 Telex: 372743B

**not only a printer buffer!**  
THIS IS THE MOST SOPHISTICATED  
**PRINTER BUFFER - MULTIPLEXOR - SWITCH**

WITH TWO SEPARATE INPUTS (SERIAL AND PARALLEL) AND TWO SEPARATE OUTPUTS (SERIAL AND PARALLEL) - CAN BE USED LIKE STANDARD BUFFER. WITH ANY INPUT TO ANY OUTPUT. BUT ALSO YOU CAN CONVERT 1 COMPUTER TO 1 PRINTER OR 1 COMPUTER TO 2 PRINTERS OR 1 COMPUTER AND 2 PRINTERS AND MORE - 1 COMPUTER TO 3 PRINTERS OR 3 COMPUTERS TO 1 PRINTER.

HIGH CAPACITY - 64 KB TO 1 MB AND - 64 KB TO 1 MB (MODELS A AND B) PAUSE, COPY AND RESET FUNCTIONS. SERIAL PORTS WITH 1 OR 2 BIT WORD LENGTH 1 OR 2 STOP BIT. PARITY. XON/XOFF. DTR. RTS.

DCB-A-44K \$ 195 DCB-B-844K \$ 255 M

Power supply and parallel cables are included.

ALSO, WE HAVE THE MOST COMPLETE DATA CONVERTER UNIT. CONVERTS BINARY SERIAL TO CENTRONICS PARALLEL OR YOUR YIELD, JUST BY MOVING JUMPERS. BAUD RATE AND PROTOCOL FULLY PROGRAMMABLE FROM 9600 TO 19200 BAUDS. INCLUDES DTR, RTS, XON/XOFF, PARRY, etc.

DCU \$ 80 M

Power supply and cables NOT included.

**serial & parallel bi-directional converter**

**INTECRA Inc - Dept. 233**  
300 TERMINAL BLVD  
MOUNTAIN VIEW, CA 94043  
(415) 967-8818 TX 345545

**Presto!**  
**A Link to Mainframe Graphics**

Find out how our whole family of EMU-TEK graphics terminal emulation software makes good sense for the work you do. Call today for more information.

**FTC DATA SYSTEMS**  
(714) 995-3900  
(800) 962-3900 (800) 972-3900 (Call TX)  
10801 Dale St., Suite M-2  
Sancton, CA 90580

## Serial Data \$495 Analyzer

Introductory Offer

DataScout™ turns your PC into a tool for solving RS-232 interfacing problems.

**Features:**

- Monitor full duplex async data
- Log Monitored Data to Disk
- Post Acquisition Analysis
- Inject Data in Either Direction
- Integrated Breakout Box
- 9 LEDs Monitor Signal Levels
- Simple menu driven interface

HiTech Equipment Corp.  
**HTE** 9560 Black Min. Rd.  
San Diego, CA 92126  
(619) 566-1892

# WE WILL NOT BE UNDERSOLD — CALL (800) 654-7762

## CAT™ 8MHz

- BASE SYSTEM**
- 256K (Opt. 640K) • 150 Watt Power Supply • AT Style Keyboard • 4.77 or 8 MHz Keyboard Selectable • FDC • 8087 Socket • 380K Floppy Drive

**\$39900**

COMPLETE SYSTEM CALL FOR PRICE  
1 Year Warranty



## CAT™ 286-10

- BASE SYSTEM**
- 512K Exp. to 1 MEG • 200 Watt Power Supply • AT Style Keyboard • Western Digital Controller • 1.2 Meg Floppy • Legal Bios w/ manuals • Systems Documentation • 1 yr. war. • Clock/Calc

**\$92900**

COMPLETE SYSTEM CALL FOR PRICE  
11.3 Months @

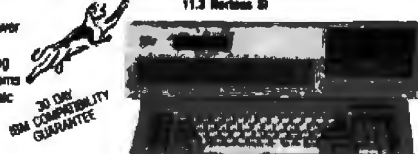

<b>OPTION A</b> 12" Mono Amber Monitor Graphics Card w/par port <b>\$54900</b>	<b>OPTION B</b> 640 x 200 Color Monitor Graphics Card w/par port <b>\$71600</b>	<b>OPTION C</b> 12" Mono Amber Monitor Graphics Card w/par port 20 Meg Hard Drive <b>\$81900</b>	<b>OPTION A AT</b> 12" Mono Amber Monitor Graphics Card w/par port <b>\$107800</b>	<b>OPTION B AT</b> 640 x 200 Color Monitor Graphics Card w/par port <b>\$123900</b>	<b>OPTION C AT</b> 12" Mono Amber Monitor Graphics Card w/par port 20 Meg Hard Drive <b>\$133900</b>
---	--	--	---	--	--

**PRINTERS**

<b>IBM PARALLEL CABLE</b>	<b>PANASONIC</b>	<b>CITIZEN</b>
KXP1888 144CPS ... 199	MSP15E 180CPS 9 Pin 15" 380	MSP40 250CPS 9 Pin 10" 380
KXP1891 192CPS ... 229		
KXP1882 240CPS ... 379		

Tractors — Sheet Feeders — Cables — Ribbons Available

**EVEREX MEMORY & IO CARDS**

EV138 0-576K For XT	8900
EV173 Par/Ser/Clock 0-1 Meg XT	10900
EV173A Par/Ser 0-1 Meg AT	7900
EV159 RAM 3000 Lotus/Intel 0-3 Meg	11900
EV178 I.O. Par/Ser/Clock	6900
EV658 EGA 640 x 350 Auto Switching	14900

**MONITORS**

<b>EGA INTERFACE</b>	<b>GOLDSTAR</b>	<b>COLOR OR MONO INTERFACE</b>
EGA 640 x 350		
	<b>SAMSUNG</b>	
	12" Monochrome Amber	7900
	14" RGB Color 640 x 200	24900
	14" EGA Multisync	44900

**EPSON 3 1/2 DISK DRIVE**

• In 5 1/4 Mounting • 720K

**150 WATT POWER SUPPLY**

• Direct PC Replacement

**\$5900**

5 YEAR WARRANTY

**EVEREX TAPE BACKUPS**

40MB Mini Cartridge, 1.8MB/min. XT	35900
40MB Mini Cartridge, 3.6MB/min. AT	35900
40MB Streaming Cassette, 5MB/min w/coat	53900
60MB Streaming Cassette, 5MB/min w/coat	61900
60MB Streaming Cartridge, 5MB/min w/Full cont.	77900
125MB Streaming Cartridge, 5MB/min w/Full cont.	90900

External Add 19500

**RAM UPGRADES**

4164 150 NS, 64 x 1	3900
4164 120 NS, 64 x 1	3200
4184 100 NS, 64K x 1	4400
41256 150 NS, 256K x 1	12900
41256 120 NS, 256K x 1	13900
41256 100 NS, 256K x 1	13900
4464 150 NS, 64K x 4	12900
1Meg 100 NS, 1048 x 1	3900

**HARD DRIVES**

Seagate COMPLETE KITS

8T225 20Meg w/conf. & Cables	26900
8T238 30Meg w/conf. & Cables	29900
8T251 40Meg 1/2 HT 40 Min w/software	37900
8T251-1 40Meg, 2.8 Mil Sec	47900
8T4826 20Meg Full HT 40 Mil	27900
8T4805 80Meg Full HT w/software	64900

**MODEMS**

EVEREX

EV-920 EverCom 12 300/1200 bps	7400
EV-940 Internal 300/1200/2400	15900
EV-945 External 300/1200/2400	23900

MNP for all of above add \$10.00

Modem / Hayes Compatible

1200 Baud w/Btcom 5 yr. Warranty	6900
1200 Baud External, 5 yr. Warranty & Software	9900
2400 Baud Internal, 5 yr. Warranty & Software	12900

**INTEL COPROCESSORS**

Intel 8087 5MHz	6900
Intel 8087 8MHz	14900
Intel 80287 6MHz	17900
Intel 80287 8MHz	23900
Intel 80287 10MHz	28900
Intel 80387 16MHz	42900
Intel 80387 20MHz	77900

**SIMM RAM UPGRADES**

256K x 9 120 NS	13900
1 Meg x 9 120 NS	64900

## BELOW EVERYONE'S COST — CLEARANCE SALE

# LETTER QUALITY PRINTER

Why pay \$1149 for a C. Itoh  
**STARWRITER™ F-10**

When our 40 cps letter quality daisywheel printer from the same manufacturer is only

**\$29900**

ea. 100 for \$249

These printers were originally priced to sell at over \$1100. Through a special arrangement MEAD has purchased these units from a major computer manufacturer and is offering these printers at a fraction of their original cost.

DAISYWHEEL PRINTER MANUFACTURED BY C.I.TOH



**3 MONTH WARRANTY**

**OPTIONS**

• 6 ft. Serial Cable	\$ 1900
• AT or XT RS232C/Serial Interface	3900
• Bidirectional Tractor	14900
• Cut Sheet Feeder	19900

**STANDARD FEATURES**

- 40 CPS • Accepts Paper to 15 inches
- Form Length and Pitch Set from Control Panel
- Industry compatible ribbon, printwheels and control commands
- RS232 Serial Interface

**TANDON**

<b>380K FLOPPY DRIVE</b>	<b>180K FLOPPY DRIVE</b>
• TM100-2A Full Height	• TM 100-1A • 160K
• Orig. Drives used by IBM	• IBM Plg & Instructions
List 24900	List 19900

**10 MEG HARD DRIVE**

COMET

- 1/2 Height
- 66 Mil Sec.

List 29900

**PRINTER STANDS**

MANUFACTURED BY EPSON OR IBM

List 3900

**OKI DISK DRIVE**

• 380K IBM Compatible

• 5 1/4", 1/3 Height • 90 Day Warranty

List 19900

**MITSUBISHI FLOPPY DRIVE**

1.2 MEG

• 5 1/4" Half Height • Black Face • 1 Year Warranty

List 9900

**DATA CARTRIDGE**

IBM COMPATIBLE

• DC 300 XLP • 45 Meg or Less • Indiv. Wrapped

List 3900

**800-654-7762**

SALES: 7 A.M. - 3 P.M. PST

**702-294-0204**

CUSTOMER SERVICE / ORDER STATUS:  
9 A.M. - 4 P.M. PST

**FAX 702-294-1168**



NO SURCHARGE FOR MC/VISA

**TERMS:**

MC • VISA • CDD • CASH  
Purchase Orders from Qualified Firm  
Personal Checks • AE add 4%

20% Restocking Fee on Non-Selectable Returns



SHIPPING: (min. 60) UPS



Circle 87 on Reader Service Card

**\*FREE! Headcleaning Kit**

**3M** High Performance Products For People

DS-DD	Quantity Discounts Available	DS-HD
.72*	5.25"	1.48
1.49	3.50"	4.45

3M No-Logo Bulk w/tyvek, labels, W/P .....52  
 DC-1000 ..... 12.75 DC-300XLP ..... 19.85  
 DC-2000 ..... 17.25 DC-600A ..... 21.65

**WHOLLY KAO** COLOR DISKS  
 110% of Industry Standards

DS/DD Color	5.25"	OS/HD Color
.79	in Plastic Storage Box	1.29
.45	Bulk - Color	.88
DS/DD Color	3.50"	DS/DD Color
1.59	in Plastic Storage Box ... no logo	1.29

**BASF** \*FREE BASF VCR TAPE

5.25" DS/DD	5.25" DS/HD
.65*	1.35
3.50" DS/DD	.95
60 BASF 5.25" DS/DD in Mialdex/60	47.40

**Verbatim** \*FREE! DataLifePlus\* offer inside

5.25" DS/DD	3.50" DS/DD	5.25" DS/HD
.75	1.49	1.39
DataLifePlus w/Teflon, PC Formatted... .85		

**Nashua**

5.25" DS/DD	3.50" DS/DD	5.25" DS/HD
.49	1.35	.83

**BULK**

BLACK DISKS	COLOR DISKS	
.29	5.25" DS/DD 48TPI	.39
.69	5.25" DS/HD 96TPI	.79
1.05	3.50" DS/DD 135TPI	1.19
*5.25" Bulk Disks with sleeves, labels & w/p tabs, add 6c		

**Worldwide Special!**

Price in U.S. currency per box of ten diskettes includes COST OF PRODUCT, INSURANCE AND (AIR)FREIGHT (C.I.F. Anywhere in the World!)

**BOX OF TEN DISKS: CIF WORLDWIDE BY AIR PRICE:**

5.25" DS/DD/48TPI	4.75/box
BASF-5.25" DS/DD in plastic library box	8.50/box
KAO-5.25" DS/HD 'AT' in plastic library box	9.99/box
KAO-3.50" DS/DD in plastic library box	13.95/box

(Min. order 50 boxes. Orders shipped within USA & Canada via surface deduct 75¢ per box. Offer expires September 30, 1988. Prices higher on certain destinations where air consolidation not available.)

**CALL FOR INFORMATION ON RIBBONS, STORAGE, MAG TAPES AND YOUR NAME & LOGO DISKETTES**

TERMS: VISA, Mastercard or AMEX. COD only add \$3.00. Prepaid orders deduct 2% cash discount. PO's accepted from recognized institutions and corporations on Net 30. Shipping: \$4/100 or lower disks. Reduced shipping charges on larger quantities.

**WE BEAT ANY PRICE!**

Toll Free Order Line: **1-800-523-9681**  
 Information Line: **1-801-255-0080**  
 TLX-9102404712 FAX-801-572-3327

**DISKOTECH**  
 DISKCO TECHNOLOGIES, INC.  
 213 Cottage Avenue  
 P.O. Box 1339 Sandy, Utah 84091

344 B Y T E • SEPTEMBER 1988

**RS-232C INTERFACE AND MONITORING EQUIPMENT CATALOG FROM B & B ELECTRONICS**

WRITE OR CALL for YOUR FREE COMPREHENSIVE B & B ELECTRONICS CATALOG TODAY!

Pages and pages of photographs and illustrated, descriptive text for B&B's complete line of RS-232 converters, RS-422 converters, current loop converters, adapters, break-out boxes, data switches, data splitters, short haul modems, surge protectors, and much, much more. Most products meet FCC Part 15.

Your RS-232 needs for quality, service and competitive prices will be more than met by B&B ELECTRONICS. Manufacturer to you, as middleman! Money-back guarantee! Same-day shipment! One-year warranty on products! Technical support available!

Write For Your FREE Catalog Today!

**B & B electronics**  
 MANUFACTURING COMPANY  
 1502J Boyce Memorial Drive, P.O. Box 1040 • Ottawa, IL 61350  
 Phone: 815-434-0846

Circle 24 on Reader Service Card

**Quel® 68000** Software Development Tools

Since 1983, professional quality tools for the entire 68xxx family including the 68030. Hosts: MS-DOS, UNIX and VAX.

**C Compilers  
 C Source Level Debuggers  
 Macro Assembler Packages  
 Disassemblers  
 Simulators**

**AVOCET**  
 Systems®, Inc.  
**800/448-8500**  
 FAX: 207/236-6713  
 Telex: 467210 AVOCET CI

Circle 230 on Reader Service Card

**9-Track Tape Subsystem for the IBM PC/XT/AT**



Now you can exchange data files between your IBM PC and any mainframe or mini-computer using IBM compatible 1600 or 6250 BPI 9-Track tape. System can also be used for disk backup. Transfer rate is up to 4 megabytes per minute on PCs and compatibles. Subsystems include 7" or 10 1/2" streaming tape drive, tape coupler card and DOS compatible software. For more information, call us today!

**QUALSTAR**  
 9621 Irondale Ave., Chatsworth, CA 91311  
 Telephone: (818) 882-5822

Circle 226 on Reader Service Card



**2400BAUD \$95 MODEM**

**30 DAY FREE TRIAL**

WE AREN'T KIDDING...HIGH PERFORMANCE TEXAS INSTRUMENT CHIP SET. LOW COST, NO COMPROMISE 2400, 1200, 300 BAUD MODEM. FULL FEATURED, HAYES COMPATIBLE IBM INTERNAL SOFTWARE INCLUDED. 30 DAY MONEY BACK TRIAL.

CALL FOR DETAILS  
**CompuCom Corporation**  
 (800) ACT ON IT (408) 732-4500 (CA)

Circle 48 on Reader Service Card

**WE ARE LOOKING FOR:**

Distributors who can offer us PC Products (Hard disks, NEC Printers, Monitors, Graphics Cards etc.) quickly, at a competitive price, suitable for sale on the German Market.

**WE ARE OFFERING:**

PC-Products made in Germany of a high quality, some of which are only available from Germany. (Copy Cards, etc.) for Atari and Amiga PCs.

**Hendrik Hasse Computersysteme.**  
 Wiedfeldstr. 77 10-4300 Essen  
 West Germany  
 Telefax — 49 201 422575

Circle 303 on Reader Service Card

**ICs PROMPT DELIVERY!!!**  
 SAME DAY SHIPPING (USUALLY!)  
 QUANTITY ONE PRICES SHOWN for JULY 13, 1988

OUTSIDE OKLAHOMA		NO SALES TAX	
<b>DYNAMIC RAM</b>			
SIMM	1048Kx9	100 ns	\$550.00
1Mbit	1048Kx1	100 ns	37.50
41256	256Kx1	60 ns	14.25
41256	256Kx1	80 ns	13.95
41256	256Kx1	100 ns	13.50
51256	+ 256Kx1	100 ns	13.50
41256	256Kx1	120 ns	12.95
41256	256Kx1	150 ns	11.50
41264	+ 64Kx4	120 ns	16.95
<b>EPROM</b>			
27C1000	128Kx8	200 ns	\$37.50
27C512	64Kx8	200 ns	13.95
27256	32Kx8	250 ns	7.25
27128	16Kx8	250 ns	6.60
<b>STATIC RAM</b>			
43256L-10	32Kx8	100 ns	\$18.50
6264P-12	8Kx8	120 ns	13.75

640K BATTERED UPGRADE Zermis 150.  
 IBM PC AT, Compat Portables & Plus, 100 Vectra

WE EXPORT ONLY TO CANADA, GUAM, PUERTO RICO & VIRGIN ISLANDS

OPEN 6 DAYS 7 AM TO 10 PM SHIP VIA FEDEX ON SAT

FAST DELIVERY INCLUDED ON PRE-PAID ORDERS RECEIVED BY: THE SUN BY 3:30 PM PT. 48 HRS. 1-800-267-4961

MasterCard/VISA or UPS CASH COD  
**Factory New, Prime Parts MICROPROCESSORS UNLIMITED, INC.**  
 24 000 S. Peoria Ave. (918) 267-4961  
 BEGGS OK 74421

No distributor orders. Please note the prices are subject to change. Shipping & insurance extra. \$ 4.95 for shipping. Orders received by 3 PM CST are usually shipped the next morning, via Federal Express Standard Air @ 95.00, or guaranteed next day Priority One @ 85.00

Circle 176 on Reader Service Card

# TIMELINE INC.

SUPER  
SEPTEMBER  
SALE

ORDER DESK ONLY

Continental U.S.A.  
(800) 872-8878

Inside California  
(800) 223-9977

L.A. & Technical Info  
(213) 217-8912

OEM INQUIRIES  
WELCOME

## AST™ RAMPAGE AT



**\$59**  
INCREDIBLE!

### MEMORY EXPANSION CARD FOR YOUR IBM PC/AT

Can be expanded to 2Mb memory. This card can do EMS and EEMS as well as extended memory. We bought these bulk pack from an OEM, so no AST box or manual. We supply our own manual. Comes with software for printer spooler and Ramdisk. 1 year warranty. RAMPAGE™ card available with O-K memory only. Serial/parallel port card available separately at a very good price.

**\*ADAPTEC 4000A CONTROLLER \$79**  
I/O for the ST412-508 Interface Using MFM Encoding

**\*DC 600 STYLE TAPES \$15.00**  
10,000 fpi es. 19.95 3-9 17.95 es. 10+ (minimum order 2)

**\*AST ADVANTAGE \$79**  
1-Serial, 1-Parallel Port. For AT. Has extended memory (no EMS or EEMS). (O-K memory)

## ZENITH

7" DIAGONAL SCREEN

## HIGH RESOLUTION AMBER MONITOR

**\$29.95**  
MODEL DJ7NKZ

22 MHz  
TYPICAL  
BANDWIDTH



- Flat faceplate
- 900 lines at center
- 650 lines at corners
- Operates from 12VDC at 1.4 amp
- Vertical input is 47 to 63 Hz
- Horizontal frequency: 15 KHz (adjustable)

4 for  
\$99.00

For split video (TTL inputs) operation.  
Not composite video.

# VGA COLOR GRAPHICS PACKAGE

## POSSIBLE DISPLAY MODES VGA GRAPHICS:

800 x 560 x 16 colors  
320 x 200 x 256 colors



### ALSO:

640 x 480 x 16 colors  
640 x 350 x 16 colors  
640 x 200 x 16 colors  
640 x 200 black & white  
320 x 200 x 4 colors  
Hercules Graphics  
40 and 80 column character mode

## INCREDIBLE!

The manufacturer of this monitor SET THE STANDARD FOR COLOR GRAPHICS. The card is an ATI improved VIP CARD. The package comes with user friendly manual and step-by-step instructions. One year warranty on the monitor, two year warranty on the card.

CALL FOR QUANTITY DISCOUNTS.

- 13" color screen
- Max resolution (800x560)
- Bandwidth: 17 Mhz
- Software selectable to VGA, EGA, CGA, MDA, HGA
- Anti-reflective, coated non-interlaced flicker free screen
- .31 dot pitch

1490 W. ARTESIA BLVD, GARDENA, CA 90247



Continental U.S.A.  
(800) 223-9977

Inside California  
(800) 872-8878



L.A. Area & Technical Info  
(213) 217-8912

15% Restocking fee for returned orders.

### NO SURCHARGE FOR CREDIT CARD ORDERS!

Minimum Order: \$25.00. Shipping & handling charges via UPS Ground: \$.50/lb. UPS Air: \$1.00/lb. Minimum Charge: \$4.00. We accept cashiers checks, MC or VISA. No personal check COD's. California residents add 6 1/2% sales tax. We are not responsible for typographical errors. All merchandise subject to prior sale. Phone orders welcome. Foreign Orders require special handling. Prices subject to change without notice.



**BULK DISKS**

All Items In Stock  
**100% Guaranteed**  
 MC, VISA, COD Accepted  
 24 Hour Shipment  
 Call For Our Monthly Specials

**3.5" DS/DD**

- MAXELL 1.25
- SONY 1.17
- DATASAFE 1.09

**5.25" DS/HD**

- TDK 1.29
- DATASAFE .89

**5.25" DS/DO**

- MAXELL .64
- VERBATIM .59
- 3M .57
- DATASAFE .39

Prices based on 200 Disks  
 Includes Labels, Sleeves & Tabs  
 Smaller Quantities Available  
 In NJ 800-426-0247 FAX  
 201-882-5655 201-882-6188

**PRINCETON  
 DISKETTE**

432 MacArthur Dr. ■ Brick, NJ 08724

Circle 209 on Reader Service Card

**TurboFlow \$69**

Flowchart drawing for IBM PC/XT/AT/PS2

**\$89 with Logitech mouse!**

- Pop-up icon menus
- Variable size symbols
- Paper size to 34" x 44"
- Hercules mono, CGA, EGA
- HP-GL, DM/PL, SweetP Plotters
- Automatic PANning to scan drawing quickly
- IBM/EPSON, NEC, OKIDATA, HP LaserJet

Daytron Electronics Inc.  
 610 S. Sherman #104, Richardson, Tx 75081  
 Add sales tax (24 USA, \$20 foreign), Texas residents add 8% sales tax

**Order Today! 1-214-669-2137**

Money-back guarantee

Circle 76 on Reader Service Card

**Sure  
 it's insured?**

SAFEWARE® Insurance provides full replacement of hardware, media and purchased software. As little as \$39/yr. covers

- Fire • Theft • Power Surges
- Earthquake • Water Damage • Auto Accident

For information or immediate coverage call  
**1-800-848-3469**  
 In Ohio call 1-614-262-0559

**SAFEWARE**  
 SAFEWARE, The Insurance Agency Inc

Circle 238 on Reader Service Card

**DYNAMIC RAMS**

1MBIT	100ns	\$39.00
51258	100ns	\$12.25
41464	150ns	\$10.75
41256	100ns	\$12.75
41256	120ns	\$11.75
41256	150ns	<del>\$10.85</del>
41264	150ns	\$14.75
4164	150ns	<del>\$ 2.95</del>

1 For high-speed Zp. Pico, Sanyo

PROCESSORS	PRICE	16 PROMS	PRICE
80287-16 16mbps	\$445.00	27C101 250ns	\$ 24.00
80287-10 10mbps	\$275.00	27C512 200ns	\$ 18.00
80287-8 8mbps	\$235.00	27F12 250ns	\$ 12.50
80287-6 6mbps	\$195.00	27C256 250ns	\$ 8.00
80287-4 4mbps	\$155.00	27F256 250ns	\$ 8.50
80287-2 2mbps	\$115.00	27F256A 200ns	\$ 8.50
V-30 8mbps	\$ 12.75	27F64 250ns	\$ 5.00
V-20 10mbps	\$ 17.00	43256 200ns	\$ 18.00
V-30 8mbps	\$ 5.50	43256 150ns	\$ 13.50

**I.C. EXPRESS**

15358 Valley Blvd. City of Industry, CA 91746 Tel: 818-360-2888  
 CREDIT TO GO PRICE (When F.I.R. P.O.)  
**(800) 892-8889 • (800) 882-8181**

CALL FOR CURRENT PRICES & AVAILABILITY  
 Price subject to change without notice. Minimum order \$100.00. Shipping & handling extra. Orders ship on 17th of month. All prices include 10% discount with prompt delivery.

Circle 124 on Reader Service Card

**"D" SIZE PLOTTER**

\$2295.00  
 RETAIL

\$1695.00  
 INTRODUCTORY OFFER

- Model PC 3600
- Repeatability .001"
- Speed at 7" Per Second
- Vacuum Paper Hold Down
- High Resolution Circles: Suitable for PCB Artwork

**(415) 490-8380 ZERICON**  
 STEVENSON BUSINESS PARK  
 BOX 1669, FREMONT, CA 94538

Circle 299 on Reader Service Card

**ZSTEM**

VT220 D400  
 VT240

**TERMINAL EMULATION**

**KEA SYSTEMS LTD.**  
 #412 - 2150 West Broadway  
 Vancouver, B.C. CANADA, V6K 4L9  
 Tel: 604-732-7411 Telex: 04-352848 VCR  
 FAX: 604-732-0715  
 Order Toll Free (800) 663-8702

**KEA SYSTEMS**

Circle 142 on Reader Service Card

**HARD DISK CONTROLLERS**

ADAPTEC

PC/XT Controller ST508412	\$45
2070 Controller PC/XT to ST 508412 RLL	\$69
2071 PC/XT to ST508 RLL (1 drive)	\$69
2072 PC/XT RLL	\$79
2370 PC/AT to ST508 RLL	\$99
3530 SCSI to Tape QIC 36	\$78
4000 SCSI to ST508412	\$89
4520 SCSI to ESDI	\$98
5500 SCSI to ST508412	\$125
5580 SCSI to SMD	\$175

XEBEC

5140 SASI Controller	\$89
51420 SASI to 5 1/4" Floppy & Hard Disk Controller	\$29
Apple II, II+, IIE Host Adapter	\$29

OTHERS

DTC 510A SASI Controller	\$99
WD 1002-SHO Xebec Compatible SASI Controller	\$109
Konan DJ-210 3.5" SASI to ST508412 (Xebec 1410 clone)	\$98

• Call for cable prices.  
 • Controller manuals \$8 each.

Computer Surplus Store  
 Phone 408-434-1050  
 FAX 408-434-0931  
 Telex 1581447  
 MCVSA/Discover/COD's

**"WE BUY AND SELL"**

**MCVSA/Discover/COD's**

Circle 54 on Reader Service Card

**HD64180 Single Board**

Prototyping / Control Computer

Get your 64180 project going quickly!

The SBC100 is a complete computer powered by a wall transformer. Available C compiler, assembler, linker and debugger run on a PC. Has battery-backed RAM, battery-backed clock, power fail interrupt, SBX bus connectors, serial and parallel I/O, prototype area for up to 20 IC's. Only \$295 including serial cable, power supply, 32k of battery backed RAM and schematics.

**Z-World**  
 1772A Picasso Avenue  
 Davis, CA 95616  
 (916) 753-3722  
 In Germany: iSystem 08131/1687

**"Z80 Family Specialists"**

Circle 301 on Reader Service Card

**"C" for Z80 and  
 HD64180 Microprocessor  
 Programming.**

Source level debugging on a remote target system!

Investigate our powerful PC-based, C compiler for embedded Z80 and HD64180 microprocessors. A compiler written for microprocessor engineers. Excellent for the new Hitachi single chip HD647180X microprocessor. \$495.00 for the compiler. Remote source debugger \$195.00. We have many other products: assemblers, linkers, prototyping SBC's, etc.

**Z-World**  
 1772A Picasso Ave.  
 Davis, CA 95616  
 (916) 753-3722  
 In Germany: iSystem Tel: 08131/1687

**"Z80 Specialists"**

Circle 302 on Reader Service Card

# Priority One

**T**

his full featured computer is built from the chips up by one of Korea's biggest firms (they also build cars). But because the price is so low, they made us promise not to print their name in this ad.

These hot new systems come with everything you could want or need—the things the other guys charge you extra for. This means you get a full 640K RAM memory as a standard feature, instead of a measly 256K that most other systems sold today offer.

At today's chip prices, the memory you need to run programs on their system means a \$200 upgrade—with ours, it's already installed.

Each system is thoroughly tested and backed by a full one year warranty and the assistance of our Toll-Free Technical Support Hotline.

**Features:**

- 4.77/8MHz Turbo Processing Speed
  - 640 Kbytes of RAM memory
  - Serial and parallel ports
  - 4 Slots for system expansion
  - Hercules compatible video
  - Clock calendar w/battery backup
  - MS-DOS/GW Basic version 3.2
  - One year warranty
- \*Integrated Software Package Included\*  
with System FREE



Single Floppy System  
without Monitor

**\$591<sup>.30</sup>**

20 Mbyte System  
with Monochrome Monitor

**\$879<sup>.30</sup>**



**QUANTUM**  
42.7 Mbyte  
Hard Disk **\$279**

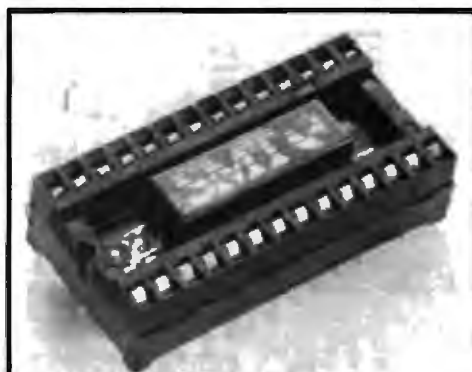

No-Slot  
Clock **\$29<sup>.99</sup>**



**KRAFT**  
Mouse  
w/Telepoint  
& Pops-Menu **\$39<sup>.99</sup>**

**MORE SPECTACULAR SPECIALS**

NEC MultiSync II	\$599.99	Paradise EGA 480	\$169.99
NEC MultiSync GS	\$199.99	Orchid Tiny Turbo	\$279.99
NEC MultiSync+	\$899.99	Orchid Designer VGA	\$299.99
NEC MultiSync XL	\$1954.99	Video 7 VRAM VGA	\$554.99
Taxan 770 Plus	\$499.99	Video 7 VEGA VGA	\$298.99



**PRIORITY 1 ELECTRONICS**

21622 Plummer St., Chatsworth, CA 91311

**(800) 423-5922**  
**FAX (818) 709-4362**



- Same Day Shipping
- Money Back Guarantee (call for details)
- No credit card surcharge - limited to stock on hand

PRODUCT AND PRICING MAY NOT BE AVAILABLE IN RETAIL STORES



# IC's, Parts, Components... Shipped Fast!

## West Coast's Largest Selection... Call for More

### RAM Upgrades!

- ...priced in sets of 9
- 64K/120ns ..... CALL
  - 64K/150ns ..... CALL
  - 256K/100ns ..... CALL
  - 256K/120ns ..... CALL
  - 256K/150ns ..... CALL

### DYNAMIC RAMS

4198200ns	Call	4464/150ns	Call
MK4332/200ns	Call	41256/100ns	Call
4184/200ns	Call	41256/120ns	Call
4184/150ns	Call	41256/150ns	Call
4184/100ns	Call	41264/150ns	Call
4184/PIN ONE	Call	4128/150ns	Call
4418/200ns	Call	8118/4517	Call
4418/150ns	Call	1 MEG/100ns	Call
4484/200ns	Call	TMS 4161/150ns	Call

### STATIC RAMS

2102/P/450ns	\$ 99	8116/120ns	\$2.95
2101/450ns	1.79	8116/P/150ns	2.45
2112/450ns	2.89	8254/P/120ns	4.95
2114/450ns	89	8254/P/150ns	4.95
21142	1.19	8264/150ns	4.25
2114L/2	1.99	82256/120ns	12.85
6116/150ns	2.45	82256/100ns	10.95

### 74 HCT SERIES

74HC100	\$ 25	74HC161	\$ 65	74HC1540	\$1.99
74HC102	25	74HC183	65	74HC1541	1.99
74HC104	25	74HC184	65	74HC1563	2.99
74HC108	25	74HC175	65	74HC1564	2.99
74HC110	25	74HC240	1.29	74HC1573	1.99
74HC112	30	74HC241	1.29	74HC1574	1.99
74HC114	49	74HC244	1.29	74HC1640	1.99
74HC1138	50	74HC245	1.29	74HC1646	2.99
74HC1157	65	74HC257	65	74HC1563	2.99
74HC1160	65	74HC259	1.10	74HC1564	2.99

### LINEAR

CA3090	\$1.19	LM396	\$1.10	LM3900	45
CA3090	1.19	LM397	75	LM3909	1.25
CA3091	1.19	LM732	30	LM3911	1.95
CA3092	1.49	LM733	30	LM3914	2.75
LF388N	1.49	LM741	30	LM3915	2.75
LF388N	1.99	LM747	80	LM3916	2.75
LF441	1.89	LM748	85	LM4024	3.95
LMC001	30	LM1414	1.49	LM4044	3.95
LMC008K	1.00	LM1888	3.29	LM4136	1.50
LMC177K	2.95	LM1330	1.95	LM4508	75
LMC177T	1.75	LM1350	1.25	LM7555	2.50
LMC1818	1.15	LM1359	1.95	LM7558	2.50
LMC1919	95	LM1372	2.25	LM7800	2.95
LMC3207-XX	88	LM1408LL	2.50	LM7803	2.95
LMC3208-XX	1.35	LM1450	48	LM7810-405	6.95
LMC322K	4.25	LM1469	68	LM7812	6.95
LMC324	35	LM1489	68	LM8308	3.75
LMC3302	1.19	LM1889	2.50	MC3423	1.99
LMC3302	1.19	LM2003	75	MC3459	2.99
LMC3374	4.95	LM2210	3.75	MC3470	2.99
LMC3374	4.95	LM2211	1.99	MC3480	6.99
LMC339K	8.95	LM2211	2.75	MC3486	1.89
LMC3407-XX	80	LM2240	1.95	MC3487	1.89
LMC3408-XX	1.35	LM2900	1.19	LM3524	1.99
LMC368	45	LM2901	1.19	TDA1170	5.49
LMC376	1.89	LM2917	1.29	TDA1180	5.99
LMC380	95	LM3045	1.19	TL074	1.95
LMC385	95	LM3054	1.99	TL081	75
LMC385	95	LM3054	1.99	TL082	85
LMC385	95	LM3054	1.99	TL084	1.25
LMC385	95	LM3054	1.99	ULN2003	1.19
LMC385	95	LM3054	1.99	ULN2004	1.79
LMC385	95	LM3054	1.99	ULN2001	1.99
LMC385	95	LM3054	1.99	ULN2001	1.99

### 74HC SERIES

74HC00	\$ 25	74HC125	\$ 50	74HC174	\$ 65
74HC02	25	74HC132	50	74HC175	65
74HC04	25	74HC133	50	74HC240	1.29
74HC08	25	74HC136	55	74HC244	1.29
74HC09	25	74HC139	55	74HC245	1.29
74HC10	25	74HC148	75	74HC368	85
74HC11	25	74HC151	85	74HC373	1.29
74HC12	25	74HC153	85	74HC374	1.29
74HC20	25	74HC154	3.75	74HC4020	99
74HC32	25	74HC157	85	74HC4080	99
74HC74	35	74HC161	85	74HC4086	99
74HC85	85	74HC168	1.15	74HC4075	89
74HC112	85	74HC173	85	74HC4078	89

### 7400 SERIES

7400	\$ 18	7474	\$ 35	74157	\$ 65
7402	18	7475	35	74158	65
7404	18	7476	35	74173	65
7405	18	7485	35	74174	65
7408	35	7486	35	74175	65
7407	35	7489	35	74178	65
7408	35	7489	35	74181	1.75
7410	25	7485	35	74189	2.95
7414	35	74121	35	74189	85
7420	25	74123	45	74185	65
7426	25	74125	45	74198	1.65
7427	25	74126	45	74221	75
7436	25	74148	65	74273	1.75
7432	25	74150	1.20	74365	50
7438	25	74151	65	74368	50
7442	30	74153	65	74367	50
7445	85	74154	1.20	74368	50
7447	95				

### 74C CHIPS

74C00	\$ 25	74C154	\$2.85	74C374	\$1.89
74C02	25	74C173	99	74C393	1.19
74C04	25	74C174	99	74C396	1.19
74C08	35	74C175	99	74C312	6.95
74C10	35	74C221	1.25	74C322	3.95
74C14	49	74C240	1.69	74C323	3.95
74C32	35	74C244	1.69	74C329	4.89
74C90	1.19	74C373	1.69	74C332	14.89

Partial Listing Only!!!  
Call us for components...

### 74LS SERIES

74LS00	\$ 19	74LS125	\$ 45	74LS241	\$ 99
74LS02	19	74LS126	49	74LS242	99
74LS03	19	74LS138	45	74LS243	99
74LS04	19	74LS139	45	74LS244	99
74LS05	19	74LS153	50	74LS245	99
74LS06	19	74LS154	1.29	74LS257	69
74LS09	19	74LS157	40	74LS258	69
74LS10	19	74LS158	40	74LS259	69
74LS14	35	74LS161	40	74LS273	99
74LS27	28	74LS163	40	74LS322	1.79
74LS30	25	74LS164	45	74LS323	1.79
74LS32	28	74LS166	49	74LS365	59
74LS47	99	74LS168	99	74LS366	59
74LS73	35	74LS173	49	74LS367	59
74LS74	35	74LS174	49	74LS368	59
74LS75	35	74LS175	49	74LS373	99
74LS76	35	74LS189	3.95	74LS374	99
74LS85	49	74LS190	49	74LS389	99
74LS86	28	74LS191	49	74LS824	1.89
74LS90	45	74LS192	49	74LS829	1.89
74LS93	45	74LS193	49	74LS840	1.89
74LS107	45	74LS195	49	74LS841	1.89
74LS109	45	74LS211	55	74LS870	99
74LS123	49	74LS240	99	74LS888	1.89

### 74F SERIES

74F00	\$ 35	74F153	\$ 59	74F243	\$1.29
74F02	35	74F157	59	74F244	1.29
74F04	35	74F158	59	74F245	1.29
74F06	35	74F161	59	74F251	79
74F10	35	74F162	59	74F258	79
74F11	35	74F163	59	74F280	2.89
74F20	35	74F174	69	74F373	1.89
74F32	35	74F175	69	74F374	1.89
74F64	49	74F181	1.99	74F378	1.99
74F64	49	74F189	2.99	74F380	2.99
74F86	49	74F219	2.99	74F521	2.99
74F109	49	74F240	1.29	74F533	2.99
74F139	49	74F241	1.29	74F534	2.99
74F151	59				

### IC SOCKETS

SOLDER TAIL	HR16S/T	58	22PIN/W/W	1.29	
8PIN/P	HR18S/T	69	24PIN/W/W	1.29	
14PIN/P	HR20S/T	79	28PIN/W/W	1.59	
18PIN/P	HR22S/T	89	40PIN/W/W	1.99	
20PIN/P	HR24S/T	99	88 PIN W/W		
22PIN/P	HR26S/T	1.19	HR8W/W	1.79	
24PIN/P	HR28S/T	1.29	HR14W/W	1.19	
26PIN/P	HR30S/T	1.49	HR16W/W	1.29	
28PIN/P	HR32S/T	1.69	HR20W/W	1.59	
40PIN/P	HR34S/T	2.29	HR22W/W	1.79	
88 PIN	HR36S/T	2.99	HR24W/W	1.99	
HR8S/T	HR38S/T	3.49	HR26W/W	2.29	
HR14S/T	49	HR40S/T	3.99	HR28W/W	2.49

### SPECIAL FUNCTION

VOICE RECOGNITION	16450 - 16 BIT	
CHIP SET	\$49.95	USART
YAMAHA DXY	8250 - 8 BIT	
CHIP SET	29.95	USART
TMS 6100	5832 - CLOCK	3.95
SPEECH CHIP	9.95	58167 - CLOCK
TMS 5200 SPEECH CHIP	7.95	

### CMOS

CD4001	\$ 18	CD4017	\$ 59	CD4047	\$ 65	CD4069	\$ 29	CD4510	\$ 69	CD4543	\$ 89
CD4002	18	CD4018	59	CD4048	75	CD4070	29	CD4511	89	CD4555	99
CD4007	18	CD4020	59	CD4049	29	CD4071	29	CD4512	89	CD4556	99
CD4008	59	CD4024	49	CD4050	39	CD4072	29	CD4518	79	CD4584	69
CD4009	59	CD4025	59	CD4061	39	CD4073	79	CD4519	79	CD14408	6.95
CD4010	29	CD4027	35	CD4052	59	CD4076	85	CD4520	79	CD14410	7.95
CD4011	29	CD4030	29	CD4053	59	CD4081	29	CD4522	79	CD14411	8.95
CD4012	29	CD4040	85	CD4060	1.49	CD4082	29	CD4538	79	CD14412	8.95
CD4013	29	CD4042									





# CHIPCLOCK

10-year clock/calendar IN A CHIP!

Easy plug-in ■ 10-year battery  
Never set date/time again  
No slot needed ■ 100% compatible

**NOW WORKS WITH PS/2**

CHIPCLOCK w/software NOW \$49.00

30-day money-back guarantee

**COMPUQUEST INC.**

801 Morse Ave. ■ Schaumburg, IL 60193

1-800-722-2353

1-312-529-2552 In IL

Circle 49 on Reader Service Card

# PDK51



**The \$595 Solution to 8051  
Product Development**

The PDK51 is a powerful and economical choice for the development of 8051-based systems. The PDK51 is used with an IBM-PC or equivalent and includes:

- SIBEC-II 8052 Basic Microcontroller
- SXA51 Cross Assembler
- ROM-Based Monitor/Debugger
- PROM Programmer
- Power Supplies
- Documentation, Tutorial and More

Call Now! (603) 489-3232



**Binary Technology, Inc.**

Main St., P.O. Box 67, Meriden, NH 03770

## Set up a complete graphics workstation on your PC for under \$100!

PC-PL0T-III graphics terminal emulator software package enables IBM PC's and compatibles to appear to a mainframe as DEC VT-100/200, VT-52, Retrographics VT-640 or Tektronix 4010/4014 and 4027 terminals. The program also provides valuable communication commands and more.

An enhanced version, PC-PL0T-IV, further allows complete Tektronix 4105 terminal emulation.

For more information call 614/882-4786



659-N Park Meadow Rd. Westerville, OH 43081

Circle 175 on Reader Service Card

## DATA ACQUISITION TO GO INTERFACE FOR ANY COMPUTER

**FREE IBM SOFTWARE**



Connects via RS-232. Fully IBM compatible. Built-in BASIC. Stand alone capability. Expandable. Battery Option. Basic system: 16 ch. 12 bit A/D, 2 ch. D/A, 32 bit Digital I/O. Expansion boards available. Direct Bus units for many computers.

(201) 299-1615

P.O. Box 246, Morris Plains, NJ 07950

**ELEXOR**

Circle 93 on Reader Service Card

## A VOICE FOR YOUR PC!

**VOXX** Only \$79<sup>95</sup>



- ▶ Unlimited vocabulary
- ▶ Text-to-speech software included
- ▶ Speaks English text and numbers
- ▶ Also speaks Spanish and Italian
- ▶ 16 different, easy to understand voices
- ▶ Automatic inflection
- ▶ Easy to use with DOS, BASIC, etc...
- ▶ Uses one PC/XT/AT type short slot
- ▶ Better than units costing much more
- ▶ Audio amplifier and speaker included

Add \$3.00 per order for shipping.  
Vt., N.C., Okla., Ill., O., Wisconsin,  
CT. customers add sales tax.  
C.O.D. and \$3.00 extra.  
Canada: shipping to bill  
Overseas add 10%.



(203) 658-1808

**ALPHA Products**  
242-B West Avenue, Danan, CT 06820

Circle 17 on Reader Service Card

## 8051 FAMILY EMULATORS



For info call:

Austria	02 22 38 78 38-0
Australia	02 654 1873
Denmark	02 85 81 11
Finland	See Sweden
France	01 69 412 801
Great Britain	01 464 2586
Israel	03 499034
Korea	02 784 7841
New Zealand	04 886 375
Norway	See Sweden
Portugal	01 83 56 70
Spain	03 217 2340
Switzerland	01 740 41 05
West Germany	08 131 16 87
Sweden	040 92 24 25
USA	408 866 1820

**NOHAU** CORPORATION  
51 E Campbell Ave #107E  
Campbell CA 95008  
(408) 866-1820

Circle 191 on Reader Service Card

## 16-BIT RESOLUTION ANALOG-TO-DIGITAL CONVERTER

12,000 SAMPLES/SEC  
for IBM PC, XT & AT  
SINGLE PIECE PRICE  
\$475

We manufacture a broad line of data acquisition and control hardware and software for Apple and IBM computers.

Call for quotes on custom hardware or complete systems.

**LAWSON LABS, INC.**

5700 RAIBE ROAD  
COLUMBIA FALLS, MT 59912  
800-321-5355 or 408-387-5355



Circle 145 on Reader Service Card

## Satellite Communication MICROSAT II Expansion Board

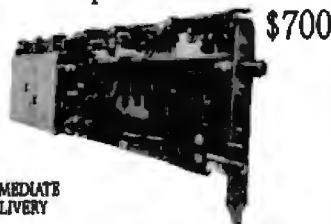

IMMEDIATE  
DELIVERY

- For IBM PC/XT/AT and compatible.
- Satellite data receiver - 9600 baud.
- Satellite bulletin board.
- Satellite video and audio option - Add \$200

PERSONAL SPACE COMMUNICATIONS

707 Johnson Road, Blaine WA 98230

(504)597-6298 TLX 04-508306 FAX (504)597-6214

Circle 208 on Reader Service Card

## REAL WORLD I/O For PC/XT/ATs



DG24 • 24-line digital I/O; 10 Mhz 8255	\$95
AD500 • 8 channel 12-bit (plus sign) integrating A/D; programmable gates of 1, 10, & 100. Hi-Z input and 7 digital lines	\$239
AD100 • Single channel version of AD500 with 10 digital lines.	\$149
AD200 • 4 channel, 125 nS, 12-bit A/D board.	\$239
ADA300 • 8 channel, 25 nS, 8-bit A/D; single D/A; 24 TTL I/O lines (10 Mhz 8255)	\$239
DA600 • Fast settling dual 12-bit D/A.	\$169
PD200 • Prototype/development board with address decoder, buffer, 100+ page applications/project manual.	\$99
XB40 • External connection/prototype board with cable.	\$49

All boards include BASIC, Pascal, C, and Fortran drivers. 30 day return; 1 year warranty. Call for "Real World Interfacing" application notes.

**Real Time Devices, Inc.**

P.O. Box 906 State College, PA 16804  
(814) 234-8087

Circle 234 on Reader Service Card

# California Digital

17700 Figueroa Street • Carson, California 90248



**Color Monitor**  
Better Than **EGA**  
\$1095 **\$289**

Ideal for CAD/CAM and Desk Top publishing applications. The Roland CD-240 color monitor has a resolution of 720 pixels by 400 lines on a 311mm dot pitch 12 non-glare screen. VGA specifications in last mode EGA in graphic mode. Comparable monitor and card packages retail at over \$1095. California Digital has made a special purchase and is able to offer the CD-240 and 132 column VGA/EGA graphic card for only \$389.

**20" Analog Color**  
\$1095 **\$659**



Ever try gathering a classroom of students around a 12 inch monitor? The 20 inch analog RGB monitor is the ideal solution. High screen resolution of 1200 pixels by 950 lines allow extra line detail without the dots looking like golf balls. 256 colors and VGA compatible. Super value originally sold for over \$2000. Only 350 available.

**40 Meg. Tape Back-up**  
\$699 **\$239**

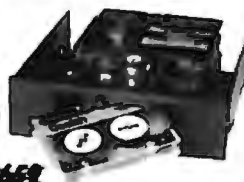

Head Crash, Power Spikes or just poor disk maintenance... Don't loose data because you didn't back up. The ALL/40 is an inexpensive way to save and restore files in the event that your data has been destroyed. This 40 megabyte half height tape back is manufactured by North America's largest producer of data retrieval equipment. No need to purchase a separate tape controller. The ALL/40 attaches directly to your existing floppy disk controller. Supplied software allows your computer to back up any time Day or Night. Come back in the morning and 40 megabytes of irreplaceable data has been stored on one Scotch DC/2000 data cassette. Back up entire hard disk, modified files only, or by file name. Loss of data is inevitable but when you are backed up on an ALL/40 it's not a catastrophe.

**Hitachi 11 by 17 Plotter**  
\$895 **\$695**



The Hitachi 872/XD is a four color 11 by 17 (B size) plotter with superior accuracy and repeatability (.3mm). The 872 accepts HPGL 7475 commands and is both Centronics parallel and RS232C compatible. The 872 plots at a fast eight inches per second in axial direction and eleven inches at an angle of 45 degrees. The plotter also features a self contained digitizing function that allows data to be entered into your computer from printed graphs and blue prints. Four different color pens are supplied with the plotter but a wide variety of technical pens are available.

**\$119**  
**2400 Baud Modem**



2400 baud with forward error correcting make the Maxon MAX/2400 an unbelievable value at only \$119. Fully compatible with the Hayes command set and CCITT V.22 standards. Error correcting, autobauding and "adaptive equalization" allow the MAX/2400 to maintain reliable data transmission over marginal phone lines. Manufactured by Maxon Systems, one of the World's largest producers of consumer electronics. Originally priced at \$295. While supplies last California Digital is offering the MAX/2400 at only \$119.

**Smarteam 2400**



The Smarteam 2400 offers all the features of the Hayes Smart Modem 2400 for a fraction of the price. Now is your opportunity to purchase a 2400 baud modem for only \$219. Also available: The MiniTeam 1200 at only \$129.

**MODEMS**

Avalex 1200E external, Hayes compatible	...	999
CTS 1200 baud modem	.....	89
Hayes Smartmodem 2400 baud modem	.....	529
Smarteam 2400 Hayes Compatible	.....	259
Smarteam 1200 Hayes Compatible, 3000/1200	.....	119
Smarteam 1200B IBM 1200 baud card	.....	119
Ultralink 1200 data and voice, Bus 202	.....	89
U.S. Robotics 2400 baud Direct, internal	.....	199
U.S. Robotics 9600 bps Courier HST	.....	799
Signatman Mark VI, 300 baud internal PC	.....	35

**Television Terminal**  
**\$59**



The Quick Line 300 gives you an instant line to any data base. Such as Dow Jones, Western Union or the Bureau. The Quick Line has four user programmable sign-on keys, allowing the operator with only one key stroke to dial the data base, log on and give the password. All this information is permanently stored in non-volatile RAM. Features include video output to television or monitor, auto dial, auto-log, full sized keyboard, 200 baud modem and 1020 baud auxiliary printer port.

**Dragon Computer**  
\$395 **\$89**



Competes with most Radio Shack Color Computer software. Manufactured by the Taro Corp. under license of the British Broadcasting Company. The Dragon comes complete with 64K byte of memory, serial modem port along with a printer interface. The unique microcomputer features Motorola's advanced 8800E microprocessor and comes standard with Microdot Color Basic, data base manager and a complete word processing package. The computer outputs color composite video along with R.F. video that allows the user to be used in conjunction with any color television.

**21 Megabyte Gold Card**



**\$379**

The Gold Card from Silicon Valley Computers features shock mounted automatic head unloading, 15 watt drive coupled with a 2K/byte sector buffer and advanced OMTI controller for maximum reliability. 30,000 hour MTBF and full 2 year warranty - the best cost per megabyte hardcard available. Also available the 30 Meg. Gold Card at only \$419.

**NEC/8500 Laptop**  
\$395 **\$319**



The NEC PC-8500 laptop computer incorporates a 25 line liquid crystal display and modem that plugs directly into any RJ-11 wall jack. An auto log-on feature instructs the 8500 to phone the users host computer and automatically send password and log-on information. The computer also includes both serial and Centronics parallel ports packaged in the six pound laptop. This is the ideal computer for Resellers, insurance people or any individual that requires immediate access to remote information. ROM based telecommunication software, spreadsheet and Wordstar also make the 8500 a great computer for students. Files can be transferred from this CP/M computer to any other including the IBM/PC.

**40 Megabyte Hard Disk Kit**

Forty megabyte internal hard disk drive, controller and cables all for only \$397. The kit includes the a 40 mlt-second Miniscribe 3650 drive and a half slot Western Digital controller.

**\$397**



	One	Two	Ten
TEC501 1/2 height sgl.sided	49	39	35
TANDON 85L/2 360K, 1/2 ht.	79	75	72
TANDON 101/4 full ht. 96 TPI.	99	89	79
FUJITSU 5 1/4" half height	85	89	82
MITSUBISHI new 501 half ht.	119	109	106
MITSUBISHI 504A AT comp.	149	139	135
TEAC FD55BV half height	109	99	89
TEAC FD55FV 96 TPI, half ht.	119	109	106
TEAC FD55GF for IBM AT	149	139	135
PANASONIC 455 Half Height	109	99	89
PANASONIC 475 1.2 Meg./96	119	115	109
Switching power supply			49
Dual enclosure for 5 1/4" drives			89

**3 1/2" DISK DRIVES**

SONY MP-53W 720K/Byte	129	125	119
SONY MP-73W, 2 Meg.	159	149	call
TEAC 35FN 720 K/Byte	129	119	115
TEAC 35HN/30, 2 Meg.	159	149	145
5 1/4" form factor kit			20

**8" DISK DRIVES**

QUME 842 double sided	189	179	175
QUME 841 single sided	119	109	99
SHUGART 851R dbl. sided	319	309	299
REMX RFD4000 dbl. sided	189	179	165
OLIVETTI 851	189	179	165

**Heath H/89 Computer**  
**\$179**



Hard to believe... but we found a stash of brand new Zenith/Heath Model H/89 computers. These computers feature the Zilog Z-80 CPU and operate under CP/M. The unit incorporates a 12 inch green screen, three serial ports and one 5 1/4" disk drive. Zenith's original price was \$1895. We have 350 units available for sale, while supplies last we are offering the H/89 at only \$179. Word processing and communication software included.

## Catalog

Best of all it's FREE... almost. California Digital's Fall catalog is now available. Rather than indiscriminately just giving them away, we are asking that a \$5.00 contribution be made to one of the following charitable organizations.

American Cancer Society  American Heart Assoc  American Red Cross

For your generosity, you will receive California Digital's color catalog offering over 3000 computer related products. You will also receive a \$5.00 credit certificate that may be applied toward any merchandise offered by California Digital. See it's almost free. Please make your check (do not send cash) payable to the charitable organization.

Name \_\_\_\_\_  
Address \_\_\_\_\_  
City/Zip \_\_\_\_\_

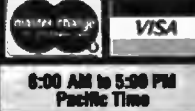

Every year since 1973, customers from virtually every nation in the free World have chosen California Digital for their data processing requirements. If its computer, California Digital has it... complete minisystem or just one microchip. California Digital offers over 10,000 unique computer products. Regardless of how specialized your data processing requirements... California Digital is your one stop shopping solution.

TECHNICAL & CALIFORNIA  
**(213) 217-0500**  
TOLL FREE ORDER LINE  
**(800) 421-5041**





# JDR Microdevices

Complete customer satisfaction... superior service... friendly, knowledgeable personnel  
quality merchandise... providing the best values in leading edge technology.

### STATIC RAMS

2112	256x4	(450ns)	2.00
2114	1024x4	(450ns)	1.99
2114L 2	1024x4	(200ns)(LOW POWER)	1.99
TM82016 100	2048x8	(100ns)	1.99
HM8115 4	2048x8	(150ns)(CMOS)	2.29
HM8116 3	2048x8	(150ns)(CMOS)	2.06
HM8116L 4	2048x8	(200ns)(CMOS)(LP)	4.29
HM8116L 3	2048x8	(150ns)(CMOS)(LP)	4.00
HM8116L 2	2048x8	(120ns)(CMOS)(LP)	5.40
HM8264LP 15	8192x8	(150ns)(CMOS)(LP)	6.40
HM8264LP 12	8192x8	(120ns)(CMOS)(LP)	8.00
HM83256LP 15	32768x8	(150ns)(CMOS)(LP)	14.00
HM83256LP 12	32768x8	(120ns)(CMOS)(LP)	14.00
HM83256LP 10	32768x8	(100ns)(CMOS)(LP)	18.00

### DYNAMIC RAMS

4116 250	16384x1	(250ns)	4.00
4116 200	16384x1	(200ns)	3.00
4116 150	16384x1	(150ns)	3.00
4116 120	16384x1	(120ns)	1.40
MM4332	32768x1	(200ns)	3.00
4184 150	65536x1	(150ns)	2.00
4184 120	65536x1	(120ns)	3.10
MC80665	65536x1	(200ns)	1.90
TM84164	65536x1	(150ns)	1.00
4184 REFRESH	65536x1	(150ns)(PIN 1 REFRESH)	2.00
TM84416	16384x4	(150ns)	3.75
41128 150	131072x1	(150ns)	6.00
TM84484 15	65536x4	(150ns)	7.00
41256 150	262144x1	(150ns)	12.40
41256 120	262144x1	(120ns)	12.00
41256 100	262144x1	(100ns)	12.40
HM85125A 100	262144x1	(100ns)(CMOS)	6.00
1 MB-120	1048576x1	(120ns)	34.00
1 MB-100	1048576x1	(100ns)	37.00

### EPROMS

2708	1024x8	(450ns)(25V)	4.00
2716	2048x8	(450ns)(25V)	3.40
2716-1	2048x8	(350ns)(25V)	3.00
TM82532	4096x8	(450ns)(25V)	5.00
2732	4096x8	(450ns)(25V)	3.00
2732A	4096x8	(250ns)(21V)	3.00
2732A-2	4096x8	(200ns)(21V)	4.25
27C44	8192x8	(250ns)(12.5V CMOS)	6.00
2784	8192x8	(450ns)(12.5V)	3.00
2784-250	8192x8	(250ns)(12.5V)	3.00
2784-200	8192x8	(200ns)(12.5V)	4.25
MC80678	8192x8	(350ns)(21V)(24 PIN)	15.00
27128	16384x8	(250ns)(12.5V)	4.25
27C264	32768x8	(250ns)(12.5V CMOS)	7.00
27264	32768x8	(250ns)(12.5V)	5.00
27812	65536x8	(250ns)(12.5V)	11.00
27C512	65536x8	(250ns)(12.5V CMOS)	12.00

MEMORY PRICES SUBJECT TO CHANGE DUE TO MARKET CONDITIONS PLEASE CALL TO CONFIRM PRICES

### 6500

6502	1.0 MHz	2.25
65C02 (CMOS)	7.00	
6520	1.00	
6522	2.00	
6526	13.00	
6532	6.00	
6546	2.00	
6551	2.00	

### 8.0 MHz

65G2A	2.00
65J20A	2.00
65J22A	5.00
65A4A	1.00
65E1A	4.00

### 3.0 MHz

6502B	4.25
-------	------

### 6800

6800	1.00
6802	2.00
6803	3.00
6805	2.00
6809E	2.00
6810	1.00
6820	2.00
6821	1.00
6840	3.00
6842	4.00
6844	6.00
6845	2.75
6847	4.75
6849	1.00
68B3	22.00

### 2.0 MHz

68B00	2.00
68B02	3.00
68B04	5.40
68B06	5.00
68B21	1.00
68B45	4.00
68B60	1.75
68B00	0.95

### Z-80

Z80 CPU	1.25
Z80A-CTC	1.60
Z80A-DART	5.00
Z80A-DMA	5.00
Z80A-PHO	1.00
Z80A-SIO 0	5.00
Z80A-SIO 1	5.00
Z80A-SIO 2	5.00

### 6.0 MHz

Z80B-CPU	2.75
Z80B-CTC	4.25
Z80B-PHO	4.25
Z80B-DART	6.00
Z80B-SIO 0	12.00
Z80B-SIO 2	12.00
Z8671 Z80C	5.00

### CLOCK CIRCUITS

MM58167	3.00
MM58174	0.95
MS4932	2.00

### BIT RATE GENERATORS

MC14411	3.00
BR1941	4.00
4702	0.95
COM8116	8.00

### INTERSIL

KCL7106	5.00
KCL7107	10.00
KCL7660	1.00
KCL8038	3.00
KCM7207A	5.00
ICM7208	15.00

### DISK CONTROLLERS

1771	4.00
1791	5.00
1793	9.00
1795	12.00
1797	12.00
2791	12.00
2793	15.00
2797	20.00
8272	4.30
UPD765	4.30
MS8876	12.00
MS8877	12.00
1691	6.00
2143	6.00
3216	6.20

### UARTS

AY51013	3.00
AY31015	4.00
TR1602	3.00
7651	4.00
IM6402	3.00
IM6403	3.00
MS8250	5.00
NS16450	10.00

### MISC.

ADC0804	2.00
ADC0809	3.00
DAC0800	3.20
DAC0808	1.00
DAC1022	5.00
MC1406LB	1.00
BT28	1.20
BT57	5.00
DP8304	2.20
9334	1.75
9368	2.85
9602	6.00
ULN2003	7.00
MAX232	1.00
MC3470	7.00
MC3487	2.00
AYS-3600 PRO	11.00

## HIGH-TECH SPOTLIGHT 1 MB EPROMS

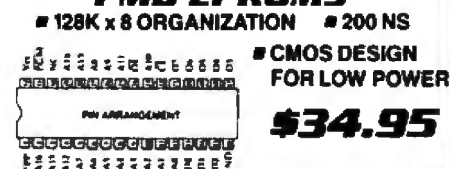

**\$34.95**

### 8000

8031	3.00
8035	1.40
8039	3.00
8082AH BASIC	34.00
8080	2.40
8085	1.00
8086	6.40
8088	5.00
8088 2	7.00
8155	2.40
8155 2	3.00
8741	9.00
8748	7.00
8755	14.00

### 8200

8203	14.00
8205	3.20
8212	1.40
8216	1.40
8224	2.20
8227	4.20
8274	4.00
8275	16.00
8278	2.40
8279	1.00
8282	3.00
8283	3.00
8284	3.00
8286	3.00
8287	3.00
8288	4.00

### MATH COPROCESSORS

8087	5 MHz	\$99.95
8087-2	8 MHz	\$159.95
8087-1	10 MHz	\$229.95
80287	6 MHz	\$179.95
80287-8	8 MHz	\$249.95
80287-10	10 MHz	\$309.95
80387-16	16 MHz	\$499.95
80387-20	20 MHz	\$799.95

### 74LS00

74LS00	16	74LS112	29	74LS241	69
74LS01	18	74LS122	45	74LS242	69
74LS02	17	74LS123	49	74LS243	69
74LS03	18	74LS125	2 75	74LS244	69
74LS04	16	74LS125	39	74LS245	79
74LS05	18	74LS126	39	74LS251	49
74LS08	18	74LS132	39	74LS253	49
74LS09	18	74LS133	49	74LS257	39
74LS10	16	74LS136	33	74LS258	49
74LS11	27	74LS138	33	74LS259	1 29
74LS12	22	74LS139	39	74LS260	49
74LS13	26	74LS145	99	74LS266	39
74LS14	39	74LS147	99	74LS273	79
74LS15	26	74LS148	99	74LS279	39
74LS16	17	74LS151	39	74LS280	1 99
74LS17	22	74LS153	39	74LS283	59
74LS18	22	74LS154	1 49	74LS286	99
74LS19	23	74LS155	59	74LS293	39
74LS20	26	74LS156	49	74LS299	1 49
74LS21	17	74LS157	36	74LS322	3 95
74LS22	18	74LS158	29	74LS323	2 49
74LS23	28	74LS160	29	74LS365	39
74LS24	26	74LS161	39	74LS367	39
74LS25	29	74LS162	39	74LS368	79
74LS26	75	74LS164	49	74LS374	95
74LS27	85	74LS165	65	74LS375	95
74LS28	17	74LS166	55	74LS377	75
74LS29	29	74LS169	95	74LS390	1 19
74LS30	24	74LS173	49	74LS393	75
74LS31	29	74LS174	1 49	74LS401	1 49
74LS32	29	74LS175	39	74LS524	1 95
74LS33	49	74LS191	49	74LS640	99
74LS34	49	74LS192	69	74LS645	99
74LS35	22	74LS193	69	74LS670	89
74LS36	39	74LS194	69	74LS682	3 20
74LS37	49	74LS195	69	74LS688	2 40
74LS38	29	74LS196	59	74LS702	22 00
74LS39	29	74LS197	59	74LS751	2 40
74LS40	49	74LS198	59	74LS752	2 40
74LS41	26	74LS221	59	2SL2521	2 00
74LS42	26	74LS221	59	2SL31	1 95
74LS43	26	74LS221	59	2SL52	1 95

### 7400

7400	15
7402	15
7404	15
7406	29
7407	29
7408	24
7410	15
7411	15
7414	49
7416	25
7417	25
7420	15
7430	15
7432	29
7438	29
7442	89
7446	89
7447	89
7473	34
7474	34
7475	45
7476	38
7483	50
7485	59
7486	59
7487	2 15
7490	39
7493	35
74121	25
74122	49
74125	45
74150	1 35
74151	35
74153	35
74154	1 40
74157	55
74159	1 65
74161	65
74164	85
74166	1 00
74175	89
74367	65

### LINEAR

LM567	75
NE570	2 95
NE592	1 95
LM723	49
LM733	98
LM741	29
LM742	69
LM743	1 30
MC1350	1 15
LM1458	35
LM1488	45
LM1489	45
LM1496	85
ULN2003	75
XR2206	3 95
XR2211	2 95
MC1370	1 95
CA3046	85
CA3146	1 29
MC1373	1 29
MC1374	1 95
MC3480	8 95
MC3487	2 95
LM3900	4 25
LM3911	2 49
LM3909	5 00
LM3914	1 89
MC4024	3 49
MC4084	3 99
MC4188	1 25
MC4558	65
MC4604	1 25
MC4608	1 25
MC4609	1 25
MC4615	1 25
MC4616	1 25

### CAPACITORS

TANTALUM			
1.0µ	15V	12	1.0µ 35V 45
6.8	15V	42	2.2 35V 19
10	15V	45	4.7 35V 39
22	15V	99	10 35V 68
DISC			
10µ	50V	05	001µ 50V 05
22	50V	05	005 50V 05
33	50V	05	01 50V 07
47	50V	05	08 50V 07
100	50V	05	1 12V 10
220	50V	05	1 50V 12

### MONOLITHIC

01µ	50V	14	1µ 50V 18
047µ	50V	18	.47µ 50V 25

### ELECTROLYTIC

RADIAL		AXIAL	
1µ	25V	14	1µ 50V 14
4.7	50V	11	10 50V 18
10	50V	11	22 16V 14
47	35V	13	47 50V 19
100	16V	15	100 35V 13
220	25V	20	470 50V 29
470	25V	30	1000 16V 29
2200	16V	70	2200 16V 70
4700	25V	145	4700 16V 125

### BYPASS CAPACITORS

01µ	CERAMIC DISC	100	45	00
01µ	MONOLITHIC	100	50	00
1µ	CERAMIC DISC	100	40	50
1µ	MONOLITHIC	100	52	50

### "SNAPABLE" HEADERS

CAN BE SNAPPED APART TO MAKE ANY SIZE HEADER, ALL WITH .1" CENTERS

1x40	STRAIGHT LEAD	.99
1x40	RIGHT ANGLE LEAD	.49
2x40	2 STRAIGHT LEADS	2.49
2x40	2 RIGHT ANGLE LEADS	2.99

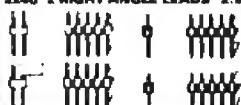

### VOLTAGE REGULATORS

7805T	49	7812K	1.39
7805T	49	7805K	1.69
7812T	49	7812K	1.49
7815T	49	78L05	.49
7905T	59	78L12	.49
7908T	59	78L06	.68
7812T	59	78L12	1.49
7815T	59	LM223K	4.79
7805K	1.59	LM238K	6.99

### DISCRETE

1N751	15	4N28	.69
1N4148 25	1.49	4N33	.89
1N4004 10	1.19	4N37	1.19
1N5402	.25	MCT-2	.59
KBP02	.56	MCT-6	1.29
2N2222	25	TIL-111	.99
PN2222	10	2N3906	10
2N2907	25	2N4401	.25
2N3055	79	2N4402	.25
2N2904	10	2N4403	.25
4N25	.69	2N6048	1.75
4N27	.59	TIP31	.49

### SOLDER STATION

- ADJUSTABLE HEAT SETTING WITH TIP TEMPERATURE READOUT
- REPLACEMENT TIPS AVAILABLE \$2.95

**\$49.95**



### WIREWRAP PROTOTYPE CARDS

FR-4 EPOXY GLASS LAMINATE WITH GOLD PLATED EDGE-CARD FINGERS SILK SCREENED LEGENDS, MOUNTING BRACKETS INCLUDED



### FOR PS/2

JDR-PR32	32 BIT PROTOTYPE CARD	98.95
JDR-PR16	16 BIT CARD WITH I/O DECODING LAYOUT	48.95
JDR-PR16PK	PARTS KIT FOR JDR-PR16 ABOVE	15.95
JDR-PR16V	16 BIT CARD FOR VIDEO APPLICATIONS	28.95

### FOR AT

JDR-PR10	16 BIT CARD WITH I/O DECODING LAYOUT	34.95
JDR-PR10PK	PARTS KIT FOR JDR-PR10 ABOVE	12.95

### FOR XT

IBM-PR1	WITH +5V AND GROUND PLANE	27.95
IBM-PR2	AS ABOVE WITH I/O DECODING LAYOUT	29.95

### RESISTOR NETWORKS

SIP	10 PIN	8 RESISTOR	59
SIP	8 PIN	7 RESISTOR	59
DIP	16 PIN	8 RESISTOR	1.09
DIP	16 PIN	15 RESISTOR	1.09
DIP	14 PIN	7 RESISTOR	99
DIP	14 PIN	13 RESISTOR	99

### SHORTING BLOCKS



### EXTENDER CARDS

FOR PROTOTYPE DEBUGGING AND TROUBLESHOOTING

EXT-8008	FOR XT SYSTEM	29.95
EXT-8028	FOR AT SYSTEM	39.95
EXT-16	MICROCHANNEL 16-BIT	69.95
EXT-32	MICROCHANNEL 32-BIT	99.95

### SOLDERLESS BREADBOARDS

WBU-D	100 TIE PTS.	2.95	WBU-204	1680 TIE PTS.	24.95
WBU-T	630 TIE PTS.	6.95	WBU-206	2390 TIE PTS.	29.95
WBU-204-3	1360 TIE PTS.	17.95	WBU-206	3220 TIE PTS.	39.95



### IDC CONNECTORS/RIBBON CABLE

DESCRIPTION	ORDER BY	CONTACTS					
		10	20	26	34	40	50
SOLDER HEADER	IDMxxS	.82	1.29	1.68	2.20	2.58	3.24
RIGHT ANGLE SOLDER HEADER	IDMxxSR	.85	1.35	1.78	2.31	2.72	3.39
WIREWRAP HEADER	IDMxxW	1.89	2.98	3.84	4.50	5.28	6.63
RIGHT ANGLE WIREWRAP HEADER	IDMxxWR	2.05	3.28	4.22	4.65	4.80	7.30
RIBBON HEADER SOCKET	IDRxx	.43	.89	.95	1.29	1.49	1.69
RIBBON HEADER	IDMxx	---	5.50	6.25	7.00	7.50	8.50
RIBBON EDGE CARD	IDRxx	.85	1.25	1.35	1.75	2.05	2.45
10' GREY RIBBON CABLE	RCxx	1.80	3.20	4.10	5.40	6.40	7.80

FOR ORDERING INSTRUCTIONS SEE D-SUBMINIATURE CONNECTORS BELOW

### 3 VOLT LITHIUM BATTERY HOLDER \$1.95



### SPECTRONICS CORPORATION EPROM ERASERS

Model	Turner	Chip Capacity	Intensity (µW/cm²)	Unit Cost
PE 140	NO	9	8,000	689
PE 140T	YES	9	8,000	1,129
PE 240T	YES	12	9,600	1,189



### D-SUBMINIATURE CONNECTORS

DESCRIPTION		ORDER BY	CONTACTS					
			8	14	16	20	25	37
SOLDER CUP	MALE	DBxxP	.46	.59	.69	.69	1.39	1.89
	FEMALE	DBxxS	.48	.69	.75	.75	1.39	2.29
RIGHT ANGLE PC SOLDER	MALE	DBxxPR	.49	.69	---	.78	2.27	---
	FEMALE	DBxxSR	.55	.78	---	.85	2.49	---
WIREWRAP	MALE	DBxxPW	1.69	2.86	---	3.89	5.60	---
	FEMALE	DBxxSW	2.78	4.27	---	6.84	9.95	---
IDC RIBBON CABLE	MALE	IDRxxP	1.39	1.99	---	2.25	4.25	---
	FEMALE	IDRxxS	1.45	2.08	---	2.35	4.48	---
HOODS	METAL	RMH000xx	1.05	1.15	1.25	1.25	---	---
	GREY	HOODxx	.39	.39	---	.39	.69	.78

ORDERING INSTRUCTIONS: INSERT THE NUMBER OF CONTACTS IN THE POSITION MARKED \*\* OF THE ORDER BY PART NUMBER LISTED. EXAMPLE: A 15 PIN RIGHT ANGLE MALE PC SOLDER WOULD BE DB15PR

**MOUNTING HARDWARE 59¢**

### IC SOCKETS/DIP CONNECTORS

DESCRIPTION	ORDER BY	CONTACTS								
		8	14	16	18	20	22	24	28	40
SOLDERTAIL SOCKETS	xxST	11	11	12	15	18	15	20	22	30
WIREWRAP SOCKETS	xxWW	.69	.69	.69	.99	1.09	1.39	1.49	1.69	1.99
DIP SOCKETS	25Fxx	---	4.95	---	5.95	---	5.95	6.95	9.95	---
TOOLED SOCKETS	AUGATxxST	.62	.79	.85	1.09	1.29	1.39	1.49	1.69	2.49
TOOLED W/W SOCKETS	AUGATxxWW	1.30	1.90	2.10	2.40	2.50	2.90	3.15	3.70	5.40
COMPONENT CARRIERS	ICCxx	.49	.59	.69	.99	.99	.99	1.09	1.49	1.49
DIP PLUGS (IDC)	IDPxx	.95	.59	.59	1.29	1.49	---	---	1.49	1.59

FOR ORDERING INSTRUCTIONS SEE D-SUBMINIATURE CONNECTORS ABOVE

### GENDER CHANGERS

FOR 25 PIN D-SUBMINIATURE CONNECTORS

GENDER-FF	FEMALE-MALE	7.95
GENDER-MM	MALE-MALE	7.95
GENDER-MF	MALE-FEMALE	7.95
GENDER-MM	MULL MOODER	8.95
GENDER-JB	JUMPER BOX	8.95
GENDER-MT	MMITESTER	14.95



### DATABASE

- ERASES 2 EPROMS IN 10 MINUTES
- VERY COMPACT, NO DRAWER
- THIN METAL SHUTTER PREVENTS UV LIGHT FROM ESCAPING

**\$34.95**



### JOYSTICK

- SET X-Y AXIS FOR AUTO CENTER OR FREE MOVEMENT
- FIRE BUTTON FOR USE WITH GAME SOFTWARE
- ADAPTOR CABLE FOR IBM, APPLE II

**\$19.95**



JDR MICRODEVICES, 110 KNOWLES DRIVE, LOS GATOS, CA 95030  
LOCAL (408) 866-6200 FAX (408) 378-8927 TELEX 171-110



RETAIL STORE: 1256 SOUTH BASCOM AVE., SAN JOSE, CA (408) 947-8881  
HOURS: M-F 10-7 SAT. 9-5 SUN. 12-4



**ORDER TOLL FREE 800-538-5000**

COPYRIGHT 1988 JDR MICRODEVICES

CONTINENTAL U.S. AND CANADA



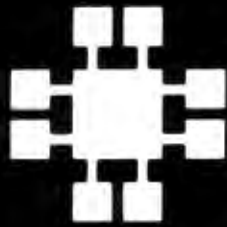

# JDR Microdevices®

Complete customer satisfaction...superior service...friendly, knowledgeable personnel  
quality merchandise...providing the best values in leading edge technology.

## PROMETHEUS 2400 BAUD MODEM \$129.95 NEW LOW PRICE!



IT'S TIME TO TRADE UP NOW THAT JDR BREAKS THE PRICE BARRIER ON 2400 BAUD MODEMS

- AUTO DIAL ANSWER
- SELF TEST ON POWER UP
- TOUCHTONE OR PULSE DIALING
- HAYES & BELL SYSTEMS COMPATIBLE
- FULL OR HALF DUPLEX
- MIRROR II COMMUNICATIONS SOFTWARE INCLUDED

MCT-241  
MCT-121 1200 BAUD 1/2 CARD \$ 69.95

**EXTERNAL MODEMS**

MCT-12E 1200 BAUD \$ 99.95  
MCT-24E 2400 BAUD \$169.95



## DIABLO PRINTER \$279.95

- LETTER QUALITY AT 20 CPS 132 COLS
- 10 12 15 PITCH & PROPORTIONAL SPACING
- SERIAL & PARALLEL INTERFACE
- AUTO PAPER LOAD FRICTION FEED
- FULL XEROX WARRANTY



## CENTRONICS LASER \$1195 PRINTER

NEAR TYPESET QUALITY  
AFFORDABLE AT LAST

- 8 PAGES PER MINUTE • 300 DPI RESOLUTION
  - 1 YEAR WARRANTY • CHOICE OF EMULATION BOARDS
- MULTI-PRINTER EMULATION BOARD:**  
EPSON FX 80 EMULATION NOTHING ELSE REQUIRED  
IBM PC GRAPHICS PROPRINTER & DIABLO 630  
EMULATION REQUIRES ADDITIONAL FONT CARD
- HP LJ+ EMULATION BOARD:**  
HP LASERJET EMULATION 3 RESIDENT FONTS &  
2 PITCHES ADDITIONAL FONT CARD AVAILABLE
- 1.5MB RAM CARD \$139.95  
EXTRA FONT CARDS \$199.95  
TONER CARTRIDGES \$59.95  
PFS FIRST PUBLISHER \$99.95

## VGA COMPATIBLE PACKAGE \$649.00

MONITOR  
& CARD  
TOGETHER



- 800 X 560 MAXIMUM RESOLUTION
- 640 X 480 IN 16 COLORS
- 320 X 200 IN 256 COLORS
- IBM STYLE ANALOG MONITOR
- FULLY VGA EGA CGA Hercules & MONOCHROME COMPATIBLE



**NEC MULTISYNC \$599.95**  
• ORIGINAL CGA EGA VGA COMPATIBLE MONITOR  
• AUTO FREQUENCY ADJUSTMENT  
• RESOLUTION AS HIGH AS 800 X 560

**CASPER EGA \$399.95**  
• 15.75 21.85 KHZ SCANNING FREQUENCIES  
• 640 X 200 350 RESOLUTION • 31 MM DOT PITCH  
• 14 BLACK MATRIX SCREEN • 16 COLORS

**CASPER RGB \$279.95**  
• COLOR GREEN AMBER SWITCH • 39MM DOT PITCH  
• 640 X 240 RESOLUTION • 14 NON GLARE SCREEN  
• RGB IBM COMPATIBLE • CABLE INCLUDED

**SAKATA MONOCHROME \$69.95**  
• IBM COMPATIBLE TTL INPUT  
• 12 NON GLARE SCREEN  
• CABLE FOR IBM PC INCLUDED

**SAMSUNG MONOCHROME MONITOR \$129.95**

### MONITOR STANDS

**MODEL MS-100 \$12.95**  
• TILTS AND SWIVELS  
• STURDY PLASTIC CONSTRUCTION

**MODEL MS-200 \$39.95**  
• TILTS AND SWIVELS • BUILT IN SURGE SUPPRESSOR  
• INDEPENDENTLY CONTROLS UP TO 5 AC OUTLETS

## COMPUTER CASES

ATTRACTIVE STURDY STEEL CASES FIT THE POPULAR SIZED MOTHERBOARDS AND INCLUDE SPEAKERS FACEPLATES EXPANSION SLOTS FRONT PANEL KEYLOCKS LED INDICATORS AND ALL NECESSARY HARDWARE



CASE-FLIP FOR 8088 MOTHERBOARDS \$34.95  
CASE-SLIDE FOR 8088 MOTHERBOARDS \$39.95  
CASE-286 FOR 286 MOTHERBOARDS \$89.95  
CASE-JR FLIP-TOP FOR MINI 286 \$149.95  
• INCLUDES 150 WATT POWER SUPPLY

## POWER SUPPLIES

**PS-135 135 WATT \$59.95**  
• UL APP 135 WATTS  
• 5V 15A • 12V 4.2A  
5V 5A 12V 5A

**PS-150 150W MODEL \$69.95**

**PS-200 200 WATT \$89.95**  
• 200 WATTS  
• 5V 22A • 12V 8A  
5V 5A 12V 5A



## KEYBOARDS

FULL ONE YEAR WARRANTY

**MCT-5330 ENHANCED STYLE LAYOUT \$79.95**  
• AUTOSENSE FOR XT OR AT COMPATIBLES  
• LED INDICATORS • AUTO REPEAT FEATURE  
• SEPARATE CURSOR PAD

**MCT-5060 STANDARD LAYOUT \$59.95**  
• SOFTWARE AUTOSENSE FOR XT OR AT COMPATIBLES  
• LED INDICATORS • AUTO REPEAT FEATURE

### MAXI-SWITCH KEYBOARDS

**MCT-5330 ENHANCED STYLE LAYOUT \$84.95**  
• STANDARD ENHANCED KEYBOARD LAYOUT  
• TACTILE FEEDBACK  
• LIGHTED NUM CAPS AND SCROLL LOCK  
• NUMERIC & CURSOR KEYPADS 12 F KEYS

**MAX-5060 STANDARD LAYOUT \$64.95**

## LOGITECH MOUSE \$79.95



PC MAGAZINE'S EDITORS CHOICE  
ALL MODELS HAVE SERIAL SUPPORT (COM1) COM2) 200  
DPI RESOLUTION LOTUS 1 2-3 SHELL SELF INSTALLING  
SOFTWARE AND POINT EDITOR

**SERIAL MOUSE W PC PAINTBRUSH \$99.95**  
**BUS MOUSE W PC PAINTBRUSH \$99.95**  
**BUS MOUSE W PC PAINTBRUSH CAD \$149.95**

## 3.5" FLOPPY DISK DRIVE \$149.95



**1.44 MB 3 1/2" DRIVE**  
• ULTRA HIGH DENSITY  
• ALSO WORKS WITH 720K DISKS

**FDD-1 44 x BLACK FACEPLATE \$149.95**  
**FDD-1 44 x BEIGE FACEPLATE \$149.95**

**720K 3 1/2" FLOPPY DRIVE \$129.95**  
FDD-3 5 x (FORXT)  
FDD-3 5 x (FORAT)

**Seagate**

**NEW!**  
**FAST 40MB DRIVE**  
**\$529.00**

THE NEW ST 251-1 DRIVE IS 30% FASTER WITH AN AVERAGE ACCESS TIME OF 28 MS EASY TO INSTALL HALF-HEIGHT DRIVE

ST-251-1

WITH MCT-HDC CONTROLLER \$589.00  
WITH MCT-AFH CONTROLLER \$639.00

**1/2 HEIGHT DRIVES**

20 MB, 65 MS, ST-225 \$225.00  
WITH MCT-HDC CONTROLLER \$269.00  
WITH MCT-AFH CONTROLLER \$339.00

30 MB RLL, 65 MS, ST-238 \$249.00  
WITH MCT-RLL CONTROLLER \$299.00  
WITH MCT-AFH-RLL CONTROLLER \$389.00

40 MB, 40 MS, ST-251 \$429.00  
WITH MCT-HDC CONTROLLER \$469.00  
WITH MCT-AFH CONTROLLER \$539.00

60 MB RLL, 40 MS, ST-277 \$499.00  
WITH MCT-RLL CONTROLLER \$549.00  
WITH MCT-AFH CONTROLLER \$639.00

**FULL HEIGHT DRIVES**

30 MB, 40 MS, ST-4038 \$559.00  
80 MB, 28 MS, ST-4096 \$895.00

**TEAC DISK DRIVE**

360K 5 1/4" DRIVE  
RELIABLE DIRECT DRIVE MOTOR  
DOUBLE-SIDED/DOUBLE-DENSITY  
FD-558 **\$99.95**



**1/2 HEIGHT FLOPPY DISK DRIVES**

5 1/4" TEAC FD-55G DS-HD 1.2M \$129.95  
5 1/4" FUJITSU M2551A DS-DD 360K \$89.95  
5 1/4" FUJITSU M2553K OS-HD 1.2M \$119.95  
5 1/4" DS-DD 360K \$89.95  
5 1/4" DS-HD-1.2M \$109.95  
3 1/2" MITSUBISHI DS-DD (FOR AT OR XT) \$129.95

**INTERFACE CARDS FROM MODULAR CIRCUIT TECHNOLOGY DISPLAY ADAPTORS**

**MONOCHROME GRAPHICS CARD \$59.95**  
TRUE HERCULES COMPATIBILITY SUPPORTS LOTUS 123  
PARALLEL PRINTER PORT CONFIGURES AS CPT1 OR LPT2  
USES VLSI CHIPS TO ENSURE RELIABILITY  
MCT-MGP

**ENHANCED GRAPHICS ADAPTOR \$149.95**  
100% IBM COMPATIBLE PASSES IBM EGA DIAGNOSTICS  
256K OF VIDEO RAM ALLOWS 640 X 350 IN 16 OF 64 COLORS  
COMPATIBLE WITH COLOR AND MONOCHROME ADAPTORS  
MCT-EGA

**COLOR GRAPHICS ADAPTOR \$49.95**  
COMPATIBLE WITH IBM GRAPHICS STANDARDS  
SUPPORTS RGB COLOR & COMPOSITE MONOCHROME  
640 X 200 RESOLUTION LIGHT PEN INTERFACE  
MCT-CG

**MULTIFUNCTION CARDS**

**MONOGRAPHS MULTI I/O \$119.75**  
TOTAL SYSTEM CONTROL FROM A SINGLE SLOT  
CTRL 2 FLOPPY S SERIAL PARALLEL GAME PORT  
CLOCK CAL RUN COLOR GRAPHICS SOFTWARE ON A MONOCHROME MONITOR  
MCT-MGM10

**MULTI I/O FLOPPY CONTROLLER \$79.95**  
A PERFECT COMPANION FOR OUR MOTHERBOARDS  
SUPPORTS UP TO 2 360K FLOPPIES 720K WITH DOS 3.2  
SERIAL PARALLEL GAME PORT CLOCK CALENDAR  
MCT-MIO  
MIO-SERIAL—2ND SERIAL PORT \$15.95

**MULTI I/O CARD \$59.95**  
USE WITH MCT-FH FOR A MINIMUM OF SLOTS USED  
SERIAL PORT CLOCK CALENDAR WITH BATTERY BACK UP  
PARALLEL PRINTER PORT ADDRESSABLE AS LPT1 OR LPT2  
MCT-IO

**286/386 MULTIFUNCTION \$139.95**  
ADDS UP TO 3 MB OF RAM TO YOUR AT  
USER EXPANDABLE TO 1.5 MB OR 3 MB WITH OPTIONAL PIGGYBACK BOARD (0 K INSTALLED)  
INCLUDES SERIAL AND PARALLEL PORT  
MCT-AMF-MC PIGGYBACK BOARD \$29.95  
AMF-SERIAL \$24.95

**286/386 MULTI I/O CARD \$59.95**  
USE WITH MCT-AFH FOR MINIMUM OF SLOTS USED  
SERIAL PARALLEL AND GAME PORTS  
USES 16450 SERIAL SUPPORT CHIPS FOR HIGH SPEED OPS  
MCT-AIO  
AIO-SERIAL—2ND SERIAL PORT \$24.95

**MEMORY CARDS**

**576K RAM CARD \$59.95**  
A CONTIGUOUS MEMORY SOLUTION IN A SHORT SLOT  
USER SELECTABLE CONFIGURATION UP TO 576K  
USES 64K & 256K RAM CHIPS (ZERO K INSTALLED)  
MCT-RAM

**EXPANDED MEMORY CARD \$129.95**  
2 MB OF LOTUS INTEL MICROSOFT COMPATIBLE MEMORY FOR AN XT  
CONFORMS TO LOTUS INTEL EMS  
USER EXPANDABLE TO 2 MB  
CAN BE USED AS EXPANDED OR CONVENTIONAL MEMORY RAMDISK AND SPOOLER  
MCT-EMS  
MCT-AEMS 286/386 VERSION \$139.95

**DRIVE CONTROLLERS**

**FLOPPY DISK CONTROLLER \$29.95**  
QUALITY DESIGN FOR SINGLE SLOT CONTROL OF 4 FLOPPY S  
INTERFACES UP TO 4 FDD S TO AN IBM PC OR COMPATIBLE  
SUPPORTS BOTH DS DD AND DS OD WITH DOS 3.2  
MCT-FDC

**1.2 MB FLOPPY CONTROLLER \$69.95**  
ADD VERSATILITY AND CAPACITY TO YOUR XT  
SUPPORTS 2 DRIVES BOTH MAY BE 360K OR 1.2 MB  
ALLOWS DATA TO FLOW FREELY FROM XT S TO AT S  
MCT-FDC-1.2

**FLOPPYHARD CONTROLLER \$139.95**  
XT SYSTEM STARVED FOR SLOTS? THIS CARD FREES ONE UP  
INTERFACES UP TO 2 FDD S & 2 HDD S CABLING FOR 2 FDD 1 HDD  
SUPPORTS BOTH DS DD & DS OD WITH DOS 3.2  
MCT-FH

**286/386 FLOPPYHARD CARD \$149.95**  
FLOPPY HARD DISK CONTROL IN A TRUE AT DESIGN  
SUPPORTS UP TO 2 360K 720K 1.2MB FDD S AS WELL AS 2 HDD S USING STANDARD CONTROL TABLES  
MCT-AFH

**286/386 RLL CONTROLLER \$199.95**  
IMPROVE SPEED AND STORAGE OF YOUR AT COMPATIBLE  
SUPPORTS UP TO 2 RLL HARD DISCS AND 2 FLOPPY DRIVES  
SUPPORTS 360 720 1.2 MB FLOPPIES IN 5.25 & 3.5  
MCT-AFH-RLL

**intel**



**INBOARD 386/PC \$895.00**

UPGRADE YOUR XT TO A 386 FOR LESS THAN \$1000  
16 MHz PROCESSOR REPLACES 8088  
1 MB INSTALLED  
EXPAND TO 3MB WITH PIGGYBACK CARD  
5 YR WARRANTY

PCIB1200  
PCIB1210  
PCMB4020  
PCMB4120  
1MB PIGGYBACK CARD  
512K ABOVE BOARD  
512K ABOVE BOARD  
PAR/SER  
Call \$389.95  
\$399.95

**ARCHIVE XL TAPE BACK-UP \$369.95**

BACK UP 40 MB IN 40 MINUTES!  
EASY TO USE MENU DRIVEN SOFTWARE  
USES STANDARD OIL DATA FORMAT  
FULL & INCREMENTAL BACK UP  
PARTIAL & FULL RESTORE  
AR5240 FOR AT S & AT S  
AR5540 AT S ONLY 2X FASTER  
TAPE NOT INCLUDED  
TAPE CARTRIDGE—40 MB \$24.95



**20MB HARD DISK ON A CARD \$349**

SAVES SPACE AND REDUCES POWER CONSUMPTION  
IDEAL FOR PCs WITH FULL HEIGHT FLOPPIES  
LEAVES ROOM FOR A HALF LENGTH CARD IN ADJACENT SLOT



JUST A NOTE TO LET YOU KNOW THAT MY SALESPERSON, HELEN MORSE, AT YOUR COMPANY HAS BEEN VERY HELPFUL AND COURTEOUS. THIS IS A PLEASANT CHANGE FROM MOST TELEPHONE SALESPeOPLE I DEAL WITH. PLEASE PASS MY THANKS TO HELEN. I PLAN ON DOING FREQUENT BUSINESS WITH JDR AS MY NEW COMPANY, COEM INC. GETS GOING, AND HELEN'S ATTITUDE AND HELPFULNESS ARE A MAJOR REASON WHY I LIKE DOING BUSINESS WITH YOU.

R.C.K. BENSBALEM, PA

**BARGAIN HUNTER'S CORNER**  
**720K FLOPPY DISK DRIVE BY MITSUBISHI**  
5 1/4" HALF-HEIGHT  
96 TPI  
100% IBM COMPATIBLE  
DOUBLE-SIDED/DOUBLE-DENSITY  
**ONLY \$69.95**  
SPECIAL ENDS 8/31/88

JDR MICRODEVICES, 110 KNOWLES DRIVE, LOS GATOS, CA 95030  
LOCAL (408) 866-6200 FAX (408) 378-8927 TELEX 171-110

**ORDER TOLL FREE 800-538-5000**

COPYRIGHT 1988 JDR MICRODEVICES

CONTINENTAL U.S. AND CANADA



# BUILD YOUR OWN SYSTEM



OVER 20,000 JDR SYSTEMS  
HAVE ALREADY BEEN BUILT.  
EASY TO ASSEMBLE IN JUST 2  
HOURS WITH A SCREWDRIVER.  
SAVE MONEY AND LEARN  
ABOUT YOUR COMPUTER AT  
THE SAME TIME.

**12 MHZ  
MINI-286  
\$1101<sup>70</sup>**

- 12 MHZ BABY AT MOTHERBOARD
- 256K RAM MEMORY
- MINI AT CASE W POWER SUPPLY
- AT STYLE KEYBOARD
- 1 2 MB FLOPPY DRIVE
- FLOPPY HARD DRIVE CONTROLLER
- MONOCHROME MONITOR
- GRAPHICS ADAPTOR

**10 MHZ  
TURBO 8088  
\$656<sup>50</sup>**

- INCLUDES SERIAL PORT 2 PARALLEL  
PORTS CLOCK CALENDAR AND GAME  
ADAPTOR RUNS COLOR GRAPHICS ON  
1 MONOCHROME MONITOR
- MOTHERBOARD
- 256K RAM MEMORY
- 135 WATT POWER SUPPLY
- FLIP TOP CASE
- AT STYLE KEYBOARD
- 360K FLOPPY DRIVE
- MONOGRAPHICS I/O CARD
- MONOCHROME MONITOR

**16 MHZ  
1 MB 386  
\$2298<sup>65</sup>**

- MYLEX 386 MOTHERBOARD
- 1 MB RAM ON BOARD
- 700 WATT POWER SUPPLY
- AT STYLE CASE
- ENHANCED AT STYLE KEYBOARD
- 1 2 MB FLOPPY DRIVE
- AT FLOPPY HARD CONTROLLER
- MONOCHROME MONITOR
- MONOGRAPHICS CARD

**VIDEO  
INSTRUCTIONS  
\$4<sup>95</sup>  
WITH KIT PURCHASE**  
**IT'S A JOB  
EXCLUSIVE!  
EASY TO FOLLOW  
20 MINUTE VHS  
TAPE SHOWS YOU  
STEP-BY-STEP  
HOW TO BUILD  
AN XT COMPATIBLE  
SYSTEM.  
WITHOUT KIT  
\$19.95**

## MOTHERBOARDS

**TURBO 4.77/8 MHZ \$99.95 12 MHZ MINI 80286 \$399.95**

- 4 77 OR 8 MHZ OPERATION WITH 8088 2 & OPTIONAL  
8087 2 CO PROCESSOR
- FRONT PANEL LED SPEED INDICATOR AND RESET  
SWITCH SET SUPPORTED
- CHOICE OF NORMAL TURBO MODE OR SOFTWARE  
SELECT PROCESSOR SPEED

MCT-TURBO  
MCT-XMB STANDARD MOTHERBOARD \$87.95

- 6 MHZ (0 WAIT STATE) 12 MHZ (1 WAIT STATE)  
RELIABILITY
- SUPPORTS 256K - 1024K MEMORY
- RE CHARGEABLE HIGH CAPACITY Ni CAD BATTERY
- 6 16-BIT SLOTS 2 8 BIT SLOTS
- MOUNTS IN STANDARD XT CASE

MCT-M286-12  
MCT-M286 10 MHZ MINI 80286 BOARD \$389.95

**80286 6/8 MHZ \$379.95 16 MHZ MYLEX 386 \$1649.00**

- 8 SLOT (2 EIGHT BIT & SIXTEEN BIT) AT MOTHERBOARD
- HARDWARE SELECTION OF 6 OR 8 MHZ
- 1 WAIT STATE
- KEYLOCK SUPPORTED RESET SWITCH FRONT PANEL  
LED INDICATOR
- SOCKETS FOR 1 MB OF RAM AND 80287
- BATTERY BACKED CLOCK

MCT-288

- 1 MB RAM ON BOARD
- 8 SLOTS 2 8-BIT 6 16-BIT
- SUPPORTS 80287 MATH CO-PROCESSOR
- SUPPORTS 80387 W ADAPTOR
- 64 KB CACHE FOR NEAR 0 WAIT STATE
- USES AMI BIOS

MCT-386 MB  
MCT-386 MB-4 4 MB MEMORY INSTALLED \$2649.00  
MCT-386 MB-MCB MATH CO-PROCESSOR  
ADAPTOR BOARD \$149.00

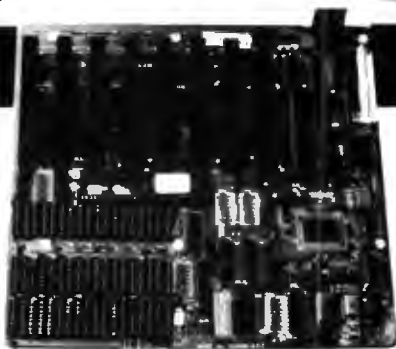

**10 MHZ SINGLE CHIP  
\$129<sup>95</sup>**

- SINGLE CHIP USES LESS POWER IMPROVES RELIABILITY
- KEY SELECTABLE SPEED 4 77 MHZ OR 10 MHZ
- 2 3 TIMES FASTER THAN A STANDARD
- RESET SWITCH KEYLOCK AND SPEED POWER  
INDICATORS SUPPORTED

MCT-TURBO-10

## DEVELOPMENT TOOLS

**EPROM  
PROGRAMMER  
\$129<sup>95</sup>**

- PROGRAMS 27XX & 27XXX EPROMS UP TO 27312
- SUPPORTS VARIOUS PROGRAMMING FORMATS AND  
VOLTAGES
- SPLIT OR COMBINE CONTENTS OF SEVERAL EPROMS  
OF DIFFERENT SIZES
- READ WRITE COPY ERASE CHECK AND VERIFY
- SOFTWARE FOR HEX AND INTEL HEX FORMATS

MCT-EPROM  
MCT-EPROM-4 4 GANG PROGRAMMER \$189.00  
MCT-EPROM-10 10 GANG PROGRAMMER \$299.95  
MCT-PAL PAL PROGRAMMER \$269.95  
MCT-MP PROCESSOR PROG. \$199.95

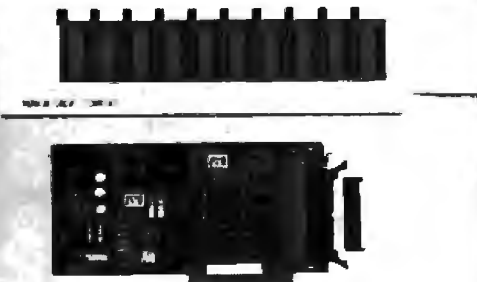

- 1 YEAR WARRANTY ON  
MCT PRODUCTS
- 30 DAY MONEY BACK  
GUARANTEE
- TOLL-FREE  
TECHNICAL  
SUPPORT
- NEXT DAY AIR  
SHIP AVAILABLE

**JDR Microdevices®**

JDR MICRODEVICES, 110 KNOWLES DRIVE, LOS GATOS, CA 95030  
LOCAL (408) 866-6200 FAX (408) 378-8927 TELEX 171-110

**ORDER TOLL FREE 800-538-5000**

COPYRIGHT 1988 JDR MICRODEVICES

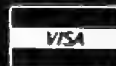

CONTINENTAL U.S. AND CANADA

# AVPROM™ \$295

For IBM-PC's & compatibles, menu-driven AVPROM programs EPROMs up to 8x faster than serially-connected units (20 sec. for 2764)

• Programs 2716 thru 27512A.

• 4- and 10 socket gang versions too. Call for prices.

For complete specs, free 32 pg. development tool catalog, call

800-448-8500.  
or 207-236-9055

**AVOCET**  
SYSTEMS, INC.™

120 Union St., Rockport, ME 04856

## Stepping Motor Controls



control up to 4 motors from any computer or terminal  
no assembly required!

- All logic, drives & power supplies built in
- Stand Alone or Slave system operation
- RS-232 Interface @ up to 19.2 K baud
- Switch Inputs & Relay Outputs
- Drives any size stepping motor
- Microstep -or- Full step drives
- CNC version for Machine applications
- BASIC version for any application

Centroid Corp.

P.O. Box 739, State College, PA 16804

1-800-346-0178

Circle 42 on Reader Service Card

**3M** 5¼" DSDD .74 ea.  
3½" DSDD 1.59 ea.  
**JVC** 5¼" DSDD .54 ea.  
3½" DSDD 1.49 ea.  
**SONY** 5¼" DSDD .73 ea.  
3½" DSDD 1.69 ea.

Prices based on Min 100 Diskettes

**BULK** 5¼" DSDD .27 ea.  
Min 800  
3½" DSDD 1.09 ea.  
Min 100  
Sleeves & Labels Included  
Lifetime Warranty 100% Certified

Shipping at Cost - Same Day

716-298-5035

FAX # 716-297-2749

**DATA DIRECT**

Prices may be subject to change without notice

Circle 68 on Reader Service Card

## the HUSKY™

EPROM  
PLD  
MICRO  
GANG  
SET



PC based PROGRAMMER  
\$599.00\*

\*modules not included.

From A Name You Can Trust

**LOGICAL DEVICES, INC.**

1201 N.W. 65th Place, Ft. Lauderdale, FL 33309

1-800-331-7766 (305) 974-0967

Telex 383142 Fax (305) 974-8531

Circle 147 on Reader Service Card  
(DEALERS: 148)

## EPROM PROGRAMMER

From  
\$395.00



PC BASED OR  
STAND-ALONE / RS-232

From A Name You Can Trust

**LOGICAL DEVICES INC.**

1201 N.W. 65th Place

Ft. Lauderdale, FL 33309

1-800-331-7766 (305) 974-0967  
Telex 383142 Fax (305) 974-8531

Circle 304 on Reader Service Card  
(DEALERS: 305)

## DATA CARTRIDGES

600 A Min 5 ..... 19.95 ea.  
300 XLP Min 5 ..... 19.65 ea.  
2000 Min 5 ..... 17.50 ea.

## EPSON ORIGINAL RIBBONS

MX, FX, RX 80 series . . . Min 4 doz. 4.49 ea.  
MX, FX, RX 100 series . . . Min 4 doz. 5.89 ea.  
LQ 1000 . . . . . Min 4 doz. 6.29 ea.

Call for pricing on LASER CARTRIDGES  
COMPUTER TAPE, RIBBONS

716-298-5035

FAX # 716-297-2749

**DATA DIRECT**

Prices may be subject to change without notice

Circle 69 on Reader Service Card

## RELAY INTERFACE



\$89.95

• Allows you to use your computer as a control system for environmental controls, equipment automation, experiments, robotics or other applications which require software control of external devices.

• Provides output channels to control 16 relays. Expandable to 128 relays.

• Wide variety of relay and contact configurations available.

• Plugs into serial port (RS-232, I/O, printer, etc.)

• Use with IBM and compatibles, Tandy Apple and most other computers.

24 HOUR ORDER LINE (614) 464-4470  
Visa, MasterCard, American Express, COB

ELECTRONIC ENERGY CONTROL, INC.  
380 S. Fifth Street, Suite 604  
Columbus, Ohio 43215

Circle 92 on Reader Service Card

## SUPER K.

Electronic Products, Inc.  
1633-6 Sycamore Ave.  
Bohemia, NY 11716

BEST GUARANTEED QUALITY & PRICE

- AT 80286 MOTHER BOARD
- 8/8/12 up to 16 MHz CALL
- 4.7710 MHz Turbo Board \$59.50
- 4.778 MHz Turbo Board \$56.00
- Multi I/O Card w/Cable \$38.00
- 1.2 M & 360K Floppy Disk Controller Card w/Cable \$36.00
- I/O plus card for AT \$ 38.00
- Floppy Disk Controller Card w/Cable \$14.00
- Game Card \$12.00
- Printer Card \$12.00
- Serial Card \$14.00
- Monochrome Graphic Card w/8 pieces RAM CHIPS \$42.00 or w/2 pieces RAM CHIPS \$48.00
- Color Graphic Card w/printer port \$42.00
- 41256-15 RAM CHIP \$11.50
- 41256-12 RAM CHIP \$10.65

Quantity Discount Available

ORDER LINE  
NYS 1-800-842-4246  
Outside NY (516) 567-6730  
FAX (516) 567-6731

- \$3.00 Handling Charge
- Shipped UPS GDD
- Prices are F.O.B. NY

\* Due to factors beyond our control, prices are subject to change w/o notice.

Circle 263 on Reader Service Card

## PRINTER BUFFERS

DEI manufactures a complete line of high performance data buffers. What ever your applications, we have a buffer to meet your requirements at an affordable price.

Printer Buffers 256K-1M \$295 & UP  
Plotter Buffers 256K-20M \$495 & UP

Remote Data Collection for PBX call records 256K-20M \$495 & UP

Serial or parallel data ports, battery back-up, internal modems, data compression, special protocols, and custom programming are available on all units. Call today with your data buffering requirements. Our design engineers will assist you in selecting the right model for your job.

1-800-247-5419

**DICKERSON ENTERPRISES, INC.**

8101 North Milwaukee Ave., Niles, IL 60648  
In Illinois or Dealer Inquiries: (312) 966-4884

Circle 82 on Reader Service Card



# EDITORIAL INDEX BY COMPANY

Index of companies covered in articles, columns, or news stories in this issue  
Each reference is to the first page of the article or section in which the company name appears

INQUIRY #	COMPANY	PAGE	INQUIRY #	COMPANY	PAGE	INQUIRY #	COMPANY	PAGE
	ABACUS .....	11	757	CORNERSTONE TECHNOLOGY	889	LASERMASTER .....	164	
961	ACCESS TECHNOLOGY .....	135	986	.....67, 282	897	LIFETREE SOFTWARE .....	225	
957	ACTUS .....	135	987	CORVUS SYSTEMS .....	282	394	LINK COMPUTER .....	282
768	ADAPTEC .....	67	988	CTX INTERNATIONAL .....	282	395	LOGITECH .....	67, 282
768	ADDISON-WESLEY .....	67	989	DATA GENERAL .....	282	778		
752	ADVANCED LOGIC RESEARCH ...	67	926	DATACOPY .....	203		MACNEAL-SCHWENDLER .....	11
	ADVANCED RESEARCH PROJECTS		376	DATAFOX .....	282	956	MAGNA COMPUTER .....	129
	AGENCY NETWORK .....	147	771	DATAPATH TECHNOLOGIES .....	67	396	MAI BASIC FOUR .....	282
968	AMDEK .....	282	884	DATAPRODUCTS .....	164		MATSUSHITA ELECTRIC .....	11
923	AMERICAN DATA		942	DATASTORM TECHNOLOGIES ...	103		MCGRAW-HILL .....	51
	TECHNOLOGY .....	203	927	DEST .....	203		MCS .....	11
	AMERICAN HOME BUSINESS		797	DIGITAL COMMUNICATIONS	397		MEGASCAN	
	ASSOCIATION .....	11		ASSOCIATES .....	67		TECHNOLOGY .....	243, 282
969	AMERICAN RESEARCH .....	282		DIGITAL RESEARCH .....	11	906	MERIDIAN SOFTWARE	
940	AMICA .....	103	377	DOTRONIX .....	282		SYSTEMS .....	213
	ANALOG DEVICES .....	11	378	E-MACHINES .....	282	793	METAWARE .....	11
	ANALYTICS .....	288	928	EIT .....	203	398	MICRO ADVICE .....	67
	ANSA SOFTWARE .....	11	379	ELECTRO MECHANICAL			MICRO CELLULAR	
970	AOC INTERNATIONAL .....	282		SYSTEMS .....	282	399	COMMUNICATIONS .....	282
883	APPLE COMPUTER .....	135, 164, 282	380	ELECTROHOME .....	282	400	MICRO DISPLAY SYSTEMS .....	282
955				FAR POINT ENGINEERING .....	11		MICROGRAPHIC IMAGES .....	282
959			381	4SITE TECHNOLOGIES .....	282	854	MICROPRO INTERNATIONAL .....	11
971			956	FOX SOFTWARE .....	135	935	MICROSOFT .....	89, 123, 143
941	APPLIED CREATIVE			FUJITSU .....	243		MICROSOFT PRESS .....	51
	TECHNOLOGY .....	103	929	GAMMALINK .....	203	930	MICROTEK LAB .....	203
779	ARCHIMEDES SOFTWARE .....	67		GAZELLE MICROCIRCUITS .....	11	401	MICROTOUCH SYSTEMS .....	282
787	ASHTON-TATE .....	67, 123, 135	885	GENERAL COMPUTER .....	164	402	MICROVITEC .....	282
934			784	GENERIC SOFTWARE .....	67		MIT MEDIA LAB .....	288
958			775	GENTRY SOFTWARE .....	67	403	MITSUBA .....	282
894	AST RESEARCH .....	195, 282		GEORGE WASHINGTON		404	MITSUBISHI ELECTRONICS	
972				UNIVERSITY .....	288		AMERICA .....	282
973	AXTEL .....	282		GOLDSTAR ELECTRONICS		405	MONITERM .....	67, 282
974	AYDIN CONTROLS .....	282	382	INTERNATIONAL .....	282	761		
	BATTELLE INSTITUTE COLUMBUS		383	GREATWEST TECHNOLOGY .....	282		MOTOROLA .....	11
	LABS .....	288	896	GRID SYSTEMS .....	183	406	NANAO USA .....	282
	BBN LABORATORIES .....	288	753	HERTZ COMPUTER .....	67	960	NANTUCKET SOFTWARE .....	135
975	BELTRON COMPUTER			HEWLETT-PACKARD .....	11		NASA AMES RESEARCH	
	SYSTEMS .....	282	384	HITACHI SALES OF AMERICA .....	282		CENTER .....	288
976	BFA SALES .....	282	762	HONEYWELL BULL ITALIA .....	67		NASA LANGLEY RESEARCH	
977	BLUE CHIP INTERNATIONAL .....	282	773	HUNTRON INSTRUMENTS .....	67		CENTER .....	288
852	BORLAND		385	HYUNDAI ELECTRONICS			NATIONAL CENTER FOR	
943	INTERNATIONAL .....	89, 103		AMERICA .....	282		ATMOSPHERIC RESEARCH .....	147
924	BROOKTROUT TECHNOLOGY .....	203	386	IBM .....	154, 164, 282		NATIONAL INSTITUTES OF	
786	BSOFT SOFTWARE .....	67	886				HEALTH .....	288
	BYTE BOOKS .....	303	944	IGC .....	103	407	NATIONAL INSTRUMENTS .....	11
978	C. ITOH ELECTRONICS .....	282	887	IMAGEN .....	164		NCR MICROELECTRONICS .....	11
	CADKEY .....	11	387	IMC COMPUTER .....	282	769	NEC HOME ELECTRONICS	
936	CANDY CABLE .....	103	388	INDTECH .....	282		..... 237, 282	
770	CAPITAL EQUIPMENT .....	67	389	INDUSTRIAL COMPUTER		907	NETLINE .....	67
	CARNEGIE MELLON			SOURCE .....	282		NHK LABORATORIES .....	243
	UNIVERSITY .....	288	795	INFORMATION RESEARCH .....	67		NU-MEGA TECHNOLOGIES .....	219
979	CARROLL TOUCH .....	282	390	INTECOLOR .....	282	408	ORIENTEC OF AMERICA .....	282
980	CHUGAI INTERNATIONAL .....	282	767	INTERNATIONAL COMPUTERS ..	67	764	OUR BUSINESS MACHINES .....	67
	CIRCUIT CELLAR INK .....	303	888	INTERSTATE ELECTRONICS .....	11	409	PACKARD BELL .....	282
	CMS ENHANCEMENTS .....	11		ITT QUME .....	164	410	PANASONIC INDUSTRIAL ..	203, 282
981	COLORGRAPHIC			JAPANESE BROADCASTING .....	288	931		
	COMMUNICATIONS .....	282		JOHN WILEY & SONS .....	51	411	PDS VIDEO TECHNOLOGY .....	282
763	COMMUNICATIONS AUTOMATION		391	KAYPRO .....	282	412	PERSONAL COMPUTER	
	& CONTROL .....	67	392	KIMTRON .....	282		PERIPHERALS .....	282
794	COMMUNICATIONS RESEARCH		857	KONAN .....	89	766	PERSTOR SYSTEMS .....	67
	GROUP .....	67	393	KRAFT SYSTEMS .....	282	939	PETER NORTON COMPUTING .....	103
982	COMPAQ COMPUTER .....	143, 282		KURZWEIL APPLIED		413	PHILIPS CONSUMER	
983	COMPUADD .....	282		INTELLIGENCE .....	288		ELECTRONICS .....	282
984	CONRAC .....	282		LAHEY COMPUTER SYSTEMS .....	11	800	PIONEER SOFTWARE .....	67
985	CONTROL SYSTEMS .....	282				414	PLANAR SYSTEMS .....	243, 275, 282
	COORDINATION TECHNOLOGY ..	11						
751	CORDATA TECHNOLOGIES .....	67						

INQUIRY #	COMPANY	PAGE	INQUIRY #	COMPANY	PAGE	INQUIRY #	COMPANY	PAGE
	PRENTICE-HALL.....	51		U.S. ARMY LABORATORY			WEITEK.....	11
	PRIAM.....	143		COMMAND.....	275	441	WELLS AMERICAN .....	282
799	PRIME SOLUTIONS .....	67	439	ULTRA-COMP.....	282		WESTERN DIGITAL.....	143
415	PRINCETON GRAPHIC		765	ULTRATEK.....	67	442	WYSE TECHNOLOGY.....	282
	SYSTEMS.....	282	440	UNISYS.....	282	443	XTRON COMPUTER	
776	PRODUCTION SYSTEMS			UNITED SILICON STRUCTURES..	11		EQUIPMENT .....	282
	TECHNOLOGIES.....	67		UNIVERSITY OF FLORIDA AT				
851	PROXIMITY SOFTWARE .....	89		GAINESVILLE.....	288	783	YAKISOFT .....	67
416	QIC RESEARCH .....	282		UNIVERSITY OF MICHIGAN			YAMAHA ELECTRONIC SYSTEM	
890	QMS .....	164		PRESS .....	51		DIVISION.....	243
417	QUADRAM .....	203, 282	893	VARITYPER .....	164	444	ZENITH DATA SYSTEMS ....	129, 282
932				VIDEOTEX INDUSTRY		957		
418	QUBIE .....	282		ASSOCIATION .....	147			
419	QUIMAX SYSTEMS .....	282		VPL RESEARCH .....	288			
420	RADIUS .....	89, 282						
856								
938	REFERENCE SOFTWARE .....	103						
421	RELISYS .....	282						
782	ROCHE SYSTEMS.....	67						
422	ROLAND DG .....	282						
792	RUPP BROTHERS .....	67, 103						
937								
423	SAMPO OF AMERICA .....	282						
424	SAMSUNG ELECTRONICS							
	AMERICA .....	282						
425	SANYO BUSINESS SYSTEMS .....	282						
772	SCRIPTEL .....	67						
	SENTIENT SYSTEMS							
	TECHNOLOGY .....	288						
774	SEQUITER SOFTWARE .....	67						
426	SHARP ELECTRONICS.....	282						
791	SOFTWARE PUBLISHING .....	11, 67						
	SONY MICROSYSTEMS .....	11						
427	SONY OF AMERICA .....	282						
853	SOTA TECHNOLOGY .....	89						
933	SPECTRAFAX.....	203						
	STANFORD RESEARCH							
	INSTITUTE .....	147						
	STANFORD UNIVERSITY.....	11						
428	SUPERMAC TECHNOLOGY .....	282						
	SWANSON ANALYSIS.....	11						
756	TALLGRASS TECHNOLOGIES .....	67						
429	TANDY/RADIO SHACK .....	154, 282						
430	TATUNG.....	282						
431	TAXAN USA.....	282						
962	TECMAR.....	135						
432	TEKTRONIX .....	243, 282						
	TEXAS A&M UNIVERSITY .....	288						
433	TEXAS INSTRUMENTS							
891	.....	11, 164, 243, 257, 282						
925	THE COMPLETE PC .....	203						
892	THE LASER CONNECTION .....	164						
	THINKING MACHINES .....	288						
434	THOMSON INFORMATION							
	SYSTEMS.....	282						
435	3A COMPUTER.....	282						
	3COM .....	11						
436	3LYNX TECHNOLOGIES .....	282						
908	TOOLS & TECHNIQUES .....	231						
437	TOSHIBA AMERICA .....	11, 183, 282						
895								
798	TRAVELING SOFTWARE .....	67, 129						
955								
	TRILLIAN COMPUTER .....	143						
855	TSI .....	89						
438	TW CASPER .....	282						

## COMING UP IN BYTE

### PRODUCTS IN PERSPECTIVE:

October will see the continuation of our new column format. This includes special pieces devoted to business applications, the Macintosh, computer communications, OS/2, and hands-on hardware and software construction projects. And don't forget Computing at Chaos Manor and Applications Plus.

A whole new class of 80386 systems can give you the performance of an 80386 for a lot less money than the high-end systems. These clones don't push for that extra bit of performance and don't offer a lot of frills. But the trade-off is an attractive price—around \$3000. October's Product Focus will compare a dozen of these clones.

**System reviews:** Next month, we'll give the 20-MHz 80386-based System 310 from Dell Computer a full going-over. Another review examines three portables: the Amstrad PPC640, the Epson Equity LT, and the USA Micro Laser Compact XT.

**A hardware review** examines five low-end scanners for the Macintosh.

**Software reviews:** Given the current interest in object-oriented development, you may want to take a look at our review of C-TALK from CNS. C-TALK adds object-oriented extensions to a number of C implementations. In another review, we'll look at a diagnostic facility for C on MS-DOS computers called PC-Lint from Gimpel Software. Also in for scrutiny will be Borland's Turbo Prolog 2.0.

**Application reviews** include D, the Data Language, a fast database manager for MS-DOS computers from CalTex; EGA Paint 2005 from RIX SoftWorks; and Borland's high-powered word processor for MS-DOS systems, Sprint.

### IN DEPTH:

HyperCard and hypertext embody similar techniques. Each is a tool for linking disparate facts together, even if those facts are not all initially contained in the same place. Our In-Depth section will take a look at some outstanding "hyper" examples and explain the technology behind the linkages.

### FEATURES:

Mark Waller will continue his discussion on microcomputer power with an article on power backup systems. Waller, an authority on electrical power management, will provide practical advice for buying the best system for your needs. Additionally, Peter Wayner will present a piece on a structured writing program.



# READER SERVICE

To get further information on the products advertised in BYTE, fill out the reader service card by circling the numbers on the card that correspond to the inquiry number listed with the advertiser. This index is provided as an additional service by the publisher, who assumes no liability for errors or omissions.

\* Correspond directly with company

## Alphabetical Index to Advertisers

Inquiry No.	Page No.	Inquiry No.	Page No.	Inquiry No.	Page No.	Inquiry No.	Page No.
3	253	67	52	145	350	217	338
4	317	68	357	148	340	218	338
5	316	69	357	147	357	219	338
6	334	308	190	148	357	220	338
7	281	70	211	304	357	221	338
308	168,169	71	211	306	357	222	338
8	348,349	*	41	149	74,75	223	338
9	8,9	72	227	150	74,75	224	338
10	8,9	73	227	151	188	225	338
12	338	74	229	152	188	226	344
13	28	76	229	153	188	227	175
*	334	78	348	154	188	228	128
14	187	78	336	*	100,101	229	223
15	187	79	180-183	*	17	230	344
16	335	80	180,181	186	151	231	315
17	350	81	279	187	151	*	34,35
*	337	82	367	188	93	232	179
18	50	83	118,117	189	18	233	179
*	262	84	118,117	190	30	234	350
19	150	85	334	191	98	235	340
*	55	86	341	*	7	236	340
20	208	87	344	162	256	237	339
21	263	88	336	*	177	238	346
22	68	89	341	163	343	239	235
23	81	90	91	164	339	240	330
*	357	91	59	166	339	241	95
24	344	92	357	168	60	242	191
25	338	93	350	167	111	243	340
26	338	94	112	168	342	*	269
27	341	311	301	169	54	244	242
318	284,255	95	18	171	24	245	139
28	267	96	18	172	53	85	66,67
*	28	97	29,29	173	182	86	66,67
*	380	98	29,29	174	182	248	146
450	296,297	99	35,37	*	256	249	146
29	33	101	102	176	350	250	340
30	CM	102	102	178	344	251	138
31	CM	103	25	*	14,15	252	340
32	1	104	342	*	128	253	221
33	1	313	281	177	127	254	27
34	71	314	281	178	127	255	27
35	71	106	10	179	46	256	13
36	334	107	199	180	46	257	106
36	334	108	199	181	218	258	249
*	321-330	108	21-23	182	302	259	212
*	364	111	79	183	315	261	233
*	285	112	341	183	118	306	58
312	301	113	336	184	178	307	58
*	192,193	114	108	185	224	282	108
*	318	116	108	186	224	283	367
*	320	116	294	187	142	284	340
*	94	303	344	188	133	285	96
37	342	117	216	189	133	286	73
*	351	118	217	*	42,43	287	271
38	334	318	301	*	CM	288	340
39	334	119	342	*	98	289	47
40	144	120	110	190	137	270	47
42	357	121	110	191	350	271	180,181
*	202	122	148	192	140,141	272	180,181
43	92	123	148	193	134	273	107
44	92	124	348	194	339	274	107
45	336	125	120	195	334	275	108
46	341	126	173	*	77	276	108
47	98	*	48,49	196	64	277	60
48	324-34	*	342	197	230	55	55,57
49	344	128	200	198	121	56	55,57
49	369	129	91	199	331	280	345
50	391	*	149	200	331	*	239,239
51	341	130	234	201	61	281	183,183
52	97	131	330	202	45	282	183,183
53	342	132	274	203	20	283	186
54	122	133	184	204	340	284	282
54	346	134	332,333	206	85	285	104
55	56,57	135	339	208	350	286	236
56	56,57	136	339	208	350	287	82,83
58	339	137	87	207	92	11	130
59	341	138	352,353	208	346	288	131
60	342	139	354,355	210	251	289	288
61	301	139	356	211	347	289	144
62	40	140	66	212	39	289	201
63	54	141	112	213	312	290	113
64	336	142	346	214	82,83	291	114
65	171	143	115	215	106	292	5
66	171	144	180	216	132	293	340





# READER SERVICE

To get further information on the products advertised in BYTE, fill out the reader service card by circling the numbers on the card that correspond to the inquiry number listed with the advertiser. This index is provided as an additional service by the publisher, who assumes no liability for errors or omissions.

\* Correspond directly with company

## Index to Advertisers by Product Category

Inquiry No.	Page No.	Inquiry No.	Page No.	Inquiry No.	Page No.	Inquiry No.	Page No.
<b>HARDWARE</b>		<b>MASS STORAGE</b>		<b>PRINTER RIBBONS</b>		<b>TERMINALS</b>	
361	ADD INS	366		371		83	CURTIS INC. .... 84
321	ABECO ..... 88IS-14	12	AK SYSTEMS ..... 336	28	BAY TECHNICAL ASSOC. .... 287	<b>SOFTWARE</b>	
16	ALPHA PRODUCTS ..... 335	14	ALPHA MICRO ..... 187	372	<b>SCANNERS/DIGITIZERS</b>	<b>APPLE2/MAC APPLICATIONS</b> Scientific/Technical	
21	ATI TECHNOLOGIES ..... 263	16	ALPHA MICRO ..... 187	101	FLAGSTAFF ..... 102	130	IO TECH ..... 234
25	B&C MICRO ..... 338	*	MAXELL DATA PRODUCTS ..... 7	102	FLAGSTAFF ..... 102	258	SPSS ..... 212
27	B&C MICRO ..... 341	345	MITSUBISHI KASEI ..... 88IS-26	119	HITECH EQUIP. CORP. .... 342	<b>APPLE2/MAC CAD</b>	
*	BINARY TECH. .... 350	226	QUALSTAR ..... 344	149	LOGITECH ..... 74,75	106	GENERIC SOFTWARE ..... 199
327	BLUE CHIP TECHNOLOGY 88IS-34	*	SEAGATE TECHNOLOGY ..... 259	150	LOGITECH ..... 74,75	107	GENERIC SOFTWARE ..... 199
40	CAPITAL EQUIPMENT ..... 144	269	TALLGRASS TECHNOLOGIES . 47	284	TPS ..... 252	<b>APPLE2/MAC LANGUAGES</b>	
*	COMPUTER CONTINUUM ..... 342	270	TALLGRASS TECHNOLOGIES . 47	496	VUTEK ..... 88M/AT-2	230	QUELO ..... 344
59	CONTROL VISION ..... 341	271	TANDON ..... 180,181	527	VUTEK ..... 88PC-10	<b>IBM/MSDOS APPLICATIONS—</b> Business/Office	
*	DATRAM ..... 41	272	TANDON ..... 180,181	373	<b>SOFTWARE SECURITY</b>	316	BASIS INC. .... 254,255
111	GENOA ..... 79	<b>MISCELLANEOUS</b>		13	ALADDIN ..... 26	34	BORLAND ..... 71
338	GTCC CORP. .... 88IS-37	7	AD LIB, INC. .... 281	60	COVOX ..... 342	35	BORLAND ..... 71
340	INES ..... 88IS-36	17	ALPHA PRODUCTS ..... 350	220	QIA TECH ..... 338	44	COGITATE ..... 341
131	IO TECH ..... 330	42	CENTROID ..... 357	221	QIA TECH ..... 338	74	DAYBREAK TECH. .... 229
145	LAWSON LABS ..... 350	49	COMPUQUEST ..... 350	222	QIA TECH ..... 338	76	DAYBREAK TECH. .... 229
167	MENDELSON ELECTRONICS . 111	62	CUESTA SYSTEMS ..... 40	224	QIA TECH ..... 338	103	FOX SOFTWARE ..... 25
181	MICROWAY ..... 216	90	EASTMAN KODAK ..... 91	258	SOFTWARE SECURITY INC. .... 13	104	FTG DATA ..... 342
*	MICROWAY ..... 302	92	ELECT. ENERGY CONTROL . 357	289	VIDEX ..... 201	336	GAMMA PRODUCTIONS . 88IS-20
181	NOHAU CORP. .... 350	*	INTECTRA ..... 342	618	VILLARREAL CONSULTING 88PC-8	338	GAMMA PRODUCTIONS . 88IS-20
184	ON TARGET ..... 339	128	INTEGRAND ..... 200	374	<b>SYSTEMS</b>	112	GOLDEN BOW ..... 341
198	ORION ..... 84	169	MERRITT COMPUTERS ..... 54	321	ABECO ..... 88IS-14	*	INFORMIX SOFTWARE ..... 49,49
208	PERSONAL SPACE COMM. .... 350	201	PARA SYSTEMS ..... 81	322	ACER ..... 88IS-39	LOTUS DEV. CORP. .... 100,101	
217	QIA TECH ..... 338	277	TELEBYTE TECHNOLOGY ..... 60	9	ADVANCED LOGIC RESEARCH 8,9	172	MICRO DATA BASE SYSTEMS . 63
218	QIA TECH ..... 338	288	VICTORY ENTERPRISES ..... 144	10	ADVANCED LOGIC RESEARCH 8,9	167	NANTUCKET ..... 152
219	QIA TECH ..... 338	<b>MODEMS/MULTIPLEXORS</b>		*	ALLEN SYSTEMS ..... 334	348	NOVELL DEV. PROD. DIV. 88IS-31
223	QIA TECH ..... 338	48	COMPUCOM CORP. .... 344	614	ALTEC TECH. CORP. .... 88PC-10	*	ORACLE ..... 77
225	QIA TECH ..... 338	81	DELTA GOLD ..... 279	*	AMPRO ..... 262	202	PARSONS TECHNOLOGY ..... 45
234	REAL TIME DEVICES ..... 350	96	EVEREX ..... 19	*	AST RESEARCH ..... 55	206	PERSOFT ..... 85
235	ROSE ELECTRONICS ..... 340	96	EVEREX ..... 19	*	COMPAQ COMP. CORP. .... 32A-H	229	QUARTERDECK ..... 223
243	SEA LEVEL ..... 340	311	E-TECH RESEARCH ..... 301	329	COMPLADD ..... 88IS-29	348	ROTTRON ..... 88IS-10
264	SUPERMICRO ..... 340	120	HOLMES MICROSYSTEMS .... 110	539	CORTEX CORP ..... 88NE-7	<b>IBM/MSDOS APPLICATIONS—</b> Scientific/Technical	
268	TALKING TECHNOLOGY ..... 340	121	HOLMES MICROSYSTEMS .... 110	70	DATAWORLD ..... 211	20	ASYST SOFTWARE TECH. .... 209
301	Z-WORLD ..... 346	520	MICROCOMP. SQUARE ... 88PC-4	71	DATAWORLD ..... 211	78	DAYTRON ELECTRONIC ..... 348
362	<b>DRIVES</b>	544	MICROCOMP. SQUARE ... 88NE-2	79	DELL COMP. (N. AMER.) . 160-163	91	ECOSOFT ..... 59
266	SYSGEN ..... 73	263	TOUCHBASE ..... 196	80	DELL COMP. (INT'L) . 160,161	181	MATHSOFT ..... 69
363	<b>HARDWARE PROGRAMMERS</b>	286	UNIVERSAL DATA SYSTEMS . 236	333	ELDNEX ..... 88IS-11	188	NATIONAL INSTRUMENTS ... 133
*	AVOCET ..... 357	<b>MONITORS</b>		97	EVEREX ..... 28,29		
26	B&C MICRO ..... 339	3	3LYNX TECH. CORP. .... 253	98	EVEREX ..... 28,29		
36	BP MICROSYSTEMS ..... 334	185	NANAO ..... 224	105	GATEWAY 2000 ..... 10		
36	BP MICROSYSTEMS ..... 334	166	NANAO ..... 224	339	ISE DATA ..... 88IS-26		
37	BYTEK ..... 342	*	NEC HOME ELEC. DIV. .... 42	166	MEGATEL ..... 80		
116	GTEK, INC. .... 108	*	NEC HOME ELEC. DIV. .... 43	173	MICRO EXPRESS ..... 182		
114	GTEK, INC. .... 108	210	PRINCETON GRAPHICS SYS. . 251	174	MICRO EXPRESS ..... 182		
483	KORE ..... 88MW-4	244	SEIKO ..... 242	*	MICROSMART ..... 88NE-8,9		
146	LINK COMPUTER ..... 340	279	TATUNG ..... 107	521	MICROSYS. ENG. .... 88PC-15		
147	LOGICAL DEVICES ..... 367	274	TATUNG ..... 107	522	MICROSYS. ENG. .... 88PC-15		
148	LOGICAL DEVICES ..... 367	354	TVM ..... 88IS-40	*	NEC INFO. SYSTEMS ..... CW		
296	XELTEK ..... 339	<b>NETWORK HARDWARE</b>		192	NORMEREL ..... 140,141		
364	<b>INSTRUMENTATION</b>	45	COGITATE ..... 336	347	OLIVETTI ..... 88IS-2		
93	ELEXOR ..... 350	330	CUBIX ..... 88IS-27	505	OMEGA MICRO SYSTEMS . 88SE-2		
130	IO TECH ..... 234	540	DRESSLHAUS ..... 88NE-3	493	OWL COMP. SERVICE ... 88M/AT-1		
482	KEITHLEY DAC ..... 88MW-9	128	IMC ..... 173	198	P C DESIGN ..... 121		
617	KEITHLEY DAC ..... 88PC-7	132	ITRON ..... 274				
613	KEITHLEY DAC ..... 88SW-6	206	PERSONAL SPACE COMM. .... 350				
184	ON TARGET ..... 339	236	ROSE ELECTRONICS ..... 340				
365	<b>KEYBOARDS/MICE</b>	308	SUNCOAST SYSTEMS ..... 58				
122	HOOLEON ..... 148	307	SUNCOAST SYSTEMS ..... 58				
123	HOOLEON ..... 148	363	TASTRONIC CONTROLS . 88IS-18				
241	SCIENCE ACCESSORIES ..... 95	<b>PRINTERS/PLOTTERS</b>					
		370					
		51	COMPUTER AGE ..... 341				
		65	C.ITHON ELECTRONICS ..... 171				
		86	C.ITHON ELECTRONICS ..... 171				
		82	DICKERSON ENTERPRISES . 357				







# FREE Information Retrieval Service

To assist you in making your evaluations, purchasing decisions, or recommendations, you can request further information directly from the manufacturer or service company on products and services advertised in this issue. There is no charge, no obligation. Just complete and mail the attached post-paid, self-addressed reply card, and we'll do the rest.

- 1** Circle numbers on reply card which correspond to numbers assigned to items of interest to you.
- 2** Check all the appropriate answers to questions "A" through "F".
- 3** Print your name and address and mail.

Fill out this coupon carefully. PLEASE PRINT. Requests cannot be honored unless the zip code is included. This card is valid for 6 months from cover date.

**A. What is your primary job function?**

- (Check one only)
- 1  Business Owner, General Management, Administrative
  - 2  MIS/DP, Programming
  - 3  Engineering/Scientific, R&D
  - 4  Professional (law, medicine, accounting)
  - 5  Other

**B. How many people does your company employ?**

- 1  25 or fewer
- 2  26-99
- 3  100-499
- 4  500-999
- 5  1000 or more

**C. Reason for request: (Check all that apply).**

- 1  Business use for yourself
- 2  Business use for your company
- 3  Personal use

**D. Your next step after information is received:**

- 1  Purchase order
- 2  Evaluation
- 3  Specification/Recommendation

**E. Please indicate the product categories for which you influence the selection or purchase at your (or your client's) company or organization. (Check all that apply).**

- 1  Microcomputers
- 2  Peripherals
- 3  Software
- 4  Accessories and supplies

**F. For how many microcomputers do you influence the purchase of products at your (or your client's) company or organization?**

- 1  1
- 2  2-4
- 3  5-9
- 4  10 or more

Name \_\_\_\_\_  
 Title \_\_\_\_\_  
 Company \_\_\_\_\_  
 Address \_\_\_\_\_  
 City \_\_\_\_\_ State \_\_\_\_\_  
 Zip \_\_\_\_\_ Telephone \_\_\_\_\_

**CIRCLE FOR FREE INFORMATION**

SEPTEMBER 489RSU

1	2	3	4	5	6	7	8	9	10	11	12	13	14	15	16	17	18	19	20	21	22	23	24	25	26	27
28	29	30	31	32	33	34	35	36	37	38	39	40	41	42	43	44	45	46	47	48	49	50	51	52	53	54
55	56	57	58	59	60	61	62	63	64	65	66	67	68	69	70	71	72	73	74	75	76	77	78	79	80	81
82	83	84	85	86	87	88	89	90	91	92	93	94	95	96	97	98	99	100	101	102	103	104	105	106	107	108
109	110	111	112	113	114	115	116	117	118	119	120	121	122	123	124	125	126	127	128	129	130	131	132	133	134	135
136	137	138	139	140	141	142	143	144	145	146	147	148	149	150	151	152	153	154	155	156	157	158	159	160	161	162
163	164	165	166	167	168	169	170	171	172	173	174	175	176	177	178	179	180	181	182	183	184	185	186	187	188	189
190	191	192	193	194	195	196	197	198	199	200	201	202	203	204	205	206	207	208	209	210	211	212	213	214	215	216
217	218	219	220	221	222	223	224	225	226	227	228	229	230	231	232	233	234	235	236	237	238	239	240	241	242	243
244	245	246	247	248	249	250	251	252	253	254	255	256	257	258	259	260	261	262	263	264	265	266	267	268	269	270
271	272	273	274	275	276	277	278	279	280	281	282	283	284	285	286	287	288	289	290	291	292	293	294	295	296	297
298	299	300	301	302	303	304	305	306	307	308	309	310	311	312	313	314	315	316	317	318	319	320	321	322	323	324
325	326	327	328	329	330	331	332	333	334	335	336	337	338	339	340	341	342	343	344	345	346	347	348	349	350	351
352	353	354	355	356	357	358	359	360	361	362	363	364	365	366	367	368	369	370	371	372	373	374	375	376	377	378
379	380	381	382	383	384	385	386	387	388	389	390	391	392	393	394	395	396	397	398	399	400	401	402	403	404	405
406	407	408	409	410	411	412	413	414	415	416	417	418	419	420	421	422	423	424	425	426	427	428	429	430	431	432
433	434	435	436	437	438	439	440	441	442	443	444	445	446	447	448	449	450	451	452	453	454	455	456	457	458	459
460	461	462	463	464	465	466	467	468	469	470	471	472	473	474	475	476	477	478	479	480	481	482	483	484	485	486
487	488	489	490	491	492	493	494	495	496	497	498	499	500	501	502	503	504	505	506	507	508	509	510	511	512	513
514	515	516	517	518	519	520	521	522	523	524	525	526	527	528	529	530	531	532	533	534	535	536	537	538	539	540
541	542	543	544	545	546	547	548	549	550	551	552	553	554	555	556	557	558	559	560	561	562	563	564	565	566	567
568	569	570	571	572	573	574	575	576	577	578	579	580	581	582	583	584	585	586	587	588	589	590	591	592	593	594
595	596	597	598	599	600	601	602	603	604	605	606	607	608	609	610	611	612	613	614	615	616	617	618	619	620	621
622	623	624	625	626	627	628	629	630	631	632	633	634	635	636	637	638	639	640	641	642	643	644	645	646	647	648
649	650	651	652	653	654	655	656	657	658	659	660	661	662	663	664	665	666	667	668	669	670	671	672	673	674	675
676	677	678	679	680	681	682	683	684	685	686	687	688	689	690	691	692	693	694	695	696	697	698	699	700	701	702
703	704	705	706	707	708	709	710	711	712	713	714	715	716	717	718	719	720	721	722	723	724	725	726	727	728	729
730	731	732	733	734	735	736	737	738	739	740	741	742	743	744	745	746	747	748	749	750	751	752	753	754	755	756
757	758	759	760	761	762	763	764	765	766	767	768	769	770	771	772	773	774	775	776	777	778	779	780	781	782	783
784	785	786	787	788	789	790	791	792	793	794	795	796	797	798	799	800	801	802	803	804	805	806	807	808	809	810
811	812	813	814	815	816	817	818	819	820	821	822	823	824	825	826	827	828	829	830	831	832	833	834	835	836	837
838	839	840	841	842	843	844	845	846	847	848	849	850	851	852	853	854	855	856	857	858	859	860	861	862	863	864
865	866	867	868	869	870	871	872	873	874	875	876	877	878	879	880	881	882	883	884	885	886	887	888	889	890	891
892	893	894	895	896	897	898	899	900	901	902	903	904	905	906	907	908	909	910	911	912	913	914	915	916	917	918
919	920	921	922	923	924	925	926	927	928	929	930	931	932	933	934	935	936	937	938	939	940	941	942	943	944	945
946	947	948	949	950	951	952	953	954	955	956	957	958	959	960	961	962	963	964	965	966	967	968	969	970	971	972
973	974	975	976	977	978	979	980	981	982	983	984	985	986	987	988	989	990	991	992	993	994	995	996	997	998	999

**BUSINESS REPLY MAIL**  
 FIRST CLASS MAIL PERMIT NO. 176 DALTON, MA

POSTAGE WILL BE PAID BY ADDRESSEE

**BYTE**

READER SERVICE  
 PO Box 298  
 Dalton, MA 01227-0298  
 USA

NO POSTAGE  
 NECESSARY  
 IF MAILED  
 IN THE  
 UNITED STATES



# FREE Information Retrieval Service

To assist you in making your evaluations, purchasing decisions, or recommendations, you can request further information directly from the manufacturer or service company on products and services advertised in this issue. There is no charge, no obligation. Just complete and mail the attached post-paid, self-addressed reply card, and we'll do the rest.

**1**

Circle numbers on reply card which correspond to numbers assigned to items of interest to you.

**2**

Check all the appropriate answers to questions "A" through "F".

**3**

Print your name and address and mail.



NO POSTAGE  
NECESSARY  
IF MAILED  
IN THE  
UNITED STATES

## BUSINESS REPLY MAIL

FIRST CLASS MAIL PERMIT NO. 176 DALTON, MA

POSTAGE WILL BE PAID BY ADDRESSEE

# BYTE

READER SERVICE

PO Box 298  
Dalton, MA 01227-0298  
USA

Fill out this coupon carefully. PLEASE PRINT. Requests cannot be honored unless the zip code is included. This card is valid for 6 months from cover date.

**A. What is your primary job function? (Check one only)**

- 1 Business Owner, General Management, Administrative
- 2 MIS/DP, Programming
- 3 Engineering/Scientific, R&D
- 4 Professional (law, medicine, accounting)
- 5 Other

**B. How many people does your company employ?**

- 1 25 or fewer
- 2 26-99
- 3 100-499
- 4 500-999
- 5 1000 or more

**C. Reason for request: (Check all that apply).**

- 1 Business use for yourself
- 2 Business use for your company
- 3 Personal use

**D. Your next step after information is received:**

- 1 Purchase order
- 2 Evaluation
- 3 Specification/Recommendation

**E. Please indicate the product categories for which you influence the selection or purchase at your (or your client's) company or organization. (Check all that apply).**

- 1 Microcomputers
- 2 Peripherals
- 3 Software
- 4 Accessories and supplies

**F. For how many microcomputers do you influence the purchase of products at your (or your client's) company or organization?**

- 1 1
- 2 2-4
- 3 5-9
- 4 10 or more

CIRCLE FOR FREE INFORMATION

SEPTEMBER 489RSU

1	2	3	4	5	6	7	8	9	10	11	12	13	14	15	16	17	18	19	20	21	22	23	24	25	26	27
28	29	30	31	32	33	34	35	36	37	38	39	40	41	42	43	44	45	46	47	48	49	50	51	52	53	54
55	56	57	58	59	60	61	62	63	64	65	66	67	68	69	70	71	72	73	74	75	76	77	78	79	80	81
82	83	84	85	86	87	88	89	90	91	92	93	94	95	96	97	98	99	100	101	102	103	104	105	106	107	108
109	110	111	112	113	114	115	116	117	118	119	120	121	122	123	124	125	126	127	128	129	130	131	132	133	134	135
136	137	138	139	140	141	142	143	144	145	146	147	148	149	150	151	152	153	154	155	156	157	158	159	160	161	162
163	164	165	166	167	168	169	170	171	172	173	174	175	176	177	178	179	180	181	182	183	184	185	186	187	188	189
190	191	192	193	194	195	196	197	198	199	200	201	202	203	204	205	206	207	208	209	210	211	212	213	214	215	216
217	218	219	220	221	222	223	224	225	226	227	228	229	230	231	232	233	234	235	236	237	238	239	240	241	242	243
244	245	246	247	248	249	250	251	252	253	254	255	256	257	258	259	260	261	262	263	264	265	266	267	268	269	270
271	272	273	274	275	276	277	278	279	280	281	282	283	284	285	286	287	288	289	290	291	292	293	294	295	296	297
298	299	300	301	302	303	304	305	306	307	308	309	310	311	312	313	314	315	316	317	318	319	320	321	322	323	324
325	326	327	328	329	330	331	332	333	334	335	336	337	338	339	340	341	342	343	344	345	346	347	348	349	350	351
352	353	354	355	356	357	358	359	360	361	362	363	364	365	366	367	368	369	370	371	372	373	374	375	376	377	378
379	380	381	382	383	384	385	386	387	388	389	390	391	392	393	394	395	396	397	398	399	400	401	402	403	404	405
406	407	408	409	410	411	412	413	414	415	416	417	418	419	420	421	422	423	424	425	426	427	428	429	430	431	432
433	434	435	436	437	438	439	440	441	442	443	444	445	446	447	448	449	450	451	452	453	454	455	456	457	458	459
460	461	462	463	464	465	466	467	468	469	470	471	472	473	474	475	476	477	478	479	480	481	482	483	484	485	486
487	488	489	490	491	492	493	494	495	496	497	498	499	500	501	502	503	504	505	506	507	508	509	510	511	512	513
514	515	516	517	518	519	520	521	522	523	524	525	526	527	528	529	530	531	532	533	534	535	536	537	538	539	540
541	542	543	544	545	546	547	548	549	550	551	552	553	554	555	556	557	558	559	560	561	562	563	564	565	566	567
568	569	570	571	572	573	574	575	576	577	578	579	580	581	582	583	584	585	586	587	588	589	590	591	592	593	594
595	596	597	598	599	600	601	602	603	604	605	606	607	608	609	610	611	612	613	614	615	616	617	618	619	620	621
622	623	624	625	626	627	628	629	630	631	632	633	634	635	636	637	638	639	640	641	642	643	644	645	646	647	648
649	650	651	652	653	654	655	656	657	658	659	660	661	662	663	664	665	666	667	668	669	670	671	672	673	674	675
676	677	678	679	680	681	682	683	684	685	686	687	688	689	690	691	692	693	694	695	696	697	698	699	700	701	702
703	704	705	706	707	708	709	710	711	712	713	714	715	716	717	718	719	720	721	722	723	724	725	726	727	728	729
730	731	732	733	734	735	736	737	738	739	740	741	742	743	744	745	746	747	748	749	750	751	752	753	754	755	756
757	758	759	760	761	762	763	764	765	766	767	768	769	770	771	772	773	774	775	776	777	778	779	780	781	782	783
784	785	786	787	788	789	790	791	792	793	794	795	796	797	798	799	800	801	802	803	804	805	806	807	808	809	810
811	812	813	814	815	816	817	818	819	820	821	822	823	824	825	826	827	828	829	830	831	832	833	834	835	836	837
838	839	840	841	842	843	844	845	846	847	848	849	850	851	852	853	854	855	856	857	858	859	860	861	862	863	864
865	866	867	868	869	870	871	872	873	874	875	876	877	878	879	880	881	882	883	884	885	886	887	888	889	890	891
892	893	894	895	896	897	898	899	900	901	902	903	904	905	906	907	908	909	910	911	912	913	914	915	916	917	918
919	920	921	922	923	924	925	926	927	928	929	930	931	932	933	934	935	936	937	938	939	940	941	942	943	944	945
946	947	948	949	950	951	952	953	954	955	956	957	958	959	960	961	962	963	964	965	966	967	968	969	970	971	972
973	974	975	976	977	978	979	980	981	982	983	984	985	986	987	988	989	990	991	992	993	994	995	996	997	998	999

Name \_\_\_\_\_  
 Title \_\_\_\_\_  
 Company \_\_\_\_\_  
 Address \_\_\_\_\_  
 City \_\_\_\_\_ State \_\_\_\_\_  
 Zip \_\_\_\_\_ Telephone \_\_\_\_\_



# THE DESKTOP COMPUTER FOR PEOPLE WHOSE MINDS ARE AT WORK EVEN WHEN THEIR BODIES AREN'T.



## Presenting the PowerMate™ Portable. Desktop power to go.™

If you happen to be one of those rare individuals whose minds don't punch out at five o'clock, we have some good news for you.

It's called the PowerMate Portable. And thanks to some workaholic engineers at NEC, this nifty little dynamo is everything a desktop computer is.

Plus it's portable. Which means you can use it anywhere. At work. At home. Or on the road. It boggles the mind.

And speaking of mind boggling, check out what's under the hood: Intel 80286™ technology, full-size internal AT-compatible expansion slots, an optional internal modem, 20 or 40 MB hard disk and EGA resolution on a backlit LCD display. Call 1-800-343-4418 and find out more about PowerMate Portable from NEC. The quick pick-me-up for the "Thank Goodness it's Monday" crowd.



*Take it to the limit.*

# NEC

For the name of the dealer nearest you, call 1-800-343-4418. In Canada, call 1-800-387-4313. NEC Information Systems, Dept. 1610, 1414 Massachusetts Ave., Boxborough, MA 01719.

**C&C** Computers and Communications



**Tandy Computers:**  
**Because there is**  
**no better value.**<sup>TM</sup>

# The New Tandy<sup>®</sup> 5000 MC

Our most powerful  
386<sup>TM</sup> based computer  
... made in America.

The new Tandy 5000 MC Professional System is strictly business, from the look of its 256,000-color VGA graphics to the tactile feel of its keyboard.

Inside is pure performance, from the 80386 processor operating at 20 MHz to the fast memory with cache that provides RAM-fast access to your data.

The 5000 MC comes with a built-in 1.44MB 3 1/2" floppy drive. There's room inside for a second 3 1/2" drive (or hard drive) and two 5 1/4" floppy, hard or tape drives. Choose from ST-506 or ESDI—and SCSI support is coming.

Expand the memory to 16MB using two dedicated expansion slots, and you can still add five IBM<sup>®</sup> Micro Channel compatible expansion adapters.

And the 5000 MC is a natural as the hub of a multiuser system or as a file server in a 3Com<sup>®</sup> office workgroup.

A Tandy 5000 MC with an 84MB hard disk drive is only \$6999. Check out the new alternative in personal computing.

**Radio Shack<sup>®</sup>**  
**COMPUTER CENTERS**

A DIVISION OF TANDY CORPORATION



- 20 MHz Intel<sup>®</sup> 80386 microprocessor
- 2MB RAM, expandable to 16MB
- Intel 82385 Memory Cache controller
- Built-in VGA graphics
- Five IBM Micro Channel<sup>™</sup> expansion slots, plus two dedicated memory slots
- 80387 coprocessor socket
- Supports MS-DOS<sup>®</sup>, MS<sup>®</sup> OS/2 and multiuser SCO<sup>®</sup> XENIX<sup>®</sup> operating systems

Price applies at Radio Shack Computer Centers and participating stores and dealers. Monitor sold separately. Intel/Reg. TM and 386/TM Intel Corp. IBM/Reg. TM and Micro Channel/TM IBM Corp. MS, MS-DOS and XENIX/Reg. TM Microsoft Corp. SCO/Reg. TM The Santa Cruz Operation. 3Com/Reg. TM 3Com Corp.

Circle 231 on Reader Service Card